



# C.V.Joint & Drive Shaft

## Catalogue 2016

---

---



# <sup>®</sup> **AUTOPARTS**





# 01

## Outer C.V. Joints

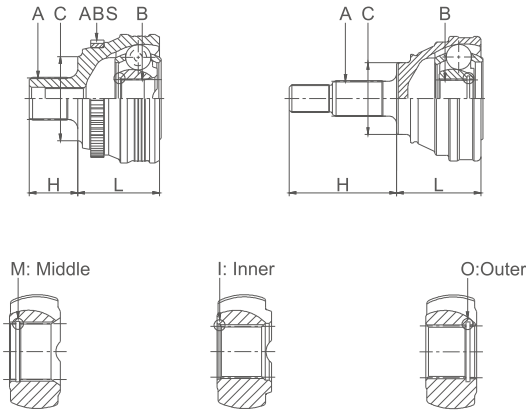

A: External Teeth, wheel side  
 B: Internal Teeth, wheel side  
 C: Seal Diameter [mm]  
 H: Bell pin length  
 L: Length  
 ABS: Number of teeth on ABS ring  
 I: Groove type: Inner  
 M: Groove type: Middle  
 O: Groove type: Outer  
 P: Groove position

# 02

## Inner C.V. Joints

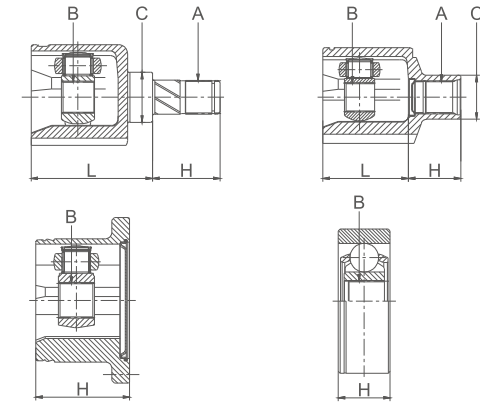

A: External Teeth, diff. side  
 B: Internal Teeth, diff. side  
 C: Seal Diameter [mm]  
 H: Bell pin length  
 L: Length

# 03

## Drive Shafts

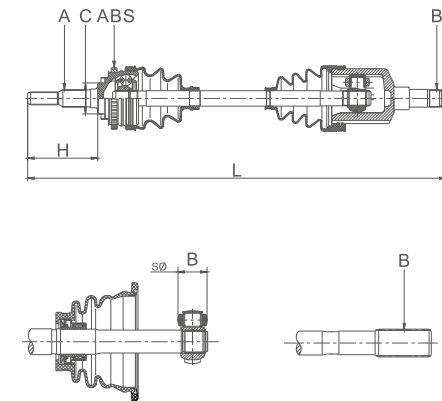

A: External Teeth, wheel side  
 B: External Teeth, diff. side/  
 Tripod roller Diameter  
 C: Seal Diameter [mm]  
 H: Bell pin length (wheel side)  
 L: Length  
 ABS: Number of teeth on ABS ring

# 04

## Stub Shaft

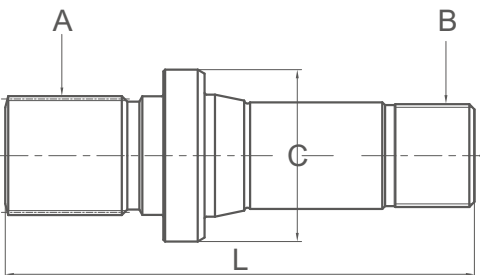

A: External Teeth, wheel side  
 B: External Teeth, diff. side  
 C: Seal Diameter [mm]  
 L: Length

## **GENERAL INDEX**

<b>Vehicle index.....</b>	<b>page.A- U</b>
<b>Applications.....</b>	<b>page.001-754</b>
<b>Cross references list.....</b>	<b>page.755-792</b>
<b>Numerical list.....</b>	<b>page.793-889</b>
<b>Obsolete Part Number Deleted(compared with catalogue 2015) .....</b>	<b>page.890-890</b>
<b>New applications (compared with catalogue 2015).....</b>	<b>page.891-895</b>



MAKE-MODEL	PAGE	MAKE-MODEL	PAGE	MAKE-MODEL	PAGE
<b>ACURA</b>		80 (81, 85, B2)	18	A6 AVANT (4G5, C7)	68
EL	1	80 (89, 89Q, 8A, B3)	18	A6 AVANT (4G5, C7, 4GD)	68
INTEGRA	1	80 (8C, B4)	20	A6 II (4B, C5), AVANT	68
VIGOR	1	80 AVANT (8C, B4)	20	A6 II QUATTRO, AVANT	68
<b>ALFA ROMEO</b>		80 III (89, 89Q, 8A, B3)	21	A6 II, AVANT	69
145 / 146 (930)	1	90 (81, 85, B2)	21	A6 III (4F2, 4FH) ALLROAD, AVANT	69
147 (937)	1	90 (89, 89Q, 8A, B3)	21	A6 IV (4G2, 4G5), AVANT	69
155 (167)	2	A1 (8X1)	22	A6 IV (4GH), ALLROAD	69
156 (932)	2	A1 (8X1, 8XA), SPORTBACK (8PA)	22	A7 (4GA)	69
156 SPORTWAGON (932)	3	A1 (8X1, 8XF)	22	A7 (4GA), SPORTBACK	70
159 (939)	4	A1 (8XA, 8XK)	22	A7 SPORTBACK (4GA, 4GF)	70
159 SPORTWAGON (939)	6	A1 SPORTACK (8XA, 8XK)	22	A8 (4D2, 4D8)	70
164 (164)	7	A2 (8Z0)	23	A8 (4E_)	70
166 (936)	7	A3	23	A8 (4H_)	70
1750-2000	7	A3 (8L1)	23	A8 II (4E)	70
33 (905)	7	A3 (8P1)	24	A8 III (4H)	71
33 (905A)	8	A3 (8P7)	27	ALLROAD (4BH, C5)	71
33 (907A)	8	A3 (8P7), CABRIO	28	CABRIO (8G7, B4)	71
33 (907B)	9	A3 (8PA)	28	CABRIOLET (8G7, B4)	71
33 II (907A, B) SPORTWAGON	9	A3 (8V1)	31	COUPE	71
33 SPORT WAGON (907B)	9	A3 (8V1), SPORTBACK (8VA)	31	COUPE (81, 85)	71
75 (162B)	9	A3 (8V7)	31	COUPE (89, 8B)	71
90 (162)	10	A3 CONVERTIBLE (8V7)	32	PHAETON (3D2)	72
ALFASUD (901)	10	A3 I QUATTRO	32	Q3 (8U)	72
ALFASUD GIARDINETTA (904)	10	A3 LIMOUSINE (8VS)	32	Q5 (8R)	72
ALFASUD SPRINT (902.A)	10	A3 SPORTBACK (8PA)	32	Q7 (4L)	73
ALFETTA (116)	10	A3 SPORTBACK (8VA)	33	QUATTRO (85)	73
ALFETTA GT (116)	10	A4	33	TT (8J3)	73
ARNA (920)	10	A4 (8D2, B5)	33	TT (8J3, 8J9)	74
BRAVO (198)	10	A4 (8E2, B6)	33	TT (8J3, 8J9), ROADSTER	74
BRERA	10	A4 (8EC, B7)	36	TT (8N3)	74
BRERA COUPE (177)	10	A4 (8H7, B6, 8HE, B7)	39	TT ROADSTER (8J9)	75
GIULIETTA (116)	11	A4 (8K2, B8)	41	TT ROADSTER (8N9)	75
GIULIETTA (940)	11	A4 / A4 AVANT	43	V8 (44_, 4C_)	76
GIULIETTA X7 (940)	11	A4 ALLROAD (8KH, B8)	43	<b>AUDI FAW</b>	
GT (937)	11	A4 AVANT (8D5, B5)	44	A6 (C5)	76
GTV (116)	11	A4 AVANT (8E5, B6)	44	<b>AUSTIN</b>	
GTV (916C)	11	A4 AVANT (8ED, B7)	47	ALLEGRO (ADO 67)	76
GTV (916C_)	12	A4 AVANT (8K5, B8)	50	MINI	76
GTV (916S)	12	A4 II (8E2, 8E5, B6), AVANT	52	<b>BMW</b>	
KAPPA (838A, B), SW	12	A4 II (8H7), CABRIO	52	1 (E81)	76
MITO (955)	12	A4 III (8EC, SED, B7), AVANT	53	1 (E82)	77
SPIDER (916S)	12	A4 IV (8K2, 8K5), AVANT	53	1 (E87)	77
SPIDER (916S_)	12	A4 IV (8KH), ALLROAD	53	1 (E88)	77
SPIDER (939)	13	A5 (8F7)	53	1 (E20)	77
<b>AUDI</b>		A5 (8F7, 8T3, 8TA), SPORTBACK	54	1 (F21)	77
100	13	A5 (8T3)	55	3 (E30)	77
100 (43, C2)	13	A5 (8TA)	56	3 (E36)	78
100 (44, 44Q, C3)	13	A5 CONVERTIBLE (8F7)	57	3 (E46)	79
100 (4A, C4)	15	A5 SPORTBACK (8TA)	58	3 (E90)	79
100 AVANT (43, C2)	15	A6	58	3 (E92)	80
100 AVANT (44, 44Q, C3)	15	A6 (4A, C4)	58	3 (E93)	81
100 AVANT (4A, C4)	17	A6 (4B2, C5)	58	3 (F30, F35, F80)	81
200 (43)	17	A6 (4F2, C6)	61	3 COMPACT (E36)	81
200 (44, 44Q)	17	A6 (4G2, C7)	63	3 COMPACT (E46)	81
200 AVANT (44, 44Q)	17	A6 ALLROAD (4FH, C6)	63	3 SERIES (E46)	81
80 (80, 82, B1)	17	A6 ALLROAD (4GH)	63	3 SERIES E36	81
		A6 AVANT (4A, C4)	63		
		A6 AVANT (4B5, C5)	64		
		A6 AVANT (4F5, C6)	67		

MAKE-MODEL	PAGE	MAKE-MODEL	PAGE	MAKE-MODEL	PAGE
<b>BMW</b>		CRUZE STATION WAGON (J308)	94	NEW YORKER / PHANTOM / SHADOW	98
		EPICA	94	NEW YORKER / PHANTOM / SPIRIT / SHADOW	98
3 TOURING (E30)	81	EPICA (KL1_)	94	NEW YORKER / SPIRIT / SHADOW	98
3 TOURING (E36)	82	K 1500	94	PT CRUISER	98
3 TOURING (E46)	82	K 2500	94	PT CRUISER (PT_)	98
3 TOURING (E91)	82	KALOS	94	PT TUBRO MTX	99
3 Touring (F31)	83	LACETTI (J200)	95	PT TURBO ATX	99
5 (E34)	83	LUMINA	95	SEBRING CONV	99
5 (E39)	84	MATIZ (M200, M250)	95	SEBRING COUPE	99
5 (E60)	84	MONTANA	95	SHADOW	99
5 TOURING (E34)	85	MONTE CARLO	95	SPIRIT	99
5 TOURING (E39)	85	NOVA	95	SPIRIT / SHADOW	99
5 TOURING (E61)	85	NOVA S	96	STRATUS	99
6 (E63)	86	NUBIRA	96	STRATUS TURBO	99
6 (E64)	86	OPTRA	96	TOWN / COUNTRY	99
7 (E65, E66, E67)	86	ORLANDO (J309)	96	TOWN / COUNTRY MINI VAN	99
X3 (E83)	86	PRIZM	96	TOWN / COUNTRY VAN	99
X5 (E53)	88	S10	96	VISION	99
X5 (E70)	89	S10 / S10 BLAZER	96	VOYAGER	99
X6 (E71)	90	S10 BLAZER	96	VOYAGER I (ES)	99
X6 (E71, E72)	90	S10 PICK UP	96	VOYAGER II (ES)	99
Z3 (E36)	91	SPARK	96	VOYAGER II (GS)	100
Z4 (E85)	91	SPARK (M300)	96	VOYAGER III (RG, RS)	100
<b>BUICK</b>		SPRINT	96	<b>CHRYSLER TRUCK</b>	
		STORM	96	TOWN / COUNTRY MINI VAN	100
CELEBRITY	91	SUBURBAN / TAHOE	96	<b>CHRYSLER TRUCK / VAN</b>	
CENTURY	91	VECTRA / MONZA / KADETT	96	TOWN / COUNTRY VAN	100
CENTURY SS	91	<b>CHEVROLET / GEO</b>		<b>CITROEN</b>	
RANIER	92	AVALANCHE	97	AX	100
REGAL	92	BLAZER / K1500 / K2500 / K3500	97	AX (ZA-)	100
RIVIERA	92	METRO	97	BERLINGO	101
SKYHAWK	92	S10 / S10 BLAZER	97	BERLINGO (MF)	102
SKYLARK (N-BODY)	92	SILVERADO PICK UP	97	BERLINGO (M_)	102
<b>BYD</b>		SUBURBAN / TAHOE	97	BERLINGO / XANTIA / XSARA	103
F3	92	<b>CHRYSLER</b>		BERLINGO MULTISPACE	103
<b>CADILLAC</b>		300 M	97	BX (XB-)	103
ELDORADO	92	BREZZE	97	BX BREAK (XB-)	104
SEVILLE	92	CARAVAN	97	C-CROSSER (EP_)	105
<b>CHEVROLET</b>		CIRRUS	97	C1 (PM, PN)	105
ASTRO	92	CIRRUS / STRATUS	97	C1 (PM_, PN_)	105
AVEO	92	CONCORDE	97	C15	105
AVEO (T200)	92	DART / LE BARON	97	C15 (VD-)	105
AVEO (T250)	92	DART / LE BARON / NEW YORKER	97	C2 (JM_)	106
AVEO (T250, T255)	92	DART / VOLARE	97	C25	106
BERETTA (L-BODY)	93	DART / VOLARE / LE BARON	97	C25 (280_, 290_)	106
BLAZER / K1500 / K2500 / K3500	93	FIFTH AVENUE	97	C3 I (FC_)	107
CAPTIVA	93	GRAND VOYAGER V (RT)	97	C3 II	108
CAPTIVA (C100)	93	IMPERIAL	98	C3 PICASSO	108
CAPTIVA (C100, C140)	93	JEEP LIBERTY	98	C3 PLURIEL (HB_)	108
CAVALIER (J-BODY)	93	LE BARON	98	C4	109
CELEBRITY	93	LE BARON / CONVERTIBLE / COUPE / SEDAN / GTC / GTS	98	C4 (LA_)	109
CORSA	93	LHS	98	C4 GRAND PICASSO I (UA_)	110
CORSA TH	93	MAGNUM	98	C4 I (LC_)	111
CORSICA (L-BODY)	93	MAGNUM / LE BARON / NEW YORKER	98	C4 II (B7)	112
CRUZE	93	MAGNUM / VOLARE / PHANTOM / NEW YORKER	98	C4 PICASSO I (UD_)	112
CRUZE (J300)	94	NEON	98	C4 PICASSO II	113
CRUZE (J305)	94	NEW YORKER	98	C5 I (DC_)	113
		NEW YORKER / PHANTOM / LE BARON	98		



MAKE-MODEL	PAGE	MAKE-MODEL	PAGE	MAKE-MODEL	PAGE
<b>CITROEN</b>		<b>CITROEN UTILIT AIRES</b>		APPLAUSE	144
C5 I (DE_)	114	BERLINGO	139	APPLAUSE (A101, A111)	144
C5 II (RC_)	114	<b>DACIA</b>		BE-GO (J210G)	144
C5 II (RC_)	115			BOON (M300S)	144
C5 II BREAK (RE_)	115	1300	139	BOON (M301S)	144
C5 III (RD_)	116	1310	139	BOON (M310S)	144
C5 III BREAK (TD_)	116	1310 (U, X)	139	CHARADE	144
C6 (TD_)	117	DOKKER	139	CHARADE (G10)	144
C8 (EA, EB)	117	DOKKER EXPRESS	139	CHARADE (G100)	144
C8 (EA_, EB_)	117	DUSTER	139	CHARADE (G102)	144
DISPATCH	118	LOGGY	139	CHARADE (G102S)	145
DISPATCH (U6U)	119	LOGAN	140	CHARADE (G200)	145
DISPATCH VAN (BS_, BT_, BY_, BZ_)	119	LOGAN (LS_)	140	CHARADE (G200S)	145
DS3	119	LOGAN (US_)	140	CHARADE (G201S)	145
DS4	119	LOGAN EXPRESS	140	CHARADE (G202)	145
DS4 / DS4 CROSSBACK	120	LOGAN EXPRESS (FS_)	140	CHARADE (G203)	145
DS5	120	LOGAN MCV	140	CHARADE (G203S)	145
EVASION (22, U6)	120	LOGAN MCV (KS_)	140	CHARADE (G213S)	145
JUMPER I-II	120	PICK UP	141	CHARADE (L2_)	145
JUMPER III	120	SANDERO	141	CHARADE II (G11, G30)	145
JUMPY	120	SANDERO,STEPWAY	141	CHARADE III (G100, G101, G102)	145
LNA	121	SOLENZA	141	CHARADE III (G102)	145
NEMO	121	SUPER NOVA	141	CHARADE IV (G200, G202)	145
NEMO (AA_)	121	<b>DAEWOO</b>		CHARADE IV (G203)	146
PHEDRA (179)	121	-	141	CUORE	146
RELAY	121	CIELO	141	CUORE (M401)	146
RELAY (230)	122	CIELO RACER (ETI)	141	CUORE IV (L501)	146
RELAY (230L)	124	CIELO RACER (GL)	142	CUORE VI (L7_)	146
RELAY (230P)	126	CIELO RACER (GS)	142	CUORE VII (L251)	146
RELAY (244)	129	ESPERO	142	FEROZA	146
RELAY (244, Z_)	129	ESPERO (KLEJ)	142	FOURTRAK (F7, F8)	146
RELAY VNA	129	EVANDA (KLAL)	142	GRAN MOVE (G3)	146
SAXO	130	KALOS	142	HANDIVAN	146
SAXO (S0, S1)	130	KALOS (KLAS)	142	HIJET	147
SAXO II	131	LACETTI (KLAN)	142	HIJET (S210P)	147
SYNERGIE (22, U6)	131	LANOS	142	HIJET CARGO (S210V)	147
VISA	132	LANOS (KLAT)	142	LEEZA (L100)	147
XANTIA	132	LEGANZA	143	LEEZA (L111S)	147
XANTIA (X1)	132	LEGANZA (KLAV)	143	MAIRA II (L80, L81)	147
XANTIA (X2)	132	MATIZ (KLYA)	143	MAIRA III (L201)	147
XANTIA II (X2)	133	NEXIA	143	MAX (L960S)	147
XANTIA II (X2) BREAK	133	NEXIA (KLETN)	143	MAX (L962S)	147
XM (Y3)	133	NUBIRA	143	MIRA	147
XM (Y4)	134	NUBIRA (KLAJ)	143	MIRA CUORE (L200S)	147
XSARA	135	NUBIRA (KLAN)	143	MIRA CUORE (L200V)	147
XSARA (N0)	135	NUBIRA OPTRA LACETTI	143	MIRA CUORE (L210S)	147
XSARA (N1)	135	NUBIRA WAGON (KLAJ)	143	MIRA CUORE (L210V)	147
XSARA (N2)	136	NUBIRA WAGON (KLAN)	143	MIRA CUORE (L220S)	147
XSARA PICASSO	137	RACER	144	MIRA CUORE (L500S V)	147
XSARA PICASSO (N68)	137	RACER / CIELO	144	MIRA CUORE (L500S)	148
XSARA VAN	138	TACUMA (KLAU)	144	MIRA CUORE (L500V)	148
ZX	138	TICO	144	MIRA CUORE (L502S)	148
ZX (N2)	138	TICO (KLY3)	144	MIRA CUORE (L510S)	148
<b>CITROEN LCV</b>		WINSTORM	144	MIRA CUORE (L510SV)	148
CITROEN LCV	138	<b>DAIHATSU</b>		MIRA CUORE (L512S)	148
JUMPER III	138	-	144	MIRA CUORE (L70S V)	148
NEMO (AA)	139	-	144	MIRA CUORE (L70V)	148
		7100	144	MIRA CUORE (L80V)	148
				MOVE	148
				MOVE (L6, L9)	148

MAKE-MODEL	PAGE	MAKE-MODEL	PAGE	MAKE-MODEL	PAGE
<b>DAIHATSU</b>		SUMMIT	151	FIORINO (146)	175
		VISION	151	FIORINO (147)	175
MOVE (L600S)	148	<b>FIAT</b>		FIORINO (225)	175
MOVE (L602S)	148			FREEMONT (JC)	175
MOVE (L610S)	148	127	151	GRANDE PUNTO	176
MOVE (L910S)	148	127 PANORAMA	151	GRANDE PUNTO (199)	176
MOVE (L912S)	148	128	151	GRANDE PUNTO (199), VAN	176
MYVI (M301S)	148	128 FAMILIARE	151	IDEA	176
MYVI (MS300S)	148	500	151	LINEA	177
NEW G100	148	500 C	152	LINEA (323)	177
OPTI (L300S)	148	500 L	152	LYBRA (839AX, BX), SW	177
OPTI (L310S)	148	500, 500 C, ABARTH	152	MAREA	177
OPTI (L800S)	148	500L	152	MAREA (185)	177
PYZAR	149	ABARTH 500	152	MAREA WEEKEND	178
PYZAR GRANMOVE (G301G)	149	ABARTH 500 C	152	MAREA WEEKEND (185)	178
PYZAR GRANMOVE (G303G)	149	ALBEA	152	MULTIPLA (186)	178
ROCKY (F300)	149	BARCETTA (183)	153	PALIO	179
SIRION	149	BRAVA (182)	153	PALIO (178BX)	179
SIRION (M1)	149	BRAVA,BRAVO (182)	153	PALIO (178BX, 178DX)	179
SIRION (M3_)	149	BRAVO (198)	153	PALIO (178BX, 178DX), WEEKEND	179
SIRION II (M3)	149	BRAVO I (182)	154	PALIO SIENA (178BX)	179
SPORTRAK (F300)	149	BRAVO II	154	PALIO WEEKEND	179
TAFT	149	BRAVO II (198)	154	PALIO WEEKEND (178DX)	179
TERIOS	149	BRAVO VAN (198)	155	PANDA (141A_)	180
TERIOS (J1)	149	BRAVO,BRAVA (182)	155	PANDA (169)	180
TERIOS (J100)	149	CAMPAGNOLA	155	PANDA (312, 319)	180
TERIOS KID (J111G)	149	COUPE (FA/175)	155	PANDA II (169)	180
VIVA	149	CROMA (154)	155	PANDA II (169) VAN	180
VIVA (L250)	149	CROMA (194)	156	PANDA III (312)	180
VIVA (L251)	149	DELTA III (844)	157	PANDA VAN (141_)	181
VIVA (L252)	149	DOBLO	157	PANDA VAN (169)	181
YRV (M201)	149	DOBLO (119)	157	PUNTO (176)	181
YRV (M211)	150	DOBLO (152, 263)	158	PUNTO (176C)	181
<b>DODGE</b>		DOBLO (263)	158	PUNTO (188)	181
		DOBLO ADVENTURE	158	PUNTO (199)	182
600	150	DOBLO CARGO (223)	158	PUNTO / GRANDE PUNTO (199)	182
ARIES	150	DOBLO I (119)	159	PUNTO EVO	182
AVENGER	150	DOBLO I (223)	159	PUNTO EVO (199)	182
CALIBER	150	DOBLO II (119)	159	PUNTO EVO, VAN	183
CALIBER (PM)	150	DOBLO III (152)	159	PUNTO II (188)	183
CARAVAN	150	DOBLO III (223)	159	PUNTO III (199)	183
COLT VISTA FWD	150	DOBLO MAXI	159	PUNTO ILI (199) EVO, VAN	183
DAKOTA	150	DOBLOII (119)	159	PUNTO VAN	183
DAYTONA	150	DUCATO	159	PUNTO VAN (188AX)	184
DURANGO	150	DUCATO (230)	159	PUNTO VAN (199)	184
DYNASTY	150	DUCATO (230L)	166	QUBO (225)	184
INTREPID	150	DUCATO (244)	170	REGATA (138)	184
LANCER	150	DUCATO (244, Z_)	170	REGATA WEEKEND	184
NEON	150	DUCATO (250)	170	SCUDO	185
NEON II	151	DUCATO (280)	172	SCUDO (220L)	185
RAM 50	151	DUCATO (290)	173	SCUDO (270_)	185
SHADOW	151	DUCATO 250)	173	SCUDO COMBINATO (220P)	186
SPIRIT	151	DUCATO III-IV	173	SEDCI	187
STEALTH	151	DUCATO PANORAMA (280)	173	SEICENTO (187)	187
STEALTH (FWD)	151	DUCATO PANORAMA (290)	174	SIENA	187
<b>DODGE TRUCK</b>		DUCATO V	175	SIENA (178_)	187
		DUNA (146 B)	175	STILO	188
CARAVAN	151	DUNA WEEKEND (146 B)	175	STILO (192)	188
<b>EAGLE</b>		FIORINO	175	STILO (192),MULTI WAGON	188
		FIORINO (127)	175	STILO MULTI WAGON (192)	189



MAKE-MODEL	PAGE	MAKE-MODEL	PAGE	MAKE-MODEL	PAGE
<b>FIAT</b>		ESCORT CLASSIC TURNIER (ANL)	198	GRANADA (GGTL, GGFL)	216
STRADA	189	ESCORT EXPRESS	198	GRANADA (GNU)	216
STRADA (138A)	189	ESCORT HOBBY	198	GRANADA (GU)	216
STRADA (178E)	190	ESCORT III (ALD)	198	GRANADA III (GAE, GGE)	216
STRADA II (138A)	190	ESCORT III (AWA)	198	GRANADA III (GGE)	218
TALENTO	190	ESCORT III (GAA)	198	GRAND C-MAX	218
TALENTO (290)	190	ESCORT IV (ALF)	199	IKON / FIESTA	219
TEMPRA (159)	190	ESCORT IV (AWF, AVF)	199	KA	219
TEMPRA S.W. (159)	191	ESCORT IV (GAF, AWF, ABFT)	199	KA (RB_)	219
TIPO	191	ESCORT V (ALL)	199	KA VAN (RB)	219
TIPO (160)	191	ESCORT V (GAL)	199	KUGA I	219
ULYSSE (179AX)	192	ESCORT V (GAL, AVL)	200	KUGA II (DM2)	220
ULYSSE (220)	192	ESCORT VI (GAL)	200	LASER	220
UNO (146A / E) 55	193	ESCORT VII (ALL)	200	LASER (METEOR)	220
UNO (146A/E)	193	ESCORT VII (GAL, AAL, ABL)	200	LYNX	220
WEEKEND	193	ESCORT VII (GAL, AFL)	200	MAVERICK	220
X 1 / 9 (128 AS)	193	ESCORT VIII	200	MONDEO	220
<b>FIAT LCV</b>		ESCORT ZX2	200	MONDEO (BNP)	220
DOBLO CARGO (223)	193	EXPEDITION / F150	201	MONDEO (CA2)	221
DOBLO CARGO I (223)	193	EXPLORER SPORT / SPORT TRAC	201	MONDEO (GBP)	221
DOBLO CARGO II (223)	193	FALCON	201	MONDEO II (BAP)	224
DOBLO CARGO III (263)	194	FESTIVA	201	MONDEO II (BFP)	225
DUCATO	194	FIESTA	201	MONDEO II (BNP)	225
FIORINO IV (225)	194	FIESTA (FVD)	201	MONDEO III	226
FIORINO QUBO (225)	194	FIESTA (GFBT)	201	MONDEO III (B4Y)	226
PANDA II (169) VAN	195	FIESTA (WFVT)	201	MONDEO III (B5Y)	226
PUNTO VAN II	195	FIESTA GII	201	MONDEO III (BWY)	227
PUNTO VAN II (188AX)	195	FIESTA II (FBD)	201	MONDEO IV	227
QUBO (225)	195	FIESTA III (GFJ)	201	MONDEO IV TURNIER	229
<b>FORD</b>		FIESTA IV	202	MONDEO IV, SW	230
323	195	FIESTA IV (JA_, JB_)	202	ORION (AFD)	230
AEROSTAR	195	FIESTA V (JH, JD)	202	ORION II (AFF)	230
B-MAX	195	FIESTA V (JH_, JD_)	202	ORION III (GAL)	231
BELINA I	195	FIESTA VAN	203	PAMPA	231
BELINA II	195	FIESTA VI	203	PROBE	231
C-MAX	195	FOCUS	204	PROBE ALL	231
C-MAX II	196	FOCUS (DAW, DBW)	204	PUMA	231
CAPRI	197	FOCUS (DFW)	204	PUMA (EC_)	231
CONSUL (GGCL)	197	FOCUS (DNW)	205	RAIDER	231
CONSUL (GGFL)	197	FOCUS C-MAX	205	RANGER	231
CONSUL TURNIER (GGNL)	197	FOCUS I (DAW, DBW), SW	206	RANGER (TU_)	232
CONTOUR	197	FOCUS II	206	S-MAX	232
CORCEL I	197	FOCUS II (DA)	207	S-MAX / GALAXY (CA1)	233
CORCEL II	197	FOCUS II (DA_)	207	S-MAX I	233
COUGAR (EC)	197	FOCUS II CC	209	S-MAX II	234
COUGAR (EC_)	197	FOCUS II STATION WAGON (DA_)	209	SCALA	234
COURIER	197	FOCUS II SW	210	SCORPIO II (GFR, GGR)	234
COURIER (F3L, F5L)	197	FOCUS III	210	SIERRA (BNG)	234
COURIER (J5_, J3_)	197	FOCUS III TURNIER	212	SIERRA (GBC, GBG)	234
COURIER (JV_)	197	FOCUS III, SW	212	SIERRA (GBG, GB4)	234
DEL REY	197	FUSION (JU)	212	STREET KA	234
ESCAPE	197	FUSION (JU_)	212	TAURUS	234
ESCORT	197	GALAXY	213	TELSTAR	234
ESCORT '81 EXPRESS (AVA)	198	GALAXY (WGR)	214	TELSTAR (GD / GE)	234
ESCORT '86 EXPRESS (AVF)	198	GALAXY I (VX, WGR, VY)	215	TEMPO	234
ESCORT '91 EXPRESS (AVL)	198	GALAXY II	215	THUNDERBIRD	235
ESCORT CLASSIC (AAL, ABL)	198	GALAXY III	215	TOPAZ	235
		GHIA	216	TOURNEO CONNECT	235
		GRANADA (GGCL)	216	TOURNEO CUSTOM	235
		GRANADA (GGNL)	216	TRANSIT	235

MAKE-MODEL	PAGE	MAKE-MODEL	PAGE	MAKE-MODEL	PAGE
<b>FORD</b>		ENVOY / ENVOY XL	243	ACCORD WAGON (CH9)	248
		JIMMY / K1500 / K2500 / K3500	243	ACCORD WAGON (CL2)	248
TRANSIT (FD_, FB_, FS_, FZ_, FC_)	236	S15 / JIMMY / SONOMA / PICK UP	243	ACCORDL (SJ, SY, SM, SV, SZ)	248
TRANSIT (FM_, FN_)	237	S15 / JIMMY / SONOMA / SYCLONE / TYPHOON	243	ASCOT (CB1)	248
TRANSIT CONNECT (P65_, P70_, P80_)	238	SAFARI	243	ASCOT (CB2)	248
TRANSIT CUSTOM	238	SIERRA PICK UP	244	ASCOT (CB3)	248
TRANSIT TOURNEO	238	SUBURBAN / YUKON XL	244	ASCOT (CB4)	248
TRANSIT V347	239	<b>HAWTAI</b>		ASCOT (CE4)	248
TRANSIT VAN (FA_)	239	E70	244	ASCOT (CE5)	248
VERONA	240	<b>HOLDEN</b>		AVANCIER	248
<b>FORD LCV</b>				BALLADE	248
COURIER II	240	APOLLO	244	CITY	248
FIESTA IV VAN	240	ASTRA	244	CIVIC	248
TRANSIT VII (FA, FD, FM)	240	ASTRA TS	244	CIVIC (AN, AR)	249
<b>FORD USA</b>		BARINA	244	CIVIC (EG1)	249
PROBE	240	COMMODORE	244	CIVIC (EG3)	249
<b>GEO</b>		JACKAROO	244	CIVIC (EG4)	249
PRIZM	240	NOVA	244	CIVIC (EG7)	249
S10 / S10 BLAZER	240	RODEO	244	CIVIC (EG8)	249
STORM	240	<b>HONDA</b>		CIVIC (EG9)	249
<b>GM</b>		ACCORD	244	CIVIC (EJ1)	249
-	240	ACCORD (CB1)	245	CIVIC (EJ3)	249
ASTRA	240	ACCORD (CB2)	245	CIVIC (EJ4)	249
CAVALIER	241	ACCORD (CB3)	245	CIVIC (EK2)	249
CAVALIER / CAVALIER Z-24	241	ACCORD (CB4)	245	CIVIC (EK3)	249
CAVALIER Z-24	241	ACCORD (CD3)	245	CIVIC (EK4)	249
CELEBRITY	241	ACCORD (CD4)	245	CIVIC (FD1)	249
CELEBRITY / CENTURY / CENTURY SS	241	ACCORD (CD5)	245	CIVIC (FD2)	249
CELEBRITY / CENTURY SS	241	ACCORD (CD6)	245	CIVIC (SB)	249
CELTA	241	ACCORD (CD7)	245	CIVIC (SF)	249
CENTURY	241	ACCORD (CD8)	245	CIVIC CRX	249
CENTURY / CUTLASS	241	ACCORD (CE1)	245	CIVIC CVCC	249
CENTURY / CUTLASS / CUTLASS EUROSPO	241	ACCORD (CD8)	245	CIVIC DEL SOL	249
CENTURY / CUTLASS EUROSPO	241	ACCORD (CL)	245	CIVIC FERIO (EG7)	249
CENTURY SS	241	ACCORD (CL1)	245	CIVIC FERIO (EG8)	249
CHEVY / MONZA	241	ACCORD (CL1)	245	CIVIC FERIO (EJ3)	250
CITATION	241	ACCORD (CN1)	245	CIVIC FERIO (EK2)	250
CITATION / CELEBRITY	241	ACCORD (CU2)	245	CIVIC FERIO (EK3)	250
CITATION / CELEBRITY / X-11	241	ACCORD (SDA)	245	CIVIC FERIO (EK4)	250
CORSA	242	ACCORD (SJ, SY)	245	CIVIC I	250
CORSA CLASSIC	242	ACCORD I (SC,SJ,SM,SV,SY)	245	CIVIC II	250
CORSA NOVO	242	ACCORD II	245	CIVIC II (EE)	250
CORSA PICK UP	242	ACCORD II (AC, AD)	245	CIVIC II (SS, SL)	250
CORSA SEDAN	242	ACCORD III (CA4, CA5)	246	CIVIC II (WC)	250
CORSA WAGON	243	ACCORD III (CA5)	246	CIVIC III (AL, AJ, AG, AH)	250
CUTLASS	243	ACCORD IV	246	CIVIC III (AM, AK, AU)	250
CUTLASS EUROSPO	243	ACCORD IV (CB)	246	CIVIC III (EC, ED, EE)	250
MERIVA	243	ACCORD IV (CB,CB3,CB7,CB8,CC,CC1,SM4)	246	CIVIC III (ED)	251
OMEGA	243	ACCORD IV (CC1)	246	CIVIC IV	251
PICK UP	243	ACCORD V (CC7, CD)	246	CIVIC IV (EG)	252
SPACE VAN	243	ACCORD V (CD7, CD9)	247	CIVIC IV (EG, EH)	252
SUPREMA	243	ACCORD V (CE)	247	CIVIC IV (MA, MB)	252
VECTRA	243	ACCORD VI (CE, CF)	247	CIVIC NACIONAL	252
ZAFIRA	243	ACCORD VII (CG)	247	CIVIC V	252
<b>GMC</b>		ACCORD VII (CG, CK)	247	CIVIC V (EJ, EK)	252
		ACCORD VII (CH)	247	CIVIC V (MB, MC)	253
		ACCORD VII (CL)	247	CIVIC VI	253
		ACCORD VII TOURER (CM)	247	CIVIC VI (EU, EP)	253
		ACCORD VIII	247	CIVIC VII (EM2)	254
		ACCORD VIII (CU)	247	CIVIC VII (ES)	254

MAKE-MODEL	PAGE	MAKE-MODEL	PAGE	MAKE-MODEL	PAGE	
<b>HONDA</b>		LIFE (JB3)	258	ACCENT	261	
		LIFE (JB4)	258	ACCENT (LC)	261	
CIVIC VII (EU, EP, EV)	254	LIFE (JD1)	258	ACCENT (MC)	262	
CIVIC VIII (FD, FA)	254	LIFE (JD2)	258	ACCENT (X-3)	262	
CIVIC VIII (FN, FK)	254	LIFE DUNK (JB3)	258	ACCENT ADMIRE	262	
CIVICK IV (EJ)	254	LIFE DUNK (JB4)	258	ACCENT ERA	262	
CONCERTO (HW)	254	LOGO (GA3)	258	ACCENT GETZ	262	
CONCERTO (HWW)	255	ODYSSEY	258	ACCENT I (X-3)	262	
CR-V	255	ODYSSEY (RA6)	258	ACCENT II	263	
CR-V (RD1)	255	ODYSSEY (RA7)	258	ACCENT II (LC)	263	
CR-V (RD2)	255	ODYSSEY (RA8)	258	ACCENT III (MC)	263	
CR-V (RD4)	255	ODYSSEY (RA9)	258	ACCENT MILENIUM	263	
CR-V (RD4, RD5, RD6, RD7, RD9)	255	ODYSSEY III (RB1, RB2)	258	AMICA (MX)	264	
CR-V (RD5)	255	OLTIA (EL1)	258	AMICA / ATOZ (MX)	264	
CR-V (RE3)	255	OLTIA (EL2)	258	ATOS	264	
CR-V (RE4)	255	OLTIA (EL3)	258	ATOS (MX)	264	
CR-V I (RD)	255	PARTNER (EY6)	258	ATOS PRIME (MX)	264	
CR-V II (RD.)	255	PARTNER (EY7)	258	ATOS PRIME I (MX)	264	
CR-V III (RE)	256	PARTNER (EY8)	258	AVEO	264	
CRX	256	PASSPORT	258	AZERA	264	
CRX (AF, AS)	256	PRELUDE	258	CERATO	265	
CRX II (ED, EE)	256	PRELUDE (BA4)	259	COUPE	265	
CRX III (EH, EG)	256	PRELUDE (BA5)	259	COUPE (RD)	265	
DOMANI (MA4)	256	PRELUDE (BA7)	259	COUPE (KG)	265	
DOMANI (MA7)	256	PRELUDE (BA8)	259	COUPE II (GK)	265	
DOMANI (MB3)	256	PRELUDE (BA9)	259	ELANTRA	265	
DOMANI (MB4)	256	PRELUDE (BB1)	259	ELANTRA (XD)	265	
EDIX (BE1, BE2, BE3, BE4)	256	PRELUDE (BB4)	259	EXCEL	266	
FIT / JAZZ / CITY (GD1)	256	PRELUDE (SN)	259	EXCEL/SCOUPE	266	
FIT / JAZZ / CITY (GD2)	256	PRELUDE I, COUPE (SN)	259	GETZ	266	
FIT / JAZZ / CITY (GD4)	256	PRELUDE II	259	GETZ (TB)	266	
FIT / JAZZ / CITY (GD6)	256	PRELUDE II (AB)	259	GRANDEUR	267	
FIT / JAZZ / CITY (GD8)	256	PRELUDE III (BA)	259	GRANDEUR (TG)	267	
FIT / JAZZ / CITY (GE6)	256	PRELUDE IV (BB)	260	i10	267	
FIT / JAZZ / CITY (GE7) 4WD	256	QUINTET (SU)	260	i10 (PA)	267	
FIT / JAZZ / CITY (GE8)	256	RAFAGA (CE4)	260	i20	267	
FIT / JAZZ / CITY (GE9) 4WD	256	RAFAGA (CE5)	260	i20 (PB, PBT)	267	
FREED (GB3)	256	S-MX (RH)	260	i30	267	
HR-V (GH)	257	SHUTTLE (RA)	260	i30 (FD)	268	
INSPIRE	257	STREAM	260	i30 / i30 CW	268	
INSPIRE (CB5)	257	STREAM (RN)	260	i30 CW (FD)	268	
INSPIRE (CC3)	257	TODAY	260	i40 (VF)	268	
INTEGRA	257	TODAY (JA1)	260	i40 CW (VF)	268	
INTEGRA (DB6)	257	TODAY (JA2)	260	i45	268	
INTEGRA (DC1)	257	TODAY (JA3)	260	ix20 (JC)	268	
INTEGRA (DC2, DC4)	257	TODAY (JA4)	260	ix35 (LM, EL, ELH)	268	
INTEGRA (EK3)	257	TODAY (JA5)	260	LANTRA	269	
JAZZ II (GD)	257	TODAY (JW2)	260	LANTRA (GK)	269	
JAZZ III (GD)	257	TODAY (JW3)	260	LANTRA (J-1)	269	
JAZZ IV (GE)	257	TODAY (JW4)	260	LANTRA (RD)	269	
LEGEND	257	TORNEO (CL1)	260	LANTRA II (J-2)	269	
LEGEND (HS, KA)	257	U.S CIVIC (EJ1)	260	LANTRA II (J-2), SW	270	
LEGEND (KA3)	257	VIGOR	260	MATRIX	270	
LEGEND II (CC,KA7,KA8)	257	VIGOR (CB5)	260	MATRIX (FC)	270	
LEGEND II (KA7)	257	VIGOR (CC3)	261	PONY (X-1)	270	
LEGEND II (KA8)	257	<b>HUMMER</b>			PONY (X-2)	270
LEGEND III (KA9)	258	H2	261	PONY / EXCEL (X-2)	270	
LIFE (JA4)	258	<b>HYUNDAI</b>			S (SLC)	270
LIFE (JB1)	258			S COUPE	270	
LIFE (JB2)	258			SANTA FE	271	



MAKE-MODEL	PAGE	MAKE-MODEL	PAGE	MAKE-MODEL	PAGE
<b>HYUNDAI</b>		GRAND CHEROKEE III (WH, WK)	280	2170 KALINA / PRIORA	289
SANTA FE I (SM)	271	LIBERTY	280	NIVA (2121)	289
SANTA FE II (CM)	271	PATRIOT (MK74)	280	NIVA (2123)	289
SANTRO	272	WRANGLER II (TJ)	280	OKA	289
SENTA FE	272	<b>KIA</b>		OKA (1111)	289
SOLARIS (SB)	272	CARENS	280	SAMARA (2108, 2109)	289
SONATA	272	CARENS I (FC)	280	SAMARA 2110	290
SONATA (NF)	273	CARENS II	280	SAMARA FORMA (21099)	290
SONATA (Y-2)	273	CARENS II (FJ)	280	<b>LANCIA</b>	
SONATA II (Y-3)	273	CARNIVAL	280	BETA (828BC)	290
SONATA III (EF)	273	CARNIVAL (VQ)	281	BETA (828_B_)	290
SONATA V (NF)	273	CARNIVAL I (UP)	281	BETA H.P.E. (828BF)	290
SONICA	273	CEE'D	281	BETA MONTE CARLO (137AS, 137BS)	290
TERRACAN (HP)	273	CEE'D (ED)	281	BETA SPIDER (828BS)	291
TRAJET (FO)	274	CERATO	282	DEDRA (835)	291
TUCSON	274	CERATO (LD)	282	DELTA (831AB0)	291
TUCSON (JM)	274	CLARUS (GC)	282	DELTA II (836)	291
VELOSTER	275	CLARUS (K9A)	282	DELTA III (844)	291
VELOSTER (FS)	275	MAGENTIS	282	KAPPA (838)	291
VERNA	275	MAGENTIS (GD)	282	KAPPA (838A)	291
<b>INFINITI</b>		MENTOR (FA)	282	KAPPA (838A, B), SW	291
G20	275	MORNING	283	KAPPA (838B)	292
I30	275	OPTIMA	283	LYBRA (839AX)	292
QX4	275	PICANTO	283	LYBRA (839AX, BX), SW	292
<b>ISUZU</b>		PICANTO (BA)	283	LYBRA (839BX)	292
AMIGO	275	PICANTO (TA)	284	MUSA (350)	292
AXIOM	276	PRIDE	284	PHEDRA (179)	293
CAMPO (KB)	276	PRIDE (DA)	284	PRISMA (831AB0)	293
FASTER RODEO (TFSIS)	276	PRO CEED (ED)	284	THEMA (834)	293
GEMINI (JT)	276	RIO	284	THESIS (841AX)	294
IMPULSE	276	RIO (BC)	285	TREVI (828DB)	294
PIAZZA (JR_)	276	RIO (DC)	285	Y (840A)	294
PICK UP	276	RIO (DC_)	285	YPSILON (843)	295
RODEO	276	RIO I	285	YPSILON I (843)	295
STYLUS	276	RIO II (JB)	285	ZETA (220)	295
TROOPER	276	SEDONA	285	<b>LAND ROVER</b>	
TROOPER & TROOPER II	276	SEDONA II (GQ)	285	90/110 (DHMC)	296
TROOPER (UB)	276	SEDONA II (VQ)	285	DEFENDER	296
TROOPER (UBS)	276	SEPHIA	285	DEFENDER STATION WAGON (LD)	296
<b>JAGUAR</b>		SHUMA	286	DISCOVERY	296
S-TYPE (CCX)	277	SHUMA (FB)	286	DISCOVERY (LJ, LG)	296
X-TYPE	277	SORENTO	286	DISCOVERY I	296
X-TYPE (CF1)	277	SORENTO I (JC)	286	DISCOVERY II (LJ, LT)	296
X-TYPE ESTATE	278	SORENTO II (XM)	286	DISCOVERY III	296
<b>JEEP</b>		SOUL (AM)	286	DISCOVERY III (TAA)	296
CHEROKEE (KJ)	278	SPECTRA	287	DISCOVERY IV	296
CHEROKEE (XJ)	278	SPECTRA (BFD)	287	DISCOVERY IV (LA)	296
CHEROKEE / COMANCHE / GRAND CHEROKEE / GRAND WAGONEER / WAGONEER	279	SPORTAGE	287	FREELANDER	297
COMMANDER (XK)	279	SPORTAGE (JE)	287	FREELANDER (LN)	297
COMPASS (MK49)	279	SPORTAGE (JE_)	287	FREELANDER 2 (FA_)	297
GRAND	279	SPORTAGE (K00)	288	FREELANDER I	298
GRAND CHEROKEE	279	SPORTAGE (SL)	288	FREELANDER I (LN)	298
GRAND CHEROKEE (ZJ)	279	VENGA (YN)	288	FREELANDER SOFT TOP	298
GRAND CHEROKEE II (WJ, WG)	279	<b>LADA</b>		FREELANDER V6	298
GRAND CHEROKEE III (WH)	280	110	288	FREELANDER VAN	298
		111	289	LAND ROVER	299
		112	289	LANDROVER RANGE ROVER SPORT (LS)	299
				RANGE ROVER (AE, AN, HAA, HAB, HAM, HBM, RE, RN)	299



MAKE-MODEL	PAGE	MAKE-MODEL	PAGE	MAKE-MODEL	PAGE
<b>LAND ROVER</b>		323 S IV (BG)	305	CAPELLA 626 TELSTER (CG2PP)	315
		323 S V (BA)	305	CAPELLA 626 TELSTER (CG2SP)	315
RANGE ROVER EVOQUE (LV)	299	323 S VI (BJ)	306	CAPELLA 626 TELSTER (GD8R)	315
RANGE ROVER II (LP)	299	5 (CR19)	306	CAPELLA 626 TELSTER (GDEA B)	315
RANGE ROVER III (LM)	299	5 CR	306	CAPELLA 626 TELSTER (GDEPS)	315
RANGE ROVER IV (LG)	299	6	306	CAPELLA 626 TELSTER (GDER)	315
RANGE ROVER SPORT	299	6 (GG)	306	CAPELLA 626 TELSTER (GDFFP)	315
RANGE ROVER SPORT (LS)	299	6 (GH)	308	CAPELLA 626 TELSTER (GE8P)	315
RANGE ROVER SPORT II	300	6 (GY)	308	CAPELLA 626 TELSTER (GEEP)	316
<b>LANDWIND</b>		6 STATION WAGON (GY)	308	CAPELLA 626 TELSTER (GEFP)	316
		626	309	CAPELLA 626 TELSTER (GF)	316
X5	300	626 (GE)	309	CAPELLA 626 TELSTER (GF8P)	316
<b>LDV</b>		626 / MX-6 MYSTERE&CRONOS	309	CAPELLA 626 TELSTER (GFEP)	316
		626 II (GC)	309	CAPELLA 626 TELSTER (GFER)	316
MAXUS	300	626 III (GD)	310	CAPELLA TELSTER CARGO / WAGO (GFFP)	316
<b>LEXUS</b>		626 III (GV)	311	CAPELLA TELSTER CARGO / WAGO (GV8W)	316
		626 IV (CBA,GE)	312	CAPELLA TELSTER CARGO / WAGO (GVER)	316
CT (2WA1 )	301	626 IV (GE)	312	CAPELLA TELSTER CARGO / WAGO (GVFR)	316
ES (F1, F2)	301	626 MATSURI	312	CAPELLA TELSTER CARGO / WAGO (GVFW)	316
ES300	301	626 V (GF)	312	CAPELLA TELSTER CARGO / WAGO (GW5R)	316
IS I (JCE1_, GXE1_)	301	626 V (GW)	313	CAPELLA TELSTER CARGO / WAGO (GW8W)	316
IS SPORTCROSS	301	ATENZA (GH5AP)	313	CAPELLA TELSTER CARGO / WAGO (GWEW)	316
LX (UZJ100)	301	ATENZA (GH5AS)	313	CAPRLLA 626 TELSTER (GE5P)	316
RX (GYL1_, GGL15, AGL10)	301	ATENZA (GH5FP)	313	CAPRLLA 626 TELSTER (GE5PF)	316
RX (MCU15)	301	ATENZA (GH5FS)	313	CLEF (GE5PA)	316
RX (MHU3_, GSU3_, MCU3_)	301	ATENZA (GHEFP)	313	CLEF (GEEPA)	316
<b>LINCOLN</b>		ATENZA (GHEFS)	313	CRONOS (GE5P)	316
		ATENZA SPORT WAGON (GH5AW)	313	CRONOS (GE8P)	316
CONTINENTAL	301	ATENZA SPORT WAGON (GH5FW)	313	CRONOS (GEEP)	316
<b>MARUTI</b>		ATENZA SPORT WAGON (GHEFW)	313	CRONOS (GEFP)	316
		ATENZA SPORT WAGON (GY3W)	314	CRONOS (GESR)	316
1000	301	ATENZA SPORT WAGON (GYEW)	314	DEMIO (DE3AS)	317
800	302	AXELA	314	DEMIO (DE3FS)	317
SX4	302	AZ-3 (ECPSA)	314	DEMIO (DE5FS)	317
<b>MAZDA</b>		B-SERIE (UN)	314	DEMIO (DEJFS)	317
		B2500	314	DEMIO (DW)	317
121 (DA)	302	B2500 B2600 B3000 B4000	314	EUNOS 100 (BG8PE)	317
121 I (DA)	302	B2600	314	EUNOS 300 (MAEPE)	317
121 II (DB)	302	B2600 / BRAVO	314	EUNOS 500 (CA8P)	317
121 III (JASM, JBSM)	302	BONGO	314	EUNOS 500 (CAEP)	317
2 (DE)	302	BONGO BRAWNY TRUCK (SK2)	314	EUNOS 500 (CAPP)	317
2 (DY)	302	BONGO BRAWNY TRUCK (SK5)	314	EUNOS 800 (MILLERCYCLE)	317
2 I (DY)	302	BONGO BRAWNY VAN (SK5)	314	EUNOS 800 (TA5)	317
3	302	BONGO FRIENDEE MPV (SG)	314	EUNOS PRESSO (EC8S)	317
3 (BK)	302	BONGO J80 / 100 (SD29M)	314	FAMILIA 323	317
3 (BK3P)	303	BONGO J80 / 100 (SD5)	314	FAMILIA 323 LASER (BF3TP)	317
3 (BK5P)	303	BONGO J80 / 100 (SE28)	314	FAMILIA 323 LASER (BG8PSP)	317
3 (BL)	303	BONGO J80 / 100 (SE88M)	315	FAMILIA 323 LASER (BG8SP)	317
3 BK	303	BONGO J80 / 100 (SR2AM)	315	FAMILIA 323 LASER (BHA6R)	317
323	303	BONGO J80 / 100 (SS28)	315	FAMILIA 323 LASER (BHA7P)	317
323 ASTINA	303	BONGO J80 / 100 (SS88M)	315	FAMILIA 323 LASER (BHA7R)	317
323 C IV (BG)	303	BONGO J80 / 100 (SSE8R)	315	FAMILIA 323 LASER (BHA8PS)	318
323 C V (BA)	304	BONGO J80 / 100 (SSF8R)	315	FAMILIA 323 LASER (BJFW)	318
323 F IV (BG)	304	BONGO TRUCK (SK22)	315	FAMILIA VAN / WAGON LASER VAN (1BF3V)	318
323 F V (BA)	304	BONGO TRUCK (SK82)	315	FAMILIA VAN / WAGON LASER VAN (2BW3W)	318
323 F/P VI (BJ)	304	BONGO VAN (SK22)	315	FAMILIA VAN / WAGON LASER VAN (3BVSY10)	318
323 II (BD)	304	BONGO VAN (SK82)	315	FAMILIA VAN / WAGON LASER VAN (3BVY10)	318
323 III (BF)	304	BRAVO	315	FAMILIA VAN / WAGON LASER VAN (BVFY10)	318
323 III (BW)	305	BT-50 (CD, UN)	315	FAMILIA VAN / WAGON LASER VAN (BWE / BVE Y10)	318
323 P V (BA)	305	CAPELLA 626	315	FAMILIA VAN / WAGON LASER VAN (BWFY10)	318

MAKE-MODEL	PAGE	MAKE-MODEL	PAGE	MAKE-MODEL	PAGE
<b>MAZDA</b>		B-CLASS (W245)	324	MINI (R52)	337
FESTIVA (D23PF)	318	C-CLASS (S202)	326	MINI (R56)	338
FESTIVA (D25PF)	318	C-CLASS (W202)	326	MINI (R57)	339
FESTIVA (DA3PF)	318	CLASSE A I (W168)	326	MINI (R58)	339
FESTIVA (DAJPF)	318	CLASSE A II (W169)	326	MINI CLUBMAN (R55)	339
GLC	318	CLASSE A III (W169)	327	MINI COUNTRYMAN (R60)	340
IXION (CP8WF)	318	CLASSE B I (W245)	327	MINI I (R50, R53)	340
LANTIS	318	CLASSE B II (W245)	328	MINI I CABRIO (R52)	340
LANTIS (CBA)	318	CLASSE GL (X164)	328	MINI II CLUBMAN (R55)	340
LANTIS (CBA8P)	318	CLASSE M I (W163)	328	MINI II, CABRIO (R56, R57)	340
LASER (FORD)FIESTA	318	CLASSE M II (W164)	329	MINI III (R58, R59)	340
MAZDA 3	318	CLASSE R (W251, V251)	329	MINI ROADSTER (R59)	340
MAZDA 3 (BK3P)	318	COUPE (C123)	329	<b>MITSUBISHI</b>	
MAZDA 3 (BK5P)	318	COUPE (C124)	329	3000 GT (FWD)	341
MAZDA 3 (BKEP)	318	E CLASS (W124)	329	3000 GT (Z16A)	341
MILLENNIA	319	E-CLASS (S124)	329	AIRTREK (CU2W)	341
MILLENNIA (TA5P)	319	E-CLASS (S210)	329	AIRTREK (CU4W)	341
MILLENNIA (TAFP)	319	E-CLASS (W124)	329	AIRTREK (CU5W)	341
MPV	319	E-CLASS (W210)	329	CARISMA (DA)	341
MPV I (LV)	319	G-CLASS (W460)	330	CARISMA (DA_)	341
MPV II (LW)	319	G-CLASS (W461)	330	CHALLENGER (K90)	342
MS-6 (GE8P)	319	G-CLASS (W463)	330	CHAMP	342
MS-6 (GEEP)	319	G-CLASS CABRIO (W463)	330	CHARADE (CU2W)	342
MS-6 (GEFP)	319	KOMBI (S123)	330	CHARADE (CU4W)	342
MS-8 (MB5A)	319	KOMBI (S124)	330	CHARADE (CU5W)	342
MS-8 (MBEP)	319	M-CLASS (W163)	330	CHARIOT (D02W)	342
MX-3	319	M-CLASS (W164)	331	CHARIOT (D03W)	342
MX-3 (EC)	319	MB	331	CHARIOT (D05W)	342
MX-5	319	R-CLASS (W251, V251)	332	CHARIOT (NIMBUS) / GRANDIS	342
MX-5 (NA)	319	SALOON (W123)	332	COLT	342
MX-5 III (NC)	319	SALOON (W124)	332	COLT (A15_A)	342
MX-6	319	SL (C107)	332	COLT (RG)	342
MX-6 (GE)	320	SL (R107)	332	COLT (Z23A)	342
MX-6 (GE5SB)	320	SLK (R170)	332	COLT (Z24A)	342
MX-6 (GE5SB)	320	SPRINTER 3-T (903)	332	COLT (Z25A)	342
PICK UP	320	V-CLASS (638/2)	333	COLT (Z26A)	342
PRECIDIA	320	VANEO (414)	333	COLT (Z27A)	342
PREMACY (CP)	320	VIANO (W639)	333	COLT (Z28A)	342
PREMACY (CP8W)	320	VITO (638)	333	COLT II (C1_A)	343
PREMACY (CPEW)	320	VITO (W639)	334	COLT III (C5_A)	343
PRIDE	320	VITO / MIXTO (W639)	335	COLT IV	343
PROBE	320	VITO II (W639)	335	COLT IV (CA_A)	343
PROBE (PT22L)	320	<b>MERCURY</b>		COLT V (CJ_, CP_)	343
PROTEGE	320	COUGAR	336	COLT VI (CZ)	343
PROTEGE (USA)	320	COUGAR (FWD)	336	COLT VI (Z3_A, Z2_A)	343
REVUE (DB3PA)	321	LYNX / LN7	336	COLT VII (Z30)	343
REVUE (DB5PA)	321	MYSTIQUE	336	CORDIA	343
TRIBUTE	321	SABLE	336	CORDIA (A212)	343
TRIBUTE (EP)	321	TOPAZ	336	CORDIA (A213)	344
XEDOS 6	321	TRACER	336	CORDIA (A21_A, AB)	344
XEDOS 6 (CA)	321	VILLAGER	336	CORDIA (SE SX)	344
XEDOS 9 (TA)	321	<b>MG</b>		DEBONAIR (S11A)	344
<b>MERCEDES BENZ</b>		MG TF	336	DEBONAIR (S12A)	344
100 (631)	321	MG ZR	336	DEBONAIR (S22A)	344
190 (W201)	321	MGF (RD)	336	DEBONAIR (S27A)	344
A-CLASS (W168)	322	<b>MINI</b>		DIAMANTE	344
A-CLASS (W169)	322	MINI (R50, R53)	337	DIAMANTE (F13A)	344
A-CLASSE	324			DIAMANTE (F15A)	344
				DIAMANTE (F25A)	344



MAKE-MODEL	PAGE	MAKE-MODEL	PAGE	MAKE-MODEL	PAGE
<b>MITSUBISHI</b>		LANCER IV (C6_A)	349	PAJERO (V68W)	352
		LANCER IV (C6_A, C7_A)	349	PAJERO (V68W/V78W)	352
DIAMANTE (F27A)	344	LANCER SEDAN	350	PAJERO (V73W)	352
ECLIPSE	344	LANCER V (CB/D_A)	350	PAJERO (V75W)	352
ECLIPSE (D22A)	344	LANCER V STATION WAGON (CB_W, CD_W)	350	PAJERO (V78W)	352
ECLIPSE (D2_A)	344	LANCER VI (CJ-CP_)	350	PAJERO / SHOGUN (L04_G, L14_G)	352
ECLIPSE II (D3_A)	344	LEGNUM (EA5W)	350	PAJERO / SHOGUN (V2_W, V4_W)	352
EMERAUDE / GALANT / ETERNA (E52A)	344	LIBERO / LIBERO CARGO (CB8V W)	350	PAJERO / SHOGUN CLASSIC (V2_W)	352
EMERAUDE / GALANT / ETERNA (E53A)	344	MAGNA	350	PAJERO / SHOGUN II (L04_G)	352
EMERAUDE / GALANT / ETERNA (E54A)	344	MIRAGE	350	PAJERO / SHOGUN II (V3_W, V2_W, V4_W)	353
EMERAUDE / GALANT / ETERNA (E57A)	344	MIRAGE / LANCER	350	PAJERO / SHOGUN III (V6_W, V7_W)	353
EMERAUDE / GALANT / ETERNA (E64A)	344	MIRAGE / LANCER (A153)	350	PAJERO / SHOGUN III (V7_W, V6_W)	353
EMERAUDE / GALANT / ETERNA (E72A)	344	MIRAGE / LANCER (C11A)	350	PAJERO / SHOGUN IV (V8_W, V9_W)	353
EMERAUDE / GALANT / ETERNA (E74A)	344	MIRAGE / LANCER (C12A)	350	PAJERO III CANVAS TOP (V6_W, V7_W)	353
EMERAUDE / GALANT / ETERNA (E77A)	344	MIRAGE / LANCER (C14A)	350	PAJERO IV VAN (V90, V80, V8_V)	353
EMERAUDE / GALANT / ETERNA (E84A)	345	MIRAGE / LANCER (C18A)	350	PICK UP	353
ETERNA	345	MIRAGE / LANCER (C51A)	350	PONY	353
EXCEL	345	MIRAGE / LANCER (C52A)	350	PRECIS	353
EXPO	345	MIRAGE / LANCER (C61A)	350	S COUPE	353
EXPO LRV	345	MIRAGE / LANCER (C62A)	350	SAPPORO II (A16_A)	353
GALAN FORTIS (CY4A)	345	MIRAGE / LANCER (C64A)	350	SHOGUN PININ (H6_W, H7_W)	353
GALANT	345	MIRAGE / LANCER (C72A)	350	SIGMA (F13A)	353
GALANT / ETERNA	345	MIRAGE / LANCER (C74A)	350	SIGMA (F15A)	353
GALANT / ETERNA (E11A)	345	MIRAGE / LANCER (C82A)	351	SIGMA (F25A)	353
GALANT / ETERNA (E12A)	345	MIRAGE / LANCER (CA4A)	351	SIGMA (F27A)	353
GALANT / ETERNA (E17A)	345	MIRAGE / LANCER (CB4A)	351	SIGMA (F2_A, F1_A)	353
GALANT / ETERNA (E18A)	345	MIRAGE / LANCER (CB7A)	351	SIGMA STATION WAGON (F0_W)	353
GALANT / ETERNA (E31A)	345	MIRAGE / LANCER (CB8A)	351	SPACE RUNNER (N1_W, N2_W)	354
GALANT / ETERNA (E32A)	345	MIRAGE / LANCER (CC3A)	351	SPACE STAR (DG0)	354
GALANT / ETERNA (E33A)	345	MIRAGE / LANCER (CC4A)	351	SPACE STAR (DG_A)	354
GALANT / ETERNA (E34A)	345	MIRAGE / LANCER (CD3A)	351	SPACE WAGON	354
GALANT / ETERNA (E35A)	345	MIRAGE / LANCER (CD5A)	351	SPACE WAGON (D0_V/W)	354
GALANT III (E1_A)	345	MIRAGE / LANCER (CD7A)	351	SPACE WAGON (N3_W, N4_W)	354
GALANT IV	345	MIRAGE / LANCER (CD8A)	351	SUMMIT	354
GALANT IV (E3_A)	346	MIRAGE / LANCER (CD9A)	351	TREDIA	354
GALANT V (E5_A, E7_A, E8_A)	346	MIRAGE / LANCER (CJ1A)	351	TREDIA (A211)	354
GALANT V (E5_A, E7_A, E8_A)	347	MIRAGE / LANCER (CJ2A)	351	TREDIA (A212)	354
GALANT VI (EA_)	347	MIRAGE / LANCER (CK1A)	351	TREDIA (A213)	354
GRANDIS (NA4W)	347	MIRAGE / LANCER (CK2A)	351	TREDIA (A215)	354
GRANDIS (NA_W)	347	MIRAGE / LANCER / COLT	351	TREDIA (A21_)	354
L 200 (K7_T, K6_T)	347	MIRAGE / LANCER V (CB/DA)	351	VISTA	355
L 200 (KB_T, KA_T)	347	MIRAGE / LANCER V (CB/DA) SW	351	<b>MOSKVICH</b>	
L 400 (PD_W, PC_W, PB_V, PA_W, PA_V)	348	MIRAGE / LANCER VAN / WAGON (C11V)	351	21412	355
L 400 / SPACE GEAR (PD_W, PC_W, PA_V, PB_V, PA_V)	348	MIRAGE / LANCER VAN / WAGON (C12V W)	351	<b>NISSAN</b>	
L200/TRITON	348	MIRAGE / LANCER VAN / WAGON (C14V W)	351	100 NX (B13)	355
LANCER	348	MIRAGE LANCER	351	AD VAN / WAGON (VB11)	355
LANCER (A17_)	348	MONTERO	351	AD VAN / WAGON (VY10, WY10)	355
LANCER (CK1A, CK2A)	348	OUTLANDER	351	AD VAN / WAGON (WEY10)	355
LANCER (CS_A)	348	OUTLANDER I (CU_W)	351	AD VAN / WAGON MAX (V/W FY10/FGY10)	355
LANCER (CS_W)	348	OUTLANDER II (CW_W)	352	AD VAN / WAGON MAX (V/WSY10, VSGY10)	355
LANCER (CY/Z_A)	348	OUTLANDER II VAN (CW_W)	352	AD VAN / WAGON MAX (VFN/WFNY10)	355
LANCER / COLT	348	OUTLANDER III (GG_W, GF_W, ZJ)	352	AD VAN / WAGON MAX (VHB11)	355
LANCER CEDIA (CS1A)	348	OUTLANDER III VAN (GF_W, GG_W)	352	AD VAN / WAGON MAX (VSB11)	355
LANCER CEDIA (CS5A)	349	PAJERO	352	AD VAN / WAGON MAX (VSNY10)	355
LANCER CEDIA WAGON (CS2W)	349	PAJERO (L041)	352	AD VAN WINGROAD (VFY11, WFY11)	355
LANCER CEDIA WAGON (CS5W)	349	PAJERO (L043)	352	AD VAN WINGROAD (VY11)	355
LANCER EVOLUTION (CZ4A)	349	PAJERO (L146)	352	AIMERA II (N16)	356
LANCER F II (A17_)	349	PAJERO (V63W)	352	ALMERA (N15)	356
LANCER III (C1_A, C6_A)	349	PAJERO (V65W)	352		
LANCER III (C1_V, C3_V)	349	PAJERO (V65W/V75W)	352		



MAKE-MODEL	PAGE	MAKE-MODEL	PAGE	MAKE-MODEL	PAGE
<b>NISSAN</b>		DATSUN 140 Y (HLB310)	361	NX COUPE (EB13)	368
		DATSUN FRONTIER (D22)	361	NX COUPE (FB13)	368
ALMERA I (N15)	356	DUALIS (KJ10)	361	PATHFINDER	368
ALMERA II (N16)	356	DUALIS (KNJ10)	361	PATHFINDER (R50)	368
ALMERA TINO (V10)	357	EXA (KEN13)	361	PATHFINDER (R51)	368
ALTIMA	357	INTERSTAR	361	PATROL GR (Y60, GR)	368
ALTIMA (L31)	357	INTERSTAR (X70)	361	PATROL GR II (Y61)	368
AUSTER	357	JUKE (F15)	362	PATROL HARDTOP (K160)	368
AUSTER STANZA (PT12)	357	KUBISTAR	362	PATROL HARDTOP (K260)	368
AVENIR (PNW10)	357	KUBISTAR (X76)	362	PATROL II GR (Y61)	369
AVENIR (PW10)	357	LANGLEY	362	PATROL STATION WAGON (W160)	369
AVENIR (SW10)	357	LANGLEY LIVERTAVILLA (BEN13)	362	PATROL STATION WAGON (W260)	369
AVENIR (VENW10)	357	LANGLEY LIVERTAVILLA (BSN13)	362	PICK UP (D21)	369
AVENIR (VEW10)	357	LANGLEY LIVERTAVILLA (N12)	362	PICK UP (D22)	369
AVENIR (VSW10)	357	LANGLEY LIVERTAVILLA (N13)	362	PICK UP FRONTIER	369
AVENIR (W10)	358	LANGLEY LIVERTAVILLA (SN12)	363	PICK-UP (720)	369
BLUEBIRD	358	LARGO (C22)	363	PRAIRIE (BM / VBM10)	369
BLUEBIRD (910)	358	LARGO (ED7)	363	PRAIRIE (HNM10)	369
BLUEBIRD (ENU12)	358	LARGO (UD7)	363	PRAIRIE (HNM11)	369
BLUEBIRD (ENU14)	358	LARGO (W30)	363	PRAIRIE (M10, NM10)	369
BLUEBIRD (EU11)	358	LATIO (JY12)	363	PRAIRIE (NM11)	369
BLUEBIRD (EU12)	358	LATIO (ZE11)	363	PRAIRIE (PNM11)	369
BLUEBIRD (EU13)	358	LAUREL	363	PRAIRIE PRO (M11)	369
BLUEBIRD (HNU12)	358	LAUREL SPIRIT (B11)	363	PRESEA (PR10)	369
BLUEBIRD (HNU14)	358	LAUREL SPIRIT (B12)	363	PRESEA (PR11)	369
BLUEBIRD (HU12)	358	LAUREL SPIRIT (EB12)	363	PRESEA (R10)	369
BLUEBIRD (HU14)	358	LAUREL SPIRIT (SB11)	363	PRESEA (R11)	370
BLUEBIRD (RNU12)	358	LAUREL SPIRIT (SB12)	363	PRIMASTAR	370
BLUEBIRD (RU12)	358	MARCH (K11)	363	PRIMASTAR (X83)	370
BLUEBIRD (SU12)	358	MARCH / MICRA (HK11)	363	PRIMASTAR VAN (X83)	370
BLUEBIRD (SU13)	358	MARCH / MICRA (K11)	363	PRIMERA	370
BLUEBIRD (T72 , T12)	358	MARCH / MICRA (K12)	364	PRIMERA (P10)	370
BLUEBIRD (T72, T12)	359	MAXIMA	364	PRIMERA (P11)	371
BLUEBIRD (U11)	359	MAXIMA (J30)	364	PRIMERA (P12)	372
BLUEBIRD (U14)	359	MAXIMA II (J30)	364	PRIMERA (WP12)	373
BLUEBIRD STATION WAGON (WU11)	359	MAXIMA QX (A32)	364	PRIMERA / CAMINO (HNP10)	373
BLUEBIRD SYLPHY (FG10)	359	MAXIMA QX (A33)	364	PRIMERA / CAMINO (HNP11)	373
BLUEBIRD SYLPHY (G10)	359	MAXIMA STATION WAGON	364	PRIMERA / CAMINO (HP11)	373
BLUEBIRD SYLPHY (G11E)	360	MICRA / MARCH (k12)	364	PRIMERA / CAMINO (P10)	373
BLUEBIRD SYLPHY (QG10)	360	MICRA C+C (K12)	364	PRIMERA / CAMINO (P11)	373
BLUEBIRD SYLPHY (TG10)	360	MICRA I (K10)	365	PRIMERA / CAMINO (P12DDA)	373
BLUEBIRD VAN / WAGON (VEU11)	360	MICRA II (K11)	365	PRIMERA / CAMINO (P12EDA)	373
BLUEBIRD VAN / WAGON (WU11)	360	MICRA III	365	PRIMERA II (P11)	374
CALIFORNIA (B11)	360	MICRA III (K12)	365	PRIMERA II (WP11), SW	374
CALIFORNIA (B12)	360	MICRA III C+C (K12)	366	PRIMERA II / III	374
CALIFORNIA (WSB11)	360	MICRA IV (K13)	366	PRIMERA II / III (P11)	374
CALIFORNIA (WSB12)	360	MIERA II (K11)	366	PRIMERA III (P12), SW	374
CALIFORNIA (Y10)	360	MISTRAL / TERRANO II (R20)	366	PRIMERA TRAVELLER (W10)	374
CARAVAN HOMY (E24)	360	MURANO (KWZ50)	366	PRIMERA TRAVELLER (WP11)	374
CEFIRO	360	MURANO (Z50)	366	PRIMERA UK (FHP10)	375
CEFIRO J30	360	MURANO (Z51)	366	PRIMERA UK (P10)	375
CEFIRO MAXIMA (A33)	360	NAVARA (D40)	366	PRIMERA UK (P11)	375
CHERRY	360	NOTE (E11)	366	PRIMERA UK (P12E)	375
CHERRY II (N10)	360	NOTE (E11E)	367	PRIMERA WAGON (WHP11)	375
CHERRY II TRAVELLER (VN10)	361	NOTE (E12)	367	PRIMERA WAGON / CAMINO WAGON (P12DDA)	375
CHERRY III (N12)	361	NP300	367	PRIMERA WAGON / CAMINO WAGON (P12EDA)	375
CUBE (Z11)	361	NV200	367	PRIMERA WAGON / CAMINO WAGON (WHNP11)	375
CUBE (Z12)	361	NV200 EVALIA	367	PRIMERA WAGON / CAMINO WAGON (WHP11)	375
CUBE Z11	361	NV400	367	PRIMERA WAGON / CAMINO WAGON (WP11)	375
DATSUN (D21)	361	NX COUPE	368	PRIMERA WAGON CAMINO WAGON (WP11)	375

MAKE-MODEL	PAGE	MAKE-MODEL	PAGE	MAKE-MODEL	PAGE
<b>NISSAN</b>		SUNNY / SENTRA (SNB13)	379	ASCONA	386
		SUNNY / SENTRA (SNB14)	379	ASCONA C (81_, 86_, 87_, 88_)	386
PULSAR	375	SUNNY II (B12)	379	ASCONA C (84_, 89_)	386
PULSAR (INTL) SE MODELS	375	SUNNY II (N13)	380	ASTRA	387
PULSAR / ALMERA (N13)	375	SUNNY III (N14)	380	ASTRA / VECTRA	387
PULSAR / ALMERA (N14)	375	SUNNY III (Y10)	381	ASTRA F	387
PULSAR / ALMERA (PN12)	375	TEANA (J31)	381	ASTRA F (51_, 52_)	387
PULSAR / ALMERA (RNN14)	375	TEANA (J32)	381	ASTRA F (53_, 54_, 58_, 59_)	388
PULSAR / ALMERA (SN12)	375	TERRANO (WD21)	381	ASTRA F (53_B)	388
PULSAR / ALMERA (SN13)	375	TERRANO / PATHFINDER (BYD21)	381	ASTRA F (56_, 57_)	389
PULSAR / ALMERA (SN14)	375	TERRANO / PATHFINDER (D21)	381	ASTRA F CLASSIC	389
PULSAR / ALMERA (SN15)	375	TERRANO II (R20)	381	ASTRA F CLASSIC, SW	390
PULSAR / ALMERA (SNN15)	376	TERRANO VAN (R20)	382	ASTRA F VAN (55_)	390
PULSAR / LUCINO / ALMERA (EN13)	376	TIIDA	382	ASTRA G	390
PULSAR / LUCINO / ALMERA (EN14)	376	TIIDA (C11)	382	ASTRA G (F07_)	390
PULSAR / LUCINO / ALMERA (EN15)	376	TIIDA (C11X)	382	ASTRA G (F35_)	391
PULSAR / LUCINO / ALMERA (FN13)	376	TIIDA (C11_)	382	ASTRA G (F48_, F08_)	391
PULSAR / LUCINO / ALMERA (FN14)	376	TIIDA (SC11X)	382	ASTRA G (F67)	392
PULSAR / LUCINO / ALMERA (FN15)	376	TIIDA LATIO (C11)	382	ASTRA G (F69_)	392
PULSAR / LUCINO / ALMERA (FNN13)	376	TIIDA LATIO (SC11)	382	ASTRA G (F70)	393
PULSAR / LUCINO / ALMERA (FNN14)	376	TSUBAME	382	ASTRA G, SW	393
PULSAR / LUCINO / ALMERA (FNN15)	376	TSURU	382	ASTRA GTC J	394
PULSAR / LUCINO / ALMERA (HN12)	376	TSURU / TSUBAME	382	ASTRA H	394
PULSAR / LUCINO / ALMERA (HN13)	376	TSURU GS	382	ASTRA H (L35)	394
PULSAR / LUCINO / ALMERA (HNN13)	376	TSURU I	382	ASTRA H (L48)	395
PULSAR SE MODEL DOHC	376	TSURU II	382	ASTRA H (L69)	396
QASHQAI	376	TSURU III	383	ASTRA H CABRIO	396
QASHQAI (J10, JJ10)	376	TSURU III GS	383	ASTRA H SPORP HATCH (L08)	396
QASHQAI / QASHQAI +2 (J10, JJ10)	376	VANETTE (C22)	383	ASTRA H TWINTOP (L67)	397
QUEST	377	WINGROAD (WEY10)	383	ASTRA H VAN (L70)	398
RASHEEN (RFNB14)	377	WINGROAD (WFNY10)	383	ASTRA H, GTC, SW	398
ROGUE	377	WINGROAD (WFY10)	383	ASTRA J	399
S-CARGO (G20)	377	WINGROAD (WHNY10)	383	ASTRA J SPORTS TOURER	400
SAFARI PATROL (Y61)	377	WINGROAD (WHY11)	383	ASTRA J, GTC, SW	400
SENTRA	377	X-TRAIL	383	ASTRA J, SW, GTC	400
SENTRA DOHC	377	X-TRAIL (NT31)	383	CALIBRA A (85)	400
SENTRA HS	377	X-TRAIL (T30)	383	CALIBRA A (85_)	401
SERENA (BC24)	377	X-TRAIL (T31)	384	CASCADA (W13)	401
SERENA (C23)	377	X-TRAIL (TNT31)	384	CHEVY	401
SERENA (C23M)	378	XTERRA	384	COMBO	401
SERENA (VC24)	378	<b>NISSAN LCV</b>		COMBO B	402
SPIRIT	378	INTERSTAR (X70)	384	COMBO II	402
STANZA	378	KUBISTAR (X76)	384	COMBO TOUR	402
STANZA (T11)	378	<b>OLDSMOBILE</b>		CORSA A	403
STANZA (T12)	378	BRAVADA	384	CORSA A (93_, 94_, 98_, 99_)	404
SUNNY	378	CUTLASS SUPREME	384	CORSA A TR (91_, 92_, 96_, 97_)	404
SUNNY (B11)	378	EUROSPORT	384	CORSA B	404
SUNNY (Y10)	378	TORONADO	384	CORSA B (73, 78, 79, F35)	404
SUNNY / SENTRA (B11)	378	<b>OPEL</b>		CORSA B (73_, 78_, 79_)	404
SUNNY / SENTRA (B12)	378	ADAM	385	CORSA C	404
SUNNY / SENTRA (B13)	379	AGILA (A) (H00)	385	CORSA C (F08, F68)	404
SUNNY / SENTRA (B14)	379	AGILA (B) (H08)	385	CORSA C (F08, W5L)	406
SUNNY / SENTRA (B15)	379	AGILA A (H00)	385	CORSA D	407
SUNNY / SENTRA (EB12)	379	AGILA B	385	CORSA D VAN	408
SUNNY / SENTRA (EB13)	379	ANTARA	385	INSIGNIA	408
SUNNY / SENTRA (EB14)	379	ARENA (TB, TF)	386	INSIGNIA SPORTS TOURER	410
SUNNY / SENTRA (SB11)	379	ARENA (THB)	386	KADETT	410
SUNNY / SENTRA (SB12)	379			KADETT D (31_-34_, 41_-44_)	410
SUNNY / SENTRA (SB13)	379			KADETT D (35_, 36_, 45_, 46_)	411
SUNNY / SENTRA (SB14)	379			KADETT E (33_, 34_, 43_, 44_)	411

MAKE-MODEL	PAGE	MAKE-MODEL	PAGE	MAKE-MODEL	PAGE
<b>OPEL</b>		106 II	433	407 (6D_)	461
		106 II (1)	433	407 (6E_)	462
KADETT E (35_, 36_, 45_, 46_)	412	107	433	5008	462
KADETT E (37_, 47_)	413	508	433	504	463
KADETT E (39_, 49_)	414	2008	433	508 SW	463
KADETT E (43B_)	415	205	433	605 (6B)	463
KADETT E / ASTRA E, BELMONT	415	205 (741A/C)	433	607 (9D, 9U)	465
KADETT E COMBO (38_, 48_)	415	205 (741B, 20D)	435	806 (221)	465
KADETT E SW	416	205 II (20A/C)	435	807 (E)	466
MERIVA	416	205 VAN	436	BIPPER	466
MERIVA A	416	206	436	BIPPER (AA_)	466
MERIVA B	416	206 (2A/C)	436	BIPPER TEPEE	466
MOVANO (F9)	417	206 (2E/K)	437	BOXER	466
MOVANO (H9)	417	206 CC (2D)	438	BOXER (230L)	467
MOVANO (J9)	417	206 VAN	438	BOXER (230P)	470
MOVANO (U9, E9)	418	206-TRE VOLUMI	438	BOXER (244)	473
MOVANO B	418	207	438	BOXER (244, Z_)	473
MOVANO B KASTEN	418	207 (WA_, WC_)	438	BOXER (ZCT_)	473
SIGNUM	418	207 (WK_)	439	BOXER I-II	476
TIGRA (95_)	420	207 CC (WD_)	440	BOXER III	476
TIGRA B TWINTOP	420	207 VAN	440	EXPERT	476
TIGRA TWINTOP	420	208	440	EXPERT (224)	476
VECTRA A (86, 87)	420	3008	441	EXPERT (VF3A_, VF3U_, VF3X_)	476
VECTRA A (86_, 87_)	420	305	442	EXPERT TEPEE	477
VECTRA A (88_, 89_)	422	305 II (581E)	442	EXPERT TEPEE (VF3V_)	477
VECTRA B (31_)	423	305 II (581M)	442	EXPERT VAN (222)	477
VECTRA B (36), SW	423	306	442	J10 PREMIER	477
VECTRA B (36_)	424	306 (7A, 7C, N3, N5)	442	J5	477
VECTRA B (38_)	424	306 (7B, N3, N5)	443	J5 (280L)	477
VECTRA C	425	306 (7B,N3)	443	J5 (280P)	478
VECTRA C GTS	427	306 (7D, N3, N5)	443	J5 (290L)	478
VECTRA C, SW	429	306 BREAK (7E, N3, N5)	444	J5 (290P)	478
VIVARO	429	306 II	445	J9	479
VIVARO (E7)	429	307 (3A/C)	445	J9 PREMIER	479
VIVARO (F7)	429	307 (3E)	446	PARTNER	479
VIVARO (J7)	430	307 (3H)	447	PARTNER (5)	480
ZAFIRA	431	307 CC (3B)	448	PARTNER COMBISPACE (5F)	480
ZAFIRA A	431	308 (4A_, 4C_)	448	PARTNER MPV	480
ZAFIRA A (F75)	431	308 CC	450	PARTNER TEPEE	480
ZAFIRA A (F75_)	431	308 SW	451	PARTNER VAN (5)	481
ZAFIRA B	431	309 (10C, 10A)	453	RCZ	481
ZAFIRA B (A05)	432	309 II (3C, 3A)	453		
ZAFIRA B VAN	432	4007 (GP_)	454	<b>PEUGEOT LCV</b>	
ZAFIRA TOURER C (P12)	432	405	454	BIPPER (AA)	482
<b>OPEL LCV</b>		405 (15B)	454	BOXER	482
		405 (15E)	455	<b>PIAGGIO</b>	
ASTRA G VAN (F70)	432	405 II (4B)	455	<b>PLYMOUTH</b>	
ASTRA H VAN	433	405 II (4E)	456	PORTER	482
CORSA C VAN (F08, W5L)	433	405 II (4E) BREAK	456	<b>ACCLAIM</b>	
MOVANO I (J9)	433	406	456	COLT VISTA	482
ZAFIRA VAN	433	406 (8B)	456	NEON	482
<b>PERODUA</b>		406 (8B), 406 (8E/F), BREAK	458	RELIANT	482
		406 (8C)	458	SUNDANCE	482
KELISA (L7_)	433	406 (8E/F)	459	VOYAGER	482
<b>PEUGEOT</b>		406 / 406 BREAK	461	VOYAGER / GRAND VOYAGER	482
		406 I	461	VOYAGER VAN	482
1007 (KM)	433	406 II	461		
1007 (KM_)	433	407 (6C), COUPE	461		
104	433	407 (6C_)	461		
106	433	407 (6D), 407 (6E) SW	461		



MAKE-MODEL	PAGE	MAKE-MODEL	PAGE	MAKE-MODEL	PAGE
<b>PLYMOUTH TRUCK</b>		9 (L42)	491	MASTER I VAN (T_)	514
		9 (L42_)	491	MASTER II	514
VOYAGER VAN	482	AVANTIME (DE0_)	491	MASTER II (ED/HD/UD)	514
<b>PONTIAC</b>		CAPTUR	491	MASTER II (JD)	514
		CLIO	491	MASTER II VAN (FD)	515
GRAND PRIX	482	CLIO (B/C57_, 5/357_)	492	MASTER III	516
SUNBIRD (J-BODY)	482	CLIO / THALIA	493	MASTER III (EV, HV, UV)	516
<b>PORSCHE</b>		CLIO GRANDTOUR (KR0/1)	493	MASTER III (FV)	516
		CLIO GRANDTOUR (KR0/1_)	493	MASTER III (JV)	516
911	483	CLIO II	493	MEGANE	517
944	483	CLIO II (B/C/ B0/1)	494	MEGANE CC (EZ0/1_)	517
BOXSTER (986)	483	CLIO II (BB0/1/2_, CB0/1/2_)	494	MEGANE I (BA0/1)	517
BOXSTER (987)	483	CLIO II (SB0/1/2_)	496	MEGANE I (BA0/1_)	517
CAYENNE (955)	483	CLIO III (BR0/1, CR0/1)	497	MEGANE I (DA0/1), COACH	518
<b>PROTON</b>		CLIO IV	498	MEGANE I (KA0/1), SW	518
		CLIO MK II (BB0/1/2_, CB0/1/2_)	498	MEGANE I (LA0/1), CLASSIC	518
PERSONA (CM3)	484	ESPACE (J11_)	498	MEGANE I CABRIOLET (EA0/1_)	518
PERSONA (CM6)	484	ESPACE II (J/S63_)	498	MEGANE I CLASSIC (LA0/1_)	519
PREDANA	484	ESPACE III (JE0_)	499	MEGANE I COACH (DA0/1_)	520
PROTON	484	ESPACE IV (JK0/1)	499	MEGANE I GRANDTOUR (KA0/1_)	520
SAGA	484	ESPACE IV (JK0/1_)	499	MEGANE II	521
SAGA (BT3)	484	EXPRESS	499	MEGANE II (BM0/1, CM0/1)	521
SATRIA (C9_M)	484	EXTRA VAN (F40_, G40_)	500	MEGANE II (BM0/1_, CM0/1_)	521
WIRA	484	FLUENCE (L30_)	500	MEGANE II (EM0/1)	523
WIRA (C9_C, C9_S)	484	FUEGO	500	MEGANE II (EM0/1_)	523
WIRA (C9_S)	484	FUEGO (136_)	500	MEGANE II (KM0/1), SW	523
<b>RENAULT</b>		GRAND MODUS	500	MEGANE II (KM0/1_)	523
		GRAND SCENIC I (JM0/1)	500	MEGANE II (LM0/1)	524
11 (B/C37_)	484	GRAND SCENIC II (JM0/1_)	501	MEGANE II (LM0/1_)	524
12	484	GRAND SCENIC III (JZ0/1_)	501	MEGANE II COUPE-CABRIOLET II (EM0/1_)	525
15 (130_)	484	KANGOO	501	MEGANE II SPORT TOURER (KM0/1_)	525
17	484	KANGOO (KC0/1)	502	MEGANE III (BZ0_)	526
18	484	KANGOO (KC0/1_)	502	MEGANE III (DZ0/1_)	526
18 (134_)	484	KANGOO / GRAND KANGOO (KW0/1_)	503	MEGANE III GRANDTOUR (KZ0/1)	527
18 GTL	484	KANGOO BE BOP (KW0/1_)	504	MEGANE SCENIC (JA0/1_)	527
18 GTX	484	KANGOO EXPRESS (FC0/1_)	504	MODUS (F/JP0)	527
18 VARIABLE (135_)	484	KANGOO EXPRESS (FW0/1_)	505	MODUS / GRAND MODUS (F/JP0_)	528
19	484	KANGOO I (FC0/1), VAN	505	PLUENCE	528
19 (B/C53_)	484	KANGOO MPV	505	R12 TL	528
19 (D53_)	485	KANGOO VAN	506	RODEO 5	529
19 (L53_)	485	KOLEOS (HY_)	506	RODEO 6	529
19 II (B/C53_)	485	LAGUNA	506	SAFRANE	529
19 II (D53_, 853_)	487	LAGUNA (DT0/1)	506	SAFRANE (B54_)	529
19 II (L53_)	487	LAGUNA I	506	SAFRANE II (B54_)	529
19 II (S53_)	488	LAGUNA I (B56, 556, K56), SW	506	SCENIC	529
20 (127_)	488	LAGUNA I (B56_, 556_)	507	SCENIC / J64	529
21	488	LAGUNA I (K56_)	508	SCENIC I (JA0/1)	529
21 (B48_)	488	LAGUNA II	510	SCENIC I (JA0/1_)	529
21 (L48_)	489	LAGUNA II (B74, K74), SW	510	SCENIC II	530
21 SAVANNA (K48_)	489	LAGUNA II (BG0/1_)	510	SCENIC II (JM0/1)	530
25 (B29_)	490	LAGUNA II SPORT TOURER (KG0/1_)	511	SCENIC II (JM0/1_)	531
30 (127_)	490	LAGUNA III (BT0/1)	513	SCENIC III (JZ0/1_)	531
4	490	LAGUNA III (BTO/1)	513	SUPER 5 (B/C40_)	532
4 (112)	490	LAGUNA III GRANDTOUR (KT0/1)	513	THALIA (LB0/1/2)	533
4 (112_)	491	LAGUNA III SPORT TOURER (KT0/1)	513	THALIA I (LB0/1/2_)	533
4 (R21_, R23_)	491	LOGAN (KS_)	513	TRAFIC	533
5 (122_)	491	LOGAN (LS, KS), SW	513	TRAFIC (P6)	533
6	491	MAGANE	513	TRAFIC (PXX)	534
6 (118_)	491	MASTER I (P_)	514	TRAFIC (T1, T3, T4)	534
9	491	MASTER I (T_)	514	TRAFIC (T5, T6, T7)	534

MAKE-MODEL	PAGE	MAKE-MODEL	PAGE	MAKE-MODEL	PAGE
<b>RENAULT</b>		<b>SEAT</b>		OCTAVIA (1Z5)	576
TRAFIC (TXW)	534	ALHAMBRA	546	OCTAVIA (5E3)	578
TRAFIC (TXX)	534	ALHAMBRA (710)	546	OCTAVIA COMBI (5E5)	578
TRAFIC DIESEL	535	ALHAMBRA (7V8, 7V9)	546	OCTAVIA II (1U2, 1U5), SW	579
TRAFIC ESSENCE	535	ALTEA (5P1)	548	OCTAVIA III (1Z3, 1Z5), SW	579
TRAFIC II (EL)	535	ALTEA XL (5P5, 5P8)	550	OCTAVIA IV (5E3, 5E5), SW	579
TRAFIC II (JL)	535	AROSA (6H)	552	RAPID (NH1)	579
TRAFIC II VAN (FL)	535	CORDOBA (6K2)	553	ROOMSTER (5J)	579
TWINGO I (C06)	536	CORDOBA (6L2)	553	ROOMSTER (5J7, 5J), PRAKTIK	580
TWINGO I (C06_)	536	CORDOBA GLX / SXE	554	ROOMSTER PRAKTIK (5J)	580
TWINGO II (CN0)	536	CORDOBA II (6K2, 6K5), VARIO	554	SUPERB	580
TWINGO II (CN0_)	536	CORDOBA III (6L2)	554	SUPERB (3T4)	580
VEL SATIS	537	CORDOBA VARIO (6K5)	554	SUPERB (3T5)	581
<b>RENAULT LCV</b>		EXEO (3R2)	554	SUPERB (3U4)	582
CLIO II (SB0/1/2), VAN	537	EXEO ST (3R5)	555	SUPERB II (3T4, 3T5), SW	583
CLIO III, VAN	537	IBIZA (021A)	555	YETI (5L)	583
KANGOO I (FC0/1), VAN	537	IBIZA GLX / SXE	555	<b>SMART</b>	
MASTER III	537	IBIZA III (6K1)	555	CABRIO (450)	584
MEGANE II VAN	537	IBIZA IV (6L1)	556	CITY-COUPE (450)	584
MODUS VAN	537	IBIZA V (6J1, 6J5, 6J8), ST, SW	557	CROSSBLADE (450)	585
TRAFIC III (EL, FL, J6)	537	IBIZA V (6J5)	558	FORFOUR (454)	585
<b>ROVER</b>		IBIZA V SPORTCOUPE (6J1)	558	FORTWO (450)	585
100 / METRO (XP)	537	IBIZA V ST (6J8)	559	FORTWO (451)	585
200 (XW)	537	INCA	559	FORTWO CABRIO (450)	585
200 SERIES	538	INCA (6K9)	559	FORTWO CABRIO (451)	585
25 (RF)	538	LEON (1M1)	559	FORTWO, CABRIO, COUPE	586
400 (XW)	539	LEON (1P1)	560	ROADSTER (452)	586
400 SERIES	539	LEON (5F1)	562	<b>SSANGYONG</b>	
45 (RT)	539	LEON II (1P1)	562	FAMILY	586
600	540	LEON III (5F1, 5F5), SC	563	KYRON	586
600 (RH)	540	LEON SC (5F5)	563	MUSSO (FJ)	586
75 (RJ)	540	LEON ST (5F8)	563	REXTON	586
75 TOURER (RJ)	540	MII (KF1_)	564	REXTON (GAB_)	586
800	540	OCTAVIA III (1U2, 1U5), SW	564	REXTON I	586
800 (XS)	540	OCTAVIA III (1Z3, 1Z5), SW	564	REXTON II	586
CABRIOLET (XW)	541	RONDA (022A)	564	<b>SUBARU</b>	
MG ZR	541	TOLEDO	564	ALCYONE / LEONE / LOYALE / DOMINGO	586
MG ZS	541	TOLEDO II (1M2)	564	B4	586
MINI	541	TOLEDO III (5P2)	565	BRUMBY	586
MONTEGO (XE)	541	TOLEDO IV (KG3)	566	FIORI	586
STREETWISE	541	<b>SKODA</b>		FORESTER	586
<b>SAAB</b>		CITIGO	566	FORESTER (SF)	586
9-3	541	FABIA	566	FORESTER (SG)	586
9-3 (YS3D)	541	FABIA (6Y2)	567	FORESTER (SH)	586
9-3 (YS3F)	541	FABIA (6Y3)	568	IMPREZA	586
9-3 CABRIOLET (YS3D)	542	FABIA (6Y5)	568	IMPREZA (CDAC)	588
9-3 I (YS3D)	542	FABIA COMBI	569	IMPREZA (GD2D)	588
9-3 II (YS3F)	542	FABIA I (6Y2, 6Y3, 6Y5), SW	570	IMPREZA (GD2E)	588
9-5 (YS3E)	544	FABIA II (5J2), SW	570	IMPREZA (GD2F)	588
9-5 (YS3G)	544	FABIA PRAKTIK	570	IMPREZA (GD3D)	588
9-5 I (YS3E)	544	FAVORIT (781)	571	IMPREZA (GD3E)	588
900	544	FAVORIT (787)	571	IMPREZA (GD9A)	588
900 (AC4, AM4)	545	FAVORIT FORMAN (785)	571	IMPREZA (GD9B)	588
900 II	545	FELICIA I FUN (797)	571	IMPREZA (GD9C)	588
9000	545	OCTAVIA	571	IMPREZA (GDAA)	588
		OCTAVIA (1U2)	571	IMPREZA (GDAB)	588
		OCTAVIA (1U5)	572	IMPREZA (GDAC)	588
		OCTAVIA (1Z3)	574		

MAKE-MODEL	PAGE	MAKE-MODEL	PAGE	MAKE-MODEL	PAGE
<b>SUBARU</b>		ALTO II (EC)	594	SX4 (YB11)	600
IMPREZA (GDAD)	588	ALTO III (EF)	594	TUTTO	600
IMPREZA (GDAE)	588	ALTO IV (FF)	594	VITARA (ET, TA)	600
IMPREZA (GDAF)	588	ALTO V (GF)	594	VITARA CABRIO (ET, TA)	600
IMPREZA (GC)	588	BALENO	594	WAGON R	600
IMPREZA (GC8)	588	BALENO (EG)	594	WAGON R+ (EM)	600
IMPREZA (GD, GG)	589	BALENO (EG), SW	595	WAGON R+ (MM)	600
IMPREZA (GDBD)	589	BALENO / CULTUS	595	WAGON R+ I (EM)	600
IMPREZA (GDBE)	589	BALENO NEXTG (INDONESIA) (RM415)	595	WAGON R+ II (MM)	601
IMPREZA (GF)	589	CRESCENT	595	WAGON-R (MC22S)	601
IMPREZA (GF8)	590	CULTUS	595	<b>TATA</b>	
IMPREZA (GFC)	590	CULTUS BALENO (DG31S)	595	INDICA	601
IMPREZA (GFC)	590	CULTUS BALENO (GA11S)	595	INDIGO	601
IMPREZA (GR, GH, G3)	590	CULTUS BALENO (GA21S)	595	<b>TOYOTA</b>	
IMPREZA / WRX / STI	590	CULTUS BALENO (GC21S)	595	4 RUNNER	601
IMPREZA SPORTS WAGON (GGBA)	590	CULTUS BALENO (GC21W)	595	4 RUNNER (KZN18_, VZN18_, RZN18_)	601
IMPREZA SPORTS WAGON (GGBB)	590	CULTUS CRESCENT WAGON (GC41W)	595	ALLION (AZT240)	601
JUSTY (KA7)	590	ESCUDO VITARA	596	ALPHARD (ANH10W)	601
JUSTY (KA8)	590	ESCUDO VITARA (TA02)	596	ALPHARD (ANH15W)	601
JUSTY (KAD)	590	ESCUDO VITARA (TA11W)	596	ALPHARD (ANH20,GGH20)	601
JUSTY III (G3X)	590	ESCUDO VITARA (TA31W)	596	ALPHARD (ATH1_, MNH1_, ANH1_)	601
LEGACY	590	ESCUDO VITARA (TA52)	596	ALPHARD (MNH10W)	601
LEGACY (BC)	591	ESCUDO VITARA (TD02)	596	ALPHARD (MNH15W)	601
LEGACY (BC, BJF)	591	ESCUDO VITARA (TD11W)	596	ALPHARD (NH10W)	601
LEGACY (BE5)	591	ESCUDO VITARA (TD31W)	596	ALPHARD (NH15W)	601
LEGACY (BH5)	591	ESCUDO VITARA (TD52)	596	ALPHARD / VELLFIRE (ANH20,GGH20)	601
LEGACY (BH9)	591	ESCUDO VITARA (TD54W)	596	ALPHARD / VELLFIRE (ANH25,GGH25)	601
LEGACY (BHC)	591	ESCUDO VITARA (TD94W)	596	ALPHARD / VELLFIRE (GGH2_, ANH2_, ATH2_)	601
LEGACY / WRX	591	ESTEEM	596	ALTEZZA GITA (GXE15, JCE15)	601
LEGACY I	591	GRAND ESCUDO VITARA	596	AURIS (22E15)	601
LEGACY II (BD, BG)	591	GRAND VITARA / ESCUDO	596	AURIS (NRE15_, ZZE15_, ADE15_, ZRE15_, NDE15_)	602
LEGACY III (BE, BH)	591	GRAND VITARA I (FT, GT)	596	AURIS (NZE18_, ZRE18_)	602
LEGACY IV	591	GRAND VITARA II (JT)	596	AURIS TOURING SPORTS (ADE18_, ZWE18_, ZRE18_)	602
LEGACY IV (B13_)	592	IGNIS (FH)	596	AURIS VAN (NDE15_)	602
LEGACY V	592	IGNIS I (FH)	596	AURIS VAN (ZRE18_, NZE18_)	602
LEONE	592	IGNIS II	596	AVALON	602
LEONE (AB)	592	IGNIS II (MH)	597	AVENSIS	602
LEONE II	592	JIMNY (FJ)	597	AVENSIS (ACM20)	602
LIBERO (E10, E12)	592	JIMNY / SIERRA / SAMURAI (JA51)	597	AVENSIS (T25)	602
LIBERTY	593	JIMNY / SIERRA / SAMURAI (JB31W)	597	AVENSIS (T250)	603
OUTBACK	593	KARIMUN	597	AVENSIS (T250W)	603
OUTBACK (BE, BH)	593	KEI (HN22S)	597	AVENSIS (T251)	603
OUTBACK (BL, BP)	593	LIANA (ER)	597	AVENSIS (T251W)	603
OUTBACK (BM, BR)	593	MARUTI II	598	AVENSIS (T25_)	603
PICK UP	593	SAMURAI (SJ)	598	AVENSIS (ZRT27, ADT27)	603
REX III	593	SPLASH	598	AVENSIS (_T22_)	604
SHERPA	593	SPRINT FIREFLY	598	AVENSIS I (722), SW	604
SVX	593	SWIFT	598	AVENSIS LIFTBACK (_T22_)	604
VIVIO	593	SWIFT (AA)	599	AVENSIS STATION WAGON (_T22_)	605
XT (XT)	593	SWIFT (ZC11S)	599	AVENSIS VERSO (M20)	605
<b>SUZUKI</b>		SWIFT (ZD11S)	599	AVENSIS VERSO (_CLM2_, _ACM2_)	605
AERIO (INDONESIA) (RH415)	593	SWIFT (ZD21S)	599	AYGO (KGB, WNB)	605
ALTO	593	SWIFT II (AH, AJ)	599	AYGO (WNB1_, KGB1_)	605
ALTO (HA23S/V)	593	SWIFT II (EA, MA)	599	BANDEIRANTES	605
ALTO (HA25, HA35)	593	SWIFT III	599	BLADE (AZE154)	605
ALTO (RF410)	593	SWIFT III (MZ, EZ)	599	BLADE (AZE156,GRE156)	605
ALTO (SS80)	593	SX4 (GY)	600	CALDINA (AZT241W)	605
ALTO / FRONTE / CERVO	594	SX4 (YA11)	600	CALDINA (ET196V)	605
ALTO I	594	SX4 (YA41)	600		
		SX4 (YA41) 4WD	600		



MAKE-MODEL	PAGE	MAKE-MODEL	PAGE	MAKE-MODEL	PAGE
<b>TOYOTA</b>		COROLLA (E8 - E11 / EL,FX,GT,NP)	611	CYNOS (EL44)	616
		COROLLA (NRE18_, ZRE17_, ZRE18_, NDE18_)	611	CYNOS (EL52)	616
CAMI (J100E)	605	COROLLA (NZE121, ZZE121)	611	CYNOS (EL54)	616
CAMI (J102E)	605	COROLLA (ZZ121)	611	ESTIMA	616
CAMRY	606	COROLLA (ZZE122)	612	ESTIMA (ACR50)	616
CAMRY (ACV30)	606	COROLLA (ZZE12_, NDE12_, ZDE12_)	612	ESTIMA (ACR55)	616
CAMRY (ACZ35)	606	COROLLA (_E10_)	612	ESTIMA (CR50W)	616
CAMRY (MCV3_, ACV3_, _XV3_)	606	COROLLA (_E12J_, _E12T_)	612	ESTIMA (CR55W)	617
CAMRY (V2),SW	606	COROLLA (_E8_)	612	ESTIMA (CXR20G)	617
CAMRY (_CV1_, _XV1_, _V1_)	606	COROLLA (_E9_)	612	ESTIMA (SR50W)	617
CAMRY (_CV2_, _XV2_)	606	COROLLA / DX / LE / SR5 (2WD)	612	ESTIMA (SR55W)	617
CAMRY (_V1_)	606	COROLLA / SPRINTER (AE100)	613	ESTIMA PREVIA (MCR30W)	617
CAMRY (_V2_)	606	COROLLA / SPRINTER (AE101)	613	ESTIMA PREVIA (MCR40W)	617
CAMRY / SOLARA	607	COROLLA / SPRINTER (AE92)	613	ESTIMA PREVIA (TCR20)	617
CAMRY / VISTA / SCEPTER	607	COROLLA / SPRINTER (CDE120 DSL)	613	ESTIMA PREVIA (TCR21)	617
CAMRY GRACIA (SXV20)	607	COROLLA / SPRINTER VAN / WAGON (AE100G)	613	EXIV ED (ST182)	617
CAMRY LIFTBACK (_V1_)	607	COROLLA COMPACT (_E10_)	613	EXIV ED (ST183)	617
CAMRY STATION WAGON (_V2_)	607	COROLLA COMPACT (_E11_)	613	EXIV ED (ST202)	617
CAMRY STATION WAGON (_XV1_, _CV1_, _V10)	607	COROLLA COMPACT (_E9_)	613	EXIV ED (ST203)	617
CAMRY VISTA (CV20)	607	COROLLA FX	613	GEO	617
CAMRY VISTA (CV30)	607	COROLLA FX COMPACT (E8B)	613	GRAND HIACE (KCH16W)	617
CAMRY VISTA (CV40)	607	COROLLA FX.FX16	613	GRANVIA (KCH16W)	617
CAMRY VISTA (SV21)	607	COROLLA II / TERCEL / CORSA (EL41)	613	GRANVIA (VCH16W)	617
CAMRY VISTA (SV25)	608	COROLLA II / TERCEL / CORSA (EL43)	613	HARRIER	617
CAMRY VISTA (SV32)	608	COROLLA II / TERCEL / CORSA (EL45)	613	HARRIER (ACU30W)	617
CAMRY VISTA (SV33)	608	COROLLA II / TERCEL / CORSA (EL51)	613	HARRIER (ACU35W)	617
CAMRY VISTA (VZV20)	608	COROLLA II / TERCEL / CORSA (EL53)	614	HARRIER (CU10W)	617
CAMRY VISTA (VZV30)	608	COROLLA II / TERCEL / CORSA (EL55)	614	HARRIER (CU15W)	617
CAMRY VISTA (VZV31)	608	COROLLA II / TERCEL / CORSA (NL30)	614	HARRIER (HU38W)	617
CAMRY VISTA (VZV32)	608	COROLLA II / TERCEL / CORSA (NL40)	614	HARRIER (MCU30W)	617
CAMRY VISTA (VZV33)	608	COROLLA II / TERCEL / CORSA (NL50)	614	HARRIER (MCU31W)	617
CARINA E (_T19_)	608	COROLLA III (E8)	614	HARRIER (MCU35W)	618
CARINA E VI	609	COROLLA IV (E9), SW,COMPACT	614	HARRIER (MCU36W)	618
CARINA II (T15)	609	COROLLA IV (E9),SW,COMPACT,LIFTBACK	614	HARRIER (SU30W/SU31W)	618
CARINA II (_T15_)	609	COROLLA LIFTBACK (_E10_)	614	HARRIER (SU35W/SU36W)	618
CARINA II (_T17_)	609	COROLLA LIFTBACK (_E11_)	614	HIACE IV (LH1_)	618
CARINA III (T17), SW	609	COROLLA LIFTBACK (_E8_)	614	HIACE IV (TRH2_, KDH2_)	618
CELICA	609	COROLLA LIFTBACK (_E9_)	615	HILUX	618
CELICA (AT16_, ST16_)	609	COROLLA RUNX / ALLEX (NZE121)	615	HILUX (MALAYSIA (KDN165)	618
CELICA (AT18_, ST18_)	610	COROLLA RUNX / ALLEX (NZE124)	615	HILUX II (RN6_, RN5_, LN6_, YN6_, YN5_, LN5_)	618
CELICA (AT20_, ST20_)	610	COROLLA RUNX / ALLEX (ZZE123)	615	HILUX III (TGN1_, GGN2_, GGN1_, KUN2_, KUN1_)	618
CELICA (ST162)	610	COROLLA SR5	615	HILUX PICK UP	619
CELICA (ST16_, AT16_)	610	COROLLA STATION WAGON (_E9_)	615	HILUX PICK UP (LN167)	619
CELICA (ST182)	610	COROLLA VERSO (ZDE12_, CDE12_)	615	HILUX PICK UP (LN172H)	619
CELICA (ST183)	610	COROLLA VERSO (ZER_, ZZE_, R1_)	615	HILUX PICK UP (RZN167)	619
CELICA (ST185)	610	COROLLA WAGON (_E10_)	616	HILUX PICK UP (RZN169H)	619
CELICA (ST202)	610	CORONA	616	HILUX PICK UP (RZN174H)	619
CELICA (ST203)	610	CORONA / CARINA (AT175)	616	HILUX SURF4RUNNER (N185W)	619
CELICA (ST20_, AT20_)	610	CORONA / CARINA (AT210)	616	HILUX SURF4RUNNER (N215W)	619
CELICA (ZZT23_)	610	CORONA / CARINA (AT211)	616	IPSUM PICNIC (ACM21W)	619
CELICA (_A6_)	610	CORONA / CARINA (AT212)	616	IPSUM PICNIC (ACM26W)	619
CELICA II (TA60, RA40, RA6)	611	CORONA / CARINA (ST162)	616	IQ	619
CELICA IV	611	CORONA / CARINA (ST171)	616	IQ (AJ1)	619
CELICA IV (T18)	611	CORONA / CARINA (ST182)	616	IQ (KPJ1_, KGJ1_, NGJ1_, NUJ1_)	619
COROLLA	611	CORONA / CARINA (ST183)	616	KLUGER V (MCU20W)	619
COROLLA (AE86)	611	CORONA / CARINA (ST210)	616	LAND CRUISER	619
COROLLA (AE92)	611	CORONA II	616	LAND CRUISER (KDJ12_, GRJ12_)	619
COROLLA (E142)	611	CROWN MAJESTA (UZS155, JZS153, JZS157)	616	LAND CRUISER (KDJ15_, GRJ15_)	619
COROLLA (E144)	611	CURREN (ST206)	616	LAND CRUISER / HI-LUX / 4 RUNNER	619
COROLLA (E15_)	611	CURREN (ST207)	616	LAND CRUISER 105 SERIES	619



MAKE-MODEL	PAGE	MAKE-MODEL	PAGE	MAKE-MODEL	PAGE
<b>TOYOTA</b>		PROGRES (JCG15)	622	YARIS / VITZ (NLP13_, NSP13_, NCP13_, KSP13_)	626
LAND CRUISER 80 (_J8_)	619	RAUM (EXZ10)	622	YARIS / VITZ (SCP1_, NLP1_, NCP1_)	626
LAND CRUISER LEXUS LX470 (FZJ105)	620	RAUM (EXZ15)	622	YARIS / VITZ (SCP9_, NSP9_, KSP9_, NCP9_, ZSP9_)	626
LAND CRUISER LEXUS LX470 (FZJ71 / 74 / 78 / 79)	620	RAV 4	622	YARIS II (C/SP9)	626
LAND CRUISER LEXUS LX470 (HZJ105)	620	RAV 4 (SXA1_)	622	YARIS VERSO (_NLP2_, _NCP2_)	627
LAND CRUISER LEXUS LX470 (HZJ71 / 78 / 79)	620	RAV 4 II (CLA2_, XA2_, ZCA2_, ACA2_)	623	<b>VAUXHALL</b>	
LAND CRUISER LEXUS LX570 (_URJ202W_)	620	RAV 4 II (XA2)	623	ADAM	627
LAND CRUISER LEXUS LX571 (_URJ202W_)	620	RAV 4 III (ACA3_, ACE_, ALA3_, GSA3_, ZSA3_)	623	AGILA A (H00)	627
LAND CRUISER LEXUS LX572 (_URJ202W_)	620	RAV 4 IV (WWA4_, AVA4_, ZSA4_, ALA4_)	623	AGILA B	627
LAND CRUISER LEXUS LX573 (_URJ202W_)	620	RAV 4 IV (ZSA4_, ALA4_)	623	AGILA I (A)	627
LAND CRUSER AMAZON (UZJ100)	620	RAV4 (ACA3_,GSA3_)	623	AGILA II (B)	627
LEXUS (S196)	620	RUSH (J210E)	623	ARENA	628
LITEACE TOWNACE (CM40G)	620	SCEPTER	623	ARENA VAN	628
LITEACE TOWNACE (CM41V)	620	SCEPTER (SXV10)	623	ASTRA	628
LITEACE TOWNACE (CM60)	620	SCEPTER (SXV15)	623	ASTRA F	628
LITEACE TOWNACE (CM65)	620	SCEPTER (SXV15W)	623	ASTRA F CLASSIC, SW	628
LITEACE TOWNACE (CR30G)	620	SCION XB (AZE150)	623	ASTRA G	628
LITEACE TOWNACE (CR31)	620	SERA (EXY10)	623	ASTRA G, SW	628
LITEACE TOWNACE (CR36V)	620	SOLUNA	623	ASTRA GTC MK VI (J)	629
LITEACE TOWNACE (CR37G)	620	SPRINTER II (E8)	623	ASTRA GTC VI (J)	629
LITEACE TOWNACE (CR38)	620	STARLET	623	ASTRA H CABRIO	629
LITEACE TOWNACE (CR50)	620	STARLET (EP71)	624	ASTRA H, GTC, SW	629
LITEACE TOWNACE (CR51)	620	STARLET (EP76V)	624	ASTRA II	630
LITEACE TOWNACE (SR50)	620	STARLET (EP81)	624	ASTRA III (F)	631
LITEACE TOWNACE (YM40G)	621	STARLET (EP82)	624	ASTRA IV (G)	633
LITEACE TOWNACE (YM60)	621	STARLET (EP85)	624	ASTRA IV (G) (F67)	635
LITEACE TOWNACE (YR30G)	621	STARLET (EP91)	624	ASTRA J, GTC, SW	635
LUCIDA EMINA (CXR20)	621	STARLET (KP6_)	624	ASTRA J, SW, GTC	635
LUCIDA EMINA (CXR21)	621	STARLET (NCP42R)	624	ASTRA MK VI (J)	635
LUCIDA EMINA (TCR20)	621	STARLET (NP70)	624	ASTRA TWINTOP V (H)	635
LUCIDA EMINA (TCR21)	621	STARLET (NP76V)	624	ASTRA V (H)	635
MARK II BLIT (GX115, JZX115)	621	STARLET (NP80)	624	ASTRA V (H) SPORT HATCH	637
MARK II CHASER / CRESTA (GX105)	621	STARLET (NP90)	624	ASTRA VI (J)	638
MARK II QUALIS (SXV20)	621	STARLET (_P7_)	624	ASTRA VI (J) SPORTS TOURER	639
MARK X ZIO (ANA15)	621	STARLET (_P8_)	624	ASTRAVAN III (F)	639
MARK X ZIO (ANA1_,GGA10)	621	T100	624	ASTRAVAN IV (G)	639
MR 2 I (AW1_)	621	TACOMA	624	ASTRAVAN V (H)	640
MR 2 II	621	TERCEL	624	CALIBRA	640
MR-2 I (W1)	621	TERCEL (AL2_)	624	CALIBRA A (85)	640
PASSO (KGC10)	621	TERCEL (L1, L2)	625	CASCADA	641
PASSO (KGC15)	621	TERCEL (_L1_, _L2_)	625	CAVALIER II	641
PASSO (QNC10)	621	URBAN CRUISER (NSP1_, NLP1_, ZSP1_, NCP11_)	625	CAVALIER III	642
PICK UP	621	VEROSSA (GX115)	625	CAVALIER III (87)	643
PICNIC (_XM10)	621	VERSO (_AUR2_, _ZGR2_)	625	COMBO I (B)	644
PLATZ ECHO (NCP10)	621	VERSO S (NLP12_, NCP12_, NSP12_)	625	COMBO II (C) (F25)	644
PRADO (J120W)	621	VIGO	625	COMBO TOUR II (C) (F25)	645
PRADO (J121W)	622	VIOS	625	CORSA B	645
PRADO (J125W)	622	VISTA	625	CORSA B (73, 78, 79, F35)	645
PRADO (J90W)	622	VITZ / YARIS / ECHO	625	CORSA C	645
PRADO (J95W)	622	VITZ / YARIS / ECHO (CP10)	625	CORSA C (F08, F68)	646
PREMIO (AZT240)	622	VITZ / YARIS / ECHO (NCP11)	625	CORSA I	646
PREVIA (MCR3_, ACR3_, CLR3_)	622	VITZ / YARIS / ECHO (SCP10)	625	CORSA I (B)	646
PREVIA (TCR2_, TCR1_)	622	WISH	625	CORSA II (C) (W5L, F08)	646
PREVIA / TARAGO (ACR50)	622	WISH (ANE10G)	625	CORSA III (D) (L_8)	647
PRIUS	622	WISH (ANE10G,ANE11W)	625	CORSA VAN II	648
PRIUS (NHW11_)	622	WISH (ANE11W)	625	CORSAVAN II (C)	648
PRIUS (NHW20_)	622	WISH (ZNE10G)	625	CORSAVAN III (D)	649
PRIUS (ZVW3_)	622	WISH (ZNE14G)	625	INSIGNIA	649
PRIUS II (2VW30)	622	YARIS	625	INSIGNIA SPORTS TOURER	650
		YARIS / VITZ (CP90)	625		





MAKE-MODEL	PAGE	MAKE-MODEL	PAGE	MAKE-MODEL	PAGE
<b>VAUXHALL</b>		CADDY III (2KA, 2KB, 2KH, 2KJ)	668	LOGUS	697
KADETT E / ASTRA E, BELMONT	651	CADDY III (2KA, 2KH, 2CA, 2CH)	668	LUPO (6X1, 6E1)	697
KADETT E SW	651	CADDY III (2KB, 2KJ, 2CB, 2CJ)	669	MAGGIOLINO (5CI, 5C7)	697
MERIVA A	651	CADDY IV (2CA, 2CB)	670	MULTIVAN MK V (7HM, 7HN, 7HF, 7EF, 7EM, 7EN)	697
MERIVA I (A)	651	CC (358)	670	MULTIVAN V (7HM, 7HN, 7HF, 7EF, 7EM, 7EN)	697
MERIVA II (B)	652	CORRADO (53I)	671	NEW BEETLE (1Y7)	699
MOVANO I (A) (JD)	652	CRAFTER 30-35 (2E_)	671	NEW BEETLE (9C1, 1C1)	700
MOVANO I (A) CHASSIS/CAB (ED, UD, HD)	652	CRAFTER 30-50 (2E_)	671	NEW BEETLE (9C1, 1C1, 1Y7)	700
MOVANO I (A) VAN (FD)	653	CRAFTER 30-50 (2F_)	671	PARATI	700
NOVA	653	CROSS FOX	671	PARATI MI	700
SIGNUM	654	DERBY (86)	671	PASSAT	700
TIGRA	655	DERBY (86C, 80)	671	PASSAT (32)	700
TIGRA B TWINTOP	655	EOS (1F7, 1F8)	671	PASSAT (32B)	700
TIGRA I (F07)	655	FOX	672	PASSAT (362)	701
TIGRA TWINTOP	655	FOX (5Z1)	673	PASSAT (3A2, 35I)	701
VECTRA (B)	655	FOX (5Z1, 5Z3)	673	PASSAT (3B3)	702
VECTRA A (86, 87)	655	GOL	673	PASSAT (3C2)	703
VECTRA B	656	GOL G IV	673	PASSAT ALEMEO	705
VECTRA B (36), SW	656	GOL MI	673	PASSAT ALLTRACK (365)	705
VECTRA C	656	GOLF	673	PASSAT CC (357)	706
VECTRA C, SW	656	GOLF (155)	674	PASSAT VARIANT (32B)	706
VECTRA II (C)	657	GOLF (17)	674	PASSAT VARIANT (33)	707
VECTRA II (C) GTS	658	GOLF / GLX / GTI	674	PASSAT VARIANT (365)	707
VIVARO (E7)	659	GOLF GTI	674	PASSAT VARIANT (3A5, 35I)	707
VIVARO (F7)	660	GOLF II (19E, 1G1)	674	PASSAT VARIANT (3B6)	708
VIVARO (J7)	660	GOLF III	674	PASSAT VARIANT (3C5)	709
VX220	660	GOLF III (1E7)	674	PASSAT VI (3C2, 3C5)	711
ZAFIRA A (F75)	660	GOLF III (1H1)	675	PASSAT VII (357),CC	712
ZAFIRA B	661	GOLF III CABRIOLET (1E7)	675	PASSAT VII (362, 365)	712
ZAFIRA I (A) (F75)	661	GOLF III VARIANT (1H5)	675	PHAETON (3D_)	712
ZAFIRA II (B) (M75)	661	GOLF IV (1J1)	676	POINTER	713
ZAFIRA III (P12)	662	GOLF IV (1J1, 1J5)	679	POLO	713
ZAFIRA MK II (B) (M75)	662	GOLF IV (1J5)	679	POLO (6KV2)	713
ZAFIRA MK III (P12)	662	GOLF PLUS (5M1, 521)	681	POLO (6N1)	713
<b>VAUXHALL LCV</b>		GOLF SERIE III	684	POLO (6N2)	713
ASTRA G VAN (F70)	662	GOLF SPORTSVAN	684	POLO (6NF)	713
ASTRA H VAN	662	GOLF V (1K1)	684	POLO (6R, 6C)	714
ASTRA III VAN	662	GOLF V (1K1, 1K5)	687	POLO (86)	714
ASTRAMAX	662	GOLF V PLUS (1KP)	687	POLO (86C, 80)	714
COMBO I	662	GOLF V VARIANT (1K5)	688	POLO (9A4)	715
COMBO II	662	GOLF VI (517)	689	POLO (9N_)	715
CORSA C VAN (F08, W5L)	662	GOLF VI (5K1)	689	POLO CLASSIC	716
CORSA I VAN	662	GOLF VI (5K1, AJ5)	691	POLO III (6KV2, 6KV5)	716
CORSA VAN II	662	GOLF VI CONVERTIBLE (517)	692	POLO IV (6KV2, 6KV5)	717
MOVANO I (J9)	662	GOLF VI PLUS (5M1)	692	POLO IV (6N2)	717
ZAFIRA VAN	663	GOLF VI VARIANT (AJ5)	692	POLO SEDAN	717
<b>VOLKSWAGEN</b>		GOLF VII (5G1)	693	POLO V (9N)	717
1500,1600	663	GOLF VII (5G1, BE1)	693	POLO VI (6R)	717
A2 (8Z0)	663	GOLF VII (BA5)	694	QUANTUM	717
AMAROK	663	GOLF VII KOMBI (BA5)	694	SANTANA	717
APOLLO	663	GOLF VII (5G1, BA5)	694	SAVEIRO	717
BORA (1J2)	663	ILTIS (183)	694	SCIROCCO (137)	717
BORA (1J2, 1J6) SW	664	JETTA	694	SCIROCCO (53)	718
BORA (1J6)	664	JETTA (16)	694	SCIROCCO (53B)	718
CADDY (14)	666	JETTA II (19E, 1G2, 165)	695	SCIROCCO III (137)	719
CADDY II (9K9A)	667	JETTA III (1K2)	695	SHARAN	719
CADDY II (9K9B)	668	JETTA IV (162)	696	SHARAN (7M8, 7M9, 7M6)	719
		KAEFER	697	SHARAN (7N)	721
		KOMBI	697	SHARAN I (7M8, 7M9, 7M6)	721
		LOAD UP	697	SPACEFOX	721









MAKE-MODEL	PAGE	MAKE-MODEL	PAGE	MAKE-MODEL	PAGE
<b>VOLKSWAGEN</b>		XC60	753		
		XC70 CROSS COUNTRY	754		
SYNCR0	721	XC70 II	754		
TIGUAN (5N_)	721	XC90	754		
TIGUAN I (5N1)	722	<b>ZAZ</b>			
TIGUAN II (5N2)	722	TAVRIA (1102)	754		
TOUAREG (7LA, 7L6, 7L7)	722				
TOUAREG (7P5)	724				
TOUAREG I (7LA, 7L6, 7L7)	724				
TOURAN (1T1, 172)	724				
TOURAN (1T1, 1T2)	724				
TOURAN (1T3)	726				
TRANSPORTER / CARAVELLE III	727				
TRANSPORTER / CARAVELLE IV (70XB, 70XC, 7DB, 7DW)	727				
TRANSPORTER / CARAVELLE MK V (7HB, 7HJ, 7EB, 7EJ, 7EF)	729				
TRANSPORTER / CARAVELLE V (7HB, 7HJ, 7EB, 7EJ, 7EF)	729				
TRANSPORTER II	731				
TRANSPORTER III	731				
TRANSPORTER IV (70XA)	732				
TRANSPORTER IV (70XD)	733				
TRANSPORTER MK V (7HA, 7HH, 7EA, 7EH)	734				
TRANSPORTER MK V (7JD, 7JE, 7JL, 7JY, 7JZ)	734				
TRANSPORTER V (7HA, 7HH, 7EA, 7EH)	734				
TRANSPORTER V (7JD, 7JE, 7JL, 7JY, 7JZ)	736				
TRANSPORTER V 1.9 TDI	738				
TRANSPORTER VI 2.0	738				
UP	738				
VARIANT ALEMAO	738				
VENTO	738				
VENTO (1H2)	738				
<b>VOLKSWAGEN LCV</b>					
CADDY II	739				
CADDY II (9K9)	739				
CADDY III (2KA, 2KB, 2KH, 2KJ)	739				
CADDY IV (2CA, 2CB)	739				
MULTIVAN V (7HM, 7HF)	739				
TRANSPORTER V (7HA/B/H/J, JD/EL)	740				
<b>VOLVO</b>					
440 K (445)	740				
460 L (464)	740				
480 E	740				
C30	740				
C70 I	741				
C70 II	742				
S40	742				
S40 I (VS)	742				
S40 II (MS)	743				
S40I / V40 (VS, VW), SW	743				
S60	743				
S60 II	746				
S80 I (TS, XY)	746				
S80 II (AS)	748				
V40	748				
V40 (VW)	748				
V50 (MW)	749				
V60	750				
V70 II (SW)	750				
V70 III (BW)	753				



		TRANSM	L/R	F/R		G-AP Ref.	PRODUCT	ABS	Technical Specifications									
									YEAR	A	B	C	H	L	P			
<b>ACURA</b>																		
<b>EL</b>																		
-	2001-2005	AT	L			GDS23128	Drive Shaft	50T	26	25	60	78	903					
	2001-2005	AT	R			GDS23127	Drive Shaft	50T	26	25	60	78	606					
	2001-2005	AT	R			GCI23008	Inner Joint		25	30	35	54.5	92					
<b>INTEGRA</b>																		
-	1986-1989					GCI81002	Inner Joint		27	32	40	54	87					
	1990-1993		L		W/O GSR PKG	GDS81052	Drive Shaft	50T	26	27	55	78.5	594					
	1990-1993		R		W/O GSR PKG	GDS81016	Drive Shaft	50T	26	27	55	78.5	596					
2.0	1995-2000					GCO23075	Outer Joint	50T	26	23	55	78.5	56.5	M				
	1995-2000		R			GDS23080	Drive Shaft		26	27	55	78.5	618.5					
	1995-2000		R			GDS23049	Drive Shaft	50T	26	27	55	78.5	618.5					
	1995-2000		L			GDS23050	Drive Shaft	50T	26	27	55	78.5	594					
<b>VIGOR</b>																		
-	1992-1994					GC081004	Outer Joint		28	34	60	93	59	M				
<b>ALFA ROMEO</b>																		
<b>145 / 146 (930)</b>																		
1.3 Le. 8V (66 kW)	1994.10-	1996.11				GCI82001	Inner Joint			24		32						
1.6 i.e. 8V (66 kW)	1994.10-	1996.11				GCI82001	Inner Joint			24		32						
1.7 i.e. 8V (95 kW)	1994.10-	1996.12				GCI82001	Inner Joint			24		32						
1.9 JTD (77 kW)	1999-	2001		L		GCI82007	Inner Joint			34		47.5						
<b>147 (937)</b>																		
1.6 16V T.S. (88 kW)	2001.01-					GC017042	Outer Joint		25	25	51	85	58	O				
1.6 16V T.S. ECO (77 kW)	2001.01-					GC017042	Outer Joint		25	25	51	85	58	O				
1.6 16V T.SPARK (88 kW)	2001.01-	2010.03	5MT		F Hatchback Engine AR32104	GC017042	Outer Joint		25	25	51	85	58	O				
	2001.01-	2010.03			Hatchback Engine AR32104	GDS82009	Drive Shaft		25		51	85	494					
1.6 16V T.SPARK ECO (77 kW)	2001.01-	2010.03			F Hatchback Engine AR37203	GC017042	Outer Joint		25	25	51	85	58	O				
	2001.01-	2010.03			Hatchback Engine AR37203	GDS82009	Drive Shaft		25		51	85	494					
1.9 JTD (74 kW)	2003.06-	2010.03			F Hatchback Engine 182B9.000	GC017042	Outer Joint		25	25	51	85	58	O				
	2003.06-	2010.03			F Hatchback Engine 182B9.000	GCI82005	Inner Joint			25		32						
	2003.06-	2010.03	L	F	Hatchback Engine 182B9.000	GDS17107	Drive Shaft		25	25	59	84	615					
	2003.06-	2010.03	L	F	Hatchback Engine 182B9.000	GCI17005	Inner Joint		25	26	32	91	95					
	2003.06-	2010.03	R	F	Hatchback Engine 182B9.000	GDS82008	Drive Shaft		25	25	51	84.5	931.5					
	2003.06-	2010.03	R	F	Hatchback Engine 182B9.000	GCI17006	Inner Joint		25	26	29.8	377	108					
	2003.06-	2010.03			Hatchback Engine 182B9.000	GDS82009	Drive Shaft		25		51	85	494					
	2003.06-					GC017042	Outer Joint		25	25	51	85	58	O				
1.9 JTD (85 kW)	2001.04-	2010.03			F Hatchback Engine 937A2.000	GC082014	Outer Joint		25	28	51	84.5	64	O				
	2001.04-	2010.03			F Hatchback Engine 937A2.000	GC082025	Outer Joint		25	26	51	84.5	64.5	M				
	2001.04-	2010.03	L	F	Hatchback Engine 937A2.000	GDS17107	Drive Shaft		25	25	59	84	615					
	2001.04-	2010.03	L	F	Hatchback Engine 937A2.000	GCI17005	Inner Joint		25	26	32	91	95					
	2001.04-	2010.03	R	F	Hatchback Engine 937A2.000	GDS82008	Drive Shaft		25	25	51	84.5	931.5					
	2001.04-	2010.03	R	F	Hatchback Engine 937A2.000	GCI17006	Inner Joint		25	26	29.8	377	108					
	2001.04-					GCI82007	Inner Joint			34		47.5						
	2001.04-					GC082014	Outer Joint		25	28	51	84.5	64	O				
	2003.11-		L			GCI17005	Inner Joint		25	26	32	91	95					
	2003.11-		R			GCI17006	Inner Joint		25	26	29.8	377	108					
1.9 JTD 16V (100 kW)	2001.04-	2003.10		L		GCI82007	Inner Joint			34		47.5						
	2001.04-	2003.10				GC082014	Outer Joint		25	28	51	84.5	64	O				
	2004.10-	2010.03	L	F	Hatchback Engine 192B1.000	GDS17107	Drive Shaft		25	25	59	84	615					
	2004.10-	2010.03	L	F	Hatchback Engine 192B1.000	GCI17005	Inner Joint		25	26	32	91	95					
	2004.10-	2010.03	R	F	Hatchback Engine 192B1.000	GDS82008	Drive Shaft		25	25	51	84.5	931.5					
	2004.10-	2010.03	R	F	Hatchback Engine 192B1.000	GCI17006	Inner Joint		25	26	29.8	377	108					
1.9 JTD 16V (103 kW)	2001.04-	2003.10		L		GCI82007	Inner Joint			34		47.5						
	2002-	2003.10				GC082014	Outer Joint		25	28	51	84.5	64	O				
	2003.07-	2005.02			F Hatchback Engine 192A5.000	GC082014	Outer Joint		25	28	51	84.5	64	O				
	2003.07-	2005.02			F Hatchback Engine 192A5.000	GC082025	Outer Joint		25	26	51	84.5	64.5	M				
	2003.07-	2005.02	L	F	Hatchback Engine 192A5.000	GDS17107	Drive Shaft		25	25	59	84	615					
	2003.07-	2005.02	L	F	Hatchback Engine 192A5.000	GCI17005	Inner Joint		25	26	32	91	95					
	2003.07-	2005.02	R	F	Hatchback Engine 192A5.000	GDS82008	Drive Shaft		25	25	51	84.5	931.5					
	2003.07-	2005.02	R	F	Hatchback Engine 192A5.000	GCI17006	Inner Joint		25	26	29.8	377	108					
	2003.11-		L			GCI17005	Inner Joint		25	26	32	91	95					
	2003.11-		R			GCI17006	Inner Joint		25	26	29.8	377	108					

		TRANSM	L/R	F/R		G-AP Ref.	PRODUCT	ABS	Technical Specifications								
									YEAR	A	B	C	H	L	P		
<b>ALFA ROMEO</b>																	
<b>147 (937)</b>																	
1.9 JTD 16V (110 kW)	2007.04-	2010.01			L		GCI17005	Inner Joint	25	26	32	91	95				
	2007.04-	2010.01			R		GCI17006	Inner Joint	25	26	29.8	377	108				
1.9 JTD 16V (125 kW)	2007.04-	2010.01			L		GCI17005	Inner Joint	25	26	32	91	95				
	2007.04-	2010.01			R		GCI17006	Inner Joint	25	26	29.8	377	108				
1.9 JTD 16V (93 kW)	2001.04-	2003.10					GC082014	Outer Joint	25	28	51	84.5	64	O			
	2003.09-	2004.09			F	Hatchback Engine 937A4.000	GC082025	Outer Joint	25	26	51	84.5	64.5	M			
	2003.09-	2004.09			L	F Hatchback Engine 937A4.000	GDS17107	Drive Shaft	25	25	59	84	615				
	2003.09-	2004.09			L	F Hatchback Engine 937A4.000	GCI17005	Inner Joint	25	26	32	91	95				
	2003.09-	2004.09			R	F Hatchback Engine 937A4.000	GDS82008	Drive Shaft	25	25	51	84.5	931.5				
	2003.09-	2004.09			R	F Hatchback Engine 937A4.000	GCI17006	Inner Joint	25	26	29.8	377	108				
	2003.09-	2004.09			L		GCI17005	Inner Joint	25	26	32	91	95				
	2003.09-	2004.09			L		GCI82007	Inner Joint		34		47.5					
1.9 JTD 8V (88 kW)	2005.07-				L		GCI17005	Inner Joint	25	26	32	91	95				
	2005.07-				R		GCI17006	Inner Joint	25	26	29.8	377	108				
1.9 JTDM (85 kW)	2004.10-	2010.03			F	Hatchback Engine 939A7.000	GC082025	Outer Joint	25	26	51	84.5	64.5	M			
	2004.10-	2010.03			L	F Hatchback Engine 939A7.000	GDS17107	Drive Shaft	25	25	59	84	615				
	2004.10-	2010.03			L	F Hatchback Engine 939A7.000	GCI17005	Inner Joint	25	26	32	91	95				
	2004.10-	2010.03			R	F Hatchback Engine 939A7.000	GDS82008	Drive Shaft	25	25	51	84.5	931.5				
	2004.10-	2010.03			R	F Hatchback Engine 939A7.000	GCI17006	Inner Joint	25	26	29.8	377	108				
1.9 JTDM 16V (110 kW)	2005.03-	2007.09			F	Hatchback Engine 937A5.000	GC082025	Outer Joint	25	26	51	84.5	64.5	M			
	2005.03-	2007.09			L	F Hatchback Engine 937A5.000	GDS17107	Drive Shaft	25	25	59	84	615				
	2005.03-	2007.09			L	F Hatchback Engine 937A5.000	GCI17005	Inner Joint	25	26	32	91	95				
	2005.03-	2007.09			R	F Hatchback Engine 937A5.000	GDS82008	Drive Shaft	25	25	51	84.5	931.5				
	2005.03-	2007.09			R	F Hatchback Engine 937A5.000	GCI17006	Inner Joint	25	26	29.8	377	108				
1.9 JTDM 16V (125 kW)	2008.06-	2010.03			L	F Hatchback Engine 937A6.000	GDS17107	Drive Shaft	25	25	59	84	615				
	2008.06-	2010.03			L	F Hatchback Engine 937A6.000	GCI17005	Inner Joint	25	26	32	91	95				
	2008.06-	2010.03			R	F Hatchback Engine 937A6.000	GDS82008	Drive Shaft	25	25	51	84.5	931.5				
	2008.06-	2010.03			R	F Hatchback Engine 937A6.000	GCI17006	Inner Joint	25	26	29.8	377	108				
1.9 JTDM 8V (88 kW)	2006.02-	2010.03			F	Hatchback Engine 937A3.000	GC082025	Outer Joint	25	26	51	84.5	64.5	M			
	2006.02-	2010.03			L	F Hatchback Engine 937A3.000	GDS17107	Drive Shaft	25	25	59	84	615				
	2006.02-	2010.03			L	F Hatchback Engine 937A3.000	GCI17005	Inner Joint	25	26	32	91	95				
	2006.02-	2010.03			R	F Hatchback Engine 937A3.000	GDS82008	Drive Shaft	25	25	51	84.5	931.5				
	2006.02-	2010.03			R	F Hatchback Engine 937A3.000	GCI17006	Inner Joint	25	26	29.8	377	108				
2.0 16V T.S. (110 kW)	2001.01-						GC017042	Outer Joint	25	25	51	85	58	O			
2.0 16V T.SPARK (110 kW)	2001.01-	2010.03	MT/AT		F	Hatchback Engine AR32310	GC017042	Outer Joint	25	25	51	85	58	O			
	2001.01-	2010.03				Hatchback Engine AR32310	GDS82009	Drive Shaft	25		51	85	494				
3.2 GTA (184 kW)	2003.02-						GC099298	Outer Joint	27	26	59	84.5	63	M			
<b>155 (167)</b>																	
1.7 T.S. (83 kW)	1993.04-	1996.04	MT		F	Saloon Engine AR67103	GCI48004	Inner Joint		25		32					
1.7 T.S. (85 kW)	1993.04-	1996.04	MT		F	Saloon Engine AR67105	GCI48004	Inner Joint		25		32					
1.8 T.S. (77 kW)	1992.02-	1997.12	MT		F	Saloon Engine AR67402	GCI48004	Inner Joint		25		32					
1.8 T.S. (95 kW)	1992.02-	1993.06	MT		F	Saloon Engine AR67101	GCI48004	Inner Joint		25		32					
1.8 T.S. Sport (93 kW)	1992.01-	1996.12	MT		F	Saloon Engine AR67101/AR67102	GCI48004	Inner Joint		25		32					
1.9 TD (66 kW)	1993.04-	1997.12	MT		F	Saloon Engine AR67501	GCI48004	Inner Joint		25		32					
2.0 16V Turbo Q4 (137 kW)	1992.01-	1997.12	MT		F	Saloon Engine AR67203	GCI48004	Inner Joint		25		32					
2.0 16V Turbo Q4 (140 kW)	1992.01-	1997.12	MT		F	Saloon Engine AR67203	GCI48004	Inner Joint		25		32					
2.0 T.S. (104 kW)	1992.02-	1995.02	MT		F	Saloon Engine AR67202	GCI48004	Inner Joint		25		32					
2.0 T.S. (106 kW)	1992.02-	1993.04	MT		F	Saloon Engine AR67201	GCI48004	Inner Joint		25		32					
2.0 T.S. 16V (110 kW)	1995.03-	1997.12	MT		F	Saloon Engine AR67204	GCI48004	Inner Joint		25		32					
2.5 TD (92 kW)	1993.04-	1997.12	MT		F	Saloon Engine VM07B/VM31B	GC082019	Outer Joint	25	28	56	85	63.5	O			
2.5 V6 (120 kW)	1992.10-	1997.12	MT		F	Saloon Engine AR67302/AR67303	GCI48004	Inner Joint		25		32					
2.5 V6 (121 kW)	1992.02-	1996.09	MT		F	Saloon Engine AR67301	GCI48004	Inner Joint		25		32					
<b>156 (932)</b>																	
1.6 16V T.SPARK (88 kW)	1997.09-	2005.09	5MT		F	Saloon Engine AR32104/AR67601	GCI82005	Inner Joint		25		32					
	1997.09-	2005.09	MT		F	Saloon Engine AR32104/AR67601	GC082017	Outer Joint	25	25	58.8	85	58.3	O			
	1997.09-	2005.09	MT		F	Saloon Engine AR32104/AR67601	GDS17159	Drive Shaft	25		58.8	85	490				
1.6 16V T.SPARK. (88 kW)	2000.05-	2006.05	5MT		F	Estate Engine AR32104/AR67601	GCI82005	Inner Joint		25		32					
	2000.05-	2006.05	MT		F	Estate Engine AR32104/AR67601	GDS17159	Drive Shaft	25		58.8	85	490				
1.8 16V T.SPARK (103 kW)	2000.10-	2005.09			F	Saloon Engine AR32205	GCI82005	Inner Joint		25		32					
	2000.10-	2005.09	MT		F	Saloon Engine AR32205	GDS17159	Drive Shaft	25		58.8	85	490				
	2000.10-	2006.05			F	Estate Engine AR32205	GCI82005	Inner Joint		25		32					









		TRANSM	L/R	F/R		G-AP Ref.	PRODUCT	ABS	Technical Specifications									
									YEAR	A	B	C	H	L	P			
<b>ALFA ROMEO</b>																		
<b>156 (932)</b>																		
1.8 16V T.SPARK (103 kW)	2000.10-	2006.05	MT		F	Estate Engine AR32205	GDS17159	Drive Shaft	25		58.8	85	490					
1.8 16V T.SPARK (106 kW)	2000.06-	2005.02	5MT		F	Estate Engine AR32201	GCI82005	Inner Joint		25		32						
	2000.06-	2005.02	MT		F	Estate Engine AR32201	GDS17159	Drive Shaft	25		58.8	85	490					
1.9 JTD (110 kW)	2004.07-	2005.09			F	Saloon Engine 937A5.000	GCI82005	Inner Joint		25		32						
1.9 JTD (81 kW)	2000.10-	2001.05	MT	L	F	Estate Engine AR37101	GCI82007	Inner Joint		34		47.5						
	2000.10-	2001.05	MT	L	F	Saloon Engine AR37101	GCI82007	Inner Joint		34		47.5						
1.9 JTD (85 kW)	2001.05-	2005.09	MT		F	Saloon Engine 937A2.000	GC082012	Outer Joint	25	28	59	85	63	O				
	2001.05-	2005.09	MT	L	F	Saloon Engine 937A2.000	GCI82007	Inner Joint		34		47.5						
	2001.05-	2005.09	MT	L	F	Saloon Engine 937A2.000	GDS82001	Drive Shaft	25		59	85	520					
	2001.05-	2005.09	MT	L	F	Saloon Engine 937A2.000	GDS82003	Drive Shaft	25	26.65	59	84	502					
	2001.05-	2005.09	MT	R	F	Saloon Engine 937A2.000	GDS82002	Drive Shaft	25		59	85	521					
	2001.05-	2005.09	MT	R	F	Saloon Engine 937A2.000	GDS82004	Drive Shaft	25	26.65	59	84	521					
	2001.05-	2006.05	MT		F	Estate Engine 937A2.000	GC082012	Outer Joint	25	28	59	85	63	O				
	2001.05-	2006.05	MT	L	F	Estate Engine 937A2.000	GCI82007	Inner Joint		34		47.5						
	2001.05-	2006.05	MT	L	F	Estate Engine 937A2.000	GDS82001	Drive Shaft	25		59	85	520					
	2001.05-	2006.05	MT	L	F	Estate Engine 937A2.000	GDS82003	Drive Shaft	25	26.65	59	84	502					
	2001.05-	2006.05	MT	R	F	Estate Engine 937A2.000	GDS82002	Drive Shaft	25		59	85	521					
	2001.05-	2006.05	MT	R	F	Estate Engine 937A2.000	GDS82004	Drive Shaft	25	26.65	59	84	521					
1.9 JTD 16V (103 kW)	2002.11-	2005.09	MT	L	F	Saloon Engine 192A5.000	GDS82003	Drive Shaft	25	26.65	59	84	502					
	2002.11-	2005.09	MT	R	F	Saloon Engine 192A5.000	GDS82004	Drive Shaft	25	26.65	59	84	521					
	2002.11-	2006.05	MT	L	F	Estate Engine 192A5.000	GDS82003	Drive Shaft	25	26.65	59	84	502					
	2002.11-	2006.05	MT	R	F	Estate Engine 192A5.000	GDS82004	Drive Shaft	25	26.65	59	84	521					
1.9 JTD 16V Q4 (110 kW)	2004.07-	2006.05				Estate Engine 937A5.000	GCI82005	Inner Joint		25		32						
	2004.07-	2006.05		L	F	Estate Engine 937A5.000	GDS82003	Drive Shaft	25	26.65	59	84	502					
	2004.07-	2006.05		R	F	Estate Engine 937A5.000	GDS82004	Drive Shaft	25	26.65	59	84	521					
	2004.07-	2006.05		R	F	Estate Engine 937A5.000	GDS82008	Drive Shaft	25	25	51	84.5	931.5					
	2004.07-	2006.05		R	F	Estate Engine 937A5.000	GCI17006	Inner Joint	25	26	29.8	377	108					
2.0 (119 kW)	2002.03-	2006.05	MT		F	Estate Engine 932A2.000	GDS17159	Drive Shaft	25		58.8	85	490					
2.0 16V T.SPARK (110 kW)	2000.10-	2002.03			F	Estate Engine AR32310	GCI82005	Inner Joint		25		32						
	2000.10-	2002.03			F	Saloon Engine AR32310	GCI82005	Inner Joint		25		32						
	2000.10-	2002.03	MT		F	Estate Engine AR32310	GDS17159	Drive Shaft	25		58.8	85	490					
	2000.10-	2002.03	MT		F	Saloon Engine AR32310	GDS17159	Drive Shaft	25		58.8	85	490					
2.0 16V T.SPARK (114 kW)	2000.05-	2002.06			F	Estate Engine AR32301	GCI82005	Inner Joint		25		32						
	2000.05-	2002.06	MT		F	Estate Engine AR32301	GDS17159	Drive Shaft	25		58.8	85	490					
2.0 JTS (122 kW)	2002.03-	2005.09			F	Saloon Engine 937A1.000	GC017042	Outer Joint	25	25	51	85	58	O				
	2002.03-	2005.09			F	Saloon Engine 937A1.000	GCI82005	Inner Joint		25		32						
	2002.03-	2005.09	MT		F	Saloon Engine 937A1.000	GDS17159	Drive Shaft	25		58.8	85	490					
	2002.03-	2006.05			F	Estate Engine 937A1.000	GC017042	Outer Joint	25	25	51	85	58	O				
	2002.03-	2006.05			F	Estate Engine 937A1.000	GCI82005	Inner Joint		25		32						
	2002.03-	2006.05	MT		F	Estate Engine 937A1.000	GDS17159	Drive Shaft	25		58.8	85	490					
2.4 JTD (100 kW)	1997.09-	2003.09	MT		F	Saloon Engine AR32501	GC082012	Outer Joint	25	28	59	85	63	O				
	2000.05-	2003.09	MT		F	Estate Engine AR32501	GC082012	Outer Joint	25	28	59	85	63	O				
2.4 JTD (110 kW)	2002.03-	2006.05	MT	L	F	Estate Engine 841C000	GDS17117	Drive Shaft	25	27	59	84	550					
	2002.03-	2006.05	MT	R	F	Estate Engine 841C000	GDS17110	Drive Shaft	25	27	59	84	1000					
2.4 JTD (120 kW)	2003.06-	2005.09		L	F	Saloon Engine 841M.000/841N.000	GDS17117	Drive Shaft	25	27	59	84	550					
	2003.06-	2005.09		R	F	Saloon Engine 841M.000/841N.000	GDS17110	Drive Shaft	25	27	59	84	1000					
	2003.06-	2006.05	MT	L	F	Estate Engine 841M.000/841N.000	GDS17117	Drive Shaft	25	27	59	84	550					
	2003.06-	2006.05	MT	R	F	Estate Engine 841M.000/841N.000	GDS17110	Drive Shaft	25	27	59	84	1000					
2.4 JTD (129 kW)	2003.10-	2005.09		L	F	Saloon Engine 841G.000	GDS17117	Drive Shaft	25	27	59	84	550					
	2003.10-	2005.09		R	F	Saloon Engine 841G.000	GDS17110	Drive Shaft	25	27	59	84	1000					
	2003.10-	2006.05		L	F	Estate Engine 841G.000	GDS17117	Drive Shaft	25	27	59	84	550					
	2003.10-	2006.05		R	F	Estate Engine 841G.000	GDS17110	Drive Shaft	25	27	59	84	1000					
2.5 V6 24V (140 kW)	2000.05-	2003.08			F	Estate Engine AR32401	GCI82005	Inner Joint		25		32						
	2000.05-	2003.08	MT		F	Estate Engine AR32401	GC082012	Outer Joint	25	28	59	85	63	O				
2.5 V6 24V (141 kW)	2000.10-	2005.09			F	Saloon Engine AR32405	GCI82005	Inner Joint		25		32						
	2000.10-	2006.05			F	Estate Engine AR32405	GCI82005	Inner Joint		25		32						
<b>156 SPORTWAGON (932)</b>																		
1.6 16V T.S. (88 kW)	2000.05-	2006.05					GC082008	Outer Joint	25	25	59	85	58	O				
1.8 16V T.S. (103 kW)	2000.10-	2006.05					GC082008	Outer Joint	25	25	59	85	58	O				
1.8 16V T.S. (106 kW)	2000.05-	2000.10					GC082008	Outer Joint	25	25	59	85	58	O				
1.9 JTD (77 kW)	2000.05-	2000.10		L			GCI82007	Inner Joint		34		47.5						
	2000.05-	2000.10					GC082012	Outer Joint	25	28	59	85	63	O				



		TRANSM	L/R	F/R		G-AP Ref.	PRODUCT	ABS	Technical Specifications							
									YEAR	A	B	C	H	L	P	
<b>ALFA ROMEO</b>																
<b>156 SPORTWAGON (932)</b>																
1.9 JTD (81 kW)	2000.10-	2001.05				GCI82007	Inner Joint		34		47.5					
	2000.10-	2001.05				GC082012	Outer Joint	25	28	59	85	63	O			
1.9 JTD (85 kW)	2001.05-	2006.05				GCI82007	Inner Joint		34		47.5					
	2001.05-	2006.05				GC082012	Outer Joint	25	28	59	85	63	O			
1.9 JTD 16V (103 kW)	2002.11-	2006.05				GCI17005	Inner Joint	25	26	32	91	95				
	2002.11-	2006.05				GCI82007	Inner Joint		34		47.5					
	2002.11-	2006.05				GCI17006	Inner Joint	25	26	29.8	377	108				
	2002.11-	2006.05				GC017009	Outer Joint	25	26	59	84	63	M			
	2002.11-	2006.05				GC082012	Outer Joint	25	28	59	85	63	O			
1.9 JTD 16V Q4 (110 kW)	2004.07-	2006.05				GC017009	Outer Joint	25	26	59	84	63	M			
2.0 16V T.S. (110 kW)	2000.10-	2002.03				GC082008	Outer Joint	25	25	59	85	58	O			
2.0 16V T.S. (114 kW)	2000.05-	2000.10				GC082008	Outer Joint	25	25	59	85	58	O			
2.0 JTS (122 kW)	2002.03-	2006.05				GC017042	Outer Joint	25	25	51	85	58	O			
2.4 JTD (100 kW)	2000.05-	2000.10				GC082012	Outer Joint	25	28	59	85	63	O			
	2000.05-	2006.05				GCI82007	Inner Joint		34		47.5					
2.4 JTD (103 kW)	2000.05-	2006.05				GCI82007	Inner Joint		34		47.5					
	2000.10-	2006.05				GC082012	Outer Joint	25	28	59	85	63	O			
2.4 JTD (110 kW)	2000.05-	2006.05				GCI82007	Inner Joint		34		47.5					
	2002.03-	2006.05				GC082012	Outer Joint	25	28	59	85	63	O			
2.4 JTD (120 kW)	2003.10-	2006.05				GCI21016	Inner Joint	27	26	35	78.5	112				
2.4 JTD (129 kW)	2003.10-	2006.05				GCI21016	Inner Joint	27	26	35	78.5	112				
	2003.10-	2006.05				GC017009	Outer Joint	25	26	59	84	63	M			
2.5 V6 24V (140 kW)	2000.05-	2000.10				GC082012	Outer Joint	25	28	59	85	63	O			
2.5 V6 24V (141 kW)	2000.10-	2006.05				GC082012	Outer Joint	25	28	59	85	63	O			
3.2 GTA (184 kW)	2000.10-	2006.05				GC099298	Outer Joint	27	26	59	84.5	63	M			
<b>159 (939)</b>																
1.8 JTS TBI (147 kW)	2008.05-					GC082024	Outer Joint	30	27	61	93	65	M			
1.8 MPI (103 kW)	2005.03-					GCI82014	Inner Joint	22	24	34.95	57.5	111				
	2005.03-					GCI17055	Inner Joint	22	24	34.9	378.5	106.5				
	2005.03-					GC082026	Outer Joint	30	24	61	93	58	M			
	2007.03-	2011.11			F	Estate Engine 939A4.000	GC082026	Outer Joint	30	24	61	93	58	M		
	2007.03-	2011.11			F	Saloon Engine 939A4.000	GC082026	Outer Joint	30	24	61	93	58	M		
1.8 MPI (121 kW)	2005.03-					GCI82014	Inner Joint	22	24	34.95	57.5	111				
	2005.03-					GCI17055	Inner Joint	22	24	34.9	378.5	106.5				
	2005.03-					GC082026	Outer Joint	30	24	61	93	58	M			
1.8 MPI (147 kW)	2005.03-					GCI82014	Inner Joint	22	24	34.95	57.5	111				
	2005.03-					GCI17055	Inner Joint	22	24	34.9	378.5	106.5				
	2005.03-					GC082026	Outer Joint	30	24	61	93	58	M			
1.8 MPI (96 kW)	2005.03-					GCI82014	Inner Joint	22	24	34.95	57.5	111				
	2005.03-					GCI17055	Inner Joint	22	24	34.9	378.5	106.5				
	2005.03-					GC082026	Outer Joint	30	24	61	93	58	M			
1.8 TBi (147 kW)	2009.05-	2011.11			F	Estate Engine 939B1.000	GC082026	Outer Joint	30	24	61	93	58	M		
	2009.05-	2011.11			F	Saloon Engine 939B1.000	GC082026	Outer Joint	30	24	61	93	58	M		
1.9 JTDM 16V (100 kW)	2005.09-	2011.11			F	Saloon Engine 937A8.000/939A8.000	GC082023	Outer Joint	30	26	61	94	63.5	M		
	2005.09-	2011.11			L	F Saloon Engine 937A8.000/939A8.000	GDS17122	Drive Shaft	30	25	61	94	640			
	2005.09-	2011.11			L	F Saloon Engine 937A8.000/939A8.000	GCI17035	Inner Joint	25	26	34.9	57.5	114.5			
	2005.09-	2011.11			R	F Saloon Engine 937A8.000/939A8.000	GDS17124	Drive Shaft	30	25	61	94	1015			
	2005.09-	2011.11			R	F Saloon Engine 937A8.000/939A8.000	GCI82010	Inner Joint	25	26	34.9	439.5	108.5			
	2005.09-				L		GCI82009	Inner Joint	25	26	34.9	57.5	114.5			
	2005.09-				R		GCI82010	Inner Joint	25	26	34.9	439.5	108.5			
	2005.09-						GC082023	Outer Joint	30	26	61	94	63.5	M		
	2006.03-	2011.11			F	Estate Engine 937A8.000	GC082023	Outer Joint	30	26	61	94	63.5	M		
	2006.03-	2011.11			L	F Estate Engine 937A8.000	GDS17122	Drive Shaft	30	25	61	94	640			
	2006.03-	2011.11			L	F Estate Engine 937A8.000	GCI17035	Inner Joint	25	26	34.9	57.5	114.5			
1.9 JTDM 16V (110 kW)	2005.09-	2011.11			R	F Estate Engine 937A8.000	GDS17124	Drive Shaft	30	25	61	94	1015			
	2006.03-	2011.11			R	F Estate Engine 937A8.000	GCI82010	Inner Joint	25	26	34.9	439.5	108.5			
	2005.09-	2011.11			F	Saloon Engine 939A2.000	GC082023	Outer Joint	30	26	61	94	63.5	M		
	2005.09-	2011.11			L	F Saloon Engine 939A2.000	GDS17122	Drive Shaft	30	25	61	94	640			
	2005.09-	2011.11			L	F Saloon Engine 939A2.000	GCI17035	Inner Joint	25	26	34.9	57.5	114.5			
1.9 JTDM 16V (110 kW)	2005.09-	2011.11			R	F Saloon Engine 939A2.000	GDS17124	Drive Shaft	30	25	61	94	1015			
	2005.09-	2011.11			R	F Saloon Engine 939A2.000	GCI82010	Inner Joint	25	26	34.9	439.5	108.5			
	2005.09-				L		GCI82009	Inner Joint	25	26	34.9	57.5	114.5			

		TRANSM	L/R	F/R		G-AP Ref.	PRODUCT	ABS	Technical Specifications									
									YEAR	A	B	C	H	L	P			
<b>ALFA ROMEO</b>																		
<b>159 (939)</b>																		
1.9 JTDM 16V (110 kW)	2005.09-																	
	2005.09-						R											
	2005.09-																	
	2006.06-	2011.11				F	Estate Engine 939A2.000											
	2006.06-	2011.11			L	F	Estate Engine 939A2.000											
	2006.06-	2011.11			L	F	Estate Engine 939A2.000											
	2006.06-	2011.11			R	F	Estate Engine 939A2.000											
1.9 JTDM 8V (88 kW)	2005.09-	2011.11			F	Saloon Engine 939.A1.000												
	2005.09-	2011.11			L	F	Saloon Engine 939.A1.000											
	2005.09-	2011.11			L	F	Saloon Engine 939.A1.000											
	2005.09-	2011.11			R	F	Saloon Engine 939.A1.000											
	2005.09-	2011.11			R	F	Saloon Engine 939.A1.000											
	2005.09-				L													
	2005.09-				R													
	2005.09-																	
	2006.03-	2011.11			F	Estate Engine 939A1.000												
	2006.03-	2011.11			L	F	Estate Engine 939A1.000											
	2006.03-	2011.11			L	F	Estate Engine 939A1.000											
	2006.03-	2011.11			R	F	Estate Engine 939A1.000											
	2006.03-	2011.11			R	F	Estate Engine 939A1.000											
	1.9 JTS (118 kW)	2005.09-	2011.11			F	Saloon Engine 939A6.000											
		2006.06-	2011.11			F	Estate Engine 939A6.000											
	2.0 JTD (100 kW)	2008-																
2010-					L													
2010-					R													
2.0 JTDM (120 kW)	2009.05-	2011.11	MT	L	F	Saloon Engine 844A2.000												
	2009.05-	2011.11	MT	L	F	Saloon Engine 844A2.000												
	2009.05-	2011.11		L	F	Estate Engine 844A2.000												
	2009.05-	2011.11		L	F	Estate Engine 844A2.000												
	2009.05-	2011.11	MT	R	F	Saloon Engine 844A2.000												
	2009.05-	2011.11		R	F	Estate Engine 844A2.000												
2.0 JTDM (125 kW)	2009.05-	2011.11			F	Estate Engine 939B3.000												
	2009.05-	2011.11			F	Saloon Engine 939B3.000												
	2009.05-	2011.11		L	F	Estate Engine 939B3.000												
	2009.05-	2011.11		L	F	Saloon Engine 939B3.000												
	2009.05-	2011.11		L	F	Saloon Engine 939B3.000												
	2009.05-	2011.11		R	F	Estate Engine 939B3.000												
	2009.05-	2011.11		R	F	Saloon Engine 939B3.000												
	2009.05-			L		G. Box: 6 Sp												
	2009.05-																	
	2.2 JTS (136 kW)	2005.09-	2011.11			F	Saloon Engine 939A5.000											
2005.09-		2011.11		L	F	Saloon Engine 939A5.000												
2005.09-		2011.11		L	F	Saloon Engine 939A5.000												
2005.09-		2011.11		R	F	Saloon Engine 939A5.000												
2005.09-		2011.11		R	F	Saloon Engine 939A5.000												
2005.09-				L														
2005.09-				R														
2005.09-																		
2006.06-		2011.11			F	Estate Engine 939A5.000												
2006.06-		2011.11		L	F	Estate Engine 939A5.000												
2006.06-		2011.11		L	F	Estate Engine 939A5.000												
2006.06-		2011.11	MT	R	F	Estate Engine 939A5.000												
2006.06-		2011.11	MT	R	F	Estate Engine 939A5.000												
2.4 JTDM (147 kW)		2005.09-	2011.11			F	Saloon Engine 939A3.000											
	2005.09-	2011.11	MT	L	F	Saloon Engine 939A3.000												
	2005.09-	2011.11	MT	L	F	Saloon Engine 939A3.000												
	2005.09-	2011.11	MT	R	F	Saloon Engine 939A3.000												
	2006.06-	2011.11			F	Estate Engine 939A3.000												
	2006.06-	2011.11	MT	L	F	Estate Engine 939A3.000												
	2006.06-	2011.11	MT	L	F	Estate Engine 939A3.000												
	2006.06-	2011.11	MT	R	F	Estate Engine 939A3.000												









		YEAR	TRANSM	L/R	F/R		G-AP Ref.	PRODUCT	ABS	Technical Specifications						
										A	B	C	H	L	P	
<b>ALFA ROMEO</b>																
<b>159 (939)</b>																
2.4 JTDM (154 kW)	2007.05-	2011.11			F	Estate Engine 939A9.000	GC082024	Outer Joint		30	27	61	93	65	M	
	2007.05-	2011.11			F	Saloon Engine 939A9.000	GC082024	Outer Joint		30	27	61	93	65	M	
	2007.05-	2011.11	MT	L	F	Estate Engine 939A9.000	GDS17123	Drive Shaft		30	27	61	93	598		
	2007.05-	2011.11	MT	L	F	Estate Engine 939A9.000	GCI21017	Inner Joint		27	27	35	78.5	112		
	2007.05-	2011.11	MT	L	F	Saloon Engine 939A9.000	GDS17123	Drive Shaft		30	27	61	93	598		
	2007.05-	2011.11	MT	L	F	Saloon Engine 939A9.000	GCI21017	Inner Joint		27	27	35	78.5	112		
	2007.05-	2011.11	MT	R	F	Estate Engine 939A9.000	GDS17145	Drive Shaft		30	27	61	93	1059		
	2007.05-	2011.11	MT	R	F	Saloon Engine 939A9.000	GDS17145	Drive Shaft		30	27	61	93	1059		
2.4 JTDM 20V 4x2 (147 kW)	2005.09-		MT/AT	L			GCI21017	Inner Joint		27	27	35	78.5	112		
	2005.09-		MT/AT	R			GCI17008	Inner Joint		27	27	35	498	108.5		
	2005.09-		MT/AT				GC082024	Outer Joint		30	27	61	93	65	M	
2.4 JTDM 20V 4x2 (154 kW)	2005.09-		MT/AT				GC082024	Outer Joint		30	27	61	93	65	M	
	2007.05-			L			GCI21017	Inner Joint		27	27	35	78.5	112		
	2007.05-			R			GCI17008	Inner Joint		27	27	35	498	108.5		
2.4 JTDM Q4 (154 kW)	2007.05-	2011.11				Estate Engine 939A9.000	GC082024	Outer Joint		30	27	61	93	65	M	
	2007.05-	2011.11				Saloon Engine 939A9.000	GC082024	Outer Joint		30	27	61	93	65	M	
	2007.05-	2011.11	MT	L	F	Estate Engine 939A9.000	GDS17123	Drive Shaft		30	27	61	93	598		
	2007.05-	2011.11	MT	L	F	Estate Engine 939A9.000	GCI21017	Inner Joint		27	27	35	78.5	112		
	2007.05-	2011.11	MT	L	F	Saloon Engine 939A9.000	GDS17123	Drive Shaft		30	27	61	93	598		
	2007.05-	2011.11	MT	L	F	Saloon Engine 939A9.000	GCI21017	Inner Joint		27	27	35	78.5	112		
	2007.05-	2011.11	MT	R	F	Estate Engine 939A9.000	GDS17145	Drive Shaft		30	27	61	93	1059		
	2007.05-	2011.11	MT	R	F	Saloon Engine 939A9.000	GDS17145	Drive Shaft		30	27	61	93	1059		
	2007.05-			L			GCI21016	Inner Joint		27	26	35	78.5	112		
2007.05-						GC082023	Outer Joint		30	26	61	94	63.5	M		
2.4 JTDM,Q4 (154)	2007.05-			R			GCI17007	Inner Joint		27	26	35	453	108.5		
3.2 JTS (191 kW)	2005-			L			GCI21017	Inner Joint		27	27	35	78.5	112		
	2005-						GC082024	Outer Joint		30	27	61	93	65	M	
	2008.02-	2011.11			F	Estate Engine 939A.000	GC082023	Outer Joint		30	26	61	94	63.5	M	
	2008.02-	2011.11			F	Saloon Engine 939A.000	GC082023	Outer Joint		30	26	61	94	63.5	M	
3.2 JTS (195 kW)	2005-			L			GCI21017	Inner Joint		27	27	35	78.5	112		
	2005-						GC082024	Outer Joint		30	27	61	93	65	M	
3.2 JTS Q4 (191 kW)	2005.12-	2008		L			GCI21016	Inner Joint		27	26	35	78.5	112		
	2005.12-	2008					GC082023	Outer Joint		30	26	61	94	63.5	M	
	2006.01-	2011.11				Saloon Engine 939A.000	GC082023	Outer Joint		30	26	61	94	63.5	M	
	2006.06-	2011.11				Estate Engine 939A.000	GC082023	Outer Joint		30	26	61	94	63.5	M	
3.2 JTS Q4 (191)	2005.12-	2008		R			GCI17007	Inner Joint		27	26	35	453	108.5		
<b>159 SPORTWAGON (939)</b>																
1.8 JTS TBI (147 kW)	2008.05-						GC082024	Outer Joint		30	27	61	93	65	M	
1.8 MPI (103 kW)	2005.03-			L			GCI82014	Inner Joint		22	24	34.95	57.5	111		
	2005.03-			R			GCI17055	Inner Joint		22	24	34.9	378.5	106.5		
	2005.03-						GC082026	Outer Joint		30	24	61	93	58	M	
1.9 JTDM 16V (100 kW)	2006.03-			L			GCI82009	Inner Joint		25	26	34.9	57.5	114.5		
	2006.03-			R			GCI82010	Inner Joint		25	26	34.9	439.5	108.5		
	2006.03-						GC082023	Outer Joint		30	26	61	94	63.5	M	
1.9 JTDM 16V (110 kW)	2006.03-			L			GCI82009	Inner Joint		25	26	34.9	57.5	114.5		
	2006.03-			R			GCI82010	Inner Joint		25	26	34.9	439.5	108.5		
	2006.03-						GC082023	Outer Joint		30	26	61	94	63.5	M	
1.9 JTDM 8V (88 kW)	2006.03-			L			GCI82009	Inner Joint		25	26	34.9	57.5	114.5		
	2006.03-			R			GCI82010	Inner Joint		25	26	34.9	439.5	108.5		
	2006.03-						GC082023	Outer Joint		30	26	61	94	63.5	M	
1.9 JTS (118 kW)	2006.03-					GC082026	Outer Joint		30	24	61	93	58	M		
2.0 JTD (100 kW)	2010-			L			GCI17031	Inner Joint		25	26	32	59	110.5		
	2010-			R			GCI17075	Inner Joint		25	26	29.75	440	108.5		
	2010-						GC082023	Outer Joint		30	26	61	94	63.5	M	
2.0 JTD (125 kW)	2009.05-						GC082024	Outer Joint		30	27	61	93	65	M	
2.0 JTDM (125 kW)	2009.05-			L		G. Box: 6 Sp	GCI21017	Inner Joint		27	27	35	78.5	112		
2.2 JTS (136 kW)	2006.03-			L			GCI82009	Inner Joint		25	26	34.9	57.5	114.5		
	2006.03-			R			GCI82010	Inner Joint		25	26	34.9	439.5	108.5		
	2006.03-						GC082023	Outer Joint		30	26	61	94	63.5	M	
2.4 JTDM 20V 4x2 (147 kW)	2006.03-	2007.05					GC082024	Outer Joint		30	27	61	93	65	M	
	2006.03-			L		G. Box: 6 Sp	GCI21017	Inner Joint		27	27	35	78.5	112		
	2006.03-			R		G. Box: 6 Sp	GCI17008	Inner Joint		27	27	35	498	108.5		



		TRANSM	L/R	F/R		G-AP Ref.	PRODUCT	ABS	Technical Specifications								
									YEAR	A	B	C	H	L	P		
<b>ALFA ROMEO</b>																	
<b>159 SPORTWAGON (939)</b>																	
2.4 JTDM 20V 4x2 (154 kW)	2006.03-	2007.05				GC082024	Outer Joint		30	27	61	93	65	M			
	2007.05-			L	G. Box: 6 Sp	GCI21017	Inner Joint		27	27	35	78.5	112				
	2007.05-			R	G. Box: 6 Sp	GCI17008	Inner Joint		27	27	35	498	108.5				
2.4 JTDM Q4 (154 kW)	2007.05-			L		GCI21016	Inner Joint		27	26	35	78.5	112				
	2007.05-					GC082023	Outer Joint		30	26	61	94	63.5	M			
2.4 JTDM,Q4 (154)	2007.05-			R		GCI17007	Inner Joint		27	26	35	453	108.5				
3.2 JTS (191 kW)	2008.02-			L		GCI21017	Inner Joint		27	27	35	78.5	112				
	2008.02-					GC082024	Outer Joint		30	27	61	93	65	M			
3.2 JTS (195 kW)	2008.02-			L		GCI21017	Inner Joint		27	27	35	78.5	112				
	2008.02-					GC082024	Outer Joint		30	27	61	93	65	M			
3.2 JTS Q4 (191 kW)	2006.03-			L		GCI21016	Inner Joint		27	26	35	78.5	112				
	2006.03-					GC082023	Outer Joint		30	26	61	94	63.5	M			
3.2 JTS Q4 (191)	2006.03-			R		GCI17007	Inner Joint		27	26	35	453	108.5				
<b>164 (164)</b>																	
2.0 (102 kW)	1987.06-	1998.09	MT		F Saloon Engine AR06416	GCI48004	Inner Joint				25		32				
2.0 T.S. (105 kW)	1987.06-	1992.09	MT		F Saloon Engine AR06416	GCI48004	Inner Joint				25		32				
2.0 T.S. (106 kW)	1992.09-	1998.09	MT		F Saloon Engine AR64103	GCI48004	Inner Joint				25		32				
2.0 T.S. (109 kW)	1987.06-	1990.12	MT		F Saloon Engine AR06420	GCI48004	Inner Joint				25		32				
2.0 Turbo (128 kW)	1987.10-	1998.09	MT		F Saloon Engine AR06476	GCI48004	Inner Joint				25		32				
2.0 V6 Turbo (148 kW)	1992.09-	1998.09	MT		F Saloon Engine AR64102	GCI82004	Inner Joint				28		32				
2.0 V6 Turbo (150 kW)	1991.03-	1992.09	MT		F Saloon Engine AR64101	GCI82004	Inner Joint				28		32				
2.5 TD (84 kW)	1987.06-	1992.09	MT		F Saloon Engine VM84A	GCI82004	Inner Joint				28		32				
2.5 TD (92 kW)	1992.09-	1998.09	MT/AT		F Saloon Engine VM08B/VM32B	GCI82004	Inner Joint				28		32				
3.0 24V Q4 (170 kW)	1994.02-	1998.09	MT		F Saloon Engine AR64307/AR64308	GCI82004	Inner Joint				28		32				
3.0 V6 (132 kW)	1992.09-	1998.09	MT/AT		F Saloon Engine AR64305/AR66303	GCI82004	Inner Joint				28		32				
3.0 V6 (135 kW)	1987.06-	1992.09	MT/AT		F Saloon Engine AR06412	GCI82004	Inner Joint				28		32				
3.0 V6 (141 kW)	1987.06-	1992.09	MT/AT		F Saloon Engine AR06410	GCI82004	Inner Joint				28		32				
<b>166 (936)</b>																	
2.0 T.S. (110 kW)	2000.10-					GC082002	Outer Joint		27	25	59	84.5	58	O			
2.0 T.S. (114 kW)	1998.09-	2000.10				GC082002	Outer Joint		27	25	59	84.5	58	O			
2.0 T.Spark (110 kW)	2000.10-	2007.06	6MT		F Saloon Engine AR36301	GCI82005	Inner Joint				25		32				
2.4 JTD (100 kW)	1998.09-	2000.10		L		GCI82007	Inner Joint				34		47.5				
	1998.09-	2000.10				GC082013	Outer Joint		27	28	59	83.5	63	O			
2.4 JTD (103 kW)	2000.10-					GC082013	Outer Joint		27	28	59	83.5	63	O			
	2000.10-			L		GCI82007	Inner Joint				34		47.5				
2.4 JTD (110 kW)	2002.04-			L		GCI82007	Inner Joint				34		47.5				
	2002.04-					GC082013	Outer Joint		27	28	59	83.5	63	O			
2.4 JTD (122 kW)	2003.1-		AT	L		GCI17048	Inner Joint		26	26	31	68	94.5				
	2003.1-		MT	L		GCI21016	Inner Joint		27	26	35	78.5	112				
	2003.1-		AT	R		GCI17069	Inner Joint		26	26	31	418.5	108.5				
	2003.1-		MT/AT			GC099298	Outer Joint		27	26	59	84.5	63	M			
	2003.10-		MT	R		GCI17076	Inner Joint		27	26	35	428	108.5				
2.4 JTD (129 kW)	2003.1-		AT	L		GCI17048	Inner Joint		26	26	31	68	94.5				
	2003.1-		MT	L		GCI21016	Inner Joint		27	26	35	78.5	112				
	2003.1-		AT	R		GCI17069	Inner Joint		26	26	31	418.5	108.5				
	2003.1-		MT/AT			GC099298	Outer Joint		27	26	59	84.5	63	M			
	2003.10-	2007.06			F Saloon Engine 841G.000/841H.000	GC099298	Outer Joint		27	26	59	84.5	63	M			
2.4 JTD (132 kW)	2003.10-		MT	R		GCI17076	Inner Joint		27	26	35	428	108.5				
	2003.1-		MT	L		GCI21016	Inner Joint		27	26	35	78.5	112				
	2003.1-		MT/AT			GC099298	Outer Joint		27	26	59	84.5	63	M			
	2003.10-		MT	R		GCI17076	Inner Joint		27	26	35	428	108.5				
	2006.07-	2007.06			F Saloon Engine 841M.000	GC099298	Outer Joint		27	26	59	84.5	63	M			
2.4 JTD (136 kW)	2005.07-	2007.06			F Saloon Engine 841M.000/936B.000	GC099298	Outer Joint		27	26	59	84.5	63	M			
2.5 V6 24V (138 kW)	2000.10-					GC082013	Outer Joint		27	28	59	83.5	63	O			
2.5 V6 24V (140 kW)	1998-	2000				GC082013	Outer Joint		27	28	59	83.5	63	O			
3.0 V6 24V (166 kW)	1998-	2000				GC082013	Outer Joint		27	28	59	83.5	63	O			
<b>1750-2000</b>																	
1.8 (83 kW)	1968.03-	1972.10	MT		R Saloon Engine AR00548	GCI82001	Inner Joint				24		32				
2.0 (97 kW)	1971.10-	1983.12	MT		R Saloon Engine AR10520	GCI82001	Inner Joint				24		32				
<b>33 (905)</b>																	
1.2 (50 kW)	1983.06-	1989.12	MT		F Hatchback Engine AR30585	GCI82001	Inner Joint				24		32				

		TRANSM	L/R	F/R		G-AP Ref.	PRODUCT	ABS	Technical Specifications						
									YEAR	A	B	C	H	L	P
<b>ALFA ROMEO</b>															
<b>33 (905)</b>															
1.3 (55 kW)	1983.06-	1989.12	MT		F	Hatchback Engine AR30502/AR30586	GCI82001	Inner Joint		24		32			
	1983.06-	1989.12	MT		F	Hatchback Engine AR30502/AR30586	GC082015	Outer Joint	28	24	55	96	58	O	
1.3 (58 kW)	1983.05-	1989.12	MT		F	Hatchback Engine AR30502	GCI82001	Inner Joint		24		32			
	1983.05-	1989.12	MT		F	Hatchback Engine AR30502	GC082015	Outer Joint	28	24	55	96	58	O	
1.3 (63 kW)	1984.10-	1989.12	MT		F	Hatchback Engine AR30168/AR30587	GCI82001	Inner Joint		24		32			
	1984.10-	1989.12	MT		F	Hatchback Engine AR30168/AR30587	GC082015	Outer Joint	28	24	55	96	58	O	
1.3 i.e. (66 kW)	1983.05-	1989.12	MT		F	Hatchback Engine AR 30168	GCI82001	Inner Joint		24		32			
1.5 (62 kW)	1983.06-	1985.12			F	Hatchback Engine AR30143/AR30504	GCI82001	Inner Joint		24		32			
	1983.06-	1985.12	MT		F	Hatchback Engine AR30143/AR30504	GC082015	Outer Joint	28	24	55	96	58	O	
1.5 (66 kW)	1983.06-	1986.12			F	Hatchback Engine AR30520	GCI82001	Inner Joint		24		32			
	1983.06-	1986.12	MT		F	Hatchback Engine AR30520	GC082015	Outer Joint	28	24	55	96	58	O	
1.5 (75 kW)	1986.07-	1989.12			F	Hatchback Engine AR30588	GCI82001	Inner Joint		24		32			
	1986.07-	1989.12	MT		F	Hatchback Engine AR30588	GC082015	Outer Joint	28	24	55	96	58	O	
1.5 4x4 (62 kW)	1983.11-	1984.12				Hatchback Engine AR30504	GCI82001	Inner Joint		24		32			
	1983.11-	1984.12	MT		F	Hatchback Engine AR30504	GC082015	Outer Joint	28	24	55	96	58	O	
1.5 4x4 (66 kW)	1985.01-	1986.09				Hatchback Engine AR30520	GCI82001	Inner Joint		24		32			
	1985.01-	1986.09	MT		F	Hatchback Engine AR30520	GC082015	Outer Joint	28	24	55	96	58	O	
1.5 4x4 (75 kW)	1986.07-	1989.12				Hatchback Engine AR30588	GCI82001	Inner Joint		24		32			
	1986.07-	1989.12	MT		F	Hatchback Engine AR30588	GC082015	Outer Joint	28	24	55	96	58	O	
1.5 4x4 (77 kW)	1986.09-	1989.12				Hatchback Engine AR30146/AR30588	GCI82001	Inner Joint		24		32			
	1986.09-	1989.12	MT		F	Hatchback Engine AR30146/AR30588	GC082015	Outer Joint	28	24	55	96	58	O	
1.5 QV (77 kW)	1984.06-	1989.12			F	Hatchback Engine AR30146/AR30508/AR30588	GCI82001	Inner Joint		24		32			
	1984.06-	1989.12	MT		F	Hatchback Engine AR30146/AR30508/AR30588	GC082015	Outer Joint	28	24	55	96	58	O	
1.7 (87 kW)	1986.01-	1989.12			F	Hatchback Engine AR30550	GCI82001	Inner Joint		24		32			
	1986.01-	1989.12	MT		F	Hatchback Engine AR30550	GC082015	Outer Joint	28	24	55	96	58	O	
1.7 i.e. (77 kW)	1988.09-	1989.12			F	Hatchback Engine AR30558	GCI82001	Inner Joint		24		32			
	1988.09-	1989.12	MT		F	Hatchback Engine AR30558	GC082015	Outer Joint	28	24	55	96	58	O	
1.7 QV (84 kW)	1988.03-	1989.12			F	Hatchback Engine AR30550	GCI82001	Inner Joint		24		32			
	1988.03-	1989.12	MT		F	Hatchback Engine AR30550	GC082015	Outer Joint	28	24	55	96	58	O	
1.8 TD (54 kW)	1986.01-	1990.06			F	Hatchback Engine VM82A	GCI82001	Inner Joint		24		32			
	1986.01-	1990.06	MT		F	Hatchback Engine VM82A	GC082015	Outer Joint	28	24	55	96	58	O	
<b>33 (905A)</b>															
1.4 (66 kW)	1984.01-	1988.12			F	Estate Engine AR30587	GCI82001	Inner Joint		24		32			
1.5 (66 kW)	1984.09-	1986.12			F	Estate Engine AR30520	GCI82001	Inner Joint		24		32			
	1984.09-	1986.12	MT		F	Estate Engine AR30520	GC082015	Outer Joint	28	24	55	96	58	O	
1.5 (75 kW)	1986.12-	1989.12			F	Estate Engine AR30588	GCI82001	Inner Joint		24		32			
	1986.12-	1989.12	MT		F	Estate Engine AR30588	GC082015	Outer Joint	28	24	55	96	58	O	
1.5 (77 kW)	1986.12-	1989.12			F	Estate Engine AR30146/AR30508/AR30588	GCI82001	Inner Joint		24		32			
	1986.12-	1989.12	MT		F	Estate Engine AR30146/AR30508/AR30588	GC082015	Outer Joint	28	24	55	96	58	O	
1.5 4x4 (66 kW)	1984.09-	1986.12				Estate Engine AR30520	GCI82001	Inner Joint		24		32			
	1984.09-	1986.12	MT		F	Estate Engine AR30520	GC082015	Outer Joint	28	24	55	96	58	O	
1.5 4x4 (75 kW)	1986.12-	1989.12				Estate Engine AR30588	GCI82001	Inner Joint		24		32			
	1986.12-	1989.12	MT		F	Estate Engine AR30588	GC082015	Outer Joint	28	24	55	96	58	O	
1.5 4x4 (77 kW)	1986.12-	1989.03				Estate Engine AR30146/AR30508/AR30588	GCI82001	Inner Joint		24		32			
	1986.12-	1989.03	MT		F	Estate Engine AR30146/AR30508/AR30588	GC082015	Outer Joint	28	24	55	96	58	O	
1.7 (87 kW)	1988.03-	1989.12			F	Estate Engine AR30550	GCI82001	Inner Joint		24		32			
	1988.03-	1989.12	MT		F	Estate Engine AR30550	GC082015	Outer Joint	28	24	55	96	58	O	
1.7 i.e. (77 kW)	1988.09-	1989.12			F	Estate Engine AR30558	GCI82001	Inner Joint		24		32			
	1988.09-	1989.12	MT		F	Estate Engine AR30558	GC082015	Outer Joint	28	24	55	96	58	O	
1.7 i.e. 4x4 (77 kW)	1988.09-	1989.12				Estate Engine AR30558/AR30737	GCI82001	Inner Joint		24		32			
	1988.09-	1989.12	MT		F	Estate Engine AR30558/AR30737	GC082015	Outer Joint	28	24	55	96	58	O	
<b>33 (907A)</b>															
1.4 i.e. (65 kW)	1991.06-	1994.09	MT		F	Hatchback Engine AR30753/AR30755	GC082015	Outer Joint	28	24	55	96	58	O	
1.4 i.e. (66 kW)	1991.06-	1994.09			F	Hatchback Engine AR30753/AR30755	GCI82001	Inner Joint		24		32			
	1991.06-	1994.09	MT		F	Hatchback Engine AR30753/AR30755	GC082015	Outer Joint	28	24	55	96	58	O	
	1991.06-	1994.09			F	Hatchback Engine AR30753/AR30755	GC082001	Outer Joint	25	24	52	85	58	O	
1.5 (77 kW)	1990.01-	1993.04			F	Hatchback Engine AR30734	GCI82001	Inner Joint		24		32			
	1990.01-	1993.04			F	Hatchback Engine AR30734	GC082001	Outer Joint	25	24	52	85	58	O	
1.5 i.e. (71 kW)	1990.01-	1994.09			F	Hatchback Engine AR30751	GCI82001	Inner Joint		24		32			
	1990.01-	1994.09			F	Hatchback Engine AR30751	GC082001	Outer Joint	25	24	52	85	58	O	
1.5 i.e. (74 kW)	1990.07-	1991.08			F	Hatchback Engine AR30750	GCI82001	Inner Joint		24		32			
	1990.07-	1991.08			F	Hatchback Engine AR30750	GC082001	Outer Joint	25	24	52	85	58	O	









		TRANSM	L/R	F/R		G-AP Ref.	PRODUCT	ABS	Technical Specifications					
									YEAR	A	B	C	H	L
<b>ALFA ROMEO</b>														
<b>33 (907A)</b>														
1.7 16V (101 kW)	1990.01-	1992.03			F Hatchback Engine AR30746	GCI82001	Inner Joint		24		32			
	1990.01-	1992.03			F Hatchback Engine AR30746	GC082001	Outer Joint	25	24	52	85	58	O	
1.7 16V (95 kW)	1990.01-	1994.09			F Hatchback Engine AR30747	GCI82001	Inner Joint		24		32			
1.7 16V (97 kW)	1990.01-	1992.03			F Hatchback Engine AR30747	GCI82001	Inner Joint		24		32			
1.7 16V 4x4 (101 kW)	1990.01-	1994.09			Hatchback Engine AR30746	GCI82001	Inner Joint		24		32			
	1990.01-	1994.09			Hatchback Engine AR30746	GC082001	Outer Joint	25	24	52	85	58	O	
1.7 16V 4x4 (95 kW)	1990.01-	1994.09			Hatchback Engine AR30747	GCI82001	Inner Joint		24		32			
1.7 16V 4x4 (97 kW)	1990.01-	1994.09			Hatchback Engine AR30747	GCI82001	Inner Joint		24		32			
1.7 i.e. (77 kW)	1992.04-	1994.09			F Hatchback Engine AR30737A	GCI82001	Inner Joint		24		32			
	1992.04-	1994.09	MT		F Hatchback Engine AR30737A	GC082015	Outer Joint	28	24	55	96	58	O	
	1992.04-	1994.09			F Hatchback Engine AR30737A	GC082001	Outer Joint	25	24	52	85	58	O	
1.7 i.e. (79 kW)	1990.01-	1994.09			F Hatchback Engine AR30736/AR30737	GCI82001	Inner Joint		24		32			
	1990.01-	1994.09	MT		F Hatchback Engine AR30736/AR30737	GC082015	Outer Joint	28	24	55	96	58	O	
	1990.01-	1994.09			F Hatchback Engine AR30736/AR30737	GC082001	Outer Joint	25	24	52	85	58	O	
1.7 i.e. 4x4 (79 kW)	1990.01-	1992.03			Hatchback Engine AR30736/AR30737	GCI82001	Inner Joint		24		32			
	1990.01-	1992.03	MT		F Hatchback Engine AR30736/AR30737	GC082015	Outer Joint	28	24	55	96	58	O	
	1990.01-	1992.03			Hatchback Engine AR30736/AR30737	GC082001	Outer Joint	25	24	52	85	58	O	
1.8 TD (62 kW)	1990.07-	1994.09			F Hatchback Engine VM96A	GCI82001	Inner Joint		24		32			
	1990.07-	1994.09	MT		F Hatchback Engine VM96A	GC082015	Outer Joint	28	24	55	96	58	O	
	1990.07-	1994.09			F Hatchback Engine VM96A	GC082001	Outer Joint	25	24	52	85	58	O	
<b>33 (907B)</b>														
1.4 i.e. (65 kW)	1991.06-	1994.09	MT		F Estate Engine AR30755/AR30753	GC082015	Outer Joint	28	24	55	96	58	O	
1.4 i.e. (66 kW)	1991.06-	1994.09			F Estate Engine AR30755	GCI82001	Inner Joint		24		32			
	1991.06-	1994.09	MT		F Estate Engine AR30755	GC082015	Outer Joint	28	24	55	96	58	O	
	1991.06-	1994.09			F Estate Engine AR30755	GC082001	Outer Joint	25	24	52	85	58	O	
1.5 i.e. (71 kW)	1990.01-	1994.09			F Estate Engine AR30751	GCI82001	Inner Joint		24		32			
	1990.01-	1994.09			F Estate Engine AR30751	GC082001	Outer Joint	25	24	52	85	58	O	
1.7 16V (101 kW)	1990.01-	1992.03			F Estate Engine AR30746	GCI82001	Inner Joint		24		32			
	1990.01-	1992.03			F Estate Engine AR30746	GC082001	Outer Joint	25	24	52	85	58	O	
1.7 16V (95 kW)	1990.01-	1994.09			F Estate Engine AR30747	GCI82001	Inner Joint		24		32			
1.7 16V (97 kW)	1990.01-	1994.09			F Estate Engine AR30747	GCI82001	Inner Joint		24		32			
1.7 16V 4x4 (95 kW)	1990.01-	1994.09			Estate Engine AR30747	GCI82001	Inner Joint		24		32			
1.7 16V 4x4 (97 kW)	1990.01-	1992.03			Estate Engine AR30747	GCI82001	Inner Joint		24		32			
1.7 i.e. (77 kW)	1992.04-	1994.09			F Estate Engine AR30737	GCI82001	Inner Joint		24		32			
	1992.04-	1994.09	MT		F Estate Engine AR30737	GC082015	Outer Joint	28	24	55	96	58	O	
	1992.04-	1994.09			F Estate Engine AR30737	GC082001	Outer Joint	25	24	52	85	58	O	
1.7 i.e. (79 kW)	1990.01-	1992.03			F Estate Engine AR30736/AR30737	GCI82001	Inner Joint		24		32			
	1990.01-	1992.03	MT		F Estate Engine AR30736/AR30737	GC082015	Outer Joint	28	24	55	96	58	O	
	1990.01-	1992.03			F Estate Engine AR30736/AR30737	GC082001	Outer Joint	25	24	52	85	58	O	
1.7 i.e. 4x4 (79 kW)	1990.01-	1992.03			Estate Engine AR30736/AR30737	GCI82001	Inner Joint		24		32			
	1990.01-	1992.03	MT		F Estate Engine AR30736/AR30737	GC082015	Outer Joint	28	24	55	96	58	O	
	1990.01-	1992.03			Estate Engine AR30736/AR30737	GC082001	Outer Joint	25	24	52	85	58	O	
<b>33 II (907A, B) SPORTWAGON</b>														
1.4 i.e. (66 kW)	1991.06-	1994.09				GCI82001	Inner Joint		24		32			
1.5 i.e. (74 kW)	1990.01-	1991.11				GCI82001	Inner Joint		24		32			
1.7 i.e. (79 kW)	1990.01-	1991.11				GCI82001	Inner Joint		24		32			
1.8 TD (Exc. SW) (82 kW)	1990.01-	1991.11				GCI82001	Inner Joint		24		32			
<b>33 SPORT WAGON (907B)</b>														
1.4 i.e. 4WD (66 kW)	1991.06-	1994.09			Estate Engine AR 30587/AR 30755	GCI82001	Inner Joint		24		32			
<b>75 (162B)</b>														
1.6 (81 kW)	1985.05-	1989.09	MT		R Saloon Engine AR06100	GCI82001	Inner Joint		24		32			
1.6 CAT (81 kW)	1989.05-	1992.02	MT		R Saloon Engine AR61101	GCI82001	Inner Joint		24		32			
1.8 (85 kW)	1985.09-	1989.06	MT		R Saloon Engine AR06202	GCI82001	Inner Joint		24		32			
1.8 (88 kW)	1988.09-	1992.02	MT		R Saloon Engine AR06168/AR61102	GCI82001	Inner Joint		24		32			
1.8 (90 kW)	1989.08-	1992.02	MT		R Saloon Engine AR61201	GCI82001	Inner Joint		24		32			
2.0 (94 kW)	1985.05-	1988.10	MT		R Saloon Engine AR06212	GCI82001	Inner Joint		24		32			
2.0 T.S CAT (109 kW)	1985.05-	1992.02	MT		R Saloon Engine AR06224	GCI82001	Inner Joint		24		32			
2.0 T.S. (107 kW)	1987.01-	1992.02	MT		R Saloon Engine AR06166/AR06224	GCI82001	Inner Joint		24		32			
2.0 T.S. (109 kW)	1987.01-	1988.12	MT		R Saloon Engine AR06224	GCI82001	Inner Joint		24		32			
2.0 TD (70 kW)	1985.05-	1992.09	MT		R Saloon Engine VM80A	GCI82001	Inner Joint		24		32			



		TRANSM	L/R	F/R		G-AP Ref.	PRODUCT	ABS	Technical Specifications						
									YEAR	A	B	C	H	L	P
<b>ALFA ROMEO</b>															
<b>90 (162)</b>															
1.8 (85 kW)	1984.10-	1987.07	MT		R	Saloon Engine AR06202	GCI82001	Inner Joint		24		32			
1.8 (89 kW)	1984.10-	1987.07	MT		R	Saloon Engine AR06202	GCI82001	Inner Joint		24		32			
2.0 i.e. (94 kW)	1984.10-	1987.07	MT		R	Saloon Engine AR01713/AR06212	GCI82001	Inner Joint		24		32			
2.5 i.e. V6 (110 kW)	1984.10-	1987.07	MT		R	Saloon Engine AR01646/AR01911	GCI82001	Inner Joint		24		32			
2.5 i.e. V6 (114 kW)	1984.10-	1987.07	MT		R	Saloon Engine AR01646/AR01911	GCI82001	Inner Joint		24		32			
<b>ALFASUD (901)</b>															
1.2 (46 kW)	1972.06-	1984.09	MT		F	Hatchback Engine AR30102	GCI82001	Inner Joint		24		32			
1.2 TI (50 kW)	1973.11-	1984.09	MT		F	Hatchback Engine AR30104	GCI82001	Inner Joint		24		32			
1.3 Super (51 kW)	1979.01-	1984.09	MT		F	Hatchback Engine AR30160	GCI82001	Inner Joint		24		32			
1.3 TI (55 kW)	1977.09-	1984.09	MT		F	Hatchback Engine AR30184	GCI82001	Inner Joint		24		32			
1.5 TI (61 kW)	1979.01-	1984.09	MT		F	Hatchback Engine AR30124	GCI82001	Inner Joint		24		32			
1.5 TI (70 kW)	1980.03-	1984.12	MT		F	Hatchback Engine AR30128	GCI82001	Inner Joint		24		32			
1.5 TI Sprint (77 kW)	1983.01-	1984.12	MT		F	Hatchback Engine AR30146	GCI82001	Inner Joint		24		32			
<b>ALFASUD GIARDINETTA (904)</b>															
1.2 (46 kW)	1978.01-	1981.12	MT		F	Estate Engine AR30102	GCI82001	Inner Joint		24		32			
1.3 (48 kW)	1978.01-	1979.07	MT		F	Estate Engine AR30180	GCI82001	Inner Joint		24		32			
1.3 (51 kW)	1980.03-	1981.12	MT		F	Estate Engine AR30160	GCI82001	Inner Joint		24		32			
<b>ALFASUD SPRINT (902.A)</b>															
1.3 (55 kW)	1976.09-	1981.12			F	Coupe Engine AR30184	GCI82001	Inner Joint		24		32			
1.4 (63 kW)	1979.07-	1989.12	MT		F	Coupe Engine AR30168	GCI82001	Inner Joint		24		32			
1.5 (77 kW)	1983.01-	1987.12			F	Coupe Engine AR30146	GCI82001	Inner Joint		24		32			
1.7 (87 kW)	1987.03-	1989.12			F	Coupe Engine AR30550	GCI82001	Inner Joint		24		32			
<b>ALFETTA (116)</b>															
1.6 (79 kW)	1975.01-	1984.12			R	Saloon Engine AR01600	GCI82001	Inner Joint		24		32			
1.8 (89 kW)	1979.10-	1984.12			R	Saloon Engine AR01608	GCI82001	Inner Joint		24		32			
1.8 (90 kW)	1979.10-	1984.12			R	Saloon Engine AR01678	GCI82001	Inner Joint		24		32			
2.0 (97 kW)	1978.07-	1984.12			R	Saloon Engine AR01655/AR01713/AR10520	GCI82001	Inner Joint		24		32			
2.0 TD (60 kW)	1979.10-	1983.03			R	Saloon Engine VM4HT/2	GCI82001	Inner Joint		24		32			
<b>ALFETTA GT (116)</b>															
1.6 (79 kW)	1976.01-	1982.09			R	Coupe Engine AR01600	GCI82001	Inner Joint		24		32			
2.0 (89 kW)	1978.07-	1986.01			R	Coupe Engine AR01623	GCI82001	Inner Joint		24		32			
2.0 (96 kW)	1977.06-	1984.12			R	Coupe Engine AR01655	GCI82001	Inner Joint		24		32			
<b>ARNA (920)</b>															
1.2 (44 kW)	1985.01-	1986.12	MT		F	Hatchback Engine AR31000	GCI82001	Inner Joint		24		32			
1.2 (50 kW)	1985.01-	1986.12	MT		F	Hatchback Engine AR30500	GCI82001	Inner Joint		24		32			
1.3 TI (63 kW)	1983.03-	1986.12			F	Hatchback Engine AR30168/AR31010	GCI82001	Inner Joint		24		32			
			MT	F	Hatchback Engine AR30168/AR31010	GC082015	Outer Joint	28	24	55	96	58	O		
1.5 (70 kW)	1985.01-	1986.12			F	Hatchback Engine AR30182	GCI82001	Inner Joint		24		32			
<b>BRAVO (198)</b>															
1.9 D Multijet (110 kW)	2007.04-						GC017009	Outer Joint		25	26	59	84	63	M
<b>BRERA</b>															
1.8 TBi (147 kW)	2009.05-				F	Hatchback Engine 939B1.000	GC082024	Outer Joint		30	27	61	93	65	M
2.0 JTDM (125 kW)	2009.05-				F	Hatchback Engine 939B3.000	GC082024	Outer Joint		30	27	61	93	65	M
2.2 JTS (136 kW)	2006.04-				F	Hatchback Engine 939A5.000	GC082023	Outer Joint		30	26	61	94	63.5	M
			L	F	Hatchback Engine 939A5.000	GDS17122	Drive Shaft	30	25	61	94	640			
	2006.04-				L	F	Hatchback Engine 939A5.000	GCI17035	Inner Joint		25	26	34.9	57.5	114.5
			MT	R	F	Hatchback Engine 939A5.000	GDS17124	Drive Shaft	30	25	61	94	1015		
	2006.04-				R	F	Hatchback Engine 939A5.000	GCI82010	Inner Joint		25	26	34.9	439.5	108.5
			MT	F	Hatchback Engine 939A5.000										
2.4 JTDM 20V (147 kW)	2006.04-				F	Hatchback Engine 939A3.000	GC082024	Outer Joint		30	27	61	93	65	M
			MT	L	F	Hatchback Engine 939A3.000	GDS17123	Drive Shaft	30	27	61	93	598		
			MT	L	F	Hatchback Engine 939A3.000	GCI21017	Inner Joint	27	27	35	78.5	112		
			MT	R	F	Hatchback Engine 939A3.000	GDS17145	Drive Shaft	30	27	61	93	1059		
2.4 JTDM 20V (154 kW)	2007.05-				F	Hatchback Engine 939A9.000	GC082024	Outer Joint		30	27	61	93	65	M
			MT	L	F	Hatchback Engine 939A9.000	GDS17123	Drive Shaft	30	27	61	93	598		
			MT	L	F	Hatchback Engine 939A9.000	GCI21017	Inner Joint	27	27	35	78.5	112		
			MT	R	F	Hatchback Engine 939A9.000	GDS17145	Drive Shaft	30	27	61	93	1059		
3.2 JTS (191 kW)	2008.03-				F	Hatchback Engine 939A.000	GC082023	Outer Joint		30	26	61	94	63.5	M
3.2 JTS Q4 (191 kW)	2006.04-					Hatchback Engine 939A.000	GC082023	Outer Joint		30	26	61	94	63.5	M
<b>BRERA COUPE (177)</b>															
1.8 TBI (147 kW)	2009.05-						GC082024	Outer Joint		30	27	61	93	65	M
2.0 JTDM (125 kW)	2009.05-				L		GCI21017	Inner Joint		27	27	35	78.5	112	
	2009.05-						GC082024	Outer Joint		30	27	61	93	65	M

		TRANSM	L/R	F/R		G-AP Ref.	PRODUCT	ABS	Technical Specifications									
									YEAR	A	B	C	H	L	P			
<b>ALFA ROMEO BRERA COUPE (177)</b>																		
2.2 JTS (136 kW)	2006.01-			L		GCI82009	Inner Joint		25	26	34.9	57.5	114.5					
	2006.01-			R		GCI82010	Inner Joint		25	26	34.9	439.5	108.5					
	2006.01-					GC082023	Outer Joint		30	26	61	94	63.5	M				
2.4 JTDM 20V (147 kW)	2006.01-		MT/AT	L		GCI21017	Inner Joint		27	27	35	78.5	112					
	2006.01-		MT/AT	R		GCI17008	Inner Joint		27	27	35	498	108.5					
	2006.01-		MT/AT			GC082024	Outer Joint		30	27	61	93	65	M				
2.4 JTDM 20V (154 kW)	2006.01-		MT/AT	L		GCI21017	Inner Joint		27	27	35	78.5	112					
	2006.01-		MT/AT	R		GCI17008	Inner Joint		27	27	35	498	108.5					
	2006.01-		MT/AT			GC082024	Outer Joint		30	27	61	93	65	M				
3.2 JTS 4x2 (191 kW)	2008.03-			L		GCI21017	Inner Joint		27	27	35	78.5	112					
	2008.03-					GC082024	Outer Joint		30	27	61	93	65	M				
3.2 JTS Q4 (195 kW)	2006.01-		MT	L		GCI21016	Inner Joint		27	26	35	78.5	112					
	2006.01-		MT			GC082023	Outer Joint		30	26	61	94	63.5	M				
3.2 JTS Q4 (195)	2006.01-		MT	R		GCI17007	Inner Joint		27	26	35	453	108.5					
<b>GIULIETTA (116)</b>																		
1.3 (66 kW)	1977.10-	1983.06			R	Saloon Engine AR01644	Inner Joint				24		32					
1.6 (79 kW)	1977.10-	1985.04			R	Saloon Engine AR01600	Inner Joint				24		32					
1.8 (90 kW)	1979.04-	1985.04			R	Saloon Engine AR01678	Inner Joint				24		32					
2.0 (96 kW)	1980.06-	1985.04			R	Saloon Engine AR01655/AR11671	Inner Joint				24		32					
2.0 TD (61 kW)	1983.01-	1985.12			R	Saloon Engine VM4HT	Inner Joint				24		32					
<b>GIULIETTA (940)</b>																		
1.4 TB (125 kW)	2010.04-				F	Hatchback Engine 940A2.000	Outer Joint		27	25	59	84	61.5	M				
1.4 TB (88 kW)	2010.04-				F	Hatchback Engine 198A4.000/940B7.000	Outer Joint		27	25	59	84	61.5	M				
1.6 JTDM (77 kW)	2010.04-				F	Hatchback Engine 940A3.000	Outer Joint		27	25	59	84	61.5	M				
<b>GIULIETTA X7 (940)</b>																		
1.4 TB (125 kW)	2010.04-	2013.04			L		GCI17031	Inner Joint	25	26	32	59	110.5					
1.4 TB (77 kW)	2010.04-	2013.04			L		GCI17031	Inner Joint	25	26	32	59	110.5					
1.4 TB (88 kW)	2010.04-	2013.04			L		GCI17031	Inner Joint	25	26	32	59	110.5					
1.6 JTD (77 kW)	2010.04-	2013.04			L		GCI17031	Inner Joint	25	26	32	59	110.5					
1.6 JTDM (77 kW)	2010.04-	2013.04			L		GCI17031	Inner Joint	25	26	32	59	110.5					
1.8 TBI (1693 kW)	2010.04-						GC017064	Outer Joint	27	27	59	84.5	64	M				
1.8 TBI (173 kW)	2010.04-						GC017064	Outer Joint	27	27	59	84.5	64	M				
2.0 JTDM (103 kW)	2010.04-						GC017064	Outer Joint	27	27	59	84.5	64	M				
2.0 JTDM (110 kW)	2010.04-						GC017064	Outer Joint	27	27	59	84.5	64	M				
2.0 JTDM (125 kW)	2010.04-						GC017064	Outer Joint	27	27	59	84.5	64	M				
<b>GT (937)</b>																		
1.8 T.S. (103 kW)	2003.11-						GC082008	Outer Joint	25	25	59	85	58	O				
1.8 TS (103 kW)	2003.11-	2010.09			F	Coupe Engine AR32205	Inner Joint			25		32						
	2003.11-	2010.09	MT/AT		F	Coupe Engine AR32205	Drive Shaft		25		58.8	85	490					
1.9 JTD (110 kW)	2003.11-				L		GCI17005	Inner Joint	25	26	32	91	95					
	2003.11-				R		GCI17006	Inner Joint	25	26	29.8	377	108					
	2004.04-	2007.01	MT	L	F	Coupe Engine 937A5.000	Drive Shaft		25	25	59	84	615					
	2004.04-	2007.01	MT	L	F	Coupe Engine 937A5.000	Inner Joint		25	26	32	91	95					
	2004.04-	2007.01	MT	R	F	Coupe Engine 937A5.000	Drive Shaft		25	25	51	84.5	931.5					
	2004.04-	2007.01	MT	R	F	Coupe Engine 937A5.000	Inner Joint		25	26	29.8	377	108					
	2013.11-						GC017009	Outer Joint	25	26	59	84	63	M				
1.9 JTD (125 kW)	2008.05-	2010.09	MT	L	F	Coupe Engine 937A6.000	Drive Shaft		25	25	59	84	615					
	2008.05-	2010.09	MT	L	F	Coupe Engine 937A6.000	Inner Joint		25	26	32	91	95					
	2008.05-	2010.09	MT	R	F	Coupe Engine 937A6.000	Drive Shaft		25	25	51	84.5	931.5					
	2008.05-	2010.09	MT	R	F	Coupe Engine 937A6.000	Inner Joint		25	26	29.8	377	108					
	2008.05-				L		GCI17005	Inner Joint	25	26	32	91	95					
	2008.05-				R		GCI17006	Inner Joint	25	26	29.8	377	108					
2.0 JTS (119 kW)	2006.12-	2010.09	MT/AT		F	Coupe Engine 932A2.000	Drive Shaft		25		58.8	85	490					
2.0 JTS (121 kW)	2003.11-						GC082008	Outer Joint	25	25	59	85	58	O				
	2004.04-	2007.01			F	Coupe Engine 932A2.000/937A1.000	Inner Joint			25		32						
	2004.04-	2007.01			F	Coupe Engine 932A2.000/937A1.000	Drive Shaft		25		58.8	85	490					
3.2 GTA (176 kW)	2003.11-					GC099298	Outer Joint	27	26	59	84.5	63	M					
<b>GTV (116)</b>																		
2.0 (94 kW)	1985.01-	1985.12			R	Coupe Engine AR06212	Inner Joint				24		32					
2.0 (96 kW)	1978.07-	1986.01			R	Coupe Engine AR01655/AR06212	Inner Joint				24		32					
<b>GTV (916C)</b>																		
2.0 JTS (121 kW)	2003.04-						GC017042	Outer Joint	25	25	51	85	58	O				









		YEAR	TRANSM	L/R	F/R		G-AP Ref.	PRODUCT	ABS	Technical Specifications						
										A	B	C	H	L	P	
<b>ALFA ROMEO</b>																
<b>GTV (916C)</b>																
3.2 V6 24V (176 kW)	2003.04-						GC099298	Outer Joint			27	26	59	84.5	63	M
<b>GTV (916C_)</b>																
1.8 16V (106 kW)	1998.05-	2005.10	MT		F	Coupe Engine AR32201	GCI82005	Inner Joint				25		32		
2.0 JTS (121 kW)	2003.07-	2006.01			F	Coupe Engine 937A1.000	GC017042	Outer Joint			25	25	51	85	58	O
2.0 T.SPARK 16V (110 kW)	1995.06-	2005.10	5MT		F	Coupe Engine AR16201/AR32310	GC017042	Outer Joint			25	25	51	85	58	O
3.0 V6 24V (160 kW)	2000.10-	2005.10			F	Coupe Engine AR16105	GCI48002	Inner Joint				28		32		
<b>GTV (916S)</b>																
2.0 V6 T (148 kW)	1998.05-	2005.04					GCI82003	Inner Joint				28		32		
3.0 V6 (141 kW)	1995.06-	2005.04					GCI82003	Inner Joint				28		32		
<b>KAPPA (838A, B), SW</b>																
2.0 20V T Coupe (162 kW)	1998-	2001.10					GC082013	Outer Joint			27	28	59	83.5	63	O
2.4 20V Coupe (129 kW)	1994.08-	2001.10				Ch-2084919	GC082013	Outer Joint			27	28	59	83.5	63	O
2.4 JTD (100 kW)	1998.06-	2001.10					GC082013	Outer Joint			27	28	59	83.5	63	O
3.0 24V Coupe (150 kW)	1994.08-	2001.10				Ch-2084919	GC082013	Outer Joint			27	28	59	83.5	63	O
<b>MITO (955)</b>																
0.9 (63 kW)	2011.07-						GC017070	Outer Joint			22	22	51	79	57.5	M
0.9 (77 kW)	2011.07-						GC017070	Outer Joint			22	22	51	79	57.5	M
1.3 JTDM (59 kW)	2013.12-		MT	L/R	F	Hatchback Engine 199B8.000	GC017063	Outer Joint			25	25	51.1	84.5	61	M
1.3 JTDM (66 kW)	2008.09-				F	Hatchback Engine 199A3.000	GC017028	Outer Joint			25	24	51	84.5	62	M
	2008.09-		5MT	L	F	Hatchback Engine 199A3.000	GDS17148	Drive Shaft			25	24	51.1	84.5	614	
	2008.09-		MT	L	F	Hatchback Engine 199A3.000	GCI17025	Inner Joint			24	24	29.7	86.5	93	
	2008.09-		MT	R	F	Hatchback Engine 199A3.000	GDS17144	Drive Shaft			25	24	51.1	84.5	908	
	2008.09-		5MT	L	F	Hatchback Engine 199B1.000	GDS17148	Drive Shaft			25	24	51.1	84.5	614	
1.3 JTDM (70 kW)	2009.10-				L/R	F	Hatchback Engine 199B1.000	GC017063	Outer Joint		25	25	51.1	84.5	61	M
	2009.10-				MT	R	F	Hatchback Engine 199B1.000	GDS17144	Drive Shaft	25	24	51.1	84.5	908	
	2009.10-				R			GCI17026	Inner Joint	24	24	29.7	379	100.5		
1.3 SDE (61 kW)	2008.09-			R			GC017063	Outer Joint		25	25	51.1	84.5	61	M	
1.3 SDE (66 kW)	2008.09-			R			GCI17056	Inner Joint		25	23	34.9	400	97		
1.3 SDE (70 kW)	2008.09-			R			GCI17026	Inner Joint		24	24	29.7	379	100.5		
	2008.09-						GC017063	Outer Joint		25	25	51.1	84.5	61	M	
1.4 (110 kW)	2008.09-						GC017065	Outer Joint		25	33	51.1	84.5	61	I	
1.4 (51 kW)	2011.05-			R	F	Hatchback Engine 955A9.000	GDS17111	Drive Shaft		22	22	51.2	79.5	887		
1.4 (57 kW)	2011.03-			R	F	Hatchback Engine 350A1.000	GDS17111	Drive Shaft		22	22	51.2	79.5	887		
	2011.03-			R	F	Hatchback Engine 955A1.000	GDS17111	Drive Shaft		22	22	51.2	79.5	887		
1.4 (58 kW)	2008.09-		MT	L	F	Hatchback Engine 955A1.000	GDS17045	Drive Shaft		22	22	51	79.5	649		
	2008.09-		MT	L	F	Hatchback Engine 955A1.000	GCI17103	Inner Joint		22	27	36	61.5	93.5		
	2008.09-		MT	L	F	Hatchback Engine 955A1.000	GC099325	Outer Joint		22	27	51	79.5	54	O	
1.4 (70 kW)	2008.09-				F	Hatchback Engine 199A6.000	GC017052	Outer Joint		22	21	51.2	79.5	54	M	
	2008.09-			L/R	F	Hatchback Engine 199A6.000	GC017063	Outer Joint		25	25	51.1	84.5	61	M	
1.4 (77 kW)	2010.08-			L/R	F	Hatchback Engine 955A6.000	GC017070	Outer Joint		22	22	51	79	57.5	M	
1.4 (88 kW)	2008.09-			L/R	F	Hatchback Engine 198A4.000	GC017063	Outer Joint		25	25	51.1	84.5	61	M	
1.4 (99 kW)	2009.10-		MT				GC017063	Outer Joint		25	25	51.1	84.5	61	M	
1.4 8V (51 kW)	2013-						GC017070	Outer Joint		22	22	51	79	57.5	M	
1.4 8V (57 kW)	2013-						GC017070	Outer Joint		22	22	51	79	57.5	M	
1.4 Bifuel (88 kW)	2011.07-			L/R	F	Hatchback Engine 198A4.000	GC017063	Outer Joint		25	25	51.1	84.5	61	M	
1.4 TB (114 kW)	2008.09-				F	Hatchback Engine 199A8.000	GC017065	Outer Joint		25	33	51.1	84.5	61	I	
1.4 TB (120 kW)	2009.10-			L/R	F	Hatchback Engine 955A8.000	GC017063	Outer Joint		25	25	51.1	84.5	61	M	
	2009.10-						GC017063	Outer Joint		25	25	51.1	84.5	61	M	
1.4 TB (125 kW)	2009.10-			L/R	F	Hatchback Engine 940A2.000	GC017063	Outer Joint		25	25	51.1	84.5	61	M	
1.4 TB (99 kW)	2009.10-			L/R	F	Hatchback Engine 955A2.000/955A7.000	GC017063	Outer Joint		25	25	51.1	84.5	61	M	
1.4 TRB (120 kW)	2008.09-			L			GCI17031	Inner Joint		25	26	32	59	110.5		
1.6 JTD (88 kW)	2008.09-						GC017065	Outer Joint		25	33	51.1	84.5	61	I	
	2011-		MT	L			GCI17031	Inner Joint		25	26	32	59	110.5		
	2011-		MT				GC017063	Outer Joint		25	25	51.1	84.5	61	M	
1.6 JTDM (88 kW)	2008.09-				F	Hatchback Engine 198A2.000/955A3.000	GC017065	Outer Joint		25	33	51.1	84.5	61	I	
<b>SPIDER (916S)</b>																
2.0 16V T.S. (110 kW)	1995.06-	2005.04					GC082004	Outer Joint	44T		25	25	52	85	58	I
	1995.06-	2005.04					GC017042	Outer Joint			25	25	51	85	58	O
2.0 JTS (121 kW)	2003.04-	2005.04					GC017042	Outer Joint			25	25	51	85	58	O
<b>SPIDER (916S_)</b>																
1.8 16V (106 kW)	1998.05-	2005.04	MT		F	Convertible Engine AR32201	GCI82005	Inner Joint				25		32		
2.0 JTS (121 kW)	2003.04-	2005.04			F	Convertible Engine 937A1.000	GC017042	Outer Joint			25	25	51	85	58	O

		YEAR	TRANSM	L/R	F/R		G-AP Ref.	PRODUCT	ABS	Technical Specifications											
										A	B	C	H	L	P						
<b>ALFA ROMEO</b>																					
<b>SPIDER (916S_)</b>																					
2.0 T.SPARK 16V (110 kW)	1995.06-	2005.04	5MT			Convertible Engine AR16201/AR32310	GC017042	Outer Joint			25	25	51	85	58	O					
2.0 V6 Turbo (148 kW)	1998.05-	2005.04	MT			Convertible Engine AR16202	GC183001	Inner Joint				28		32							
	1998.05-	2005.04	MT			Convertible Engine AR16202	GC082009	Outer Joint	44T	25	28	56	85	63.5	O						
3.0 V6 (141 kW)	1995.06-	2005.04	MT			Convertible Engine AR16101	GC183001	Inner Joint				28		32							
	1995.06-	2005.04	MT			Convertible Engine AR16101	GC082009	Outer Joint	44T	25	28	56	85	63.5	O						
3.0 V6 24V (162 kW)	1999.01-	2003.10				Convertible Engine AR16102	GC148002	Inner Joint				28		32							
3.2 V6 24V (176 kW)	2003.04-	2005.04				Convertible Engine 936A6.000	GC148002	Inner Joint				28		32							
<b>SPIDER (939)</b>																					
1.8 TBi (147 kW)	2009.05-					Convertible Engine 939B1.000	GC082024	Outer Joint			30	27	61	93	65	M					
	2009.05-						GC082024	Outer Joint			30	27	61	93	65	M					
2.0 JTDM (125 kW)	2009.05-					Convertible Engine 939B3.000	GC082024	Outer Joint			30	27	61	93	65	M					
	2009.05-				L		GCI21017	Inner Joint			27	27	35	78.5	112						
	2009.05-						GC082024	Outer Joint			30	27	61	93	65	M					
2.2 JTS (136 kW)	2006.01-				L		GCI82009	Inner Joint			25	26	34.9	57.5	114.5						
	2006.01-				R		GCI82010	Inner Joint			25	26	34.9	439.5	108.5						
	2006.01-						GC082023	Outer Joint			30	26	61	94	63.5	M					
	2007.03-					Convertible Engine 939A5.000	GC082023	Outer Joint			30	26	61	94	63.5	M					
2.4 JTDM (147 kW)	2007.03-				Convertible Engine 939A3.000	GC082023	Outer Joint			30	26	61	94	63.5	M						
2.4 JTDM (154 kW)	2008.03-				Convertible Engine 939A3.000	GC082024	Outer Joint			30	27	61	93	65	M						
2.4 JTDM 20V (147 kW)	2006.01-		MT/AT	L			GCI21017	Inner Joint			27	27	35	78.5	112						
	2006.01-		MT/AT	R			GCI17008	Inner Joint			27	27	35	498	108.5						
2.4 JTDM 20V (154 kW)	2006.01-		MT/AT	L			GCI21017	Inner Joint			27	27	35	78.5	112						
	2006.01-		MT/AT	R			GCI17008	Inner Joint			27	27	35	498	108.5						
3.2 JTS (191 kW)	2008.03-					Convertible Engine 939A.000	GC082023	Outer Joint			30	26	61	94	63.5	M					
3.2 JTS 4x2 (191 kW)	2008.03-				L		GCI21017	Inner Joint			27	27	35	78.5	112						
3.2 JTS Q4 (191 kW)	2007.03-					Convertible Engine 939A.000	GC082023	Outer Joint			30	26	61	94	63.5	M					
3.2 JTS Q4 (195 kW)	2006.01-		MT	L			GCI21016	Inner Joint			27	26	35	78.5	112						
3.2 JTS Q4 (195)	2006.01-		MT	R			GCI17007	Inner Joint			27	26	35	453	108.5						
<b>AUDI</b>																					
<b>100</b>																					
1.8					L		GDS83028	Drive Shaft			38		59.5	34.5	599						
2.0					L		GDS83028	Drive Shaft			38		59.5	34.5	599						
<b>100 (43, C2)</b>																					
1.6 (63 kW)	1976.08-	1982.07	MT/AT			Saloon Engine YV	GC083004	Outer Joint			26	25	56.5	84.5	61.5	O					
1.9 (74 kW)	1980.08-	1982.07	MT			Saloon Engine WH	GC083004	Outer Joint			26	25	56.5	84.5	61.5	O					
2.0 D (51 kW)	1978.08-	1982.07				Saloon Engine CN	GC083004	Outer Joint			26	25	56.5	84.5	61.5	O					
2.1 (100 kW)	1977.03-	1982.07	MT/AT			Saloon Engine WC	GC083004	Outer Joint			26	25	56.5	84.5	61.5	O					
2.1 (85 kW)	1977.10-	1982.07	MT/AT			Saloon Engine WB	GC083004	Outer Joint			26	25	56.5	84.5	61.5	O					
<b>100 (44, 44Q, C3)</b>																					
1.8 (55 kW)	1982.08-	1987.12	MT/AT			Saloon Engine DR/RS	GC083004	Outer Joint			26	25	56.5	84.5	61.5	O					
	1982.08-	1987.12	MT/AT			Saloon Engine DR/RS	GC083006	Outer Joint	96T	26	25	56.5	84.5	61.5	O						
1.8 (65 kW)	1986.02-	1988.07	MT&AT			Saloon Engine SH	GC083004	Outer Joint			26	25	56.5	84.5	61.5	O					
	1986.02-	1988.07	MT			Saloon Engine SH	GC083013	Outer Joint			38	25	59.5	34.5	61	O					
	1986.02-	1988.07	MT			Saloon Engine SH	GC083006	Outer Joint	96T	26	25	56.5	84.5	61.5	O						
	1986.02-	1988.07	MT			Saloon Engine SH	GC083014	Outer Joint	45T	38	25	59.5	34.5	61	O						
	1986.02-	1988.07	AT			Saloon Engine SH	GC083005	Outer Joint	45T	26	25	56.5	84.5	61.5	O						
1.8 (66 kW)	1983.08-	1989.07	MT/AT			Saloon Engine NP/DS	GC083004	Outer Joint			26	25	56.5	84.5	61.5	O					
	1983.08-	1989.07	MT			Saloon Engine NP/DS	GC083013	Outer Joint			38	25	59.5	34.5	61	O					
	1983.08-	1989.07	MT			Saloon Engine NP/DS	GC083006	Outer Joint	96T	26	25	56.5	84.5	61.5	O						
	1983.08-	1989.07	MT			Saloon Engine NP/DS	GC083014	Outer Joint	45T	38	25	59.5	34.5	61	O						
	1983.08-	1989.07	AT			Saloon Engine NP/DS	GC083005	Outer Joint	45T	26	25	56.5	84.5	61.5	O						
1.8 CAT (66 kW)	1985.03-	1990.11	AT			Saloon Engine 4B/PH	GC083004	Outer Joint			26	25	56.5	84.5	61.5	O					
	1985.03-	1990.11	MT			Saloon Engine 4B/PH	GC083013	Outer Joint			38	25	59.5	34.5	61	O					
	1985.03-	1990.11	MT			Saloon Engine 4B/PH	GC083014	Outer Joint	45T	38	25	59.5	34.5	61	O						
	1985.03-	1990.11	AT			Saloon Engine 4B/PH	GC083005	Outer Joint	45T	26	25	56.5	84.5	61.5	O						
1.8 Quattro (65 kW)	1986.08-	1990.07				Saloon Engine SH	GC083004	Outer Joint			26	25	56.5	84.5	61.5	O					
	1986.08-	1990.07				Saloon Engine SH	GC083006	Outer Joint	96T	26	25	56.5	84.5	61.5	O						
	1986.08-	1990.07	MT			Saloon Engine SH	GC083014	Outer Joint	45T	38	25	59.5	34.5	61	O						
	1986.08-	1990.07	MT/AT		R	Saloon Engine SH	GC083014	Outer Joint	45T	38	25	59.5	34.5	61	O						
1.8 Quattro (66 kW)	1984.10-	1988.07				Saloon Engine NP	GC083004	Outer Joint			26	25	56.5	84.5	61.5	O					
	1984.10-	1988.07				Saloon Engine NP	GC083006	Outer Joint	96T	26	25	56.5	84.5	61.5	O						
	1984.10-	1988.07	MT		F	Saloon Engine NP	GC083014	Outer Joint	45T	38	25	59.5	34.5	61	O						



		TRANSM	L/R	F/R		G-AP Ref.	PRODUCT	ABS	Technical Specifications								
									YEAR	A	B	C	H	L	P		
<b>AUDI</b>																	
<b>100 (44, 44Q, C3)</b>																	
1.8 Quattro (66 kW)	1984.10-	1988.07	MT/AT		R	Saloon Engine NP	GC083014	Outer Joint	45T	38	25	59.5	34.5	61	O		
1.8 Quattro CAT (66 kW)	1985.08-	1990.11	MT		F	Saloon Engine 4B/PH	GC083014	Outer Joint	45T	38	25	59.5	34.5	61	O		
	1985.08-	1990.11	MT		R	Saloon Engine 4B/PH	GC083014	Outer Joint	45T	38	25	59.5	34.5	61	O		
1.9 (74 kW)	1982.08-	1984.07	MT		F	Saloon Engine WH	GC083004	Outer Joint		26	25	56.5	84.5	61.5	O		
2.0 (83 kW)	1986.08-	1987.11	MT/AT		F	Saloon Engine SL	GC083004	Outer Joint		26	25	56.5	84.5	61.5	O		
	1986.08-	1987.11	MT/AT		F	Saloon Engine SL	GC083006	Outer Joint	96T	26	25	56.5	84.5	61.5	O		
2.0 (85 kW)	1984.08-	1987.12	MT/AT		F	Saloon Engine KP	GC083004	Outer Joint		26	25	56.5	84.5	61.5	O		
	1984.08-	1987.12	MT/AT		F	Saloon Engine KP	GC083006	Outer Joint	96T	26	25	56.5	84.5	61.5	O		
2.0 CAT (85 kW)	1988.01-	1990.11	AT		F	Saloon Engine RT	GC083004	Outer Joint		26	25	56.5	84.5	61.5	O		
	1988.01-	1990.11	MT		F	Saloon Engine RT	GC083013	Outer Joint		38	25	59.5	34.5	61	O		
	1988.01-	1990.11	MT		F	Saloon Engine RT	GC083014	Outer Joint	45T	38	25	59.5	34.5	61	O		
	1988.01-	1990.11	AT		F	Saloon Engine RT	GC083005	Outer Joint	45T	26	25	56.5	84.5	61.5	O		
2.0 D (51 kW)	1982.08-	1988.07	MT/AT		F	Saloon Engine CN	GC083004	Outer Joint		26	25	56.5	84.5	61.5	O		
	1982.08-	1988.07	MT		F	Saloon Engine CN	GC083013	Outer Joint		38	25	59.5	34.5	61	O		
	1982.08-	1988.07	MT&AT		F	Saloon Engine CN	GC083006	Outer Joint	96T	26	25	56.5	84.5	61.5	O		
	1982.08-	1988.07	MT		F	Saloon Engine CN	GC083014	Outer Joint	45T	38	25	59.5	34.5	61	O		
	1982.08-	1988.07	AT		F	Saloon Engine CN	GC083005	Outer Joint	45T	26	25	56.5	84.5	61.5	O		
2.0 D Turbo (64 kW)	1982.08-	1988.02	MT/AT		F	Saloon Engine DE	GC083004	Outer Joint		26	25	56.5	84.5	61.5	O		
	1982.08-	1988.02	MT/AT		F	Saloon Engine DE	GC083006	Outer Joint	96T	26	25	56.5	84.5	61.5	O		
2.0 D Turbo (74 kW)	1988.03-	1990.11	MT		F	Saloon Engine NC	GC083014	Outer Joint	45T	38	25	59.5	34.5	61	O		
	1988.03-	1990.11	MT		F	Saloon Engine NC	GC083013	Outer Joint		38	25	59.5	34.5	61	O		
2.1 (100 kW)	1982.08-	1984.07	MT/AT		F	Saloon Engine WC	GC083004	Outer Joint		26	25	56.5	84.5	61.5	O		
	1982.08-	1984.07	MT/AT		F	Saloon Engine WC	GC083006	Outer Joint	96T	26	25	56.5	84.5	61.5	O		
2.2 (101 kW)	1984.08-	1988.12	MT&AT		F	Saloon Engine KU	GC083004	Outer Joint		26	25	56.5	84.5	61.5	O		
	1984.08-	1988.12	MT		F	Saloon Engine KU	GC083013	Outer Joint		38	25	59.5	34.5	61	O		
	1984.08-	1988.12	MT&AT		F	Saloon Engine KU	GC083006	Outer Joint	96T	26	25	56.5	84.5	61.5	O		
	1984.08-	1988.12	MT		F	Saloon Engine KU	GC083014	Outer Joint	45T	38	25	59.5	34.5	61	O		
	1984.08-	1988.12	AT		F	Saloon Engine KU	GC083005	Outer Joint	45T	26	25	56.5	84.5	61.5	O		
2.2 (85 kW)	1984.10-	1986.09	MT/AT		F	Saloon Engine KZ	GC083004	Outer Joint		26	25	56.5	84.5	61.5	O		
	1984.10-	1986.09	MT/AT		F	Saloon Engine KZ	GC083006	Outer Joint	96T	26	25	56.5	84.5	61.5	O		
2.2 CAT (101 kW)	1989.06-	1990.11	MT		F	Saloon Engine HX/KU	GC083013	Outer Joint		38	25	59.5	34.5	61	O		
	1989.06-	1990.11	MT		F	Saloon Engine HX/KU	GC083014	Outer Joint	45T	38	25	59.5	34.5	61	O		
	1989.06-	1990.11	3AT		F	Saloon Engine HX/KU	GC083005	Outer Joint	45T	26	25	56.5	84.5	61.5	O		
2.2 E Quattro (88 kW)	1985.08-	1986.07				Saloon Engine PX	GC083004	Outer Joint		26	25	56.5	84.5	61.5	O		
	1985.08-	1986.07				Saloon Engine PX	GC083006	Outer Joint	96T	26	25	56.5	84.5	61.5	O		
2.2 E Turbo Quattro (121 kW)	1986.08-	1990.11	MT		R	Saloon Engine MC	GC083004	Outer Joint		26	25	56.5	84.5	61.5	O		
	1986.08-	1990.11	MT/AT		R	Saloon Engine MC	GC083006	Outer Joint	96T	26	25	56.5	84.5	61.5	O		
	1986.08-	1990.11	MT/AT		R	Saloon Engine MC	GC083014	Outer Joint	45T	38	25	59.5	34.5	61	O		
	1986.08-	1990.11	MT			Saloon Engine MC	GC083106	Outer Joint	45T	38	28	59.6	34.5	66.5	O		
2.2 Quattro (101 kW)	1984.08-	1988.12				Saloon Engine KU	GC083004	Outer Joint		26	25	56.5	84.5	61.5	O		
	1984.08-	1988.12				Saloon Engine KU	GC083006	Outer Joint	96T	26	25	56.5	84.5	61.5	O		
	1984.08-	1988.12	MT		F	Saloon Engine KU	GC083014	Outer Joint	45T	38	25	59.5	34.5	61	O		
	1984.08-	1988.12	MT/AT		R	Saloon Engine KU	GC083014	Outer Joint	45T	38	25	59.5	34.5	61	O		
2.2 Quattro CAT (101 kW)	1989.06-	1990.11	MT		F	Saloon Engine HX/KU	GC083014	Outer Joint	45T	38	25	59.5	34.5	61	O		
	1989.06-	1990.11	MT/AT		R	Saloon Engine HX/KU	GC083014	Outer Joint	45T	38	25	59.5	34.5	61	O		
2.2 Turbo (121 kW)	1986.08-	1990.11	MT		F	Saloon Engine MC	GC083106	Outer Joint	45T	38	28	59.6	34.5	66.5	O		
2.3 E (100 kW)	1986.10-	1990.11	MT&AT		F	Saloon Engine NF	GC083004	Outer Joint		26	25	56.5	84.5	61.5	O		
	1986.10-	1990.11	MT		F	Saloon Engine NF	GC083013	Outer Joint		38	25	59.5	34.5	61	O		
	1986.10-	1990.11	MT&AT		F	Saloon Engine NF	GC083006	Outer Joint	96T	26	25	56.5	84.5	61.5	O		
	1986.10-	1990.11	MT&4AT		F	Saloon Engine NF	GC083014	Outer Joint	45T	38	25	59.5	34.5	61	O		
	1986.10-	1990.11	AT/3AT		F	Saloon Engine NF	GC083005	Outer Joint	45T	26	25	56.5	84.5	61.5	O		
2.3 E (98 kW)	1990.01-	1990.11	AT		F	Saloon Engine AAR	GC083004	Outer Joint		26	25	56.5	84.5	61.5	O		
	1990.01-	1990.11	MT		F	Saloon Engine AAR	GC083013	Outer Joint		38	25	59.5	34.5	61	O		
	1990.01-	1990.11	MT&4AT		F	Saloon Engine AAR	GC083014	Outer Joint	45T	38	25	59.5	34.5	61	O		
	1990.01-	1990.11	3AT		F	Saloon Engine AAR	GC083005	Outer Joint	45T	26	25	56.5	84.5	61.5	O		
2.3 E Quattro (100 kW)	1986.08-	1990.11				Saloon Engine NF	GC083004	Outer Joint		26	25	56.5	84.5	61.5	O		
	1986.08-	1990.11				Saloon Engine NF	GC083006	Outer Joint	96T	26	25	56.5	84.5	61.5	O		
	1986.08-	1990.11	MT		F	Saloon Engine NF	GC083014	Outer Joint	45T	38	25	59.5	34.5	61	O		
	1986.08-	1990.11	MT/AT		R	Saloon Engine NF	GC083014	Outer Joint	45T	38	25	59.5	34.5	61	O		
2.3 Quattro (98 kW)	1990.01-	1990.11	MT		F	Saloon Engine AAR	GC083014	Outer Joint	45T	38	25	59.5	34.5	61	O		
2.4 D (60 kW)	1989.08-	1991.07	MT		F	Saloon Engine 3D	GC083013	Outer Joint		38	25	59.5	34.5	61	O		
	1989.08-	1991.07	MT		F	Saloon Engine 3D	GC083014	Outer Joint	45T	38	25	59.5	34.5	61	O		
2.5 TDi (88 kW)	1990.01-	1990.11	MT		F	Saloon Engine 1T	GC083106	Outer Joint	45T	38	28	59.6	34.5	66.5	O		





	 YEAR	TRANSM	L/R	F/R		G-AP Ref.	PRODUCT	ABS	Technical Specifications								
									A	B	C	H	L	P			
<b>AUDI</b>																	
<b>100 (4A, C4)</b>																	
2.0 (74 kW)	1990.12-	1994.06	MT/AT		F	Saloon Engine AAE	GC083016	Outer Joint	45T	38	30	59.5	34	61	I		
	1990.12-	1994.06			F	Saloon Engine AAE	GC083015	Outer Joint		38	30	59.5	34	61	I		
2.0 E (85 kW)	1990.12-	1994.06	MT/AT		F	Saloon Engine AAD/ABK	GC083016	Outer Joint	45T	38	30	59.5	34	61	I		
	1990.12-	1994.06			F	Saloon Engine AAD/ABK	GC083015	Outer Joint		38	30	59.5	34	61	I		
2.0 E 16V (103 kW)	1992.01-	1994.06	MT/AT		F	Saloon Engine ACE	GC083016	Outer Joint	45T	38	30	59.5	34	61	I		
2.0 E Quattro (85 kW)	1990.12-	1992.07	MT		F	Saloon Engine AAD	GC083016	Outer Joint	45T	38	30	59.5	34	61	I		
	1990.12-	1992.07	MT/AT		R	Saloon Engine AAD	GC083014	Outer Joint	45T	38	25	59.5	34.5	61	O		
2.2 S4 Turbo Quattro (169 kW)	1991.08-	1994.06	MT/AT		F	Saloon Engine AAN	GC083017	Outer Joint	45T	38	27	59.5	34.5	68.5	I		
2.3 E (98 kW)	1990.12-	1994.06	MT/AT		F	Saloon Engine AAR	GC083016	Outer Joint	45T	38	30	59.5	34	61	I		
	1990.12-	1994.06			F	Saloon Engine AAR	GC083015	Outer Joint		38	30	59.5	34	61	I		
2.3 E Quattro (98 kW)	1990.12-	1994.06	MT		F	Saloon Engine AAR	GC083016	Outer Joint	45T	38	30	59.5	34	61	I		
2.4 D (60 kW)	1990.12-	1994.06	MT/AT		F	Saloon Engine AAS	GC083016	Outer Joint	45T	38	30	59.5	34	61	I		
	1990.12-	1994.06			F	Saloon Engine AAS	GC083015	Outer Joint		38	30	59.5	34	61	I		
2.5 TDi (85 kW)	1990.12-	1994.06			F	Saloon Engine AAT/ABP	GC083056	Outer Joint		38	27	59.5	34.5	68.5	I		
	1990.12-	1994.06	MT		F	Saloon Engine AAT/ABP	GC083017	Outer Joint	45T	38	27	59.5	34.5	68.5	I		
	1990.12-	1994.06	MT	L	F	Saloon Engine AAT/ABP	GDS83050	Drive Shaft	45T	38		59.5	34.5	612			
	1990.12-	1994.06	MT	R	F	Saloon Engine AAT/ABP	GDS83051	Drive Shaft	45T	38		59.5	34.5	647			
2.6 (110 kW)	1992.03-	1994.06	MT/AT		F	Saloon Engine ABC	GC083016	Outer Joint	45T	38	30	59.5	34	61	I		
	1992.03-	1994.06			F	Saloon Engine ABC	GC083015	Outer Joint		38	30	59.5	34	61	I		
2.6 Quattro (110 kW)	1992.04-	1994.06	MT		F	Saloon Engine ABC	GC083016	Outer Joint	45T	38	30	59.5	34	61	I		
	1992.04-	1994.06	MT/AT		R	Saloon Engine ABC	GC083014	Outer Joint	45T	38	25	59.5	34.5	61	O		
2.8 E (128 kW)	1990.12-	1994.06	AT	L	F	Saloon Engine AAH	GDS83060	Drive Shaft	45T	38		59.5	34	565			
	1990.12-	1994.06	AT	R	F	Saloon Engine AAH	GDS83061	Drive Shaft	45T	38		59.5	34	488			
	1990.12-	1994.06			F	Saloon Engine AAH	GC083056	Outer Joint		38	27	59.5	34.5	68.5	I		
	1990.12-	1994.06	MT/AT		F	Saloon Engine AAH	GC083017	Outer Joint	45T	38	27	59.5	34.5	68.5	I		
	1990.12-	1994.06	AT	R	F	Saloon Engine AAH	GDS83050	Drive Shaft	45T	38		59.5	34.5	612			
	1990.12-	1994.06	MT	L	F	Saloon Engine AAH	GDS83050	Drive Shaft	45T	38		59.5	34.5	612			
	1990.12-	1994.06	MT	R	F	Saloon Engine AAH	GDS83051	Drive Shaft	45T	38		59.5	34.5	647			
2.8 E Quattro (128 kW)	1990.12-	1994.06				Saloon Engine AAH	GC083056	Outer Joint		38	27	59.5	34.5	68.5	I		
	1990.12-	1994.06	MT/AT		F	Saloon Engine AAH	GC083017	Outer Joint	45T	38	27	59.5	34.5	68.5	I		
	1990.12-	1994.06	MT/AT		R	Saloon Engine AAH	GC083014	Outer Joint	45T	38	25	59.5	34.5	61	O		
4.2 S4 V8 Quattro (206 kW)	1992.10-	1994.06	MT		F	Saloon Engine ABH	GC083017	Outer Joint	45T	38	27	59.5	34.5	68.5	I		
<b>100 AVANT (43, C2)</b>																	
1.6 (63 kW)	1977.07-	1983.02	MT/AT		F	Estate Engine YV	GC083004	Outer Joint		26	25	56.5	84.5	61.5	O		
1.9 (74 kW)	1980.08-	1982.07	MT		F	Estate Engine WH	GC083004	Outer Joint		26	25	56.5	84.5	61.5	O		
2.0 (85 kW)	1977.08-	1980.07			F	Estate Engine WA	GC083004	Outer Joint		26	25	56.5	84.5	61.5	O		
2.0 D (51 kW)	1978.08-	1983.02			F	Estate Engine CN	GC083004	Outer Joint		26	25	56.5	84.5	61.5	O		
2.1 (100 kW)	1977.07-	1983.02	MT/AT		F	Estate Engine WC/WG	GC083004	Outer Joint		26	25	56.5	84.5	61.5	O		
	1977.07-	1983.02	MT/AT		F	Estate Engine WC/WG	GC083006	Outer Joint	96T	26	25	56.5	84.5	61.5	O		
2.1 (85 kW)	1977.07-	1983.02	MT/AT		F	Estate Engine WB/WE	GC083004	Outer Joint		26	25	56.5	84.5	61.5	O		
	1977.07-	1983.02	MT/AT		F	Estate Engine WB/WE	GC083006	Outer Joint	96T	26	25	56.5	84.5	61.5	O		
<b>100 AVANT (44, 44Q, C3)</b>																	
1.8 (55 kW)	1982.08-	1987.12	MT/AT		F	Estate Engine DR/RS	GC083004	Outer Joint		26	25	56.5	84.5	61.5	O		
	1982.08-	1987.12	MT/AT		F	Estate Engine DR/RS	GC083006	Outer Joint	96T	26	25	56.5	84.5	61.5	O		
1.8 (65 kW)	1986.02-	1990.07	MT&AT		F	Estate Engine SH	GC083004	Outer Joint		26	25	56.5	84.5	61.5	O		
	1986.02-	1990.07	MT		F	Estate Engine SH	GC083013	Outer Joint		38	25	59.5	34.5	61	O		
	1986.02-	1990.07	MT&AT		F	Estate Engine SH	GC083006	Outer Joint	96T	26	25	56.5	84.5	61.5	O		
	1986.02-	1990.07	MT		F	Estate Engine SH	GC083014	Outer Joint	45T	38	25	59.5	34.5	61	O		
	1986.02-	1990.07	AT		F	Estate Engine SH	GC083005	Outer Joint	45T	26	25	56.5	84.5	61.5	O		
1.8 (66 kW)	1983.08-	1989.07	MT&AT		F	Estate Engine DS/NP	GC083004	Outer Joint		26	25	56.5	84.5	61.5	O		
	1983.08-	1989.07	MT		F	Estate Engine DS/NP	GC083013	Outer Joint		38	25	59.5	34.5	61	O		
	1983.08-	1989.07	MT&AT		F	Estate Engine DS/NP	GC083006	Outer Joint	96T	26	25	56.5	84.5	61.5	O		
	1983.08-	1989.07	MT		F	Estate Engine DS/NP	GC083014	Outer Joint	45T	38	25	59.5	34.5	61	O		
	1983.08-	1989.07	AT		F	Estate Engine DS/NP	GC083005	Outer Joint	45T	26	25	56.5	84.5	61.5	O		
1.8 CAT (66 kW)	1985.03-	1990.11	AT		F	Estate Engine 4B/PH	GC083004	Outer Joint		26	25	56.5	84.5	61.5	O		
	1985.03-	1990.11	MT		F	Estate Engine 4B/PH	GC083013	Outer Joint		38	25	59.5	34.5	61	O		
	1985.03-	1990.11	MT		F	Estate Engine 4B/PH	GC083014	Outer Joint	45T	38	25	59.5	34.5	61	O		
	1985.03-	1990.11	AT		F	Estate Engine 4B/PH	GC083005	Outer Joint	45T	26	25	56.5	84.5	61.5	O		
1.8 Quattro (65 kW)	1986.08-	1990.07				Estate Engine SH	GC083004	Outer Joint		26	25	56.5	84.5	61.5	O		
	1986.08-	1990.07				Estate Engine SH	GC083006	Outer Joint	96T	26	25	56.5	84.5	61.5	O		
	1986.08-	1990.07	MT		F	Estate Engine SH	GC083014	Outer Joint	45T	38	25	59.5	34.5	61	O		
	1986.08-	1990.07	MT/AT		R	Estate Engine SH	GC083014	Outer Joint	45T	38	25	59.5	34.5	61	O		



		TRANSM	L/R	F/R		G-AP Ref.	PRODUCT	ABS	Technical Specifications							
									YEAR	A	B	C	H	L	P	
<b>AUDI</b>																
<b>100 AVANT (44, 44Q, C3)</b>																
1.8 Quattro (66 kW)	1984.10-	1988.07				Estate Engine JW/NP	GC083004	Outer Joint		26	25	56.5	84.5	61.5	O	
	1984.10-	1988.07				Estate Engine JW/NP	GC083006	Outer Joint	96T	26	25	56.5	84.5	61.5	O	
	1984.10-	1988.07	MT		F	Estate Engine JW/NP	GC083014	Outer Joint	45T	38	25	59.5	34.5	61	O	
	1984.10-	1988.07	MT/AT		R	Estate Engine JW/NP	GC083014	Outer Joint	45T	38	25	59.5	34.5	61	O	
1.8 Quattro CAT (66 kW)	1985.08-	1990.10	MT		F	Estate Engine 4B/PH	GC083014	Outer Joint	45T	38	25	59.5	34.5	61	O	
	1985.08-	1990.10	MT		R	Estate Engine 4B/PH	GC083014	Outer Joint	45T	38	25	59.5	34.5	61	O	
1.9 (74 kW)	1983.02-	1984.07	MT		F	Estate Engine WH	GC083004	Outer Joint		26	25	56.5	84.5	61.5	O	
2.0 (83 kW)	1986.09-	1987.11	MT/AT		F	Estate Engine SL	GC083004	Outer Joint		26	25	56.5	84.5	61.5	O	
	1986.09-	1987.11	MT/AT		F	Estate Engine SL	GC083006	Outer Joint	96T	26	25	56.5	84.5	61.5	O	
2.0 D (51 kW)	1983.03-	1990.11	MT&AT		F	Estate Engine CN	GC083004	Outer Joint		26	25	56.5	84.5	61.5	O	
	1983.03-	1990.11	MT		F	Estate Engine CN	GC083013	Outer Joint		38	25	59.5	34.5	61	O	
	1983.03-	1990.11	MT&AT		F	Estate Engine CN	GC083006	Outer Joint	96T	26	25	56.5	84.5	61.5	O	
	1983.03-	1990.11	MT		F	Estate Engine CN	GC083014	Outer Joint	45T	38	25	59.5	34.5	61	O	
	1983.03-	1990.11	AT		F	Estate Engine CN	GC083005	Outer Joint	45T	26	25	56.5	84.5	61.5	O	
2.0 E (85 kW)	1985.01-	1987.12	MT/AT		F	Estate Engine KP	GC083004	Outer Joint		26	25	56.5	84.5	61.5	O	
	1985.01-	1987.12	MT/AT		F	Estate Engine KP	GC083006	Outer Joint	96T	26	25	56.5	84.5	61.5	O	
2.0 E CAT (85 kW)	1988.01-	1990.11	AT		F	Estate Engine RT	GC083004	Outer Joint		26	25	56.5	84.5	61.5	O	
	1988.01-	1990.11	MT		F	Estate Engine RT	GC083013	Outer Joint		38	25	59.5	34.5	61	O	
	1988.01-	1990.11	MT		F	Estate Engine RT	GC083014	Outer Joint	45T	38	25	59.5	34.5	61	O	
	1988.01-	1990.11	AT		F	Estate Engine RT	GC083005	Outer Joint	45T	26	25	56.5	84.5	61.5	O	
2.0 TD (64 kW)	1983.03-	1987.10	MT/AT		F	Estate Engine DE	GC083004	Outer Joint		26	25	56.5	84.5	61.5	O	
	1983.03-	1987.10	MT/AT		F	Estate Engine DE	GC083006	Outer Joint	96T	26	25	56.5	84.5	61.5	O	
2.0 TD (74 kW)	1988.03-	1990.11	MT		F	Estate Engine NC	GC083013	Outer Joint		38	25	59.5	34.5	61	O	
	1988.03-	1990.11	MT		F	Estate Engine NC	GC083014	Outer Joint	45T	38	25	59.5	34.5	61	O	
2.1 (100 kW)	1982.08-	1984.07	MT/AT		F	Estate Engine WC	GC083004	Outer Joint		26	25	56.5	84.5	61.5	O	
	1982.08-	1984.07	MT/AT		F	Estate Engine WC	GC083006	Outer Joint	96T	26	25	56.5	84.5	61.5	O	
2.2 (101 kW)	1984.08-	1988.12	MT&AT		F	Estate Engine KU	GC083004	Outer Joint		26	25	56.5	84.5	61.5	O	
	1984.08-	1988.12	MT		F	Estate Engine KU	GC083013	Outer Joint		38	25	59.5	34.5	61	O	
	1984.08-	1988.12	MT&AT		F	Estate Engine KU	GC083006	Outer Joint	96T	26	25	56.5	84.5	61.5	O	
	1984.08-	1988.12	MT		F	Estate Engine KU	GC083014	Outer Joint	45T	38	25	59.5	34.5	61	O	
	1984.08-	1988.12	AT		F	Estate Engine KU	GC083005	Outer Joint	45T	26	25	56.5	84.5	61.5	O	
2.2 (85 kW)	1984.10-	1986.09	MT/AT		F	Estate Engine KZ	GC083004	Outer Joint		26	25	56.5	84.5	61.5	O	
	1984.10-	1986.09	MT/AT		F	Estate Engine KZ	GC083006	Outer Joint	96T	26	25	56.5	84.5	61.5	O	
2.2 CAT (101 kW)	1989.06-	1990.11	MT		F	Estate Engine HX/KU	GC083013	Outer Joint		38	25	59.5	34.5	61	O	
	1989.06-	1990.11	MT&4AT		F	Estate Engine HX/KU	GC083014	Outer Joint	45T	38	25	59.5	34.5	61	O	
	1989.06-	1990.11	3AT		F	Estate Engine HX/KU	GC083005	Outer Joint	45T	26	25	56.5	84.5	61.5	O	
2.2 E Quattro (88 kW)	1985.08-	1986.07				Estate Engine PX	GC083004	Outer Joint		26	25	56.5	84.5	61.5	O	
	1985.08-	1986.07				Estate Engine PX	GC083006	Outer Joint	96T	26	25	56.5	84.5	61.5	O	
2.2 Quattro (101 kW)	1984.08-	1988.12				Estate Engine KU	GC083004	Outer Joint		26	25	56.5	84.5	61.5	O	
	1984.08-	1988.12				Estate Engine KU	GC083006	Outer Joint	96T	26	25	56.5	84.5	61.5	O	
	1984.08-	1988.12	MT		F	Estate Engine KU	GC083014	Outer Joint	45T	38	25	59.5	34.5	61	O	
	1984.08-	1988.12	MT/AT		R	Estate Engine KU	GC083014	Outer Joint	45T	38	25	59.5	34.5	61	O	
2.2 Quattro CAT (101 kW)	1989.06-	1990.11	MT		F	Estate Engine HX/KU	GC083014	Outer Joint	45T	38	25	59.5	34.5	61	O	
	1989.06-	1990.11	MT/AT		R	Estate Engine HX/KU	GC083014	Outer Joint	45T	38	25	59.5	34.5	61	O	
2.2 Turbo (121 kW)	1986.08-	1990.11	MT		F	Estate Engine MC	GC083106	Outer Joint	45T	38	28	59.6	34.5	66.5	O	
2.2 Turbo Quattro (121 kW)	1986.08-	1990.11	MT/AT		R	Estate Engine MC	GC083004	Outer Joint		26	25	56.5	84.5	61.5	O	
	1986.08-	1990.11	MT/AT		R	Estate Engine MC	GC083006	Outer Joint	96T	26	25	56.5	84.5	61.5	O	
	1986.08-	1990.11	MT/AT		R	Estate Engine MC	GC083014	Outer Joint	45T	38	25	59.5	34.5	61	O	
	1986.08-	1990.11	MT			Estate Engine MC	GC083106	Outer Joint	45T	38	28	59.6	34.5	66.5	O	
2.3 (100 kW)	1986.08-	1990.11	MT/AT		F	Estate Engine NF	GC083004	Outer Joint		26	25	56.5	84.5	61.5	O	
	1986.08-	1990.11	MT		F	Estate Engine NF	GC083013	Outer Joint		38	25	59.5	34.5	61	O	
	1986.08-	1990.11	MT&AT		F	Estate Engine NF	GC083006	Outer Joint	96T	26	25	56.5	84.5	61.5	O	
	1986.08-	1990.11	MT&4AT		F	Estate Engine NF	GC083014	Outer Joint	45T	38	25	59.5	34.5	61	O	
	1986.08-	1990.11	AT/3AT		F	Estate Engine NF	GC083005	Outer Joint	45T	26	25	56.5	84.5	61.5	O	
2.3 (98 kW)	1990.03-	1990.11	AT		F	Estate Engine AAR	GC083004	Outer Joint		26	25	56.5	84.5	61.5	O	
	1990.03-	1990.11	MT		F	Estate Engine AAR	GC083013	Outer Joint		38	25	59.5	34.5	61	O	
	1990.03-	1990.11	MT&4AT		F	Estate Engine AAR	GC083014	Outer Joint	45T	38	25	59.5	34.5	61	O	
	1990.03-	1990.11	3AT		F	Estate Engine AAR	GC083005	Outer Joint	45T	26	25	56.5	84.5	61.5	O	
2.3 E Quattro (100 kW)	1986.08-	1990.11				Estate Engine NF	GC083004	Outer Joint		26	25	56.5	84.5	61.5	O	
	1986.08-	1990.11				Estate Engine NF	GC083006	Outer Joint	96T	26	25	56.5	84.5	61.5	O	
	1986.08-	1990.11	MT		F	Estate Engine NF	GC083014	Outer Joint	45T	38	25	59.5	34.5	61	O	
	1986.08-	1990.11	MT/AT		R	Estate Engine NF	GC083014	Outer Joint	45T	38	25	59.5	34.5	61	O	





		TRANSM	L/R	F/R		G-AP Ref.	PRODUCT	ABS	Technical Specifications															
									YEAR	A	B	C	H	L	P									
<b>AUDI</b>																								
<b>100 AVANT (44, 44Q, C3)</b>																								
2.3 Quattro (98 kW)	1990.01-	1990.11	MT		F	Estate Engine AAR	GC083014	Outer Joint	45T	38	25	59.5	34.5	61	O									
2.4 D (60 kW)	1989.08-	1990.11	MT		F	Estate Engine 3D	GC083013	Outer Joint		38	25	59.5	34.5	61	O									
	1989.08-	1990.11	MT		F	Estate Engine 3D	GC083014	Outer Joint	45T	38	25	59.5	34.5	61	O									
2.5 TDi (88 kW)	1990.01-	1990.11	MT		F	Estate Engine 1T	GC083106	Outer Joint	45T	38	28	59.6	34.5	66.5	O									
<b>100 AVANT (4A, C4)</b>																								
2.0 E (74 kW)	1991.09-	1994.06	MT/AT		F	Estate Engine AAE	GC083016	Outer Joint	45T	38	30	59.5	34	61	I									
2.0 E (85 kW)	1991.09-	1994.06	MT/AT		F	Estate Engine AAD/ABK	GC083016	Outer Joint	45T	38	30	59.5	34	61	I									
2.0 E Quattro (85 kW)	1990.12-	1992.07	MT		F	Estate Engine AAD	GC083016	Outer Joint	45T	38	30	59.5	34	61	I									
	1990.12-	1992.07	MT/AT		R	Estate Engine AAD	GC083014	Outer Joint	45T	38	25	59.5	34.5	61	O									
2.2 S4 Turbo Quattro (169 kW)	1991.09-	1994.06	MT/AT		F	Estate Engine AAN	GC083017	Outer Joint	45T	38	27	59.5	34.5	68.5	I									
2.3 E (98 kW)	1991.09-	1994.06	MT/AT		F	Estate Engine AAR	GC083016	Outer Joint	45T	38	30	59.5	34	61	I									
2.3 E Quattro (98 kW)	1991.09-	1994.06	MT		F	Estate Engine AAR	GC083016	Outer Joint	45T	38	30	59.5	34	61	I									
2.4 D (60 kW)	1990.12-	1994.06	MT/AT		F	Estate Engine AAS	GC083016	Outer Joint	45T	38	30	59.5	34	61	I									
	1990.12-	1994.06			F	Estate Engine AAT/ABP	GC083056	Outer Joint		38	27	59.5	34.5	68.5	I									
2.5 TDi (85 kW)	1990.12-	1994.06	MT		F	Estate Engine AAT/ABP	GC083017	Outer Joint	45T	38	27	59.5	34.5	68.5	I									
	1990.12-	1994.06	MT	L	F	Estate Engine AAT/ABP	GDS83050	Drive Shaft	45T	38		59.5	34.5	612										
	1990.12-	1994.06	MT	R	F	Estate Engine AAT/ABP	GDS83051	Drive Shaft	45T	38		59.5	34.5	647										
2.6 (110 kW)	1992.03-	1994.06	MT/AT		F	Estate Engine ABC	GC083016	Outer Joint	45T	38	30	59.5	34	61	I									
2.6 Quattro (110 kW)	1992.07-	1994.06	MT		F	Estate Engine ABC	GC083016	Outer Joint	45T	38	30	59.5	34	61	I									
	1992.07-	1994.06	MT/AT		R	Estate Engine ABC	GC083014	Outer Joint	45T	38	25	59.5	34.5	61	O									
2.8 E (128 kW)	1991.09-	1994.06	AT	L	F	Estate Engine AAH	GDS83060	Drive Shaft	45T	38		59.5	34	565										
	1991.09-	1994.06	AT	R	F	Estate Engine AAH	GDS83061	Drive Shaft	45T	38		59.5	34	488										
	1991.09-	1994.06			F	Estate Engine AAH	GC083056	Outer Joint		38	27	59.5	34.5	68.5	I									
	1991.09-	1994.06	MT/AT		F	Estate Engine AAH	GC083017	Outer Joint	45T	38	27	59.5	34.5	68.5	I									
	1991.09-	1994.06	AT	R	F	Estate Engine AAH	GDS83050	Drive Shaft	45T	38		59.5	34.5	612										
	1991.09-	1994.06	MT	L	F	Estate Engine AAH	GDS83050	Drive Shaft	45T	38		59.5	34.5	612										
2.8 E Quattro (128 kW)	1991.09-	1994.06			F	Estate Engine AAH	GDS83051	Drive Shaft	45T	38		59.5	34.5	647										
	1991.09-	1994.06			F	Estate Engine AAH	GC083056	Outer Joint		38	27	59.5	34.5	68.5	I									
	1991.09-	1994.06	MT/AT		F	Estate Engine AAH	GC083017	Outer Joint	45T	38	27	59.5	34.5	68.5	I									
4.2 S4 V8 Quattro (206 kW)	1991.09-	1994.06	MT/AT		R	Estate Engine AAH	GC083014	Outer Joint	45T	38	25	59.5	34.5	61	O									
	1992.10-	1994.06	MT		F	Estate Engine ABH	GC083017	Outer Joint	45T	38	27	59.5	34.5	68.5	I									
<b>200 (43)</b>																								
2.1 5 E (100 kW)	1979.10-	1982.09	MT/AT		F	Saloon Engine WC	GC083004	Outer Joint		26	25	56.5	84.5	61.5	O									
	1979.10-	1982.09	MT/AT		F	Saloon Engine WC	GC083006	Outer Joint	96T	26	25	56.5	84.5	61.5	O									
<b>200 (44, 44Q)</b>																								
2.1 5 E (100 kW)	1983.08-	1984.07	MT/AT		F	Saloon Engine WC	GC083004	Outer Joint		26	25	56.5	84.5	61.5	O									
	1983.08-	1984.07	MT/AT		F	Saloon Engine WC	GC083006	Outer Joint	96T	26	25	56.5	84.5	61.5	O									
2.1 Turbo Quattro (134 kW)	1983.08-	1986.09	MT/AT		R	Saloon Engine KG	GC083004	Outer Joint		26	25	56.5	84.5	61.5	O									
	1983.08-	1986.09	MT/AT		R	Saloon Engine KG	GC083006	Outer Joint	96T	26	25	56.5	84.5	61.5	O									
2.2 (101 kW)	1984.08-	1985.07	MT/AT		F	Saloon Engine KU	GC083004	Outer Joint		26	25	56.5	84.5	61.5	O									
	1984.08-	1985.07	MT/AT		F	Saloon Engine KU	GC083006	Outer Joint	96T	26	25	56.5	84.5	61.5	O									
2.2 20V Turbo Quattro (162 kW)	1989.03-	1990.12	MT/AT		R	Saloon Engine 3B	GC083014	Outer Joint	45T	38	25	59.5	34.5	61	O									
	1989.03-	1990.12	MT			Saloon Engine 3B	GC083106	Outer Joint	45T	38	28	59.6	34.5	66.5	O									
2.2 Turbo (121 kW)	1985.08-	1991.09	MT		F	Saloon Engine MC	GC083106	Outer Joint	45T	38	28	59.6	34.5	66.5	O									
2.2 Turbo (147 kW)	1988.02-	1990.12	MT		F	Saloon Engine 1B	GC083106	Outer Joint	45T	38	28	59.6	34.5	66.5	O									
2.2 Turbo Quattro (121 kW)	1985.01-	1991.12	MT/AT		R	Saloon Engine MC	GC083014	Outer Joint	45T	38	25	59.5	34.5	61	O									
	1985.01-	1991.12	MT			Saloon Engine MC	GC083106	Outer Joint	45T	38	28	59.6	34.5	66.5	O									
2.2 Turbo Quattro (147 kW)	1988.02-	1990.11	MT/AT		R	Saloon Engine 1B	GC083014	Outer Joint	45T	38	25	59.5	34.5	61	O									
	1988.02-	1990.11	MT			Saloon Engine 1B	GC083106	Outer Joint	45T	38	28	59.6	34.5	66.5	O									
<b>200 AVANT (44, 44Q)</b>																								
2.1 Turbo Quattro (134 kW)	1983.09-	1988.01	MT/AT		R	Estate Engine KG/JY	GC083004	Outer Joint		26	25	56.5	84.5	61.5	O									
	1983.09-	1988.01	MT/AT		R	Estate Engine KG/JY	GC083006	Outer Joint	96T	26	25	56.5	84.5	61.5	O									
2.2 20V Turbo Quattro (162 kW)	1989.07-	1990.12	MT/AT		R	Estate Engine 3B	GC083014	Outer Joint	45T	38	25	59.5	34.5	61	O									
	1989.07-	1990.12	MT			Estate Engine 3B	GC083106	Outer Joint	45T	38	28	59.6	34.5	66.5	O									
2.2 Turbo (121 kW)	1985.08-	1991.09	MT		F	Estate Engine MC	GC083106	Outer Joint	45T	38	28	59.6	34.5	66.5	O									
2.2 Turbo Quattro (121 kW)	1983.09-	1990.12	MT/AT		R	Estate Engine MC	GC083014	Outer Joint	45T	38	25	59.5	34.5	61	O									
	1983.09-	1990.12	MT			Estate Engine MC	GC083106	Outer Joint	45T	38	28	59.6	34.5	66.5	O									
2.2 Turbo Quattro (147 kW)	1988.02-	1991.12	MT/AT		R	Estate Engine 1B	GC083014	Outer Joint	45T	38	25	59.5	34.5	61	O									
	1988.02-	1991.12	MT			Estate Engine 1B	GC083106	Outer Joint	45T	38	28	59.6	34.5	66.5	O									
<b>80 (80, 82, B1)</b>																								
1.3 (44 kW)	1972.05-	1978.07			F	Saloon Engine ZF	GC083038	Outer Joint		22	30	51	78.7	51.1	O									
1.6 (63 kW)	1975.09-	1978.07			F	Saloon Engine YP	GC083038	Outer Joint		22	30	51	78.7	51.1	O									









		TRANSM	L/R	F/R		G-AP Ref.	PRODUCT	ABS	Technical Specifications								
									YEAR	A	B	C	H	L	P		
<b>AUDI</b>																	
<b>80 (80, 82, B1)</b>																	
1.6 GT (74 kW)	1973.09-	1976.07			F Saloon Engine XX	GC083038	Outer Joint		22	30	51	78.7	51.1	O			
1.6 GTE (81 kW)	1976.01-	1978.07			F Saloon Engine YS	GC083038	Outer Joint		22	30	51	78.7	51.1	O			
<b>80 (81, 85, B2)</b>																	
1.3 (40 kW)	1978.09-	1981.07	MT		F Saloon Engine FY	GC083038	Outer Joint		22	30	51	78.7	51.1	O			
1.3 (44 kW)	1978.09-	1986.07	MT		F Saloon Engine EP	GC083038	Outer Joint		22	30	51	78.7	51.1	O			
1.6 (55 kW)	1978.08-	1986.07	MT		F Saloon Engine DT	GC083038	Outer Joint		22	30	51	78.7	51.1	O			
	1978.08-	1986.07	MT		F Saloon Engine WV/YN	GC083038	Outer Joint		22	30	51	78.7	51.1	O			
1.6 (63 kW)	1978.08-	1983.02	MT		F Saloon Engine YP	GC083038	Outer Joint		22	30	51	78.7	51.1	O			
1.6 D (40 kW)	1980.08-	1986.08	MT/AT		F Saloon Engine CR/JK	GC083038	Outer Joint		22	30	51	78.7	51.1	O			
1.6 GLE (81 kW)	1979.01-	1986.12	MT		F Saloon Engine YZ	GC083038	Outer Joint		22	30	51	78.7	51.1	O			
1.8 (68 kW)	1983.08-	1986.08	MT		F Saloon Engine JN	GC083003	Outer Joint		26	28	56.5	84.5	66.5	O			
1.8 GTE (81 kW)	1985.08-	1986.07	MT		F Saloon Engine PV	GC083003	Outer Joint		26	28	56.5	84.5	66.5	O			
1.8 GTE (82 kW)	1984.10-	1986.08	MT		F Saloon Engine DZ	GC083003	Outer Joint		26	28	56.5	84.5	66.5	O			
	1985.03-	1986.08			Saloon Engine PV	GCI61007	Inner Joint			33		32					
1.8 GTE Quattro (81 kW)	1985.03-	1986.08	MT	R	Saloon Engine PV	GC083003	Outer Joint		26	28	56.5	84.5	66.5	O			
	1985.03-	1986.08	MT	R	Saloon Engine PV	GC083004	Outer Joint		26	25	56.5	84.5	61.5	O			
	1985.03-	1986.08	MT	R	Saloon Engine PV	GC083006	Outer Joint	96T	26	25	56.5	84.5	61.5	O			
1.8 GTE Quattro (82 kW)	1984.08-	1986.08	MT	R	Saloon Engine DZ	GC083003	Outer Joint		26	28	56.5	84.5	66.5	O			
	1984.08-	1986.08	MT	R	Saloon Engine DZ	GC083004	Outer Joint		26	25	56.5	84.5	61.5	O			
	1984.08-	1986.08	MT	R	Saloon Engine DZ	GC083006	Outer Joint	96T	26	25	56.5	84.5	61.5	O			
1.8 Quattro (66 kW)	1984.08-	1986.08			Saloon Engine NE/JV	GCI61007	Inner Joint			33		32					
	1984.08-	1986.08	MT	R	Saloon Engine NE/JV	GC083003	Outer Joint		26	28	56.5	84.5	66.5	O			
	1984.08-	1986.08	MT	R	Saloon Engine NE/JV	GC083004	Outer Joint		26	25	56.5	84.5	61.5	O			
	1984.08-	1986.08	MT	R	Saloon Engine NE/JV	GC083006	Outer Joint	96T	26	25	56.5	84.5	61.5	O			
1.8 Quattro (68 kW)	1985.08-	1986.08			Saloon Engine JN	GCI61007	Inner Joint			33		32					
	1985.08-	1986.08	MT	R	Saloon Engine JN	GC083003	Outer Joint		26	28	56.5	84.5	66.5	O			
	1985.08-	1986.08	MT	R	Saloon Engine JN	GC083004	Outer Joint		26	25	56.5	84.5	61.5	O			
	1985.08-	1986.08	MT	R	Saloon Engine JN	GC083006	Outer Joint	96T	26	25	56.5	84.5	61.5	O			
<b>80 (89, 89Q, 8A, B3)</b>																	
1.6 (51 kW)	1987.08-	1991.09	MT		F Saloon Engine PP	GC083023	Outer Joint	96T	22	30	51	78.7	51.1	I			
	1987.08-	1991.09	MT		F Saloon Engine PP	GC083008	Outer Joint		33	30	53	30.5	51.5	I			
	1987.08-	1991.09	MT		F Saloon Engine PP	GC083009	Outer Joint	45T	33	30	53	30.5	51.5	I			
1.6 (55 kW)	1986.09-	1991.08	MT		F Saloon Engine RN	GC083023	Outer Joint	96T	22	30	51	78.7	51.1	I			
	1986.09-	1991.08	MT		F Saloon Engine RN	GC083008	Outer Joint		33	30	53	30.5	51.5	I			
	1986.09-	1991.08	MT		F Saloon Engine RN	GC083009	Outer Joint	45T	33	30	53	30.5	51.5	I			
1.6 (75 kW)	1990.08-	1991.10	MT	L	F Saloon Engine ABB	GDS83059	Drive Shaft				53	31	586				
	1990.08-	1991.10	MT	L	F Saloon Engine ABB	GDS83003	Drive Shaft	45T	33		53	31	586				
	1990.08-	1991.10	MT/AT		F Saloon Engine ABB	GC083051	Outer Joint		33	30	53	30	61	I			
	1990.08-	1991.10	MT/AT		F Saloon Engine ABB	GCI83014	Inner Joint			33		32					
1.6 D (40 kW)	1986.09-	1991.08	MT		F Saloon Engine JK	GC083008	Outer Joint		33	30	53	30.5	51.5	I			
1.6 TD (59 kW)	1986.09-	1991.08	AT		F Saloon Engine RA/SB	GCI83014	Inner Joint			33		32					
	1986.09-	1991.08	MT		F Saloon Engine RA/SB	GC083008	Outer Joint		33	30	53	30.5	51.5	I			
	1986.09-	1991.08	MT		F Saloon Engine RA/SB	GC083009	Outer Joint	45T	33	30	53	30.5	51.5	I			
	1986.09-	1991.08	AT		F Saloon Engine RA/SB	GC083051	Outer Joint		33	30	53	30	61	I			
1.8 (55 kW)	1986.10-	1990.01			F Saloon Engine RU	GCI61007	Inner Joint			33		32					
	1986.10-	1990.01	MT		F Saloon Engine RU	GC083023	Outer Joint	96T	22	30	51	78.7	51.1	I			
	1986.10-	1990.01	AT		F Saloon Engine RU	GC083032	Outer Joint		22	30	51	78	61	I			
	1986.10-	1990.01	AT		F Saloon Engine RU	GC083034	Outer Joint	96T	22	30	51	78	61	I			
	1986.10-	1990.01	AT		F Saloon Engine RU	GCI83014	Inner Joint			33		32					
	1986.10-	1990.01	MT		F Saloon Engine RU	GC083008	Outer Joint		33	30	53	30.5	51.5	I			
	1986.10-	1990.01	MT		F Saloon Engine RU	GC083009	Outer Joint	45T	33	30	53	30.5	51.5	I			
	1986.10-	1990.01	AT		F Saloon Engine RU	GC083051	Outer Joint		33	30	53	30	61	I			
1.8 (83 kW)	1986.09-	1988.07	MT/AT		F Saloon Engine SD	GC083032	Outer Joint		22	30	51	78	61	I			
	1986.09-	1988.07	MT/AT		F Saloon Engine SD	GC083034	Outer Joint	96T	22	30	51	78	61	I			
	1986.09-	1988.07	MT/AT		F Saloon Engine SD	GCI83014	Inner Joint			33		32					
	1986.09-	1988.07	MT	L	F Saloon Engine SD	GDS83059	Drive Shaft		33		53	31	586				
	1986.09-	1988.07	MT	L	F Saloon Engine SD	GDS83003	Drive Shaft	45T	33		53	31	586				
	1986.09-	1988.07	MT/AT		F Saloon Engine SD	GC083051	Outer Joint		33	30	53	30	61	I			
1.8 E (82 kW)	1986.06-	1991.08	MT		F Saloon Engine DZ	GC083032	Outer Joint		22	30	51	78	61	I			
	1986.06-	1991.08	MT		F Saloon Engine DZ	GC083034	Outer Joint	96T	22	30	51	78	61	I			
	1986.06-	1991.08	MT		F Saloon Engine DZ	GCI83014	Inner Joint			33		32					
	1986.06-	1991.08	MT	L	F Saloon Engine DZ	GDS83059	Drive Shaft		33		53	31	586				



		TRANSM	L/R	F/R		G-AP Ref.	PRODUCT	ABS	Technical Specifications									
									YEAR	A	B	C	H	L	P			
<b>AUDI</b>																		
<b>80 (89, 89Q, 8A, B3)</b>																		
1.8 E (82 kW)	1986.06-	1991.08	MT	L	F	Saloon Engine DZ	GDS83003	Drive Shaft	45T	33		53	31	586				
	1986.06-	1991.08	MT		F	Saloon Engine DZ	GC083051	Outer Joint		33	30	53	30	61	I			
1.8 E Quattro (82 kW)	1986.09-	1991.08				Saloon Engine DZ	GCI161007	Inner Joint			33		32					
	1986.09-	1991.08	MT		F	Saloon Engine DZ	GC083032	Outer Joint		22	30	51	78	61	I			
	1986.09-	1991.08	MT		F	Saloon Engine DZ	GC083034	Outer Joint	96T	22	30	51	78	61	I			
	1986.09-	1991.08	MT		R	Saloon Engine DZ	GC083004	Outer Joint		26	25	56.5	84.5	61.5	O			
	1986.09-	1991.08	MT	L	F	Saloon Engine DZ	GDS83003	Drive Shaft	45T	33		53	31	586				
	1986.09-	1991.08	MT		R	Saloon Engine DZ	GC083006	Outer Joint	96T	26	25	56.5	84.5	61.5	O			
	1986.09-	1991.08	MT		F	Saloon Engine DZ	GC083009	Outer Joint	45T	33	30	53	30.5	51.5	I			
1.8 Quattro (83 kW)	1986.09-	1990.08				Saloon Engine SD	GCI161007	Inner Joint			33		32					
	1986.09-	1990.08	MT		F	Saloon Engine SD	GC083032	Outer Joint		22	30	51	78	61	I			
	1986.09-	1990.08	MT		F	Saloon Engine SD	GC083034	Outer Joint	96T	22	30	51	78	61	I			
	1986.09-	1990.08	MT		R	Saloon Engine SD	GC083004	Outer Joint		26	25	56.5	84.5	61.5	O			
	1986.09-	1990.08	MT	L	F	Saloon Engine SD	GDS83003	Drive Shaft	45T	33		53	31	586				
	1986.09-	1990.08	MT		R	Saloon Engine SD	GC083006	Outer Joint	96T	26	25	56.5	84.5	61.5	O			
	1986.09-	1990.08	MT		F	Saloon Engine SD	GC083009	Outer Joint	45T	33	30	53	30.5	51.5	I			
1.8 S (65 kW)	1986.09-	1990.12	MT		F	Saloon Engine SF	GC083023	Outer Joint	96T	22	30	51	78.7	51.1	I			
	1986.09-	1990.12	AT		F	Saloon Engine SF	GC083032	Outer Joint		22	30	51	78	61	I			
	1986.09-	1990.12	AT		F	Saloon Engine SF	GC083034	Outer Joint	96T	22	30	51	78	61	I			
	1986.09-	1990.12	AT		F	Saloon Engine SF	GCI83014	Inner Joint			33		32					
	1986.09-	1990.12	MT		F	Saloon Engine SF	GC083008	Outer Joint		33	30	53	30.5	51.5	I			
	1986.09-	1990.12	MT		F	Saloon Engine SF	GC083009	Outer Joint	45T	33	30	53	30.5	51.5	I			
	1986.09-	1990.12	AT		F	Saloon Engine SF	GC083051	Outer Joint		33	30	53	30	61	I			
1.8 S (66 kW)	1986.09-	1991.10	MT		F	Saloon Engine JN/NE/PM	GC083023	Outer Joint	96T	22	30	51	78.7	51.1	I			
	1986.09-	1991.10	AT		F	Saloon Engine JN/NE/PM	GC083032	Outer Joint		22	30	51	78	61	I			
	1986.09-	1991.10	AT		F	Saloon Engine JN/NE/PM	GC083034	Outer Joint	96T	22	30	51	78	61	I			
	1986.09-	1991.10	AT		F	Saloon Engine JN/NE/PM	GCI83014	Inner Joint			33		32					
	1986.09-	1991.10	MT		F	Saloon Engine JN/NE/PM	GC083008	Outer Joint		33	30	53	30.5	51.5	I			
	1986.09-	1991.10	MT		F	Saloon Engine JN/NE/PM	GC083009	Outer Joint	45T	33	30	53	30.5	51.5	I			
	1986.09-	1991.10	AT		F	Saloon Engine JN/NE/PM	GC083051	Outer Joint		33	30	53	30	61	I			
1.8 S Quattro (65 kW)	1986.09-	1990.07				Saloon Engine SF	GCI161007	Inner Joint			33		32					
	1986.09-	1990.07	MT		F	Saloon Engine SF	GC083032	Outer Joint		22	30	51	78	61	I			
	1986.09-	1990.07	MT		F	Saloon Engine SF	GC083034	Outer Joint	96T	22	30	51	78	61	I			
	1986.09-	1990.07	MT		R	Saloon Engine SF	GC083004	Outer Joint		26	25	56.5	84.5	61.5	O			
	1986.09-	1990.07	MT	L	F	Saloon Engine SF	GDS83003	Drive Shaft	45T	33		53	31	586				
	1986.09-	1990.07	MT		R	Saloon Engine SF	GC083006	Outer Joint	96T	26	25	56.5	84.5	61.5	O			
	1986.09-	1990.07	MT		F	Saloon Engine SF	GC083009	Outer Joint	45T	33	30	53	30.5	51.5	I			
1.8 S Quattro (66 kW)	1986.09-	1991.09				Saloon Engine JN/NE/PM	GCI161007	Inner Joint			33		32					
	1986.09-	1991.09	MT		F	Saloon Engine JN/NE/PM	GC083032	Outer Joint		22	30	51	78	61	I			
	1986.09-	1991.09	MT		F	Saloon Engine JN/NE/PM	GC083034	Outer Joint	96T	22	30	51	78	61	I			
	1986.09-	1991.09	MT		R	Saloon Engine JN/NE/PM	GC083004	Outer Joint		26	25	56.5	84.5	61.5	O			
	1986.09-	1991.09	MT	L	F	Saloon Engine JN/NE/PM	GDS83003	Drive Shaft	45T	33		53	31	586				
	1986.09-	1991.09	MT		R	Saloon Engine JN/NE/PM	GC083006	Outer Joint	96T	26	25	56.5	84.5	61.5	O			
	1986.09-	1991.09	MT		F	Saloon Engine JN/NE/PM	GC083009	Outer Joint	45T	33	30	53	30.5	51.5	I			
1.9 D (50 kW)	1989.08-	1991.08	MT		F	Saloon Engine 1Y	GC083008	Outer Joint		33	30	53	30.5	51.5	I			
	1989.08-	1991.08	MT		F	Saloon Engine 1Y	GC083009	Outer Joint	45T	33	30	53	30.5	51.5	I			
2.0 (82 kW)	1990.10-	1991.08			F	Saloon Engine AAD	GCI161007	Inner Joint			33		32					
	1990.10-	1991.08	AT		F	Saloon Engine AAD	GCI83014	Inner Joint			33		32					
	1990.10-	1991.08	MT	L	F	Saloon Engine AAD	GDS83059	Drive Shaft		33		53	31	586				
	1990.10-	1991.08	MT	L	F	Saloon Engine AAD	GDS83003	Drive Shaft	45T	33		53	31	586				
	1990.10-	1991.08	MT&AT		F	Saloon Engine AAD	GC083051	Outer Joint		33	30	53	30	61	I			
2.0 E (83 kW)	1988.08-	1990.10	MT&AT		F	Saloon Engine 3A	GCI83014	Inner Joint			33		32					
	1988.08-	1990.10	MT	L	F	Saloon Engine 3A	GDS83059	Drive Shaft		33		53	31	586				
	1988.08-	1990.10	MT	L	F	Saloon Engine 3A	GDS83003	Drive Shaft	45T	33		53	31	586				
	1988.08-	1990.10	MT&AT		F	Saloon Engine 3A	GC083051	Outer Joint		33	30	53	30	61	I			
2.0 E 16V (101 kW)	1990.03-	1991.09	MT	R	F	Saloon Engine 6A	GDS83044	Drive Shaft	45T	33		53	31	563				
	1990.03-	1991.09	MT		F	Saloon Engine 6A	GC083051	Outer Joint		33	30	53	30	61	I			
2.0 E 16V Quattro (101 kW)	1990.03-	1991.08				Saloon Engine 6A	GCI161007	Inner Joint			33		32					
	1990.03-	1991.08	MT	L	F	Saloon Engine 6A	GDS83003	Drive Shaft	45T	33		53	31	586				
2.0 E Quattro (83 kW)	1988.08-	1990.09				Saloon Engine 3A	GCI161007	Inner Joint			33		32					
	1988.08-	1990.09	MT	L	F	Saloon Engine 3A	GDS83003	Drive Shaft	45T	33		53	31	586				
	1988.08-	1990.09	MT		R	Saloon Engine 3A	GC083009	Outer Joint	45T	33	30	53	30.5	51.5	I			

		TRANSM	L/R	F/R		G-AP Ref.	PRODUCT	ABS	Technical Specifications								
									YEAR	A	B	C	H	L	P		
<b>AUDI</b>																	
<b>80 (89, 89Q, 8A, B3)</b>																	
2.0 Quattro (82 kW)	1988.08-1990.07	MT	L	F	Saloon Engine 3A	GDS83003	Drive Shaft	45T	33		53	31	586				
	1988.08-1990.07	MT		R	Saloon Engine 3A	GC083009	Outer Joint	45T	33	30	53	30.5	51.5	I			
2.0 Quattro (85 kW)	1990.10-1991.08				Saloon Engine AAD	GC161007	Inner Joint			33		32					
	1990.10-1991.08	MT	L	F	Saloon Engine AAD	GDS83003	Drive Shaft	45T	33		53	31	586				
	1990.10-1991.08	MT		R	Saloon Engine AAD	GC083009	Outer Joint	45T	33	30	53	30.5	51.5	I			
<b>80 (8C, B4)</b>																	
1.6 (52 kW)	1991.09-1994.12			F	Saloon Engine ABM	GC161007	Inner Joint			33		32					
	1991.09-1994.12	MT		F	Saloon Engine ABM	GC183014	Inner Joint			33		32					
	1991.09-1994.12	MT	L	F	Saloon Engine ABM	GDS83059	Drive Shaft		33		53	31	586				
	1991.09-1994.12	MT	L	F	Saloon Engine ABM	GDS83003	Drive Shaft	45T	33		53	31	586				
	1991.09-1994.12	MT		F	Saloon Engine ABM	GC083051	Outer Joint		33	30	53	30	61	I			
1.6 E (74 kW)	1993.06-1994.12			F	Saloon Engine ADA	GC161007	Inner Joint			33		32					
	1993.06-1994.12	MT		F	Saloon Engine ADA	GC183014	Inner Joint			33		32					
	1993.06-1994.12	MT	L	F	Saloon Engine ADA	GDS83003	Drive Shaft	45T	33		53	31	586				
1.9 TD (55 kW)	1991.09-1994.12	MT		F	Saloon Engine AAZ	GC183014	Inner Joint			33		32					
	1991.09-1994.12	MT	L	F	Saloon Engine AAZ	GDS83059	Drive Shaft		33		53	31	586				
	1991.09-1994.12	MT	L	F	Saloon Engine AAZ	GDS83003	Drive Shaft	45T	33		53	31	586				
	1991.09-1994.12	MT/AT		F	Saloon Engine AAZ	GC083051	Outer Joint		33	30	53	30	61	I			
2.0 (66 kW)	1991.09-1994.12	MT		F	Saloon Engine ABT	GC183014	Inner Joint			33		32					
	1991.09-1994.12	MT	L	F	Saloon Engine ABT	GDS83059	Drive Shaft		33		53	31	586				
	1991.09-1994.12	MT	L	F	Saloon Engine ABT	GDS83003	Drive Shaft	45T	33		53	31	586				
	1991.09-1994.12	MT/4AT		F	Saloon Engine ABT	GC083051	Outer Joint		33	30	53	30	61	I			
2.0 E (85 kW)	1991.09-1994.12			F	Saloon Engine ABK	GC161007	Inner Joint			33		32					
	1991.09-1994.12	MT		F	Saloon Engine ABK	GC183014	Inner Joint			33		32					
	1991.09-1994.12	MT	L	F	Saloon Engine ABK	GDS83059	Drive Shaft		33		53	31	586				
	1991.09-1994.12	MT	L	F	Saloon Engine ABK	GDS83003	Drive Shaft	45T	33		53	31	586				
	1991.09-1994.12	MT/4AT		F	Saloon Engine ABK	GC083051	Outer Joint		33	30	53	30	61	I			
2.0 E 16V (103 kW)	1992.08-1994.12	MT	R	F	Saloon Engine ACE	GDS83044	Drive Shaft	45T	33		53	31	563				
	1992.08-1994.12	MT/4AT		F	Saloon Engine ACE	GC083051	Outer Joint		33	30	53	30	61	I			
2.0 E 16V Quattro (103 kW)	1992.04-1994.12	MT		F	Saloon Engine ACE	GC083016	Outer Joint	45T	38	30	59.5	34	61	I			
	1992.04-1994.12				Saloon Engine ACE	GC161007	Inner Joint			33		32					
	1992.04-1994.12	MT	L	F	Saloon Engine ACE	GDS83003	Drive Shaft	45T	33		53	31	586				
	1992.04-1994.12	MT	R	F	Saloon Engine ACE	GC083009	Outer Joint	45T	33	30	53	30.5	51.5	I			
2.0 E Quattro (85 kW)	1991.09-1994.12	MT		F	Saloon Engine ABK	GC083016	Outer Joint	45T	38	30	59.5	34	61	I			
	1991.09-1994.12	MT	L	F	Saloon Engine ABK	GDS83003	Drive Shaft	45T	33		53	31	586				
	1991.09-1994.12	MT		R	Saloon Engine ABK	GC083009	Outer Joint	45T	33	30	53	30.5	51.5	I			
2.2 S2 Quattro (169 kW)	1993.02-1994.12	MT		F	Saloon Engine ABY	GC083017	Outer Joint	45T	38	27	59.5	34.5	68.5	I			
	1993.02-1994.12	MT/AT		R	Saloon Engine ABY	GC083014	Outer Joint	45T	38	25	59.5	34.5	61	O			
2.3 E (98 kW)	1991.09-1994.12	MT	R	F	Saloon Engine NG	GDS83044	Drive Shaft	45T	33		53	31	563				
	1991.09-1994.12	MT/4AT		F	Saloon Engine NG	GC083051	Outer Joint		33	30	53	30	61	I			
2.3 E Quattro (98 kW)	1991.09-1994.12	MT		F	Saloon Engine NG	GC083016	Outer Joint	45T	38	30	59.5	34	61	I			
	1991.09-1994.12				Saloon Engine NG	GC161007	Inner Joint			33		32					
	1991.09-1994.12	MT	L	F	Saloon Engine NG	GDS83003	Drive Shaft	45T	33		53	31	586				
	1991.09-1994.12	MT		R	Saloon Engine NG	GC083009	Outer Joint	45T	33	30	53	30.5	51.5	I			
2.6 (110 kW)	1992.07-1994.12	MT/AT		F	Saloon Engine ABC	GC083017	Outer Joint	45T	38	27	59.5	34.5	68.5	I			
2.6 Quattro (110 kW)	1992.06-1994.12	MT		F	Saloon Engine ABC	GC083016	Outer Joint	45T	38	30	59.5	34	61	I			
	1992.06-1994.12				Saloon Engine ABC	GC161007	Inner Joint			33		32					
2.8 (128 kW)	1991.09-1994.12	MT/AT		F	Saloon Engine AAH	GC083017	Outer Joint	45T	38	27	59.5	34.5	68.5	I			
2.8 Quattro (128 kW)	1991.09-1994.12	MT		F	Saloon Engine AAH	GC083016	Outer Joint	45T	38	30	59.5	34	61	I			
	1991.09-1994.12				Saloon Engine AAH	GC161007	Inner Joint			33		32					
<b>80 AVANT (8C, B4)</b>																	
1.6 E (74 kW)	1993.06-1996.01	MT		F	Estate Engine ADA	GC183014	Inner Joint			33		32					
	1993.06-1996.01	MT	L	F	Estate Engine ADA	GDS83003	Drive Shaft	45T	33		53	31	586				
2.0 (66 kW)	1992.07-1996.01	MT		F	Estate Engine ABT	GC183014	Inner Joint			33		32					
	1992.07-1996.01	MT	L	F	Estate Engine ABT	GDS83059	Drive Shaft		33		53	31	586				
	1992.07-1996.01	MT	L	F	Estate Engine ABT	GDS83003	Drive Shaft	45T	33		53	31	586				
	1992.07-1996.01	MT&4AT		F	Estate Engine ABT	GC083051	Outer Joint		33	30	53	30	61	I			
2.0 E (85 kW)	1992.07-1996.01			F	Estate Engine ABK	GC161007	Inner Joint			33		32					
	1992.07-1996.01	MT		F	Estate Engine ABK	GC183014	Inner Joint			33		32					
	1992.07-1996.01	MT	L	F	Estate Engine ABK	GDS83059	Drive Shaft		33		53	31	586				
	1992.07-1996.01	MT	L	F	Estate Engine ABK	GDS83003	Drive Shaft	45T	33		53	31	586				
	1992.07-1996.01	MT&4AT		F	Estate Engine ABK	GC083051	Outer Joint		33	30	53	30	61	I			









		TRANSM	L/R	F/R		G-AP Ref.	PRODUCT	ABS	Technical Specifications								
									YEAR	A	B	C	H	L	P		
<b>AUDI</b>																	
<b>80 AVANT (8C, B4)</b>																	
2.0 E 16V (103 kW)	1993.02-	1996.01	MT	R	F	Estate Engine ACE	GDS83044	Drive Shaft	45T	33		53	31	563			
	1993.02-	1996.01	MT/4AT		F	Estate Engine ACE	GC083051	Outer Joint		33	30	53	30	61	I		
2.0 E 16V Quattro (103 kW)	1992.12-	1995.07	MT		F	Estate Engine ACE	GC083016	Outer Joint	45T	38	30	59.5	34	61	I		
	1992.12-	1995.07				Estate Engine ACE	GCI61007	Inner Joint			33		32				
	1992.12-	1995.07	MT	L	F	Estate Engine ACE	GDS83003	Drive Shaft	45T	33		53	31	586			
	1992.12-	1995.07	MT/AT		R	Estate Engine ACE	GC083014	Outer Joint	45T	38	25	59.5	34.5	61	O		
	1992.12-	1995.07	MT/AT		R	Estate Engine ACE	GC083014	Outer Joint	45T	38	25	59.5	34.5	61	O		
2.2 S2 Quattro (169 kW)	1993.02-	1995.07	MT		F	Estate Engine ABY	GC083017	Outer Joint	45T	38	27	59.5	34.5	68.5	I		
	1993.02-	1995.07	MT/AT		R	Estate Engine ABY	GC083014	Outer Joint	45T	38	25	59.5	34.5	61	O		
2.3 E (98 kW)	1992.07-	1996.01	MT	R	F	Estate Engine NG	GDS83044	Drive Shaft	45T	33		53	31	563			
	1992.07-	1996.01	MT/4AT		F	Estate Engine NG	GC083051	Outer Joint		33	30	53	30	61	I		
2.3 E Quattro (98 kW)	1991.09-	1994.11	MT		F	Estate Engine NG	GC083016	Outer Joint	45T	38	30	59.5	34	61	I		
	1991.09-	1994.11	MT	L	F	Estate Engine NG	GDS83003	Drive Shaft	45T	33		53	31	586			
	1991.09-	1994.11	MT/AT		R	Estate Engine NG	GC083014	Outer Joint	45T	38	25	59.5	34.5	61	O		
2.6 (110 kW)	1992.07-	1996.01	MT/AT		F	Estate Engine ABC	GC083017	Outer Joint	45T	38	27	59.5	34.5	68.5	I		
2.6 Quattro (110 kW)	1992.07-	1995.07	MT		F	Estate Engine ABC	GC083016	Outer Joint	45T	38	30	59.5	34	61	I		
	1992.07-	1995.07	MT/AT		R	Estate Engine ABC	GC083014	Outer Joint	45T	38	25	59.5	34.5	61	O		
2.8 (128 kW)	1991.09-	1996.01	MT/AT		F	Estate Engine AAH	GC083017	Outer Joint	45T	38	27	59.5	34.5	68.5	I		
2.8 Quattro (128 kW)	1992.08-	1995.07	MT		F	Estate Engine AAH	GC083016	Outer Joint	45T	38	30	59.5	34	61	I		
	1992.08-	1995.07	MT/AT		R	Estate Engine AAH	GC083014	Outer Joint	45T	38	25	59.5	34.5	61	O		
<b>80 III (89, 89Q, 8A, B3)</b>																	
2.0 E (83 kW)	1988.08-	2009.10				Ch-89J373599-8CP300000	GCI83013	Inner Joint			33		34				
<b>90 (81, 85, B2)</b>																	
2.0 (83 kW)	1986.03-	1987.03			F	Saloon Engine SK	GCI61007	Inner Joint			33		32				
2.0 (85 kW)	1984.10-	1987.03			F	Saloon Engine HP/JS	GCI61007	Inner Joint			33		32				
2.2 (100 kW)	1984.10-	1987.03	MT/AT		F	Saloon Engine KV	GC083031	Outer Joint		22	25	51	78	61	O		
	1984.10-	1987.03	MT/AT		F	Saloon Engine KV	GC083029	Outer Joint	96T	22	25	51	78	61	O		
2.2 (85 kW)	1985.01-	1987.03			F	Saloon Engine KX	GCI61007	Inner Joint			33		32				
2.2 E Quattro (100 kW)	1984.11-	1987.03	MT		R	Saloon Engine KV	GC083004	Outer Joint		26	25	56.5	84.5	61.5	O		
	1984.11-	1987.03	MT		R	Saloon Engine KV	GC083006	Outer Joint	96T	26	25	56.5	84.5	61.5	O		
<b>90 (89, 89Q, 8A, B3)</b>																	
1.6 TD (59 kW)	1987.04-	1991.09	AT		F	Saloon Engine RA/SB	GCI83014	Inner Joint			33		32				
	1987.04-	1991.09	MT		F	Saloon Engine RA/SB	GC083008	Outer Joint		33	30	53	30.5	51.5	I		
	1987.04-	1991.09	AT		F	Saloon Engine RA/SB	GC083051	Outer Joint		33	30	53	30	61	I		
2.0 (85 kW)	1988.07-	1991.09	MT&AT		F	Saloon Engine PS	GCI83014	Inner Joint			33		32				
	1988.07-	1991.09	MT	L	F	Saloon Engine PS	GDS83059	Drive Shaft		33		53	31	586			
	1988.07-	1991.09	MT	L	F	Saloon Engine PS	GDS83003	Drive Shaft	45T	33		53	31	586			
	1988.07-	1991.09	MT&AT		F	Saloon Engine PS	GC083051	Outer Joint		33	30	53	30	61	I		
2.0 20V (118 kW)	1989.08-	1991.07	MT	R	F	Saloon Engine NM	GDS83044	Drive Shaft	45T	33		53	31	563			
	1989.08-	1991.07	MT		F	Saloon Engine NM	GC083051	Outer Joint		33	30	53	30	61	I		
2.2 E (100 kW)	1987.04-	1991.07			F	Saloon Engine KV	GCI61007	Inner Joint			33		32				
	1987.04-	1991.07	MT/AT		F	Saloon Engine KV	GC083032	Outer Joint		22	30	51	78	61	I		
	1987.04-	1991.07	MT/AT		F	Saloon Engine KV	GC083034	Outer Joint	96T	22	30	51	78	61	I		
	1987.04-	1991.07	MT	R	F	Saloon Engine KV	GDS83044	Drive Shaft	45T	33		53	31	563			
	1987.04-	1991.07	MT/AT		F	Saloon Engine KV	GC083051	Outer Joint		33	30	53	30	61	I		
2.2 E Quattro (100 kW)	1987.04-	1991.09	MT		F	Saloon Engine KV	GC083032	Outer Joint		22	30	51	78	61	I		
	1987.04-	1991.09	MT	L	F	Saloon Engine KV	GDS83059	Drive Shaft		33		53	31	586			
	1987.04-	1991.09	MT	L	F	Saloon Engine KV	GDS83003	Drive Shaft	45T	33		53	31	586			
	1987.04-	1991.09	MT	R	F	Saloon Engine KV	GC083009	Outer Joint	45T	33	30	53	30.5	51.5	I		
	1987.04-	1991.09	MT		F	Saloon Engine KV	GC083051	Outer Joint		33	30	53	30	61	I		
	1987.04-	1991.09	MT/AT		F	Saloon Engine KV	GC083032	Outer Joint		22	30	51	78	61	I		
2.3 E (100 kW)	1987.04-	1991.07	MT/AT		F	Saloon Engine NG	GC083032	Outer Joint		22	30	51	78	61	I		
	1987.04-	1991.07	MT/AT		F	Saloon Engine NG	GC083034	Outer Joint	96T	22	30	51	78	61	I		
	1987.04-	1991.07	MT	R	F	Saloon Engine NG	GDS83044	Drive Shaft	45T	33		53	31	563			
	1987.04-	1991.07	MT/AT		F	Saloon Engine NG	GC083051	Outer Joint		33	30	53	30	61	I		
2.3 E (98 kW)	1987.04-	1991.09	MT	R	F	Saloon Engine NG	GDS83044	Drive Shaft	45T	33		53	31	563			
	1987.04-	1991.09	MT/AT		F	Saloon Engine NG	GC083051	Outer Joint		33	30	53	30	61	I		
2.3 E 20V (123 kW)	1990.04-	1991.07	MT		F	Saloon Engine 7A	GC083017	Outer Joint	45T	38	27	59.5	34.5	68.5	I		
2.3 E 20V (125 kW)	1988.08-	1991.07	MT		F	Saloon Engine 7A	GC083017	Outer Joint	45T	38	27	59.5	34.5	68.5	I		
2.3 E 20V Quattro (125 kW)	1988.06-	1991.09	MT		F	Saloon Engine 7A	GC083016	Outer Joint	45T	38	30	59.5	34	61	I		
	1988.06-	1991.09				Saloon Engine 7A	GCI61007	Inner Joint			33		32				
2.3 E Quattro (100 kW)	1987.04-	1991.07				Saloon Engine NG	GCI61007	Inner Joint			33		32				
	1987.04-	1991.07	MT		F	Saloon Engine NG	GC083032	Outer Joint		22	30	51	78	61	I		
	1987.04-	1991.07	MT	L	F	Saloon Engine NG	GDS83059	Drive Shaft		33		53	31	586			

	 YEAR	TRANSM	L/R	F/R		G-AP Ref.	PRODUCT	ABS	Technical Specifications								
									A	B	C	H	L	P			
<b>AUDI</b>																	
<b>90 (89, 89Q, 8A, B3)</b>																	
2.3 E Quattro (100 kW)	1987.04-	1991.07	MT	L	F	Saloon Engine NG	GDS83003	Drive Shaft	45T	33		53	31	586			
	1987.04-	1991.07	MT		R	Saloon Engine NG	GC083009	Outer Joint	45T	33	30	53	30.5	51.5	I		
	1987.04-	1991.07	MT		F	Saloon Engine NG	GC083051	Outer Joint		33	30	53	30	61	I		
2.3 E Quattro (98 kW)	1987.04-	1991.09	MT	L	F	Saloon Engine NG	GDS83003	Drive Shaft	45T	33		53	31	586			
	1987.04-	1991.09	MT		R	Saloon Engine NG	GC083009	Outer Joint	45T	33	30	53	30.5	51.5	I		
<b>A1 (8X1)</b>																	
1.4 TFSi (136 kW)	2011.01-	2012.04					GCI83016	Inner Joint			28		32				
1.6 TDi (66 kW)	2010.05-		AT			DOUBLE CLUTCH	GCI83016	Inner Joint			28		32				
1.6 TDi (77 kW)	2010.05-		AT			DOUBLE CLUTCH	GCI83016	Inner Joint			28		32				
2.0 TDi (105 kW)	2011.09-	2012.05	AT			DOUBLE CLUTCH	GCI83016	Inner Joint			28		32				
2.0 TFSi Quattro (188 kW)	2012.03-						GCI83016	Inner Joint			28		32				
<b>A1 (8X1, 8XA), SPORTBACK (8PA)</b>																	
1.4 TFSi (92 kW)		2011.05					GC083002	Outer Joint		36	27	59.5	40	66	I		
1.6 TDi (77 kW)		2011.05					GC083002	Outer Joint		36	27	59.5	40	66	I		
1.8 TFSi (118 kW)	2006.11-	2010.05					GC083002	Outer Joint		36	27	59.5	40	66	I		
1.8 TFSi Quattro (118 kW)	2006.11-	2010.05					GC083002	Outer Joint		36	27	59.5	40	66	I		
1.9 TDi (77 kW)	2009.05-					Double Clutch	GC083002	Outer Joint		36	27	59.5	40	66	I		
2.0 TDi (100 kW)	2003.06-	2010.05	MT			Double Clutch	GC083002	Outer Joint		36	27	59.5	40	66	I		
2.0 TDi (103 kW)	2003.06-	2010.05	MT			Double Clutch	GC083002	Outer Joint		36	27	59.5	40	66	I		
2.0 TDi (125 kW)	2008.07-	2010.05				Double Clutch	GC083002	Outer Joint		36	27	59.5	40	66	I		
2.0 TDi Quattro (103 kW)	2005-				F	Double Clutch	GC083002	Outer Joint		36	27	59.5	40	66	I		
2.0 TDi Quattro (125 kW)	2006.02-	2008.06				Double Clutch	GC083002	Outer Joint		36	27	59.5	40	66	I		
2.0 TFSi (147 kW)	2004.06-	2010.01				Double Clutch	GC083002	Outer Joint		36	27	59.5	40	66	I		
2.0 TFSi Quattro (147 kW)	2004.06-	2008.06				Double Clutch	GC083002	Outer Joint		36	27	59.5	40	66	I		
2.0 TFSi Quattro (188 kW)	2012.03-						GC083002	Outer Joint		36	27	59.5	40	66	I		
3.2 (184 kW)	2003.07-	2008.06					GC083002	Outer Joint		36	27	59.5	40	66	I		
3.2 TFSi Quattro (184 kW)	2008.07-	2009.05					GC083002	Outer Joint		36	27	59.5	40	66	I		
S 3 2.0 16V Quattro (188 kW)	2006.11-	2010.05					GC083002	Outer Joint		36	27	59.5	40	66	I		
S 3 2.0 16V Quattro (195 kW)	2006.11-	2010.05					GC083002	Outer Joint		36	27	59.5	40	66	I		
<b>A1 (8X1, 8XF)</b>																	
1.2 TFSi (63 kW)	2010.05-				F	Hatchback Engine CBZA	GC083024	Outer Joint		36	30	50.75	59	54.5	I		
	2010.05-		MT		F	Hatchback Engine CBZA	GCI53002	Inner Joint			33		34				
	2010.05-		MT	L	F	Hatchback Engine CBZA	GDS61263	Drive Shaft		36		52	59	514			
	2010.05-			L	F	Hatchback Engine CBZA	GDS61274	Drive Shaft		36		50.5	59	514			
1.4 TFSi (103 kW)	2012.04-		AT	L	F	Hatchback Engine CPTA	GDS61260	Drive Shaft		36		52	75	498			
1.4 TFSi (136 kW)	2011.01-		AT	L	F	Hatchback Engine CAVG/CTHG/CTJA	GDS61260	Drive Shaft		36		52	75	498			
	2011.01-		AT	R	F	Hatchback Engine CAVG/CTHG/CTJA	GDS61261	Drive Shaft		36		52	75	785			
1.4 TFSi (90 kW)	2010.05-				F	Hatchback Engine CAXA/CNVA	GC083024	Outer Joint		36	30	50.75	59	54.5	I		
	2010.05-		MT		F	Hatchback Engine CAXA/CNVA	GCI53002	Inner Joint			33		34				
	2010.05-		MT	L	F	Hatchback Engine CAXA/CNVA	GDS61263	Drive Shaft		36		52	59	514			
	2010.05-			L	F	Hatchback Engine CAXA/CNVA	GDS61274	Drive Shaft		36		50.5	59	514			
1.6 TDi (66 kW)	2011.03-		AT	L	F	Hatchback Engine CAYB	GDS61260	Drive Shaft		36		52	75	498			
	2011.03-		AT	R	F	Hatchback Engine CAYB	GDS61261	Drive Shaft		36		52	75	785			
1.6 TDi (77 kW)	2010.05-				F	Hatchback Engine CAYC	GC083024	Outer Joint		36	30	50.75	59	54.5	I		
	2010.05-		MT		F	Hatchback Engine CAYC	GCI53002	Inner Joint			33		34				
	2010.05-		MT	L	F	Hatchback Engine CAYC	GDS61184	Drive Shaft		36		52	59	496			
	2010.05-		MT	L/R	F	Hatchback Engine CAYC	GC054006	Outer Joint		36	30	52	59	55.5	I		
	2010.05-			R	F	Hatchback Engine CAYC	GDS61185	Drive Shaft		36		52	59	785			
<b>A1 (8XA, 8XK)</b>																	
1.2 TFSi (63 kW)	2012.01-		MT	L	F	Hatchback Engine CBZA	GDS61263	Drive Shaft		36		52	59	514			
	2012.01-			L	F	Hatchback Engine CBZA	GDS61274	Drive Shaft		36		50.5	59	514			
1.4 TFSi (103 kW)	2012.04-		AT	L	F	Hatchback Engine CPTA	GDS61260	Drive Shaft		36		52	75	498			
1.4 TFSi (136 kW)	2011.11-		AT	L	F	Hatchback Engine CAVG/CTHG/CTJA	GDS61260	Drive Shaft		36		52	75	498			
	2011.11-		AT	R	F	Hatchback Engine CAVG/CTHG/CTJA	GDS61261	Drive Shaft		36		52	75	785			
1.4 TFSi (90 kW)	2011.11-		MT	L	F	Hatchback Engine CAXA/CNVA	GDS61263	Drive Shaft		36		52	59	514			
	2011.11-			L	F	Hatchback Engine CAXA/CNVA	GDS61274	Drive Shaft		36		50.5	59	514			
1.6 TDi (66 kW)	2011.11-		AT	L	F	Hatchback Engine CAYB	GDS61260	Drive Shaft		36		52	75	498			
	2011.11-		AT	R	F	Hatchback Engine CAYB	GDS61261	Drive Shaft		36		52	75	785			
<b>A1 SPORTACK (8XA, 8XK)</b>																	
1.4 TFSi (136 kW)	2011.01-	2012.04					GCI83016	Inner Joint			28		32				
1.6 TDi (66 kW)	2010.05-		AT			DOUBLE CLUTCH	GCI83016	Inner Joint			28		32				
1.6 TDi (77 kW)	2010.05-		AT			DOUBLE CLUTCH	GCI83016	Inner Joint			28		32				



	 YEAR	TRANSM	L/R	F/R		G-AP Ref.	PRODUCT	ABS	Technical Specifications								
									A	B	C	H	L	P			
<b>AUDI</b>																	
<b>A1 SPORTACK (8XA, 8XK)</b>																	
2.0 TDi (105 kW)	2011.09-	2012.05	AT		DOUBLE CLUTCH	GC183016	Inner Joint			28		32					
2.0 TFSi Quattro (188 kW)	2012.03-					GC183016	Inner Joint			28		32					
<b>A2 (8Z0)</b>																	
1.2 TDi (45 kW)	2001.03-	2005.08		F	Hatchback Engine ANY	GC099268	Outer Joint		20	26	43	56	45	M			
1.4 (55 kW)	2000.02-	2005.08		F	Hatchback Engine AUA/BBY	GC083027	Outer Joint		36	30	50.7	58.5	47.5	I			
	2000.02-	2005.08				GC083027	Outer Joint		36	30	50.7	58.5	47.5	I			
1.4 TDi (55 kW)	2000.02-	2005.08		F	Hatchback Engine AMF/BHC	GC083024	Outer Joint		36	30	50.75	59	54.5	I			
1.4 TDi (66 kW)	2003.09-	2004.12		F	Hatchback Engine ATL	GC083024	Outer Joint		36	30	50.75	59	54.5	I			
1.6 FSi (81 kW)	2002.05-	2005.08		F	Hatchback Engine BAD	GC083024	Outer Joint		36	30	50.75	59	54.5	I			
<b>A3</b>																	
1.6	1999.01-	2006.12	MT			GC153002	Inner Joint			33		34					
	1999.01-	2006.12	MT			GC083070	Outer Joint		36	30	53	78	60	I			
1.8	1999.01-	2006.12	MT			GC153002	Inner Joint			33		34					
<b>A3 (8L1)</b>																	
1.6 (74 kW)	1996.09-	2003.05	MT	F	Hatchback Engine AEH/AKL/APF	GC083033	Outer Joint		36	30	53	78.5	51	I			
	1996.09-	2003.05	MT	F	Hatchback Engine AEH/AKL/APF	GC183008	Inner Joint			33		32					
	1996.09-	2003.05	AT	L F	Hatchback Engine AEH/AKL/APF	GDS61156	Drive Shaft		36		53	78	554.5				
	1996.09-	2003.05	AT	L F	Hatchback Engine AEH/AKL/APF	GC161062	Inner Joint			30		59					
	1996.09-	2003.05	MT	L F	Hatchback Engine AEH/AKL/APF	GDS61045	Drive Shaft		36		53	78.5	555				
	1996.09-	2003.05	MT	R F	Hatchback Engine AEH/AKL/APF	GDS83046	Drive Shaft		36		53	78.5	822				
1.6 (75 kW)	2000.08-	2003.05	MT	F	Hatchback Engine AVU/BFQ	GC083033	Outer Joint		36	30	53	78.5	51	I			
	2000.08-	2003.05	MT/AT	F	Hatchback Engine AVU/BFQ	GC183008	Inner Joint			33		32					
	2000.08-	2003.05	AT	L F	Hatchback Engine AVU/BFQ	GDS61156	Drive Shaft		36		53	78	554.5				
	2000.08-	2003.05	AT	L F	Hatchback Engine AVU/BFQ	GC161062	Inner Joint			30		59					
	2000.08-	2003.05	MT	L F	Hatchback Engine AVU/BFQ	GDS61045	Drive Shaft		36		53	78.5	555				
	2000.08-	2003.05	MT	R F	Hatchback Engine AVU/BFQ	GDS83046	Drive Shaft		36		53	78.5	822				
1.8 (92 kW)	1996.09-	2003.05	MT	F	Hatchback Engine AGN/APG	GC183011	Inner Joint			33		34					
	1996.09-	2003.05	MT/AT	F	Hatchback Engine AGN/APG	GC083036	Outer Joint		36	30	53.2	77.5	61	I			
	1996.09-	2003.05	AT	L F	Hatchback Engine AGN/APG	GDS61156	Drive Shaft		36		53	78	554.5				
	1996.09-	2003.05	AT	L F	Hatchback Engine AGN/APG	GC161062	Inner Joint			30		59					
	1996.09-	2003.05	MT	L F	Hatchback Engine AGN/APG	GDS61021	Drive Shaft		36		53.2	77.5	564.5				
	1996.09-	2003.05	MT	L F	Hatchback Engine AGN/APG	GC083035	Outer Joint		36	27	53	77.5	65	I			
1.8 S3 Quattro (154 kW)	1999.03-	2002.04	MT/AT	F	Hatchback Engine APY/AMK	GC083035	Outer Joint		36	27	53	77.5	65	I			
	1999.03-	2002.04		L F	Hatchback Engine APY/AMK	GDS61123	Drive Shaft		36		53	77.5	520				
	1999.03-	2002.04	MT	L F	Hatchback Engine APY/AMK	GDS83304	Drive Shaft		36		59.5	40	481				
	1999.03-	2002.04		R F	Hatchback Engine APY/AMK	GDS61186	Drive Shaft		36		53	77.5	653				
	1999.03-	2002.04		R F	Hatchback Engine APY/AMK	GC161002	Inner Joint			28		31.8					
	1999.03-	2002.04		R F	Hatchback Engine APY/AMK	GC083035	Outer Joint		36	27	53	77.5	65	I			
	1999.03-	2002.04	6MT	R	Hatchback Engine APY/AMK	GC183011	Inner Joint			33		34					
1.8 S3 Quattro (165 kW)	2001.10-	2003.05	MT	L F	Hatchback Engine BAM	GDS83304	Drive Shaft		36		59.5	40	481				
	2001.10-	2003.05	6MT	R	Hatchback Engine BAM	GC183011	Inner Joint			33		34					
1.8 T (110 kW)	1996.12-	2003.05	MT	F	Hatchback Engine AGU/AQA/ARZ/AUM	GC183011	Inner Joint			33		34					
	1996.12-	2003.05	MT/AT	F	Hatchback Engine AGU/AQA/ARZ/AUM	GC083036	Outer Joint		36	30	53.2	77.5	61	I			
	1996.12-	2003.05	AT	L F	Hatchback Engine AGU/AQA/ARZ/AUM	GDS83374	Drive Shaft		36		53	77.5	521				
	1996.12-	2003.05	MT	L F	Hatchback Engine AGU/AQA/ARZ/AUM	GDS61021	Drive Shaft		36		53.2	77.5	564.5				
	1996.12-	2003.05	MT	L F	Hatchback Engine AGU/AQA/ARZ/AUM	GDS61156	Drive Shaft		36		53	78	554.5				
	1996.12-	2003.05	MT	L F	Hatchback Engine AGU/AQA/ARZ/AUM	GC161062	Inner Joint			30		59					
1.8 T (132 kW)	1998.12-	2003.05	AT	F	Hatchback Engine AJQ/APP/ARY/AUQ	GC083035	Outer Joint		36	27	53	77.5	65	I			
	1998.12-	2003.05	MT	L F	Hatchback Engine AJQ/APP/ARY/AUQ	GDS61156	Drive Shaft		36		53	78	554.5				
	1998.12-	2003.05	MT	L F	Hatchback Engine AJQ/APP/ARY/AUQ	GC161062	Inner Joint			30		59					
	1998.12-	2003.05	Semi-AT	L F	Hatchback Engine AJQ/APP/ARY/AUQ	GDS83374	Drive Shaft		36		53	77.5	521				
	1998.12-	2003.05															
1.8 T Quattro (110 kW)	1996.12-	2003.05			Hatchback Engine AGU/AQA/ARX	GC083036	Outer Joint		36	30	53.2	77.5	61	I			
	1996.12-	2003.05	MT	F	Hatchback Engine AGU/AQA/ARX	GC183011	Inner Joint			33		34					
	1996.12-	2003.05		R F	Hatchback Engine AGU/AQA/ARX	GDS61186	Drive Shaft		36		53	77.5	653				
	1996.12-	2003.05		R F	Hatchback Engine AGU/AQA/ARX	GC161002	Inner Joint			28		31.8					
	1996.12-	2003.05		R F	Hatchback Engine AGU/AQA/ARX	GC083035	Outer Joint		36	27	53	77.5	65	I			
	1996.12-	2003.05															
1.8 T Quattro (132 kW)	1998.10-	2003.05	MT/AT	F	Hatchback Engine AJQ/ARY	GC083035	Outer Joint		36	27	53	77.5	65	I			
	1998.10-	2003.05	AT	L F	Hatchback Engine AJQ/ARY	GDS61156	Drive Shaft		36		53	78	554.5				
	1998.10-	2003.05	AT	L F	Hatchback Engine AJQ/ARY	GC161062	Inner Joint			30		59					
	1998.10-	2003.05	MT	L F	Hatchback Engine AJQ/ARY	GDS61123	Drive Shaft		36		53	77.5	520				
	1998.10-	2003.05	Semi-AT	L F	Hatchback Engine AJQ/ARY	GDS83374	Drive Shaft		36		53	77.5	521				
	1998.10-	2003.05	MT	R F	Hatchback Engine AJQ/ARY	GDS61186	Drive Shaft		36		53	77.5	653				
	1998.10-	2003.05		R F	Hatchback Engine AJQ/ARY	GC161002	Inner Joint			28		31.8					
	1998.10-	2003.05															





		YEAR	TRANSM	L/R	F/R		G-AP Ref.	PRODUCT	ABS	Technical Specifications										
										A	B	C	H	L	P					
<b>AUDI</b>																				
<b>A3 (8L1)</b>																				
1.8 T Quattro (132 kW)	1998.10-	2003.05	MT	R	F	Hatchback Engine AJQ/ARY	GC083035	Outer Joint		36	27	53	77.5	65	I					
	1998.10-	2003.05			R	Hatchback Engine AJQ/ARY	GCI83011	Inner Joint			33		34							
1.9 TDi (66 kW)	1996.09-	2001.07	MT	L	F	Hatchback Engine AGR/ALH	GDS61021	Drive Shaft		36		53.2	77.5	564.5						
	1996.09-	2001.07	AT	L	F	Hatchback Engine AGR/ALH	GDS61156	Drive Shaft		36		53	78	554.5						
	1996.09-	2001.07	AT	L	F	Hatchback Engine AGR/ALH	GCI61062	Inner Joint			30		59							
	1996.09-	2001.07					GCI83011	Inner Joint			33		34							
1.9 TDi (74 kW)	1996.09-	2001.07					GCI83011	Inner Joint			33		34							
	2000.10-	2003.05	AT		F	Hatchback Engine ATD/AXR	GC083035	Outer Joint		36	27	53	77.5	65	I					
	2000.10-	2003.05	MT		F	Hatchback Engine ATD/AXR	GCI83011	Inner Joint			33		34							
	2000.10-	2003.05	MT/AT		F	Hatchback Engine ATD/AXR	GC083036	Outer Joint		36	30	53.2	77.5	61	I					
	2000.10-	2003.05	AT	L	F	Hatchback Engine ATD/AXR	GDS83374	Drive Shaft		36		53	77.5	521						
	2000.10-	2003.05	MT	L	F	Hatchback Engine ATD/AXR	GDS61021	Drive Shaft		36		53.2	77.5	564.5						
	2000.10-	2003.05	MT	L	F	Hatchback Engine ATD/AXR	GDS83006	Drive Shaft		36		53.2	77.5	557						
	2000.10-	2003.05	MT	R	F	Hatchback Engine ATD/AXR	GDS83004	Drive Shaft		36		53.2	77.5	822						
1.9 TDi (81 kW)	1996.09-	2001.07					GCI83011	Inner Joint			33		34							
	1997.08-	2001.07	MT	L	F	Hatchback Engine AHF/ASV	GDS61021	Drive Shaft		36		53.2	77.5	564.5						
	1997.08-	2001.07	AT	L	F	Hatchback Engine AHF/ASV	GDS61156	Drive Shaft		36		53	78	554.5						
	1997.08-	2001.07	AT	L	F	Hatchback Engine AHF/ASV	GCI61062	Inner Joint			30		59							
1.9 TDi (96 kW)	2000.08-	2003.05	MT/AT		F	Hatchback Engine ASZ	GC083035	Outer Joint		36	27	53	77.5	65	I					
	2000.08-	2003.05	AT	L	F	Hatchback Engine ASZ	GDS83374	Drive Shaft		36		53	77.5	521						
1.9 TDi Quattro (96 kW)	2000.08-	2003.05	MT/AT		F	Hatchback Engine ASZ	GC083035	Outer Joint		36	27	53	77.5	65	I					
	2000.08-	2003.05		L	F	Hatchback Engine ASZ	GDS61123	Drive Shaft		36		53	77.5	520						
	2000.08-	2003.05		R	F	Hatchback Engine ASZ	GDS61186	Drive Shaft		36		53	77.5	653						
	2000.08-	2003.05		R	F	Hatchback Engine ASZ	GCI61002	Inner Joint			28		31.8							
	2000.08-	2003.05		R	F	Hatchback Engine ASZ	GC083035	Outer Joint		36	27	53	77.5	65	I					
	2000.08-	2003.05		R	F	Hatchback Engine ASZ	GCI83011	Inner Joint			33		34							
<b>A3 (8P1)</b>																				
1.2 TSi (77 kW)	2010.04-	2012.08	Semi-AT	L	F	Hatchback Engine CBZB	GDS61201	Drive Shaft		36		59.5	40.5	535						
	2010.04-	2012.08	MT				GC083037	Outer Joint		36	30	59.5	40.5	55	I					
	2010.04-	2012.08				Hatchback Engine CBZB	GC083100	Outer Joint		36	33	59.5	38	55	I					
1.4 TFSi (92 kW)	2007.09-	2012.08	AT		F	Hatchback Engine CAXC/CMSA	GC083002	Outer Joint		36	27	59.5	40	66	I					
	2007.09-	2012.08	MT		F	Hatchback Engine CAXC/CMSA	GCI83011	Inner Joint			33		34							
	2007.09-	2012.08				Hatchback Engine CAXC/CMSA	GC061059	Outer Joint		36	33	59.5	40	59.5	I					
	2011.05-					DOUBLE CLUTCH	GCI83016	Inner Joint			28		32							
1.6 (75 kW)	2003.05-	2012.08			F	Hatchback Engine BGU/BSE/BSF/CCSA/CMXA	GC083037	Outer Joint		36	30	59.5	40.5	55	I					
	2003.05-	2012.08	6AT		F	Hatchback Engine BGU/BSE/BSF/CCSA/CMXA	GCI61011	Inner Joint		26	32	31	68.5	85						
	2003.05-	2012.08	MT		F	Hatchback Engine BGU/BSE/BSF/CCSA/CMXA	GCI83011	Inner Joint			33		34							
	2003.05-	2012.08	6AT	L	F	Hatchback Engine BGU/BSE/BSF/CCSA/CMXA	GDS61093	Drive Shaft		36	26	59.5	40.5	587.5						
	2003.05-	2012.08	6AT	L	F	Hatchback Engine BGU/BSE/BSF/CCSA/CMXA	GDS83318	Drive Shaft		36	26	59.5	38	581						
	2003.05-	2012.08	7AT	L	F	Hatchback Engine BGU/BSE/BSF/CCSA/CMXA	GDS61089	Drive Shaft		36		59.5	40.5	521						
	2003.05-	2012.08	MT	L	F	Hatchback Engine BGU/BSE/BSF/CCSA/CMXA	GDS61097	Drive Shaft		36		59.5	40.5	543						
	2003.05-	2012.08	MT	L	F	Hatchback Engine BGU/BSE/BSF/CCSA/CMXA	GDS83320	Drive Shaft		36		59.5	40	546						
	2003.05-	2012.08	6AT	R	F	Hatchback Engine BGU/BSE/BSF/CCSA/CMXA	GDS83346	Drive Shaft		36	26	59.5	38	879						
	2003.05-	2012.08	6AT	R	F	Hatchback Engine BGU/BSE/BSF/CCSA/CMXA	GCI61011	Inner Joint		26	32	31	68.5	85						
	2003.05-	2012.08	6AT	R	F	Hatchback Engine BGU/BSE/BSF/CCSA/CMXA	GC083116	Outer Joint		36	30	59.5	38	55	I					
	2003.05-	2012.08	6AT	R	F	Hatchback Engine BGU/BSE/BSF/CCSA/CMXA	GDS61094	Drive Shaft		36	26	59.5	40.5	884						
	2003.05-	2012.08	MT	R	F	Hatchback Engine BGU/BSE/BSF/CCSA/CMXA	GDS61096	Drive Shaft		36		59.5	40.5	799						
	2003.06-	2012.08	MT/AT				GC083037	Outer Joint		36	30	59.5	40.5	55	I					
1.6 FSi (85 kW)	2003.06-	2010.05	MT			Engine BGABLF/8LPG	GC083037	Outer Joint		36	30	59.5	40.5	55	I					
	2003.08-	2007.04			F	Hatchback Engine BAG/BLF/BLP	GC083037	Outer Joint		36	30	59.5	40.5	55	I					
	2003.08-	2007.04	MT		F	Hatchback Engine BAG/BLF/BLP	GCI83011	Inner Joint			33		34							
	2003.08-	2007.04	6MT	L	F	Hatchback Engine BAG/BLF/BLP	GDS83319	Drive Shaft		36		59.5	38	557						
	2003.08-	2007.04	6MT	R	F	Hatchback Engine BAG/BLF/BLP	GDS61211	Drive Shaft		36		59.5	40.5	784						
1.6 TDi (66 kW)	2009.05-	2010.05					GC083037	Outer Joint		36	30	59.5	40.5	55	I					
	2009.05-	2012.08			F	Hatchback Engine CAYB	GC083037	Outer Joint		36	30	59.5	40.5	55	I					
	2009.05-	2012.08	MT		F	Hatchback Engine CAYB	GCI53002	Inner Joint			33		34							
	2009.05-	2012.08		L	F	Hatchback Engine CAYB	GDS83294	Drive Shaft		36		59.5	38	519						
	2009.05-	2012.08		L	F	Hatchback Engine CAYB	GDS61089	Drive Shaft		36		59.5	40.5	521						
	2009.05-	2012.08		R	F	Hatchback Engine CAYB	GDS61042	Drive Shaft		36		59.5	40.5	814						
1.6 TDi (77 kW)	2009.05-	2010.05					GC083037	Outer Joint		36	30	59.5	40.5	55	I					
	2009.05-	2012.08			F	Hatchback Engine CAYC	GC083037	Outer Joint		36	30	59.5	40.5	55	I					
	2009.05-	2012.08	MT		F	Hatchback Engine CAYC	GCI53002	Inner Joint			33		34							



		YEAR	TRANSM	L/R	F/R		G-AP Ref.	PRODUCT	ABS	Technical Specifications											
										A	B	C	H	L	P						
<b>AUDI</b>																					
<b>A3 (8P1)</b>																					
1.6 TDi (77 kW)	2009.05-	2012.08	AT	L	F	Hatchback Engine CAYC	GDS83236	Drive Shaft	36		59.5	40	484								
	2009.05-	2012.08	MT	L	F	Hatchback Engine CAYC	GDS61089	Drive Shaft	36		59.5	40.5	521								
	2009.05-	2012.08	MT	L	F	Hatchback Engine CAYC	GDS83294	Drive Shaft	36		59.5	38	519								
	2009.05-	2012.08	MT	R	F	Hatchback Engine CAYC	GDS61042	Drive Shaft	36		59.5	40.5	814								
	2009.05-	2012.08				Hatchback Engine CAYC	GC061059	Outer Joint	36	33	59.5	40	59.5	I							
	2011.05-					DOUBLE CLUTCH	GCI83016	Inner Joint		28		32									
1.8 TFSi (118 kW)	2006.11-	2010.05					GCI83016	Inner Joint		28		32									
	2006.11-	2012.08	MT		F	Hatchback Engine BYT/BZB/CDA	GC083002	Outer Joint	36	27	59.5	40	66	I							
	2006.11-	2012.08	AT	L	F	Hatchback Engine BYT/BZB/CDA	GDS83295	Drive Shaft	36		59.5	40	491								
	2006.11-	2012.08	MT	L	F	Hatchback Engine BYT/BZB/CDA	GDS61131	Drive Shaft	36		59.5	40	515								
	2006.11-	2012.08	SEMI-AT	L	F	Hatchback Engine BYT/BZB/CDA	GDS83236	Drive Shaft	36		59.5	40	484								
	2006.11-	2012.08	MT	R	F	Hatchback Engine BYT/BZB/CDA	GDS83313	Drive Shaft	36		59.5	40	792								
1.8 TFSi Quattro (118 kW)	2008.07-	2012.08	MT			Hatchback Engine CDA	GCI53002	Inner Joint		33		34									
	2008.07-	2012.08		L		Hatchback Engine CDA	GDS83295	Drive Shaft	36		59.5	40	491								
	2008.07-	2012.08		R		Hatchback Engine CDA	GDS83266	Drive Shaft	36		59.5	40	601								
	2008.07-	2012.08	MT&AT		F	Hatchback Engine CDA	GC083002	Outer Joint	36	27	59.5	40	66	I							
1.9 TDi (77 kW)	2003.05-	2007.04			F	Hatchback Engine BKC/BLS/BXE	GC083037	Outer Joint	36	30	59.5	40.5	55	I							
	2003.05-	2007.04	6AT		F	Hatchback Engine BKC/BLS/BXE	GC083002	Outer Joint	36	27	59.5	40	66	I							
	2003.05-	2007.04	MT		F	Hatchback Engine BKC/BLS/BXE	GCI83011	Inner Joint		33		34									
	2003.05-	2007.04	6AT	L	F	Hatchback Engine BKC/BLS/BXE	GDS54013	Drive Shaft	36		59.5	40	479.5								
	2003.05-	2007.04	MT	L	F	Hatchback Engine BKC/BLS/BXE	GDS61089	Drive Shaft	36		59.5	40.5	521								
	2003.05-	2007.04	MT	L	F	Hatchback Engine BKC/BLS/BXE	GDS83294	Drive Shaft	36		59.5	38	519								
	2003.05-	2007.04	AT	L/R	F	Hatchback Engine BKC/BLS/BXE	GCI61057	Inner Joint		34		86									
	2003.05-	2007.04	AT	R	F	Hatchback Engine BKC/BLS/BXE	GDS83355	Drive Shaft	36	23	59.5	40	799								
	2003.05-	2007.04	AT	R	F	Hatchback Engine BKC/BLS/BXE	GDS54011	Drive Shaft	36		59.5	40	755								
	2003.05-	2007.04	MT	R	F	Hatchback Engine BKC/BLS/BXE	GDS61042	Drive Shaft	36		59.5	40.5	814								
2.0 FSi (110 kW)	2003.05-	2008.06			F	Hatchback Engine AXW/BLR/BLX/BLY/BMB/BVY/BVZ	GC083037	Outer Joint	36	30	59.5	40.5	55	I							
	2003.05-	2008.06	6AT		F	Hatchback Engine AXW/BLR/BLX/BLY/BMB/BVY/BVZ	GCI61011	Inner Joint	26	32	31	68.5	85								
	2003.05-	2008.06	MT		F	Hatchback Engine AXW/BLR/BLX/BLY/BMB/BVY/BVZ	GCI83011	Inner Joint		33		34									
	2003.05-	2008.06	6AT	L	F	Hatchback Engine AXW/BLR/BLX/BLY/BMB/BVY/BVZ	GDS61093	Drive Shaft	36	26	59.5	40.5	587.5								
	2003.05-	2008.06	MT	L	F	Hatchback Engine AXW/BLR/BLX/BLY/BMB/BVY/BVZ	GDS61089	Drive Shaft	36		59.5	40.5	521								
	2003.05-	2008.06	6AT	R	F	Hatchback Engine AXW/BLR/BLX/BLY/BMB/BVY/BVZ	GDS61094	Drive Shaft	36	26	59.5	40.5	884								
2.0 FSi (147 kW)	2003.06-	2010.05					GC083037	Outer Joint	36	30	59.5	40.5	55	I							
GCI83016	Inner Joint		28		32																
2.0 S3 Quattro (188 kW)	2007.02-	2012.08		L		Hatchback Engine CDLC/BZC	GDS83295	Drive Shaft	36		59.5	40	491								
	2006.10-	2007.12	MT			Hatchback Engine BHZ/CDLA	GCI53002	Inner Joint		33		34									
	2006.10-	2007.12		L		Hatchback Engine BHZ/CDLA	GDS83295	Drive Shaft	36		59.5	40	491								
	2006.10-	2007.12			F	Hatchback Engine BHZ/CDLA	GC083002	Outer Joint	36	27	59.5	40	66	I							
2.0 S3 Quattro (195 kW)	2006.10-	2007.12	MT		R	Hatchback Engine BHZ/CDLA	GCI83011	Inner Joint		33		34									
	2003.05-	2012.08	MT		F	Hatchback Engine AZV/CBAA/CFFA	GC083002	Outer Joint	36	27	59.5	40	66	I							
	2003.05-	2012.08	AT	L	F	Hatchback Engine AZV/CBAA/CFFA	GDS54013	Drive Shaft	36		59.5	40	479.5								
	2003.05-	2012.08	MT	L	F	Hatchback Engine AZV/CBAA/CFFA	GCI83016	Inner Joint		28		32									
	2003.05-	2012.08	MT	L	F	Hatchback Engine AZV/CBAA/CFFA	GDS83265	Drive Shaft	36		59.5	40	487								
	2003.05-	2012.08	MT	L	F	Hatchback Engine AZV/CBAA/CFFA	GDS83295	Drive Shaft	36		59.5	40	491								
	2003.05-	2012.08	AT	L/R	F	Hatchback Engine AZV/CBAA/CFFA	GCI61057	Inner Joint		34		86									
	2003.05-	2012.08	AT	R	F	Hatchback Engine AZV/CBAA/CFFA	GDS83355	Drive Shaft	36	23	59.5	40	799								
	2003.05-	2012.08	AT	R	F	Hatchback Engine AZV/CBAA/CFFA	GDS54011	Drive Shaft	36		59.5	40	755								
	2003.05-	2012.08	MT	R	F	Hatchback Engine AZV/CBAA/CFFA	GDS83313	Drive Shaft	36		59.5	40	792								
2.0 TDi (100 kW)	2003.06-	2010.05	MT				GCI83016	Inner Joint		28		32									
	2003.06-	2010.05	MT				GCI83016	Inner Joint		28		32									
	2007.02-	2007.04	MT		F	Hatchback Engine BMM	GCI53002	Inner Joint		33		34									
	2007.02-	2007.04	MT		F	Hatchback Engine BMM	GC083002	Outer Joint	36	27	59.5	40	66	I							
	2007.02-	2007.04	AT	L	F	Hatchback Engine BMM	GDS83241	Drive Shaft	36		59.5	40	475								
	2007.02-	2007.04	AT	L	F	Hatchback Engine BMM	GDS54013	Drive Shaft	36		59.5	40	479.5								
	2007.02-	2007.04	MT	L	F	Hatchback Engine BMM	GDS83236	Drive Shaft	36		59.5	40	484								
	2007.02-	2007.04	MT	L	F	Hatchback Engine BMM	GCI83016	Inner Joint		28		32									
	2007.02-	2007.04	MT	L	F	Hatchback Engine BMM	GDS83265	Drive Shaft	36		59.5	40	487								
	2007.02-	2007.04	MT	L	F	Hatchback Engine BMM	GDS83295	Drive Shaft	36		59.5	40	491								
	2007.02-	2007.04	AT	L/R	F	Hatchback Engine BMM	GCI61057	Inner Joint		34		86									
	2007.02-	2007.04	AT	R	F	Hatchback Engine BMM	GDS83355	Drive Shaft	36	23	59.5	40	799								
	2007.02-	2007.04	AT	R	F	Hatchback Engine BMM	GDS54011	Drive Shaft	36		59.5	40	755								
	2007.02-	2007.04	AT	R	F	Hatchback Engine BMM	GDS54011	Drive Shaft	36		59.5	40	755								





		TRANSM	L/R	F/R		G-AP Ref.	PRODUCT	ABS	Technical Specifications										
									YEAR	A	B	C	H	L	P				
<b>AUDI</b>																			
<b>A3 (8P1)</b>																			
2.0 TDi (103 kW)	2007.02-	2007.04	MT	R	F	Hatchback Engine BMM	GDS61126	Drive Shaft	36		59.5	40	793						
	2007.02-	2007.04	MT	R	F	Hatchback Engine BMM	GDS83313	Drive Shaft	36		59.5	40	792						
2.0 TDi (120 kW)	2006.02-	2008.06					GCI83016	Inner Joint		28		32							
	2006.06-	2008.06	MT	L	F	Hatchback Engine BUY	GDS83236	Drive Shaft	36		59.5	40	484						
	2006.06-	2008.06	MT	L	F	Hatchback Engine BUY	GCI83016	Inner Joint		28		32							
	2006.06-	2008.06	MT	L	F	Hatchback Engine BUY	GDS83265	Drive Shaft	36		59.5	40	487						
	2006.06-	2008.06	AT	L/R	F	Hatchback Engine BUY	GCI61057	Inner Joint		34		86							
	2006.06-	2008.06	AT	R	F	Hatchback Engine BUY	GDS83355	Drive Shaft	36	23	59.5	40	799						
	2006.06-	2008.06	AT	R	F	Hatchback Engine BUY	GDS54011	Drive Shaft	36		59.5	40	755						
	2006.06-	2008.06	MT	R	F	Hatchback Engine BUY	GDS61126	Drive Shaft	36		59.5	40	793						
2.0 TDi (125 kW)	2006.02-	2008.06					GCI83016	Inner Joint		28		32							
	2006.05-	2007.04	6AT		F	Hatchback Engine BMN/CBBB/CFGB	GCI54004	Inner Joint		34		85							
	2006.05-	2007.04	MT		F	Hatchback Engine BMN/CBBB/CFGB	GCI53002	Inner Joint		33		34							
	2006.05-	2007.04	MT		F	Hatchback Engine BMN/CBBB/CFGB	GC061045	Outer Joint	36	27	59.5	40	65	M					
	2006.05-	2007.04	AT	L	F	Hatchback Engine BMN/CBBB/CFGB	GDS83241	Drive Shaft	36		59.5	40	475						
	2006.05-	2007.04	MT	L	F	Hatchback Engine BMN/CBBB/CFGB	GDS83236	Drive Shaft	36		59.5	40	484						
	2006.05-	2007.04	MT	L	F	Hatchback Engine BMN/CBBB/CFGB	GCI83016	Inner Joint		28		32							
	2006.05-	2007.04	MT	L	F	Hatchback Engine BMN/CBBB/CFGB	GDS83265	Drive Shaft	36		59.5	40	487						
	2006.05-	2007.04	AT	L/R	F	Hatchback Engine BMN/CBBB/CFGB	GCI61057	Inner Joint		34		86							
	2006.05-	2007.04	AT	R	F	Hatchback Engine BMN/CBBB/CFGB	GDS83355	Drive Shaft	36	23	59.5	40	799						
	2006.05-	2007.04	AT	R	F	Hatchback Engine BMN/CBBB/CFGB	GDS54011	Drive Shaft	36		59.5	40	755						
	2006.05-	2007.04	MT	R	F	Hatchback Engine BMN/CBBB/CFGB	GDS61126	Drive Shaft	36		59.5	40	793						
2.0 TDi 16V (103 kW)	2003.05-	2012.08	MT		F	Hatchback Engine BKD/CBAB/CFFB/CLJA	GCI53002	Inner Joint		33		34							
	2003.05-	2012.08	MT		F	Hatchback Engine BKD/CBAB/CFFB/CLJA	GC083002	Outer Joint	36	27	59.5	40	66	I					
	2003.05-	2012.08	AT	L	F	Hatchback Engine BKD/CBAB/CFFB/CLJA	GDS83241	Drive Shaft	36		59.5	40	475						
	2003.05-	2012.08	AT	L	F	Hatchback Engine BKD/CBAB/CFFB/CLJA	GDS54013	Drive Shaft	36		59.5	40	479.5						
	2003.05-	2012.08	MT	L	F	Hatchback Engine BKD/CBAB/CFFB/CLJA	GDS83236	Drive Shaft	36		59.5	40	484						
	2003.05-	2012.08	MT	L	F	Hatchback Engine BKD/CBAB/CFFB/CLJA	GCI83016	Inner Joint		28		32							
	2003.05-	2012.08	MT	L	F	Hatchback Engine BKD/CBAB/CFFB/CLJA	GDS83265	Drive Shaft	36		59.5	40	487						
	2003.05-	2012.08	MT	L	F	Hatchback Engine BKD/CBAB/CFFB/CLJA	GDS83295	Drive Shaft	36		59.5	40	491						
	2003.05-	2012.08	AT	L/R	F	Hatchback Engine BKD/CBAB/CFFB/CLJA	GCI61057	Inner Joint		34		86							
	2003.05-	2012.08	AT	R	F	Hatchback Engine BKD/CBAB/CFFB/CLJA	GDS83355	Drive Shaft	36	23	59.5	40	799						
	2003.05-	2012.08	AT	R	F	Hatchback Engine BKD/CBAB/CFFB/CLJA	GDS54011	Drive Shaft	36		59.5	40	755						
	2003.05-	2012.08			R	Hatchback Engine BKD/CBAB/CFFB/CLJA	GC083037	Outer Joint	36	30	59.5	40.5	55	I					
	2.0 TDi 16V Quattro (103 kW)	2004.10-	2007.04	MT			Hatchback Engine BKD/CBAB/CFFB	GCI53002	Inner Joint		33		34						
		2004.10-	2007.04	MT	L		Hatchback Engine BKD/CBAB/CFFB	GDS83295	Drive Shaft	36		59.5	40	491					
2004.10-		2007.04		R		Hatchback Engine BKD/CBAB/CFFB	GDS83266	Drive Shaft	36		59.5	40	601						
2004.10-		2007.04	MT		F	Hatchback Engine BKD/CBAB/CFFB	GC083002	Outer Joint	36	27	59.5	40	66	I					
2004.10-		2007.04	MT	L	F	Hatchback Engine BKD/CBAB/CFFB	GDS83236	Drive Shaft	36		59.5	40	484						
2004.10-		2007.04			R	Hatchback Engine BKD/CBAB/CFFB	GC083037	Outer Joint	36	30	59.5	40.5	55	I					
2004.10-		2007.04	MT		R	Hatchback Engine BKD/CBAB/CFFB	GCI83011	Inner Joint		33		34							
2004.10-		2007.04	MT	L	R	Hatchback Engine BKD/CBAB/CFFB	GDS61284	Drive Shaft	36		59.5	79	594						
2004.10-		2007.04	MT	R	R	Hatchback Engine BKD/CBAB/CFFB	GDS61293	Drive Shaft	36		59.5	40	631						
2004.10-		2007.04			R	Hatchback Engine BKD/CBAB/CFFB	GCI83016	Inner Joint		28		32							
2.0 TDi Quattro (100 kW)	2003.05-	2008.06	MT		F	Hatchback Engine AZV	GC083002	Outer Joint	36	27	59.5	40	66	I					
	2003.05-	2008.06	MT	L	F	Hatchback Engine AZV	GDS83236	Drive Shaft	36		59.5	40	484						
	2003.05-	2008.06	MT		R	Hatchback Engine AZV	GCI83011	Inner Joint		33		34							
2.0 TDi Quattro (103 kW)	2003-				R	RWD	GC083037	Outer Joint	36	30	59.5	40.5	55	I					
	2006.01-	2008.06	MT			Hatchback Engine BMM	GCI53002	Inner Joint		33		34							
	2006.01-	2008.06	MT	L		Hatchback Engine BMM	GDS83295	Drive Shaft	36		59.5	40	491						
	2006.01-	2008.06	MT	R		Hatchback Engine BMM	GDS83266	Drive Shaft	36		59.5	40	601						
	2006.01-	2008.06	MT		F	Hatchback Engine BMM	GC083002	Outer Joint	36	27	59.5	40	66	I					
	2006.01-	2008.06	AT	L	F	Hatchback Engine BMM	GDS83241	Drive Shaft	36		59.5	40	475						
	2006.01-	2008.06	MT	L	F	Hatchback Engine BMM	GDS83236	Drive Shaft	36		59.5	40	484						
	2006.01-	2008.06	MT		R	Hatchback Engine BMM	GCI83011	Inner Joint		33		34							
	2006.01-	2008.06	MT	L	R	Hatchback Engine BMM	GDS61284	Drive Shaft	36		59.5	79	594						
	2006.01-	2008.06	MT	R	R	Hatchback Engine BMM	GDS61293	Drive Shaft	36		59.5	40	631						
2.0 TDi Quattro (125 kW)	2006.01-	2008.06	MT		R	Hatchback Engine BMM	GCI83016	Inner Joint		28		32							
	2006.02-	2008.06					GCI83016	Inner Joint		28		32							
	2006.05-	2007.04	MT		R	Hatchback Engine BMN/CBBB/CFGB	GCI83011	Inner Joint		33		34							
	2006.05-	2007.04	MT	L	R	Hatchback Engine BMN/CBBB/CFGB	GDS61284	Drive Shaft	36		59.5	79	594						
	2006.05-	2007.04	MT	R	R	Hatchback Engine BMN/CBBB/CFGB	GDS61293	Drive Shaft	36		59.5	40	631						
2006.05-	2007.04	MT	R		Hatchback Engine BMN/CBBB/CFGB	GCI83016	Inner Joint		28		32								









		TRANSM	L/R	F/R		G-AP Ref.	PRODUCT	ABS	Technical Specifications										
									YEAR	A	B	C	H	L	P				
<b>AUDI</b>																			
<b>A3 (8P1)</b>																			
2.0 TDi Quattro (125 kW)	2006.05-	2007.04	6AT			Hatchback Engine BMN/CBBB/CFGB	GCI54004	Inner Joint		34		85							
	2006.05-	2007.04	MT			Hatchback Engine BMN/CBBB/CFGB	GCI53002	Inner Joint		33		34							
	2006.05-	2007.04	MT	L		Hatchback Engine BMN/CBBB/CFGB	GDS83295	Drive Shaft	36		59.5	40	491						
	2006.05-	2007.04	MT	R		Hatchback Engine BMN/CBBB/CFGB	GDS83266	Drive Shaft	36		59.5	40	601						
	2006.05-	2007.04	MT		F	Hatchback Engine BMN/CBBB/CFGB	GC083002	Outer Joint	36	27	59.5	40	66	I					
	2006.05-	2007.04	MT	L	F	Hatchback Engine BMN/CBBB/CFGB	GDS83236	Drive Shaft	36		59.5	40	484						
2.0 TFSi (147 kW)	2004.06-	2010.05					GCI83016	Inner Joint		28		32							
	2004.07-	2007.04	MT		F	Hatchback Engine AXX/BWA/CAWB/CCZA	GCI53002	Inner Joint		33		34							
	2004.07-	2007.04	MT		F	Hatchback Engine AXX/BWA/CAWB/CCZA	GC083002	Outer Joint	36	27	59.5	40	66	I					
	2004.07-	2007.04		L	F	Hatchback Engine AXX/BWA/CAWB/CCZA	GDS83295	Drive Shaft	36		59.5	40	491						
	2004.07-	2007.04	MT	L	F	Hatchback Engine AXX/BWA/CAWB/CCZA	GDS83236	Drive Shaft	36		59.5	40	484						
	2004.07-	2007.04	MT	R	F	Hatchback Engine AXX/BWA/CAWB/CCZA	GDS61126	Drive Shaft	36		59.5	40	793						
	2004.07-	2007.04	Semi-AT	R	F	Hatchback Engine AXX/BWA/CAWB/CCZA	GDS83349	Drive Shaft	36		59.5	40	784						
2.0 TFSi Quattro (147 kW)	2004.06-	2008.06					GCI83016	Inner Joint		28		32							
	2004.10-	2007.04	MT			Hatchback Engine AXX/BWA/CCZA	GCI53002	Inner Joint		33		34							
	2004.10-	2007.04		L		Hatchback Engine AXX/BWA/CCZA	GDS83295	Drive Shaft	36		59.5	40	491						
	2004.10-	2007.04	MT	L	F	Hatchback Engine AXX/BWA/CCZA	GDS83236	Drive Shaft	36		59.5	40	484						
	2004.10-	2007.04	MT	R	F	Hatchback Engine AXX/BWA/CCZA	GDS61126	Drive Shaft	36		59.5	40	793						
	2004.10-	2007.04	Semi-AT	R	F	Hatchback Engine AXX/BWA/CCZA	GDS83349	Drive Shaft	36		59.5	40	784						
	2004.10-	2007.04	MT		R	Hatchback Engine AXX/BWA/CCZA	GCI83011	Inner Joint		33		34							
	2004.10-	2007.04	MT		R	Hatchback Engine AXX/BWA/CCZA	GCI83016	Inner Joint		28		32							
3.2 (184 kW)	2003.07-	2008.06					GCI83016	Inner Joint		28		32							
3.2 FSi Quattro (184 kW)	2008.07-	2009.05					GCI83016	Inner Joint		28		32							
3.2 V6 Quattro (184 kW)	2003.08-	2007.04	MT			Hatchback Engine BDB/BMJ/BUB	GCI53002	Inner Joint		33		34							
	2003.08-	2007.04		L		Hatchback Engine BDB/BMJ/BUB	GDS83295	Drive Shaft	36		59.5	40	491						
	2003.08-	2007.04	AT	R		Hatchback Engine BDB/BMJ/BUB	GDS83266	Drive Shaft	36		59.5	40	601						
	2003.08-	2007.04	MT		F	Hatchback Engine BDB/BMJ/BUB	GC083002	Outer Joint	36	27	59.5	40	66	I					
	2003.08-	2007.04	AT	L	F	Hatchback Engine BDB/BMJ/BUB	GDS83241	Drive Shaft	36		59.5	40	475						
	2003.08-	2007.04	MT	L	F	Hatchback Engine BDB/BMJ/BUB	GDS83236	Drive Shaft	36		59.5	40	484						
	2003.08-	2007.04	MT	R	F	Hatchback Engine BDB/BMJ/BUB	GCI83011	Inner Joint		33		34							
	2003.08-	2007.04	MT	L	R	Hatchback Engine BDB/BMJ/BUB	GDS61284	Drive Shaft	36		59.5	79	594						
	2003.08-	2007.04	MT	R	R	Hatchback Engine BDB/BMJ/BUB	GDS61293	Drive Shaft	36		59.5	40	631						
	2003.08-	2007.04	AT	R		Hatchback Engine BDB/BMJ/BUB	GCI83016	Inner Joint		28		32							
S3 2.0 16V Quattro (188 kW)	2006.11-	2010.05					GCI83016	Inner Joint		28		32							
S3 2.0 16V Quattro (195 kW)	2006.11-	2010.05					GCI83016	Inner Joint		28		32							
<b>A3 (8P7)</b>																			
1.2 TFSi (77 kW)	2010.03-		Semi-AT	L	F	Convertible Engine CBZB	GDS61201	Drive Shaft	36		59.5	40.5	535						
	2010.03-					Convertible Engine CBZB	GC083100	Outer Joint	36	33	59.5	38	55	I					
1.4 TFSi (92 kW)	2011.02-		7AT			Convertible Engine CAXC	GC061059	Outer Joint	36	33	59.5	40	59.5	I					
1.6 (75 kW)	2008.09-				F	Convertible Engine BSE	GC083037	Outer Joint	36	30	59.5	40.5	55	I					
	2008.09-				F	Convertible Engine BSE	GCI83011	Inner Joint		33		34							
	2008.09-			L	F	Convertible Engine BSE	GDS83320	Drive Shaft	36		59.5	40	546						
	2008.09-		7AT	L	F	Convertible Engine BSE	GDS61089	Drive Shaft	36		59.5	40.5	521						
	2008.09-			L	F	Convertible Engine BSE	GDS61089	Drive Shaft	36		59.5	40.5	521						
1.6 TDi (77 kW)	2009.05-				F	Convertible Engine CAYC	GC083037	Outer Joint	36	30	59.5	40.5	55	I					
	2009.05-				F	Convertible Engine CAYC	GCI83011	Inner Joint		33		34							
	2009.05-			L	F	Convertible Engine CAYC	GDS83294	Drive Shaft	36		59.5	38	519						
	2009.05-			R	F	Convertible Engine CAYC	GDS61042	Drive Shaft	36		59.5	40.5	814						
	2009.05-		AT	L	F	Convertible Engine CAYC	GDS83236	Drive Shaft	36		59.5	40	484						
	2009.05-		MT	L	F	Convertible Engine CAYC	GDS61089	Drive Shaft	36		59.5	40.5	521						
1.8 TFSi (118 kW)	2008.04-		MT		F	Convertible Engine BZB/CDA	GC083002	Outer Joint	36	27	59.5	40	66	I					
	2008.04-		AT	L	F	Convertible Engine BZB/CDA	GDS83295	Drive Shaft	36		59.5	40	491						
	2008.04-		7AT	L	F	Convertible Engine BZB/CDA	GDS83236	Drive Shaft	36		59.5	40	484						
	2008.04-		MT	L	F	Convertible Engine BZB/CDA	GDS61131	Drive Shaft	36		59.5	40	515						
1.9 TDi (77 kW)	2008.04-				F	Convertible Engine BLS	GCI83011	Inner Joint		33		34							
	2008.04-		5MT		F	Convertible Engine BLS	GC083037	Outer Joint	36	30	59.5	40.5	55	I					
	2008.04-			L	F	Convertible Engine BLS	GDS83294	Drive Shaft	36		59.5	38	519						
	2008.04-			R	F	Convertible Engine BLS	GDS61042	Drive Shaft	36		59.5	40.5	814						
	2008.04-		MT	L	F	Convertible Engine BLS	GDS61089	Drive Shaft	36		59.5	40.5	521						
2.0 TDi (100 kW)	2008.04-		AT	L	F	Convertible Engine CFFA/CBAA	GDS54013	Drive Shaft	36		59.5	40	479.5						
	2008.04-		AT	R	F	Convertible Engine CFFA/CBAA	GDS54011	Drive Shaft	36		59.5	40	755						
	2008.04-		MT	R	F	Convertible Engine CFFA/CBAA	GDS83313	Drive Shaft	36		59.5	40	792						
	2008.04-		AT	L	F	Convertible Engine CFFA/CBAA	GDS83241	Drive Shaft	36		59.5	40	475						



		TRANSM	L/R	F/R		G-AP Ref.	PRODUCT	ABS	Technical Specifications									
									YEAR	A	B	C	H	L	P			
<b>AUDI</b>																		
<b>A3 (8P7)</b>																		
2.0 TDi (100 kW)	2008.04-		MT	L	F	Convertible Engine CFFA/CBAA	GDS83236	Drive Shaft	36		59.5	40	484					
	2008.04-		AT	L/R	F	Convertible Engine CFFA/CBAA	GCI61057	Inner Joint		34		86						
2.0 TDi (103 kW)	2008.04-		6AT		F	Convertible Engine CBAB/CFFB	GCI54004	Inner Joint		34		85						
	2008.04-		MT		F	Convertible Engine CBAB/CFFB	GC083002	Outer Joint	36	27	59.5	40	66	I				
	2008.04-		AT	L	F	Convertible Engine CBAB/CFFB	GDS54013	Drive Shaft	36		59.5	40	479.5					
	2008.04-		MT	L	F	Convertible Engine CBAB/CFFB	GDS83295	Drive Shaft	36		59.5	40	491					
	2008.04-		AT	R	F	Convertible Engine CBAB/CFFB	GDS54011	Drive Shaft	36		59.5	40	755					
	2008.04-		MT	R	F	Convertible Engine CBAB/CFFB	GDS83313	Drive Shaft	36		59.5	40	792					
	2008.04-		AT	L	F	Convertible Engine CBAB/CFFB	GDS83236	Drive Shaft	36		59.5	40	484					
	2008.04-		MT	L	F	Convertible Engine CBAB/CFFB	GDS83241	Drive Shaft	36		59.5	40	475					
	2008.04-		AT	L/R	F	Convertible Engine CBAB/CFFB	GCI61057	Inner Joint		34		86						
	2008.04-		AT	R	F	Convertible Engine CBAB/CFFB	GDS83355	Drive Shaft	36	23	59.5	40	799					
2.0 TFSi (147 kW)	2008.04-		MT		F	Convertible Engine CAWB/CCZA	GC083002	Outer Joint	36	27	59.5	40	66	I				
	2008.04-			L	F	Convertible Engine CAWB/CCZA	GDS83295	Drive Shaft	36		59.5	40	491					
	2008.04-		MT/AT	L	F	Convertible Engine CAWB/CCZA	GDS83236	Drive Shaft	36		59.5	40	484					
	2008.04-		AT	R	F	Convertible Engine CAWB/CCZA	GDS83349	Drive Shaft	36		59.5	40	784					
	2008.04-		MT	R	F	Convertible Engine CAWB/CCZA	GDS61126	Drive Shaft	36		59.5	40	793					
<b>A3 (8P7), CABRIO</b>																		
1.6 (75 kW)	2008.09-	2010.05					GC083037	Outer Joint	36	30	59.5	40.5	55	I				
1.6 TDi (77 kW)	2009.05-					DOUBLE CLUTCH	GCI83016	Inner Joint		28		32						
	2009.05-					Double Clutch	GC083002	Outer Joint	36	27	59.5	40	66	I				
	2009.05-						GC083037	Outer Joint	36	30	59.5	40.5	55	I				
1.8 TFSi (118 kW)	2008.04-	2009.01					GC083002	Outer Joint	36	27	59.5	40	66	I				
	2008.04-	2012.04				DOUBLE CLUTCH	GCI83016	Inner Joint		28		32						
1.9 TDi (77 kW)	2009.02-		MT				GC083037	Outer Joint	36	30	59.5	40.5	55	I				
2.0 TDi (100 kW)	2008.04-	2010.05				Double Clutch	GC083002	Outer Joint	36	27	59.5	40	66	I				
2.0 TDi (103 kW)	2008.04-	2010.05				Double Clutch	GC083002	Outer Joint	36	27	59.5	40	66	I				
2.0 TFSi (147 kW)	2008.04-	2009.01					GCI83016	Inner Joint		28		32						
	2008.04-	2009.01					GC083002	Outer Joint	36	27	59.5	40	66	I				
<b>A3 (8PA)</b>																		
1.2 TSi (77 kW)	2010.04-		Semi-AT	L	F	Hatchback Engine CBZB	GDS61201	Drive Shaft	36		59.5	40.5	535					
	2010.04-					Hatchback Engine CBZB	GC083100	Outer Joint	36	33	59.5	38	55	I				
1.4 TFSi (92 kW)	2007.09-		AT		F	Hatchback Engine CAXC/CMSA	GC083002	Outer Joint	36	27	59.5	40	66	I				
	2007.09-		MT		F	Hatchback Engine CAXC/CMSA	GCI83011	Inner Joint		33		34						
	2007.09-					Hatchback Engine CAXC/CMSA	GC061059	Outer Joint	36	33	59.5	40	59.5	I				
1.6 (75 kW)	2005.06-	2007.04	6AT		F	Hatchback Engine CMXA/CCSA/BSF/BSE/BGU	GCI61011	Inner Joint	26	32	31	68.5	85					
	2005.06-	2007.04	AT		F	Hatchback Engine CMXA/CCSA/BSF/BSE/BGU	GC083037	Outer Joint	36	30	59.5	40.5	55	I				
	2005.06-	2007.04	MT		F	Hatchback Engine CMXA/CCSA/BSF/BSE/BGU	GCI83011	Inner Joint		33		34						
	2005.06-	2007.04	6AT	L	F	Hatchback Engine CMXA/CCSA/BSF/BSE/BGU	GDS61093	Drive Shaft	36	26	59.5	40.5	587.5					
	2005.06-	2007.04	6AT	L	F	Hatchback Engine CMXA/CCSA/BSF/BSE/BGU	GDS83318	Drive Shaft	36	26	59.5	38	581					
	2005.06-	2007.04	MT	L	F	Hatchback Engine CMXA/CCSA/BSF/BSE/BGU	GDS61097	Drive Shaft	36		59.5	40.5	543					
	2005.06-	2007.04	MT	L	F	Hatchback Engine CMXA/CCSA/BSF/BSE/BGU	GDS83320	Drive Shaft	36		59.5	40	546					
	2005.06-	2007.04	6AT	R	F	Hatchback Engine CMXA/CCSA/BSF/BSE/BGU	GDS83346	Drive Shaft	36	26	59.5	38	879					
	2005.06-	2007.04	6AT	R	F	Hatchback Engine CMXA/CCSA/BSF/BSE/BGU	GCI61011	Inner Joint	26	32	31	68.5	85					
	2005.06-	2007.04	6AT	R	F	Hatchback Engine CMXA/CCSA/BSF/BSE/BGU	GC083116	Outer Joint	36	30	59.5	38	55	I				
	2005.06-	2007.04	6AT	R	F	Hatchback Engine CMXA/CCSA/BSF/BSE/BGU	GDS61094	Drive Shaft	36	26	59.5	40.5	884					
	2005.06-	2007.04	MT	R	F	Hatchback Engine CMXA/CCSA/BSF/BSE/BGU	GDS61096	Drive Shaft	36		59.5	40.5	799					
1.6 FSi (85 kW)	2004.09-				F	Hatchback Engine BLF/BLP	GCI83011	Inner Joint		33		34						
	2004.09-		5MT		F	Hatchback Engine BLF/BLP	GC083037	Outer Joint	36	30	59.5	40.5	55	I				
	2004.09-		6MT	L	F	Hatchback Engine BLF/BLP	GDS83319	Drive Shaft	36		59.5	38	557					
	2004.09-		6MT	R	F	Hatchback Engine BLF/BLP	GDS61211	Drive Shaft	36		59.5	40.5	784					
1.6 TDi (66 kW)	2009.05-				F	Hatchback Engine CAYB	GC083037	Outer Joint	36	30	59.5	40.5	55	I				
	2009.05-		MT		F	Hatchback Engine CAYB	GCI53002	Inner Joint		33		34						
	2009.05-			L	F	Hatchback Engine CAYB	GDS83294	Drive Shaft	36		59.5	38	519					
	2009.05-			R	F	Hatchback Engine CAYB	GDS61042	Drive Shaft	36		59.5	40.5	814					
	2009.05-			L	F	Hatchback Engine CAYB	GDS61089	Drive Shaft	36		59.5	40.5	521					
1.6 TDi (77 kW)	2009.05-				F	Hatchback Engine CAYC	GC083037	Outer Joint	36	30	59.5	40.5	55	I				
	2009.05-		MT		F	Hatchback Engine CAYC	GCI53002	Inner Joint		33		34						
	2009.05-		MT	L	F	Hatchback Engine CAYC	GDS83294	Drive Shaft	36		59.5	38	519					
	2009.05-		MT	R	F	Hatchback Engine CAYC	GDS61042	Drive Shaft	36		59.5	40.5	814					
	2009.05-		AT	L	F	Hatchback Engine CAYC	GDS83236	Drive Shaft	36		59.5	40	484					
	2009.05-		MT	L	F	Hatchback Engine CAYC	GDS61089	Drive Shaft	36		59.5	40.5	521					

		YEAR	TRANSM	L/R	F/R		G-AP Ref.	PRODUCT	ABS	Technical Specifications										
										A	B	C	H	L	P					
<b>AUDI</b>																				
<b>A3 (8PA)</b>																				
1.6 TDi (77 kW)	2009.05-					Hatchback Engine CAYC	GC061059	Outer Joint		36	33	59.5	40	59.5						
1.8 TFSi (118 kW)	2006.10-	2007.04	MT		F	Hatchback Engine BYT/BZB/CDAA	GC153002	Inner Joint			33		34							
	2006.10-	2007.04	MT		F	Hatchback Engine BYT/BZB/CDAA	GC083002	Outer Joint	36	27	59.5	40	66							
	2006.10-	2007.04		L	F	Hatchback Engine BYT/BZB/CDAA	GDS83295	Drive Shaft	36		59.5	40	491							
	2006.10-	2007.04	AT	L	F	Hatchback Engine BYT/BZB/CDAA	GDS83236	Drive Shaft	36		59.5	40	484							
	2006.10-	2007.04	MT	L	F	Hatchback Engine BYT/BZB/CDAA	GDS61131	Drive Shaft	36		59.5	40	515							
	2006.10-	2007.04	MT	R	F	Hatchback Engine BYT/BZB/CDAA	GDS83313	Drive Shaft	36		59.5	40	792							
1.8 TFSi Quattro (118 kW)	2008.07-		MT			Hatchback Engine CDAA	GC153002	Inner Joint		33		34								
	2008.07-		AT	L		Hatchback Engine CDAA	GDS83295	Drive Shaft	36		59.5	40	491							
	2008.07-				R	Hatchback Engine CDAA	GDS83266	Drive Shaft	36		59.5	40	601							
	2008.07-		MT&AT		F	Hatchback Engine CDAA	GC083002	Outer Joint	36	27	59.5	40	66							
	2008.07-				R	Hatchback Engine CDAA	GC183016	Inner Joint			28		32							
1.9 TDi (77 kW)	2005.06-	2007.04			F	Hatchback Engine BKC/BLS/BXE	GC083037	Outer Joint	36	30	59.5	40.5	55							
	2005.06-	2007.04	6AT		F	Hatchback Engine BKC/BLS/BXE	GC083002	Outer Joint	36	27	59.5	40	66							
	2005.06-	2007.04	MT		F	Hatchback Engine BKC/BLS/BXE	GC183011	Inner Joint			33		34							
	2005.06-	2007.04	6AT	L	F	Hatchback Engine BKC/BLS/BXE	GDS54013	Drive Shaft	36		59.5	40	479.5							
	2005.06-	2007.04	MT	L	F	Hatchback Engine BKC/BLS/BXE	GDS61089	Drive Shaft	36		59.5	40.5	521							
	2005.06-	2007.04	MT	L	F	Hatchback Engine BKC/BLS/BXE	GDS83294	Drive Shaft	36		59.5	38	519							
	2005.06-	2007.04	AT	L/R	F	Hatchback Engine BKC/BLS/BXE	GC161057	Inner Joint		34		86								
	2005.06-	2007.04	AT	R	F	Hatchback Engine BKC/BLS/BXE	GDS83355	Drive Shaft	36	23	59.5	40	799							
	2005.06-	2007.04	AT	R	F	Hatchback Engine BKC/BLS/BXE	GDS54011	Drive Shaft	36		59.5	40	755							
	2005.06-	2007.04	MT	R	F	Hatchback Engine BKC/BLS/BXE	GDS61042	Drive Shaft	36		59.5	40.5	814							
2.0 FSi (110 kW)	2005.06-	2007.04			F	Hatchback Engine BLR/BLX/BLY/BMB/BVY/BVZ	GC083037	Outer Joint	36	30	59.5	40.5	55							
	2005.06-	2007.04	6AT		F	Hatchback Engine BLR/BLX/BLY/BMB/BVY/BVZ	GC161011	Inner Joint	26	32	31	68.5	85							
	2005.06-	2007.04	MT		F	Hatchback Engine BLR/BLX/BLY/BMB/BVY/BVZ	GC183011	Inner Joint			33		34							
	2005.06-	2007.04	6AT	L	F	Hatchback Engine BLR/BLX/BLY/BMB/BVY/BVZ	GDS61093	Drive Shaft	36	26	59.5	40.5	587.5							
	2005.06-	2007.04		L	F	Hatchback Engine BLR/BLX/BLY/BMB/BVY/BVZ	GDS83236	Drive Shaft	36		59.5	40	484							
	2005.06-	2007.04	6AT	R	F	Hatchback Engine BLR/BLX/BLY/BMB/BVY/BVZ	GDS61094	Drive Shaft	36	26	59.5	40.5	884							
	2005.06-	2007.04		R	F	Hatchback Engine BLR/BLX/BLY/BMB/BVY/BVZ	GDS61126	Drive Shaft	36		59.5	40	793							
2.0 S3 Quattro (188 kW)	2008.07-		MT			Hatchback Engine CDLC	GC153002	Inner Joint		33		34								
	2008.07-			L		Hatchback Engine CDLC	GDS83295	Drive Shaft	36		59.5	40	491							
2.0 S3 Quattro (195 kW)	2008.06-		MT			Hatchback Engine BHZ/CDLA	GC153002	Inner Joint		33		34								
	2008.06-			L		Hatchback Engine BHZ/CDLA	GDS83295	Drive Shaft	36		59.5	40	491							
	2008.06-				F	Hatchback Engine BHZ/CDLA	GC083002	Outer Joint	36	27	59.5	40	66							
	2008.06-		MT		R	Hatchback Engine BHZ/CDLA	GC183011	Inner Joint			33		34							
2.0 TDi (100 kW)	2004.09-		AT	L	F	Hatchback Engine CFFA/CBAA/AZV	GDS54013	Drive Shaft	36		59.5	40	479.5							
	2004.09-		MT	L	F	Hatchback Engine CFFA/CBAA/AZV	GDS83265	Drive Shaft	36		59.5	40	487							
	2004.09-		AT	R	F	Hatchback Engine CFFA/CBAA/AZV	GDS54011	Drive Shaft	36		59.5	40	755							
	2004.09-		MT	L	F	Hatchback Engine CFFA/CBAA/AZV	GDS83236	Drive Shaft	36		59.5	40	484							
	2004.09-		MT	L	F	Hatchback Engine CFFA/CBAA/AZV	GC183016	Inner Joint			28		32							
	2004.09-		AT	L/R	F	Hatchback Engine CFFA/CBAA/AZV	GC161057	Inner Joint		34		86								
	2004.09-		AT	R	F	Hatchback Engine CFFA/CBAA/AZV	GDS83355	Drive Shaft	36	23	59.5	40	799							
	2004.09-		MT	R	F	Hatchback Engine CFFA/CBAA/AZV	GDS61126	Drive Shaft	36		59.5	40	793							
2.0 TDi (103 kW)	2004.11-	2007.04	MT		F	Hatchback Engine BMM	GC153002	Inner Joint		33		34								
	2004.11-	2007.04	MT		F	Hatchback Engine BMM	GC083002	Outer Joint	36	27	59.5	40	66							
	2004.11-	2007.04	AT	L	F	Hatchback Engine BMM	GDS83241	Drive Shaft	36		59.5	40	475							
	2004.11-	2007.04	AT	L	F	Hatchback Engine BMM	GDS54013	Drive Shaft	36		59.5	40	479.5							
	2004.11-	2007.04	MT	L	F	Hatchback Engine BMM	GDS83236	Drive Shaft	36		59.5	40	484							
	2004.11-	2007.04	MT	L	F	Hatchback Engine BMM	GC183016	Inner Joint			28		32							
	2004.11-	2007.04	MT	L	F	Hatchback Engine BMM	GDS83265	Drive Shaft	36		59.5	40	487							
	2004.11-	2007.04	MT	L	F	Hatchback Engine BMM	GDS83295	Drive Shaft	36		59.5	40	491							
	2004.11-	2007.04	AT	L/R	F	Hatchback Engine BMM	GC161057	Inner Joint		34		86								
	2004.11-	2007.04	AT	R	F	Hatchback Engine BMM	GDS83355	Drive Shaft	36	23	59.5	40	799							
	2004.11-	2007.04	AT	R	F	Hatchback Engine BMM	GDS54011	Drive Shaft	36		59.5	40	755							
	2004.11-	2007.04	MT	R	F	Hatchback Engine BMM	GDS61126	Drive Shaft	36		59.5	40	793							
	2004.11-	2007.04	MT	R	F	Hatchback Engine BMM	GDS83313	Drive Shaft	36		59.5	40	792							
	2.0 TDi (120 kW)	2006.06-	2008.06	MT	L	F	Hatchback Engine BUY	GDS83236	Drive Shaft	36		59.5	40	484						
2006.06-		2008.06	MT	L	F	Hatchback Engine BUY	GC183016	Inner Joint			28		32							
2006.06-		2008.06	MT	L	F	Hatchback Engine BUY	GDS83265	Drive Shaft	36		59.5	40	487							
2006.06-		2008.06	AT	L/R	F	Hatchback Engine BUY	GC161057	Inner Joint		34		86								
2006.06-		2008.06	AT	R	F	Hatchback Engine BUY	GDS83355	Drive Shaft	36	23	59.5	40	799							
2006.06-		2008.06	AT	R	F	Hatchback Engine BUY	GDS54011	Drive Shaft	36		59.5	40	755							









		TRANSM	L/R	F/R		G-AP Ref.	PRODUCT	ABS	Technical Specifications											
									YEAR	A	B	C	H	L	P					
<b>AUDI</b>																				
<b>A3 (8PA)</b>																				
2.0 TDi (120 kW)	2006.06-	2008.06	MT	R	F	Hatchback Engine BUY	GDS61126	Drive Shaft	36		59.5	40	793							
2.0 TDi (125 kW)	2006.05-	2007.04	6AT		F	Hatchback Engine BMN/CBBB/CFGB	GCI54004	Inner Joint		34		85								
	2006.05-	2007.04	MT		F	Hatchback Engine BMN/CBBB/CFGB	GCI53002	Inner Joint		33		34								
	2006.05-	2007.04	MT		F	Hatchback Engine BMN/CBBB/CFGB	GC061045	Outer Joint	36	27	59.5	40	65	M						
	2006.05-	2007.04	MT	L	F	Hatchback Engine BMN/CBBB/CFGB	GDS83236	Drive Shaft	36		59.5	40	484							
	2006.05-	2007.04	MT	L	F	Hatchback Engine BMN/CBBB/CFGB	GCI83016	Inner Joint		28		32								
	2006.05-	2007.04	MT	L	F	Hatchback Engine BMN/CBBB/CFGB	GDS83265	Drive Shaft	36		59.5	40	487							
	2006.05-	2007.04	SEMI-AT	L	F	Hatchback Engine BMN/CBBB/CFGB	GDS83241	Drive Shaft	36		59.5	40	475							
	2006.05-	2007.04	AT	L/R	F	Hatchback Engine BMN/CBBB/CFGB	GCI61057	Inner Joint		34		86								
	2006.05-	2007.04	AT	R	F	Hatchback Engine BMN/CBBB/CFGB	GDS83355	Drive Shaft	36	23	59.5	40	799							
	2006.05-	2007.04	MT	R	F	Hatchback Engine BMN/CBBB/CFGB	GDS61126	Drive Shaft	36		59.5	40	793							
2.0 TDi 16V (103 kW)	2005.06-	2007.02	MT		F	Hatchback Engine BKD/CBAB/CFFB/CLJA	GCI53002	Inner Joint		33		34								
	2005.06-	2007.02	MT		F	Hatchback Engine BKD/CBAB/CFFB/CLJA	GC083002	Outer Joint	36	27	59.5	40	66	I						
	2005.06-	2007.02	AT	L	F	Hatchback Engine BKD/CBAB/CFFB/CLJA	GDS83241	Drive Shaft	36		59.5	40	475							
	2005.06-	2007.02	AT	L	F	Hatchback Engine BKD/CBAB/CFFB/CLJA	GDS54013	Drive Shaft	36		59.5	40	479.5							
	2005.06-	2007.02	MT	L	F	Hatchback Engine BKD/CBAB/CFFB/CLJA	GDS83236	Drive Shaft	36		59.5	40	484							
	2005.06-	2007.02	MT	L	F	Hatchback Engine BKD/CBAB/CFFB/CLJA	GCI83016	Inner Joint		28		32								
	2005.06-	2007.02	MT	L	F	Hatchback Engine BKD/CBAB/CFFB/CLJA	GDS83265	Drive Shaft	36		59.5	40	487							
	2005.06-	2007.02	MT	L	F	Hatchback Engine BKD/CBAB/CFFB/CLJA	GDS83295	Drive Shaft	36		59.5	40	491							
	2005.06-	2007.02	AT	L/R	F	Hatchback Engine BKD/CBAB/CFFB/CLJA	GCI61057	Inner Joint		34		86								
	2005.06-	2007.02	AT	R	F	Hatchback Engine BKD/CBAB/CFFB/CLJA	GDS83355	Drive Shaft	36	23	59.5	40	799							
	2005.06-	2007.02	AT	R	F	Hatchback Engine BKD/CBAB/CFFB/CLJA	GDS54011	Drive Shaft	36		59.5	40	755							
	2005.06-	2007.02	MT	R	F	Hatchback Engine BKD/CBAB/CFFB/CLJA	GDS61126	Drive Shaft	36		59.5	40	793							
	2005.06-	2007.02			R	Hatchback Engine BKD/CBAB/CFFB/CLJA	GC083037	Outer Joint	36	30	59.5	40.5	55	I						
	2.0 TDi 16V Quattro (103 kW)	2005.11-		MT			Hatchback Engine BKD/CBAB/CFFB	GCI53002	Inner Joint		33		34							
		2005.11-		MT	L		Hatchback Engine BKD/CBAB/CFFB	GDS83295	Drive Shaft	36		59.5	40	491						
2005.11-				R		Hatchback Engine BKD/CBAB/CFFB	GDS83266	Drive Shaft	36		59.5	40	601							
2005.11-			MT		F	Hatchback Engine BKD/CBAB/CFFB	GC083002	Outer Joint	36	27	59.5	40	66	I						
2005.11-			MT		R	Hatchback Engine BKD/CBAB/CFFB	GCI83011	Inner Joint		33		34								
2005.11-			AT	L	F	Hatchback Engine BKD/CBAB/CFFB	GDS83241	Drive Shaft	36		59.5	40	475							
2005.11-			MT	L	F	Hatchback Engine BKD/CBAB/CFFB	GDS83236	Drive Shaft	36		59.5	40	484							
2005.11-			AT	L/R	F	Hatchback Engine BKD/CBAB/CFFB	GCI61057	Inner Joint		34		86								
2005.11-			AT	R	F	Hatchback Engine BKD/CBAB/CFFB	GDS83355	Drive Shaft	36	23	59.5	40	799							
2005.11-			MT	L	R	Hatchback Engine BKD/CBAB/CFFB	GDS61284	Drive Shaft	36		59.5	79	594							
2005.11-			MT	R	R	Hatchback Engine BKD/CBAB/CFFB	GDS61293	Drive Shaft	36		59.5	40	631							
2005.11-					R	Hatchback Engine BKD/CBAB/CFFB	GCI83016	Inner Joint		28		32								
2.0 TDi Quattro (103 kW)	2006.01-	2008.06	MT			Hatchback Engine BMM	GCI53002	Inner Joint		33		34								
	2006.01-	2008.06	MT	L		Hatchback Engine BMM	GDS83295	Drive Shaft	36		59.5	40	491							
	2006.01-	2008.06		R		Hatchback Engine BMM	GDS83266	Drive Shaft	36		59.5	40	601							
	2006.01-	2008.06	MT		F	Hatchback Engine BMM	GC083002	Outer Joint	36	27	59.5	40	66	I						
	2006.01-	2008.06	MT	L	F	Hatchback Engine BMM	GDS83236	Drive Shaft	36		59.5	40	484							
	2006.01-	2008.06	SEMI-AT	L	F	Hatchback Engine BMM	GDS83241	Drive Shaft	36		59.5	40	475							
	2006.01-	2008.06	AT	L/R	F	Hatchback Engine BMM	GCI61057	Inner Joint		34		86								
	2006.01-	2008.06	AT	R	F	Hatchback Engine BMM	GDS83355	Drive Shaft	36	23	59.5	40	799							
	2006.01-	2008.06	MT		R	Hatchback Engine BMM	GCI83011	Inner Joint		33		34								
	2006.01-	2008.06	MT	L	R	Hatchback Engine BMM	GDS61284	Drive Shaft	36		59.5	79	594							
	2006.01-	2008.06	MT	R	R	Hatchback Engine BMM	GDS61293	Drive Shaft	36		59.5	40	631							
	2006.01-	2008.06			R	Hatchback Engine BMM	GCI83016	Inner Joint		28		32								
	2.0 TDi Quattro (125 kW)	2006.05-	2007.04	6AT			Hatchback Engine BMN/CBBB/CFGB	GCI54004	Inner Joint		34		85							
2006.05-		2007.04	MT			Hatchback Engine BMN/CBBB/CFGB	GCI53002	Inner Joint		33		34								
2006.05-		2007.04	MT	L		Hatchback Engine BMN/CBBB/CFGB	GDS83295	Drive Shaft	36		59.5	40	491							
2006.05-		2007.04		R		Hatchback Engine BMN/CBBB/CFGB	GDS83266	Drive Shaft	36		59.5	40	601							
2006.05-		2007.04	MT		F	Hatchback Engine BMN/CBBB/CFGB	GC083002	Outer Joint	36	27	59.5	40	66	I						
2006.05-		2007.04	MT	L	F	Hatchback Engine BMN/CBBB/CFGB	GDS83236	Drive Shaft	36		59.5	40	484							
2006.05-		2007.04	SEMI-AT	L	F	Hatchback Engine BMN/CBBB/CFGB	GDS83241	Drive Shaft	36		59.5	40	475							
2006.05-		2007.04	AT	L/R	F	Hatchback Engine BMN/CBBB/CFGB	GCI61057	Inner Joint		34		86								
2006.05-		2007.04	AT	R	F	Hatchback Engine BMN/CBBB/CFGB	GDS83355	Drive Shaft	36	23	59.5	40	799							
2006.05-		2007.04	MT		R	Hatchback Engine BMN/CBBB/CFGB	GCI83011	Inner Joint		33		34								
2006.05-		2007.04	MT	L	R	Hatchback Engine BMN/CBBB/CFGB	GDS61284	Drive Shaft	36		59.5	79	594							
2006.05-		2007.04	MT	R	R	Hatchback Engine BMN/CBBB/CFGB	GDS61293	Drive Shaft	36		59.5	40	631							
2006.05-		2007.04			R	Hatchback Engine BMN/CBBB/CFGB	GCI83016	Inner Joint		28		32								

		YEAR	TRANSM	L/R	F/R		G-AP Ref.	PRODUCT	ABS	Technical Specifications						
										A	B	C	H	L	P	
<b>AUDI</b>																
<b>A3 (8PA)</b>																
2.0 TFSi (147 kW)	2005.06-	2007.04	MT		F	Hatchback Engine AXX/BWA/CAWB/CBFA/CCZA	GCI53002	Inner Joint		33		34				
	2005.06-	2007.04	MT		F	Hatchback Engine AXX/BWA/CAWB/CBFA/CCZA	GC083002	Outer Joint	36	27	59.5	40	66	I		
	2005.06-	2007.04		L	F	Hatchback Engine AXX/BWA/CAWB/CBFA/CCZA	GDS83295	Drive Shaft	36		59.5	40	491			
	2005.06-	2007.04	MT/Semi-AT	L	F	Hatchback Engine AXX/BWA/CAWB/CBFA/CCZA	GDS83236	Drive Shaft	36		59.5	40	484			
	2005.06-	2007.04	MT	R	F	Hatchback Engine AXX/BWA/CAWB/CBFA/CCZA	GDS61126	Drive Shaft	36		59.5	40	793			
	2005.06-	2007.04	Semi-AT	R	F	Hatchback Engine AXX/BWA/CAWB/CBFA/CCZA	GDS83349	Drive Shaft	36		59.5	40	784			
2.0 TFSi Quattro (147 kW)	2007.02-	2007.04	MT			Hatchback Engine AXX/BPY/BWA/CCZA	GCI53002	Inner Joint		33		34				
	2007.02-	2007.04		L		Hatchback Engine AXX/BPY/BWA/CCZA	GDS83295	Drive Shaft	36		59.5	40	491			
	2007.02-	2007.04	MT		F	Hatchback Engine AXX/BPY/BWA/CCZA	GC083002	Outer Joint	36	27	59.5	40	66	I		
	2007.02-	2007.04	MT	L	F	Hatchback Engine AXX/BPY/BWA/CCZA	GDS83236	Drive Shaft	36		59.5	40	484			
	2007.02-	2007.04	MT		R	Hatchback Engine AXX/BPY/BWA/CCZA	GCI83011	Inner Joint		33		34				
3.2 V6 Quattro (184 kW)	2005.06-	2007.04	MT/AT	L		Hatchback Engine BMJ/BUB	GDS83295	Drive Shaft	36		59.5	40	491			
	2005.06-	2007.04	MT	R		Hatchback Engine BMJ/BUB	GDS83266	Drive Shaft	36		59.5	40	601			
	2005.06-	2007.04	MT		F	Hatchback Engine BMJ/BUB	GC083002	Outer Joint	36	27	59.5	40	66	I		
	2005.06-	2007.04	MT	R		Hatchback Engine BMJ/BUB	GCI83011	Inner Joint		33		34				
	2005.06-	2007.04	MT	L	R	Hatchback Engine BMJ/BUB	GDS61284	Drive Shaft	36		59.5	79	594			
	2005.06-	2007.04	MT	R	R	Hatchback Engine BMJ/BUB	GDS61293	Drive Shaft	36		59.5	40	631			
	2005.06-	2007.04	MT		R	Hatchback Engine BMJ/BUB	GCI83016	Inner Joint		28		32				
	2005.06-	2007.04	MT			Hatchback Engine BMJ/BUB	GCI53002	Inner Joint		33		34				
<b>A3 (8V1)</b>																
1.2 TFSi (77 kW)	2013.02-		MT	R	F	Hatchback Engine CJZA	GDS61200	Drive Shaft	36		59.5	40.5	820			
	2013.02-		MT			Hatchback Engine CJZA	GC083100	Outer Joint	36	33	59.5	38	55	I		
	2013.02-					Hatchback Engine CJZA	GC061059	Outer Joint	36	33	59.5	40	59.5	I		
1.2 TFSi (81 kW)	2014.05-		MT			Hatchback Engine CYVB	GC083100	Outer Joint	36	33	59.5	38	55	I		
1.4 TFSi (103 kW)	2013.03-		AT			Hatchback Engine CPTA	GC083101	Outer Joint	36	27	59.5	40	65	M		
	2013.03-		MT			Hatchback Engine CPTA	GC083100	Outer Joint	36	33	59.5	38	55	I		
	2013.03-					Hatchback Engine CPTA	GC061059	Outer Joint	36	33	59.5	40	59.5	I		
1.4 TFSi (110 kW)	2014.05-		AT			Hatchback Engine CZEA	GC083101	Outer Joint	36	27	59.5	40	65	M		
	2014.05-		MT			Hatchback Engine CZEA	GC083100	Outer Joint	36	33	59.5	38	55	I		
1.4 TFSi (90 kW)	2012.04-		MT	R	F	Hatchback Engine CMBA/CXSA	GDS61200	Drive Shaft	36		59.5	40.5	820			
	2012.04-		MT			Hatchback Engine CMBA/CXSA	GC083100	Outer Joint	36	33	59.5	38	55	I		
	2012.04-					Hatchback Engine CMBA/CXSA	GC061059	Outer Joint	36	33	59.5	40	59.5	I		
1.4 TFSi (92 kW)	2014.05-		MT			Hatchback Engine CXSB/CZCA	GC083100	Outer Joint	36	33	59.5	38	55	I		
1.6 TDi (77 kW)	2012.10-		MT	R	F	Hatchback Engine CLHA	GDS61200	Drive Shaft	36		59.5	40.5	820			
	2012.10-		MT			Hatchback Engine CLHA	GC083100	Outer Joint	36	33	59.5	38	55	I		
	2012.10-					Hatchback Engine CLHA	GC061059	Outer Joint	36	33	59.5	40	59.5	I		
1.6 TDi (81 kW)	2013.09-		MT			Hatchback Engine CRKB/CXXB/DBKA	GC083100	Outer Joint	36	33	59.5	38	55	I		
1.8 TFSi (132 kW)	2012.04-		MT	L	F	Hatchback Engine CJSA	GDS61304	Drive Shaft	36		59.5	40	511			
	2012.04-					Hatchback Engine CJSA	GC083101	Outer Joint	36	27	59.5	40	65	M		
2.0 TDi (100 kW)	2013.05-					Hatchback Engine CRBD/CRLC	GC083101	Outer Joint	36	27	59.5	40	65	M		
2.0 TDi (105 kW)	2012.09-					Hatchback Engine CRFC	GC083101	Outer Joint	36	27	59.5	40	65	M		
2.0 TDi (110 kW)	2012.04-		MT			Hatchback Engine CRBC/CRLB/CRUA	GC083101	Outer Joint	36	27	59.5	40	65	M		
2.0 TDi (81 kW)	2013.01-		MT	R	F	Hatchback Engine CRFA	GDS61200	Drive Shaft	36		59.5	40.5	820			
	2013.01-		MT			Hatchback Engine CRFA	GC083100	Outer Joint	36	33	59.5	38	55	I		
	2013.01-					Hatchback Engine CRFA	GC061059	Outer Joint	36	33	59.5	40	59.5	I		
2.0 TDi Quattro (110 kW)	2012.10-					Hatchback Engine CRBC	GC083101	Outer Joint	36	27	59.5	40	65	M		
<b>A3 (8V1), SPORTBACK (8VA)</b>																
1.2 TSi (77 kW)	2013.02-		MT				GC083037	Outer Joint	36	30	59.5	40.5	55	I		
1.4 TFSi (103 kW)	2013.03-					DOUBLE CLUTCH	GCI83016	Inner Joint		28		32				
1.8 TFSi (118 kW)	2012.04-		MT			DOUBLE CLUTCH	GCI83016	Inner Joint		28		32				
2.0 TDi (110 kW)	2012.04-		MT				GCI83016	Inner Joint		28		32				
2.0 TDi (135 kW)	2012.04-		MT				GCI83016	Inner Joint		28		32				
2.0 TDi Quattro (110 kW)	2012.04-		MT				GCI83016	Inner Joint		28		32				
2.0 TDi Quattro (135 kW)	2012.04-		MT				GCI83016	Inner Joint		28		32				
<b>A3 (8V7)</b>																
1.4 TFSi (103 kW)	2013.10-		AT			Convertible Engine CPTA	GC083101	Outer Joint	36	27	59.5	40	65	M		
	2013.10-		MT			Convertible Engine CPTA	GC083100	Outer Joint	36	33	59.5	38	55	I		
1.4 TFSi (110 kW)	2014.05-		AT			Convertible Engine CZEA	GC083101	Outer Joint	36	27	59.5	40	65	M		
	2014.05-		MT			Convertible Engine CZEA	GC083100	Outer Joint	36	33	59.5	38	55	I		
1.4 TFSi (92 kW)	2014.02-		MT	L	F	Convertible Engine CXSB	GDS53007	Drive Shaft	36		59.5	40	559			
1.6 TDi (81 kW)	2014.02-		MT			Convertible Engine CRKB	GC083100	Outer Joint	36	33	59.5	38	55	I		
1.8 TFSi (132 kW)	2013.10-		MT	L	F	Convertible Engine CJSA	GDS61304	Drive Shaft	36		59.5	40	511			



		TRANSM	L/R	F/R		G-AP Ref.	PRODUCT	ABS	Technical Specifications									
									YEAR	A	B	C	H	L	P			
<b>AUDI</b>																		
<b>A3 (8V7)</b>																		
1.8 TFSi (132 kW)	2013.10-				Convertible Engine CJSA	GC083101	Outer Joint		36	27	59.5	40	65	M				
2.0 TDi (100 kW)	2013.10-				Convertible Engine CRLC	GC083101	Outer Joint		36	27	59.5	40	65	M				
<b>A3 CONVERTIBLE (8V7)</b>																		
2.0 TDi (110 kW)	2013.10-		MT		Convertible Engine CRLB	GC083101	Outer Joint		36	27	59.5	40	65	M				
2.0 TDi Quattro (110 kW)	2014.03-		MT		Convertible Engine CRLB	GC083101	Outer Joint		36	27	59.5	40	65	M				
<b>A3 I QUATTRO</b>																		
1.8	1996.09-	2003.05	MT		F		Inner Joint			33		34						
1.8 Turbo	1996.09-	2003.05	MT		F		Inner Joint			33		34						
<b>A3 LIMOUSINE (8VS)</b>																		
1.2 TFSi (77 kW)	2013.10-		MT	R	F	Saloon Engine CJZA	GDS61200	Drive Shaft	36		59.5	40.5	820					
	2013.10-		MT			Saloon Engine CJZA	GC083100	Outer Joint	36	33	59.5	38	55	I				
	2013.10-					Saloon Engine CJZA	GC061059	Outer Joint	36	33	59.5	40	59.5	I				
1.2 TFSi (81 kW)	2014.05-		MT			Saloon Engine CYVB	GC083100	Outer Joint	36	33	59.5	38	55	I				
1.4 TFSi (103 kW)	2013.05-		MT		F	Saloon Engine CPTA	GC083100	Outer Joint	36	33	59.5	38	55	I				
	2013.05-		AT			Saloon Engine CPTA	GC083101	Outer Joint	36	27	59.5	40	65	M				
	2013.05-					Saloon Engine CPTA	GC061059	Outer Joint	36	33	59.5	40	59.5	I				
1.4 TFSi (110 kW)	2014.05-		AT			Saloon Engine CZEA	GC083101	Outer Joint	36	27	59.5	40	65	M				
	2014.05-		MT			Saloon Engine CZEA	GC083100	Outer Joint	36	33	59.5	38	55	I				
1.4 TFSi (90 kW)	2013.09-		MT	R	F	Saloon Engine CMBA/CXSA	GDS61200	Drive Shaft	36		59.5	40.5	820					
	2013.09-		MT			Saloon Engine CMBA/CXSA	GC083100	Outer Joint	36	33	59.5	38	55	I				
	2013.09-					Saloon Engine CMBA/CXSA	GC061059	Outer Joint	36	33	59.5	40	59.5	I				
1.4 TFSi (92 kW)	2013.09-		MT			Saloon Engine CXSB	GC083100	Outer Joint	36	33	59.5	38	55	I				
	2013.09-					Saloon Engine CXSB	GC061059	Outer Joint	36	33	59.5	40	59.5	I				
1.6 TDi (77 kW)	2013.09-		MT	R	F	Saloon Engine CLHA	GDS61200	Drive Shaft	36		59.5	40.5	820					
	2013.09-		MT			Saloon Engine CLHA	GC083100	Outer Joint	36	33	59.5	38	55	I				
	2013.09-					Saloon Engine CLHA	GC061059	Outer Joint	36	33	59.5	40	59.5	I				
1.6 TDi (81 kW)	2014.05-		MT			Saloon Engine CRKB	GC083100	Outer Joint	36	33	59.5	38	55	I				
1.8 TFSi (132 kW)	2013.05-		MT	L	F	Saloon Engine CJSA/CJSB	GDS61304	Drive Shaft	36		59.5	40	511					
	2013.05-					Saloon Engine CJSA/CJSB	GC083101	Outer Joint	36	27	59.5	40	65	M				
1.8 TFSi Quattro (132 kW)	2013.11-		MT	L	F	Saloon Engine CJSB	GDS61304	Drive Shaft	36		59.5	40	511					
	2013.11-					Saloon Engine CJSB	GC083101	Outer Joint	36	27	59.5	40	65	M				
2.0 TDi (100 kW)	2013.09-					Saloon Engine CRBD/CRLC	GC083101	Outer Joint	36	27	59.5	40	65	M				
2.0 TDi (105 kW)	2013.10-					Saloon Engine CRFC	GC083101	Outer Joint	36	27	59.5	40	65	M				
2.0 TDi (110 kW)	2013.05-					Saloon Engine CRBC/CRLB/CRUA	GC083101	Outer Joint	36	27	59.5	40	65	M				
2.0 TDi (81 kW)	2013.05-		MT	R	F	Saloon Engine CRFA	GDS61200	Drive Shaft	36		59.5	40.5	820					
	2013.05-		MT			Saloon Engine CRFA	GC083100	Outer Joint	36	33	59.5	38	55	I				
	2013.05-					Saloon Engine CRFA	GC061059	Outer Joint	36	33	59.5	40	59.5	I				
2.0 TDi Quattro (110 kW)	2013.10-		MT			Saloon Engine CRBC/CRLB	GC083101	Outer Joint	36	27	59.5	40	65	M				
<b>A3 SPORTBACK (8PA)</b>																		
1.2 TSi (77 kW)	2010.04-	2012.08	MT				GC083037	Outer Joint	36	30	59.5	40.5	55	I				
1.4 TFSi (92 kW)	2011.05-					DOUBLE CLUTCH	GCI83016	Inner Joint		28		32						
1.6 (75 kW)	2003.06-	2012.08	MT/AT				GC083037	Outer Joint	36	30	59.5	40.5	55	I				
1.6 FSi (85 kW)	2003.06-	2010.05	MT			Engine BGABLF/8LPG	GC083037	Outer Joint	36	30	59.5	40.5	55	I				
1.6 TDi (66 kW)	2009.05-	2010.05					GC083037	Outer Joint	36	30	59.5	40.5	55	I				
1.6 TDi (77 kW)	2009.05-	2010.05					GC083037	Outer Joint	36	30	59.5	40.5	55	I				
	2011.05-					DOUBLE CLUTCH	GCI83016	Inner Joint		28		32						
1.8 TFSi (118 kW)	2006.11-	2010.05					GCI83016	Inner Joint		28		32						
1.9 TDi (77 kW)	2003.06-	2010.05	MT				GC083037	Outer Joint	36	30	59.5	40.5	55	I				
2.0 FSi (110 kW)	2003.06-	2008.06					GC083037	Outer Joint	36	30	59.5	40.5	55	I				
2.0 FSi (147 kW)	2003.06-	2010.05					GCI83016	Inner Joint		28		32						
2.0 TDi (100 kW)	2003.06-	2010.05	MT				GCI83016	Inner Joint		28		32						
2.0 TDi (103 kW)	2003.06-	2010.05	MT				GCI83016	Inner Joint		28		32						
2.0 TDi (120 kW)	2006.02-	2008.06					GCI83016	Inner Joint		28		32						
2.0 TDi (125 kW)	2006.02-	2008.06					GCI83016	Inner Joint		28		32						
2.0 TDi Quattro (103 kW)	2003-			R	RWD		GC083037	Outer Joint	36	30	59.5	40.5	55	I				
2.0 TDi Quattro (125 kW)	2006.02-	2008.06					GCI83016	Inner Joint		28		32						
2.0 TFSi (147 kW)	2004.06-	2010.05					GCI83016	Inner Joint		28		32						
2.0 TFSi Quattro (147 kW)	2004.06-	2008.06					GCI83016	Inner Joint		28		32						
3.2 (184 kW)	2003.07-	2008.06					GCI83016	Inner Joint		28		32						
3.2 FSi Quattro (184 kW)	2008.07-	2009.05					GCI83016	Inner Joint		28		32						
S3 2.0 16V Quattro (188 kW)	2006.11-	2010.05					GCI83016	Inner Joint		28		32						
S3 2.0 16V Quattro (195 kW)	2006.11-	2010.05					GCI83016	Inner Joint		28		32						





		TRANSM	L/R	F/R		G-AP Ref.	PRODUCT	ABS	Technical Specifications									
									YEAR	A	B	C	H	L	P			
<b>AUDI</b>																		
<b>A3 SPORTBACK (8VA)</b>																		
1.2 TFSi (77 kW)	2013.05-		MT	R	F	Hatchback Engine CJZA	GDS61200	Drive Shaft	36		59.5	40.5	820					
	2013.05-					Hatchback Engine CJZA	GC083100	Outer Joint	36	33	59.5	38	55	I				
1.2 TFSi (81 kW)	2014.05-					Hatchback Engine CYVB	GC083100	Outer Joint	36	33	59.5	38	55	I				
1.4 TFSi (103 kW)	2013.03-		AT			Hatchback Engine CPTA	GC083101	Outer Joint	36	27	59.5	40	65	M				
	2013.03-		MT			Hatchback Engine CPTA	GC083100	Outer Joint	36	33	59.5	38	55	I				
	2013.03-					Hatchback Engine CPTA	GC061059	Outer Joint	36	33	59.5	40	59.5	I				
1.4 TFSi (110 kW)	2014.05-		MT			Hatchback Engine CZEA	GC083100	Outer Joint	36	33	59.5	38	55	I				
1.4 TFSi (90 kW)	2012.09-		MT	R	F	Hatchback Engine CMBA/CXSA	GDS61200	Drive Shaft	36		59.5	40.5	820					
	2012.09-		MT			Hatchback Engine CMBA/CXSA	GC083100	Outer Joint	36	33	59.5	38	55	I				
	2012.09-					Hatchback Engine CMBA/CXSA	GC061059	Outer Joint	36	33	59.5	40	59.5	I				
1.4 TFSi (92 kW)	2014.05-		MT			Hatchback Engine CZCA	GC083100	Outer Joint	36	33	59.5	38	55	I				
1.4 TFSi e-tron (110 kW)	2014.05-		MT			Hatchback Engine CUKB/CXUA	GC083100	Outer Joint	36	33	59.5	38	55	I				
1.4 TFSi g-tron (81 kW)	2013.11-					Hatchback Engine CPWA	GC083100	Outer Joint	36	33	59.5	38	55	I				
1.6 TDi (77 kW)	2012.10-		MT	R	F	Hatchback Engine CLHA	GDS61200	Drive Shaft	36		59.5	40.5	820					
	2012.10-		MT			Hatchback Engine CLHA	GC083100	Outer Joint	36	33	59.5	38	55	I				
	2012.10-					Hatchback Engine CLHA	GC061059	Outer Joint	36	33	59.5	40	59.5	I				
1.6 TDi (81 kW)	2013.09-		MT			Hatchback Engine CRKB/CXXB/DBKA	GC083100	Outer Joint	36	33	59.5	38	55	I				
1.8 TFSi (132 kW)	2012.09-		MT	L	F	Hatchback Engine CJSA/CJSB	GDS61304	Drive Shaft	36		59.5	40	511					
	2012.09-					Hatchback Engine CJSA/CJSB	GC083101	Outer Joint	36	27	59.5	40	65	M				
2.0 TDi (110 kW)	2012.09-					Hatchback Engine CRBC/CRLB/CRUA	GC083101	Outer Joint	36	27	59.5	40	65	M				
2.0 TDi (81 kW)	2013.05-		MT	R	F	Hatchback Engine CRFA	GDS61200	Drive Shaft	36		59.5	40.5	820					
	2013.05-					Hatchback Engine CRFA	GC083100	Outer Joint	36	33	59.5	38	55	I				
2.0 TDi Quattro (110 kW)	2013.02-					Hatchback Engine CRBC/CRLB	GC083101	Outer Joint	36	27	59.5	40	65	M				
<b>A4</b>																		
1.9 TDi	1994.11-				L		GDS83010	Drive Shaft	45W	33		53	30	599				
	1994.11-				R		GDS83009	Drive Shaft	45W	33		53	30	617				
2.4 V6	1997.09-	2001.09	MT	L	F		GDS83054	Drive Shaft	45W	38		59.5	34.5	601				
2.5 TDi V6	1998.05-	2001.09	MT	L	F		GDS83054	Drive Shaft	45W	38		59.5	34.5	601				
2.6 V6	1995.03-	2001.09	MT	L	F		GDS83054	Drive Shaft	45W	38		59.5	34.5	601				
2.8 V6	1996.04-	2001.09	MT	L	F		GDS83054	Drive Shaft	45W	38		59.5	34.5	601				
<b>A4 (8D2, B5)</b>																		
1.6 (74 kW)	1994.11-	2000.10			F	Saloon Engine ADP/AHL/ANA/ARM	GCI61007	Inner Joint		33		32						
1.6 (75 kW)	2000.07-	2000.11			F	Saloon Engine ALZ	GCI61007	Inner Joint		33		32						
2.8 (128 kW)	1995.09-	1997.07	AT	R	F	Saloon Engine AAH	GDS83048	Drive Shaft	45W	38		59.5	34.5	502				
	1995.09-	1997.07	AT	L	F	Saloon Engine AAH	GDS83015	Drive Shaft	45W	38		59.5	34.5	527				
2.8 (142 kW)	1996.10-	2000.11	AT	R	F	Saloon Engine ACK/AHA/ALG/AMX/APR/AQD	GDS83048	Drive Shaft	45W	38		59.5	34.5	502				
	1996.10-	2000.11	AT	L	F	Saloon Engine ACK/AHA/ALG/AMX/APR/AQD	GDS83015	Drive Shaft	45W	38		59.5	34.5	527				
2.8 Quattro (142 kW)	1996.10-	2001.08	MT			Saloon Engine ACK/AHA/ALG/AMX/APR/AQD	GC083049	Outer Joint	38	30	59.5	34	59.5	I				
<b>A4 (8E2, B6)</b>																		
1.6 (75 kW)	2000.11-	2004.12			F	Saloon Engine ALZ	GC083058	Outer Joint	45W	38	33	59.5	34	55	M			
	2000.11-	2004.12			F	Saloon Engine ALZ	GC083030	Outer Joint		38	33	59.5	34	55	M			
1.8 T (110 kW)	2001.09-	2004.05			F	Saloon Engine AVJ	GC083030	Outer Joint		38	33	59.5	34	55	M			
	2001.09-	2004.05	AT		F	Saloon Engine AVJ	GCI61044	Inner Joint			34		85					
	2001.09-	2004.05	MT		F	Saloon Engine AVJ	GC083058	Outer Joint	45W	38	33	59.5	34	55	M			
	2001.09-	2004.05	MT&Semi-AT		F	Saloon Engine AVJ	GC083092	Outer Joint	45W	38	27	59.5	34	68	I			
	2001.09-	2004.05	MT	L	F	Saloon Engine AVJ	GDS61115	Drive Shaft	45W	38		59.5	34	597				
	2001.09-	2004.05	MT	L	F	Saloon Engine AVJ	GDS83057	Drive Shaft	45W	38		59.5	34.5	593				
	2001.09-	2004.05	AT	L/R	F	Saloon Engine AVJ	GDS83052	Drive Shaft	45W	38		59.5	34.5	522				
	2001.09-	2004.05	MT	R	F	Saloon Engine AVJ	GDS83362	Drive Shaft	45W	38		59.5	34	621				
	2001.09-	2004.05	MT	R	F	Saloon Engine AVJ	GDS83058	Drive Shaft	45W	38		59.5	34.5	613				
1.8 T (120 kW)	2002.07-	2004.12			F	Saloon Engine BFB	GC083030	Outer Joint		38	33	59.5	34	55	M			
	2002.07-	2004.12	MT		F	Saloon Engine BFB	GC083067	Outer Joint	45W	38	27	59.5	34	68	M			
	2002.07-	2004.12	MT&Semi-AT		F	Saloon Engine BFB	GC083092	Outer Joint	45W	38	27	59.5	34	68	I			
	2002.07-	2004.12	MT/AT		F	Saloon Engine BFB	GCI61044	Inner Joint			34		85					
	2002.07-	2004.12	MT	L	F	Saloon Engine BFB	GDS83352	Drive Shaft	45W	38		59.5	34.5	594				
	2002.07-	2004.12	MT	L	F	Saloon Engine BFB	GDS83057	Drive Shaft	45W	38		59.5	34.5	593				
	2002.07-	2004.12	AT	L/R	F	Saloon Engine BFB	GDS83052	Drive Shaft	45W	38		59.5	34.5	522				
	2002.07-	2004.12	MT	R	F	Saloon Engine BFB	GDS83058	Drive Shaft	45W	38		59.5	34.5	613				
	2002.07-	2004.12				Saloon Engine BFB	GC083069	Outer Joint	45W	38	27	59.5	34.5	63	M			
1.8 T (140 kW)	2002.11-	2004.12			F	Saloon Engine BEX	GC083078	Outer Joint	45W	38	27	59.5	34.5	63	M			
	2002.11-	2004.12	MT		F	Saloon Engine BEX	GC083067	Outer Joint	45W	38	27	59.5	34	68	M			
	2002.11-	2004.12	MT/AT		F	Saloon Engine BEX	GCI61044	Inner Joint			34		85					



		YEAR	TRANSM	L/R	F/R		G-AP Ref.	PRODUCT	ABS	Technical Specifications										
										A	B	C	H	L	P					
<b>AUDI</b>																				
<b>A4 (8E2, B6)</b>																				
1.8 T (140 kW)	2002.11-	2004.12				Saloon Engine BEX	GDS83352	Drive Shaft	45W	38		59.5	34.5	594						
	2002.11-	2004.12	AT	L/R	F	Saloon Engine BEX	GDS83052	Drive Shaft	45W	38		59.5	34.5	522						
	2002.11-	2004.12	AT			Saloon Engine BEX	GC083069	Outer Joint	45W	38	27	59.5	34.5	63	M					
1.8 T Quattro (110 kW)	2000.11-	2002.07	MT			Saloon Engine AVJ	GC083058	Outer Joint	45W	38	33	59.5	34	55	M					
	2000.11-	2002.07			F	Saloon Engine AVJ	GC083030	Outer Joint		38	33	59.5	34	55	M					
	2000.11-	2002.07	MT		F	Saloon Engine AVJ	GC083092	Outer Joint	45W	38	27	59.5	34	68	I					
	2000.11-	2002.07	MT	L	F	Saloon Engine AVJ	GDS61115	Drive Shaft	45W	38		59.5	34	597						
	2000.11-	2002.07	MT	L	F	Saloon Engine AVJ	GDS83057	Drive Shaft	45W	38		59.5	34.5	593						
	2000.11-	2002.07	AT	L/R	F	Saloon Engine AVJ	GDS83052	Drive Shaft	45W	38		59.5	34.5	522						
	2000.11-	2002.07	MT	R	F	Saloon Engine AVJ	GDS83362	Drive Shaft	45W	38		59.5	34	621						
	2000.11-	2002.07	MT	R	F	Saloon Engine AVJ	GDS83058	Drive Shaft	45W	38		59.5	34.5	613						
1.8 T Quattro (120 kW)	2002.07-	2004.12				Saloon Engine BFB	GC083058	Outer Joint	45W	38	33	59.5	34	55	M					
	2002.07-	2004.12			F	Saloon Engine BFB	GC083030	Outer Joint		38	33	59.5	34	55	M					
	2002.07-	2004.12	MT/AT		F	Saloon Engine BFB	GCI61044	Inner Joint			34		85							
	2002.07-	2004.12	MT	L	F	Saloon Engine BFB	GDS83310	Drive Shaft	45W	38		59.5	34	594						
	2002.07-	2004.12			L	Saloon Engine BFB	GDS61115	Drive Shaft	45W	38		59.5	34	597						
	2002.07-	2004.12	AT	L/R	F	Saloon Engine BFB	GDS83052	Drive Shaft	45W	38		59.5	34.5	522						
	2002.07-	2004.12	MT	L/R	F	Saloon Engine BFB	GCI61070	Inner Joint			24		85							
	2002.07-	2004.12	MT	L/R	F	Saloon Engine BFB	GC061075	Outer Joint	45W	38	33	59.5	34	56.5	M					
	2002.07-	2004.12	MT	R	F	Saloon Engine BFB	GDS83362	Drive Shaft	45W	38		59.5	34	621						
	2002.07-	2004.12	MT	R	F	Saloon Engine BFB	GDS83058	Drive Shaft	45W	38		59.5	34.5	613						
1.8 T Quattro (140 kW)	2002.11-	2004.12				Saloon Engine BEX	GC083058	Outer Joint	45W	38	33	59.5	34	55	M					
	2002.11-	2004.12			F	Saloon Engine BEX	GC083030	Outer Joint		38	33	59.5	34	55	M					
	2002.11-	2004.12	MT/AT		F	Saloon Engine BEX	GCI61044	Inner Joint			34		85							
	2002.11-	2004.12	MT	L	F	Saloon Engine BEX	GDS83310	Drive Shaft	45W	38		59.5	34	594						
	2002.11-	2004.12			L	Saloon Engine BEX	GDS61115	Drive Shaft	45W	38		59.5	34	597						
	2002.11-	2004.12	AT	L/R	F	Saloon Engine BEX	GDS83052	Drive Shaft	45W	38		59.5	34.5	522						
	2002.11-	2004.12	MT	L/R	F	Saloon Engine BEX	GCI61070	Inner Joint			24		85							
	2002.11-	2004.12	MT	L/R	F	Saloon Engine BEX	GC061075	Outer Joint	45W	38	33	59.5	34	56.5	M					
	2002.11-	2004.12	MT	R	F	Saloon Engine BEX	GDS83362	Drive Shaft	45W	38		59.5	34	621						
	2002.11-	2004.12	MT	R	F	Saloon Engine BEX	GDS83058	Drive Shaft	45W	38		59.5	34.5	613						
1.9 TDi (74 kW)	2001.05-	2004.12			F	Saloon Engine AVB	GC083067	Outer Joint	45W	38	27	59.5	34	68	M					
	2001.05-	2004.12			F	Saloon Engine AVB	GC083078	Outer Joint	45W	38	27	59.5	34.5	63	M					
	2001.05-	2004.12	MT		F	Saloon Engine AVB	GC083092	Outer Joint	45W	38	27	59.5	34	68	I					
	2001.05-	2004.12	MT/AT		F	Saloon Engine AVB	GCI61044	Inner Joint			34		85							
	2001.05-	2004.12	MT	L	F	Saloon Engine AVB	GDS83352	Drive Shaft	45W	38		59.5	34.5	594						
	2001.05-	2004.12	MT	L	F	Saloon Engine AVB	GDS83057	Drive Shaft	45W	38		59.5	34.5	593						
	2001.05-	2004.12	MT	R	F	Saloon Engine AVB	GDS83058	Drive Shaft	45W	38		59.5	34.5	613						
	2001.05-	2004.12	MT			Saloon Engine AVB	GC083069	Outer Joint	45W	38	27	59.5	34.5	63	M					
1.9 TDi (85 kW)	2004.04-	2004.09			F	Saloon Engine BKE	GC083067	Outer Joint	45W	38	27	59.5	34	68	M					
	2004.04-	2004.09			F	Saloon Engine BKE	GC083078	Outer Joint	45W	38	27	59.5	34.5	63	M					
	2004.04-	2004.09			L	Saloon Engine BKE	GDS83352	Drive Shaft	45W	38		59.5	34.5	594						
1.9 TDi (96 kW)	2000.11-	2004.12	MT		F	Saloon Engine AVF/AWX	GC083067	Outer Joint	45W	38	27	59.5	34	68	M					
	2000.11-	2004.12	MT&AT		F	Saloon Engine AVF/AWX	GC083092	Outer Joint	45W	38	27	59.5	34	68	I					
	2000.11-	2004.12	MT/AT		F	Saloon Engine AVF/AWX	GCI61044	Inner Joint			34		85							
	2000.11-	2004.12	MT/AT		F	Saloon Engine AVF/AWX	GC083078	Outer Joint	45W	38	27	59.5	34.5	63	M					
	2000.11-	2004.12	MT	L	F	Saloon Engine AVF/AWX	GDS83352	Drive Shaft	45W	38		59.5	34.5	594						
	2000.11-	2004.12	MT	L	F	Saloon Engine AVF/AWX	GDS83057	Drive Shaft	45W	38		59.5	34.5	593						
	2000.11-	2004.12	AT	L/R	F	Saloon Engine AVF/AWX	GDS83052	Drive Shaft	45W	38		59.5	34.5	522						
	2000.11-	2004.12	MT	R	F	Saloon Engine AVF/AWX	GDS83058	Drive Shaft	45W	38		59.5	34.5	613						
	2000.11-	2004.12	MT			Saloon Engine AVF/AWX	GC083069	Outer Joint	45W	38	27	59.5	34.5	63	M					
1.9 TDi Quattro (96 kW)	2001.11-	2004.12				Saloon Engine AVF	GC083058	Outer Joint	45W	38	33	59.5	34	55	M					
	2001.11-	2004.12			F	Saloon Engine AVF	GC083092	Outer Joint	45W	38	27	59.5	34	68	I					
	2001.11-	2004.12			F	Saloon Engine AVF	GC083030	Outer Joint		38	33	59.5	34	55	M					
	2001.11-	2004.12	MT/AT		F	Saloon Engine AVF	GCI61044	Inner Joint			34		85							
	2001.11-	2004.12	MT	L	F	Saloon Engine AVF	GDS83057	Drive Shaft	45W	38		59.5	34.5	593						
	2001.11-	2004.12			L	Saloon Engine AVF	GDS61115	Drive Shaft	45W	38		59.5	34	597						
	2001.11-	2004.12	AT	L/R	F	Saloon Engine AVF	GDS83052	Drive Shaft	45W	38		59.5	34.5	522						
	2001.11-	2004.12	MT	R	F	Saloon Engine AVF	GDS83362	Drive Shaft	45W	38		59.5	34	621						
	2001.11-	2004.12	MT	R	F	Saloon Engine AVF	GDS83058	Drive Shaft	45W	38		59.5	34.5	613						
2.0 (96 kW)	2000.11-	2004.12			F	Saloon Engine ALT	GC083030	Outer Joint		38	33	59.5	34	55	M					
	2000.11-	2004.12	MT		F	Saloon Engine ALT	GCI61044	Inner Joint			34		85							
	2000.11-	2004.12	MT		F	Saloon Engine ALT	GC083092	Outer Joint	45W	38	27	59.5	34	68	I					
	2000.11-	2004.12	MT/AT		F	Saloon Engine ALT	GC083058	Outer Joint	45W	38	33	59.5	34	55	M					
	2000.11-	2004.12	MT	L	F	Saloon Engine ALT	GDS83310	Drive Shaft	45W	38		59.5	34	594						





	 YEAR	TRANSM	L/R	F/R		G-AP Ref.	PRODUCT	ABS	Technical Specifications								
									A	B	C	H	L	P			
<b>AUDI</b>																	
<b>A4 (8E2, B6)</b>																	
2.0 (96 kW)	2000.11-	2004.12	MT	L/R	F	Saloon Engine ALT	GCI61070	Inner Joint			24		85				
	2000.11-	2004.12	MT	L/R	F	Saloon Engine ALT	GC061075	Outer Joint	45W	38	33	59.5	34	56.5	M		
	2000.11-	2004.12		L/R	F	Saloon Engine ALT	GDS83364	Drive Shaft	45W	38		59.5	34	522			
	2000.11-	2004.12	MT	R	F	Saloon Engine ALT	GDS83362	Drive Shaft	45W	38		59.5	34	621			
2.0 FSi (110 kW)	2002.07-	2004.12	MT		F	Saloon Engine AWA	GC083058	Outer Joint	45W	38	33	59.5	34	55	M		
	2002.07-	2004.12	MT		F	Saloon Engine AWA	GC083030	Outer Joint		38	33	59.5	34	55	M		
	2002.07-	2004.12	MT/AT		F	Saloon Engine AWA	GCI61044	Inner Joint			34		85				
	2002.07-	2004.12	Semi-AT		F	Saloon Engine AWA	GC083092	Outer Joint	45W	38	27	59.5	34	68	I		
	2002.07-	2004.12	MT	L	F	Saloon Engine AWA	GDS83310	Drive Shaft	45W	38		59.5	34	594			
	2002.07-	2004.12	AT	L/R	F	Saloon Engine AWA	GDS83052	Drive Shaft	45W	38		59.5	34.5	522			
	2002.07-	2004.12	MT	L/R	F	Saloon Engine AWA	GCI61070	Inner Joint			24		85				
	2002.07-	2004.12	MT	L/R	F	Saloon Engine AWA	GC061075	Outer Joint	45W	38	33	59.5	34	56.5	M		
	2002.07-	2004.12		L/R	F	Saloon Engine AWA	GDS83364	Drive Shaft	45W	38		59.5	34	522			
	2002.07-	2004.12	MT	R	F	Saloon Engine AWA	GDS83362	Drive Shaft	45W	38		59.5	34	621			
2.4 (120 kW)	2001.09-	2004.12			F	Saloon Engine AMM	GC083092	Outer Joint	45W	38	27	59.5	34	68	I		
	2001.09-	2004.12	MT		F	Saloon Engine AMM	GC083067	Outer Joint	45W	38	27	59.5	34	68	M		
	2001.09-	2004.12	MT/AT		F	Saloon Engine AMM	GCI61044	Inner Joint			34		85				
	2001.09-	2004.12	MT	L	F	Saloon Engine AMM	GDS83352	Drive Shaft	45W	38		59.5	34.5	594			
	2001.09-	2004.12	AT	L/R	F	Saloon Engine AMM	GDS83052	Drive Shaft	45W	38		59.5	34.5	522			
2.4 (125 kW)	2001.09-	2004.12	MT			Saloon Engine AMM	GC083069	Outer Joint	45W	38	27	59.5	34.5	63	M		
	2001.09-	2004.12	MT		F	Saloon Engine BDV	GC083067	Outer Joint	45W	38	27	59.5	34	68	M		
	2001.09-	2004.12	MT&Semi-AT		F	Saloon Engine BDV	GC083092	Outer Joint	45W	38	27	59.5	34	68	I		
	2001.09-	2004.12	MT/AT		F	Saloon Engine BDV	GCI61044	Inner Joint			34		85				
	2001.09-	2004.12	MT	L	F	Saloon Engine BDV	GDS83352	Drive Shaft	45W	38		59.5	34.5	594			
	2001.09-	2004.12	MT	L	F	Saloon Engine BDV	GDS83057	Drive Shaft	45W	38		59.5	34.5	593			
	2001.09-	2004.12	AT	L/R	F	Saloon Engine BDV	GDS83052	Drive Shaft	45W	38		59.5	34.5	522			
	2001.09-	2004.12	MT	R	F	Saloon Engine BDV	GDS83058	Drive Shaft	45W	38		59.5	34.5	613			
	2001.09-	2004.12	MT			Saloon Engine BDV	GC083069	Outer Joint	45W	38	27	59.5	34.5	63	M		
	2001.09-	2004.12	MT		F	Saloon Engine BDV	GC083067	Outer Joint	45W	38	27	59.5	34	68	M		
2.5 TDi (114 kW)	2001.08-	2002.07	MT		F	Saloon Engine AYM	GC083067	Outer Joint	45W	38	27	59.5	34	68	M		
	2001.08-	2002.07	MT		F	Saloon Engine AYM	GC083092	Outer Joint	45W	38	27	59.5	34	68	I		
	2001.08-	2002.07	MT/AT		F	Saloon Engine AYM	GCI61044	Inner Joint			34		85				
	2001.08-	2002.07	MT	L	F	Saloon Engine AYM	GDS83363	Drive Shaft	45W	38		59.5	34.5	611			
	2001.08-	2002.07	MT	L	F	Saloon Engine AYM	GDS83057	Drive Shaft	45W	38		59.5	34.5	593			
	2001.08-	2002.07	AT	L/R	F	Saloon Engine AYM	GDS83052	Drive Shaft	45W	38		59.5	34.5	522			
	2001.08-	2002.07		L/R	F	Saloon Engine AYM	GCI61033	Inner Joint			34		85				
	2001.08-	2002.07	MT	R	F	Saloon Engine AYM	GDS83058	Drive Shaft	45W	38		59.5	34.5	613			
	2001.08-	2002.07	AT			Saloon Engine AYM	GC083069	Outer Joint	45W	38	27	59.5	34.5	63	M		
	2001.08-	2002.07	MT		F	Saloon Engine AYM	GC083067	Outer Joint	45W	38	27	59.5	34	68	M		
2.5 TDi (120 kW)	2002.07-	2004.12	MT	L	F	Saloon Engine BCZ/BDG/BFC	GDS83057	Drive Shaft	45W	38		59.5	34.5	593			
	2002.07-	2004.12	AT	L/R	F	Saloon Engine BCZ/BDG/BFC	GDS83052	Drive Shaft	45W	38		59.5	34.5	522			
	2002.07-	2004.12		L/R	F	Saloon Engine BCZ/BDG/BFC	GCI61033	Inner Joint			34		85				
	2002.07-	2004.12	MT	R	F	Saloon Engine BCZ/BDG/BFC	GDS83058	Drive Shaft	45W	38		59.5	34.5	613			
	2002.07-	2004.12	AT			Saloon Engine BCZ/BDG/BFC	GC083069	Outer Joint	45W	38	27	59.5	34.5	63	M		
	2002.07-	2004.12			F	Saloon Engine BCZ/BDG/BFC	GC083078	Outer Joint	45W	38	27	59.5	34.5	63	M		
	2002.07-	2004.12	MT		F	Saloon Engine BCZ/BDG/BFC	GC083067	Outer Joint	45W	38	27	59.5	34	68	M		
	2002.07-	2004.12	MT&Semi-AT		F	Saloon Engine BCZ/BDG/BFC	GC083092	Outer Joint	45W	38	27	59.5	34	68	I		
	2002.07-	2004.12	MT/AT		F	Saloon Engine BCZ/BDG/BFC	GCI61044	Inner Joint			34		85				
	2002.07-	2004.12	MT	L	F	Saloon Engine BCZ/BDG/BFC	GDS83363	Drive Shaft	45W	38		59.5	34.5	611			
2.5 TDi Quattro (132 kW)	2000.11-	2004.12	MT		F	Saloon Engine AKE/BAU/BDH	GCI61044	Inner Joint			34		85				
	2000.11-	2004.12	MT		F	Saloon Engine AKE/BAU/BDH	GC083067	Outer Joint	45W	38	27	59.5	34	68	M		
	2000.11-	2004.12	MT&AT		F	Saloon Engine AKE/BAU/BDH	GC083092	Outer Joint	45W	38	27	59.5	34	68	I		
	2000.11-	2004.12	MT	L	F	Saloon Engine AKE/BAU/BDH	GDS83352	Drive Shaft	45W	38		59.5	34.5	594			
	2000.11-	2004.12	MT	L	F	Saloon Engine AKE/BAU/BDH	GDS83057	Drive Shaft	45W	38		59.5	34.5	593			
	2000.11-	2004.12	MT	R	F	Saloon Engine AKE/BAU/BDH	GDS83058	Drive Shaft	45W	38		59.5	34.5	613			
	2000.11-	2004.12	AT			Saloon Engine AKE/BAU/BDH	GC083069	Outer Joint	45W	38	27	59.5	34.5	63	M		
	2000.11-	2004.12	MT		F	Saloon Engine AKE/BAU/BDH	GC083067	Outer Joint	45W	38	27	59.5	34	68	M		
3.0 (160 kW)	2001.04-	2004.12	MT		F	Saloon Engine BBJ	GC083067	Outer Joint	45W	38	27	59.5	34	68	M		
	2001.04-	2004.12	MT&Semi-AT		F	Saloon Engine BBJ	GC083092	Outer Joint	45W	38	27	59.5	34	68	I		
	2001.04-	2004.12	MT/AT		F	Saloon Engine BBJ	GCI61044	Inner Joint			34		85				
	2001.04-	2004.12	MT	L	F	Saloon Engine BBJ	GDS83352	Drive Shaft	45W	38		59.5	34.5	594			
	2001.04-	2004.12	MT	L	F	Saloon Engine BBJ	GDS83057	Drive Shaft	45W	38		59.5	34.5	593			
	2001.04-	2004.12	AT	L/R	F	Saloon Engine BBJ	GDS83052	Drive Shaft	45W	38		59.5	34.5	522			
	2001.04-	2004.12	MT	R	F	Saloon Engine BBJ	GDS83058	Drive Shaft	45W	38		59.5	34.5	613			
	2001.04-	2004.12	AT			Saloon Engine BBJ	GC083069	Outer Joint	45W	38	27	59.5	34.5	63	M		





		TRANSM	L/R	F/R		G-AP Ref.	PRODUCT	ABS	Technical Specifications						
									YEAR	A	B	C	H	L	P
<b>AUDI</b>															
<b>A4 (8E2, B6)</b>															
3.0 (162 kW)	2000.11-2004.12	MT		F	Saloon Engine ASN	GC083067	Outer Joint	45W	38	27	59.5	34	68	M	
	2000.11-2004.12	MT&AT		F	Saloon Engine ASN	GC083092	Outer Joint	45W	38	27	59.5	34	68	I	
	2000.11-2004.12	MT/AT		F	Saloon Engine ASN	GCI61044	Inner Joint			34		85			
	2000.11-2004.12	MT	L	F	Saloon Engine ASN	GDS83352	Drive Shaft	45W	38		59.5	34.5	594		
	2000.11-2004.12	MT	L	F	Saloon Engine ASN	GDS83057	Drive Shaft	45W	38		59.5	34.5	593		
	2000.11-2004.12	AT	L/R	F	Saloon Engine ASN	GDS83052	Drive Shaft	45W	38		59.5	34.5	522		
	2000.11-2004.12	MT	R	F	Saloon Engine ASN	GDS83058	Drive Shaft	45W	38		59.5	34.5	613		
	2000.11-2004.12	MT			Saloon Engine ASN	GC083069	Outer Joint	45W	38	27	59.5	34.5	63	M	
3.0 Quattro (160 kW)	2001.04-2004.12			F	Saloon Engine BBJ	GC083092	Outer Joint	45W	38	27	59.5	34	68	I	
	2001.04-2004.12	AT		F	Saloon Engine BBJ	GCI61044	Inner Joint			34		85			
	2001.04-2004.12	AT	L/R	F	Saloon Engine BBJ	GDS83052	Drive Shaft	45W	38		59.5	34.5	522		
	2001.04-2004.12	AT			Saloon Engine BBJ	GC083069	Outer Joint	45W	38	27	59.5	34.5	63	M	
3.0 Quattro (162 kW)	2000.11-2004.12	AT		F	Saloon Engine ASN	GCI61044	Inner Joint			34		85			
	2000.11-2004.12	MT/AT		F	Saloon Engine ASN	GC083092	Outer Joint	45W	38	27	59.5	34	68	I	
	2000.11-2004.12	AT	L/R	F	Saloon Engine ASN	GDS83052	Drive Shaft	45W	38		59.5	34.5	522		
4.2 S4 Quattro (253 kW)	2000.11-2004.12	AT			Saloon Engine ASN	GC083069	Outer Joint	45W	38	27	59.5	34.5	63	M	
	2003.03-2004.12				Saloon Engine BBK	GC083078	Outer Joint	45W	38	27	59.5	34.5	63	M	
	2003.03-2004.12			F	Saloon Engine BBK	GC083067	Outer Joint	45W	38	27	59.5	34	68	M	
	2003.03-2004.12	AT	L	F	Saloon Engine BBK	GDS83347	Drive Shaft	45W	38		59.5	34.5	580		
	2003.03-2004.12	AT	L	F	Saloon Engine BBK	GCI61076	Inner Joint			34		82			
	2003.03-2004.12	AT	L	F	Saloon Engine BBK	GC083078	Outer Joint	45W	38	27	59.5	34.5	63	M	
2003.03-2004.12	MT	L	F	Saloon Engine BBK	GDS83352	Drive Shaft	45W	38		59.5	34.5	594			
<b>A4 (8EC, B7)</b>															
1.6 (75 kW)	2004.11-2008.06			F	Saloon Engine ALZ	GC083058	Outer Joint	45W	38	33	59.5	34	55	M	
	2004.11-2008.06			F	Saloon Engine ALZ	GC083030	Outer Joint		38	33	59.5	34	55	M	
1.8 T (120 kW)	2004.11-2008.06			F	Saloon Engine BFB	GC083067	Outer Joint	45W	38	27	59.5	34	68	M	
	2004.11-2008.06			F	Saloon Engine BFB	GC083092	Outer Joint	45W	38	27	59.5	34	68	I	
	2004.11-2008.06	MT&AT		F	Saloon Engine BFB	GC083078	Outer Joint	45W	38	27	59.5	34.5	63	M	
	2004.11-2008.06	MT/AT		F	Saloon Engine BFB	GCI61044	Inner Joint			34		85			
	2004.11-2008.06	MT	L	F	Saloon Engine BFB	GDS83352	Drive Shaft	45W	38		59.5	34.5	594		
	2004.11-2008.06		L/R	F	Saloon Engine BFB	GDS83052	Drive Shaft	45W	38		59.5	34.5	522		
	2004.11-2008.06	MT	R	F	Saloon Engine BFB	GDS83255	Drive Shaft	45W	38		59.5	34.5	621		
	2004.11-2008.06	MT			Saloon Engine BFB	GC083069	Outer Joint	45W	38	27	59.5	34.5	63	M	
1.8 T Quattro (120 kW)	2004.11-2008.06	AT			Saloon Engine BFB	GC083058	Outer Joint	45W	38	33	59.5	34	55	M	
	2004.11-2008.06			F	Saloon Engine BFB	GC083067	Outer Joint	45W	38	27	59.5	34	68	M	
	2004.11-2008.06			F	Saloon Engine BFB	GC083030	Outer Joint		38	33	59.5	34	55	M	
	2004.11-2008.06	MT/AT		F	Saloon Engine BFB	GCI61044	Inner Joint			34		85			
	2004.11-2008.06		L	F	Saloon Engine BFB	GDS83310	Drive Shaft	45W	38		59.5	34	594		
	2004.11-2008.06		L/R	F	Saloon Engine BFB	GCI61070	Inner Joint			24		85			
	2004.11-2008.06		L/R	F	Saloon Engine BFB	GC061075	Outer Joint	45W	38	33	59.5	34	56.5	M	
	2004.11-2008.06	MT	R	F	Saloon Engine BFB	GDS83255	Drive Shaft	45W	38		59.5	34.5	621		
1.9 TDi (85 kW)	2004.11-2008.06			R	Saloon Engine BFB	GDS83311	Drive Shaft	45W	38		59.5	34	617		
	2004.11-2008.06			F	Saloon Engine BKE/BRB	GC083067	Outer Joint	45W	38	27	59.5	34	68	M	
	2004.11-2008.06			F	Saloon Engine BKE/BRB	GC083078	Outer Joint	45W	38	27	59.5	34.5	63	M	
	2004.11-2008.06	MT		F	Saloon Engine BKE/BRB	GCI61044	Inner Joint			34		85			
	2004.11-2008.06		L	F	Saloon Engine BKE/BRB	GDS83352	Drive Shaft	45W	38		59.5	34.5	594		
	2004.11-2008.06	MT	R	F	Saloon Engine BKE/BRB	GDS83255	Drive Shaft	45W	38		59.5	34.5	621		
2.0 (96 kW)	2004.11-2008.06				Saloon Engine BKE/BRB	GC083069	Outer Joint	45W	38	27	59.5	34.5	63	M	
	2004.11-2008.06			F	Saloon Engine ALT	GC083030	Outer Joint		38	33	59.5	34	55	M	
	2004.11-2008.06	MT		F	Saloon Engine ALT	GCI61044	Inner Joint			34		85			
	2004.11-2008.06	MT		F	Saloon Engine ALT	GC083058	Outer Joint	45W	38	33	59.5	34	55	M	
	2004.11-2008.06	MT	L	F	Saloon Engine ALT	GDS83310	Drive Shaft	45W	38		59.5	34	594		
	2004.11-2008.06		L/R	F	Saloon Engine ALT	GDS83364	Drive Shaft	45W	38		59.5	34	522		
	2004.11-2008.06		L/R	F	Saloon Engine ALT	GCI61070	Inner Joint			24		85			
	2004.11-2008.06		L/R	F	Saloon Engine ALT	GC061075	Outer Joint	45W	38	33	59.5	34	56.5	M	
2.0 TDi (100 kW)	2004.11-2008.06			R	Saloon Engine ALT	GDS83311	Drive Shaft	45W	38		59.5	34	617		
	2007.02-2007.08			F	Saloon Engine BNA/BRF	GC083067	Outer Joint	45W	38	27	59.5	34	68	M	
	2007.02-2007.08			F	Saloon Engine BNA/BRF	GC083092	Outer Joint	45W	38	27	59.5	34	68	I	
	2007.02-2007.08			F	Saloon Engine BNA/BRF	GC083078	Outer Joint	45W	38	27	59.5	34.5	63	M	
	2007.02-2007.08	MT		F	Saloon Engine BNA/BRF	GCI61044	Inner Joint			34		85			
	2007.02-2007.08	MT	L	F	Saloon Engine BNA/BRF	GDS83352	Drive Shaft	45W	38		59.5	34.5	594		
2007.02-2007.08		L/R	F	Saloon Engine BNA/BRF	GCI61033	Inner Joint			34		85				



		YEAR	TRANSM	L/R	F/R		G-AP Ref.	PRODUCT	ABS	Technical Specifications								
										A	B	C	H	L	P			
<b>AUDI</b>																		
<b>A4 (8EC, B7)</b>																		
2.0 TDi (100 kW)	2007.02-	2007.08	MT	R	F	Saloon Engine BNA/BRF	GDS83255	Drive Shaft	45W	38		59.5	34.5	621				
	2007.02-	2007.08				Saloon Engine BNA/BRF	GC083069	Outer Joint	45W	38	27	59.5	34.5	63	M			
2.0 TDi (103 kW)	2007.02-	2007.08			F	Saloon Engine BPW	GC083067	Outer Joint	45W	38	27	59.5	34	68	M			
	2007.02-	2007.08			F	Saloon Engine BPW	GC083092	Outer Joint	45W	38	27	59.5	34	68	I			
	2007.02-	2007.08	AT		F	Saloon Engine BPW	GC083078	Outer Joint	45W	38	27	59.5	34.5	63	M			
	2007.02-	2007.08	MT		F	Saloon Engine BPW	GCI61044	Inner Joint			34		85					
	2007.02-	2007.08	MT	L	F	Saloon Engine BPW	GDS83352	Drive Shaft	45W	38		59.5	34.5	594				
	2007.02-	2007.08	MT	R	F	Saloon Engine BPW	GDS83255	Drive Shaft	45W	38		59.5	34.5	621				
	2007.02-	2007.08				Saloon Engine BPW	GC083069	Outer Joint	45W	38	27	59.5	34.5	63	M			
2.0 TDi (120 kW)	2006.06-	2008.06		L	F	Saloon Engine BVA	GDS83352	Drive Shaft	45W	38		59.5	34.5	594				
2.0 TDi (125 kW)	2006.05-	2007.08			F	Saloon Engine BRD	GC083067	Outer Joint	45W	38	27	59.5	34	68	M			
	2006.05-	2007.08			F	Saloon Engine BRD	GC083078	Outer Joint	45W	38	27	59.5	34.5	63	M			
	2006.05-	2007.08	MT		F	Saloon Engine BRD	GCI61044	Inner Joint			34		85					
	2006.05-	2007.08		L	F	Saloon Engine BRD	GDS83352	Drive Shaft	45W	38		59.5	34.5	594				
	2006.05-	2007.08	MT	R	F	Saloon Engine BRD	GDS83255	Drive Shaft	45W	38		59.5	34.5	621				
2.0 TDi (93 kW)	2005.11-	2006.11		L	F	Saloon Engine BVF	GDS83352	Drive Shaft	45W	38		59.5	34.5	594				
	2005.11-	2006.11				Saloon Engine BVF	GC083069	Outer Joint	45W	38	27	59.5	34.5	63	M			
	2004.11-	2008.06			F	Saloon Engine BLB/BRE	GC083067	Outer Joint	45W	38	27	59.5	34	68	M			
2.0 TDi 16V (103 kW)	2004.11-	2008.06			F	Saloon Engine BLB/BRE	GC083092	Outer Joint	45W	38	27	59.5	34	68	I			
	2004.11-	2008.06	AT		F	Saloon Engine BLB/BRE	GC083078	Outer Joint	45W	38	27	59.5	34.5	63	M			
	2004.11-	2008.06	MT		F	Saloon Engine BLB/BRE	GCI61044	Inner Joint			34		85					
	2004.11-	2008.06	MT	L	F	Saloon Engine BLB/BRE	GDS83352	Drive Shaft	45W	38		59.5	34.5	594				
	2004.11-	2008.06		L/R	F	Saloon Engine BLB/BRE	GCI61033	Inner Joint			34		85					
	2004.11-	2008.06	MT	R	F	Saloon Engine BLB/BRE	GDS83255	Drive Shaft	45W	38		59.5	34.5	621				
	2004.11-	2008.06				Saloon Engine BLB/BRE	GC083069	Outer Joint	45W	38	27	59.5	34.5	63	M			
2.0 TDi Quattro (103 kW)	2006.01-	2008.06	AT			Saloon Engine BPW	GC083078	Outer Joint	45W	38	27	59.5	34.5	63	M			
	2006.01-	2008.06			F	Saloon Engine BPW	GC083067	Outer Joint	45W	38	27	59.5	34	68	M			
	2006.01-	2008.06		L	F	Saloon Engine BPW	GDS83310	Drive Shaft	45W	38		59.5	34	594				
	2006.01-	2008.06		L/R	F	Saloon Engine BPW	GCI61070	Inner Joint			24		85					
	2006.01-	2008.06		L/R	F	Saloon Engine BPW	GC061075	Outer Joint	45W	38	33	59.5	34	56.5	M			
	2006.01-	2008.06		R	F	Saloon Engine BPW	GDS83311	Drive Shaft	45W	38		59.5	34	617				
2.0 TDi Quattro (125 kW)	2006.05-	2007.08				Saloon Engine BRD	GC083058	Outer Joint	45W	38	33	59.5	34	55	M			
	2006.05-	2007.08				Saloon Engine BRD	GC083030	Outer Joint		38	33	59.5	34	55	M			
	2006.05-	2007.08			F	Saloon Engine BRD	GC083067	Outer Joint	45W	38	27	59.5	34	68	M			
	2006.05-	2007.08		L	F	Saloon Engine BRD	GDS83310	Drive Shaft	45W	38		59.5	34	594				
	2006.05-	2007.08		L/R	F	Saloon Engine BRD	GCI61070	Inner Joint			24		85					
	2006.05-	2007.08		L/R	F	Saloon Engine BRD	GC061075	Outer Joint	45W	38	33	59.5	34	56.5	M			
	2006.05-	2007.08		R	F	Saloon Engine BRD	GDS83311	Drive Shaft	45W	38		59.5	34	617				
2.0 TFSi (125 kW)	2006.10-	2008.06			F	Saloon Engine BPJ/BYK	GC083092	Outer Joint	45W	38	27	59.5	34	68	I			
	2006.10-	2008.06			F	Saloon Engine BPJ/BYK	GC083078	Outer Joint	45W	38	27	59.5	34.5	63	M			
	2006.10-	2008.06		L	F	Saloon Engine BPJ/BYK	GDS83352	Drive Shaft	45W	38		59.5	34.5	594				
2.0 TFSi (147 kW)	2004.11-	2008.06			F	Saloon Engine BGB/BWE	GC083067	Outer Joint	45W	38	27	59.5	34	68	M			
	2004.11-	2008.06			F	Saloon Engine BGB/BWE	GC083092	Outer Joint	45W	38	27	59.5	34	68	I			
	2004.11-	2008.06			F	Saloon Engine BGB/BWE	GC083078	Outer Joint	45W	38	27	59.5	34.5	63	M			
	2004.11-	2008.06	MT/AT		F	Saloon Engine BGB/BWE	GCI61044	Inner Joint			34		85					
	2004.11-	2008.06	MT	L	F	Saloon Engine BGB/BWE	GDS83352	Drive Shaft	45W	38		59.5	34.5	594				
	2004.11-	2008.06		L/R	F	Saloon Engine BGB/BWE	GDS83052	Drive Shaft	45W	38		59.5	34.5	522				
	2004.11-	2008.06	MT	R	F	Saloon Engine BGB/BWE	GDS83255	Drive Shaft	45W	38		59.5	34.5	621				
2.0 TFSi (162 kW)	2004.11-	2008.06				Saloon Engine BGB/BWE	GC083069	Outer Joint	45W	38	27	59.5	34.5	63	M			
	2005.12-	2007.08			F	Saloon Engine BUL	GC083067	Outer Joint	45W	38	27	59.5	34	68	M			
	2005.12-	2007.08			F	Saloon Engine BUL	GC083078	Outer Joint	45W	38	27	59.5	34.5	63	M			
	2005.12-	2007.08	MT		F	Saloon Engine BUL	GCI61044	Inner Joint			34		85					
	2005.12-	2007.08		L	F	Saloon Engine BUL	GDS83352	Drive Shaft	45W	38		59.5	34.5	594				
2.0 TFSi Quattro (147 kW)	2005.12-	2007.08	MT	R	F	Saloon Engine BUL	GDS83255	Drive Shaft	45W	38		59.5	34.5	621				
	2005.12-	2007.08				Saloon Engine BUL	GC083069	Outer Joint	45W	38	27	59.5	34.5	63	M			
	2004.11-	2008.06				Saloon Engine BGB/BWE	GC083058	Outer Joint	45W	38	33	59.5	34	55	M			
	2004.11-	2008.06			F	Saloon Engine BGB/BWE	GC083067	Outer Joint	45W	38	27	59.5	34	68	M			
	2004.11-	2008.06			F	Saloon Engine BGB/BWE	GC083030	Outer Joint		38	33	59.5	34	55	M			
	2004.11-	2008.06	MT	L	F	Saloon Engine BGB/BWE	GDS83310	Drive Shaft	45W	38		59.5	34	594				
	2004.11-	2008.06		L/R	F	Saloon Engine BGB/BWE	GCI61070	Inner Joint			24		85					
	2004.11-	2008.06		L/R	F	Saloon Engine BGB/BWE	GC061075	Outer Joint	45W	38	33	59.5	34	56.5	M			
2004.11-	2008.06		R	F	Saloon Engine BGB/BWE	GDS83311	Drive Shaft	45W	38		59.5	34	617					





		TRANSM	L/R	F/R		G-AP Ref.	PRODUCT	ABS	Technical Specifications								
									YEAR	A	B	C	H	L	P		
<b>AUDI</b>																	
<b>A4 (8EC, B7)</b>																	
2.0 TFSi Quattro (147 kW)	2004.11-	2008.06	AT		Saloon Engine BGB/BWE	GC083069	Outer Joint	45W	38	27	59.5	34.5	63	M			
2.0 TFSi Quattro (162 kW)	2005.04-	2007.08			Saloon Engine BUL	GC083058	Outer Joint	45W	38	33	59.5	34	55	M			
	2005.04-	2007.08		F	Saloon Engine BUL	GC083067	Outer Joint	45W	38	27	59.5	34	68	M			
	2005.04-	2007.08		L	F	Saloon Engine BUL	GDS83310	Drive Shaft	45W	38		59.5	34	594			
	2005.04-	2007.08		L/R	F	Saloon Engine BUL	GCI61070	Inner Joint			24		85				
	2005.04-	2007.08		L/R	F	Saloon Engine BUL	GC061075	Outer Joint	45W	38	33	59.5	34	56.5	M		
	2005.04-	2007.08		R	F	Saloon Engine BUL	GDS83311	Drive Shaft	45W	38		59.5	34	617			
2.5 TDi (120 kW)	2004.11-	2006.05		F	Saloon Engine BDG	GC083092	Outer Joint	45W	38	27	59.5	34	68	I			
	2004.11-	2006.05	AT	F	Saloon Engine BDG	GCI61044	Inner Joint			34		85					
	2004.11-	2006.05	MT	F	Saloon Engine BDG	GC083067	Outer Joint	45W	38	27	59.5	34	68	M			
	2004.11-	2006.05	MT&AT	F	Saloon Engine BDG	GC083078	Outer Joint	45W	38	27	59.5	34.5	63	M			
	2004.11-	2006.05	MT	L	F	Saloon Engine BDG	GDS83363	Drive Shaft	45W	38		59.5	34.5	611			
	2004.11-	2006.05		L/R	F	Saloon Engine BDG	GDS83052	Drive Shaft	45W	38		59.5	34.5	522			
	2004.11-	2006.05				Saloon Engine BDG	GC083069	Outer Joint	45W	38	27	59.5	34.5	63	M		
2.7 TDi (120 kW)	2005.11-	2008.06			Saloon Engine BSG	GC083069	Outer Joint	45W	38	27	59.5	34.5	63	M			
2.7 TDi (132 kW)	2006.02-	2007.08		F	Saloon Engine BPP	GC083058	Outer Joint	45W	38	33	59.5	34	55	M			
	2006.02-	2007.08			Saloon Engine BPP	GC083069	Outer Joint	45W	38	27	59.5	34.5	63	M			
3.0 (160 kW)	2004.11-	2006.05		F	Saloon Engine BBJ	GC083067	Outer Joint	45W	38	27	59.5	34	68	M			
	2004.11-	2006.05		F	Saloon Engine BBJ	GC083092	Outer Joint	45W	38	27	59.5	34	68	I			
	2004.11-	2006.05		F	Saloon Engine BBJ	GC083078	Outer Joint	45W	38	27	59.5	34.5	63	M			
	2004.11-	2006.05		L	F	Saloon Engine BBJ	GDS83352	Drive Shaft	45W	38		59.5	34.5	594			
3.0 Quattro (160 kW)	2004.11-	2006.07			Saloon Engine BBJ	GC083078	Outer Joint	45W	38	27	59.5	34.5	63	M			
	2004.11-	2006.07		F	Saloon Engine BBJ	GC083067	Outer Joint	45W	38	27	59.5	34	68	M			
	2004.11-	2006.07		F	Saloon Engine BBJ	GC083092	Outer Joint	45W	38	27	59.5	34	68	I			
	2004.11-	2006.07	MT		Saloon Engine BBJ	GC083069	Outer Joint	45W	38	27	59.5	34.5	63	M			
3.0 TDi Quattro (150 kW)	2004.11-	2008.06			Saloon Engine BKN	GC083078	Outer Joint	45W	38	27	59.5	34.5	63	M			
	2004.11-	2008.06		F	Saloon Engine BKN	GC083067	Outer Joint	45W	38	27	59.5	34	68	M			
	2004.11-	2008.06	MT	F	Saloon Engine BKN	GCI61044	Inner Joint			34		85					
	2004.11-	2008.06	AT	L	F	Saloon Engine BKN	GDS83347	Drive Shaft	45W	38		59.5	34.5	580			
	2004.11-	2008.06	AT	L	F	Saloon Engine BKN	GCI61076	Inner Joint			34		82				
	2004.11-	2008.06	AT	L	F	Saloon Engine BKN	GC083078	Outer Joint	45W	38	27	59.5	34.5	63	M		
	2004.11-	2008.06	MT	L	F	Saloon Engine BKN	GDS83352	Drive Shaft	45W	38		59.5	34.5	594			
	2004.11-	2008.06	MT	R	F	Saloon Engine BKN	GDS83255	Drive Shaft	45W	38		59.5	34.5	621			
3.0 TDi Quattro (171 kW)	2007.02-	2007.08			Saloon Engine ASB	GC083078	Outer Joint	45W	38	27	59.5	34.5	63	M			
	2007.02-	2007.08		F	Saloon Engine ASB	GC083067	Outer Joint	45W	38	27	59.5	34	68	M			
	2007.02-	2007.08	MT	F	Saloon Engine ASB	GCI61044	Inner Joint			34		85					
	2007.02-	2007.08	AT	L	F	Saloon Engine ASB	GDS83347	Drive Shaft	45W	38		59.5	34.5	580			
	2007.02-	2007.08	AT	L	F	Saloon Engine ASB	GCI61076	Inner Joint			34		82				
	2007.02-	2007.08	AT	L	F	Saloon Engine ASB	GC083078	Outer Joint	45W	38	27	59.5	34.5	63	M		
	2007.02-	2007.08	MT	L	F	Saloon Engine ASB	GDS83352	Drive Shaft	45W	38		59.5	34.5	594			
	2007.02-	2007.08	MT	R	F	Saloon Engine ASB	GDS83255	Drive Shaft	45W	38		59.5	34.5	621			
3.2 FSi (188 kW)	2005.01-	2008.06	AT	F	Saloon Engine AUK	GCI61044	Inner Joint			34		85					
	2005.01-	2008.06	MT	F	Saloon Engine AUK	GC083067	Outer Joint	45W	38	27	59.5	34	68	M			
	2005.01-	2008.06	MT&AT	F	Saloon Engine AUK	GC083078	Outer Joint	45W	38	27	59.5	34.5	63	M			
	2005.01-	2008.06			Saloon Engine AUK	GC083069	Outer Joint	45W	38	27	59.5	34.5	63	M			
3.2 FSi Quattro (188 kW)	2005.01-	2008.06	MT&AT		Saloon Engine AUK	GC083078	Outer Joint	45W	38	27	59.5	34.5	63	M			
	2005.01-	2008.06		F	Saloon Engine AUK	GC083092	Outer Joint	45W	38	27	59.5	34	68	I			
	2005.01-	2008.06	AT	L	F	Saloon Engine AUK	GDS83347	Drive Shaft	45W	38		59.5	34.5	580			
	2005.01-	2008.06	AT	L	F	Saloon Engine AUK	GCI61076	Inner Joint			34		82				
	2005.01-	2008.06	AT	L	F	Saloon Engine AUK	GC083078	Outer Joint	45W	38	27	59.5	34.5	63	M		
	2005.01-	2008.06			Saloon Engine AUK	GC083069	Outer Joint	45W	38	27	59.5	34.5	63	M			
4.2 RS4 Quattro (309 kW)	2005.09-	2008.06	MT&AT		Saloon Engine BNS	GC083078	Outer Joint	45W	38	27	59.5	34.5	63	M			
	2005.09-	2008.06		F	Saloon Engine BNS	GC083067	Outer Joint	45W	38	27	59.5	34	68	M			
	2005.09-	2008.06		L	F	Saloon Engine BNS	GDS83352	Drive Shaft	45W	38		59.5	34.5	594			
	2005.09-	2008.06	MT		Saloon Engine BNS	GC083069	Outer Joint	45W	38	27	59.5	34.5	63	M			
4.2 S4 Quattro (253 kW)	2007.02-	2007.08			Saloon Engine BBK	GC083078	Outer Joint	45W	38	27	59.5	34.5	63	M			
	2007.02-	2007.08		F	Saloon Engine BBK	GC083067	Outer Joint	45W	38	27	59.5	34	68	M			
	2007.02-	2007.08	MT	F	Saloon Engine BBK	GCI61044	Inner Joint			34		85					
	2007.02-	2007.08		L	F	Saloon Engine BBK	GDS83347	Drive Shaft	45W	38		59.5	34.5	580			
	2007.02-	2007.08		L	F	Saloon Engine BBK	GCI61076	Inner Joint			34		82				
	2007.02-	2007.08		L	F	Saloon Engine BBK	GC083078	Outer Joint	45W	38	27	59.5	34.5	63	M		
	2007.02-	2007.08	MT	R	F	Saloon Engine BBK	GDS83255	Drive Shaft	45W	38		59.5	34.5	621			
	2007.02-	2007.08		F	Saloon Engine BBK	GC083069	Outer Joint	45W	38	27	59.5	34.5	63	M			





		TRANSM	L/R	F/R		G-AP Ref.	PRODUCT	ABS	Technical Specifications					
									YEAR	A	B	C	H	L
<b>AUDI</b> <b>A4 (8H7, B6, 8HE, B7)</b> 1.8 T (120 kW)	2002.07-2009.03	MT		F	Convertible Engine BFB	GC083067	Outer Joint	45W	38	27	59.5	34	68	M
	2002.07-2009.03	MT&Semi-AT		F	Convertible Engine BFB	GC083092	Outer Joint	45W	38	27	59.5	34	68	I
	2002.07-2009.03	MT/AT		F	Convertible Engine BFB	GCI61044	Inner Joint			34		85		
	2002.07-2009.03	MT	L	F	Convertible Engine BFB	GDS83352	Drive Shaft	45W	38		59.5	34.5	594	
	2002.07-2009.03	MT	L	F	Convertible Engine BFB	GDS83057	Drive Shaft	45W	38		59.5	34.5	593	
	2002.07-2009.03	AT	L/R	F	Convertible Engine BFB	GDS83052	Drive Shaft	45W	38		59.5	34.5	522	
	2002.07-2009.03	MT	R	F	Convertible Engine BFB	GDS83058	Drive Shaft	45W	38		59.5	34.5	613	
	2002.07-2009.03	MT			Convertible Engine BFB	GC083069	Outer Joint	45W	38	27	59.5	34.5	63	M
1.8 T Quattro (120 kW)	2003.05-2005.10				Convertible Engine BFB	GC083058	Outer Joint	45W	38	33	59.5	34	55	M
	2003.05-2005.10	MT/AT		F	Convertible Engine BFB	GCI61044	Inner Joint			34		85		
	2003.05-2005.10	MT	L	F	Convertible Engine BFB	GDS83310	Drive Shaft	45W	38		59.5	34	594	
	2003.05-2005.10	AT	L/R	F	Convertible Engine BFB	GDS83052	Drive Shaft	45W	38		59.5	34.5	522	
	2003.05-2005.10	MT	L/R	F	Convertible Engine BFB	GCI61070	Inner Joint			24		85		
	2003.05-2005.10	MT	L/R	F	Convertible Engine BFB	GC061075	Outer Joint	45W	38	33	59.5	34	56.5	M
	2003.05-2005.10	MT	R	F	Convertible Engine BFB	GDS83362	Drive Shaft	45W	38		59.5	34	621	
	2003.05-2005.10	MT			Convertible Engine BFB	GC083069	Outer Joint	45W	38	27	59.5	34.5	63	M
2.0 (96 kW)	2004.09-2005.12			F	Convertible Engine ALT	GC083058	Outer Joint	45W	38	33	59.5	34	55	M
	2004.09-2005.12			F	Convertible Engine ALT	GC083030	Outer Joint		38	33	59.5	34	55	M
	2004.09-2005.12	MT		F	Convertible Engine ALT	GCI61044	Inner Joint			34		85		
	2004.09-2005.12	MT		F	Convertible Engine ALT	GC083092	Outer Joint	45W	38	27	59.5	34	68	I
	2004.09-2005.12	MT	L	F	Convertible Engine ALT	GDS83310	Drive Shaft	45W	38		59.5	34	594	
	2004.09-2005.12	MT	L/R	F	Convertible Engine ALT	GCI61070	Inner Joint			24		85		
	2004.09-2005.12	MT	L/R	F	Convertible Engine ALT	GC061075	Outer Joint	45W	38	33	59.5	34	56.5	M
	2004.09-2005.12	MT	R	F	Convertible Engine ALT	GDS83311	Drive Shaft	45W	38		59.5	34	617	
2.0 TDi (100 kW)	2006.01-2009.03			F	Convertible Engine BRC	GC083078	Outer Joint	45W	38	27	59.5	34.5	63	M
	2006.01-2009.03	MT		F	Convertible Engine BRC	GC083067	Outer Joint	45W	38	27	59.5	34	68	M
	2006.01-2009.03	Semi-AT		F	Convertible Engine BRC	GC083092	Outer Joint	45W	38	27	59.5	34	68	I
	2006.01-2009.03	MT	L	F	Convertible Engine BRC	GDS83352	Drive Shaft	45W	38		59.5	34.5	594	
	2006.01-2009.03				Convertible Engine BRC	GC083069	Outer Joint	45W	38	27	59.5	34.5	63	M
2.0 TDi (103 kW)	2005.11-2007.04			F	Convertible Engine BPW	GC083078	Outer Joint	45W	38	27	59.5	34.5	63	M
	2005.11-2007.04			F	Convertible Engine BPW	GC083092	Outer Joint	45W	38	27	59.5	34	68	I
	2005.11-2007.04	AT		F	Convertible Engine BPW	GC083078	Outer Joint	45W	38	27	59.5	34.5	63	M
	2005.11-2007.04	MT		F	Convertible Engine BPW	GCI61044	Inner Joint			34		85		
	2005.11-2007.04	MT		F	Convertible Engine BPW	GC083067	Outer Joint	45W	38	27	59.5	34	68	M
	2005.11-2007.04	AT	L	F	Convertible Engine BPW	GDS83347	Drive Shaft	45W	38		59.5	34.5	580	
	2005.11-2007.04	AT	L	F	Convertible Engine BPW	GCI61076	Inner Joint			34		82		
	2005.11-2007.04	AT	L	F	Convertible Engine BPW	GC083078	Outer Joint	45W	38	27	59.5	34.5	63	M
	2005.11-2007.04	MT	L	F	Convertible Engine BPW	GDS83352	Drive Shaft	45W	38		59.5	34.5	594	
	2005.11-2007.04	MT	R	F	Convertible Engine BPW	GDS83255	Drive Shaft	45W	38		59.5	34.5	621	
2005.11-2007.04				Convertible Engine BPW	GC083069	Outer Joint	45W	38	27	59.5	34.5	63	M	
2.0 TFSi 16V (147 kW)	2005.11-2007.04			F	Convertible Engine BWE	GC083078	Outer Joint	45W	38	27	59.5	34.5	63	M
	2005.11-2007.04			F	Convertible Engine BWE	GC083092	Outer Joint	45W	38	27	59.5	34	68	I
	2005.11-2007.04	AT		F	Convertible Engine BWE	GC083078	Outer Joint	45W	38	27	59.5	34.5	63	M
	2005.11-2007.04	AT		F	Convertible Engine BWE	GCI61044	Inner Joint			34		85		
	2005.11-2007.04	MT		F	Convertible Engine BWE	GC083067	Outer Joint	45W	38	27	59.5	34	68	M
	2005.11-2007.04	MT	L	F	Convertible Engine BWE	GDS83352	Drive Shaft	45W	38		59.5	34.5	594	
	2005.11-2007.04	MT	L/R	F	Convertible Engine BWE	GDS83052	Drive Shaft	45W	38		59.5	34.5	522	
	2005.11-2007.04				Convertible Engine BWE	GC083069	Outer Joint	45W	38	27	59.5	34.5	63	M
2.4 (120 kW)	2002.04-2005.12	MT&Semi-AT		F	Convertible Engine AMM	GC083092	Outer Joint	45W	38	27	59.5	34	68	I
	2002.04-2005.12	MT/AT		F	Convertible Engine AMM	GCI61044	Inner Joint			34		85		
	2002.04-2005.12	MT	L	F	Convertible Engine AMM	GDS83352	Drive Shaft	45W	38		59.5	34.5	594	
	2002.04-2005.12	MT	L	F	Convertible Engine AMM	GDS83057	Drive Shaft	45W	38		59.5	34.5	593	
	2002.04-2005.12	AT	L/R	F	Convertible Engine AMM	GDS83052	Drive Shaft	45W	38		59.5	34.5	522	
	2002.04-2005.12	MT	R	F	Convertible Engine AMM	GDS83058	Drive Shaft	45W	38		59.5	34.5	613	
	2002.04-2005.12	AT			Convertible Engine AMM	GC083069	Outer Joint	45W	38	27	59.5	34.5	63	M
	2002.04-2005.12	MT		F	Convertible Engine AMM	GC083067	Outer Joint	45W	38	27	59.5	34	68	M
2.4 (125 kW)	2002.04-2005.12	MT		F	Convertible Engine BDV	GC083067	Outer Joint	45W	38	27	59.5	34	68	M
	2002.04-2005.12	MT&Semi-AT		F	Convertible Engine BDV	GC083092	Outer Joint	45W	38	27	59.5	34	68	I
	2002.04-2005.12	MT/AT		F	Convertible Engine BDV	GCI61044	Inner Joint			34		85		
	2002.04-2005.12	MT	L	F	Convertible Engine BDV	GDS83352	Drive Shaft	45W	38		59.5	34.5	594	
	2002.04-2005.12	MT	L	F	Convertible Engine BDV	GDS83057	Drive Shaft	45W	38		59.5	34.5	593	
	2002.04-2005.12	AT	L/R	F	Convertible Engine BDV	GDS83052	Drive Shaft	45W	38		59.5	34.5	522	
	2002.04-2005.12	MT	R	F	Convertible Engine BDV	GDS83058	Drive Shaft	45W	38		59.5	34.5	613	



		TRANSM	L/R	F/R		G-AP Ref.	PRODUCT	ABS	Technical Specifications								
									YEAR	A	B	C	H	L	P		
<b>AUDI</b>																	
<b>A4 (8H7, B6, 8HE, B7)</b>																	
2.4 (125 kW)	2002.04-	2005.12	AT			Convertible Engine BDV	GC083069	Outer Joint	45W	38	27	59.5	34.5	63	M		
2.5 TDi (120 kW)	2002.08-	2005.12			F	Convertible Engine BCZ/BDG/BFC	GC083078	Outer Joint	45W	38	27	59.5	34.5	63	M		
	2002.08-	2005.12	MT		F	Convertible Engine BCZ/BDG/BFC	GC083067	Outer Joint	45W	38	27	59.5	34	68	M		
	2002.08-	2005.12	MT&Semi-AT		F	Convertible Engine BCZ/BDG/BFC	GC083092	Outer Joint	45W	38	27	59.5	34	68	I		
	2002.08-	2005.12	MT/AT		F	Convertible Engine BCZ/BDG/BFC	GCI61044	Inner Joint				34		85			
	2002.08-	2005.12	MT	L	F	Convertible Engine BCZ/BDG/BFC	GDS83363	Drive Shaft	45W	38		59.5	34.5	611			
	2002.08-	2005.12	MT	L	F	Convertible Engine BCZ/BDG/BFC	GDS83057	Drive Shaft	45W	38		59.5	34.5	593			
	2002.08-	2005.12	AT	L/R	F	Convertible Engine BCZ/BDG/BFC	GDS83052	Drive Shaft	45W	38		59.5	34.5	522			
	2002.08-	2005.12		L/R	F	Convertible Engine BCZ/BDG/BFC	GCI61033	Inner Joint				34		85			
	2002.08-	2005.12	MT	R	F	Convertible Engine BCZ/BDG/BFC	GDS83058	Drive Shaft	45W	38		59.5	34.5	613			
	2002.08-	2005.12	AT			Convertible Engine BCZ/BDG/BFC	GC083069	Outer Joint	45W	38	27	59.5	34.5	63	M		
2.7 TDi (132 kW)	2006.06-	2009.03				Convertible Engine BPP	GC083069	Outer Joint	45W	38	27	59.5	34.5	63	M		
3.0 (160 kW)	2002.04-	2005.12	MT	L	F	Convertible Engine BBJ	GDS83352	Drive Shaft	45W	38		59.5	34.5	594			
3.0 (162 kW)	2002.04-	2005.12			F	Convertible Engine ASN	GC083058	Outer Joint	45W	38	33	59.5	34	55	M		
	2002.04-	2005.12	MT		F	Convertible Engine ASN	GC083067	Outer Joint	45W	38	27	59.5	34	68	M		
	2002.04-	2005.12	MT/AT		F	Convertible Engine ASN	GCI61044	Inner Joint				34		85			
	2002.04-	2005.12	MT/AT		F	Convertible Engine ASN	GC083092	Outer Joint	45W	38	27	59.5	34	68	I		
	2002.04-	2005.12	MT	L	F	Convertible Engine ASN	GDS83352	Drive Shaft	45W	38		59.5	34.5	594			
	2002.04-	2005.12	MT	L	F	Convertible Engine ASN	GDS83057	Drive Shaft	45W	38		59.5	34.5	593			
	2002.04-	2005.12	AT	L/R	F	Convertible Engine ASN	GDS83052	Drive Shaft	45W	38		59.5	34.5	522			
	2002.04-	2005.12	MT	R	F	Convertible Engine ASN	GDS83058	Drive Shaft	45W	38		59.5	34.5	613			
	2002.04-	2005.12	MT			Convertible Engine ASN	GC083069	Outer Joint	45W	38	27	59.5	34.5	63	M		
	2002.04-	2005.12	MT			Convertible Engine ASN	GC083058	Outer Joint	45W	38	33	59.5	34	55	M		
3.0 Quattro (162 kW)	2003.05-	2005.10				Convertible Engine ASN	GCI61044	Inner Joint				34		85			
	2003.05-	2005.10	AT		F	Convertible Engine ASN	GC083092	Outer Joint	45W	38	27	59.5	34	68	I		
	2003.05-	2005.10	MT/AT		F	Convertible Engine ASN	GDS83052	Drive Shaft	45W	38		59.5	34.5	522			
	2003.05-	2005.10	MT			Convertible Engine ASN	GC083069	Outer Joint	45W	38	27	59.5	34.5	63	M		
3.0 TDi Quattro (150 kW)	2006.01-	2009.03				Convertible Engine BKN	GC083078	Outer Joint	45W	38	27	59.5	34.5	63	M		
	2006.01-	2009.03				Convertible Engine BKN	GC083067	Outer Joint	45W	38	27	59.5	34	68	M		
	2006.01-	2009.03	AT	L	F	Convertible Engine BKN	GDS83347	Drive Shaft	45W	38		59.5	34.5	580			
	2006.01-	2009.03	AT	L	F	Convertible Engine BKN	GCI61076	Inner Joint				34		82			
	2006.01-	2009.03	AT	L	F	Convertible Engine BKN	GC083078	Outer Joint	45W	38	27	59.5	34.5	63	M		
	2006.01-	2009.03	MT	L	F	Convertible Engine BKN	GDS83352	Drive Shaft	45W	38		59.5	34.5	594			
	2006.01-	2009.03				Convertible Engine BKN	GC083069	Outer Joint	45W	38	27	59.5	34.5	63	M		
	2006.01-	2009.03				Convertible Engine BKN	GC083078	Outer Joint	45W	38	27	59.5	34.5	63	M		
3.0 TDi Quattro (171 kW)	2005.11-	2007.04				Convertible Engine ASB	GC083078	Outer Joint	45W	38	27	59.5	34.5	63	M		
	2005.11-	2007.04	AT			Convertible Engine ASB	GC083078	Outer Joint	45W	38	27	59.5	34.5	63	M		
	2005.11-	2007.04			F	Convertible Engine ASB	GC083067	Outer Joint	45W	38	27	59.5	34	68	M		
	2005.11-	2007.04	MT		F	Convertible Engine ASB	GCI61044	Inner Joint				34		85			
	2005.11-	2007.04	AT	L	F	Convertible Engine ASB	GDS83347	Drive Shaft	45W	38		59.5	34.5	580			
	2005.11-	2007.04	AT	L	F	Convertible Engine ASB	GCI61076	Inner Joint				34		82			
	2005.11-	2007.04	AT	L	F	Convertible Engine ASB	GC083078	Outer Joint	45W	38	27	59.5	34.5	63	M		
	2005.11-	2007.04	MT	L	F	Convertible Engine ASB	GDS83352	Drive Shaft	45W	38		59.5	34.5	594			
	2005.11-	2007.04	MT	R	F	Convertible Engine ASB	GDS83255	Drive Shaft	45W	38		59.5	34.5	621			
	2005.11-	2007.04			F	Convertible Engine AUK	GC083092	Outer Joint	45W	38	27	59.5	34	68	I		
3.2 FSi (188 kW)	2005.11-	2007.04	AT		F	Convertible Engine AUK	GC083078	Outer Joint	45W	38	27	59.5	34.5	63	M		
	2005.11-	2007.04	AT		F	Convertible Engine AUK	GCI61044	Inner Joint				34		85			
	2005.11-	2007.04				Convertible Engine AUK	GC083069	Outer Joint	45W	38	27	59.5	34.5	63	M		
	2005.11-	2007.04				Convertible Engine AUK	GC083078	Outer Joint	45W	38	27	59.5	34.5	63	M		
3.2 FSi Quattro (188 kW)	2005.11-	2007.04	AT			Convertible Engine AUK	GC083078	Outer Joint	45W	38	27	59.5	34.5	63	M		
	2005.11-	2007.04			F	Convertible Engine AUK	GC083092	Outer Joint	45W	38	27	59.5	34	68	I		
	2005.11-	2007.04	AT		F	Convertible Engine AUK	GCI61044	Inner Joint				34		85			
	2005.11-	2007.04	AT	L	F	Convertible Engine AUK	GDS83347	Drive Shaft	45W	38		59.5	34.5	580			
	2005.11-	2007.04	AT	L	F	Convertible Engine AUK	GCI61076	Inner Joint				34		82			
	2005.11-	2007.04	AT	L	F	Convertible Engine AUK	GC083078	Outer Joint	45W	38	27	59.5	34.5	63	M		
	2005.11-	2007.04	AT	L	F	Convertible Engine AUK	GC083069	Outer Joint	45W	38	27	59.5	34.5	63	M		
	2005.11-	2007.04			F	Convertible Engine AUK	GC083078	Outer Joint	45W	38	27	59.5	34.5	63	M		
4.2 RS4 Quattro (309 kW)	2006.03-	2009.03			F	Convertible Engine BNS	GC083067	Outer Joint	45W	38	27	59.5	34	68	M		
	2006.03-	2009.03		L	F	Convertible Engine BNS	GDS83352	Drive Shaft	45W	38		59.5	34.5	594			
	2006.03-	2009.03			F	Convertible Engine BNS	GC083069	Outer Joint	45W	38	27	59.5	34.5	63	M		
4.2 S4 Quattro (253 kW)	2004.01-	2007.12				Convertible Engine BBK	GC083078	Outer Joint	45W	38	27	59.5	34.5	63	M		
	2004.01-	2007.12	AT			Convertible Engine BBK	GC083078	Outer Joint	45W	38	27	59.5	34.5	63	M		
	2004.01-	2007.12			F	Convertible Engine BBK	GC083067	Outer Joint	45W	38	27	59.5	34	68	M		
	2004.01-	2007.12	AT	L	F	Convertible Engine BBK	GDS83347	Drive Shaft	45W	38		59.5	34.5	580			
	2004.01-	2007.12	AT	L	F	Convertible Engine BBK	GCI61076	Inner Joint				34		82			
	2004.01-	2007.12	AT	L	F	Convertible Engine BBK	GC083078	Outer Joint	45W	38	27	59.5	34.5	63	M		





		TRANSM	L/R	F/R		G-AP Ref.	PRODUCT	ABS	Technical Specifications								
									YEAR	A	B	C	H	L	P		
<b>AUDI</b>																	
<b>A4 (8H7, B6, 8HE, B7)</b>																	
4.2 S4 Quattro (253 kW)	2004.01-	2007.12	MT	L	F	Convertible Engine BBK	GDS83352	Drive Shaft	45W	38		59.5	34.5	594			
	2004.01-	2007.12			F	Convertible Engine BBK	GC083069	Outer Joint	45W	38	27	59.5	34.5	63	M		
<b>A4 (8K2, B8)</b>																	
1.8 TFSi (118 kW)	2007.11-		6MT/CVT	L/R	F	Saloon Engine CABB/CCUA/CDHB	GC083087	Outer Joint		42	27	76.5	34	54.5	M		
	2007.11-		6MT	L/R	F	Saloon Engine CABB/CCUA/CDHB	GDS83273	Drive Shaft		42		76.5	34	460			
	2007.11-		6MT	L/R	F	Saloon Engine CABB/CCUA/CDHB	GCI83022	Inner Joint			34		88				
	2007.11-		AT		F	Saloon Engine CABB/CCUA/CDHB	GDS83291	Drive Shaft		42		76.4	34	464			
	2007.11-					Saloon Engine CABB/CCUA/CDHB	GC083103	Outer Joint		42	28	76.4	34	54	I		
1.8 TFSi (125 kW)	2011.11-			L/R	F	Saloon Engine CJEB	GDS83291	Drive Shaft		42		76.4	34	464			
	2011.11-					Saloon Engine CJEB	GC083103	Outer Joint		42	28	76.4	34	54	I		
1.8 TFSi (88 kW)	2008.02-		6MT/CVT	L/R	F	Saloon Engine CABA/CDHA	GC083087	Outer Joint		42	27	76.5	34	54.5	M		
	2008.02-		6MT	L/R	F	Saloon Engine CABA/CDHA	GDS83273	Drive Shaft		42		76.5	34	460			
	2008.02-		6MT	L/R	F	Saloon Engine CABA/CDHA	GCI83022	Inner Joint			34		88				
	2008.02-		MT/AT	L/R	F	Saloon Engine CABA/CDHA	GDS83291	Drive Shaft		42		76.4	34	464			
	2008.02-		MT/AT			Saloon Engine CABA/CDHA	GC083103	Outer Joint		42	28	76.4	34	54	I		
1.8 TFSi Quattro (118 kW)	2008.09-				F	Saloon Engine CDHB	GC083086	Outer Joint		42	33	76.5	34	45.5	M		
	2008.09-		6MT/6AT/7AT	L/R	F	Saloon Engine CDHB	GDS83345	Drive Shaft		42		76.5	34	463			
	2008.09-		6MT/6AT/7AT	L/R	F	Saloon Engine CDHB	GCI83029	Inner Joint			24		88.5				
	2008.09-		6MT/6AT/7AT	L/R	F	Saloon Engine CDHB	GC083086	Outer Joint		42	33	76.5	34	45.5	M		
	2008.09-		6MT/CTV	L/R	F	Saloon Engine CDHB	GDS83273	Drive Shaft		42		76.5	34	460			
	2008.09-		6MT/CTV	L/R	F	Saloon Engine CDHB	GCI83022	Inner Joint			34		88				
1.8 TFSi Quattro (125 kW)	2011.11-		MT/AT		F	Saloon Engine CJEB	GDS83291	Drive Shaft		42		76.4	34	464			
	2011.11-					Saloon Engine CJEB	GC083103	Outer Joint		42	28	76.4	34	54	I		
2.0 TDi (100 kW)	2007.11-		6MT		F	Saloon Engine CAGB/CJCB	GC083087	Outer Joint		42	27	76.5	34	54.5	M		
	2007.11-		6MT/CVT	L/R	F	Saloon Engine CAGB/CJCB	GC083087	Outer Joint		42	27	76.5	34	54.5	M		
	2007.11-		6MT	L/R	F	Saloon Engine CAGB/CJCB	GC083109	Outer Joint		42	27	76.5	34	54.5	M		
	2007.11-		6MT/CTV	L/R	F	Saloon Engine CAGB/CJCB	GDS83273	Drive Shaft		42		76.5	34	460			
	2007.11-		6MT/CTV	L/R	F	Saloon Engine CAGB/CJCB	GCI83022	Inner Joint			34		88				
	2007.11-		MT	L/R	F	Saloon Engine CAGB/CJCB	GDS83291	Drive Shaft		42		76.4	34	464			
	2007.11-					Saloon Engine CAGB/CJCB	GC083103	Outer Joint		42	28	76.4	34	54	I		
2.0 TDi (105 kW)	2007.11-		6MT		F	Saloon Engine CAGA/CJCA/CMEA/CMFA	GC083087	Outer Joint		42	27	76.5	34	54.5	M		
	2007.11-		6MT/CVT	L/R	F	Saloon Engine CAGA/CJCA/CMEA/CMFA	GC083087	Outer Joint		42	27	76.5	34	54.5	M		
	2007.11-		6MT	L/R	F	Saloon Engine CAGA/CJCA/CMEA/CMFA	GC083109	Outer Joint		42	27	76.5	34	54.5	M		
	2007.11-		6MT/CTV	L/R	F	Saloon Engine CAGA/CJCA/CMEA/CMFA	GDS83273	Drive Shaft		42		76.5	34	460			
	2007.11-		6MT/CTV	L/R	F	Saloon Engine CAGA/CJCA/CMEA/CMFA	GCI83022	Inner Joint			34		88				
	2007.11-		MT	L/R	F	Saloon Engine CAGA/CJCA/CMEA/CMFA	GDS83291	Drive Shaft		42		76.4	34	464			
	2007.11-					Saloon Engine CAGA/CJCA/CMEA/CMFA	GC083103	Outer Joint		42	28	76.4	34	54	I		
2.0 TDi (110 kW)	2013.05-		MT/AT	L/R	F	Saloon Engine CJCD/CMFB/CSUA	GDS83291	Drive Shaft		42		76.4	34	464			
	2013.05-					Saloon Engine CJCD/CMFB/CSUA	GC083103	Outer Joint		42	28	76.4	34	54	I		
2.0 TDi (120 kW)	2008.08-		6MT		F	Saloon Engine CAHB/CGLD	GC083087	Outer Joint		42	27	76.5	34	54.5	M		
	2008.08-			L/R	F	Saloon Engine CAHB/CGLD	GC083087	Outer Joint		42	27	76.5	34	54.5	M		
	2008.08-		6MT	L/R	F	Saloon Engine CAHB/CGLD	GC083109	Outer Joint		42	27	76.5	34	54.5	M		
	2008.08-		6MT/CTV	L/R	F	Saloon Engine CAHB/CGLD	GDS83273	Drive Shaft		42		76.5	34	460			
	2008.08-		6MT/CTV	L/R	F	Saloon Engine CAHB/CGLD	GCI83022	Inner Joint			34		88				
	2008.08-			L/R	F	Saloon Engine CAHB/CGLD	GDS83291	Drive Shaft		42		76.4	34	464			
	2008.08-		AT		F	Saloon Engine CAHB/CGLD	GDS83337	Drive Shaft		42		76.5	34	461			
	2008.08-		AT			Saloon Engine CAHB/CGLD	GC083102	Outer Joint		42	29	76.5	34	60	I		
	2008.08-		MT			Saloon Engine CAHB/CGLD	GC083103	Outer Joint		42	28	76.4	34	54	I		
2.0 TDi (125 kW)	2008.01-		6MT		F	Saloon Engine CAHA	GC083087	Outer Joint		42	27	76.5	34	54.5	M		
	2008.01-			L/R	F	Saloon Engine CAHA	GC083087	Outer Joint		42	27	76.5	34	54.5	M		
	2008.01-		6MT	L/R	F	Saloon Engine CAHA	GC083109	Outer Joint		42	27	76.5	34	54.5	M		
	2008.01-		6MT/CTV	L/R	F	Saloon Engine CAHA	GDS83273	Drive Shaft		42		76.5	34	460			
	2008.01-		6MT/CTV	L/R	F	Saloon Engine CAHA	GCI83022	Inner Joint			34		88				
	2008.01-			L/R	F	Saloon Engine CAHA	GDS83291	Drive Shaft		42		76.4	34	464			
	2008.01-					Saloon Engine CAHA	GC083103	Outer Joint		42	28	76.4	34	54	I		
2.0 TDi (130 kW)	2011.11-			L/R	F	Saloon Engine CGLC/CMGB	GDS83337	Drive Shaft		42		76.5	34	461			
	2011.11-					Saloon Engine CGLC/CMGB	GC083102	Outer Joint		42	29	76.5	34	60	I		
2.0 TDi (140 kW)	2013.09-		AT		F	Saloon Engine CNHA	GDS83337	Drive Shaft		42		76.5	34	461			
	2013.09-		AT			Saloon Engine CNHA	GC083102	Outer Joint		42	29	76.5	34	60	I		
2.0 TDi (88 kW)	2008.06-		6MT		F	Saloon Engine CAGC/CJCC	GC083087	Outer Joint		42	27	76.5	34	54.5	M		
	2008.06-			L/R	F	Saloon Engine CAGC/CJCC	GC083087	Outer Joint		42	27	76.5	34	54.5	M		
	2008.06-		6MT	L/R	F	Saloon Engine CAGC/CJCC	GC083109	Outer Joint		42	27	76.5	34	54.5	M		





		TRANSM	L/R	F/R		G-AP Ref.	PRODUCT	ABS	Technical Specifications									
									YEAR	A	B	C	H	L	P			
<b>AUDI</b>																		
<b>A4 (8K2, B8)</b>																		
2.0 TDi (88 kW)	2008.06-		6MT/CTV	L/R	F	Saloon Engine CAGC/CJCC	GDS83273	Drive Shaft	42		76.5	34	460					
	2008.06-		6MT/CTV	L/R	F	Saloon Engine CAGC/CJCC	GCI83022	Inner Joint		34		88						
	2008.06-		MT	L/R	F	Saloon Engine CAGC/CJCC	GDS83291	Drive Shaft	42		76.4	34	464					
	2008.06-					Saloon Engine CAGC/CJCC	GC083103	Outer Joint	42	28	76.4	34	54	I				
2.0 TDi Quattro (105 kW)	2008.11-				F	Saloon Engine CAGA/CJCA	GC083086	Outer Joint	42	33	76.5	34	45.5	M				
	2008.11-		6MT/6AT/7AT	L/R	F	Saloon Engine CAGA/CJCA	GDS83345	Drive Shaft	42		76.5	34	463					
	2008.11-		6MT/6AT/7AT	L/R	F	Saloon Engine CAGA/CJCA	GCI83029	Inner Joint		24		88.5						
	2008.11-		6MT/6AT/7AT	L/R	F	Saloon Engine CAGA/CJCA	GC083086	Outer Joint	42	33	76.5	34	45.5	M				
	2008.11-			L/R	F	Saloon Engine CAGA/CJCA	GDS83291	Drive Shaft	42		76.4	34	464					
2.0 TDi Quattro (125 kW)	2008.01-				F	Saloon Engine CAHA	GC083086	Outer Joint	42	33	76.5	34	45.5	M				
	2008.01-		6MT/6AT/7AT	L/R	F	Saloon Engine CAHA	GDS83345	Drive Shaft	42		76.5	34	463					
	2008.01-		6MT/6AT/7AT	L/R	F	Saloon Engine CAHA	GCI83029	Inner Joint		24		88.5						
	2008.01-		6MT/6AT/7AT	L/R	F	Saloon Engine CAHA	GC083086	Outer Joint	42	33	76.5	34	45.5	M				
	2008.01-		MT		F	Saloon Engine CAHA	GDS83291	Drive Shaft	42		76.4	34	464					
	2008.01-					Saloon Engine CAHA	GC083103	Outer Joint	42	28	76.4	34	54	I				
2.0 TDi Quattro (130 kW)	2011.11-		MT			Saloon Engine CGLC	GC083107	Outer Joint	42	25	76.5	34	47.5	I				
2.0 TFSi (132 kW)	2008.06-				F	Saloon Engine CAEA/CDNB/CDZA	GC083086	Outer Joint	42	33	76.5	34	45.5	M				
	2008.06-		6MT		F	Saloon Engine CAEA/CDNB/CDZA	GC083087	Outer Joint	42	27	76.5	34	54.5	M				
	2008.06-			L/R	F	Saloon Engine CAEA/CDNB/CDZA	GC083087	Outer Joint	42	27	76.5	34	54.5	M				
	2008.06-		6MT	L/R	F	Saloon Engine CAEA/CDNB/CDZA	GC083109	Outer Joint	42	27	76.5	34	54.5	M				
	2008.06-		6MT/CTV	L/R	F	Saloon Engine CAEA/CDNB/CDZA	GDS83273	Drive Shaft	42		76.5	34	460					
	2008.06-		6MT/CTV	L/R	F	Saloon Engine CAEA/CDNB/CDZA	GCI83022	Inner Joint		34		88						
	2008.06-			L/R	F	Saloon Engine CAEA/CDNB/CDZA	GDS83291	Drive Shaft	42		76.4	34	464					
	2008.06-					Saloon Engine CAEA/CDNB/CDZA	GC083103	Outer Joint	42	28	76.4	34	54	I				
2.0 TFSi (155 kW)	2008.06-		6MT		F	Saloon Engine CADA/CAEB/CDNC	GC083087	Outer Joint	42	27	76.5	34	54.5	M				
	2008.06-			L/R	F	Saloon Engine CADA/CAEB/CDNC	GC083087	Outer Joint	42	27	76.5	34	54.5	M				
	2008.06-		6MT	L/R	F	Saloon Engine CADA/CAEB/CDNC	GC083109	Outer Joint	42	27	76.5	34	54.5	M				
	2008.06-		6MT/CTV	L/R	F	Saloon Engine CADA/CAEB/CDNC	GDS83273	Drive Shaft	42		76.5	34	460					
	2008.06-		6MT/CTV	L/R	F	Saloon Engine CADA/CAEB/CDNC	GCI83022	Inner Joint		34		88						
	2008.06-		MT/AT	L/R	F	Saloon Engine CADA/CAEB/CDNC	GDS83291	Drive Shaft	42		76.4	34	464					
	2008.06-					Saloon Engine CADA/CAEB/CDNC	GC083103	Outer Joint	42	28	76.4	34	54	I				
	2008.06-					Saloon Engine CADA/CAEB/CDNC	GC083103	Outer Joint	42	28	76.4	34	54	I				
2.0 TFSi (162 kW)	2013.05-2015.12		MT/AT	L/R		Saloon Engine CAED	GDS83291	Drive Shaft	42		76.4	34	464					
	2013.05-2015.12					Saloon Engine CAED	GC083103	Outer Joint	42	28	76.4	34	54	I				
2.0 TFSi (165 kW)	2013.05-		MT/AT	L/R	F	Saloon Engine CNCD	GDS83291	Drive Shaft	42		76.4	34	464					
	2013.05-					Saloon Engine CNCD	GC083103	Outer Joint	42	28	76.4	34	54	I				
2.0 TFSi FlexFuel (132 kW)	2009.11-				F	Saloon Engine CFKA	GC083087	Outer Joint	42	27	76.5	34	54.5	M				
	2009.11-			L/R	F	Saloon Engine CFKA	GC083087	Outer Joint	42	27	76.5	34	54.5	M				
	2009.11-			L/R	F	Saloon Engine CFKA	GDS83291	Drive Shaft	42		76.4	34	464					
	2009.11-			L/R	F	Saloon Engine CFKA	GCI83022	Inner Joint		34		88						
	2009.11-					Saloon Engine CFKA	GC083103	Outer Joint	42	28	76.4	34	54	I				
2.0 TFSi FlexFuel Quattro (132 kW)	2009.11-				F	Saloon Engine CFKA	GC083086	Outer Joint	42	33	76.5	34	45.5	M				
	2009.11-			L/R	F	Saloon Engine CFKA	GDS83345	Drive Shaft	42		76.5	34	463					
	2009.11-			L/R	F	Saloon Engine CFKA	GCI83029	Inner Joint		24		88.5						
	2009.11-			L/R	F	Saloon Engine CFKA	GC083086	Outer Joint	42	33	76.5	34	45.5	M				
2.0 TFSi Quattro (155 kW)	2008.06-				F	Saloon Engine CDNC/CPMA	GC083086	Outer Joint	42	33	76.5	34	45.5	M				
	2008.06-		6MT/6AT/7AT	L/R	F	Saloon Engine CDNC/CPMA	GDS83345	Drive Shaft	42		76.5	34	463					
	2008.06-		6MT/6AT/7AT	L/R	F	Saloon Engine CDNC/CPMA	GCI83029	Inner Joint		24		88.5						
	2008.06-		6MT/6AT/7AT	L/R	F	Saloon Engine CDNC/CPMA	GC083086	Outer Joint	42	33	76.5	34	45.5	M				
2.0 TFSi Quattro (162 kW)	2013.05-2015.12		MT/AT	L/R	F	Saloon Engine CAED/CPMB	GDS83291	Drive Shaft	42		76.4	34	464					
	2013.05-2015.12					Saloon Engine CAED/CPMB	GC083103	Outer Joint	42	28	76.4	34	54	I				
2.0 TFSi Quattro (165 kW)	2013.05-		MT/AT	L/R	F	Saloon Engine CNCD	GDS83291	Drive Shaft	42		76.4	34	464					
	2013.05-					Saloon Engine CNCD	GC083103	Outer Joint	42	28	76.4	34	54	I				
2.7 TDi (140 kW)	2007.11-		6MT		F	Saloon Engine CAMA/CGKA	GC083088	Outer Joint	42	29	76.5	34	61.5	M				
	2007.11-			L/R	F	Saloon Engine CAMA/CGKA	GDS83321	Drive Shaft	42		76.5	34	462					
	2007.11-			L/R	F	Saloon Engine CAMA/CGKA	GCI83022	Inner Joint		34		88						
	2007.11-		MT/AT			Saloon Engine CAMA/CGKA	GDS83337	Drive Shaft	42		76.5	34	461					
	2007.11-					Saloon Engine CAMA/CGKA	GC083102	Outer Joint	42	29	76.5	34	60	I				
3.0 S4 Quattro (245 kW)	2008.11-			L/R		Saloon Engine CAKA/CCBA/CWGX/CGXC/CTUB	GC083087	Outer Joint	42	27	76.5	34	54.5	M				
	2008.11-				F	Saloon Engine CAKA/CCBA/CWGX/CGXC/CTUB	GC083086	Outer Joint	42	33	76.5	34	45.5	M				
	2008.11-			R		Saloon Engine CAKA/CCBA/CWGX/CGXC/CTUB	GC083088	Outer Joint	42	29	76.5	34	61.5	M				
	2008.11-			L/R	F	Saloon Engine CAKA/CCBA/CWGX/CGXC/CTUB	GDS83273	Drive Shaft	42		76.5	34	460					
	2008.11-			L/R	F	Saloon Engine CAKA/CCBA/CWGX/CGXC/CTUB	GCI83022	Inner Joint		34		88						
	2008.11-		AT		F	Saloon Engine CAKA/CCBA/CWGX/CGXC/CTUB	GDS83291	Drive Shaft	42		76.4	34	464					



	 YEAR	TRANSM	L/R	F/R		G-AP Ref.	PRODUCT	ABS	Technical Specifications									
									A	B	C	H	L	P				
<b>AUDI</b>																		
<b>A4 (8K2, B8)</b>																		
3.0 S4 Quattro (245 kW)	2008.11-				Saloon Engine CAKA/CCBA/CGWC/CGXC/CTUB	GC083103	Outer Joint		42	28	76.4	34	54	I				
3.0 TDi (150 kW)	2011.11-			F	Saloon Engine CLAB	GDS83337	Drive Shaft		42		76.5	34	461					
	2011.11-				Saloon Engine CLAB	GC083102	Outer Joint		42	29	76.5	34	60	I				
3.0 TDi Quattro (155 kW)	2008.06-			L/R	Saloon Engine CCWB	GC083087	Outer Joint		42	27	76.5	34	54.5	M				
	2008.06-			R	Saloon Engine CCWB	GC083088	Outer Joint		42	29	76.5	34	61.5	M				
	2008.06-		MT/AT	L/R	F	Saloon Engine CCWB	GDS83291	Drive Shaft		42		76.4	34	464				
	2008.06-			L/R	F	Saloon Engine CCWB	GDS83273	Drive Shaft		42		76.5	34	460				
	2008.06-			L/R	F	Saloon Engine CCWB	GCI83022	Inner Joint			34		88					
	2008.06-		MT/AT			Saloon Engine CCWB	GC083103	Outer Joint		42	28	76.4	34	54	I			
3.0 TDi Quattro (176 kW)	2007.11-		6MT	L/R	Saloon Engine CAPA/CCLA/CCWA	GDS83321	Drive Shaft		42		76.5	34	462					
	2007.11-		6MT/CVT	L/R	Saloon Engine CAPA/CCLA/CCWA	GC083087	Outer Joint		42	27	76.5	34	54.5	M				
	2007.11-		6MT/6AT/7AT	L/R	F	Saloon Engine CAPA/CCLA/CCWA	GDS83273	Drive Shaft		42		76.5	34	460				
	2007.11-		6MT/6AT/7AT	L/R	F	Saloon Engine CAPA/CCLA/CCWA	GCI83022	Inner Joint			34		88					
	2007.11-		MT/AT	L/R	F	Saloon Engine CAPA/CCLA/CCWA	GDS83291	Drive Shaft		42		76.4	34	464				
	2007.11-		6MT	L/R		Saloon Engine CAPA/CCLA/CCWA	GCI83022	Inner Joint			34		88					
	2007.11-		MT/AT			Saloon Engine CAPA/CCLA/CCWA	GC083103	Outer Joint		42	28	76.4	34	54	I			
3.0 TDi Quattro (180 kW)	2011.11-			L/R	F	Saloon Engine CDUC/CKVB/CKVC	GDS83291	Drive Shaft		42		76.4	34	464				
	2011.11-				Saloon Engine CDUC/CKVB/CKVC	GC083103	Outer Joint		42	28	76.4	34	54	I				
3.0 TFSi Quattro (200 kW)	2012.02-			L/R	F	Saloon Engine CMUA	GDS83291	Drive Shaft		42		76.4	34	464				
	2012.02-				Saloon Engine CMUA	GC083103	Outer Joint		42	28	76.4	34	54	I				
3.2 FSi (195 kW)	2008.09-				F	Saloon Engine CALA	GC083087	Outer Joint		42	27	76.5	34	54.5	M			
	2008.09-			L/R	F	Saloon Engine CALA	GC083087	Outer Joint		42	27	76.5	34	54.5	M			
	2008.09-		CTV	L/R	F	Saloon Engine CALA	GDS83273	Drive Shaft		42		76.5	34	460				
	2008.09-		CTV	L/R	F	Saloon Engine CALA	GCI83022	Inner Joint			34		88					
	2008.09-			L/R	F	Saloon Engine CALA	GDS83291	Drive Shaft		42		76.4	34	464				
	2008.09-					Saloon Engine CALA	GC083103	Outer Joint		42	28	76.4	34	54	I			
3.2 FSi Quattro (195 kW)	2007.11-		MT/AT		F	Saloon Engine CALA	GC083086	Outer Joint		42	33	76.5	34	45.5	M			
	2007.11-		6MT/6AT/7AT	L/R	F	Saloon Engine CALA	GDS83345	Drive Shaft		42		76.5	34	463				
	2007.11-		6MT/6AT/7AT	L/R	F	Saloon Engine CALA	GCI83029	Inner Joint			24		88.5					
	2007.11-		6MT/6AT/7AT	L/R	F	Saloon Engine CALA	GC083086	Outer Joint		42	33	76.5	34	45.5	M			
	2007.11-		CTV	L/R	F	Saloon Engine CALA	GDS83273	Drive Shaft		42		76.5	34	460				
	2007.11-		CTV	L/R	F	Saloon Engine CALA	GCI83022	Inner Joint			34		88					
<b>A4 / A4 AVANT</b>																		
1.6			MT/AT			GC083045	Outer Joint		33	30	53	30	62	I				
1.8			MT/AT			GC083045	Outer Joint		33	30	53	30	62	I				
1.9			MT/AT			GC083045	Outer Joint		33	30	53	30	62	I				
<b>A4 ALLROAD (8KH, B8)</b>																		
2.0 TDi Quattro (100 kW)	2009.09-		6MT/7AT	L/R	F	Estate Engine CAGB/CJCB	GDS83345	Drive Shaft		42		76.5	34	463				
	2009.09-		6MT/7AT	L/R	F	Estate Engine CAGB/CJCB	GCI83029	Inner Joint			24		88.5					
	2009.09-		6MT/7AT	L/R	F	Estate Engine CAGB/CJCB	GC083086	Outer Joint		42	33	76.5	34	45.5	M			
	2009.09-					Estate Engine CAGB/CJCB	GC083107	Outer Joint		42	25	76.5	34	47.5	I			
2.0 TDi Quattro (105 kW)	2009.09-					Estate Engine CAGA/CJCA	GC083086	Outer Joint		42	33	76.5	34	45.5	M			
	2009.09-		6MT/7AT	L/R	F	Estate Engine CAGA/CJCA	GDS83345	Drive Shaft		42		76.5	34	463				
	2009.09-		6MT/7AT	L/R	F	Estate Engine CAGA/CJCA	GCI83029	Inner Joint			24		88.5					
	2009.09-		6MT/7AT	L/R	F	Estate Engine CAGA/CJCA	GC083086	Outer Joint		42	33	76.5	34	45.5	M			
	2009.09-		6MT/7AT	L/R	F	Estate Engine CAGA/CJCA	GC083107	Outer Joint		42	25	76.5	34	47.5	I			
2.0 TDi Quattro (110 kW)	2013.05-		MT		Estate Engine CJCD	GC083107	Outer Joint		42	25	76.5	34	47.5	I				
2.0 TDi Quattro (120 kW)	2009.04-		6MT/7AT	L/R	F	Estate Engine CAHB/CGLD	GDS83345	Drive Shaft		42		76.5	34	463				
	2009.04-		6MT/7AT	L/R	F	Estate Engine CAHB/CGLD	GCI83029	Inner Joint			24		88.5					
	2009.04-		6MT/7AT	L/R	F	Estate Engine CAHB/CGLD	GC083086	Outer Joint		42	33	76.5	34	45.5	M			
	2009.04-					Estate Engine CAHB/CGLD	GC083107	Outer Joint		42	25	76.5	34	47.5	I			
2.0 TDi Quattro (125 kW)	2009.04-		6MT/7AT		F	Estate Engine CAHA	GC083086	Outer Joint		42	33	76.5	34	45.5	M			
	2009.04-		6MT/7AT	L/R	F	Estate Engine CAHA	GDS83345	Drive Shaft		42		76.5	34	463				
	2009.04-		6MT/7AT	L/R	F	Estate Engine CAHA	GCI83029	Inner Joint			24		88.5					
	2009.04-		6MT/7AT	L/R	F	Estate Engine CAHA	GC083086	Outer Joint		42	33	76.5	34	45.5	M			
	2009.04-					Estate Engine CAHA	GC083107	Outer Joint		42	25	76.5	34	47.5	I			
2.0 TDi Quattro (130 kW)	2011.11-			L/R	F	Estate Engine CGLC	GCI83029	Inner Joint			24		88.5					
	2011.11-			L/R	F	Estate Engine CGLC	GC083086	Outer Joint		42	33	76.5	34	45.5	M			
	2011.11-					Estate Engine CGLC	GC083107	Outer Joint		42	25	76.5	34	47.5	I			
	2011.11-			L/R	F	Estate Engine CGLC	GDS83345	Drive Shaft		42		76.5	34	463				
2.0 TDi Quattro (140 kW)	2013.09-		MT		Estate Engine CNHA	GC083107	Outer Joint		42	25	76.5	34	47.5	I				





	 YEAR	TRANSM	L/R	F/R		G-AP Ref.	PRODUCT	ABS	Technical Specifications						
									A	B	C	H	L	P	
<b>AUDI</b>															
<b>A4 ALLROAD (8KH, B8)</b>															
2.0 TFSi Quattro (155 kW)	2009.04-		6MT/7AT		F	Estate Engine CDNC/CPMA	GC083086	Outer Joint		42	33	76.5	34	45.5	M
	2009.04-		6MT/7AT	L/R	F	Estate Engine CDNC/CPMA	GDS83345	Drive Shaft		42		76.5	34	463	
	2009.04-		6MT/7AT	L/R	F	Estate Engine CDNC/CPMA	GCI83029	Inner Joint			24		88.5		
	2009.04-		6MT/7AT	L/R	F	Estate Engine CDNC/CPMA	GC083086	Outer Joint		42	33	76.5	34	45.5	M
	2009.04-					Estate Engine CDNC/CPMA	GC083107	Outer Joint		42	25	76.5	34	47.5	I
2.0 TFSi Quattro (162 kW)	2013.05-		MT			Estate Engine CPMB	GC083107	Outer Joint		42	25	76.5	34	47.5	I
2.0 TFSi Quattro (165 kW)	2013.05-		MT			Estate Engine CNCD	GC083107	Outer Joint		42	25	76.5	34	47.5	I
3.0 TDi Quattro (176 kW)	2009.04-		6MT/7AT	L/R		Estate Engine CCWA	GC083087	Outer Joint		42	27	76.5	34	54.5	M
	2009.04-		6MT	L/R	F	Estate Engine CCWA	GDS83273	Drive Shaft		42		76.5	34	460	
	2009.04-		6MT	L/R	F	Estate Engine CCWA	GCI83022	Inner Joint			34		88		
3.0 TDi Quattro (180 kW)	2012.01-			L/R	F	Estate Engine CDUC/CKVB/CKVC	GDS83291	Drive Shaft		42		76.4	34	464	
	2012.01-					Estate Engine CDUC/CKVB/CKVC	GC083103	Outer Joint		42	28	76.4	34	54	I
<b>A4 AVANT (8D5, B5)</b>															
1.6 (74 kW)	1994.11-	2001.09		L/R	F	Estate Engine ADP/AHL/ANA/ARM	GCI61033	Inner Joint				34		85	
	1994.11-	2001.09	MT/AT		F	Estate Engine ADP/AHL/ANA/ARM	GC083045	Outer Joint		33	30	53	30	62	I
1.8 (92 kW)	1996.02-	2001.09		L/R	F	Estate Engine ADR/APT/ARG/AVV	GCI61033	Inner Joint				34		85	
	1996.02-	2001.09	MT/AT		F	Estate Engine ADR/APT/ARG/AVV	GC083045	Outer Joint		33	30	53	30	62	I
1.8 Quattro (92 kW)	1996.01-	2001.09	MT			Estate Engine ADR/APT/ARG	GC083045	Outer Joint		33	30	53	30	62	I
1.8 T (110 kW)	1996.03-	2001.09	AT	L	F	Estate Engine AEB/ANB/APU/ARK/AWT	GDS83036	Drive Shaft	45W	33		53	30	524	
	1996.03-	2001.09	MT		F	Estate Engine AEB/ANB/APU/ARK/AWT	GC083045	Outer Joint		33	30	53	30	62	I
1.8 T Quattro (110 kW)	1996.01-	2001.09	AT	L	F	Estate Engine AEB/ANB/APU/ARK/AWT	GDS83036	Drive Shaft	45W	33		53	30	524	
	1996.01-	2001.09		L/R	F	Estate Engine AEB/ANB/APU/ARK/AWT	GCI61033	Inner Joint				34		85	
	1996.01-	2001.09	MT/AT			Estate Engine AEB/ANB/APU/ARK/AWT	GC083045	Outer Joint		33	30	53	30	62	I
1.8 T Quattro (132 kW)	1997.12-	2001.09	MT			Estate Engine AJL	GC083049	Outer Joint		38	30	59.5	34	59.5	I
1.9 DUO (66 kW)	1998.03-	2001.09			F	Estate Engine AHU	GC083045	Outer Joint		33	30	53	30	62	I
1.9 TDi (55 kW)	1996.03-	2001.09		L/R	F	Estate Engine AFF	GCI61033	Inner Joint				34		85	
	1996.03-	2001.09	MT/AT		F	Estate Engine AFF	GC083045	Outer Joint		33	30	53	30	62	I
1.9 TDi (66 kW)	1996.02-	2001.09		L/R	F	Estate Engine 1Z/AHH/AHU	GCI61033	Inner Joint				34		85	
	1996.02-	2001.09	MT/AT		F	Estate Engine 1Z/AHH/AHU	GC083045	Outer Joint		33	30	53	30	62	I
1.9 TDi (81 kW)	1996.02-	2001.09		L/R	F	Estate Engine AFN/AVG	GCI61033	Inner Joint				34		85	
	1996.02-	2001.09	MT/AT		F	Estate Engine AFN/AVG	GC083045	Outer Joint		33	30	53	30	62	I
1.9 TDi Quattro (81 kW)	1996.09-	2001.09		L/R	F	Estate Engine AFN/AVG	GCI61033	Inner Joint				34		85	
	1996.09-	2001.09	MT			Estate Engine AFN/AVG	GC083045	Outer Joint		33	30	53	30	62	I
1.9 TDi Quattro (85 kW)	2000.03-	2001.09	MT	L	F	Estate Engine AJM/ATJ	GDS61157	Drive Shaft	45W	38		59.5	34.5	601	
	2000.03-	2001.09		L/R	F	Estate Engine AJM/ATJ	GCI61033	Inner Joint				34		85	
2.4 (120 kW)	1997.08-	2001.09		L/R	F	Estate Engine AJG/AMM/APZ	GCI61033	Inner Joint				34		85	
2.4 (121 kW)	1997.03-	2001.09		L/R	F	Estate Engine AGA/ALF/AML/APS/ARJ	GCI61033	Inner Joint				34		85	
2.4 Quattro (120 kW)	1997.08-	2001.09		L/R	F	Estate Engine APZ	GCI61033	Inner Joint				34		85	
2.4 Quattro (121 kW)	1997.03-	2001.09		L/R	F	Estate Engine AGA/ALF/AML/APS/ARJ	GCI61033	Inner Joint				34		85	
2.5 TDi (110 kW)	1997.09-	2001.09		L/R	F	Estate Engine AFB/AKN	GCI61033	Inner Joint				34		85	
2.5 TDi Quattro (110 kW)	1997.09-	2001.09		L/R	F	Estate Engine AFB/AKN	GCI61033	Inner Joint				34		85	
	1996.02-	2001.09		L/R	F	Estate Engine ABC	GCI61033	Inner Joint				34		85	
	1996.02-	2001.09	MT	R	F	Estate Engine ABC	GDS83362	Drive Shaft	45W	38		59.5	34	621	
2.6 (110 kW)	1996.02-	2001.09	AT		F	Estate Engine ABC	GC083049	Outer Joint		38	30	59.5	34	59.5	I
	1996.02-	2001.09	MT			Estate Engine ABC	GC083049	Outer Joint		38	30	59.5	34	59.5	I
2.6 Quattro (110 kW)	1996.01-	2001.09	MT			Estate Engine ABC	GC083049	Outer Joint		38	30	59.5	34	59.5	I
2.8 (128 kW)	1996.03-	1996.09	AT	R	F	Estate Engine AAH	GDS83048	Drive Shaft	45W	38		59.5	34.5	502	
	1996.03-	1996.09	AT	L	F	Estate Engine AAH	GDS83015	Drive Shaft	45W	38		59.5	34.5	527	
2.8 (142 kW)	1996.10-	2001.09		L/R	F	Estate Engine ACK/AHA/ALG/AMX/APR/AQD	GCI61033	Inner Joint				34		85	
	1996.10-	2001.09	AT	R	F	Estate Engine ACK/AHA/ALG/AMX/APR/AQD	GDS83048	Drive Shaft	45W	38		59.5	34.5	502	
	1996.10-	2001.09	AT	L	F	Estate Engine ACK/AHA/ALG/AMX/APR/AQD	GDS83015	Drive Shaft	45W	38		59.5	34.5	527	
2.8 Quattro (142 kW)	1996.10-	2001.09	MT			Estate Engine ACK/AHA/ALG/AMX/APR/AQD	GC083049	Outer Joint		38	30	59.5	34	59.5	I
<b>A4 AVANT (8E5, B6)</b>															
1.6 (75 kW)	2001.09-	2004.12			F	Estate Engine ALZ	GC083058	Outer Joint	45W	38	33	59.5	34	55	M
	2001.09-	2004.12			F	Estate Engine ALZ	GC083030	Outer Joint		38	33	59.5	34	55	M
1.8 T (110 kW)	2001.09-	2002.07			F	Estate Engine AVJ	GC083030	Outer Joint		38	33	59.5	34	55	M
	2001.09-	2002.07	AT		F	Estate Engine AVJ	GCI61044	Inner Joint				34		85	
	2001.09-	2002.07	MT		F	Estate Engine AVJ	GC083058	Outer Joint	45W	38	33	59.5	34	55	M
	2001.09-	2002.07	MT&Semi-AT		F	Estate Engine AVJ	GC083092	Outer Joint	45W	38	27	59.5	34	68	I
	2001.09-	2002.07	MT	L	F	Estate Engine AVJ	GDS61115	Drive Shaft	45W	38		59.5	34	597	
	2001.09-	2002.07	MT	L	F	Estate Engine AVJ	GDS83057	Drive Shaft	45W	38		59.5	34.5	593	
	2001.09-	2002.07	AT	L/R	F	Estate Engine AVJ	GDS83052	Drive Shaft	45W	38		59.5	34.5	522	
2001.09-	2002.07	MT	R	F	Estate Engine AVJ	GDS83362	Drive Shaft	45W	38		59.5	34	621		





	 YEAR	TRANSM	L/R	F/R		G-AP Ref.	PRODUCT	ABS	Technical Specifications								
									A	B	C	H	L	P			
<b>AUDI</b>																	
<b>A4 AVANT (8E5, B6)</b>																	
1.8 T (110 kW)	2001.09-	2002.07	MT	R	F	Estate Engine AVJ	GDS83058	Drive Shaft	45W	38		59.5	34.5	613			
1.8 T (120 kW)	2002.07-	2004.12			F	Estate Engine BFB	GC083058	Outer Joint	45W	38	33	59.5	34	55	M		
	2002.07-	2004.12			F	Estate Engine BFB	GC083030	Outer Joint		38	33	59.5	34	55	M		
	2002.07-	2004.12	MT		F	Estate Engine BFB	GC083067	Outer Joint	45W	38	27	59.5	34	68	M		
	2002.07-	2004.12	MT&Semi-AT		F	Estate Engine BFB	GC083092	Outer Joint	45W	38	27	59.5	34	68	I		
	2002.07-	2004.12	MT/AT		F	Estate Engine BFB	GCI61044	Inner Joint			34		85				
	2002.07-	2004.12	MT	L	F	Estate Engine BFB	GDS83352	Drive Shaft	45W	38			59.5	34.5	594		
	2002.07-	2004.12	MT	L	F	Estate Engine BFB	GDS83057	Drive Shaft	45W	38			59.5	34.5	593		
	2002.07-	2004.12	AT	L/R	F	Estate Engine BFB	GDS83052	Drive Shaft	45W	38			59.5	34.5	522		
	2002.07-	2004.12	MT	R	F	Estate Engine BFB	GDS83058	Drive Shaft	45W	38			59.5	34.5	613		
1.8 T (140 kW)	2002.07-	2004.12			F	Estate Engine BFB	GC083069	Outer Joint	45W	38	27	59.5	34.5	63	M		
	2002.11-	2004.12	MT		F	Estate Engine BEX	GC083078	Outer Joint	45W	38	27	59.5	34.5	63	M		
	2002.11-	2004.12	MT/AT		F	Estate Engine BEX	GC083067	Outer Joint	45W	38	27	59.5	34	68	M		
	2002.11-	2004.12		L	F	Estate Engine BEX	GCI61044	Inner Joint			34		85				
	2002.11-	2004.12		L	F	Estate Engine BEX	GDS83352	Drive Shaft	45W	38			59.5	34.5	594		
	2002.11-	2004.12	AT	L/R	F	Estate Engine BEX	GDS83052	Drive Shaft	45W	38			59.5	34.5	522		
1.8 T Quattro (110 kW)	2002.11-	2004.12	AT		F	Estate Engine BEX	GC083069	Outer Joint	45W	38	27	59.5	34.5	63	M		
	2001.09-	2002.07	MT		F	Estate Engine AVJ	GC083058	Outer Joint	45W	38	33	59.5	34	55	M		
	2001.09-	2002.07	AT		F	Estate Engine AVJ	GCI61044	Inner Joint			34		85				
	2001.09-	2002.07	MT		F	Estate Engine AVJ	GC083092	Outer Joint	45W	38	27	59.5	34	68	I		
	2001.09-	2002.07	MT	L	F	Estate Engine AVJ	GDS61115	Drive Shaft	45W	38			59.5	34	597		
	2001.09-	2002.07	MT	L	F	Estate Engine AVJ	GDS83057	Drive Shaft	45W	38			59.5	34.5	593		
	2001.09-	2002.07	AT	L/R	F	Estate Engine AVJ	GDS83052	Drive Shaft	45W	38			59.5	34.5	522		
	2001.09-	2002.07	MT	R	F	Estate Engine AVJ	GDS83362	Drive Shaft	45W	38			59.5	34	621		
1.8 T Quattro (120 kW)	2001.09-	2002.07	MT	R	F	Estate Engine AVJ	GDS83058	Drive Shaft	45W	38			59.5	34.5	613		
	2002.07-	2004.12			F	Estate Engine BFB	GC083058	Outer Joint	45W	38	33	59.5	34	55	M		
	2002.07-	2004.12			F	Estate Engine BFB	GC083030	Outer Joint		38	33	59.5	34	55	M		
	2002.07-	2004.12	MT		F	Estate Engine BFB	GCI61044	Inner Joint			34		85				
	2002.07-	2004.12	MT	L	F	Estate Engine BFB	GDS83310	Drive Shaft	45W	38			59.5	34	594		
	2002.07-	2004.12	AT	L/R	F	Estate Engine BFB	GDS83052	Drive Shaft	45W	38			59.5	34.5	522		
	2002.07-	2004.12	MT	L/R	F	Estate Engine BFB	GCI61070	Inner Joint			24		85				
	2002.07-	2004.12	MT	L/R	F	Estate Engine BFB	GC061075	Outer Joint	45W	38	33	59.5	34	56.5	M		
1.8 T Quattro (140 kW)	2002.07-	2004.12	MT	R	F	Estate Engine BFB	GDS83362	Drive Shaft	45W	38			59.5	34	621		
	2002.11-	2004.12			F	Estate Engine BEX	GC083058	Outer Joint	45W	38	33	59.5	34	55	M		
	2002.11-	2004.12			F	Estate Engine BEX	GC083030	Outer Joint		38	33	59.5	34	55	M		
	2002.11-	2004.12	MT		F	Estate Engine BEX	GCI61044	Inner Joint			34		85				
	2002.11-	2004.12	MT	L	F	Estate Engine BEX	GDS83310	Drive Shaft	45W	38			59.5	34	594		
	2002.11-	2004.12		L	F	Estate Engine BEX	GDS61115	Drive Shaft	45W	38			59.5	34	597		
	2002.11-	2004.12	AT	L/R	F	Estate Engine BEX	GDS83052	Drive Shaft	45W	38			59.5	34.5	522		
	2002.11-	2004.12	MT	L/R	F	Estate Engine BEX	GCI61070	Inner Joint			24		85				
1.9 TDi (74 kW)	2002.11-	2004.12	MT	L/R	F	Estate Engine BEX	GC061075	Outer Joint	45W	38	33	59.5	34	56.5	M		
	2002.11-	2004.12	MT	R	F	Estate Engine BEX	GDS83362	Drive Shaft	45W	38			59.5	34	621		
	2001.11-	2004.12			F	Estate Engine AVB	GC083078	Outer Joint	45W	38	27	59.5	34.5	63	M		
	2001.11-	2004.12			F	Estate Engine AVB	GC083067	Outer Joint	45W	38	27	59.5	34	68	M		
	2001.11-	2004.12	MT		F	Estate Engine AVB	GC083092	Outer Joint	45W	38	27	59.5	34	68	I		
	2001.11-	2004.12	MT/AT		F	Estate Engine AVB	GCI61044	Inner Joint			34		85				
	2001.11-	2004.12	MT	L	F	Estate Engine AVB	GDS83352	Drive Shaft	45W	38			59.5	34.5	594		
	2001.11-	2004.12	MT	L	F	Estate Engine AVB	GDS83057	Drive Shaft	45W	38			59.5	34.5	593		
1.9 TDi (85 kW)	2001.11-	2004.12	MT	R	F	Estate Engine AVB	GDS83058	Drive Shaft	45W	38			59.5	34.5	613		
	2001.11-	2004.12	MT		F	Estate Engine AVB	GC083069	Outer Joint	45W	38	27	59.5	34.5	63	M		
	2004.06-	2004.12			F	Estate Engine BKE	GC083078	Outer Joint	45W	38	27	59.5	34.5	63	M		
	2004.06-	2004.12			F	Estate Engine BKE	GC083067	Outer Joint	45W	38	27	59.5	34	68	M		
1.9 TDi (96 kW)	2004.06-	2004.12		L	F	Estate Engine BKE	GDS83352	Drive Shaft	45W	38			59.5	34.5	594		
	2001.09-	2004.12	MT&AT		F	Estate Engine AVF/AWX	GC083092	Outer Joint	45W	38	27	59.5	34	68	I		
	2001.09-	2004.12	MT/AT		F	Estate Engine AVF/AWX	GC083078	Outer Joint	45W	38	27	59.5	34.5	63	M		
	2001.09-	2004.12	MT/AT		F	Estate Engine AVF/AWX	GCI61044	Inner Joint			34		85				
	2001.09-	2004.12	MT	L	F	Estate Engine AVF/AWX	GDS83352	Drive Shaft	45W	38			59.5	34.5	594		
	2001.09-	2004.12	MT	L	F	Estate Engine AVF/AWX	GDS83057	Drive Shaft	45W	38			59.5	34.5	593		
	2001.09-	2004.12	AT	L/R	F	Estate Engine AVF/AWX	GDS83052	Drive Shaft	45W	38			59.5	34.5	522		
	2001.09-	2004.12	MT	R	F	Estate Engine AVF/AWX	GDS83058	Drive Shaft	45W	38			59.5	34.5	613		
1.9 TDi Quattro (96 kW)	2001.09-	2004.12	AT		F	Estate Engine AVF/AWX	GC083069	Outer Joint	45W	38	27	59.5	34.5	63	M		
	2001.11-	2004.12			F	Estate Engine AVF	GC083058	Outer Joint	45W	38	33	59.5	34	55	M		
	2001.11-	2004.12			F	Estate Engine AVF	GC083092	Outer Joint	45W	38	27	59.5	34	68	I		



		YEAR	TRANSM	L/R	F/R		G-AP Ref.	PRODUCT	ABS	Technical Specifications						
										A	B	C	H	L	P	
<b>AUDI</b>																
<b>A4 AVANT (8E5, B6)</b>																
1.9 TDi Quattro (96 kW)	2001.11-	2004.12			F	Estate Engine AVF	GC083030	Outer Joint		38	33	59.5	34	55	M	
	2001.11-	2004.12	MT/AT		F	Estate Engine AVF	GCI161044	Inner Joint			34		85			
	2001.11-	2004.12	MT	L	F	Estate Engine AVF	GDS83057	Drive Shaft	45W	38		59.5	34.5	593		
	2001.11-	2004.12		L	F	Estate Engine AVF	GDS61115	Drive Shaft	45W	38		59.5	34	597		
	2001.11-	2004.12	AT	L/R	F	Estate Engine AVF	GDS83052	Drive Shaft	45W	38		59.5	34.5	522		
	2001.11-	2004.12	MT	R	F	Estate Engine AVF	GDS83362	Drive Shaft	45W	38		59.5	34	621		
	2001.11-	2004.12	MT	R	F	Estate Engine AVF	GDS83058	Drive Shaft	45W	38		59.5	34.5	613		
2.0 (96 kW)	2001.09-	2004.12			F	Estate Engine ALT	GC083030	Outer Joint		38	33	59.5	34	55	M	
	2001.09-	2004.12	MT		F	Estate Engine ALT	GCI161044	Inner Joint			34		85			
	2001.09-	2004.12	MT		F	Estate Engine ALT	GC083092	Outer Joint	45W	38	27	59.5	34	68	I	
	2001.09-	2004.12	MT/AT		F	Estate Engine ALT	GC083058	Outer Joint	45W	38	33	59.5	34	55	M	
	2001.09-	2004.12	MT	L	F	Estate Engine ALT	GDS83310	Drive Shaft	45W	38		59.5	34	594		
	2001.09-	2004.12	MT	L/R	F	Estate Engine ALT	GCI161070	Inner Joint			24		85			
	2001.09-	2004.12	MT	L/R	F	Estate Engine ALT	GC061075	Outer Joint	45W	38	33	59.5	34	56.5	M	
	2001.09-	2004.12		L/R	F	Estate Engine ALT	GDS83364	Drive Shaft	45W	38		59.5	34	522		
2.0 FSi (110 kW)	2002.07-	2004.12	MT		F	Estate Engine AWA	GC083058	Outer Joint	45W	38	33	59.5	34	55	M	
	2002.07-	2004.12	MT		F	Estate Engine AWA	GC083030	Outer Joint		38	33	59.5	34	55	M	
	2002.07-	2004.12	MT/AT		F	Estate Engine AWA	GCI161044	Inner Joint			34		85			
	2002.07-	2004.12	Semi-AT		F	Estate Engine AWA	GC083092	Outer Joint	45W	38	27	59.5	34	68	I	
	2002.07-	2004.12	MT	L	F	Estate Engine AWA	GDS83310	Drive Shaft	45W	38		59.5	34	594		
	2002.07-	2004.12	AT	L/R	F	Estate Engine AWA	GDS83052	Drive Shaft	45W	38		59.5	34.5	522		
	2002.07-	2004.12	MT	L/R	F	Estate Engine AWA	GCI161070	Inner Joint			24		85			
	2002.07-	2004.12	MT	L/R	F	Estate Engine AWA	GC061075	Outer Joint	45W	38	33	59.5	34	56.5	M	
	2002.07-	2004.12		L/R	F	Estate Engine AWA	GDS83364	Drive Shaft	45W	38		59.5	34	522		
	2002.07-	2004.12	MT	R	F	Estate Engine AWA	GDS83362	Drive Shaft	45W	38		59.5	34	621		
2002.07-	2004.12	AT			Estate Engine AWA	GC083069	Outer Joint	45W	38	27	59.5	34.5	63	M		
2.4 (120 kW)	2001.09-	2004.12	MT		F	Estate Engine AMM	GC083067	Outer Joint	45W	38	27	59.5	34	68	M	
	2001.09-	2004.12	MT&Semi-AT		F	Estate Engine AMM	GC083092	Outer Joint	45W	38	27	59.5	34	68	I	
	2001.09-	2004.12	MT/AT		F	Estate Engine AMM	GCI161044	Inner Joint			34		85			
	2001.09-	2004.12	MT	L	F	Estate Engine AMM	GDS83352	Drive Shaft	45W	38		59.5	34.5	594		
	2001.09-	2004.12	AT	L/R	F	Estate Engine AMM	GDS83052	Drive Shaft	45W	38		59.5	34.5	522		
	2001.09-	2004.12	AT			Estate Engine AMM	GC083069	Outer Joint	45W	38	27	59.5	34.5	63	M	
2.4 (125 kW)	2001.09-	2004.12	MT		F	Estate Engine BDV	GC083067	Outer Joint	45W	38	27	59.5	34	68	M	
	2001.09-	2004.12	MT&Semi-AT		F	Estate Engine BDV	GC083092	Outer Joint	45W	38	27	59.5	34	68	I	
	2001.09-	2004.12	MT/AT		F	Estate Engine BDV	GCI161044	Inner Joint			34		85			
	2001.09-	2004.12	MT	L	F	Estate Engine BDV	GDS83352	Drive Shaft	45W	38		59.5	34.5	594		
	2001.09-	2004.12	MT	L	F	Estate Engine BDV	GDS83057	Drive Shaft	45W	38		59.5	34.5	593		
	2001.09-	2004.12	AT	L/R	F	Estate Engine BDV	GDS83052	Drive Shaft	45W	38		59.5	34.5	522		
	2001.09-	2004.12	MT	R	F	Estate Engine BDV	GDS83058	Drive Shaft	45W	38		59.5	34.5	613		
	2001.09-	2004.12	AT			Estate Engine BDV	GC083069	Outer Joint	45W	38	27	59.5	34.5	63	M	
2.5 TDi (114 kW)	2001.09-	2002.07	MT		F	Estate Engine AYM	GC083067	Outer Joint	45W	38	27	59.5	34	68	M	
	2001.09-	2002.07	MT		F	Estate Engine AYM	GC083092	Outer Joint	45W	38	27	59.5	34	68	I	
	2001.09-	2002.07	MT/AT		F	Estate Engine AYM	GCI161044	Inner Joint			34		85			
	2001.09-	2002.07	MT	L	F	Estate Engine AYM	GDS83363	Drive Shaft	45W	38		59.5	34.5	611		
	2001.09-	2002.07	MT	L	F	Estate Engine AYM	GDS83057	Drive Shaft	45W	38		59.5	34.5	593		
	2001.09-	2002.07	AT	L/R	F	Estate Engine AYM	GDS83052	Drive Shaft	45W	38		59.5	34.5	522		
	2001.09-	2002.07		L/R	F	Estate Engine AYM	GCI161033	Inner Joint			34		85			
	2001.09-	2002.07	MT	R	F	Estate Engine AYM	GDS83058	Drive Shaft	45W	38		59.5	34.5	613		
	2001.09-	2002.07	AT			Estate Engine AYM	GC083069	Outer Joint	45W	38	27	59.5	34.5	63	M	
2.5 TDi (120 kW)	2002.07-	2004.12			F	Estate Engine BCZ/BDG/BFC	GC083078	Outer Joint	45W	38	27	59.5	34.5	63	M	
	2002.07-	2004.12	MT		F	Estate Engine BCZ/BDG/BFC	GC083067	Outer Joint	45W	38	27	59.5	34	68	M	
	2002.07-	2004.12	MT&Semi-AT		F	Estate Engine BCZ/BDG/BFC	GC083092	Outer Joint	45W	38	27	59.5	34	68	I	
	2002.07-	2004.12	MT/AT		F	Estate Engine BCZ/BDG/BFC	GCI161044	Inner Joint			34		85			
	2002.07-	2004.12	MT	L	F	Estate Engine BCZ/BDG/BFC	GDS83363	Drive Shaft	45W	38		59.5	34.5	611		
	2002.07-	2004.12	MT	L	F	Estate Engine BCZ/BDG/BFC	GDS83057	Drive Shaft	45W	38		59.5	34.5	593		
	2002.07-	2004.12	AT	L/R	F	Estate Engine BCZ/BDG/BFC	GDS83052	Drive Shaft	45W	38		59.5	34.5	522		
	2002.07-	2004.12		L/R	F	Estate Engine BCZ/BDG/BFC	GCI161033	Inner Joint			34		85			
	2002.07-	2004.12	MT	R	F	Estate Engine BCZ/BDG/BFC	GDS83058	Drive Shaft	45W	38		59.5	34.5	613		
	2002.07-	2004.12	AT			Estate Engine BCZ/BDG/BFC	GC083069	Outer Joint	45W	38	27	59.5	34.5	63	M	
2.5 TDi Quattro (132 kW)	2001.09-	2004.12	MT		F	Estate Engine AKE/BAU/BDH	GC083067	Outer Joint	45W	38	27	59.5	34	68	M	
	2001.09-	2004.12	MT		F	Estate Engine AKE/BAU/BDH	GCI161044	Inner Joint			34		85			
	2001.09-	2004.12	MT&AT		F	Estate Engine AKE/BAU/BDH	GC083092	Outer Joint	45W	38	27	59.5	34	68	I	





		YEAR	TRANSM	L/R	F/R		G-AP Ref.	PRODUCT	ABS	Technical Specifications						
										A	B	C	H	L	P	
<b>AUDI</b>																
<b>A4 AVANT (8E5, B6)</b>																
2.5 TDi Quattro (132 kW)	2001.09-	2004.12	MT	L	F	Estate Engine AKE/BAU/BDH	GDS83352	Drive Shaft	45W	38		59.5	34.5	594		
	2001.09-	2004.12	MT	L	F	Estate Engine AKE/BAU/BDH	GDS83057	Drive Shaft	45W	38		59.5	34.5	593		
	2001.09-	2004.12	MT	R	F	Estate Engine AKE/BAU/BDH	GDS83058	Drive Shaft	45W	38		59.5	34.5	613		
	2001.09-	2004.12	AT			Estate Engine AKE/BAU/BDH	GC083069	Outer Joint	45W	38	27	59.5	34.5	63	M	
3.0 (160 kW)	2001.04-	2004.12	MT		F	Estate Engine BBJ	GC083067	Outer Joint	45W	38	27	59.5	34	68	M	
	2001.04-	2004.12	MT&AT		F	Estate Engine BBJ	GC083092	Outer Joint	45W	38	27	59.5	34	68	I	
	2001.04-	2004.12	MT/AT		F	Estate Engine BBJ	GCI61044	Inner Joint			34		85			
	2001.04-	2004.12	MT	L	F	Estate Engine BBJ	GDS83352	Drive Shaft	45W	38		59.5	34.5	594		
	2001.04-	2004.12	MT	L	F	Estate Engine BBJ	GDS83057	Drive Shaft	45W	38		59.5	34.5	593		
	2001.04-	2004.12	AT	L/R	F	Estate Engine BBJ	GDS83052	Drive Shaft	45W	38		59.5	34.5	522		
	2001.04-	2004.12	MT	R	F	Estate Engine BBJ	GDS83058	Drive Shaft	45W	38		59.5	34.5	613		
	2001.04-	2004.12	MT			Estate Engine BBJ	GC083069	Outer Joint	45W	38	27	59.5	34.5	63	M	
3.0 (162 kW)	2001.09-	2004.12	MT		F	Estate Engine ASN	GC083067	Outer Joint	45W	38	27	59.5	34	68	M	
	2001.09-	2004.12	MT&AT		F	Estate Engine ASN	GC083092	Outer Joint	45W	38	27	59.5	34	68	I	
	2001.09-	2004.12	MT/AT		F	Estate Engine ASN	GCI61044	Inner Joint			34		85			
	2001.09-	2004.12	MT	L	F	Estate Engine ASN	GDS83352	Drive Shaft	45W	38		59.5	34.5	594		
	2001.09-	2004.12	MT	L	F	Estate Engine ASN	GDS83057	Drive Shaft	45W	38		59.5	34.5	593		
	2001.09-	2004.12	AT	L/R	F	Estate Engine ASN	GDS83052	Drive Shaft	45W	38		59.5	34.5	522		
	2001.09-	2004.12	MT	R	F	Estate Engine ASN	GDS83058	Drive Shaft	45W	38		59.5	34.5	613		
	2001.09-	2004.12	AT			Estate Engine ASN	GC083069	Outer Joint	45W	38	27	59.5	34.5	63	M	
3.0 Quattro (160 kW)	2001.04-	2004.12			F	Estate Engine BBJ	GC083092	Outer Joint	45W	38	27	59.5	34	68	I	
	2001.04-	2004.12	AT		F	Estate Engine BBJ	GCI61044	Inner Joint			34		85			
	2001.04-	2004.12	AT	L/R	F	Estate Engine BBJ	GDS83052	Drive Shaft	45W	38		59.5	34.5	522		
	2001.04-	2004.12	MT			Estate Engine BBJ	GC083069	Outer Joint	45W	38	27	59.5	34.5	63	M	
3.0 Quattro (162 kW)	2001.09-	2004.12	AT		F	Estate Engine ASN/AVK	GCI61044	Inner Joint			34		85			
	2001.09-	2004.12	MT/AT		F	Estate Engine ASN/AVK	GC083092	Outer Joint	45W	38	27	59.5	34	68	I	
	2001.09-	2004.12	AT	L/R	F	Estate Engine ASN/AVK	GDS83052	Drive Shaft	45W	38		59.5	34.5	522		
	2001.09-	2004.12	MT			Estate Engine ASN/AVK	GC083069	Outer Joint	45W	38	27	59.5	34.5	63	M	
4.2 S4 Quattro (253 kW)	2003.03-	2004.12			F	Estate Engine BBK	GC083078	Outer Joint	45W	38	27	59.5	34.5	63	M	
	2003.03-	2004.12			F	Estate Engine BBK	GC083067	Outer Joint	45W	38	27	59.5	34	68	M	
	2003.03-	2004.12	AT	L	F	Estate Engine BBK	GDS83347	Drive Shaft	45W	38		59.5	34.5	580		
	2003.03-	2004.12	AT	L	F	Estate Engine BBK	GCI61076	Inner Joint			34		82			
	2003.03-	2004.12	AT	L	F	Estate Engine BBK	GC083078	Outer Joint	45W	38	27	59.5	34.5	63	M	
	2003.03-	2004.12	MT	L	F	Estate Engine BBK	GDS83352	Drive Shaft	45W	38		59.5	34.5	594		
<b>A4 AVANT (8ED, B7)</b>																
1.6 (75 kW)	2004.11-	2008.06			F	Estate Engine ALZ	GC083058	Outer Joint	45W	38	33	59.5	34	55	M	
	2004.11-	2008.06			F	Estate Engine ALZ	GC083030	Outer Joint		38	33	59.5	34	55	M	
1.8 T (120 kW)	2004.11-	2008.06			F	Estate Engine BFB	GC083067	Outer Joint	45W	38	27	59.5	34	68	M	
	2004.11-	2008.06			F	Estate Engine BFB	GC083092	Outer Joint	45W	38	27	59.5	34	68	I	
	2004.11-	2008.06	AT		F	Estate Engine BFB	GC083078	Outer Joint	45W	38	27	59.5	34.5	63	M	
	2004.11-	2008.06	MT/AT		F	Estate Engine BFB	GCI61044	Inner Joint			34		85			
	2004.11-	2008.06	MT	L	F	Estate Engine BFB	GDS83352	Drive Shaft	45W	38		59.5	34.5	594		
	2004.11-	2008.06	MT	R	F	Estate Engine BFB	GDS83255	Drive Shaft	45W	38		59.5	34.5	621		
	2004.11-	2008.06	AT			Estate Engine BFB	GC083069	Outer Joint	45W	38	27	59.5	34.5	63	M	
1.8 T Quattro (120 kW)	2004.11-	2008.06			F	Estate Engine BFB	GC083030	Outer Joint		38	33	59.5	34	55	M	
	2004.11-	2008.06	AT			Estate Engine BFB	GC083058	Outer Joint	45W	38	33	59.5	34	55	M	
	2004.11-	2008.06			F	Estate Engine BFB	GC083067	Outer Joint	45W	38	27	59.5	34	68	M	
	2004.11-	2008.06	MT/AT		F	Estate Engine BFB	GCI61044	Inner Joint			34		85			
	2004.11-	2008.06		L	F	Estate Engine BFB	GDS83310	Drive Shaft	45W	38		59.5	34	594		
	2004.11-	2008.06		L/R	F	Estate Engine BFB	GCI61070	Inner Joint			24		85			
	2004.11-	2008.06		L/R	F	Estate Engine BFB	GC061075	Outer Joint	45W	38	33	59.5	34	56.5	M	
	2004.11-	2008.06	MT	R	F	Estate Engine BFB	GDS83255	Drive Shaft	45W	38		59.5	34.5	621		
	2004.11-	2008.06		R	F	Estate Engine BFB	GDS83311	Drive Shaft	45W	38		59.5	34	617		
	2004.11-	2008.06	MT			Estate Engine BFB	GC083069	Outer Joint	45W	38	27	59.5	34.5	63	M	
1.9 TDi (85 kW)	2004.11-	2008.06			F	Estate Engine BKE/BRB	GC083078	Outer Joint	45W	38	27	59.5	34.5	63	M	
	2004.11-	2008.06			F	Estate Engine BKE/BRB	GC083067	Outer Joint	45W	38	27	59.5	34	68	M	
	2004.11-	2008.06	MT			Estate Engine BKE/BRB	GCI61044	Inner Joint			34		85			
	2004.11-	2008.06		L	F	Estate Engine BKE/BRB	GDS83352	Drive Shaft	45W	38		59.5	34.5	594		
	2004.11-	2008.06	MT	R	F	Estate Engine BKE/BRB	GDS83255	Drive Shaft	45W	38		59.5	34.5	621		
	2004.11-	2008.06	MT			Estate Engine BKE/BRB	GC083069	Outer Joint	45W	38	27	59.5	34.5	63	M	
2.0 (96 kW)	2004.11-	2008.06			F	Estate Engine ALT	GC083058	Outer Joint	45W	38	33	59.5	34	55	M	
	2004.11-	2008.06			F	Estate Engine ALT	GC083030	Outer Joint		38	33	59.5	34	55	M	





		YEAR	TRANSM	L/R	F/R		G-AP Ref.	PRODUCT	ABS	Technical Specifications								
										A	B	C	H	L	P			
<b>AUDI</b>																		
<b>A4 AVANT (8ED, B7)</b>																		
2.0 (96 kW)	2004.11-	2008.06	MT	L	F	Estate Engine ALT	GDS83310	Drive Shaft	45W	38		59.5	34	594				
	2004.11-	2008.06		L/R	F	Estate Engine ALT	GDS83364	Drive Shaft	45W	38		59.5	34	522				
	2004.11-	2008.06		L/R	F	Estate Engine ALT	GCI61070	Inner Joint			24		85					
	2004.11-	2008.06		L/R	F	Estate Engine ALT	GC061075	Outer Joint	45W	38	33	59.5	34	56.5	M			
	2004.11-	2008.06		R	F	Estate Engine ALT	GDS83311	Drive Shaft	45W	38		59.5	34	617				
	2004.11-	2008.06				Estate Engine ALT	GC083069	Outer Joint	45W	38	27	59.5	34.5	63	M			
2.0 TDi (100 kW)	2007.02-	2007.08			F	Estate Engine BNA/BRF	GC083078	Outer Joint	45W	38	27	59.5	34.5	63	M			
	2007.02-	2007.08			F	Estate Engine BNA/BRF	GC083067	Outer Joint	45W	38	27	59.5	34	68	M			
	2007.02-	2007.08			F	Estate Engine BNA/BRF	GC083092	Outer Joint	45W	38	27	59.5	34	68	I			
	2007.02-	2007.08	MT		F	Estate Engine BNA/BRF	GCI61044	Inner Joint			34		85					
	2007.02-	2007.08	MT	L	F	Estate Engine BNA/BRF	GDS83352	Drive Shaft	45W	38		59.5	34.5	594				
	2007.02-	2007.08		L/R	F	Estate Engine BNA/BRF	GCI61033	Inner Joint			34		85					
	2007.02-	2007.08	MT	R	F	Estate Engine BNA/BRF	GDS83255	Drive Shaft	45W	38		59.5	34.5	621				
	2007.02-	2007.08	MT			Estate Engine BNA/BRF	GC083069	Outer Joint	45W	38	27	59.5	34.5	63	M			
2.0 TDi (103 kW)	2007.02-	2007.08			F	Estate Engine BPW	GC083067	Outer Joint	45W	38	27	59.5	34	68	M			
	2007.02-	2007.08			F	Estate Engine BPW	GC083092	Outer Joint	45W	38	27	59.5	34	68	I			
	2007.02-	2007.08	AT		F	Estate Engine BPW	GC083078	Outer Joint	45W	38	27	59.5	34.5	63	M			
	2007.02-	2007.08	MT		F	Estate Engine BPW	GCI61044	Inner Joint			34		85					
	2007.02-	2007.08	MT	L	F	Estate Engine BPW	GDS83352	Drive Shaft	45W	38		59.5	34.5	594				
	2007.02-	2007.08	MT	R	F	Estate Engine BPW	GDS83255	Drive Shaft	45W	38		59.5	34.5	621				
	2007.02-	2007.08	MT			Estate Engine BPW	GC083069	Outer Joint	45W	38	27	59.5	34.5	63	M			
2.0 TDi (120 kW)	2006.06-	2008.06		L	F	Estate Engine BVA	GDS83352	Drive Shaft	45W	38		59.5	34.5	594				
2.0 TDi (125 kW)	2006.05-	2007.08			F	Estate Engine BRD	GC083078	Outer Joint	45W	38	27	59.5	34.5	63	M			
	2006.05-	2007.08			F	Estate Engine BRD	GC083067	Outer Joint	45W	38	27	59.5	34	68	M			
	2006.05-	2007.08	MT		F	Estate Engine BRD	GCI61044	Inner Joint			34		85					
	2006.05-	2007.08		L	F	Estate Engine BRD	GDS83352	Drive Shaft	45W	38		59.5	34.5	594				
	2006.05-	2007.08	MT	R	F	Estate Engine BRD	GDS83255	Drive Shaft	45W	38		59.5	34.5	621				
	2006.05-	2007.08	MT			Estate Engine BRD	GC083069	Outer Joint	45W	38	27	59.5	34.5	63	M			
2.0 TDi (93 kW)	2005.11-	2006.11		L	F	Estate Engine BVF	GDS83352	Drive Shaft	45W	38		59.5	34.5	594				
	2005.11-	2006.11	MT			Estate Engine BVF	GC083069	Outer Joint	45W	38	27	59.5	34.5	63	M			
2.0 TDi 16V (103 kW)	2004.11-	2008.06			F	Estate Engine BLB/BRE	GC083067	Outer Joint	45W	38	27	59.5	34	68	M			
	2004.11-	2008.06			F	Estate Engine BLB/BRE	GC083092	Outer Joint	45W	38	27	59.5	34	68	I			
	2004.11-	2008.06	AT		F	Estate Engine BLB/BRE	GC083078	Outer Joint	45W	38	27	59.5	34.5	63	M			
	2004.11-	2008.06	MT		F	Estate Engine BLB/BRE	GCI61044	Inner Joint			34		85					
	2004.11-	2008.06	MT	L	F	Estate Engine BLB/BRE	GDS83352	Drive Shaft	45W	38		59.5	34.5	594				
	2004.11-	2008.06		L/R	F	Estate Engine BLB/BRE	GCI61033	Inner Joint			34		85					
	2004.11-	2008.06	MT	R	F	Estate Engine BLB/BRE	GDS83255	Drive Shaft	45W	38		59.5	34.5	621				
	2004.11-	2008.06	MT			Estate Engine BLB/BRE	GC083069	Outer Joint	45W	38	27	59.5	34.5	63	M			
2.0 TDi Quattro (103 kW)	2006.01-	2008.06		R	F	Estate Engine BPW	GDS83311	Drive Shaft	45W	38		59.5	34	617				
	2006.01-	2008.06	AT			Estate Engine BPW	GC083078	Outer Joint	45W	38	27	59.5	34.5	63	M			
	2006.01-	2008.06			F	Estate Engine BPW	GC083067	Outer Joint	45W	38	27	59.5	34	68	M			
	2006.01-	2008.06		L	F	Estate Engine BPW	GDS83310	Drive Shaft	45W	38		59.5	34	594				
	2006.01-	2008.06		L/R	F	Estate Engine BPW	GCI61070	Inner Joint			24		85					
	2006.01-	2008.06		L/R	F	Estate Engine BPW	GC061075	Outer Joint	45W	38	33	59.5	34	56.5	M			
2.0 TDi Quattro (125 kW)	2006.05-	2007.08				Estate Engine BRD	GC083058	Outer Joint	45W	38	33	59.5	34	55	M			
	2006.05-	2007.08				Estate Engine BRD	GC083030	Outer Joint		38	33	59.5	34	55	M			
	2006.05-	2007.08			F	Estate Engine BRD	GC083067	Outer Joint	45W	38	27	59.5	34	68	M			
	2006.05-	2007.08		L	F	Estate Engine BRD	GDS83310	Drive Shaft	45W	38		59.5	34	594				
	2006.05-	2007.08		L/R	F	Estate Engine BRD	GCI61070	Inner Joint			24		85					
	2006.05-	2007.08		L/R	F	Estate Engine BRD	GC061075	Outer Joint	45W	38	33	59.5	34	56.5	M			
	2006.05-	2007.08		R	F	Estate Engine BRD	GDS83311	Drive Shaft	45W	38		59.5	34	617				
	2006.05-	2007.08	MT/AT			Estate Engine BGB/BWE	GCI61044	Inner Joint			34		85					
2.0 TFSi (125 kW)	2006.10-	2008.06			F	Estate Engine BPJ/BYK	GC083078	Outer Joint	45W	38	27	59.5	34.5	63	M			
	2006.10-	2008.06			F	Estate Engine BPJ/BYK	GC083092	Outer Joint	45W	38	27	59.5	34	68	I			
	2006.10-	2008.06		L	F	Estate Engine BPJ/BYK	GDS83352	Drive Shaft	45W	38		59.5	34.5	594				
2.0 TFSi (147 kW)	2004.11-	2008.06			F	Estate Engine BGB/BWE	GC083078	Outer Joint	45W	38	27	59.5	34.5	63	M			
	2004.11-	2008.06			F	Estate Engine BGB/BWE	GC083067	Outer Joint	45W	38	27	59.5	34	68	M			
	2004.11-	2008.06			F	Estate Engine BGB/BWE	GC083092	Outer Joint	45W	38	27	59.5	34	68	I			
	2004.11-	2008.06	MT/AT			Estate Engine BGB/BWE	GCI61044	Inner Joint			34		85					
	2004.11-	2008.06	MT	L	F	Estate Engine BGB/BWE	GDS83352	Drive Shaft	45W	38		59.5	34.5	594				
	2004.11-	2008.06	MT	R	F	Estate Engine BGB/BWE	GDS83255	Drive Shaft	45W	38		59.5	34.5	621				
2.0 TFSi (162 kW)	2007.02-	2007.08			F	Estate Engine BUL	GC083078	Outer Joint	45W	38	27	59.5	34.5	63	M			
	2007.02-	2007.08			F	Estate Engine BUL	GC083067	Outer Joint	45W	38	27	59.5	34	68	M			



		YEAR	TRANSM	L/R	F/R		G-AP Ref.	PRODUCT	ABS	Technical Specifications										
										A	B	C	H	L	P					
<b>AUDI</b>																				
<b>A4 AVANT (8ED, B7)</b>																				
2.0 TFSi (162 kW)	2007.02-	2007.08	MT		F	Estate Engine BUL	GCI61044	Inner Joint			34		85							
	2007.02-	2007.08		L	F	Estate Engine BUL	GDS83352	Drive Shaft	45W	38		59.5	34.5	594						
	2007.02-	2007.08	MT	R	F	Estate Engine BUL	GDS83255	Drive Shaft	45W	38		59.5	34.5	621						
	2007.02-	2007.08	MT			Estate Engine BUL	GC083069	Outer Joint	45W	38	27	59.5	34.5	63	M					
2.0 TFSi Quattro (147 kW)	2004.11-	2008.06				Estate Engine BGB/BWE/BWT	GC083058	Outer Joint	45W	38	33	59.5	34	55	M					
	2004.11-	2008.06				Estate Engine BGB/BWE/BWT	GC083030	Outer Joint		38	33	59.5	34	55	M					
	2004.11-	2008.06			F	Estate Engine BGB/BWE/BWT	GC083067	Outer Joint	45W	38	27	59.5	34	68	M					
	2004.11-	2008.06	MT	L	F	Estate Engine BGB/BWE/BWT	GDS83310	Drive Shaft	45W	38		59.5	34	594						
	2004.11-	2008.06		L/R	F	Estate Engine BGB/BWE/BWT	GCI61070	Inner Joint			24		85							
	2004.11-	2008.06		L/R	F	Estate Engine BGB/BWE/BWT	GC061075	Outer Joint	45W	38	33	59.5	34	56.5	M					
	2004.11-	2008.06		R	F	Estate Engine BGB/BWE/BWT	GDS83311	Drive Shaft	45W	38		59.5	34	617						
	2004.11-	2008.06	AT			Estate Engine BGB/BWE/BWT	GC083069	Outer Joint	45W	38	27	59.5	34.5	63	M					
2.0 TFSi Quattro (162 kW)	2005.12-	2007.08				Estate Engine BUL	GC083058	Outer Joint	45W	38	33	59.5	34	55	M					
	2005.12-	2007.08			F	Estate Engine BUL	GC083067	Outer Joint	45W	38	27	59.5	34	68	M					
	2005.12-	2007.08		L	F	Estate Engine BUL	GDS83310	Drive Shaft	45W	38		59.5	34	594						
	2005.12-	2007.08		L/R	F	Estate Engine BUL	GCI61070	Inner Joint			24		85							
	2005.12-	2007.08		L/R	F	Estate Engine BUL	GC061075	Outer Joint	45W	38	33	59.5	34	56.5	M					
	2005.12-	2007.08		R	F	Estate Engine BUL	GDS83311	Drive Shaft	45W	38		59.5	34	617						
2.5 TDi (120 kW)	2004.11-	2006.05			F	Estate Engine BDG	GC083092	Outer Joint	45W	38	27	59.5	34	68	I					
	2004.11-	2006.05	AT		F	Estate Engine BDG	GC083078	Outer Joint	45W	38	27	59.5	34.5	63	M					
	2004.11-	2006.05	MT		F	Estate Engine BDG	GC083067	Outer Joint	45W	38	27	59.5	34	68	M					
	2004.11-	2006.05	MT	L	F	Estate Engine BDG	GDS83363	Drive Shaft	45W	38		59.5	34.5	611						
	2004.11-	2006.05		L/R	F	Estate Engine BDG	GDS83052	Drive Shaft	45W	38		59.5	34.5	522						
	2004.11-	2006.05				Estate Engine BDG	GC083069	Outer Joint	45W	38	27	59.5	34.5	63	M					
2.7 TDi (120 kW)	2005.11-	2008.03				Estate Engine BSG	GC083069	Outer Joint	45W	38	27	59.5	34.5	63	M					
2.7 TDi (132 kW)	2006.02-	2007.08			F	Estate Engine BPP	GC083058	Outer Joint	45W	38	33	59.5	34	55	M					
	2006.02-	2007.08				Estate Engine BPP	GC083069	Outer Joint	45W	38	27	59.5	34.5	63	M					
3.0 (160 kW)	2004.11-	2006.05			F	Estate Engine BBJ	GC083078	Outer Joint	45W	38	27	59.5	34.5	63	M					
	2004.11-	2006.05			F	Estate Engine BBJ	GC083092	Outer Joint	45W	38	27	59.5	34	68	I					
	2004.11-	2006.05			F	Estate Engine BBJ	GC083067	Outer Joint	45W	38	27	59.5	34	68	M					
	2004.11-	2006.05	MT	L	F	Estate Engine BBJ	GDS83352	Drive Shaft	45W	38		59.5	34.5	594						
	2004.11-	2006.05	MT			Estate Engine BBJ	GC083069	Outer Joint	45W	38	27	59.5	34.5	63	M					
3.0 Quattro (160 kW)	2004.11-	2006.07				Estate Engine BBJ	GC083078	Outer Joint	45W	38	27	59.5	34.5	63	M					
	2004.11-	2006.07			F	Estate Engine BBJ	GC083092	Outer Joint	45W	38	27	59.5	34	68	I					
	2004.11-	2006.07			F	Estate Engine BBJ	GC083067	Outer Joint	45W	38	27	59.5	34	68	M					
3.0 TDi Quattro (150 kW)	2004.11-	2008.06				Estate Engine BKN	GC083078	Outer Joint	45W	38	27	59.5	34.5	63	M					
	2004.11-	2008.06			F	Estate Engine BKN	GC083067	Outer Joint	45W	38	27	59.5	34	68	M					
	2004.11-	2008.06	MT		F	Estate Engine BKN	GCI61044	Inner Joint			34		85							
	2004.11-	2008.06	AT	L	F	Estate Engine BKN	GDS83347	Drive Shaft	45W	38		59.5	34.5	580						
	2004.11-	2008.06	AT	L	F	Estate Engine BKN	GCI61076	Inner Joint			34		82							
	2004.11-	2008.06	AT	L	F	Estate Engine BKN	GC083078	Outer Joint	45W	38	27	59.5	34.5	63	M					
	2004.11-	2008.06	MT	L	F	Estate Engine BKN	GDS83352	Drive Shaft	45W	38		59.5	34.5	594						
	2004.11-	2008.06	MT	R	F	Estate Engine BKN	GDS83255	Drive Shaft	45W	38		59.5	34.5	621						
3.0 TDi Quattro (171 kW)	2007.02-	2007.08				Estate Engine ASB	GC083078	Outer Joint	45W	38	27	59.5	34.5	63	M					
	2007.02-	2007.08			F	Estate Engine ASB	GC083067	Outer Joint	45W	38	27	59.5	34	68	M					
	2007.02-	2007.08	MT		F	Estate Engine ASB	GCI61044	Inner Joint			34		85							
	2007.02-	2007.08	AT	L	F	Estate Engine ASB	GDS83347	Drive Shaft	45W	38		59.5	34.5	580						
	2007.02-	2007.08	AT	L	F	Estate Engine ASB	GCI61076	Inner Joint			34		82							
	2007.02-	2007.08	AT	L	F	Estate Engine ASB	GC083078	Outer Joint	45W	38	27	59.5	34.5	63	M					
	2007.02-	2007.08	MT	L	F	Estate Engine ASB	GDS83352	Drive Shaft	45W	38		59.5	34.5	594						
	2007.02-	2007.08	MT	R	F	Estate Engine ASB	GDS83255	Drive Shaft	45W	38		59.5	34.5	621						
	2007.02-	2007.08				Estate Engine ASB	GC083069	Outer Joint	45W	38	27	59.5	34.5	63	M					
3.2 FSi (188 kW)	2005.01-	2008.06			F	Estate Engine AUK	GC083092	Outer Joint	45W	38	27	59.5	34	68	I					
	2005.01-	2008.06	AT		F	Estate Engine AUK	GC083078	Outer Joint	45W	38	27	59.5	34.5	63	M					
	2005.01-	2008.06	MT		F	Estate Engine AUK	GC083067	Outer Joint	45W	38	27	59.5	34	68	M					
	2005.01-	2008.06				Estate Engine AUK	GC083069	Outer Joint	45W	38	27	59.5	34.5	63	M					
3.2 FSi Quattro (188 kW)	2005.01-	2008.06	AT			Estate Engine AUK	GC083078	Outer Joint	45W	38	27	59.5	34.5	63	M					
	2005.01-	2008.06			F	Estate Engine AUK	GC083092	Outer Joint	45W	38	27	59.5	34	68	I					
	2005.01-	2008.06	AT	L	F	Estate Engine AUK	GDS83347	Drive Shaft	45W	38		59.5	34.5	580						
	2005.01-	2008.06	AT	L	F	Estate Engine AUK	GCI61076	Inner Joint			34		82							
	2005.01-	2008.06	AT	L	F	Estate Engine AUK	GC083078	Outer Joint	45W	38	27	59.5	34.5	63	M					
	2005.01-	2008.06				Estate Engine AUK	GC083069	Outer Joint	45W	38	27	59.5	34.5	63	M					
4.2 RS4 Quattro (309 kW)	2005.09-	2008.06	AT			Estate Engine BNS	GC083078	Outer Joint	45W	38	27	59.5	34.5	63	M					





		TRANSM	L/R	F/R		G-AP Ref.	PRODUCT	ABS	Technical Specifications								
									YEAR	A	B	C	H	L	P		
<b>AUDI</b>																	
<b>A4 AVANT (8ED, B7)</b>																	
4.2 RS4 Quattro (309 kW)	2005.09-2008.06			F	Estate Engine BNS	GC083067	Outer Joint	45W	38	27	59.5	34	68	M			
	2005.09-2008.06		L	F	Estate Engine BNS	GDS83352	Drive Shaft	45W	38		59.5	34.5	594				
	2005.09-2008.06	MT			Estate Engine BNS	GC083069	Outer Joint	45W	38	27	59.5	34.5	63	M			
4.2 S4 Quattro (253 kW)	2007.02-2007.08				Estate Engine BBK	GC083078	Outer Joint	45W	38	27	59.5	34.5	63	M			
	2007.02-2007.08			F	Estate Engine BBK	GC083067	Outer Joint	45W	38	27	59.5	34	68	M			
	2007.02-2007.08	MT		F	Estate Engine BBK	GCI61044	Inner Joint			34		85					
	2007.02-2007.08	AT	L	F	Estate Engine BBK	GDS83347	Drive Shaft	45W	38		59.5	34.5	580				
	2007.02-2007.08	AT	L	F	Estate Engine BBK	GCI61076	Inner Joint			34		82					
	2007.02-2007.08	AT	L	F	Estate Engine BBK	GC083078	Outer Joint	45W	38	27	59.5	34.5	63	M			
	2007.02-2007.08	MT	L	F	Estate Engine BBK	GDS83352	Drive Shaft	45W	38		59.5	34.5	594				
	2007.02-2007.08	MT	R	F	Estate Engine BBK	GDS83255	Drive Shaft	45W	38		59.5	34.5	621				
	2007.02-2007.08	AT			Estate Engine BBK	GC083069	Outer Joint	45W	38	27	59.5	34.5	63	M			
<b>A4 AVANT (8K5, B8)</b>																	
1.8 TFSi (118 kW)	2007.11-		MT/AT		F	Estate Engine CABB/CDHB	GC083086	Outer Joint		42	33	76.5	34	45.5	M		
	2007.11-		6MT/CVT	L/R	F	Estate Engine CABB/CDHB	GC083087	Outer Joint		42	27	76.5	34	54.5	M		
	2007.11-		6MT/CTV	L/R	F	Estate Engine CABB/CDHB	GDS83273	Drive Shaft		42		76.5	34	460			
	2007.11-		6MT/CTV	L/R	F	Estate Engine CABB/CDHB	GCI83022	Inner Joint			34		88				
	2007.11-			L/R	F	Estate Engine CABB/CDHB	GDS83291	Drive Shaft		42		76.4	34	464			
	2007.11-					Estate Engine CABB/CDHB	GC083103	Outer Joint		42	28	76.4	34	54	I		
1.8 TFSi (125 kW)	2011.11-		MT/AT	L/R	F	Estate Engine CJEB	GDS83291	Drive Shaft		42		76.4	34	464			
	2011.11-					Estate Engine CJEB	GC083103	Outer Joint		42	28	76.4	34	54	I		
1.8 TFSi (88 kW)	2008.04-		6MT/CVT	L/R	F	Estate Engine CDHA	GC083087	Outer Joint		42	27	76.5	34	54.5	M		
	2008.04-		6MT/CTV	L/R	F	Estate Engine CDHA	GDS83273	Drive Shaft		42		76.5	34	460			
	2008.04-		6MT/CTV	L/R	F	Estate Engine CDHA	GCI83022	Inner Joint			34		88				
	2008.04-		MT/AT	L/R	F	Estate Engine CDHA	GDS83291	Drive Shaft		42		76.4	34	464			
	2008.04-		MT/AT			Estate Engine CDHA	GC083103	Outer Joint		42	28	76.4	34	54	I		
1.8 TFSi Quattro (118 kW)	2008.09-		MT/AT		F	Estate Engine CDHB	GC083086	Outer Joint		42	33	76.5	34	45.5	M		
	2008.09-		6MT/6AT/7AT	L/R	F	Estate Engine CDHB	GDS83345	Drive Shaft		42		76.5	34	463			
	2008.09-		6MT/6AT/7AT	L/R	F	Estate Engine CDHB	GCI83029	Inner Joint			24		88.5				
	2008.09-		6MT/6AT/7AT	L/R	F	Estate Engine CDHB	GC083086	Outer Joint		42	33	76.5	34	45.5	M		
	2008.09-		6MT/CTV	L/R	F	Estate Engine CDHB	GDS83273	Drive Shaft		42		76.5	34	460			
	2008.09-		6MT/CTV	L/R	F	Estate Engine CDHB	GCI83022	Inner Joint			34		88				
1.8 TFSi Quattro (125 kW)	2011.11-		MT/AT		F	Estate Engine CJEB	GDS83291	Drive Shaft		42		76.4	34	464			
	2011.11-					Estate Engine CJEB	GC083103	Outer Joint		42	28	76.4	34	54	I		
2.0 TDi (100 kW)	2008.04-		6MT		F	Estate Engine CJCB/CAGB	GC083087	Outer Joint		42	27	76.5	34	54.5	M		
	2008.04-			L/R	F	Estate Engine CJCB/CAGB	GC083087	Outer Joint		42	27	76.5	34	54.5	M		
	2008.04-		6MT	L/R	F	Estate Engine CJCB/CAGB	GC083109	Outer Joint		42	27	76.5	34	54.5	M		
	2008.04-		6MT/CTV	L/R	F	Estate Engine CJCB/CAGB	GDS83273	Drive Shaft		42		76.5	34	460			
	2008.04-		6MT/CTV	L/R	F	Estate Engine CJCB/CAGB	GCI83022	Inner Joint			34		88				
	2008.04-		MT	L/R	F	Estate Engine CJCB/CAGB	GDS83291	Drive Shaft		42		76.4	34	464			
	2008.04-																
2.0 TDi (105 kW)	2008.04-		6MT		F	Estate Engine CAGA/CJCA/CMEA/CMFA	GC083087	Outer Joint		42	27	76.5	34	54.5	M		
	2008.04-		MT/AT		F	Estate Engine CAGA/CJCA/CMEA/CMFA	GC083086	Outer Joint		42	33	76.5	34	45.5	M		
	2008.04-			L/R	F	Estate Engine CAGA/CJCA/CMEA/CMFA	GC083087	Outer Joint		42	27	76.5	34	54.5	M		
	2008.04-		6MT	L/R	F	Estate Engine CAGA/CJCA/CMEA/CMFA	GC083109	Outer Joint		42	27	76.5	34	54.5	M		
	2008.04-		6MT/CTV	L/R	F	Estate Engine CAGA/CJCA/CMEA/CMFA	GDS83273	Drive Shaft		42		76.5	34	460			
	2008.04-		6MT/CTV	L/R	F	Estate Engine CAGA/CJCA/CMEA/CMFA	GCI83022	Inner Joint			34		88				
	2008.04-		MT	L/R	F	Estate Engine CAGA/CJCA/CMEA/CMFA	GDS83291	Drive Shaft		42		76.4	34	464			
	2008.04-					Estate Engine CAGA/CJCA/CMEA/CMFA	GC083103	Outer Joint		42	28	76.4	34	54	I		
2.0 TDi (110 kW)	2013.05-		MT/AT	L/R		Estate Engine CJCD/CMFB/CSUA	GDS83291	Drive Shaft		42		76.4	34	464			
	2013.05-					Estate Engine CJCD/CMFB/CSUA	GC083103	Outer Joint		42	28	76.4	34	54	I		
2.0 TDi (120 kW)	2008.08-		6MT		F	Estate Engine CAHB/CGLD	GC083087	Outer Joint		42	27	76.5	34	54.5	M		
	2008.08-			L/R	F	Estate Engine CAHB/CGLD	GC083087	Outer Joint		42	27	76.5	34	54.5	M		
	2008.08-		6MT	L/R	F	Estate Engine CAHB/CGLD	GC083109	Outer Joint		42	27	76.5	34	54.5	M		
	2008.08-		6MT/CTV	L/R	F	Estate Engine CAHB/CGLD	GDS83273	Drive Shaft		42		76.5	34	460			
	2008.08-		6MT/CTV	L/R	F	Estate Engine CAHB/CGLD	GCI83022	Inner Joint			34		88				
	2008.08-			L/R	F	Estate Engine CAHB/CGLD	GDS83291	Drive Shaft		42		76.4	34	464			
	2008.08-					Estate Engine CAHB/CGLD	GC083103	Outer Joint		42	28	76.4	34	54	I		
2.0 TDi (125 kW)	2008.04-		6MT		F	Estate Engine CAHA	GC083087	Outer Joint		42	27	76.5	34	54.5	M		
	2008.04-		MT/AT		F	Estate Engine CAHA	GC083086	Outer Joint		42	33	76.5	34	45.5	M		
	2008.04-			L/R	F	Estate Engine CAHA	GC083087	Outer Joint		42	27	76.5	34	54.5	M		
	2008.04-		6MT	L/R	F	Estate Engine CAHA	GC083109	Outer Joint		42	27	76.5	34	54.5	M		
	2008.04-		6MT/CTV	L/R	F	Estate Engine CAHA	GDS83273	Drive Shaft		42		76.5	34	460			









	 YEAR	TRANSM	L/R	F/R		G-AP Ref.	PRODUCT	ABS	Technical Specifications											
									A	B	C	H	L	P						
<b>AUDI</b>																				
<b>A4 AVANT (8K5, B8)</b>																				
2.0 TDi (125 kW)	2008.04-		6MT/CTV	L/R	F	Estate Engine CAHA	GCI83022	Inner Joint		34		88								
	2008.04-		MT	L/R	F	Estate Engine CAHA	GDS83291	Drive Shaft	42		76.4	34	464							
	2008.04-					Estate Engine CAHA	GC083103	Outer Joint	42	28	76.4	34	54	I						
2.0 TDi (130 kW)	2011.11-		MT/AT	L/R	F	Estate Engine CGLC	GDS83337	Drive Shaft	42		76.5	34	461							
	2011.11-					Estate Engine CGLC	GC083102	Outer Joint	42	29	76.5	34	60	I						
2.0 TDi (140 kW)	2013.09-		AT		F	Estate Engine CNHA	GDS83337	Drive Shaft	42		76.5	34	461							
	2013.09-		AT			Estate Engine CNHA	GC083102	Outer Joint	42	29	76.5	34	60	I						
2.0 TDi (88 kW)	2008.06-		6MT		F	Estate Engine CAGC/CJCC	GC083087	Outer Joint	42	27	76.5	34	54.5	M						
	2008.06-			L/R	F	Estate Engine CAGC/CJCC	GC083087	Outer Joint	42	27	76.5	34	54.5	M						
	2008.06-		6MT	L/R	F	Estate Engine CAGC/CJCC	GC083109	Outer Joint	42	27	76.5	34	54.5	M						
	2008.06-		6MT/CTV	L/R	F	Estate Engine CAGC/CJCC	GDS83273	Drive Shaft	42		76.5	34	460							
	2008.06-		6MT/CTV	L/R	F	Estate Engine CAGC/CJCC	GCI83022	Inner Joint		34		88								
	2008.06-		MT	L/R	F	Estate Engine CAGC/CJCC	GDS83291	Drive Shaft	42		76.4	34	464							
	2008.06-						Estate Engine CAGC/CJCC	GC083103	Outer Joint	42	28	76.4	34	54	I					
2.0 TDi Quattro (105 kW)	2008.04-		MT/AT		F	Estate Engine CAGA/CJCA	GC083086	Outer Joint	42	33	76.5	34	45.5	M						
	2008.04-		6MT/6AT/7AT	L/R	F	Estate Engine CAGA/CJCA	GDS83345	Drive Shaft	42		76.5	34	463							
	2008.04-		6MT/6AT/7AT	L/R	F	Estate Engine CAGA/CJCA	GCI83029	Inner Joint		24		88.5								
	2008.04-		6MT/6AT/7AT	L/R	F	Estate Engine CAGA/CJCA	GC083086	Outer Joint	42	33	76.5	34	45.5	M						
	2008.04-					Estate Engine CAGA/CJCA	GC083107	Outer Joint	42	25	76.5	34	47.5	I						
2.0 TDi Quattro (125 kW)	2008.08-		MT/AT		F	Estate Engine CAHA	GC083086	Outer Joint	42	33	76.5	34	45.5	M						
	2008.08-		6MT/6AT/7AT	L/R	F	Estate Engine CAHA	GDS83345	Drive Shaft	42		76.5	34	463							
	2008.08-		6MT/6AT/7AT	L/R	F	Estate Engine CAHA	GCI83029	Inner Joint		24		88.5								
	2008.08-		6MT/6AT/7AT	L/R	F	Estate Engine CAHA	GC083086	Outer Joint	42	33	76.5	34	45.5	M						
	2008.08-					Estate Engine CAHA	GC083107	Outer Joint	42	25	76.5	34	47.5	I						
2.0 TDi Quattro (130 kW)	2011.11-		MT			Estate Engine CGLC	GC083107	Outer Joint	42	25	76.5	34	47.5	I						
2.0 TFSi (132 kW)	2008.06-		6MT		F	Estate Engine CDN/CFKA	GC083087	Outer Joint	42	27	76.5	34	54.5	M						
	2008.06-			L/R	F	Estate Engine CDN/CFKA	GC083087	Outer Joint	42	27	76.5	34	54.5	M						
	2008.06-		6MT	L/R	F	Estate Engine CDN/CFKA	GC083109	Outer Joint	42	27	76.5	34	54.5	M						
	2008.06-		6MT/CTV	L/R	F	Estate Engine CDN/CFKA	GDS83273	Drive Shaft	42		76.5	34	460							
	2008.06-		6MT/CTV	L/R	F	Estate Engine CDN/CFKA	GCI83022	Inner Joint		34		88								
	2008.06-			L/R	F	Estate Engine CDN/CFKA	GDS83291	Drive Shaft	42		76.4	34	464							
	2008.06-						Estate Engine CDN/CFKA	GC083103	Outer Joint	42	28	76.4	34	54	I					
2.0 TFSi (155 kW)	2008.06-		6MT		F	Estate Engine CAEB/CDNC	GC083087	Outer Joint	42	27	76.5	34	54.5	M						
	2008.06-		MT/AT		F	Estate Engine CAEB/CDNC	GC083086	Outer Joint	42	33	76.5	34	45.5	M						
	2008.06-			L/R	F	Estate Engine CAEB/CDNC	GC083087	Outer Joint	42	27	76.5	34	54.5	M						
	2008.06-		6MT	L/R	F	Estate Engine CAEB/CDNC	GC083109	Outer Joint	42	27	76.5	34	54.5	M						
	2008.06-		6MT/CTV	L/R	F	Estate Engine CAEB/CDNC	GDS83273	Drive Shaft	42		76.5	34	460							
	2008.06-		6MT/CTV	L/R	F	Estate Engine CAEB/CDNC	GCI83022	Inner Joint		34		88								
	2008.06-		MT/AT	L/R	F	Estate Engine CAEB/CDNC	GDS83291	Drive Shaft	42		76.4	34	464							
	2008.06-						Estate Engine CAEB/CDNC	GC083103	Outer Joint	42	28	76.4	34	54	I					
2.0 TFSi (165 kW)	2013.05-		MT/AT	L/R	F	Estate Engine CNCD	GDS83291	Drive Shaft	42		76.4	34	464							
	2013.05-					Estate Engine CNCD	GC083103	Outer Joint	42	28	76.4	34	54	I						
2.0 TFSi FlexFuel (132 kW)	2009.11-				F	Estate Engine CFKA	GC083087	Outer Joint	42	27	76.5	34	54.5	M						
	2009.11-			L/R	F	Estate Engine CFKA	GC083087	Outer Joint	42	27	76.5	34	54.5	M						
	2009.11-			L/R	F	Estate Engine CFKA	GDS83273	Drive Shaft	42		76.5	34	460							
	2009.11-			L/R	F	Estate Engine CFKA	GCI83022	Inner Joint		34		88								
2.0 TFSi FlexFuel Quattro (132 kW)	2009.11-				F	Estate Engine CFKA	GC083086	Outer Joint	42	33	76.5	34	45.5	M						
	2009.11-			L/R	F	Estate Engine CFKA	GDS83345	Drive Shaft	42		76.5	34	463							
	2009.11-			L/R	F	Estate Engine CFKA	GCI83029	Inner Joint		24		88.5								
	2009.11-			L/R	F	Estate Engine CFKA	GC083086	Outer Joint	42	33	76.5	34	45.5	M						
	2009.11-			L/R	F	Estate Engine CFKA	GC083086	Outer Joint	42	33	76.5	34	45.5	M						
2.0 TFSi Quattro (155 kW)	2008.06-				F	Estate Engine CDNC/CAEB	GC083020	Outer Joint	45W	38	30	59.5	34	59.5	I					
	2008.06-		MT/AT		F	Estate Engine CDNC/CAEB	GC083086	Outer Joint	42	33	76.5	34	45.5	M						
	2008.06-			R		Estate Engine CDNC/CAEB	GC083026	Outer Joint	45T	33	30	53	31	62	I					
	2008.06-		6MT/6AT/7AT	L/R	F	Estate Engine CDNC/CAEB	GDS83345	Drive Shaft	42		76.5	34	463							
	2008.06-		6MT/6AT/7AT	L/R	F	Estate Engine CDNC/CAEB	GCI83029	Inner Joint		24		88.5								
	2008.06-		6MT/6AT/7AT	L/R	F	Estate Engine CDNC/CAEB	GC083086	Outer Joint	42	33	76.5	34	45.5	M						
	2008.06-						Estate Engine CDNC/CAEB	GC083049	Outer Joint	38	30	59.5	34	59.5	I					
	2008.06-						Estate Engine CDNC/CAEB	GC083026	Outer Joint	45T	33	30	53	31	62	I				
2.0 TFSi Quattro (165 kW)	2013.05-		MT/AT	L/R	F	Estate Engine CNCD	GDS83291	Drive Shaft	42		76.4	34	464							
	2013.05-					Estate Engine CNCD	GC083103	Outer Joint	42	28	76.4	34	54	I						
2.7 TDi (120 kW)	2008.06-		6MT		F	Estate Engine CGKB/CAMB	GC083088	Outer Joint	42	29	76.5	34	61.5	M						
	2008.06-		6MT	L/R	F	Estate Engine CGKB/CAMB	GDS83321	Drive Shaft	42		76.5	34	462							
	2008.06-		6MT	L/R	F	Estate Engine CGKB/CAMB	GCI83022	Inner Joint		34		88								
	2008.06-		MT		F	Estate Engine CGKB/CAMB	GDS83337	Drive Shaft	42		76.5	34	461							



		TRANSM	L/R	F/R		G-AP Ref.	PRODUCT	ABS	Technical Specifications									
									YEAR	A	B	C	H	L	P			
<b>AUDI</b>																		
<b>A4 AVANT (8K5, B8)</b>																		
2.7 TDi (120 kW)	2008.06-				Estate Engine CGKB/CAMB	GC083102	Outer Joint		42	29	76.5	34	60	I				
2.7 TDi (140 kW)	2008.04-		6MT		F Estate Engine CAMA/CGKA	GC083088	Outer Joint		42	29	76.5	34	61.5	M				
	2008.04-		6MT	L/R	F Estate Engine CAMA/CGKA	GDS83321	Drive Shaft		42		76.5	34	462					
	2008.04-		6MT	L/R	F Estate Engine CAMA/CGKA	GCI83022	Inner Joint			34		88						
	2008.04-		MT		F Estate Engine CAMA/CGKA	GDS83337	Drive Shaft		42		76.5	34	461					
	2008.04-				Estate Engine CAMA/CGKA	GC083102	Outer Joint		42	29	76.5	34	60	I				
3.0 S4 Quattro (245 kW)	2008.11-			L/R	Estate Engine CAKA/CGWC	GC083087	Outer Joint		42	27	76.5	34	54.5	M				
	2008.11-				F Estate Engine CAKA/CGWC	GC083086	Outer Joint		42	33	76.5	34	45.5	M				
	2008.11-				R Estate Engine CAKA/CGWC	GC083088	Outer Joint		42	29	76.5	34	61.5	M				
	2008.11-			L/R	F Estate Engine CAKA/CGWC	GDS83273	Drive Shaft		42		76.5	34	460					
	2008.11-			L/R	F Estate Engine CAKA/CGWC	GCI83022	Inner Joint			34		88						
	2008.11-		MT/AT		F Estate Engine CAKA/CGWC	GDS83291	Drive Shaft		42		76.4	34	464					
	2008.11-				Estate Engine CAKA/CGWC	GC083103	Outer Joint		42	28	76.4	34	54	I				
3.0 TDi (150 kW)	2011.11-		MT		F Estate Engine CLAB	GDS83337	Drive Shaft		42		76.5	34	461					
	2011.11-				Estate Engine CLAB	GC083102	Outer Joint		42	29	76.5	34	60	I				
3.0 TDi Quattro (176 kW)	2008.04-		6MT/6AT/7AT	L/R	Estate Engine CAPA/CCLA/CCWA	GC083087	Outer Joint		42	27	76.5	34	54.5	M				
	2008.04-			L/R	F Estate Engine CAPA/CCLA/CCWA	GDS83273	Drive Shaft		42		76.5	34	460					
	2008.04-			L/R	F Estate Engine CAPA/CCLA/CCWA	GCI83022	Inner Joint			34		88						
	2008.04-		MT/AT		F Estate Engine CAPA/CCLA/CCWA	GDS83291	Drive Shaft		42		76.4	34	464					
	2008.04-				Estate Engine CAPA/CCLA/CCWA	GC083103	Outer Joint		42	28	76.4	34	54	I				
3.0 TDi Quattro (180 kW)	2011.11-		AT		F Estate Engine CDUC/CKVB/CKVC	GDS83291	Drive Shaft		42		76.4	34	464					
	2011.11-		AT		Estate Engine CDUC/CKVB/CKVC	GC083103	Outer Joint		42	28	76.4	34	54	I				
3.0 TFSi Quattro (200 kW)	2012.02-		AT		F Estate Engine CMUA	GDS83291	Drive Shaft		42		76.4	34	464					
	2012.02-				Estate Engine CMUA	GC083103	Outer Joint		42	28	76.4	34	54	I				
3.2 FSi (195 kW)	2008.09-				F Estate Engine CALA	GC083087	Outer Joint		42	27	76.5	34	54.5	M				
	2008.09-		MT/AT		F Estate Engine CALA	GC083086	Outer Joint		42	33	76.5	34	45.5	M				
	2008.09-			L/R	F Estate Engine CALA	GC083087	Outer Joint		42	27	76.5	34	54.5	M				
	2008.09-		6MT/CTV	L/R	F Estate Engine CALA	GDS83273	Drive Shaft		42		76.5	34	460					
	2008.09-		6MT/CTV	L/R	F Estate Engine CALA	GCI83022	Inner Joint			34		88						
	2008.09-		MT/AT	L/R	F Estate Engine CALA	GDS83291	Drive Shaft		42		76.4	34	464					
	2008.09-		MT/AT		Estate Engine CALA	GC083103	Outer Joint		42	28	76.4	34	54	I				
3.2 FSi Quattro (195 kW)	2008.04-		MT/AT		F Estate Engine CALA	GC083086	Outer Joint		42	33	76.5	34	45.5	M				
	2008.04-		6MT/6AT/7AT	L/R	F Estate Engine CALA	GDS83345	Drive Shaft		42		76.5	34	463					
	2008.04-		6MT/6AT/7AT	L/R	F Estate Engine CALA	GCI83029	Inner Joint			24		88.5						
	2008.04-		6MT/6AT/7AT	L/R	F Estate Engine CALA	GC083086	Outer Joint		42	33	76.5	34	45.5	M				
4.2 RS4 Quattro (331 kW)	2012.05-		MT/AT	L/R	F Estate Engine CFSA	GDS83291	Drive Shaft		42		76.4	34	464					
	2012.05-		MT/AT		Estate Engine CFSA	GC083103	Outer Joint		42	28	76.4	34	54	I				
<b>A4 II (8E2, 8E5, B6), AVANT</b>																		
1.6 (75 kW)	2000.11-	2004.12				GC083078	Outer Joint	45W	38	27	59.5	34.5	63	M				
1.8 T (120 kW)	2002.11-	2004.12			Ch-8E1014313-8E1026955	GC083078	Outer Joint	45W	38	27	59.5	34.5	63	M				
1.8 T (140 kW)	2002.11-	2004.12			Ch-8E1014313-8E1026955	GC083078	Outer Joint	45W	38	27	59.5	34.5	63	M				
1.8 T Quattro (120 kW)	2002.08-	2004.10				GC083078	Outer Joint	45W	38	27	59.5	34.5	63	M				
1.8 T Quattro (140 kW)	2002.08-	2004.10				GC083078	Outer Joint	45W	38	27	59.5	34.5	63	M				
1.9 TDi (74 kW)	2001.05-	2004.12			Ch-8E4000001/8E4195501	GC083078	Outer Joint	45W	38	27	59.5	34.5	63	M				
1.9 TDi (85 kW)	2001.05-	2004.12			Ch-8E4000001/8E4195501	GC083078	Outer Joint	45W	38	27	59.5	34.5	63	M				
1.9 TDi (96 kW)	2001.05-	2004.12			Ch-8E4000001/8E4195501	GC083078	Outer Joint	45W	38	27	59.5	34.5	63	M				
2.0 FSi (110 kW)	2002.07-	2004.12				GC083078	Outer Joint	45W	38	27	59.5	34.5	63	M				
2.5 TDi (114 kW)	2002.07-	2004.12			Engine BCZBDG	GC083078	Outer Joint	45W	38	27	59.5	34.5	63	M				
2.5 TDi (120 kW)	2002.07-	2004.12			Engine BCZBDG	GC083078	Outer Joint	45W	38	27	59.5	34.5	63	M				
2.5 TDi Quattro (132 kW)	2000.11-	2004.12	AT			GC083078	Outer Joint	45W	38	27	59.5	34.5	63	M				
3.0 Quattro (160 kW)	2000.11-	2004.12			Ch-8E4350001	GC083078	Outer Joint	45W	38	27	59.5	34.5	63	M				
4.1 S4 Quattro (253 kW)	2003.03-	2004.12				GC083078	Outer Joint	45W	38	27	59.5	34.5	63	M				
<b>A4 II (8H7), CABRIO</b>																		
2.0 TDi (100 kW)	2006-		MT/AT			GC083078	Outer Joint	45W	38	27	59.5	34.5	63	M				
2.0 TDi (103 kW)	2006-		MT/AT			GC083078	Outer Joint	45W	38	27	59.5	34.5	63	M				
2.0 TFSi (147 kW)	2006-					GC083078	Outer Joint	45W	38	27	59.5	34.5	63	M				
2.5 TDi (120 kW)	2002-	2004			Engine BCZBDG	GC083078	Outer Joint	45W	38	27	59.5	34.5	63	M				
2.7 TDi (132 kW)	2006-					GC083078	Outer Joint	45W	38	27	59.5	34.5	63	M				
3.0 TDi Quattro (150 kW)	2004-		MT			GC083078	Outer Joint	45W	38	27	59.5	34.5	63	M				
3.0 TDi Quattro (171 kW)	2004-		MT			GC083078	Outer Joint	45W	38	27	59.5	34.5	63	M				
3.2 FSi Quattro (188 kW)	2005-					GC083078	Outer Joint	45W	38	27	59.5	34.5	63	M				
4.1 S4 Quattro (253 kW)	2004-					GC083078	Outer Joint	45W	38	27	59.5	34.5	63	M				

		TRANSM	L/R	F/R		G-AP Ref.	PRODUCT	ABS	Technical Specifications					
									YEAR	A	B	C	H	L
<b>AUDI</b>														
<b>A4 III (8EC, SED, B7), AVANT</b>														
1.6 (75 kW)	2004.11-	2008.06				GC083078	Outer Joint	45W	38	27	59.5	34.5	63	M
2.0 FSi (125 kW)	2006.10-	2008.06	AT			GC083078	Outer Joint	45W	38	27	59.5	34.5	63	M
2.0 TDi 16V (103 kW)	2004.11-	2008.06	AT			GC083078	Outer Joint	45W	38	27	59.5	34.5	63	M
2.0 TDi Quattro (103 kW)	2006.01-	2008.06	AT			GC083078	Outer Joint	45W	38	27	59.5	34.5	63	M
2.0 TDi Quattro (125 kW)	2006.01-	2008.06	AT			GC083078	Outer Joint	45W	38	27	59.5	34.5	63	M
2.7 TDi (120 kW)	2005.11-	2008.06				GC083078	Outer Joint	45W	38	27	59.5	34.5	63	M
2.7 TDi (132 kW)	2005.11-	2008.06				GC083078	Outer Joint	45W	38	27	59.5	34.5	63	M
3.0 Quattro (160 kW)	2004.11-	2008.07	AT			GC083078	Outer Joint	45W	38	27	59.5	34.5	63	M
	2004.11-	2008.07	MT		Ch-8E6805000	GC083078	Outer Joint	45W	38	27	59.5	34.5	63	M
3.2 FSi (188 kW)	2005.01-	2008.06				GC083078	Outer Joint	45W	38	27	59.5	34.5	63	M
3.2 FSi Quattro (188 kW)	2005.01-	2008.06	AT			GC083078	Outer Joint	45W	38	27	59.5	34.5	63	M
RS4 Quattro (309 kW)	2005.09-	2008.06	MT			GC083078	Outer Joint	45W	38	27	59.5	34.5	63	M
<b>A4 IV (8K2, 8K5), AVANT</b>														
1.8 TFSi (118 kW)	2007.11-	2012.01				GCI83022	Inner Joint				34		88	
1.8 TFSi (125 kW)	2007.11-	2012.01				GCI83022	Inner Joint				34		88	
1.8 TFSi (88 kW)	2007.11-	2012.01				GCI83022	Inner Joint				34		88	
2.0 TDi (100 kW)	2012.01-					GCI83022	Inner Joint				34		88	
2.0 TDi (105 kW)	2007.11-	2012.01				GCI83022	Inner Joint				34		88	
	2007.11-	2012.01				GC083087	Outer Joint	42	27	76.5	34	54.5	M	
2.0 TDi (120 kW)	2007.11-	2012.01				GCI83022	Inner Joint				34		88	
	2007.11-	2012.01				GC083087	Outer Joint	42	27	76.5	34	54.5	M	
2.0 TDi (125 kW)	2007.11-	2012.01				GCI83022	Inner Joint				34		88	
	2007.11-	2012.01				GC083087	Outer Joint	42	27	76.5	34	54.5	M	
2.0 TDi (130 kW)	2012.01-					GCI83022	Inner Joint				34		88	
2.0 TDi (88 kW)	2007.11-	2012.01				GCI83022	Inner Joint				34		88	
	2007.11-	2012.01				GC083087	Outer Joint	42	27	76.5	34	54.5	M	
2.0 TFSi (132 kW)	2008.06-	2012.01				GCI83022	Inner Joint				34		88	
2.0 TFSi Flexible Fuel Quattro (132 kW)	2009.11-					GC083087	Outer Joint	42	27	76.5	34	54.5	M	
2.0 TFSi Quattro (132 kW)	2008.06-	2012.01				GC083087	Outer Joint	42	27	76.5	34	54.5	M	
	2012.01-					GCI83022	Inner Joint				34		88	
2.0 TFSi Quattro (155 kW)	2008.06-	2012.01				GC083087	Outer Joint	42	27	76.5	34	54.5	M	
	2012.01-					GCI83022	Inner Joint				34		88	
2.7 TDi (120 kW)	2007.11-	2012.01	MT/AT			GCI83022	Inner Joint				34		88	
2.7 TDi (140 kW)	2007.11-	2012.01	MT/AT			GCI83022	Inner Joint				34		88	
3.0 TDi (176 kW)	2011.11-					GCI83022	Inner Joint				34		88	
3.0 TDi Quattro (150 kW)	2011.11-					GCI83022	Inner Joint				34		88	
3.0 TDi Quattro (155 kW)	2008.06-					GCI83022	Inner Joint				34		88	
3.0 TDi Quattro (176 kW)	2008.06-					GCI83022	Inner Joint				34		88	
3.0 TDi Quattro (180 kW)	2011.11-	2012.01				GCI83022	Inner Joint				34		88	
3.0 TFSi Quattro (200 kW)	2012.02-					GCI83022	Inner Joint				34		88	
3.0 TFSi Quattro (245 kW)	2012.02-					GCI83022	Inner Joint				34		88	
3.2 FSi (195 kW)	2008.09-					GC083087	Outer Joint	42	27	76.5	34	54.5	M	
S4 Quattro (245 kW)	2009.05-	2012.01				GCI83022	Inner Joint				34		88	
<b>A4 IV (8KH), ALLROAD</b>														
3.0 TDi Quattro (176 kW)	2009.09-	2012.01				GCI83022	Inner Joint				34		88	
3.0 TDi Quattro (180 kW)	2009.09-	2012.01				GCI83022	Inner Joint				34		88	
<b>A5 (8F7)</b>														
1.8 TFSi (118 kW)	2009.09-			L/R	F	Convertible Engine CDHB	GC083087	Outer Joint	42	27	76.5	34	54.5	M
	2009.09-		6MT/CTV	L/R	F	Convertible Engine CDHB	GDS83273	Drive Shaft	42		76.5	34	460	
	2009.09-		6MT/CTV	L/R	F	Convertible Engine CDHB	GCI83022	Inner Joint			34		88	
	2009.09-		AT		F	Convertible Engine CDHB	GDS83291	Drive Shaft	42		76.4	34	464	
	2009.09-					Convertible Engine CDHB	GC083103	Outer Joint	42	28	76.4	34	54	I
1.8 TFSi (125 kW)	2011.10-			L/R	F	Convertible Engine CABD/CJEB	GDS83291	Drive Shaft	42		76.4	34	464	
	2011.10-					Convertible Engine CABD/CJEB	GC083103	Outer Joint	42	28	76.4	34	54	I
2.0 TDi (105 kW)	2011.10-			L/R	F	Convertible Engine CJCA	GDS83291	Drive Shaft	42		76.4	34	464	
	2011.10-					Convertible Engine CJCA	GC083103	Outer Joint	42	28	76.4	34	54	I
2.0 TDi (110 kW)	2013.05-				F	Convertible Engine CJCD	GDS83291	Drive Shaft	42		76.4	34	464	
	2013.05-					Convertible Engine CJCD	GC083103	Outer Joint	42	28	76.4	34	54	I
2.0 TDi (125 kW)	2009.05-		6MT/CVT	L/R	F	Convertible Engine CAHA	GC083087	Outer Joint	42	27	76.5	34	54.5	M
	2009.05-		6MT/CTV	L/R	F	Convertible Engine CAHA	GDS83273	Drive Shaft	42		76.5	34	460	
	2009.05-		6MT/CTV	L/R	F	Convertible Engine CAHA	GCI83022	Inner Joint			34		88	
	2009.05-		MT		F	Convertible Engine CAHA	GDS83291	Drive Shaft	42		76.4	34	464	









		TRANSM	L/R	F/R		G-AP Ref.	PRODUCT	ABS	Technical Specifications									
									YEAR	A	B	C	H	L	P			
<b>AUDI</b>																		
<b>A5 (8F7)</b>																		
2.0 TDi (125 kW)	2009.05-				Convertible Engine CAHA	GC083103	Outer Joint		42	28	76.4	34	54	I				
2.0 TDi (130 kW)	2011.10-		MT		Convertible Engine CGLC	GDS83337	Drive Shaft		42		76.5	34	461					
	2011.10-				Convertible Engine CGLC	GC083102	Outer Joint		42	29	76.5	34	60	I				
2.0 TDi (140 kW)	2013.09-				Convertible Engine CNHA	GDS83337	Drive Shaft		42		76.5	34	461					
	2013.09-				Convertible Engine CNHA	GC083102	Outer Joint		42	29	76.5	34	60	I				
2.0 TDi Quattro (130 kW)	2012.01-				Convertible Engine CGLC	GC083107	Outer Joint		42	25	76.5	34	47.5	I				
2.0 TFSi (132 kW)	2009.03-		6MT/CVT	L/R	F	Convertible Engine CAEA/CDNB	GC083087	Outer Joint		42	27	76.5	34	54.5	M			
	2009.03-		6MT/CTV	L/R	F	Convertible Engine CAEA/CDNB	GDS83273	Drive Shaft		42		76.5	34	460				
	2009.03-		6MT/CTV	L/R	F	Convertible Engine CAEA/CDNB	GCI83022	Inner Joint			34		88					
	2009.03-		MT/AT	L/R	F	Convertible Engine CAEA/CDNB	GDS83291	Drive Shaft		42		76.4	34	464				
	2009.03-					Convertible Engine CAEA/CDNB	GC083103	Outer Joint		42	28	76.4	34	54	I			
2.0 TFSi (155 kW)	2009.03-		7AT		F	Convertible Engine CAEB/CDNC	GC083086	Outer Joint		42	33	76.5	34	45.5	M			
	2009.03-			L/R	F	Convertible Engine CAEB/CDNC	GC083087	Outer Joint		42	27	76.5	34	54.5	M			
	2009.03-		6MT/CTV	L/R	F	Convertible Engine CAEB/CDNC	GDS83273	Drive Shaft		42		76.5	34	460				
	2009.03-		6MT/CTV	L/R	F	Convertible Engine CAEB/CDNC	GCI83022	Inner Joint			34		88					
	2009.03-		MT/AT	L/R	F	Convertible Engine CAEB/CDNC	GDS83291	Drive Shaft		42		76.4	34	464				
	2009.03-		MT/AT			Convertible Engine CAEB/CDNC	GC083103	Outer Joint		42	28	76.4	34	54	I			
2.0 TFSi (165 kW)	2013.05-		MT/AT	L/R	F	Convertible Engine CNCD	GDS83291	Drive Shaft		42		76.4	34	464				
	2013.05-					Convertible Engine CNCD	GC083103	Outer Joint		42	28	76.4	34	54	I			
2.0 TFSi Quattro (155 kW)	2009.03-		6MT/CVT	L/R		Convertible Engine CAEB/CDNC	GC083087	Outer Joint		42	27	76.5	34	54.5	M			
	2009.03-		6MT	L/R	F	Convertible Engine CAEB/CDNC	GC083109	Outer Joint		42	27	76.5	34	54.5	M			
	2009.03-		7AT	L/R	F	Convertible Engine CAEB/CDNC	GDS83345	Drive Shaft		42		76.5	34	463				
	2009.03-		7AT	L/R	F	Convertible Engine CAEB/CDNC	GCI83029	Inner Joint			24		88.5					
	2009.03-		7AT	L/R	F	Convertible Engine CAEB/CDNC	GC083086	Outer Joint		42	33	76.5	34	45.5	M			
	2009.03-					Convertible Engine CAEB/CDNC	GC083103	Outer Joint		42	28	76.4	34	54	I			
2.7 TDi (140 kW)	2009.03-		6MT		F	Convertible Engine CGKA	GC083088	Outer Joint		42	29	76.5	34	61.5	M			
	2009.03-		6MT	L/R	F	Convertible Engine CGKA	GDS83321	Drive Shaft		42		76.5	34	462				
	2009.03-		6MT	L/R	F	Convertible Engine CGKA	GCI83022	Inner Joint			34		88					
	2009.03-				F	Convertible Engine CGKA	GDS83337	Drive Shaft		42		76.5	34	461				
	2009.03-					Convertible Engine CGKA	GC083102	Outer Joint		42	29	76.5	34	60	I			
3.0 S5 Quattro (245 kW)	2009.06-		7AT	L/R		Convertible Engine CAKA/CCBA/CGWC/CGXC/CTUB	GC083087	Outer Joint		42	27	76.5	34	54.5	M			
	2009.06-		7AT	L/R	F	Convertible Engine CAKA/CCBA/CGWC/CGXC/CTUB	GDS83273	Drive Shaft		42		76.5	34	460				
	2009.06-		7AT	L/R	F	Convertible Engine CAKA/CCBA/CGWC/CGXC/CTUB	GCI83022	Inner Joint			34		88					
	2009.06-			L/R	F	Convertible Engine CAKA/CCBA/CGWC/CGXC/CTUB	GDS83291	Drive Shaft		42		76.4	34	464				
	2009.06-					Convertible Engine CAKA/CCBA/CGWC/CGXC/CTUB	GC083103	Outer Joint		42	28	76.4	34	54	I			
3.0 TDi (150 kW)	2011.10-		MT/AT		F	Convertible Engine CLAB	GDS83337	Drive Shaft		42		76.5	34	461				
	2011.10-					Convertible Engine CLAB	GC083102	Outer Joint		42	29	76.5	34	60	I			
3.0 TDi Quattro (176 kW)	2009.03-		7AT	L/R		Convertible Engine CCWA	GC083087	Outer Joint		42	27	76.5	34	54.5	M			
	2009.03-		7AT	L/R	F	Convertible Engine CCWA	GDS83273	Drive Shaft		42		76.5	34	460				
	2009.03-		7AT	L/R	F	Convertible Engine CCWA	GCI83022	Inner Joint			34		88					
3.0 TDi Quattro (180 kW)	2011.10-			L/R	F	Convertible Engine CDUC	GDS83291	Drive Shaft		42		76.4	34	464				
	2011.10-					Convertible Engine CDUC	GC083103	Outer Joint		42	28	76.4	34	54	I			
3.0 TFSi Quattro (200 kW)	2011.11-			L/R	F	Convertible Engine CMUA	GDS83291	Drive Shaft		42		76.4	34	464				
	2011.11-				F	Convertible Engine CMUA	GC083103	Outer Joint		42	28	76.4	34	54	I			
3.2 FSi (195 kW)	2009.03-		7AT		F	Convertible Engine CALA	GC083086	Outer Joint		42	33	76.5	34	45.5	M			
	2009.03-		6MT/CVT	L/R	F	Convertible Engine CALA	GC083087	Outer Joint		42	27	76.5	34	54.5	M			
	2009.03-		6MT/CTV	L/R	F	Convertible Engine CALA	GDS83273	Drive Shaft		42		76.5	34	460				
	2009.03-		6MT/CTV	L/R	F	Convertible Engine CALA	GCI83022	Inner Joint			34		88					
	2009.03-			L/R	F	Convertible Engine CALA	GDS83291	Drive Shaft		42		76.4	34	464				
	2009.03-					Convertible Engine CALA	GC083103	Outer Joint		42	28	76.4	34	54	I			
3.2 FSi Quattro (195 kW)	2009.03-				F	Convertible Engine CALA	GC083086	Outer Joint		42	33	76.5	34	45.5	M			
	2009.03-		7AT	L/R	F	Convertible Engine CALA	GDS83345	Drive Shaft		42		76.5	34	463				
	2009.03-		7AT	L/R	F	Convertible Engine CALA	GCI83029	Inner Joint			24		88.5					
	2009.03-		7AT	L/R	F	Convertible Engine CALA	GC083086	Outer Joint		42	33	76.5	34	45.5	M			
4.2 RS 5 Quattro (331 kW)	2013.02-				F	Convertible Engine CFSA	GDS83291	Drive Shaft		42		76.4	34	464				
	2013.02-					Convertible Engine CFSA	GC083103	Outer Joint		42	28	76.4	34	54	I			
<b>A5 (8F7, 8T3, 8TA), SPORTBACK</b>																		
1.8 TFSi (118 kW)	2007.10-	2012.03										34		88				
1.8 TFSi (125 kW)	2007.10-	2012.03										34		88				
2.0 TDi (100 kW)	2008.08-				Exc Quattr							34		88				
2.0 TDi (105 kW)	2008.08-				Exc Quattr							34		88				
2.0 TDi (120 kW)	2008.08-				Exc Quattr							34		88				

		TRANSM	L/R	F/R		G-AP Ref.	PRODUCT	ABS	Technical Specifications						
									YEAR	A	B	C	H	L	P
<b>AUDI</b>															
<b>A5 (8F7, 8T3, 8TA), SPORTBACK</b>															
2.0 TDi (125 kW)	2008.08-	2012.03			Ch-8T8011000	GCI83022	Inner Joint		34	88					
2.0 TDi Quattro (120 kW)	2008.08-	2012.03				GCI83022	Inner Joint		34	88					
2.0 TDi Quattro (130 kW)	2008.08-	2012.03				GCI83022	Inner Joint		34	88					
2.0 TFSi (132 kW)	2008.11-	2012.03				GCI83022	Inner Joint		34	88					
2.0 TFSi Quattro (132 kW)	2008.11-	2012.03			Exc Quattro	GCI83022	Inner Joint		34	88					
2.0 TFSi Quattro (155 kW)	2008.11-	2012.03			Exc Quattro	GCI83022	Inner Joint		34	88					
2.7 TDi (120 kW)	2007.09-	2012.03			Ch-8T8011000/8T8011001	GCI83022	Inner Joint		34	88					
2.7 TDi (140 kW)	2007.09-	2012.03			Ch-8T8011000/8T8011001	GCI83022	Inner Joint		34	88					
	2009.09-					GC083087	Outer Joint	42	27	76.5	34	54.5	M		
3.0 TDi (150 kW)	2007.09-	2012.03				GCI83022	Inner Joint		34	88					
3.0 TDi Quattro (155 kW)	2007.06-	2012.03			Ch-8T8011000	GCI83022	Inner Joint		34	88					
3.0 TDi Quattro (176 kW)	2007.06-	2012.03			Ch-8T8011000	GCI83022	Inner Joint		34	88					
3.0 TDi Quattro (180 kW)	2007.06-	2012.03				GCI83022	Inner Joint		34	88					
3.0 TFSi Quattro (200 kW)	2007.06-	2012.03				GCI83022	Inner Joint		34	88					
3.0 TFSi Quattro (245 kW)	2007.06-	2012.03				GCI83022	Inner Joint		34	88					
3.0 TFSi Quattro S5 (245 kW)	2007.06-	2012.03				GCI83022	Inner Joint		34	88					
3.2 FSi (195 kW)	2007.06-	2012.03			Ch-8T8011000/8T8011001	GCI83022	Inner Joint		34	88					
4.2 FSi 40V Quattro (260 kW)	2007.06-	2012.03			Ch-8T8011000/8T8011001	GCI83022	Inner Joint		34	88					
<b>A5 (8T3)</b>															
1.8 TFSi (118 kW)	2009.05-		6MT/CVT	L/R	F	Coupe Engine CDHB	GC083087	Outer Joint	42	27	76.5	34	54.5	M	
	2009.05-		6MT/CTV	L/R	F	Coupe Engine CDHB	GDS83273	Drive Shaft	42		76.5	34	460		
	2009.05-		6MT/CTV	L/R	F	Coupe Engine CDHB	GCI83022	Inner Joint		34	88				
	2009.05-			L/R	F	Coupe Engine CDHB	GDS83291	Drive Shaft	42		76.4	34	464		
	2009.05-					Coupe Engine CDHB	GC083103	Outer Joint	42	28	76.4	34	54	I	
1.8 TFSi (125 kW)	2007.09-		6MT/CVT	L/R	F	Coupe Engine CABD/CJEB	GC083087	Outer Joint	42	27	76.5	34	54.5	M	
	2007.09-		6MT/CTV	L/R	F	Coupe Engine CABD/CJEB	GDS83273	Drive Shaft	42		76.5	34	460		
	2007.09-		6MT/CTV	L/R	F	Coupe Engine CABD/CJEB	GCI83022	Inner Joint		34	88				
	2007.09-			L/R	F	Coupe Engine CABD/CJEB	GDS83291	Drive Shaft	42		76.4	34	464		
	2007.09-					Coupe Engine CABD/CJEB	GC083103	Outer Joint	42	28	76.4	34	54	I	
2.0 TDi (120 kW)	2008.08-			L/R	F	Coupe Engine CGLD/CAHB	GC083087	Outer Joint	42	27	76.5	34	54.5	M	
	2008.08-			L/R	F	Coupe Engine CGLD/CAHB	GDS83321	Drive Shaft	42		76.5	34	462		
	2008.08-			L/R	F	Coupe Engine CGLD/CAHB	GDS83273	Drive Shaft	42		76.5	34	460		
	2008.08-		MT		F	Coupe Engine CGLD/CAHB	GCI83022	Inner Joint		34	88				
	2008.08-					Coupe Engine CGLD/CAHB	GDS83291	Drive Shaft	42		76.4	34	464		
	2008.08-					Coupe Engine CGLD/CAHB	GC083103	Outer Joint	42	28	76.4	34	54	I	
2.0 TDi (125 kW)	2008.08-		MT/AT		F	Coupe Engine CAHA	GC083086	Outer Joint	42	33	76.5	34	45.5	M	
	2008.08-		6MT/CVT	L/R	F	Coupe Engine CAHA	GC083087	Outer Joint	42	27	76.5	34	54.5	M	
	2008.08-		6MT/CTV	L/R	F	Coupe Engine CAHA	GDS83273	Drive Shaft	42		76.5	34	460		
	2008.08-		6MT/CTV	L/R	F	Coupe Engine CAHA	GCI83022	Inner Joint		34	88				
	2008.08-		MT/AT		F	Coupe Engine CAHA	GDS83291	Drive Shaft	42		76.4	34	464		
	2008.08-					Coupe Engine CAHA	GC083103	Outer Joint	42	28	76.4	34	54	I	
2.0 TDi (130 kW)	2011.10-		MT		F	Coupe Engine CGLC	GDS83337	Drive Shaft	42		76.5	34	461		
	2011.10-					Coupe Engine CGLC	GC083102	Outer Joint	42	29	76.5	34	60	I	
2.0 TDi (140 kW)	2013.09-		MT		F	Coupe Engine CNHA	GDS83337	Drive Shaft	42		76.5	34	461		
	2013.09-					Coupe Engine CNHA	GC083102	Outer Joint	42	29	76.5	34	60	I	
2.0 TDi Quattro (125 kW)	2008.08-				F	Coupe Engine CAHA	GC083086	Outer Joint	42	33	76.5	34	45.5	M	
	2008.08-		6MT/6AT/7AT	L/R	F	Coupe Engine CAHA	GDS83345	Drive Shaft	42		76.5	34	463		
	2008.08-		6MT/6AT/7AT	L/R	F	Coupe Engine CAHA	GCI83029	Inner Joint		24	88.5				
	2008.08-		6MT/6AT/7AT	L/R	F	Coupe Engine CAHA	GC083086	Outer Joint	42	33	76.5	34	45.5	M	
2.0 TDi Quattro (130 kW)	2011.12-				Coupe Engine CGLC	GC083107	Outer Joint	42	25	76.5	34	47.5	I		
2.0 TFSi (132 kW)	2008.11-		6MT/CVT	L/R	F	Coupe Engine CDNB	GC083087	Outer Joint	42	27	76.5	34	54.5	M	
	2008.11-		6MT/CTV	L/R	F	Coupe Engine CDNB	GDS83273	Drive Shaft	42		76.5	34	460		
	2008.11-		6MT/CTV	L/R	F	Coupe Engine CDNB	GCI83022	Inner Joint		34	88				
	2008.11-		MT/AT	L/R	F	Coupe Engine CDNB	GDS83291	Drive Shaft	42		76.4	34	464		
	2008.11-					Coupe Engine CDNB	GC083103	Outer Joint	42	28	76.4	34	54	I	
2.0 TFSi (155 kW)	2008.06-		MT/AT		F	Coupe Engine CDNC	GC083086	Outer Joint	42	33	76.5	34	45.5	M	
	2008.06-		6MT/CVT	L/R	F	Coupe Engine CDNC	GC083087	Outer Joint	42	27	76.5	34	54.5	M	
	2008.06-		6MT/CTV	L/R	F	Coupe Engine CDNC	GDS83273	Drive Shaft	42		76.5	34	460		
	2008.06-		6MT/CTV	L/R	F	Coupe Engine CDNC	GCI83022	Inner Joint		34	88				
	2008.06-		MT/AT	L/R	F	Coupe Engine CDNC	GDS83291	Drive Shaft	42		76.4	34	464		
	2008.06-		MT/AT			Coupe Engine CDNC	GC083103	Outer Joint	42	28	76.4	34	54	I	
2.0 TFSi (165 kW)	2013.05-		MT/AT	L/R	F	Coupe Engine CNCD	GDS83291	Drive Shaft	42		76.4	34	464		



	 YEAR	TRANSM	L/R	F/R		G-AP Ref.	PRODUCT	ABS	Technical Specifications									
									A	B	C	H	L	P				
<b>AUDI</b>																		
<b>A5 (8T3)</b>																		
2.0 TFSi (165 kW)	2013.05-				Coupe Engine CNCD	GC083103	Outer Joint		42	28	76.4	34	54	I				
2.0 TFSi Quattro (155 kW)	2008.06-			F	Coupe Engine CAEB/CDNC	GC083086	Outer Joint		42	33	76.5	34	45.5	M				
	2008.06-	6MT/6AT/7AT	L/R	F	Coupe Engine CAEB/CDNC	GDS83345	Drive Shaft		42		76.5	34	463					
	2008.06-	6MT/6AT/7AT	L/R	F	Coupe Engine CAEB/CDNC	GCI83029	Inner Joint			24		88.5						
	2008.06-	6MT/6AT/7AT	L/R	F	Coupe Engine CAEB/CDNC	GC083086	Outer Joint		42	33	76.5	34	45.5	M				
	2008.06-			F	Coupe Engine CAEB/CDNC	GDS83291	Drive Shaft		42		76.4	34	464					
	2008.06-	MT		R	Coupe Engine CAEB/CDNC	GC083103	Outer Joint		42	28	76.4	34	54	I				
2.7 TDi (120 kW)	2007.09-	6MT		F	Coupe Engine CGKB/CAMB	GC083088	Outer Joint		42	29	76.5	34	61.5	M				
	2007.09-	6MT	L/R	F	Coupe Engine CGKB/CAMB	GDS83321	Drive Shaft		42		76.5	34	462					
	2007.09-	6MT	L/R	F	Coupe Engine CGKB/CAMB	GCI83022	Inner Joint			34		88						
2.7 TDi (140 kW)	2007.06-	6MT		F	Coupe Engine CAMA/CGKA	GC083088	Outer Joint		42	29	76.5	34	61.5	M				
	2007.06-	6MT	L/R	F	Coupe Engine CAMA/CGKA	GDS83321	Drive Shaft		42		76.5	34	462					
	2007.06-	6MT	L/R	F	Coupe Engine CAMA/CGKA	GCI83022	Inner Joint			34		88						
	2007.06-			R	Coupe Engine CAMA/CGKA	GC083102	Outer Joint		42	29	76.5	34	60	I				
3.0 S5 Quattro (245 kW)	2011.10-			L/R	Coupe Engine CAKA/CGWC/CGXC/CTUB	GDS83291	Drive Shaft		42		76.4	34	464					
	2011.10-				Coupe Engine CAKA/CGWC/CGXC/CTUB	GC083103	Outer Joint		42	28	76.4	34	54	I				
3.0 TDi (150 kW)	2011.10-	MT/AT		F	Coupe Engine CLAB	GDS83337	Drive Shaft		42		76.5	34	461					
	2011.10-				Coupe Engine CLAB	GC083102	Outer Joint		42	29	76.5	34	60	I				
3.0 TDi Quattro (155 kW)	2008.03-			L/R	Coupe Engine CCWB	GC083087	Outer Joint		42	27	76.5	34	54.5	M				
	2008.03-			R	Coupe Engine CCWB	GC083088	Outer Joint		42	29	76.5	34	61.5	M				
	2008.03-	6MT/6AT/7AT	L/R	F	Coupe Engine CCWB	GDS83273	Drive Shaft		42		76.5	34	460					
	2008.03-	6MT/6AT/7AT	L/R	F	Coupe Engine CCWB	GCI83022	Inner Joint			34		88						
	2008.03-			F	Coupe Engine CCWB	GDS83291	Drive Shaft		42		76.4	34	464					
	2008.03-				Coupe Engine CCWB	GC083103	Outer Joint		42	28	76.4	34	54	I				
3.0 TDi Quattro (176 kW)	2007.06-	6MT/6AT/7AT	L/R		Coupe Engine CAPA/CCWA	GC083087	Outer Joint		42	27	76.5	34	54.5	M				
	2007.06-	6MT/6AT/7AT	L/R	F	Coupe Engine CAPA/CCWA	GDS83273	Drive Shaft		42		76.5	34	460					
	2007.06-	6MT/6AT/7AT	L/R	F	Coupe Engine CAPA/CCWA	GCI83022	Inner Joint			34		88						
3.0 TDi Quattro (180 kW)	2011.10-			L/R	Coupe Engine CDUC/CKVB	GDS83291	Drive Shaft		42		76.4	34	464					
	2011.10-				Coupe Engine CDUC/CKVB	GC083103	Outer Joint		42	28	76.4	34	54	I				
3.0 TFSi Quattro (200 kW)	2011.12-			L/R	Coupe Engine CMUA	GDS83291	Drive Shaft		42		76.4	34	464					
3.2 FSi (195 kW)	2007.06-	MT/AT		F	Coupe Engine CALA	GC083086	Outer Joint		42	33	76.5	34	45.5	M				
	2007.06-	6MT/CVT	L/R	F	Coupe Engine CALA	GC083087	Outer Joint		42	27	76.5	34	54.5	M				
	2007.06-	6MT/CTV	L/R	F	Coupe Engine CALA	GDS83273	Drive Shaft		42		76.5	34	460					
	2007.06-	6MT/CTV	L/R	F	Coupe Engine CALA	GCI83022	Inner Joint			34		88						
	2007.06-			L/R	Coupe Engine CALA	GDS83291	Drive Shaft		42		76.4	34	464					
	2007.06-				Coupe Engine CALA	GC083103	Outer Joint		42	28	76.4	34	54	I				
3.2 FSi Quattro (195 kW)	2007.06-	6MT/CVT	L/R		Coupe Engine CALA	GC083087	Outer Joint		42	27	76.5	34	54.5	M				
	2007.06-	MT/AT		F	Coupe Engine CALA	GC083086	Outer Joint		42	33	76.5	34	45.5	M				
	2007.06-	6MT/6AT/7AT	L/R	F	Coupe Engine CALA	GDS83345	Drive Shaft		42		76.5	34	463					
	2007.06-	6MT/6AT/7AT	L/R	F	Coupe Engine CALA	GCI83029	Inner Joint			24		88.5						
	2007.06-	6MT/6AT/7AT	L/R	F	Coupe Engine CALA	GC083086	Outer Joint		42	33	76.5	34	45.5	M				
4.2 RS 5 Quattro (331 kW)	2010.03-			L/R	Coupe Engine CFSA	GC083087	Outer Joint		42	27	76.5	34	54.5	M				
	2010.03-			L/R	Coupe Engine CFSA	GDS83273	Drive Shaft		42		76.5	34	460					
	2010.03-			L/R	Coupe Engine CFSA	GCI83022	Inner Joint			34		88						
	2010.03-	AT		F	Coupe Engine CFSA	GDS83291	Drive Shaft		42		76.4	34	464					
	2010.03-	AT			Coupe Engine CFSA	GC083103	Outer Joint		42	28	76.4	34	54	I				
4.2 S5 Quattro (260 kW)	2007.06-	6MT/6AT/7AT	L/R		Coupe Engine CAUA	GC083087	Outer Joint		42	27	76.5	34	54.5	M				
	2007.06-	6MT/6AT/7AT	L/R	F	Coupe Engine CAUA	GDS83273	Drive Shaft		42		76.5	34	460					
	2007.06-	6MT/6AT/7AT	L/R	F	Coupe Engine CAUA	GCI83022	Inner Joint			34		88						
<b>A5 (8TA)</b>																		
1.8 TFSi (118 kW)	2009.11-			L/R	Hatchback Engine CDHB	GC083087	Outer Joint		42	27	76.5	34	54.5	M				
	2009.11-			L/R	Hatchback Engine CDHB	GDS83273	Drive Shaft		42		76.5	34	460					
	2009.11-			L/R	Hatchback Engine CDHB	GCI83022	Inner Joint			34		88						
	2009.11-	AT		F	Hatchback Engine CDHB	GDS83291	Drive Shaft		42		76.4	34	464					
	2009.11-				Hatchback Engine CDHB	GC083103	Outer Joint		42	28	76.4	34	54	I				
1.8 TFSi (125 kW)	2011.08-			L/R	Hatchback Engine CJEB	GC083087	Outer Joint		42	27	76.5	34	54.5	M				
	2011.08-			L/R	Hatchback Engine CJEB	GDS83291	Drive Shaft		42		76.4	34	464					
	2011.08-			L/R	Hatchback Engine CJEB	GCI83022	Inner Joint			34		88						
	2011.08-				Hatchback Engine CJEB	GC083103	Outer Joint		42	28	76.4	34	54	I				
2.0 TDi (100 kW)	2009.09-			L/R	Hatchback Engine CJC/CAGB	GC083087	Outer Joint		42	27	76.5	34	54.5	M				
	2009.09-			L/R	Hatchback Engine CJC/CAGB	GDS83273	Drive Shaft		42		76.5	34	460					
	2009.09-			L/R	Hatchback Engine CJC/CAGB	GCI83022	Inner Joint			34		88						





	 YEAR	TRANSM	L/R	F/R		G-AP Ref.	PRODUCT	ABS	Technical Specifications								
									A	B	C	H	L	P			
<b>AUDI</b>																	
<b>A5 (8TA)</b>																	
2.0 TDi (105 kW)	2009.09-				Hatchback Engine CMFA/CJCA/CMEA/CAGA	GC083103	Outer Joint		42	28	76.4	34	54	I			
	2009.09-			L/R	F Hatchback Engine CMFA/CJCA/CMEA/CAGA	GC083087	Outer Joint		42	27	76.5	34	54.5	M			
	2009.09-			L/R	F Hatchback Engine CMFA/CJCA/CMEA/CAGA	GDS83291	Drive Shaft		42		76.4	34	464				
	2009.09-			L/R	F Hatchback Engine CMFA/CJCA/CMEA/CAGA	GCI83022	Inner Joint			34		88					
2.0 TDi (120 kW)	2009.09-			L/R	F Hatchback Engine CGLD/CAHB	GC083087	Outer Joint		42	27	76.5	34	54.5	M			
	2009.09-			L/R	F Hatchback Engine CGLD/CAHB	GDS83321	Drive Shaft		42		76.5	34	462				
	2009.09-			L/R	F Hatchback Engine CGLD/CAHB	GDS83291	Drive Shaft		42		76.4	34	464				
	2009.09-			L/R	F Hatchback Engine CGLD/CAHB	GCI83022	Inner Joint			34		88					
2.0 TDi (125 kW)	2009.09-			L/R	F Hatchback Engine CAHA	GC083087	Outer Joint		42	27	76.5	34	54.5	M			
	2009.09-			L/R	F Hatchback Engine CAHA	GDS83273	Drive Shaft		42		76.5	34	460				
	2009.09-			L/R	F Hatchback Engine CAHA	GCI83022	Inner Joint			34		88					
	2009.09-		MT/AT		F Hatchback Engine CAHA	GDS83291	Drive Shaft		42		76.4	34	464				
	2009.09-				F Hatchback Engine CAHA	GC083103	Outer Joint		42	28	76.4	34	54	I			
2.0 TDi Quattro (125 kW)	2009.09-				F Hatchback Engine CAHA	GC083086	Outer Joint		42	33	76.5	34	45.5	M			
	2009.09-			L/R	F Hatchback Engine CAHA	GDS83345	Drive Shaft		42		76.5	34	463				
	2009.09-			L/R	F Hatchback Engine CAHA	GCI83029	Inner Joint			24		88.5					
	2009.09-			L/R	F Hatchback Engine CAHA	GC083086	Outer Joint		42	33	76.5	34	45.5	M			
2.0 TDi Quattro (130 kW)	2011.12-		MT		Hatchback Engine CGLC	GC083107	Outer Joint		42	25	76.5	34	47.5	I			
	2011.12-				Hatchback Engine CGLC	GC083103	Outer Joint		42	28	76.4	34	54	I			
2.0 TFSi (132 kW)	2009.09-			L/R	F Hatchback Engine CDNB	GC083087	Outer Joint		42	27	76.5	34	54.5	M			
	2009.09-			L/R	F Hatchback Engine CDNB	GDS83291	Drive Shaft		42		76.4	34	464				
	2009.09-			L/R	F Hatchback Engine CDNB	GCI83022	Inner Joint			34		88					
	2009.09-				Hatchback Engine CDNB	GC083103	Outer Joint		42	28	76.4	34	54	I			
2.0 TFSi (155 kW)	2009.09-			L/R	F Hatchback Engine CDNC	GC083087	Outer Joint		42	27	76.5	34	54.5	M			
	2009.09-			L/R	F Hatchback Engine CDNC	GDS83273	Drive Shaft		42		76.5	34	460				
	2009.09-			L/R	F Hatchback Engine CDNC	GCI83022	Inner Joint			34		88					
	2009.09-				F Hatchback Engine CDNC	GDS83291	Drive Shaft		42		76.4	34	464				
	2009.09-				Hatchback Engine CDNC	GC083103	Outer Joint		42	28	76.4	34	54	I			
2.0 TFSi Quattro (155 kW)	2009.09-				F Hatchback Engine CDNC	GC083086	Outer Joint		42	33	76.5	34	45.5	M			
	2009.09-			L/R	F Hatchback Engine CDNC	GDS83345	Drive Shaft		42		76.5	34	463				
	2009.09-			L/R	F Hatchback Engine CDNC	GCI83029	Inner Joint			24		88.5					
	2009.09-			L/R	F Hatchback Engine CDNC	GC083086	Outer Joint		42	33	76.5	34	45.5	M			
	2009.09-				Hatchback Engine CDNC	GC083103	Outer Joint		42	28	76.4	34	54	I			
2.7 TDi (140 kW)	2009.09-				F Hatchback Engine CGKA	GC083087	Outer Joint		42	27	76.5	34	54.5	M			
	2009.09-			L/R	F Hatchback Engine CGKA	GC083087	Outer Joint		42	27	76.5	34	54.5	M			
	2009.09-			L/R	F Hatchback Engine CGKA	GDS83321	Drive Shaft		42		76.5	34	462				
	2009.09-			L/R	F Hatchback Engine CGKA	GCI83022	Inner Joint			34		88					
	2009.09-		MT/AT		F Hatchback Engine CGKA	GDS83337	Drive Shaft		42		76.5	34	461				
	2009.09-				Hatchback Engine CGKA	GC083102	Outer Joint		42	29	76.5	34	60	I			
3.0 S5 Quattro (245 kW)	2010.01-			L/R	Hatchback Engine CAKA/CGWC/CTUB	GC083087	Outer Joint		42	27	76.5	34	54.5	M			
	2010.01-				R Hatchback Engine CAKA/CGWC/CTUB	GC083088	Outer Joint		42	29	76.5	34	61.5	M			
	2010.01-			L/R	F Hatchback Engine CAKA/CGWC/CTUB	GDS83291	Drive Shaft		42		76.4	34	464				
	2010.01-			L/R	F Hatchback Engine CAKA/CGWC/CTUB	GCI83022	Inner Joint			34		88					
	2010.01-				Hatchback Engine CAKA/CGWC/CTUB	GC083103	Outer Joint		42	28	76.4	34	54	I			
3.0 TDi (150 kW)	2011.10-			L/R	F Hatchback Engine CLAB	GDS83337	Drive Shaft		42		76.5	34	461				
	2011.10-				Hatchback Engine CLAB	GC083102	Outer Joint		42	29	76.5	34	60	I			
3.0 TDi Quattro (176 kW)	2009.09-			L/R	Hatchback Engine CCWA	GC083087	Outer Joint		42	27	76.5	34	54.5	M			
	2009.09-				R Hatchback Engine CCWA	GC083088	Outer Joint		42	29	76.5	34	61.5	M			
	2009.09-			L/R	F Hatchback Engine CCWA	GDS83273	Drive Shaft		42		76.5	34	460				
	2009.09-			L/R	F Hatchback Engine CCWA	GCI83022	Inner Joint			34		88					
3.0 TDi Quattro (180 kW)	2011.10-			L/R	F Hatchback Engine CDUC/CKVB	GDS83291	Drive Shaft		42		76.4	34	464				
3.0 TFSi Quattro (200 kW)	2011.12-			L/R	F Hatchback Engine CMUA	GDS83291	Drive Shaft		42		76.4	34	464				
	2011.12-				Hatchback Engine CMUA	GC083103	Outer Joint		42	28	76.4	34	54	I			
3.2 FSi Quattro (195 kW)	2009.09-				F Hatchback Engine CALA	GC083086	Outer Joint		42	33	76.5	34	45.5	M			
	2009.09-				R Hatchback Engine CALA	GC083088	Outer Joint		42	29	76.5	34	61.5	M			
	2009.09-			L/R	F Hatchback Engine CALA	GDS83345	Drive Shaft		42		76.5	34	463				
	2009.09-			L/R	F Hatchback Engine CALA	GCI83029	Inner Joint			24		88.5					
	2009.09-			L/R	F Hatchback Engine CALA	GC083086	Outer Joint		42	33	76.5	34	45.5	M			
<b>A5 CONVERTIBLE (8F7)</b>																	
2.0 TFSi (162 kW)	2013.05-				F Convertible Engine CAED	GDS83291	Drive Shaft		42		76.4	34	464				
	2013.05-				Convertible Engine CAED	GC083103	Outer Joint		42	28	76.4	34	54	I			



		TRANSM	L/R	F/R		G-AP Ref.	PRODUCT	ABS	Technical Specifications						
									YEAR	A	B	C	H	L	P
<b>AUDI</b>															
<b>A5 SPORTBACK (8TA)</b>															
1.8 TFSi (106 kW)	2014.09-		MT/AT	L/R	F	Hatchback Engine CJED	GDS83291	Drive Shaft	42		76.4	34	464		
	2014.09-					Hatchback Engine CJED	GC083103	Outer Joint	42	28	76.4	34	54	I	
2.0 TDi (110 kW)	2013.05-		MT/AT	L/R	F	Hatchback Engine CJCD	GDS83291	Drive Shaft	42		76.4	34	464		
	2013.05-					Hatchback Engine CJCD	GC083103	Outer Joint	42	28	76.4	34	54	I	
2.0 TDi (140 kW)	2013.09-				F	Hatchback Engine CNHA	GDS83337	Drive Shaft	42		76.5	34	461		
	2013.09-					Hatchback Engine CNHA	GC083102	Outer Joint	42	29	76.5	34	60	I	
2.0 TFSi (165 kW)	2013.05-		MT/AT	L/R	F	Hatchback Engine CNCD	GDS83291	Drive Shaft	42		76.4	34	464		
	2013.05-					Hatchback Engine CNCD	GC083103	Outer Joint	42	28	76.4	34	54	I	
<b>A6</b>															
-							GC083055	Outer Joint	45T	38	30	59.5	34	61	I
				L			GDS83025	Drive Shaft	38		59.5	34	543		
				R			GDS83026	Drive Shaft	38		59.5	34	558		
<b>A6 (4A, C4)</b>															
2.0 (74 kW)	1994.06-	1997.10	MT/AT		F	Saloon Engine AAE	GC083016	Outer Joint	45T	38	30	59.5	34	61	I
2.0 (85 kW)	1994.06-	1997.10	MT/AT		F	Saloon Engine ABK	GC083016	Outer Joint	45T	38	30	59.5	34	61	I
2.0 16V (103 kW)	1994.06-	1997.10	MT/AT		F	Saloon Engine ACE	GC083016	Outer Joint	45T	38	30	59.5	34	61	I
2.0 16V Quattro (103 kW)	1994.06-	1997.10	MT		F	Saloon Engine ACE	GC083016	Outer Joint	45T	38	30	59.5	34	61	I
	1994.06-	1997.10	MT/AT		R	Saloon Engine ACE	GC083014	Outer Joint	45T	38	25	59.5	34.5	61	O
2.2 S6 Turbo Quattro (169 kW)	1994.06-	1997.10	AT	L	F	Saloon Engine AAN	GDS83060	Drive Shaft	45T	38		59.5	34	565	
	1994.06-	1997.10	AT	R	F	Saloon Engine AAN	GDS83061	Drive Shaft	45T	38		59.5	34	488	
	1994.06-	1997.10	MT/AT		F	Saloon Engine AAN	GC083017	Outer Joint	45T	38	27	59.5	34.5	68.5	I
	1994.06-	1997.10	AT		R	Saloon Engine AAN	GC083014	Outer Joint	45T	38	25	59.5	34.5	61	O
2.3 (98 kW)	1994.06-	1995.12	MT		F	Saloon Engine AAR	GC083016	Outer Joint	45T	38	30	59.5	34	61	I
2.5 TDi (103 kW)	1994.08-	1997.10	AT	L	F	Saloon Engine AEL	GDS83060	Drive Shaft	45T	38		59.5	34	565	
	1994.08-	1997.10	AT	R	F	Saloon Engine AEL	GDS83061	Drive Shaft	45T	38		59.5	34	488	
	1994.08-	1997.10	MT/AT		F	Saloon Engine AEL	GC083017	Outer Joint	45T	38	27	59.5	34.5	68.5	I
	1994.08-	1997.10	MT	L	F	Saloon Engine AEL	GDS83050	Drive Shaft	45T	38		59.5	34.5	612	
2.5 TDi (84 kW)	1994.08-	1997.10	MT	R	F	Saloon Engine AEL	GDS83051	Drive Shaft	45T	38		59.5	34.5	647	
	1995.01-	1997.10	AT	L	F	Saloon Engine AAT	GDS83060	Drive Shaft	45T	38		59.5	34	565	
	1995.01-	1997.10	AT	R	F	Saloon Engine AAT	GDS83061	Drive Shaft	45T	38		59.5	34	488	
	1995.01-	1997.10	MT/AT		F	Saloon Engine AAT	GC083017	Outer Joint	45T	38	27	59.5	34.5	68.5	I
2.5 TDi (85 kW)	1995.01-	1997.10	MT	L	F	Saloon Engine AAT	GDS83050	Drive Shaft	45T	38		59.5	34.5	612	
	1995.01-	1997.10	MT	R	F	Saloon Engine AAT	GDS83051	Drive Shaft	45T	38		59.5	34.5	647	
	1994.06-	1997.10	AT	L	F	Saloon Engine AAT	GDS83060	Drive Shaft	45T	38		59.5	34	565	
	1994.06-	1997.10	AT	R	F	Saloon Engine AAT	GDS83061	Drive Shaft	45T	38		59.5	34	488	
2.6 (110 kW)	1994.06-	1997.10	MT/AT		F	Saloon Engine AAT	GC083017	Outer Joint	45T	38	27	59.5	34.5	68.5	I
	1994.06-	1997.10	MT	L	F	Saloon Engine AAT	GDS83050	Drive Shaft	45T	38		59.5	34.5	612	
	1994.06-	1997.10	MT	R	F	Saloon Engine AAT	GDS83051	Drive Shaft	45T	38		59.5	34.5	647	
	1994.06-	1997.10	MT/AT		F	Saloon Engine ABC	GC083016	Outer Joint	45T	38	30	59.5	34	61	I
2.6 Quattro (110 kW)	1994.06-	1997.10	MT		F	Saloon Engine ABC	GC083016	Outer Joint	45T	38	30	59.5	34	61	I
	1994.06-	1997.10	MT/AT		R	Saloon Engine ABC	GC083014	Outer Joint	45T	38	25	59.5	34.5	61	O
2.8 (128 kW)	1994.06-	1997.10	AT	R	F	Saloon Engine AAH/AEJ/AFC	GDS83061	Drive Shaft	45T	38		59.5	34	488	
	1994.06-	1997.10	MT/AT		F	Saloon Engine AAH/AEJ/AFC	GC083017	Outer Joint	45T	38	27	59.5	34.5	68.5	I
	1994.06-	1997.10	MT	L	F	Saloon Engine AAH/AEJ/AFC	GDS83050	Drive Shaft	45T	38		59.5	34.5	612	
	1994.06-	1997.10	MT	R	F	Saloon Engine AAH/AEJ/AFC	GDS83051	Drive Shaft	45T	38		59.5	34.5	647	
	1994.06-	1997.10	AT	L	F	Saloon Engine AAH/AEJ/AFC	GDS83060	Drive Shaft	45T	38		59.5	34	565	
2.8 Quattro (128 kW)	1994.06-	1997.10	AT	L	F	Saloon Engine AAH	GDS83060	Drive Shaft	45T	38		59.5	34	565	
	1994.06-	1997.10	AT	R	F	Saloon Engine AAH	GDS83061	Drive Shaft	45T	38		59.5	34	488	
	1994.06-	1997.10	MT/AT		F	Saloon Engine AAH	GC083017	Outer Joint	45T	38	27	59.5	34.5	68.5	I
	1994.06-	1997.10	AT		R	Saloon Engine AAH	GC083014	Outer Joint	45T	38	25	59.5	34.5	61	O
4.2 S6 Plus Quattro (240 kW)	1996.04-	1997.10			F	Saloon Engine AHK	GC083017	Outer Joint	45T	38	27	59.5	34.5	68.5	I
4.2 S6 Quattro (213 kW)	1994.06-	1997.10	AT	L	F	Saloon Engine AEC	GDS83060	Drive Shaft	45T	38		59.5	34	565	
	1994.06-	1997.10	AT	R	F	Saloon Engine AEC	GDS83061	Drive Shaft	45T	38		59.5	34	488	
	1994.06-	1997.10	MT/AT		F	Saloon Engine AEC	GC083017	Outer Joint	45T	38	27	59.5	34.5	68.5	I
<b>A6 (4B2, C5)</b>															
1.8 (92 kW)	1997.07-	2005.01	MT		F	Saloon Engine AJP/ANQ/AQE/ARH	GC083018	Outer Joint	45W	33	30	53	30	62	I
	1997.07-	2005.01	MT		F	Saloon Engine AJP/ANQ/AQE/ARH	GCI83001	Inner Joint			28				
	1997.07-	2005.01	MT		F	Saloon Engine AJP/ANQ/AQE/ARH	GC083045	Outer Joint		33	30	53	30	62	I
1.8 T (110 kW)	1997.01-	2005.01	MT		F	Saloon Engine AEB/ANB/APU/ARK/AWL/AWT	GC083018	Outer Joint	45W	33	30	53	30	62	I
	1997.01-	2005.01	MT		F	Saloon Engine AEB/ANB/APU/ARK/AWL/AWT	GCI83001	Inner Joint			28				
	1997.01-	2005.01		L/R	F	Saloon Engine AEB/ANB/APU/ARK/AWL/AWT	GDS83066	Drive Shaft	45W	38		59.5	34.5	544	
	1997.01-	2005.01	MT		F	Saloon Engine AEB/ANB/APU/ARK/AWL/AWT	GC083045	Outer Joint		33	30	53	30	62	I





		YEAR	TRANSM	L/R	F/R		G-AP Ref.	PRODUCT	ABS	Technical Specifications										
										A	B	C	H	L	P					
<b>AUDI</b>																				
<b>A6 (4B2, C5)</b>																				
1.8 T (132 kW)	1997.12-	2005.01	MT		F	Saloon Engine AJL	GC083018	Outer Joint	45W	33	30	53	30	62	I					
	1997.12-	2005.01		L/R	F	Saloon Engine AJL	GCI61033	Inner Joint			34		85							
	1997.12-	2005.01	MT	R	F	Saloon Engine AJL	GDS99113	Drive Shaft	45W	38		59.5	34.5	654						
	1997.12-	2005.01	MT		F	Saloon Engine AJL	GC083045	Outer Joint		33	30	53	30	62	I					
1.8 T Quattro (110 kW)	1997.02-	2005.01			F	Saloon Engine AEB/ANB/APU/ARK/AWT	GC083018	Outer Joint	45W	33	30	53	30	62	I					
	1997.02-	2005.01	AT	R	F	Saloon Engine AEB/ANB/APU/ARK/AWT	GDS83066	Drive Shaft	45W	38		59.5	34.5	544						
	1997.02-	2005.01				Saloon Engine AEB/ANB/APU/ARK/AWT	GC083045	Outer Joint		33	30	53	30	62	I					
1.8 T Quattro (132 kW)	1997.12-	2005.01	MT		F	Saloon Engine AJL	GC083018	Outer Joint	45W	33	30	53	30	62	I					
	1997.12-	2005.01		L/R	F	Saloon Engine AJL	GCI61033	Inner Joint			34		85							
	1997.12-	2005.01	MT	R	F	Saloon Engine AJL	GDS99113	Drive Shaft	45W	38		59.5	34.5	654						
	1997.12-	2005.01	MT			Saloon Engine AJL	GC083045	Outer Joint		33	30	53	30	62	I					
1.9 TDi (85 kW)	2000.07-	2005.01	AT		F	Saloon Engine AJM	GC083058	Outer Joint	45W	38	33	59.5	34	55	M					
	2000.07-	2005.01	MT/AT		F	Saloon Engine AJM	GC083021	Outer Joint	45W	33	27	53	30	63	I					
	2000.07-	2005.01	AT	L	F	Saloon Engine AJM	GDS83019	Drive Shaft	45W	38		59.5	34.5	550						
	2000.07-	2005.01		L/R	F	Saloon Engine AJM	GCI61033	Inner Joint			34		85							
	2000.07-	2005.01	AT	R	F	Saloon Engine AJM	GDS83020	Drive Shaft	45W	38		59.5	34.5	522						
	2000.07-	2005.01	MT	R	F	Saloon Engine AJM	GDS99113	Drive Shaft	45W	38		59.5	34.5	654						
	2000.07-	2005.01			R	F	Saloon Engine AJM	GDS61076	Drive Shaft	45W	38		59.5	34.5	645					
1.9 TDi (96 kW)	2001.08-	2005.01	MT		F	Saloon Engine AVF/AWX	GC083019	Outer Joint	45W	38	27	59.5	34.5	63	I					
	2001.08-	2005.01	AT	L/R	F	Saloon Engine AVF/AWX	GDS83066	Drive Shaft	45W	38		59.5	34.5	544						
	2001.08-	2005.01		L/R	F	Saloon Engine AVF/AWX	GCI61033	Inner Joint			34		85							
	2001.08-	2005.01	5MT	R	F	Saloon Engine AVF/AWX	GDS99113	Drive Shaft	45W	38		59.5	34.5	654						
	2001.08-	2005.01			R	F	Saloon Engine AVF/AWX	GDS61076	Drive Shaft	45W	38		59.5	34.5	645					
2.0 (96 kW)	2001.08-	2005.01	MT		F	Saloon Engine ALT	GC083019	Outer Joint	45W	38	27	59.5	34.5	63	I					
	2001.08-	2005.01		L/R	F	Saloon Engine ALT	GCI61033	Inner Joint			34		85							
	2001.08-	2005.01	MT	R	F	Saloon Engine ALT	GDS99113	Drive Shaft	45W	38		59.5	34.5	654						
	2001.08-	2005.01			R	F	Saloon Engine ALT	GDS61076	Drive Shaft	45W	38		59.5	34.5	645					
2.4 (100 kW)	1998.07-	2005.01	AT		F	Saloon Engine ALW/ARN/ASM	GC083019	Outer Joint	45W	38	27	59.5	34.5	63	I					
	1998.07-	2005.01	AT	L	F	Saloon Engine ALW/ARN/ASM	GDS83019	Drive Shaft	45W	38		59.5	34.5	550						
	1998.07-	2005.01		L/R	F	Saloon Engine ALW/ARN/ASM	GCI61033	Inner Joint			34		85							
	1998.07-	2005.01	AT	R	F	Saloon Engine ALW/ARN/ASM	GDS83020	Drive Shaft	45W	38		59.5	34.5	522						
	1998.07-	2005.01			R	F	Saloon Engine ALW/ARN/ASM	GDS61076	Drive Shaft	45W	38		59.5	34.5	645					
2.4 (115 kW)	1997.02-	2005.01	MT		F	Saloon Engine APC	GC083019	Outer Joint	45W	38	27	59.5	34.5	63	I					
	1997.02-	2005.01	AT	L	F	Saloon Engine APC	GDS83019	Drive Shaft	45W	38		59.5	34.5	550						
	1997.02-	2005.01		L/R	F	Saloon Engine APC	GCI61033	Inner Joint			34		85							
	1997.02-	2005.01	AT	R	F	Saloon Engine APC	GDS83020	Drive Shaft	45W	38		59.5	34.5	522						
	1997.02-	2005.01	MT	R	F	Saloon Engine APC	GDS99113	Drive Shaft	45W	38		59.5	34.5	654						
	1997.02-	2005.01			R	F	Saloon Engine APC	GDS61076	Drive Shaft	45W	38		59.5	34.5	645					
2.4 (120 kW)	1997.02-	2005.01			F	Saloon Engine AJG/AMM/APZ	GC083020	Outer Joint	45W	38	30	59.5	34	59.5	I					
	1997.02-	2005.01			F	Saloon Engine AJG/AMM/APZ	GC083019	Outer Joint	45W	38	27	59.5	34.5	63	I					
	1997.02-	2005.01	AT	L	F	Saloon Engine AJG/AMM/APZ	GDS83019	Drive Shaft	45W	38		59.5	34.5	550						
	1997.02-	2005.01		L/R	F	Saloon Engine AJG/AMM/APZ	GCI61033	Inner Joint			34		85							
	1997.02-	2005.01	AT	R	F	Saloon Engine AJG/AMM/APZ	GDS83020	Drive Shaft	45W	38		59.5	34.5	522						
	1997.02-	2005.01	MT	R	F	Saloon Engine AJG/AMM/APZ	GDS99113	Drive Shaft	45W	38		59.5	34.5	654						
	1997.02-	2005.01			R	F	Saloon Engine AJG/AMM/APZ	GDS61076	Drive Shaft	45W	38		59.5	34.5	645					
	1997.02-	2005.01			F	Saloon Engine AJG/AMM/APZ	GC083049	Outer Joint		38	30	59.5	34	59.5	I					
2.4 (121 kW)	1997.02-	2005.01	MT/AT		F	Saloon Engine AGA/ALF/AML/APS/ARJ	GCI83002	Inner Joint			33		32							
	1997.02-	2005.01	MT/AT		F	Saloon Engine AGA/ALF/AML/APS/ARJ	GC083020	Outer Joint	45W	38	30	59.5	34	59.5	I					
	1997.02-	2005.01	MT/AT		F	Saloon Engine AGA/ALF/AML/APS/ARJ	GC083019	Outer Joint	45W	38	27	59.5	34.5	63	I					
	1997.02-	2005.01	AT	L	F	Saloon Engine AGA/ALF/AML/APS/ARJ	GDS83019	Drive Shaft	45W	38		59.5	34.5	550						
	1997.02-	2005.01		L/R	F	Saloon Engine AGA/ALF/AML/APS/ARJ	GCI61033	Inner Joint			34		85							
	1997.02-	2005.01	AT	R	F	Saloon Engine AGA/ALF/AML/APS/ARJ	GDS83020	Drive Shaft	45W	38		59.5	34.5	522						
	1997.02-	2005.01	MT	R	F	Saloon Engine AGA/ALF/AML/APS/ARJ	GDS83362	Drive Shaft	45W	38		59.5	34	621						
	1997.02-	2005.01	MT	R	F	Saloon Engine AGA/ALF/AML/APS/ARJ	GDS99113	Drive Shaft	45W	38		59.5	34.5	654						
	1997.02-	2005.01			R	F	Saloon Engine AGA/ALF/AML/APS/ARJ	GDS61076	Drive Shaft	45W	38		59.5	34.5	645					
	1997.02-	2005.01	MT/AT		F	Saloon Engine AGA/ALF/AML/APS/ARJ	GC083049	Outer Joint		38	30	59.5	34	59.5	I					
2.4 (125 kW)	2001.08-	2005.01	AT	L/R	F	Saloon Engine BDV	GDS83066	Drive Shaft	45W	38		59.5	34.5	544						
	2001.08-	2005.01		L/R	F	Saloon Engine BDV	GCI61033	Inner Joint			34		85							
	2001.08-	2005.01	MT	R	F	Saloon Engine BDV	GDS99113	Drive Shaft	45W	38		59.5	34.5	654						
	2001.08-	2005.01			R	F	Saloon Engine BDV	GDS61076	Drive Shaft	45W	38		59.5	34.5	645					
2.4 Quattro (120 kW)	1997.02-	2005.01			F	Saloon Engine AJG/APZ	GC083020	Outer Joint	45W	38	30	59.5	34	59.5	I					
	1997.02-	2005.01			F	Saloon Engine AJG/APZ	GC083019	Outer Joint	45W	38	27	59.5	34.5	63	I					
	1997.02-	2005.01	AT	L	F	Saloon Engine AJG/APZ	GDS83019	Drive Shaft	45W	38		59.5	34.5	550						





		YEAR	TRANSM	L/R	F/R		G-AP Ref.	PRODUCT	ABS	Technical Specifications										
										A	B	C	H	L	P					
<b>AUDI</b>																				
<b>A6 (4B2, C5)</b>																				
2.4 Quattro (120 kW)	1997.02-	2005.01	AT	R	F	Saloon Engine AJG/APZ	GDS83020	Drive Shaft	45W	38		59.5	34.5	522						
	1997.02-	2005.01	MT	R	F	Saloon Engine AJG/APZ	GDS99113	Drive Shaft	45W	38		59.5	34.5	654						
	1997.02-	2005.01		R	F	Saloon Engine AJG/APZ	GDS61076	Drive Shaft	45W	38		59.5	34.5	645						
	1997.02-	2005.01				Saloon Engine AJG/APZ	GC083049	Outer Joint		38	30	59.5	34	59.5	I					
2.4 Quattro (121 kW)	1997.02-	2005.01	MT/AT		F	Saloon Engine AGA/ALF/AML/APS/ARJ	GC083019	Outer Joint	45W	38	27	59.5	34.5	63	I					
	1997.02-	2005.01	AT	L	F	Saloon Engine AGA/ALF/AML/APS/ARJ	GDS83019	Drive Shaft	45W	38		59.5	34.5	550						
	1997.02-	2005.01		L/R	F	Saloon Engine AGA/ALF/AML/APS/ARJ	GCI61033	Inner Joint			34		85							
	1997.02-	2005.01	AT	R	F	Saloon Engine AGA/ALF/AML/APS/ARJ	GDS83020	Drive Shaft	45W	38		59.5	34.5	522						
	1997.02-	2005.01	MT	R	F	Saloon Engine AGA/ALF/AML/APS/ARJ	GDS99113	Drive Shaft	45W	38		59.5	34.5	654						
	1997.02-	2005.01		R	F	Saloon Engine AGA/ALF/AML/APS/ARJ	GDS61076	Drive Shaft	45W	38		59.5	34.5	645						
2.4 Quattro (125 kW)	2001.08-	2005.01	AT	L/R	F	Saloon Engine BDV	GDS83066	Drive Shaft	45W	38		59.5	34.5	544						
	2001.08-	2005.01		L/R	F	Saloon Engine BDV	GCI61033	Inner Joint			34		85							
	2001.08-	2005.01	MT	R	F	Saloon Engine BDV	GDS99113	Drive Shaft	45W	38		59.5	34.5	654						
	2001.08-	2005.01		R	F	Saloon Engine BDV	GDS61076	Drive Shaft	45W	38		59.5	34.5	645						
2.5 TDi (110 kW)	1997.07-	2005.01	MT/AT		F	Saloon Engine AFB/AKN	GC083019	Outer Joint	45W	38	27	59.5	34.5	63	I					
	1997.07-	2005.01	AT	L	F	Saloon Engine AFB/AKN	GDS83019	Drive Shaft	45W	38		59.5	34.5	550						
	1997.07-	2005.01		L/R	F	Saloon Engine AFB/AKN	GCI61033	Inner Joint			34		85							
	1997.07-	2005.01	AT	R	F	Saloon Engine AFB/AKN	GDS83020	Drive Shaft	45W	38		59.5	34.5	522						
	1997.07-	2005.01	MT	R	F	Saloon Engine AFB/AKN	GDS99113	Drive Shaft	45W	38		59.5	34.5	654						
	1997.07-	2005.01		R	F	Saloon Engine AFB/AKN	GDS61076	Drive Shaft	45W	38		59.5	34.5	645						
2.5 TDi (114 kW)	2001.08-	2005.01			F	Saloon Engine AYM	GC083019	Outer Joint	45W	38	27	59.5	34.5	63	I					
	2001.08-	2005.01		L/R	F	Saloon Engine AYM	GDS83066	Drive Shaft	45W	38		59.5	34.5	544						
	2001.08-	2005.01		L/R	F	Saloon Engine AYM	GCI61033	Inner Joint			34		85							
	2001.08-	2005.01	MT	R	F	Saloon Engine AYM	GDS99113	Drive Shaft	45W	38		59.5	34.5	654						
	2001.08-	2005.01		R	F	Saloon Engine AYM	GDS61076	Drive Shaft	45W	38		59.5	34.5	645						
2.5 TDi (120 kW)	2002.07-	2004.05			F	Saloon Engine BCZ/BDG/BFC	GC083019	Outer Joint	45W	38	27	59.5	34.5	63	I					
	2002.07-	2004.05	CVT	L/R	F	Saloon Engine BCZ/BDG/BFC	GDS83066	Drive Shaft	45W	38		59.5	34.5	544						
	2002.07-	2004.05		L/R	F	Saloon Engine BCZ/BDG/BFC	GCI61033	Inner Joint			34		85							
	2002.07-	2004.05		R	F	Saloon Engine BCZ/BDG/BFC	GDS61076	Drive Shaft	45W	38		59.5	34.5	645						
2.5 TDi (132 kW)	2000.02-	2005.01	MT		F	Saloon Engine AKE/BAU/BDH/BND	GC083019	Outer Joint	45W	38	27	59.5	34.5	63	I					
	2000.02-	2005.01		L/R	F	Saloon Engine AKE/BAU/BDH/BND	GDS83066	Drive Shaft	45W	38		59.5	34.5	544						
	2000.02-	2005.01		L/R	F	Saloon Engine AKE/BAU/BDH/BND	GCI61033	Inner Joint			34		85							
	2000.02-	2005.01	AT	R	F	Saloon Engine AKE/BAU/BDH/BND	GDS83020	Drive Shaft	45W	38		59.5	34.5	522						
	2000.02-	2005.01		R	F	Saloon Engine AKE/BAU/BDH/BND	GDS61076	Drive Shaft	45W	38		59.5	34.5	645						
2.5 TDi Quattro (110 kW)	1997.07-	2005.01	MT/AT		F	Saloon Engine AFB/AKN	GC083019	Outer Joint	45W	38	27	59.5	34.5	63	I					
	1997.07-	2005.01	AT	L	F	Saloon Engine AFB/AKN	GDS83019	Drive Shaft	45W	38		59.5	34.5	550						
	1997.07-	2005.01		L/R	F	Saloon Engine AFB/AKN	GCI61033	Inner Joint			34		85							
	1997.07-	2005.01	AT	R	F	Saloon Engine AFB/AKN	GDS83020	Drive Shaft	45W	38		59.5	34.5	522						
	1997.07-	2005.01	MT	R	F	Saloon Engine AFB/AKN	GDS99113	Drive Shaft	45W	38		59.5	34.5	654						
	1997.07-	2005.01		R	F	Saloon Engine AFB/AKN	GDS61076	Drive Shaft	45W	38		59.5	34.5	645						
2.5 TDi Quattro (132 kW)	2000.02-	2005.01	MT			Saloon Engine AKE/BAU/BDH	GC083019	Outer Joint	45W	38	27	59.5	34.5	63	I					
	2000.02-	2005.01	AT	L	F	Saloon Engine AKE/BAU/BDH	GDS83019	Drive Shaft	45W	38		59.5	34.5	550						
	2000.02-	2005.01		L/R	F	Saloon Engine AKE/BAU/BDH	GCI61033	Inner Joint			34		85							
	2000.02-	2005.01	AT	R	F	Saloon Engine AKE/BAU/BDH	GDS83020	Drive Shaft	45W	38		59.5	34.5	522						
	2000.02-	2005.01	MT	R	F	Saloon Engine AKE/BAU/BDH	GDS99113	Drive Shaft	45W	38		59.5	34.5	654						
	2000.02-	2005.01		R	F	Saloon Engine AKE/BAU/BDH	GDS61076	Drive Shaft	45W	38		59.5	34.5	645						
2.7 T (169 kW)	1999.02-	2005.01	MT		F	Saloon Engine AJK	GC083019	Outer Joint	45W	38	27	59.5	34.5	63	I					
	1999.02-	2005.01		L/R	F	Saloon Engine AJK	GCI61033	Inner Joint			34		85							
	1999.02-	2005.01	MT	R	F	Saloon Engine AJK	GDS99113	Drive Shaft	45W	38		59.5	34.5	654						
	1999.02-	2005.01		R	F	Saloon Engine AJK	GDS61076	Drive Shaft	45W	38		59.5	34.5	645						
2.7 T Quattro (169 kW)	1997.12-	2005.01	MT		F	Saloon Engine AJK	GC083019	Outer Joint	45W	38	27	59.5	34.5	63	I					
	1997.12-	2005.01		L/R	F	Saloon Engine AJK	GCI61033	Inner Joint			34		85							
	1997.12-	2005.01	MT	R	F	Saloon Engine AJK	GDS99113	Drive Shaft	45W	38		59.5	34.5	654						
	1997.12-	2005.01		R	F	Saloon Engine AJK	GDS61076	Drive Shaft	45W	38		59.5	34.5	645						
2.7 T Quattro (184 kW)	2001.08-	2005.01			F	Saloon Engine ARE/BES	GC083019	Outer Joint	45W	38	27	59.5	34.5	63	I					
	2001.08-	2005.01		R	F	Saloon Engine ARE/BES	GDS61076	Drive Shaft	45W	38		59.5	34.5	645						
2.8 (140 kW)	1999.07-	2005.01			F	Saloon Engine ATX	GC083033	Outer Joint		36	30	53	78.5	51	I					
	1999.07-	2005.01	AT	L	F	Saloon Engine ATX	GDS83019	Drive Shaft	45W	38		59.5	34.5	550						
	1999.07-	2005.01	AT	R	F	Saloon Engine ATX	GDS83020	Drive Shaft	45W	38		59.5	34.5	522						
	1999.07-	2005.01	MT	R	F	Saloon Engine ATX	GDS99113	Drive Shaft	45W	38		59.5	34.5	654						
2.8 (142 kW)	1999.07-	2005.01		R	F	Saloon Engine ATX	GDS61076	Drive Shaft	45W	38		59.5	34.5	645						
	1997.02-	2005.01	MT/AT		F	Saloon Engine ACK/AHA/ALG/AMX/APR/AQD	GCI83002	Inner Joint			33		32							
1997.02-	2005.01	MT/AT		F	Saloon Engine ACK/AHA/ALG/AMX/APR/AQD	GC083020	Outer Joint	45W	38	30	59.5	34	59.5	I						



		TRANSM	L/R	F/R		G-AP Ref.	PRODUCT	ABS	Technical Specifications									
									YEAR	A	B	C	H	L	P			
<b>AUDI</b>																		
<b>A6 (4B2, C5)</b>																		
2.8 (142 kW)	1997.02-2005.01	MT/AT		F	Saloon Engine ACK/AHA/ALG/AMX/APR/AQD	GC083019	Outer Joint	45W	38	27	59.5	34.5	63	I				
	1997.02-2005.01	AT	L	F	Saloon Engine ACK/AHA/ALG/AMX/APR/AQD	GDS83019	Drive Shaft	45W	38		59.5	34.5	550					
	1997.02-2005.01		L/R	F	Saloon Engine ACK/AHA/ALG/AMX/APR/AQD	GC161033	Inner Joint			34		85						
	1997.02-2005.01	AT	R	F	Saloon Engine ACK/AHA/ALG/AMX/APR/AQD	GDS83020	Drive Shaft	45W	38		59.5	34.5	522					
	1997.02-2005.01	MT	R	F	Saloon Engine ACK/AHA/ALG/AMX/APR/AQD	GDS99113	Drive Shaft	45W	38		59.5	34.5	654					
	1997.02-2005.01		R	F	Saloon Engine ACK/AHA/ALG/AMX/APR/AQD	GDS61076	Drive Shaft	45W	38		59.5	34.5	645					
	1997.02-2005.01	MT/AT		F	Saloon Engine ACK/AHA/ALG/AMX/APR/AQD	GC083049	Outer Joint		38	30	59.5	34	59.5	I				
2.8 Quattro (142 kW)	1997.02-2005.01	MT/AT		F	Saloon Engine ACK/AHA/ALG/AMX/APR/AQD	GC083019	Outer Joint	45W	38	27	59.5	34.5	63	I				
	1997.02-2005.01	AT	L	F	Saloon Engine ACK/AHA/ALG/AMX/APR/AQD	GDS83019	Drive Shaft	45W	38		59.5	34.5	550					
	1997.02-2005.01		L/R	F	Saloon Engine ACK/AHA/ALG/AMX/APR/AQD	GC161033	Inner Joint			34		85						
	1997.02-2005.01	AT	R	F	Saloon Engine ACK/AHA/ALG/AMX/APR/AQD	GDS83020	Drive Shaft	45W	38		59.5	34.5	522					
	1997.02-2005.01	MT	R	F	Saloon Engine ACK/AHA/ALG/AMX/APR/AQD	GDS99113	Drive Shaft	45W	38		59.5	34.5	654					
	1997.02-2005.01		R	F	Saloon Engine ACK/AHA/ALG/AMX/APR/AQD	GDS61076	Drive Shaft	45W	38		59.5	34.5	645					
3.0 (162 kW)	2001.08-2005.01			F	Saloon Engine ASN	GC083019	Outer Joint	45W	38	27	59.5	34.5	63	I				
	2001.08-2005.01	AT	L/R	F	Saloon Engine ASN	GDS83066	Drive Shaft	45W	38		59.5	34.5	544					
	2001.08-2005.01		L/R	F	Saloon Engine ASN	GC161033	Inner Joint			34		85						
	2001.08-2005.01	MT	R	F	Saloon Engine ASN	GDS99113	Drive Shaft	45W	38		59.5	34.5	654					
	2001.06-2004.07	AT	L/R	F	Saloon Engine BBJ	GDS83066	Drive Shaft	45W	38		59.5	34.5	544					
3.0 Quattro (160 kW)	2001.08-2005.01			F	Saloon Engine ASN	GC083019	Outer Joint	45W	38	27	59.5	34.5	63	I				
	2001.08-2005.01	AT	L/R	F	Saloon Engine ASN	GDS83066	Drive Shaft	45W	38		59.5	34.5	544					
	2001.08-2005.01		L/R	F	Saloon Engine ASN	GC161033	Inner Joint			34		85						
	2001.08-2005.01	MT	R	F	Saloon Engine ASN	GDS99113	Drive Shaft	45W	38		59.5	34.5	654					
4.2 Quattro (220 kW)	1998.11-2005.01			F	Saloon Engine ASG/ARS	GC083019	Outer Joint	45W	38	27	59.5	34.5	63	I				
	1998.11-2005.01	AT	L	F	Saloon Engine ASG/ARS	GDS83066	Drive Shaft	45W	38		59.5	34.5	544					
4.2 RS6 Quattro (331 kW)	2002.07-2005.01			F	Saloon Engine BCY	GC083019	Outer Joint	45W	38	27	59.5	34.5	63	I				
	2002.07-2005.01		L	F	Saloon Engine BCY	GDS83066	Drive Shaft	45W	38		59.5	34.5	544					
4.2 S6 Quattro (250 kW)	1999.09-2005.01			F	Saloon Engine ANK/AQJ	GC083019	Outer Joint	45W	38	27	59.5	34.5	63	I				
	1999.09-2005.01	AT	L	F	Saloon Engine ANK/AQJ	GDS83066	Drive Shaft	45W	38		59.5	34.5	544					
<b>A6 (4F2, C6)</b>																		
2.0 TDi (100 kW)	2006.01-2007.11			F	Saloon Engine BNA/BRF/CAGB	GC083077	Outer Joint		38	27	59.5	34	63	M				
	2006.01-2007.11	MT	L	F	Saloon Engine BNA/BRF/CAGB	GDS83290	Drive Shaft		38		59.5	34	617					
	2006.01-2007.11	AT	R	F	Saloon Engine BNA/BRF/CAGB	GDS83292	Drive Shaft		38		59.5	34.5	483					
	2006.01-2007.11	MT	R	F	Saloon Engine BNA/BRF/CAGB	GDS83329	Drive Shaft		38		59.5	34	655					
	2006.01-2007.11				Saloon Engine BNA/BRF/CAGB	GC083099	Outer Joint		38	27	59.5	34.5	64	M				
2.0 TDi (103 kW)	2004.06-2007.11			F	Saloon Engine BLB/BRE	GC083077	Outer Joint		38	27	59.5	34	63	M				
	2004.06-2007.11	MT	L	F	Saloon Engine BLB/BRE	GDS83290	Drive Shaft		38		59.5	34	617					
	2004.06-2007.11	AT	R	F	Saloon Engine BLB/BRE	GDS83292	Drive Shaft		38		59.5	34.5	483					
	2004.06-2007.11	MT	R	F	Saloon Engine BLB/BRE	GDS83329	Drive Shaft		38		59.5	34	655					
	2004.06-2007.11				Saloon Engine BLB/BRE	GC083099	Outer Joint		38	27	59.5	34.5	64	M				
2.0 TDi (125 kW)	2008.11-2011.03			F	Saloon Engine CAHA	GC083077	Outer Joint		38	27	59.5	34	63	M				
	2008.11-2011.03	MT	L	F	Saloon Engine CAHA	GDS83290	Drive Shaft		38		59.5	34	617					
	2008.11-2011.03	AT	R	F	Saloon Engine CAHA	GDS83292	Drive Shaft		38		59.5	34.5	483					
	2008.11-2011.03	MT	R	F	Saloon Engine CAHA	GDS83329	Drive Shaft		38		59.5	34	655					
	2008.11-2011.03				Saloon Engine CAHA	GC083099	Outer Joint		38	27	59.5	34.5	64	M				
2.0 TFSi (125 kW)	2005.06-2007.11			F	Saloon Engine BPJ	GC083077	Outer Joint		38	27	59.5	34	63	M				
	2005.06-2007.11	MT	L	F	Saloon Engine BPJ	GDS83290	Drive Shaft		38		59.5	34	617					
	2005.06-2007.11		L	F	Saloon Engine BPJ	GDS83271	Drive Shaft		38		59.5	34	548					
	2005.06-2007.11	MT	R	F	Saloon Engine BPJ	GDS83329	Drive Shaft		38		59.5	34	655					
	2005.06-2007.11				Saloon Engine BPJ	GC083099	Outer Joint		38	27	59.5	34.5	64	M				
2.4 (130 kW)	2004.05-2008.10			F	Saloon Engine BDW	GC083077	Outer Joint		38	27	59.5	34	63	M				
	2004.05-2008.10	MT	L	F	Saloon Engine BDW	GDS83290	Drive Shaft		38		59.5	34	617					
	2004.05-2008.10		L	F	Saloon Engine BDW	GDS83271	Drive Shaft		38		59.5	34	548					
	2004.05-2008.10	MT	R	F	Saloon Engine BDW	GDS83329	Drive Shaft		38		59.5	34	655					
	2004.05-2008.10				Saloon Engine BDW	GC083099	Outer Joint		38	27	59.5	34.5	64	M				
2.4 Quattro (130 kW)	2005.01-2008.10	MT	R	F	Saloon Engine BDW	GDS83329	Drive Shaft		38		59.5	34	655					
	2005.01-2008.10				Saloon Engine BDW	GC083099	Outer Joint		38	27	59.5	34.5	64	M				
	2005.01-2008.10	AT	L	F	Saloon Engine BDW	GDS83306	Drive Shaft		38		59.5	34	525					
	2005.01-2008.10	MT	L	F	Saloon Engine BDW	GDS83290	Drive Shaft		38		59.5	34	617					
2.7 TDi (120 kW)	2004.11-2011.03			F	Saloon Engine BSG/CANB	GC099351	Outer Joint		38	29	59.5	34	70	M				
	2004.11-2011.03	MT	L	F	Saloon Engine BSG/CANB	GDS83290	Drive Shaft		38		59.5	34	617					
	2004.11-2011.03	MT	R	F	Saloon Engine BSG/CANB	GDS83329	Drive Shaft		38		59.5	34	655					
2.7 TDi (132 kW)	2004.10-2007.11			F	Saloon Engine BPP	GC099351	Outer Joint		38	29	59.5	34	70	M				





		TRANSM	L/R	F/R		G-AP Ref.	PRODUCT	ABS	Technical Specifications											
									YEAR	A	B	C	H	L	P					
<b>AUDI</b>																				
<b>A6 (4F2, C6)</b>																				
2.7 TDi (132 kW)	2004.10-	2007.11	MT	L	F	Saloon Engine BPP	GDS83290	Drive Shaft	38		59.5	34	617							
	2004.10-	2007.11	MT	R	F	Saloon Engine BPP	GDS83329	Drive Shaft	38		59.5	34	655							
2.7 TDi (140 kW)	2008.10-	2011.03			F	Saloon Engine CANA	GC099351	Outer Joint	38	29	59.5	34	70	M						
2.7 TDi Quattro (120 kW)	2005.06-	2011.03	AT	L	F	Saloon Engine BSG/CAND	GDS83306	Drive Shaft	38		59.5	34	525							
	2005.06-	2011.03				Saloon Engine BSG/CAND	GC083099	Outer Joint	38	27	59.5	34.5	64	M						
2.7 TDi Quattro (132 kW)	2004.11-	2008.10	AT	L	F	Saloon Engine BPP	GDS83306	Drive Shaft	38		59.5	34	525							
	2004.11-	2008.10				Saloon Engine BPP	GC083099	Outer Joint	38	27	59.5	34.5	64	M						
2.7 TDi Quattro (140 kW)	2008.10-	2011.03		L	F	Saloon Engine CANC	GDS83306	Drive Shaft	38		59.5	34	525							
	2008.10-	2011.03				Saloon Engine CANC	GC083099	Outer Joint	38	27	59.5	34.5	64	M						
2.8 FSi (140 kW)	2008.10-	2011.03			F	Saloon Engine CCDA	GC083077	Outer Joint	38	27	59.5	34	63	M						
	2008.10-	2011.03	MT	L	F	Saloon Engine CCDA	GDS83290	Drive Shaft	38		59.5	34	617							
	2008.10-	2011.03		L	F	Saloon Engine CCDA	GDS83271	Drive Shaft	38		59.5	34	548							
	2008.10-	2011.03	MT	R	F	Saloon Engine CCDA	GDS83329	Drive Shaft	38		59.5	34	655							
	2008.10-	2011.03				Saloon Engine CCDA	GC083099	Outer Joint	38	27	59.5	34.5	64	M						
2.8 FSi (154 kW)	2006.11-	2008.10			F	Saloon Engine BDX	GC083077	Outer Joint	38	27	59.5	34	63	M						
	2006.11-	2008.10	MT	L	F	Saloon Engine BDX	GDS83290	Drive Shaft	38		59.5	34	617							
	2006.11-	2008.10		L	F	Saloon Engine BDX	GDS83271	Drive Shaft	38		59.5	34	548							
	2006.11-	2008.10	MT	R	F	Saloon Engine BDX	GDS83329	Drive Shaft	38		59.5	34	655							
	2006.11-	2008.10				Saloon Engine BDX	GC083099	Outer Joint	38	27	59.5	34.5	64	M						
2.8 FSi (162 kW)	2008.10-	2011.03			F	Saloon Engine CCEA	GC083077	Outer Joint	38	27	59.5	34	63	M						
	2008.10-	2011.03		L	F	Saloon Engine CCEA	GDS83271	Drive Shaft	38		59.5	34	548							
	2008.10-	2011.03				Saloon Engine CCEA	GC083099	Outer Joint	38	27	59.5	34.5	64	M						
2.8 FSi Quattro (140 kW)	2008.10-	2011.03	AT	L	F	Saloon Engine CCDA	GDS83306	Drive Shaft	38		59.5	34	525							
	2008.10-	2011.03	MT	L	F	Saloon Engine CCDA	GDS83290	Drive Shaft	38		59.5	34	617							
	2008.10-	2011.03	MT	R	F	Saloon Engine CCDA	GDS83329	Drive Shaft	38		59.5	34	655							
	2008.10-	2011.03				Saloon Engine CCDA	GC083099	Outer Joint	38	27	59.5	34.5	64	M						
2.8 FSi Quattro (154 kW)	2007.06-	2008.10	AT	L	F	Saloon Engine BDX	GDS83306	Drive Shaft	38		59.5	34	525							
	2007.06-	2008.10	MT	L	F	Saloon Engine BDX	GDS83290	Drive Shaft	38		59.5	34	617							
	2007.06-	2008.10	MT	R	F	Saloon Engine BDX	GDS83329	Drive Shaft	38		59.5	34	655							
	2007.06-	2008.10				Saloon Engine BDX	GC083099	Outer Joint	38	27	59.5	34.5	64	M						
2.8 FSi Quattro (162 kW)	2008.10-	2011.03	CVT	L	F	Saloon Engine CCEA	GDS83306	Drive Shaft	38		59.5	34	525							
	2008.10-	2011.03				Saloon Engine CCEA	GC083099	Outer Joint	38	27	59.5	34.5	64	M						
3.0 Quattro (160 kW)	2004.05-	2006.05	AT	L	F	Saloon Engine BBJ	GDS83306	Drive Shaft	38		59.5	34	525							
	2004.05-	2006.05				Saloon Engine BBJ	GC083099	Outer Joint	38	27	59.5	34.5	64	M						
	2004.05-	2011.03	CVT	L	F	Saloon Engine BNG/CDYB	GDS83306	Drive Shaft	38		59.5	34	525							
	2004.05-	2011.03				Saloon Engine BNG/CDYB	GC083099	Outer Joint	38	27	59.5	34.5	64	M						
3.0 TDi Quattro (155 kW)	2004.05-	2006.05	CVT	L	F	Saloon Engine BMK	GDS83306	Drive Shaft	38		59.5	34	525							
	2004.05-	2006.05		L	F	Saloon Engine BMK	GDS83290	Drive Shaft	38		59.5	34	617							
	2004.05-	2006.05	MT	R	F	Saloon Engine BMK	GDS83329	Drive Shaft	38		59.5	34	655							
	2004.05-	2006.05				Saloon Engine BMK	GC083099	Outer Joint	38	27	59.5	34.5	64	M						
3.0 TDi Quattro (171 kW)	2006.05-	2007.11	CVT	L	F	Saloon Engine ASB	GDS83306	Drive Shaft	38		59.5	34	525							
	2006.05-	2007.11		L	F	Saloon Engine ASB	GDS83290	Drive Shaft	38		59.5	34	617							
	2006.05-	2007.11		R	F	Saloon Engine ASB	GDS83329	Drive Shaft	38		59.5	34	655							
	2006.05-	2007.11				Saloon Engine ASB	GC083099	Outer Joint	38	27	59.5	34.5	64	M						
3.0 TDi Quattro (176 kW)	2008.10-	2011.03	CVT	L	F	Saloon Engine CDYA/CDYC	GDS83306	Drive Shaft	38		59.5	34	525							
	2008.10-	2011.03				Saloon Engine CDYA/CDYC	GC083099	Outer Joint	38	27	59.5	34.5	64	M						
3.0 TFSi Quattro (213 kW)	2008.10-	2011.03	AT	L	F	Saloon Engine CAJA	GDS83306	Drive Shaft	38		59.5	34	525							
	2008.10-	2011.03				Saloon Engine CAJA	GC083099	Outer Joint	38	27	59.5	34.5	64	M						
3.0 TFSi Quattro (220 kW)	2008.10-	2011.03	CVT	L	F	Saloon Engine CCAA	GDS83306	Drive Shaft	38		59.5	34	525							
	2008.10-	2011.03				Saloon Engine CCAA	GC083099	Outer Joint	38	27	59.5	34.5	64	M						
3.2 FSi (188 kW)	2004.05-	2009.05	AT		F	Saloon Engine AUK/BKH	GC083077	Outer Joint	38	27	59.5	34	63	M						
	2004.05-	2009.05	MT	L	F	Saloon Engine AUK/BKH	GDS83290	Drive Shaft	38		59.5	34	617							
	2004.05-	2009.05		L	F	Saloon Engine AUK/BKH	GDS83271	Drive Shaft	38		59.5	34	548							
	2004.05-	2009.05	MT	R	F	Saloon Engine AUK/BKH	GDS83329	Drive Shaft	38		59.5	34	655							
	2004.05-	2009.05				Saloon Engine AUK/BKH	GC083099	Outer Joint	38	27	59.5	34.5	64	M						
3.2 FSi (195 kW)	2009.05-	2011.03		L	F	Saloon Engine CALA	GDS83271	Drive Shaft	38		59.5	34	548							
	2009.05-	2011.03				Saloon Engine CALA	GC083099	Outer Joint	38	27	59.5	34.5	64	M						
3.2 FSi Quattro (188 kW)	2004.05-	2008.10	CVT	L	F	Saloon Engine AUK	GDS83306	Drive Shaft	38		59.5	34	525							
	2004.05-	2008.10	MT	L	F	Saloon Engine AUK	GDS83290	Drive Shaft	38		59.5	34	617							
	2004.05-	2008.10	MT	R	F	Saloon Engine AUK	GDS83329	Drive Shaft	38		59.5	34	655							
	2004.05-	2008.10				Saloon Engine AUK	GC083099	Outer Joint	38	27	59.5	34.5	64	M						
4.2 FSi Quattro (257 kW)	2006.05-	2007.11	AT	L	F	Saloon Engine BVJ	GDS83306	Drive Shaft	38		59.5	34	525							
	2006.05-	2007.11				Saloon Engine BVJ	GC083099	Outer Joint	38	27	59.5	34.5	64	M						





		YEAR	TRANSM	L/R	F/R		G-AP Ref.	PRODUCT	ABS	Technical Specifications						
										A	B	C	H	L	P	
<b>AUDI</b>																
<b>A6 (4F2, C6)</b>																
4.2 Quattro (246 kW)	2004.07-	2006.10	AT	L	F	Saloon Engine BAT	GDS83306	Drive Shaft		38		59.5	34	525		
	2004.07-	2006.10				Saloon Engine BAT	GC083099	Outer Joint	38	27	59.5	34.5	64	M		
5.2 S6 Quattro (320 kW)	2006.03-	2007.11	AT		F	Saloon Engine BXA	GC083099	Outer Joint	38	27	59.5	34.5	64	M		
<b>A6 (4G2, C7)</b>																
2.0 TFSi (132 kW)	2011.05-					Saloon Engine CDNB	GC083103	Outer Joint	42	28	76.4	34	54	I		
2.0 TFSi (155 kW)	2011.03-	2013.05				Saloon Engine CAEB	GC083103	Outer Joint	42	28	76.4	34	54	I		
2.0 TFSi HybrID (155 kW)	2011.11-					Saloon Engine CHJA	GC083103	Outer Joint	42	28	76.4	34	54	I		
2.8 FSi (150 kW)	2011.03-			L/R	F	Saloon Engine CHVA	GC083087	Outer Joint	42	27	76.5	34	54.5	M		
	2011.03-			L/R	F	Saloon Engine CHVA	GDS83317	Drive Shaft	42		76.5	34	490			
	2011.03-			L/R	F	Saloon Engine CHVA	GCI83022	Inner Joint		34		88				
	2011.03-					Saloon Engine CHVA	GC083103	Outer Joint	42	28	76.4	34	54	I		
2.8 FSi Quattro (150 kW)	2011.03-					Saloon Engine CHVA	GC083103	Outer Joint	42	28	76.4	34	54	I		
3.0 TDi Quattro (150 kW)	2011.03-					Saloon Engine CLAA	GC083103	Outer Joint	42	28	76.4	34	54	I		
3.0 TDi Quattro (180 kW)	2011.03-					Saloon Engine CDUC/CDUD/CKVB/CKVC	GC083103	Outer Joint	42	28	76.4	34	54	I		
3.0 TDi Quattro (230 kW)	2011.11-					Saloon Engine CGQB	GC083103	Outer Joint	42	28	76.4	34	54	I		
3.0 TFSi Quattro (228 kW)	2010.11-	2012.05				Saloon Engine CGWB	GC083103	Outer Joint	42	28	76.4	34	54	I		
3.0 TFSi Quattro (228 kW)	2011.03-					Saloon Engine CGWD/CGXB/CTUA	GC083103	Outer Joint	42	28	76.4	34	54	I		
4.0 S6 Quattro (309 kW)	2012.02-					Saloon Engine CEUC	GC083103	Outer Joint	42	28	76.4	34	54	I		
<b>A6 ALLROAD (4FH, C6)</b>																
2.7 TDi Quattro (120 kW)	2006.05-	2011.08	AT	L	F	Estate Engine BSG/CAND	GDS83306	Drive Shaft	38		59.5	34	525			
	2006.05-	2011.08				Estate Engine BSG/CAND	GC083099	Outer Joint	38	27	59.5	34.5	64	M		
2.7 TDi Quattro (132 kW)	2006.05-	2008.10	AT/CVT	L	F	Estate Engine BPP	GDS83306	Drive Shaft	38		59.5	34	525			
	2006.05-	2008.10	AT		F	Estate Engine BPP	GC083099	Outer Joint	38	27	59.5	34.5	64	M		
2.7 TDi Quattro (140 kW)	2008.10-	2011.08	CVT	L	F	Estate Engine CANC	GDS83306	Drive Shaft	38		59.5	34	525			
	2008.10-	2011.08				Estate Engine CANC	GC083099	Outer Joint	38	27	59.5	34.5	64	M		
3.0 TDi Quattro (155 kW)	2006.05-	2011.08	CVT	L	F	Estate Engine BNG/CDYB	GDS83306	Drive Shaft	38		59.5	34	525			
	2006.05-	2011.08				Estate Engine BNG/CDYB	GC083099	Outer Joint	38	27	59.5	34.5	64	M		
3.0 TDi Quattro (171 kW)	2006.05-	2008.10	AT	L	F	Estate Engine ASB	GDS83306	Drive Shaft	38		59.5	34	525			
	2006.05-	2008.10	MT	L	F	Estate Engine ASB	GDS83290	Drive Shaft	38		59.5	34	617			
	2006.05-	2008.10	MT	R	F	Estate Engine ASB	GDS83329	Drive Shaft	38		59.5	34	655			
	2006.05-	2008.10				Estate Engine ASB	GC083099	Outer Joint	38	27	59.5	34.5	64	M		
3.0 TDi Quattro (176 kW)	2008.10-	2011.08	CVT	L	F	Estate Engine CDYA/CDYC	GDS83306	Drive Shaft	38		59.5	34	525			
	2008.10-	2011.08				Estate Engine CDYA/CDYC	GC083099	Outer Joint	38	27	59.5	34.5	64	M		
3.0 TFSi Quattro (213 kW)	2008.10-	2011.08	AT	L	F	Estate Engine CAJA	GDS83306	Drive Shaft	38		59.5	34	525			
	2008.10-	2011.08				Estate Engine CAJA	GC083099	Outer Joint	38	27	59.5	34.5	64	M		
3.2 FSi Quattro (188 kW)	2006.12-	2007.11	CVT	L	F	Estate Engine AUK	GDS83306	Drive Shaft	38		59.5	34	525			
	2006.12-	2007.11	MT	L	F	Estate Engine AUK	GDS83290	Drive Shaft	38		59.5	34	617			
	2006.12-	2007.11	MT	R	F	Estate Engine AUK	GDS83329	Drive Shaft	38		59.5	34	655			
	2006.12-	2007.11				Estate Engine AUK	GC083099	Outer Joint	38	27	59.5	34.5	64	M		
4.2 FSi Quattro (257 kW)	2006.12-	2007.11	AT	L	F	Estate Engine BVJ	GDS83306	Drive Shaft	38		59.5	34	525			
	2006.12-	2007.11				Estate Engine BVJ	GC083099	Outer Joint	38	27	59.5	34.5	64	M		
<b>A6 ALLROAD (4GH)</b>																
3.0 TDi Quattro (150 kW)	2012.01-					Estate Engine CLAA	GC083103	Outer Joint	42	28	76.4	34	54	I		
3.0 TDi Quattro (180 kW)	2012.01-					Estate Engine CDUD/CKVC	GC083103	Outer Joint	42	28	76.4	34	54	I		
3.0 TDi Quattro (230 kW)	2012.01-					Estate Engine CGQB	GC083103	Outer Joint	42	28	76.4	34	54	I		
3.0 TFSi Quattro (228 kW)	2012.01-					Estate Engine CGWD	GC083103	Outer Joint	42	28	76.4	34	54	I		
<b>A6 AVANT (4A, C4)</b>																
2.0 (74 kW)	1994.06-	1997.12	MT/AT		F	Estate Engine AAE	GC083016	Outer Joint	45T	38	30	59.5	34	61	I	
2.0 (85 kW)	1994.06-	1997.12	MT/AT		F	Estate Engine ABK	GC083016	Outer Joint	45T	38	30	59.5	34	61	I	
2.0 16V (103 kW)	1994.06-	1997.12	MT/AT		F	Estate Engine ACE	GC083016	Outer Joint	45T	38	30	59.5	34	61	I	
2.0 16V Quattro (103 kW)	1994.06-	1997.12	MT		F	Estate Engine ACE	GC083016	Outer Joint	45T	38	30	59.5	34	61	I	
	1994.06-	1997.12	MT/AT		R	Estate Engine ACE	GC083014	Outer Joint	45T	38	25	59.5	34.5	61	O	
2.2 S6 Turbo Quattro (169 kW)	1994.06-	1997.12	AT	L	F	Estate Engine AAN	GDS83060	Drive Shaft	45T	38		59.5	34	565		
	1994.06-	1997.12	AT	R	F	Estate Engine AAN	GDS83061	Drive Shaft	45T	38		59.5	34	488		
	1994.06-	1997.12	MT/AT		F	Estate Engine AAN	GC083017	Outer Joint	45T	38	27	59.5	34.5	68.5	I	
	1994.06-	1997.12	AT		R	Estate Engine AAN	GC083014	Outer Joint	45T	38	25	59.5	34.5	61	O	
2.3 (98 kW)	1994.06-	1995.12	MT		F	Estate Engine AAR	GC083016	Outer Joint	45T	38	30	59.5	34	61	I	
2.5 TDi (103 kW)	1994.08-	1997.12	AT	L	F	Estate Engine AEL	GDS83060	Drive Shaft	45T	38		59.5	34	565		
	1994.08-	1997.12	AT	R	F	Estate Engine AEL	GDS83061	Drive Shaft	45T	38		59.5	34	488		
	1994.08-	1997.12	MT/AT		F	Estate Engine AEL	GC083017	Outer Joint	45T	38	27	59.5	34.5	68.5	I	
	1994.08-	1997.12	MT	L	F	Estate Engine AEL	GDS83050	Drive Shaft	45T	38		59.5	34.5	612		
	1994.08-	1997.12	MT	R	F	Estate Engine AEL	GDS83051	Drive Shaft	45T	38		59.5	34.5	647		



		TRANSM	L/R	F/R		G-AP Ref.	PRODUCT	ABS	Technical Specifications						
									YEAR	A	B	C	H	L	P
<b>AUDI</b>															
<b>A6 AVANT (4A, C4)</b>															
2.5 TDi (84 kW)	1995.01-	1997.12	AT	L	F	Estate Engine AAT	GDS83060	Drive Shaft	45T	38		59.5	34	565	
	1995.01-	1997.12	AT	R	F	Estate Engine AAT	GDS83061	Drive Shaft	45T	38		59.5	34	488	
	1995.01-	1997.12	MT/AT		F	Estate Engine AAT	GC083017	Outer Joint	45T	38	27	59.5	34.5	68.5	I
	1995.01-	1997.12	MT	L	F	Estate Engine AAT	GDS83050	Drive Shaft	45T	38		59.5	34.5	612	
	1995.01-	1997.12	MT	R	F	Estate Engine AAT	GDS83051	Drive Shaft	45T	38		59.5	34.5	647	
2.5 TDi (85 kW)	1994.06-	1997.12	AT	L	F	Estate Engine AAT	GDS83060	Drive Shaft	45T	38		59.5	34	565	
	1994.06-	1997.12	AT	R	F	Estate Engine AAT	GDS83061	Drive Shaft	45T	38		59.5	34	488	
	1994.06-	1997.12	MT/AT		F	Estate Engine AAT	GC083017	Outer Joint	45T	38	27	59.5	34.5	68.5	I
	1994.06-	1997.12	MT	L	F	Estate Engine AAT	GDS83050	Drive Shaft	45T	38		59.5	34.5	612	
	1994.06-	1997.12	MT	R	F	Estate Engine AAT	GDS83051	Drive Shaft	45T	38		59.5	34.5	647	
2.6 (110 kW)	1994.06-	1997.12	MT/AT		F	Estate Engine ABC	GC083016	Outer Joint	45T	38	30	59.5	34	61	I
2.6 Quattro (110 kW)	1994.06-	1997.12	MT		F	Estate Engine ABC	GC083016	Outer Joint	45T	38	30	59.5	34	61	I
	1994.06-	1997.12	MT/AT		R	Estate Engine ABC	GC083014	Outer Joint	45T	38	25	59.5	34.5	61	O
2.8 (128 kW)	1994.06-	1997.12	MT	R	F	Estate Engine AAH	GDS83051	Drive Shaft	45T	38		59.5	34.5	647	
	1994.06-	1997.12	AT	L	F	Estate Engine AAH	GDS83060	Drive Shaft	45T	38		59.5	34	565	
	1994.06-	1997.12	AT	R	F	Estate Engine AAH	GDS83061	Drive Shaft	45T	38		59.5	34	488	
	1994.06-	1997.12	MT/AT		F	Estate Engine AAH	GC083017	Outer Joint	45T	38	27	59.5	34.5	68.5	I
	1994.06-	1997.12	MT	L	F	Estate Engine AAH	GDS83050	Drive Shaft	45T	38		59.5	34.5	612	
2.8 Quattro (128 kW)	1994.06-	1997.12	AT	L	F	Estate Engine AEJ/AAH	GDS83060	Drive Shaft	45T	38		59.5	34	565	
	1994.06-	1997.12	AT	R	F	Estate Engine AEJ/AAH	GDS83061	Drive Shaft	45T	38		59.5	34	488	
	1994.06-	1997.12	MT/AT		F	Estate Engine AEJ/AAH	GC083017	Outer Joint	45T	38	27	59.5	34.5	68.5	I
	1994.06-	1997.12	AT		R	Estate Engine AEJ/AAH	GC083014	Outer Joint	45T	38	25	59.5	34.5	61	O
4.2 S6 Plus Quattro (240 kW)	1996.04-	1997.12			F	Estate Engine AHK	GC083017	Outer Joint	45T	38	27	59.5	34.5	68.5	I
4.2 S6 Quattro (213 kW)	1994.06-	1997.12	AT	L	F	Estate Engine AEC	GDS83060	Drive Shaft	45T	38		59.5	34	565	
	1994.06-	1997.12	AT	R	F	Estate Engine AEC	GDS83061	Drive Shaft	45T	38		59.5	34	488	
	1994.06-	1997.12	MT/AT		F	Estate Engine AEC	GC083017	Outer Joint	45T	38	27	59.5	34.5	68.5	I
<b>A6 AVANT (4B5, C5)</b>															
1.8 (92 kW)	1997.12-	2005.01	MT		F	Estate Engine AJP/AQE/ARH	GC083018	Outer Joint	45W	33	30	53	30	62	I
	1997.12-	2005.01	MT		F	Estate Engine AJP/AQE/ARH	GCI83001	Inner Joint				28		32	
	1997.12-	2005.01	MT		F	Estate Engine AJP/AQE/ARH	GC083045	Outer Joint		33	30	53	30	62	I
1.8 T (110 kW)	1997.12-	2005.01	MT		F	Estate Engine AEB/ANB/APU/ARK/AWT	GC083018	Outer Joint	45W	33	30	53	30	62	I
	1997.12-	2005.01	MT		F	Estate Engine AEB/ANB/APU/ARK/AWT	GCI83001	Inner Joint				28		32	
	1997.12-	2005.01	AT	L/R	F	Estate Engine AEB/ANB/APU/ARK/AWT	GDS83066	Drive Shaft	45W	38		59.5	34.5	544	
1.8 T (132 kW)	1997.12-	2005.01	MT		F	Estate Engine AEB/ANB/APU/ARK/AWT	GC083045	Outer Joint		33	30	53	30	62	I
	1999.04-	2005.01	MT		F	Estate Engine AJL	GC083018	Outer Joint	45W	33	30	53	30	62	I
	1999.04-	2005.01		L/R	F	Estate Engine AJL	GCI61033	Inner Joint			34		85		
	1999.04-	2005.01	MT	R	F	Estate Engine AJL	GDS99113	Drive Shaft	45W	38		59.5	34.5	654	
1.8 T Quattro (110 kW)	1999.04-	2005.01	MT		F	Estate Engine AJL	GC083045	Outer Joint		33	30	53	30	62	I
	1997.12-	2005.01			F	Estate Engine AEB/ANB/APU/ARK/AWT	GC083018	Outer Joint	45W	33	30	53	30	62	I
	1997.12-	2005.01	AT	R	F	Estate Engine AEB/ANB/APU/ARK/AWT	GDS83066	Drive Shaft	45W	38		59.5	34.5	544	
1.8 T Quattro (132 kW)	1997.12-	2005.01			F	Estate Engine AEB/ANB/APU/ARK/AWT	GC083045	Outer Joint		33	30	53	30	62	I
	1997.12-	2005.01	MT		F	Estate Engine AJL	GC083018	Outer Joint	45W	33	30	53	30	62	I
	1997.12-	2005.01		L/R	F	Estate Engine AJL	GCI61033	Inner Joint			34		85		
1.9 TDi (81 kW)	1997.12-	2005.01	MT	R	F	Estate Engine AJL	GDS99113	Drive Shaft	45W	38		59.5	34.5	654	
	1997.12-	2005.01	MT		F	Estate Engine AJL	GC083045	Outer Joint		33	30	53	30	62	I
	1998.02-	2001.04		L/R	F	Estate Engine AFN	GCI61033	Inner Joint			34		85		
1.9 TDi (85 kW)	1998.02-	2001.04		R	F	Estate Engine AFN	GDS61076	Drive Shaft	45W	38		59.5	34.5	645	
	2000.07-	2005.01	AT		F	Estate Engine AJM	GC083058	Outer Joint	45W	38	33	59.5	34	55	M
	2000.07-	2005.01	MT/AT		F	Estate Engine AJM	GC083021	Outer Joint	45W	33	27	53	30	63	I
	2000.07-	2005.01	AT	L	F	Estate Engine AJM	GDS83019	Drive Shaft	45W	38		59.5	34.5	550	
	2000.07-	2005.01		L/R	F	Estate Engine AJM	GCI61033	Inner Joint			34		85		
	2000.07-	2005.01	AT	R	F	Estate Engine AJM	GDS83020	Drive Shaft	45W	38		59.5	34.5	522	
	2000.07-	2005.01	MT	R	F	Estate Engine AJM	GDS99113	Drive Shaft	45W	38		59.5	34.5	654	
1.9 TDi (96 kW)	2000.07-	2005.01		R	F	Estate Engine AJM	GDS61076	Drive Shaft	45W	38		59.5	34.5	645	
	2001.08-	2005.01	MT		F	Estate Engine AVF/AWX	GC083019	Outer Joint	45W	38	27	59.5	34.5	63	I
	2001.08-	2005.01	AT	L/R	F	Estate Engine AVF/AWX	GDS83066	Drive Shaft	45W	38		59.5	34.5	544	
	2001.08-	2005.01		L/R	F	Estate Engine AVF/AWX	GCI61033	Inner Joint			34		85		
	2001.08-	2005.01	5MT	R	F	Estate Engine AVF/AWX	GDS99113	Drive Shaft	45W	38		59.5	34.5	654	
2.0 (96 kW)	2001.08-	2005.01	R	F	Estate Engine AVF/AWX	GDS61076	Drive Shaft	45W	38		59.5	34.5	645		
	2001.08-	2005.01	MT		F	Estate Engine ALT	GC083019	Outer Joint	45W	38	27	59.5	34.5	63	I
	2001.08-	2005.01		L/R	F	Estate Engine ALT	GCI61033	Inner Joint			34		85		
2001.08-	2005.01	MT	R	F	Estate Engine ALT	GDS99113	Drive Shaft	45W	38		59.5	34.5	654		





		YEAR	TRANSM	L/R	F/R		G-AP Ref.	PRODUCT	ABS	Technical Specifications									
										A	B	C	H	L	P				
<b>AUDI</b>																			
<b>A6 AVANT (4B5, C5)</b>																			
2.0 (96 kW)	2001.08-	2005.01				Estate Engine ALT	GDS61076	Drive Shaft	45W	38		59.5	34.5	645					
2.4 (100 kW)	1998.07-	2005.01	AT		F	Estate Engine ALW/ARN/ASM	GC083019	Outer Joint	45W	38	27	59.5	34.5	63	I				
	1998.07-	2005.01	AT	L	F	Estate Engine ALW/ARN/ASM	GDS83019	Drive Shaft	45W	38		59.5	34.5	550					
	1998.07-	2005.01		L/R	F	Estate Engine ALW/ARN/ASM	GCI61033	Inner Joint			34		85						
	1998.07-	2005.01	AT	R	F	Estate Engine ALW/ARN/ASM	GDS83020	Drive Shaft	45W	38		59.5	34.5	522					
	1998.07-	2005.01		R	F	Estate Engine ALW/ARN/ASM	GDS61076	Drive Shaft	45W	38		59.5	34.5	645					
2.4 (115 kW)	1997.12-	2005.01	MT		F	Estate Engine APC	GC083019	Outer Joint	45W	38	27	59.5	34.5	63	I				
	1997.12-	2005.01	AT	L	F	Estate Engine APC	GDS83019	Drive Shaft	45W	38		59.5	34.5	550					
	1997.12-	2005.01		L/R	F	Estate Engine APC	GCI61033	Inner Joint			34		85						
	1997.12-	2005.01	AT	R	F	Estate Engine APC	GDS83020	Drive Shaft	45W	38		59.5	34.5	522					
	1997.12-	2005.01	MT	R	F	Estate Engine APC	GDS99113	Drive Shaft	45W	38		59.5	34.5	654					
	1997.12-	2005.01		R	F	Estate Engine APC	GDS61076	Drive Shaft	45W	38		59.5	34.5	645					
2.4 (120 kW)	1997.12-	2005.01			F	Estate Engine AJG/AMM/APZ	GC083020	Outer Joint	45W	38	30	59.5	34	59.5	I				
	1997.12-	2005.01			F	Estate Engine AJG/AMM/APZ	GC083019	Outer Joint	45W	38	27	59.5	34.5	63	I				
	1997.12-	2005.01	AT	L	F	Estate Engine AJG/AMM/APZ	GDS83019	Drive Shaft	45W	38		59.5	34.5	550					
	1997.12-	2005.01		L/R	F	Estate Engine AJG/AMM/APZ	GCI61033	Inner Joint			34		85						
	1997.12-	2005.01	AT	R	F	Estate Engine AJG/AMM/APZ	GDS83020	Drive Shaft	45W	38		59.5	34.5	522					
	1997.12-	2005.01	MT	R	F	Estate Engine AJG/AMM/APZ	GDS99113	Drive Shaft	45W	38		59.5	34.5	654					
	1997.12-	2005.01		R	F	Estate Engine AJG/AMM/APZ	GDS61076	Drive Shaft	45W	38		59.5	34.5	645					
	1997.12-	2005.01			F	Estate Engine AJG/AMM/APZ	GC083049	Outer Joint		38	30	59.5	34	59.5	I				
2.4 (121 kW)	1997.12-	2005.01	MT/AT		F	Estate Engine AGA/ALF/AML/APS/ARJ	GCI83002	Inner Joint			33		32						
	1997.12-	2005.01	MT/AT		F	Estate Engine AGA/ALF/AML/APS/ARJ	GC083020	Outer Joint	45W	38	30	59.5	34	59.5	I				
	1997.12-	2005.01	MT/AT		F	Estate Engine AGA/ALF/AML/APS/ARJ	GC083019	Outer Joint	45W	38	27	59.5	34.5	63	I				
	1997.12-	2005.01	AT	L	F	Estate Engine AGA/ALF/AML/APS/ARJ	GDS83019	Drive Shaft	45W	38		59.5	34.5	550					
	1997.12-	2005.01		L/R	F	Estate Engine AGA/ALF/AML/APS/ARJ	GCI61033	Inner Joint			34		85						
	1997.12-	2005.01	AT	R	F	Estate Engine AGA/ALF/AML/APS/ARJ	GDS83020	Drive Shaft	45W	38		59.5	34.5	522					
	1997.12-	2005.01	MT	R	F	Estate Engine AGA/ALF/AML/APS/ARJ	GDS99113	Drive Shaft	45W	38		59.5	34.5	654					
	1997.12-	2005.01		R	F	Estate Engine AGA/ALF/AML/APS/ARJ	GDS61076	Drive Shaft	45W	38		59.5	34.5	645					
	1997.12-	2005.01	MT/AT		F	Estate Engine AGA/ALF/AML/APS/ARJ	GC083049	Outer Joint		38	30	59.5	34	59.5	I				
2.4 (125 kW)	2001.08-	2005.01	AT	L/R	F	Estate Engine BDV	GDS83066	Drive Shaft	45W	38		59.5	34.5	544					
	2001.08-	2005.01		L/R	F	Estate Engine BDV	GCI61033	Inner Joint			34		85						
	2001.08-	2005.01	MT	R	F	Estate Engine BDV	GDS99113	Drive Shaft	45W	38		59.5	34.5	654					
	2001.08-	2005.01		R	F	Estate Engine BDV	GDS61076	Drive Shaft	45W	38		59.5	34.5	645					
2.4 Quattro (115 kW)	1998.08-	2001.05		L/R	F	Estate Engine APC	GCI61033	Inner Joint			34		85						
	1998.08-	2001.05		R	F	Estate Engine APC	GDS61076	Drive Shaft	45W	38		59.5	34.5	645					
2.4 Quattro (120 kW)	1997.12-	2005.01			F	Estate Engine AJG/APZ	GC083020	Outer Joint	45W	38	30	59.5	34	59.5	I				
	1997.12-	2005.01			F	Estate Engine AJG/APZ	GC083019	Outer Joint	45W	38	27	59.5	34.5	63	I				
	1997.12-	2005.01	AT	L	F	Estate Engine AJG/APZ	GDS83019	Drive Shaft	45W	38		59.5	34.5	550					
	1997.12-	2005.01	AT	R	F	Estate Engine AJG/APZ	GDS83020	Drive Shaft	45W	38		59.5	34.5	522					
	1997.12-	2005.01	MT	R	F	Estate Engine AJG/APZ	GDS99113	Drive Shaft	45W	38		59.5	34.5	654					
	1997.12-	2005.01		R	F	Estate Engine AJG/APZ	GDS61076	Drive Shaft	45W	38		59.5	34.5	645					
2.4 Quattro (121 kW)	1997.12-	2005.01			F	Estate Engine AJG/APZ	GC083049	Outer Joint		38	30	59.5	34	59.5	I				
	1997.12-	2005.01	MT/AT		F	Estate Engine AGA/ALF/AML/APS/ARJ	GC083019	Outer Joint	45W	38	27	59.5	34.5	63	I				
	1997.12-	2005.01	AT	L	F	Estate Engine AGA/ALF/AML/APS/ARJ	GDS83019	Drive Shaft	45W	38		59.5	34.5	550					
	1997.12-	2005.01		L/R	F	Estate Engine AGA/ALF/AML/APS/ARJ	GCI61033	Inner Joint			34		85						
	1997.12-	2005.01	AT	R	F	Estate Engine AGA/ALF/AML/APS/ARJ	GDS83020	Drive Shaft	45W	38		59.5	34.5	522					
	1997.12-	2005.01	MT	R	F	Estate Engine AGA/ALF/AML/APS/ARJ	GDS99113	Drive Shaft	45W	38		59.5	34.5	654					
2.4 Quattro (125 kW)	1997.12-	2005.01		R	F	Estate Engine AGA/ALF/AML/APS/ARJ	GDS61076	Drive Shaft	45W	38		59.5	34.5	645					
	2001.08-	2005.01	AT	L/R	F	Estate Engine BDV	GDS83066	Drive Shaft	45W	38		59.5	34.5	544					
	2001.08-	2005.01		L/R	F	Estate Engine BDV	GCI61033	Inner Joint			34		85						
	2001.08-	2005.01	MT	R	F	Estate Engine BDV	GDS99113	Drive Shaft	45W	38		59.5	34.5	654					
	2001.08-	2005.01		R	F	Estate Engine BDV	GDS61076	Drive Shaft	45W	38		59.5	34.5	645					
2.5 TDi (110 kW)	1997.12-	2005.01	MT/AT		F	Estate Engine AFB/AKN	GC083019	Outer Joint	45W	38	27	59.5	34.5	63	I				
	1997.12-	2005.01	AT	L	F	Estate Engine AFB/AKN	GDS83019	Drive Shaft	45W	38		59.5	34.5	550					
	1997.12-	2005.01		L/R	F	Estate Engine AFB/AKN	GCI61033	Inner Joint			34		85						
	1997.12-	2005.01	AT	R	F	Estate Engine AFB/AKN	GDS83020	Drive Shaft	45W	38		59.5	34.5	522					
	1997.12-	2005.01	MT	R	F	Estate Engine AFB/AKN	GDS99113	Drive Shaft	45W	38		59.5	34.5	654					
	1997.12-	2005.01		R	F	Estate Engine AFB/AKN	GDS61076	Drive Shaft	45W	38		59.5	34.5	645					
2.5 TDi (114 kW)	2001.08-	2005.01			F	Estate Engine AYM	GC083019	Outer Joint	45W	38	27	59.5	34.5	63	I				
	2001.08-	2005.01	CVT	L/R	F	Estate Engine AYM	GDS83066	Drive Shaft	45W	38		59.5	34.5	544					
	2001.08-	2005.01		L/R	F	Estate Engine AYM	GCI61033	Inner Joint			34		85						
	2001.08-	2005.01	MT	R	F	Estate Engine AYM	GDS99113	Drive Shaft	45W	38		59.5	34.5	654					
	2001.08-	2005.01		R	F	Estate Engine AYM	GDS61076	Drive Shaft	45W	38		59.5	34.5	645					





		YEAR	TRANSM	L/R	F/R		G-AP Ref.	PRODUCT	ABS	Technical Specifications										
										A	B	C	H	L	P					
<b>AUDI</b>																				
<b>A6 AVANT (4B5, C5)</b>																				
2.5 TDi (120 kW)	2002.07-	2005.01			F	Estate Engine BCZ/BDG/BFC	GC083019	Outer Joint	45W	38	27	59.5	34.5	63	I					
	2002.07-	2005.01	CVT	L/R	F	Estate Engine BCZ/BDG/BFC	GDS83066	Drive Shaft	45W	38		59.5	34.5	544						
	2002.07-	2005.01		L/R	F	Estate Engine BCZ/BDG/BFC	GCI61033	Inner Joint			34		85							
	2002.07-	2005.01		R	F	Estate Engine BCZ/BDG/BFC	GDS61076	Drive Shaft	45W	38		59.5	34.5	645						
2.5 TDi (132 kW)	2000.02-	2005.01	MT		F	Estate Engine AKE/BAU/BDH	GC083019	Outer Joint	45W	38	27	59.5	34.5	63	I					
	2000.02-	2005.01	CVT	L/R	F	Estate Engine AKE/BAU/BDH	GDS83066	Drive Shaft	45W	38		59.5	34.5	544						
	2000.02-	2005.01		L/R	F	Estate Engine AKE/BAU/BDH	GCI61033	Inner Joint			34		85							
	2000.02-	2005.01	AT	R	F	Estate Engine AKE/BAU/BDH	GDS83020	Drive Shaft	45W	38		59.5	34.5	522						
	2000.02-	2005.01		R	F	Estate Engine AKE/BAU/BDH	GDS61076	Drive Shaft	45W	38		59.5	34.5	645						
2.5 TDi Quattro (110 kW)	1997.12-	2005.01	MT/AT		F	Estate Engine AFB/AKN	GC083019	Outer Joint	45W	38	27	59.5	34.5	63	I					
	1997.12-	2005.01	AT	L	F	Estate Engine AFB/AKN	GDS83019	Drive Shaft	45W	38		59.5	34.5	550						
	1997.12-	2005.01		L/R	F	Estate Engine AFB/AKN	GCI61033	Inner Joint			34		85							
	1997.12-	2005.01	AT	R	F	Estate Engine AFB/AKN	GDS83020	Drive Shaft	45W	38		59.5	34.5	522						
	1997.12-	2005.01	MT	R	F	Estate Engine AFB/AKN	GDS99113	Drive Shaft	45W	38		59.5	34.5	654						
	1997.12-	2005.01		R	F	Estate Engine AFB/AKN	GDS61076	Drive Shaft	45W	38		59.5	34.5	645						
2.5 TDi Quattro (132 kW)	2000.02-	2005.01	MT		F	Estate Engine AKE/BAU/BDH	GC083019	Outer Joint	45W	38	27	59.5	34.5	63	I					
	2000.02-	2005.01	AT	L	F	Estate Engine AKE/BAU/BDH	GDS83019	Drive Shaft	45W	38		59.5	34.5	550						
	2000.02-	2005.01		L/R	F	Estate Engine AKE/BAU/BDH	GCI61033	Inner Joint			34		85							
	2000.02-	2005.01	AT	R	F	Estate Engine AKE/BAU/BDH	GDS83020	Drive Shaft	45W	38		59.5	34.5	522						
	2000.02-	2005.01	MT	R	F	Estate Engine AKE/BAU/BDH	GDS99113	Drive Shaft	45W	38		59.5	34.5	654						
	2000.02-	2005.01		R	F	Estate Engine AKE/BAU/BDH	GDS61076	Drive Shaft	45W	38		59.5	34.5	645						
2.7 T (169 kW)	1999.02-	2005.01	MT		F	Estate Engine AJK	GC083019	Outer Joint	45W	38	27	59.5	34.5	63	I					
	1999.02-	2005.01		L/R	F	Estate Engine AJK	GCI61033	Inner Joint			34		85							
	1999.02-	2005.01	MT	R	F	Estate Engine AJK	GDS99113	Drive Shaft	45W	38		59.5	34.5	654						
	1999.02-	2005.01		R	F	Estate Engine AJK	GDS61076	Drive Shaft	45W	38		59.5	34.5	645						
2.7 T Quattro (169 kW)	1997.12-	2005.01	MT		F	Estate Engine AJK/AZA	GC083019	Outer Joint	45W	38	27	59.5	34.5	63	I					
	1997.12-	2005.01		L/R	F	Estate Engine AJK/AZA	GCI61033	Inner Joint			34		85							
	1997.12-	2005.01	MT	R	F	Estate Engine AJK/AZA	GDS99113	Drive Shaft	45W	38		59.5	34.5	654						
	1997.12-	2005.01		R	F	Estate Engine AJK/AZA	GDS61076	Drive Shaft	45W	38		59.5	34.5	645						
2.7 T Quattro (184 kW)	2001.08-	2005.01			F	Estate Engine ARE/BES	GC083019	Outer Joint	45W	38	27	59.5	34.5	63	I					
	2001.08-	2005.01		R	F	Estate Engine ARE/BES	GDS61076	Drive Shaft	45W	38		59.5	34.5	645						
2.8 (140 kW)	1999.07-	2005.01			F	Estate Engine ATX	GC083033	Outer Joint		36	30	53	78.5	51	I					
	1999.07-	2005.01	AT	L	F	Estate Engine ATX	GDS83019	Drive Shaft	45W	38		59.5	34.5	550						
	1999.07-	2005.01	AT	R	F	Estate Engine ATX	GDS83020	Drive Shaft	45W	38		59.5	34.5	522						
	1999.07-	2005.01	MT	R	F	Estate Engine ATX	GDS99113	Drive Shaft	45W	38		59.5	34.5	654						
	1999.07-	2005.01		R	F	Estate Engine ATX	GDS61076	Drive Shaft	45W	38		59.5	34.5	645						
2.8 (142 kW)	1997.12-	2005.01	MT/AT		F	Estate Engine ACK/AHA/ALG/AMX/APR/AQD	GCI83002	Inner Joint			33		32							
	1997.12-	2005.01	MT/AT		F	Estate Engine ACK/AHA/ALG/AMX/APR/AQD	GC083020	Outer Joint	45W	38	30	59.5	34	59.5	I					
	1997.12-	2005.01	MT/AT		F	Estate Engine ACK/AHA/ALG/AMX/APR/AQD	GC083019	Outer Joint	45W	38	27	59.5	34.5	63	I					
	1997.12-	2005.01	AT	L	F	Estate Engine ACK/AHA/ALG/AMX/APR/AQD	GDS83019	Drive Shaft	45W	38		59.5	34.5	550						
	1997.12-	2005.01		L/R	F	Estate Engine ACK/AHA/ALG/AMX/APR/AQD	GCI61033	Inner Joint			34		85							
	1997.12-	2005.01	AT	R	F	Estate Engine ACK/AHA/ALG/AMX/APR/AQD	GDS83020	Drive Shaft	45W	38		59.5	34.5	522						
	1997.12-	2005.01	MT	R	F	Estate Engine ACK/AHA/ALG/AMX/APR/AQD	GDS99113	Drive Shaft	45W	38		59.5	34.5	654						
	1997.12-	2005.01		R	F	Estate Engine ACK/AHA/ALG/AMX/APR/AQD	GDS61076	Drive Shaft	45W	38		59.5	34.5	645						
	1997.12-	2005.01	MT/AT		F	Estate Engine ACK/AHA/ALG/AMX/APR/AQD	GC083049	Outer Joint		38	30	59.5	34	59.5	I					
2.8 Quattro (142 kW)	1997.12-	2005.01		R	F	Estate Engine ACK/AHA/ALG/AMX/APR/AQD	GDS61076	Drive Shaft	45W	38		59.5	34.5	645						
	1997.12-	2005.01	MT/AT		F	Estate Engine ACK/AHA/ALG/AMX/APR/AQD	GC083019	Outer Joint	45W	38	27	59.5	34.5	63	I					
	1997.12-	2005.01	AT	L	F	Estate Engine ACK/AHA/ALG/AMX/APR/AQD	GDS83019	Drive Shaft	45W	38		59.5	34.5	550						
	1997.12-	2005.01		L/R	F	Estate Engine ACK/AHA/ALG/AMX/APR/AQD	GCI61033	Inner Joint			34		85							
	1997.12-	2005.01	AT	R	F	Estate Engine ACK/AHA/ALG/AMX/APR/AQD	GDS83020	Drive Shaft	45W	38		59.5	34.5	522						
	1997.12-	2005.01	MT	R	F	Estate Engine ACK/AHA/ALG/AMX/APR/AQD	GDS99113	Drive Shaft	45W	38		59.5	34.5	654						
3.0 (162 kW)	2001.08-	2005.01			F	Estate Engine ASN	GC083019	Outer Joint	45W	38	27	59.5	34.5	63	I					
	2001.08-	2005.01	AT	L/R	F	Estate Engine ASN	GDS83066	Drive Shaft	45W	38		59.5	34.5	544						
	2001.08-	2005.01		L/R	F	Estate Engine ASN	GCI61033	Inner Joint			34		85							
	2001.08-	2005.01	MT	R	F	Estate Engine ASN	GDS99113	Drive Shaft	45W	38		59.5	34.5	654						
3.0 Quattro (162 kW)	2001.08-	2005.01			F	Estate Engine ASN	GC083019	Outer Joint	45W	38	27	59.5	34.5	63	I					
	2001.08-	2005.01	AT	L/R	F	Estate Engine ASN	GDS83066	Drive Shaft	45W	38		59.5	34.5	544						
	2001.08-	2005.01		L/R	F	Estate Engine ASN	GCI61033	Inner Joint			34		85							
	2001.08-	2005.01	MT	R	F	Estate Engine ASN	GDS99113	Drive Shaft	45W	38		59.5	34.5	654						
4.2 Quattro (220 kW)	1998.11-	2005.01			F	Estate Engine ARS/ASG/AWN	GC083019	Outer Joint	45W	38	27	59.5	34.5	63	I					
	1998.11-	2005.01	AT	L	F	Estate Engine ARS/ASG/AWN	GDS83066	Drive Shaft	45W	38		59.5	34.5	544						
4.2 RS6 plus Quattro (353 kW)	2004.04-	2005.01			F	Estate Engine BRV	GC083019	Outer Joint	45W	38	27	59.5	34.5	63	I					
	2004.04-	2005.01		L	F	Estate Engine BRV	GDS83066	Drive Shaft	45W	38		59.5	34.5	544						



		TRANSM	L/R	F/R		G-AP Ref.	PRODUCT	ABS	Technical Specifications									
									YEAR	A	B	C	H	L	P			
<b>AUDI</b>																		
<b>A6 AVANT (4B5, C5)</b>																		
4.2 RS6 Quattro (331 kW)	2002.07-	2005.01			F	Estate Engine BCY	GC083019	Outer Joint	45W	38	27	59.5	34.5	63	I			
	2002.07-	2005.01		L	F	Estate Engine BCY	GDS83066	Drive Shaft	45W	38		59.5	34.5	544				
4.2 S6 Quattro (250 kW)	1999.09-	2005.01	MT		F	Estate Engine ANK/AQJ	GC083019	Outer Joint	45W	38	27	59.5	34.5	63	I			
	1999.09-	2005.01	AT	L	F	Estate Engine ANK/AQJ	GDS83066	Drive Shaft	45W	38		59.5	34.5	544				
<b>A6 AVANT (4F5, C6)</b>																		
2.0 TDi (100 kW)	2005.06-	2011.08			F	Estate Engine BNA/BRF/CAGB	GC083077	Outer Joint		38	27	59.5	34	63	M			
	2005.06-	2011.08	MT	L	F	Estate Engine BNA/BRF/CAGB	GDS83290	Drive Shaft		38		59.5	34	617				
	2005.06-	2011.08	AT	R	F	Estate Engine BNA/BRF/CAGB	GDS83292	Drive Shaft		38		59.5	34.5	483				
	2005.06-	2011.08	MT	R	F	Estate Engine BNA/BRF/CAGB	GDS83329	Drive Shaft		38		59.5	34	655				
	2005.06-	2011.08				Estate Engine BNA/BRF/CAGB	GC083099	Outer Joint		38	27	59.5	34.5	64	M			
2.0 TDi (103 kW)	2005.06-	2007.11			F	Estate Engine BLB/BRE	GC083077	Outer Joint		38	27	59.5	34	63	M			
	2005.06-	2007.11	MT	L	F	Estate Engine BLB/BRE	GDS83290	Drive Shaft		38		59.5	34	617				
	2005.06-	2007.11	AT	R	F	Estate Engine BLB/BRE	GDS83292	Drive Shaft		38		59.5	34.5	483				
	2005.06-	2007.11	MT	R	F	Estate Engine BLB/BRE	GDS83329	Drive Shaft		38		59.5	34	655				
	2005.06-	2007.11				Estate Engine BLB/BRE	GC083099	Outer Joint		38	27	59.5	34.5	64	M			
2.0 TDi (125 kW)	2008.10-	2011.08			F	Estate Engine CAHA	GC083077	Outer Joint		38	27	59.5	34	63	M			
	2008.10-	2011.08	MT	L	F	Estate Engine CAHA	GDS83290	Drive Shaft		38		59.5	34	617				
	2008.10-	2011.08	AT	R	F	Estate Engine CAHA	GDS83292	Drive Shaft		38		59.5	34.5	483				
	2008.10-	2011.08	MT	R	F	Estate Engine CAHA	GDS83329	Drive Shaft		38		59.5	34	655				
	2008.10-	2011.08				Estate Engine CAHA	GC083099	Outer Joint		38	27	59.5	34.5	64	M			
2.0 TDi (89 kW)	2005.09-	2006.06	MT	L	F	Estate Engine BVG	GDS83290	Drive Shaft		38		59.5	34	617				
	2005.09-	2006.06	AT	R	F	Estate Engine BVG	GDS83292	Drive Shaft		38		59.5	34.5	483				
	2005.09-	2006.06	MT	R	F	Estate Engine BVG	GDS83329	Drive Shaft		38		59.5	34	655				
	2005.09-	2006.06				Estate Engine BVG	GC083099	Outer Joint		38	27	59.5	34.5	64	M			
2.0 TFSi (125 kW)	2005.06-	2007.11			F	Estate Engine BPJ	GC083077	Outer Joint		38	27	59.5	34	63	M			
	2005.06-	2007.11	MT	L	F	Estate Engine BPJ	GDS83290	Drive Shaft		38		59.5	34	617				
	2005.06-	2007.11		L	F	Estate Engine BPJ	GDS83271	Drive Shaft		38		59.5	34	548				
	2005.06-	2007.11	MT	R	F	Estate Engine BPJ	GDS83329	Drive Shaft		38		59.5	34	655				
	2005.06-	2007.11				Estate Engine BPJ	GC083099	Outer Joint		38	27	59.5	34.5	64	M			
2.4 (130 kW)	2005.03-	2008.10			F	Estate Engine BDW	GC083077	Outer Joint		38	27	59.5	34	63	M			
	2005.03-	2008.10	MT	L	F	Estate Engine BDW	GDS83290	Drive Shaft		38		59.5	34	617				
	2005.03-	2008.10		L	F	Estate Engine BDW	GDS83271	Drive Shaft		38		59.5	34	548				
	2005.03-	2008.10	MT	R	F	Estate Engine BDW	GDS83329	Drive Shaft		38		59.5	34	655				
	2005.03-	2008.10				Estate Engine BDW	GC018250	Outer Joint		31	27	68.3	97	61	I			
2.4 Quattro (130 kW)	2005.03-	2008.10	CVT	L	F	Estate Engine BDW	GDS83306	Drive Shaft		38		59.5	34	525				
	2005.03-	2008.10	MT	L	F	Estate Engine BDW	GDS83290	Drive Shaft		38		59.5	34	617				
	2005.03-	2008.10	MT	R	F	Estate Engine BDW	GDS83329	Drive Shaft		38		59.5	34	655				
	2005.03-	2008.10				Estate Engine BDW	GC083099	Outer Joint		38	27	59.5	34.5	64	M			
2.7 TDi (120 kW)	2005.03-	2011.08			F	Estate Engine BSG/CANB	GC099351	Outer Joint		38	29	59.5	34	70	M			
	2005.03-	2011.08	MT	L	F	Estate Engine BSG/CANB	GDS83290	Drive Shaft		38		59.5	34	617				
	2005.03-	2011.08	MT	R	F	Estate Engine BSG/CANB	GDS83329	Drive Shaft		38		59.5	34	655				
2.7 TDi (132 kW)	2005.03-	2008.10			F	Estate Engine BPP	GC099351	Outer Joint		38	29	59.5	34	70	M			
	2005.03-	2008.10				Estate Engine BPP	GC083099	Outer Joint		38	27	59.5	34.5	64	M			
2.7 TDi (140 kW)	2008.10-	2011.08			F	Estate Engine CANA	GC099351	Outer Joint		38	29	59.5	34	70	M			
	2008.10-	2011.08				Estate Engine CANA	GC083099	Outer Joint		38	27	59.5	34.5	64	M			
2.7 TDi Quattro (120 kW)	2005.06-	2011.08	AT	L	F	Estate Engine BSG/CAND	GDS83306	Drive Shaft		38		59.5	34	525				
	2005.06-	2011.08				Estate Engine BSG/CAND	GC083099	Outer Joint		38	27	59.5	34.5	64	M			
2.7 TDi Quattro (132 kW)	2005.03-	2008.10	AT	L	F	Estate Engine BPP	GDS83306	Drive Shaft		38		59.5	34	525				
	2005.03-	2008.10				Estate Engine BPP	GC083099	Outer Joint		38	27	59.5	34.5	64	M			
2.7 TDi Quattro (140 kW)	2008.10-	2011.08	CVT	L	F	Estate Engine CANC	GDS83306	Drive Shaft		38		59.5	34	525				
	2008.10-	2011.08				Estate Engine CANC	GC083099	Outer Joint		38	27	59.5	34.5	64	M			
2.8 FSi (140 kW)	2008.10-	2011.08			F	Estate Engine CCDA	GC083077	Outer Joint		38	27	59.5	34	63	M			
	2008.10-	2011.08	MT	L	F	Estate Engine CCDA	GDS83290	Drive Shaft		38		59.5	34	617				
	2008.10-	2011.08	MT	R	F	Estate Engine CCDA	GDS83329	Drive Shaft		38		59.5	34	655				
	2008.10-	2011.08				Estate Engine CCDA	GC083099	Outer Joint		38	27	59.5	34.5	64	M			
2.8 FSi (154 kW)	2006.11-	2008.10			F	Estate Engine BDX	GC083077	Outer Joint		38	27	59.5	34	63	M			
	2006.11-	2008.10	MT	L	F	Estate Engine BDX	GDS83290	Drive Shaft		38		59.5	34	617				
	2006.11-	2008.10		L	F	Estate Engine BDX	GDS83271	Drive Shaft		38		59.5	34	548				
	2006.11-	2008.10	MT	R	F	Estate Engine BDX	GDS83329	Drive Shaft		38		59.5	34	655				
	2006.11-	2008.10				Estate Engine BDX	GC083099	Outer Joint		38	27	59.5	34.5	64	M			
2.8 FSi (162 kW)	2008.10-	2011.08			F	Estate Engine CCEA	GC083077	Outer Joint		38	27	59.5	34	63	M			
	2008.10-	2011.08		L	F	Estate Engine CCEA	GDS83271	Drive Shaft		38		59.5	34	548				





		YEAR	TRANSM	L/R	F/R		G-AP Ref.	PRODUCT	ABS	Technical Specifications						
										A	B	C	H	L	P	
<b>AUDI</b>																
<b>A6 AVANT (4F5, C6)</b>																
2.8 FSi (162 kW)	2008.10-	2011.08				Estate Engine CCEA	GC083099	Outer Joint		38	27	59.5	34.5	64	M	
2.8 FSi Quattro (140 kW)	2008.10-	2011.08	CVT	L	F	Estate Engine CCDA	GDS83306	Drive Shaft		38		59.5	34	525		
	2008.10-	2011.08				Estate Engine CCDA	GC083099	Outer Joint		38	27	59.5	34.5	64	M	
2.8 FSi Quattro (154 kW)	2007.06-	2008.10	CVT	L	F	Estate Engine BDX	GDS83306	Drive Shaft		38		59.5	34	525		
	2007.06-	2008.10				Estate Engine BDX	GC083099	Outer Joint		38	27	59.5	34.5	64	M	
2.8 FSi Quattro (162 kW)	2008.10-	2011.08	CVT	L	F	Estate Engine CCEA	GDS83306	Drive Shaft		38		59.5	34	525		
	2008.10-	2011.08				Estate Engine CCEA	GC083099	Outer Joint		38	27	59.5	34.5	64	M	
3.0 (160 kW)	2005.03-	2006.05		L	F	Estate Engine BBJ	GDS83271	Drive Shaft		38		59.5	34	548		
	2005.03-	2006.05				Estate Engine BBJ	GC083099	Outer Joint		38	27	59.5	34.5	64	M	
3.0 Quattro (160 kW)	2005.03-	2006.05	AT	L	F	Estate Engine BBJ	GDS83306	Drive Shaft		38		59.5	34	525		
	2005.03-	2006.05				Estate Engine BBJ	GC083099	Outer Joint		38	27	59.5	34.5	64	M	
3.0 TDi Quattro (155 kW)	2005.03-	2011.08	CVT	L	F	Estate Engine BNG/CDYB	GDS83306	Drive Shaft		38		59.5	34	525		
	2005.03-	2011.08				Estate Engine BNG/CDYB	GC083099	Outer Joint		38	27	59.5	34.5	64	M	
3.0 TDi Quattro (165 kW)	2005.03-	2006.05	CVT	L	F	Estate Engine BMK	GDS83306	Drive Shaft		38		59.5	34	525		
	2005.03-	2006.05				Estate Engine BMK	GC083099	Outer Joint		38	27	59.5	34.5	64	M	
3.0 TDi Quattro (171 kW)	2006.05-	2007.11	CVT	L	F	Estate Engine ASB	GDS83306	Drive Shaft		38		59.5	34	525		
	2006.05-	2007.11		L	F	Estate Engine ASB	GDS83290	Drive Shaft		38		59.5	34	617		
	2006.05-	2007.11		R	F	Estate Engine ASB	GDS83329	Drive Shaft		38		59.5	34	655		
	2006.05-	2007.11				Estate Engine ASB	GC083099	Outer Joint		38	27	59.5	34.5	64	M	
3.0 TDi Quattro (176 kW)	2008.10-	2011.08	CVT	L	F	Estate Engine CDYA/CDYC	GDS83306	Drive Shaft		38		59.5	34	525		
	2008.10-	2011.08				Estate Engine CDYA/CDYC	GC083099	Outer Joint		38	27	59.5	34.5	64	M	
3.0 TFSi Quattro (213 kW)	2008.10-	2011.08	AT	L	F	Estate Engine CAJA	GDS83306	Drive Shaft		38		59.5	34	525		
	2008.10-	2011.08				Estate Engine CAJA	GC083099	Outer Joint		38	27	59.5	34.5	64	M	
3.0 TFSi Quattro (220 kW)	2008.10-	2011.08	CVT	L	F	Estate Engine CCAA	GDS83306	Drive Shaft		38		59.5	34	525		
	2008.10-	2011.08				Estate Engine CCAA	GC083099	Outer Joint		38	27	59.5	34.5	64	M	
3.2 FSi (188 kW)	2005.03-	2008.10	AT		F	Estate Engine AUK	GC083077	Outer Joint		38	27	59.5	34	63	M	
	2005.03-	2008.10	MT	L	F	Estate Engine AUK	GDS83290	Drive Shaft		38		59.5	34	617		
	2005.03-	2008.10		L	F	Estate Engine AUK	GDS83271	Drive Shaft		38		59.5	34	548		
	2005.03-	2008.10	MT	R	F	Estate Engine AUK	GDS83329	Drive Shaft		38		59.5	34	655		
	2005.03-	2008.10				Estate Engine AUK	GC083099	Outer Joint		38	27	59.5	34.5	64	M	
3.2 FSi Quattro (188 kW)	2005.03-	2008.10	CVT	L	F	Estate Engine AUK	GDS83306	Drive Shaft		38		59.5	34	525		
	2005.03-	2008.10	MT	L	F	Estate Engine AUK	GDS83290	Drive Shaft		38		59.5	34	617		
	2005.03-	2008.10	MT	R	F	Estate Engine AUK	GDS83329	Drive Shaft		38		59.5	34	655		
	2005.03-	2008.10				Estate Engine AUK	GC083099	Outer Joint		38	27	59.5	34.5	64	M	
4.2 FSi Quattro (257 kW)	2006.05-	2007.11	AT	L	F	Estate Engine BVJ	GDS83306	Drive Shaft		38		59.5	34	525		
	2006.05-	2007.11				Estate Engine BVJ	GC083099	Outer Joint		38	27	59.5	34.5	64	M	
4.2 Quattro (246 kW)	2005.03-	2006.05	AT	L	F	Estate Engine BAT	GDS83306	Drive Shaft		38		59.5	34	525		
	2005.03-	2006.05				Estate Engine BAT	GC083099	Outer Joint		38	27	59.5	34.5	64	M	
5.2 S6 Quattro (320 kW)	2006.03-	2007.11	AT			Estate Engine BXA	GC083099	Outer Joint		38	27	59.5	34.5	64	M	
<b>A6 AVANT (4G5, C7)</b>																
2.0 TFSi (132 kW)	2011.06-					Estate Engine CDNB	GC083103	Outer Joint		42	28	76.4	34	54	I	
2.8 FSi (150 kW)	2011.05-			L/R	F	Estate Engine CHVA	GC083087	Outer Joint		42	27	76.5	34	54.5	M	
	2011.05-			L/R	F	Estate Engine CHVA	GDS83317	Drive Shaft		42		76.5	34	490		
	2011.05-			L/R	F	Estate Engine CHVA	GC183022	Inner Joint			34		88			
	2011.05-					Estate Engine CHVA	GC083103	Outer Joint		42	28	76.4	34	54	I	
2.8 FSi Quattro (150 kW)	2011.05-				Estate Engine CHVA	GC083103	Outer Joint		42	28	76.4	34	54	I		
3.0 TDi Quattro (150 kW)	2011.05-				Estate Engine CLAA	GC083103	Outer Joint		42	28	76.4	34	54	I		
3.0 TDi Quattro (180 kW)	2011.05-				Estate Engine CDUC/CDUD/CKVB/CKVC	GC083103	Outer Joint		42	28	76.4	34	54	I		
3.0 TDi Quattro (230 kW)	2011.11-				Estate Engine CGQB	GC083103	Outer Joint		42	28	76.4	34	54	I		
3.0 TFSi Quattro (220 kW)	2011.05-	2012.05				Estate Engine CGWB	GC083103	Outer Joint		42	28	76.4	34	54	I	
3.0 TFSi Quattro (228 kW)	2011.11-					Estate Engine CGWD	GC083103	Outer Joint		42	28	76.4	34	54	I	
4.0 S6 Quattro (309 kW)	2012.02-					Estate Engine CEUC	GC083103	Outer Joint		42	28	76.4	34	54	I	
<b>A6 AVANT (4G5, C7, 4GD)</b>																
4.0 RS6 Quattro (412 kW)	2013.01-					Estate Engine CRDB	GC083103	Outer Joint		42	28	76.4	34	54	I	
<b>A6 II (4B, C5), AVANT</b>																
3.0 Quattro (160 kW)	2004.01-				F		GC083077	Outer Joint		38	27	59.5	34	63	M	
<b>A6 II QUATTRO, AVANT</b>																
2.4 V6	1997.05-	2003.05	Semi-AT		F		GC083064	Outer Joint	45T	38	27	60	34	64	I	
2.5 TDi V6	1998.04-	2004.10	Semi-AT		F		GC083064	Outer Joint	45T	38	27	60	34	64	I	
2.7 Turbo	1999.06-	2003.05	Semi-AT		F		GC083064	Outer Joint	45T	38	27	60	34	64	I	
3.0 V6	2001.08-	2005.01	Semi-AT		F		GC083064	Outer Joint	45T	38	27	60	34	64	I	
	2001.08-		AT		F		GC083064	Outer Joint	45T	38	27	60	34	64	I	









		YEAR	TRANSM	L/R	F/R		G-AP Ref.	PRODUCT	ABS	Technical Specifications						
										A	B	C	H	L	P	
<b>AUDI</b>																
<b>A6 II QUATTRO, AVANT</b>																
3.0 V6	2001.08-		MT		F		GC083064	Outer Joint	45T	38	27	60	34	64	I	
<b>A6 II, AVANT</b>																
1.9 TDi	1997.05-	2005.01	AT		F		GC083064	Outer Joint	45T	38	27	60	34	64	I	
2.0 20V	2001.08-		AT		F		GC083064	Outer Joint	45T	38	27	60	34	64	I	
	2001.08-		MT		F		GC083064	Outer Joint	45T	38	27	60	34	64	I	
2.4 V6	1997.05-	2003.05	Semi-AT		F		GC083064	Outer Joint	45T	38	27	60	34	64	I	
2.5 TDi V6	1998.04-	2004.10	Semi-AT		F		GC083064	Outer Joint	45T	38	27	60	34	64	I	
<b>A6 III (4F2, 4FH) ALLROAD, AVANT</b>																
2.0 TDi 16V (100 kW)	2008.10-	2011.02	MT/AT				GC083077	Outer Joint		38	27	59.5	34	63	M	
2.0 TDi 16V (103 kW)	2008-		MT/AT				GC083077	Outer Joint		38	27	59.5	34	63	M	
2.0 TDi 16V (125 kW)	2008-		MT/AT				GC083077	Outer Joint		38	27	59.5	34	63	M	
2.0 TDi 16V (89 kW)	2008.10-	2011.02	MT/AT				GC083077	Outer Joint		38	27	59.5	34	63	M	
2.0 TFSi 16V (125 kW)	2005.06-	2011.03					GC083077	Outer Joint		38	27	59.5	34	63	M	
2.4 Quattro (130 kW)	2004.05-	2008.10					GC083077	Outer Joint		38	27	59.5	34	63	M	
2.7 TDi Quattro (120 kW)	2005.06-	2011.03			IncQuattro		GC083077	Outer Joint		38	27	59.5	34	63	M	
2.7 TDi Quattro (132 kW)	2005.06-	2011.03			IncQuattro		GC083077	Outer Joint		38	27	59.5	34	63	M	
2.7 TDi Quattro (140 kW)	2008-				IncQuattro		GC083077	Outer Joint		38	27	59.5	34	63	M	
2.8 V6 FSi (140 kW)	2006.11-	2011.03					GC083077	Outer Joint		38	27	59.5	34	63	M	
2.8 V6 FSi (162 kW)	2006.11-	2011.03					GC083077	Outer Joint		38	27	59.5	34	63	M	
2.8 V6 FSi Quattro (154 kW)	2006.11-	2011.03					GC083077	Outer Joint		38	27	59.5	34	63	M	
2.8 V6 FSi Quattro (155 kW)	2006.11-	2011.03					GC083077	Outer Joint		38	27	59.5	34	63	M	
3.0 Quattro (160 kW)	2004.05-	2008.09			F		GC083077	Outer Joint		38	27	59.5	34	63	M	
3.0 TDi Quattro (155 kW)	2004.05-	2008.09			F		GC083077	Outer Joint		38	27	59.5	34	63	M	
3.0 TDi Quattro (165 kW)	2004.05-	2008.09			F		GC083077	Outer Joint		38	27	59.5	34	63	M	
3.0 TDi Quattro (171 kW)	2004.05-	2008.09			F		GC083077	Outer Joint		38	27	59.5	34	63	M	
3.0 TDi Quattro (176 kW)	2004.05-	2008.09			F		GC083077	Outer Joint		38	27	59.5	34	63	M	
3.0 TFSi V6 Quattro (213 kW)	2008.10-	2011.03			F		GC083077	Outer Joint		38	27	59.5	34	63	M	
3.0 TFSi V6 Quattro (220 kW)	2008.10-	2011.03			F		GC083077	Outer Joint		38	27	59.5	34	63	M	
3.2 FSi (195 kW)	2009.05-	2011.03			F		GC083077	Outer Joint		38	27	59.5	34	63	M	
3.2 FSi Quattro (188 kW)	2005.03-	2008.10			F		GC083077	Outer Joint		38	27	59.5	34	63	M	
4.2 FSi V8 Quattro (257 kW)	2004.08-	2008.09	AT		F		GC083077	Outer Joint		38	27	59.5	34	63	M	
4.2 Quattro (246 kW)	2006-				F		GC083077	Outer Joint		38	27	59.5	34	63	M	
S6 5.2 V10 Quattro (315 kW)	2008.10-	2011.02			F		GC083077	Outer Joint		38	27	59.5	34	63	M	
S6 5.2 V10 Quattro (320 kW)	2008.10-	2011.02			F		GC083077	Outer Joint		38	27	59.5	34	63	M	
<b>A6 IV (4G2, 4G5), AVANT</b>																
2.0 TDi (120 kW)	2011.03-						GCI83022	Inner Joint			34		88			
2.0 TDi (130 kW)	2011.03-						GCI83022	Inner Joint			34		88			
2.0 TFSi (132 kW)	2011.01-						GCI83022	Inner Joint			34		88			
2.0 TFSi (155 kW)	2011.01-						GCI83022	Inner Joint			34		88			
2.0 TFSi hybrid (155 kW)	2011.11-						GCI83022	Inner Joint			34		88			
2.8 FSi (150 kW)	2011.03-						GCI83022	Inner Joint			34		88			
2.8 FSi Quattro (150 kW)	2011.03-						GCI83022	Inner Joint			34		88			
3.0 TDi (150 kW)	2010.11-						GCI83022	Inner Joint			34		88			
3.0 TDi Quattro (150 kW)	2011.11-						GCI83022	Inner Joint			34		88			
3.0 TDi Quattro (180 kW)	2011.11-						GCI83022	Inner Joint			34		88			
3.0 TFSi Quattro (220 kW)	2011.11-						GCI83022	Inner Joint			34		88			
3.0 TFSi Quattro (228 kW)	2011.11-						GCI83022	Inner Joint			34		88			
S6 Quattro (309 kW)	2012.02-						GCI83022	Inner Joint			34		88			
<b>A6 IV (4GH), ALLROAD</b>																
3.0 TDi Quattro (150 kW)	2012.03-						GCI83022	Inner Joint			34		88			
3.0 TDi Quattro (180 kW)	2012.03-						GCI83022	Inner Joint			34		88			
3.0 TDi Quattro (230 kW)	2012.03-						GCI83022	Inner Joint			34		88			
3.0 TFSi Quattro (228 kW)	2012.03-						GCI83022	Inner Joint			34		88			
<b>A7 (4GA)</b>																
2.8 FSi (150 kW)	2011.02-			L/R	F	Hatchback Engine CHVA	GC083087	Outer Joint		42	27	76.5	34	54.5	M	
	2011.02-			L/R	F	Hatchback Engine CHVA	GDS83317	Drive Shaft		42		76.5	34	490		
	2011.02-			L/R	F	Hatchback Engine CHVA	GCI83022	Inner Joint			34		88			
	2011.02-					Hatchback Engine CHVA	GC083103	Outer Joint		42	28	76.4	34	54	I	
2.8 FSi Quattro (150 kW)	2010.10-				Hatchback Engine CHVA/CNVA	GC083103	Outer Joint		42	28	76.4	34	54	I		
3.0 TDi Quattro (150 kW)	2010.12-				Hatchback Engine CLAA	GC083103	Outer Joint		42	28	76.4	34	54	I		
3.0 TDi Quattro (180 kW)	2010.10-				Hatchback Engine CDUC/CDUD/CKVB/CKVC	GC083103	Outer Joint		42	28	76.4	34	54	I		
3.0 TDi Quattro (230 kW)	2011.11-				Hatchback Engine CGQB	GC083103	Outer Joint		42	28	76.4	34	54	I		



		TRANSM	L/R	F/R		G-AP Ref.	PRODUCT	ABS	Technical Specifications					
									YEAR	A	B	C	H	L
<b>AUDI</b>														
<b>A7 (4GA)</b>														
3.0 TFSi Quattro (220 kW)	2010.10-				Hatchback Engine CGWB/CHMA	GC083103	Outer Joint		42	28	76.4	34	54	I
3.0 TFSi Quattro (228 kW)	2011.01-				Hatchback Engine CGWD/CGXB/CTTA/CTUA	GC083103	Outer Joint		42	28	76.4	34	54	I
4.0 S7 Quattro (309 kW)	2012.02-				Hatchback Engine CEUC	GC083103	Outer Joint		42	28	76.4	34	54	I
<b>A7 (4GA), SPORTBACK</b>														
2.8 FSi (150 kW)	2011.02-					GCI83022	Inner Joint			34		88		
2.8 FSi Quattro (150 kW)	2001.10-					GCI83022	Inner Joint			34		88		
3.0 TDi (150 kW)	2010.07-					GCI83022	Inner Joint			34		88		
3.0 TDi Quattro (150 kW)	2010.07-	2011.11				GCI83022	Inner Joint			34		88		
3.0 TDi Quattro (180 kW)	2010.07-	2011.11				GCI83022	Inner Joint			34		88		
3.0 TDi Quattro (23C kW)	2010.07-	2011.11				GCI83022	Inner Joint			34		88		
3.0 TFSi Quattro (220 kW)	2010.07-	2011.11				GCI83022	Inner Joint			34		88		
3.0 TFSi Quattro (228 kW)	2010.07-	2011.11				GCI83022	Inner Joint			34		88		
<b>A7 SPORTBACK (4GA, 4GF)</b>														
3.0 TDi Quattro (155 kW)	2014.07-				Hatchback Engine CRTF/CTCB	GC083103	Outer Joint		42	28	76.4	34	54	I
3.0 TDi Quattro (160 kW)	2014.07-				Hatchback Engine CRTE	GC083103	Outer Joint		42	28	76.4	34	54	I
3.0 TDi Quattro (176 kW)	2013.05-				Hatchback Engine CPNB	GC083103	Outer Joint		42	28	76.4	34	54	I
3.0 TDi Quattro (200 kW)	2014.05-				Hatchback Engine CRTD	GC083103	Outer Joint		42	28	76.4	34	54	I
3.0 TDi Quattro (235 kW)	2014.05-				Hatchback Engine CVUA	GC083103	Outer Joint		42	28	76.4	34	54	I
3.0 TDi Quattro (240 kW)	2014.09-				Hatchback Engine CVUB	GC083103	Outer Joint		42	28	76.4	34	54	I
4.0 RS7 Quattro (412 kW)	2013.10-				Hatchback Engine CRDB/CWUB	GC083103	Outer Joint		42	28	76.4	34	54	I
4.0 S7 Quattro (331 kW)	2014.07-				Hatchback Engine CTGE	GC083103	Outer Joint		42	28	76.4	34	54	I
<b>A8 (4D2, 4D8)</b>														
2.5 TDi (132 kW)	2000.09-	2002.09	MT		F Saloon Engine AKE	GC083019	Outer Joint	45W	38	27	59.5	34.5	63	I
2.5 TDi Quattro (132 kW)	2000.09-	2002.09			F Saloon Engine AKE	GC083019	Outer Joint	45W	38	27	59.5	34.5	63	I
2.8 (142 kW)	1996.04-	2002.09			F Saloon Engine ACK/ALG/AMX/APR/AQD	GC083019	Outer Joint	45W	38	27	59.5	34.5	63	I
2.8 Quattro (142 kW)	1996.04-	2002.09			F Saloon Engine ACK/AMX/APR/AQD	GC083019	Outer Joint	45W	38	27	59.5	34.5	63	I
3.3 TDi Quattro (165 kW)	2000.06-	2002.09			F Saloon Engine AKF	GC083019	Outer Joint	45W	38	27	59.5	34.5	63	I
3.7 (191 kW)	1998.11-	2002.09	AT		F Saloon Engine AKC/AQG	GC083019	Outer Joint	45W	38	27	59.5	34.5	63	I
3.7 Quattro (191 kW)	1998.11-	2002.09	AT		F Saloon Engine AKC/AQG	GC083019	Outer Joint	45W	38	27	59.5	34.5	63	I
4.2 Quattro (228 kW)	1998.11-	2002.09			F Saloon Engine AQF/AUW/AUX	GC083019	Outer Joint	45W	38	27	59.5	34.5	63	I
4.2 S8 Quattro (265 kW)	1999.06-	2002.09	AT		F Saloon Engine AQH/AVP	GC083019	Outer Joint	45W	38	27	59.5	34.5	63	I
6.0 W12 Quattro (309 kW)	2001.01-	2002.09	AT		F Saloon Engine AZC	GC083019	Outer Joint	45W	38	27	59.5	34.5	63	I
<b>A8 (4E _)</b>														
3.0 TDi Quattro (171 kW)	2003.08-	2010.07	AT		F Saloon Engine ASB	GC083099	Outer Joint		38	27	59.5	34.5	64	M
3.2 FSi (191 kW)	2005.06-	2007.11			F Saloon Engine BPK	GC083077	Outer Joint		38	27	59.5	34	63	M
3.7 Quattro (206 kW)	2002.10-	2006.05			Saloon Engine BFL	GC083099	Outer Joint		38	27	59.5	34.5	64	M
4.0 TDi Quattro (202 kW)	2003.05-	2005.07			Saloon Engine ASE	GC083099	Outer Joint		38	27	59.5	34.5	64	M
4.2 FSi Quattro (257 kW)	2006.05-	2007.11	AT		F Saloon Engine BVJ	GC083099	Outer Joint		38	27	59.5	34.5	64	M
4.2 Quattro (246 kW)	2002.10-	2010.07			Saloon Engine BFM	GC083099	Outer Joint		38	27	59.5	34.5	64	M
5.2 S8 Quattro (331 kW)	2006.01-	2007.12	AT		F Saloon Engine BSM	GC083099	Outer Joint		38	27	59.5	34.5	64	M
6.0 W12 Quattro (331 kW)	2003.12-	2010.07	AT		F Saloon Engine BHT	GC083099	Outer Joint		38	27	59.5	34.5	64	M
<b>A8 (4H _)</b>														
2.0 TFSi HybriD (155 kW)	2012.02-				Saloon Engine CHJA	GC083102	Outer Joint		42	29	76.5	34	60	I
3.0 TDi Quattro (155 kW)	2010.08-				Saloon Engine CDTB	GC083103	Outer Joint		42	28	76.4	34	54	I
3.0 TDi Quattro (176 kW)	2012.11-				Saloon Engine CPNA	GC083103	Outer Joint		42	28	76.4	34	54	I
3.0 TDi Quattro (184 kW)	2010.07-				Saloon Engine CDTA/CMHA	GC083103	Outer Joint		42	28	76.4	34	54	I
3.0 TDi Quattro (190 kW)	2013.10-				Saloon Engine CTBA	GC083103	Outer Joint		42	28	76.4	34	54	I
3.0 TFSi Quattro (213 kW)	2010.07-				Saloon Engine CGWA/CGXA	GC083103	Outer Joint		42	28	76.4	34	54	I
3.0 TFSi Quattro (228 kW)	2011.11-				Saloon Engine CGWD	GC083103	Outer Joint		42	28	76.4	34	54	I
3.0 TFSi Quattro (245 kW)	2010.06-				Saloon Engine CGXC/CMDA/CREC/CTDA/CTUB	GC083103	Outer Joint		42	28	76.4	34	54	I
30 FSi (150 kW)	2012.07-				Saloon Engine CPAA/CVBA	GC083103	Outer Joint		42	28	76.4	34	54	I
4.0 S8 Quattro (382 kW)	2012.04-				Saloon Engine CGTA	GC083103	Outer Joint		42	28	76.4	34	54	I
4.0 TFSi Quattro (309 kW)	2012.03-				F Saloon Engine CEUA	GC083103	Outer Joint		42	28	76.4	34	54	I
4.0 TFSi Quattro (320 kW)	2013.10-				Saloon Engine CTGA	GC083103	Outer Joint		42	28	76.4	34	54	I
4.2 FSi Quattro (273 kW)	2009.11-				F Saloon Engine CDRA	GC083103	Outer Joint		42	28	76.4	34	54	I
4.2 TDi Quattro (258 kW)	2009.11-				Saloon Engine CDSB	GC083088	Outer Joint		42	29	76.5	34	61.5	M
6.3 W12 Quattro (368 kW)	2011.01-				Saloon Engine CEJA/CTNA	GC083103	Outer Joint		42	28	76.4	34	54	I
<b>A8 II (4E)</b>														
3 (160 kW)	2003.08-	2005.05			F	GC083077	Outer Joint		38	27	59.5	34	63	M
3.0 Quattro (162 kW)	2003.08-	2005.05			F	GC083077	Outer Joint		38	27	59.5	34	63	M
3.0 TDi Quattro (155 kW)	2003.11-	2010.07			F	GC083077	Outer Joint		38	27	59.5	34	63	M
3.0 TDi Quattro (171 kW)	2003.11-	2010.07			F	GC083077	Outer Joint		38	27	59.5	34	63	M

		TRANSM	L/R	F/R		G-AP Ref.	PRODUCT	ABS	Technical Specifications					
									YEAR	A	B	C	H	L
<b>AUDI</b>														
<b>A8 II (4E)</b>														
3.2 FSi (191 kW)	2005.06-	2010.07				GC083077	Outer Joint		38	27	59.5	34	63	M
3.2 FSi Quattro (191 kW)	2005.06-	2010.07				GC083077	Outer Joint		38	27	59.5	34	63	M
3.7 Quattro (206 kW)	2002.10-	2010.07			F	GC083077	Outer Joint		38	27	59.5	34	63	M
4.0 TDi Quattro (202 kW)	2003.05-	2005.07			F	GC083077	Outer Joint		38	27	59.5	34	63	M
4.2 FSi Quattro (257 kW)	2006.06-	2010.07			F	GC083077	Outer Joint		38	27	59.5	34	63	M
4.2 Quattro (246 kW)	2002.10-	2010.07			F	GC083077	Outer Joint		38	27	59.5	34	63	M
4.2 TDi Quattro (235 kW)	2005.01-	2005.06			F	GC083077	Outer Joint		38	27	59.5	34	63	M
4.2 TDi Quattro (240 kW)	2005.01-	2005.06			F	GC083077	Outer Joint		38	27	59.5	34	63	M
6.0 W12 Quattro (331 kW)	2003.12-	2010.07			F	GC083077	Outer Joint		38	27	59.5	34	63	M
S8 Quattro (331 kW)	2003.12-	2010.07			F	GC083077	Outer Joint		38	27	59.5	34	63	M
<b>A8 III (4H)</b>														
2.0 TFSi hybrid (155 kW)	2012.02-					GCI83022	Inner Joint				34		88	
3.0 TDi Quattro (155 kW)	2010.09-	2011.11				GCI83022	Inner Joint				34		88	
3.0 TDi Quattro (184 kW)	2010.09-	2011.11				GCI83022	Inner Joint				34		88	
3.0 TFSi Quattro (213 kW)	2010.09-	2011.11				GCI83022	Inner Joint				34		88	
3.0 TFSi Quattro (245 kW)	2010.09-	2011.11				GCI83022	Inner Joint				34		88	
4.0 S8 TFSi Quattro (381 kW)	2010.06-					GCI83022	Inner Joint				34		88	
4.0 TFSi Quattro (309 kW)	2012.03-					GCI83022	Inner Joint				34		88	
4.2 FSi Quattro (273 kW)	2009.11-					GCI83022	Inner Joint				34		88	
4.2 TDi Quattro (254 kW)	2009.11-					GCI83022	Inner Joint				34		88	
<b>ALLROAD (4BH, C5)</b>														
2.5 TDi Quattro (120 kW)	2003.05-	2005.08			F Estate Engine BCZ	GC083019	Outer Joint	45W	38	27	59.5	34.5	63	I
2.5 TDi Quattro (132 kW)	2000.05-	2005.08	MT		F Estate Engine AKE/BAU	GC083019	Outer Joint	45W	38	27	59.5	34.5	63	I
2.7 T Quattro (184 kW)	2000.05-	2005.08	MT		F Estate Engine ARE/BES	GC083019	Outer Joint	45W	38	27	59.5	34.5	63	I
4.2 V8 Quattro (220 kW)	2002.07-	2005.08			F Estate Engine BAS	GC083019	Outer Joint	45W	38	27	59.5	34.5	63	I
<b>CABRIO (8G7, B4)</b>														
1.8 (92 kW)	1997.01-	2000.08				GC083012	Outer Joint	45T	33	30	53	31	62	I
1.9 TDi (66 kW)	1995.06-	2000.08				GC083012	Outer Joint	45T	33	30	53	31	62	I
<b>CABRIOLET (8G7, B4)</b>														
1.8 (92 kW)	1997.01-	2000.08	MT		F Convertible Engine ADR	GCI61007	Inner Joint				33		32	
2.0 E (85 kW)	1993.01-	1998.07	MT		F Convertible Engine ABK	GCI83014	Inner Joint				33		32	
	1993.01-	1998.07	MT	L	F Convertible Engine ABK	GDS83059	Drive Shaft		33		53	31	586	
	1993.01-	1998.07	MT	L	F Convertible Engine ABK	GDS83003	Drive Shaft	45T	33		53	31	586	
	1993.01-	1998.07	MT/AT		F Convertible Engine ABK	GC083051	Outer Joint		33	30	53	30	61	I
2.3 E (98 kW)	1991.05-	1994.07	MT	R	F Convertible Engine NG	GDS83044	Drive Shaft	45T	33		53	31	563	
	1991.05-	1994.07	MT		F Convertible Engine NG	GC083051	Outer Joint		33	30	53	30	61	I
2.6 (110 kW)	1993.06-	2000.08	MT/AT		F Convertible Engine ABC	GC083017	Outer Joint	45T	38	27	59.5	34.5	68.5	I
2.8 (128 kW)	1992.11-	2000.08	MT/AT		F Convertible Engine AAH	GC083017	Outer Joint	45T	38	27	59.5	34.5	68.5	I
<b>COUPE</b>														
2.0 (85 kW)	1983.08-	1986.07			F	GC053004	Outer Joint		22	30	51	78	61	I
<b>COUPE (81, 85)</b>														
1.8 GT (79 kW)	1986.08-	1987.10	MT		F Coupe Engine PV	GCI83006	Inner Joint				33		34	
1.8 GT (82 kW)	1986.08-	1988.10	MT		F Coupe Engine DZ	GCI83006	Inner Joint				33		34	
1.9 (85 kW)	1980.08-	1983.07			F Coupe Engine WN	GCI61007	Inner Joint				33		32	
2.0 (85 kW)	1983.09-	1986.07	MT		F Coupe Engine JS	GCI83006	Inner Joint				33		34	
2.1 GT (96 kW)	1982.09-	1987.10	MT		F Coupe Engine KE	GC083031	Outer Joint		22	25	51	78	61	O
2.2 GT (100 kW)	1984.09-	1988.10	MT/AT		F Coupe Engine HY/KV	GC083031	Outer Joint		22	25	51	78	61	O
	1984.09-	1988.10	MT/AT		F Coupe Engine HY/KV	GC083029	Outer Joint	96T	22	25	51	78	61	O
<b>COUPE (89, 8B)</b>														
2.0 (82 kW)	1990.03-	1990.07			F Coupe Engine 3A	GCI61007	Inner Joint				33		32	
2.0 (85 kW)	1989.05-	1996.12	3MT/AT		F Coupe Engine AAD/ABK	GCI83014	Inner Joint				33		32	
	1989.05-	1996.12	MT	L	F Coupe Engine AAD/ABK	GDS83059	Drive Shaft		33		53	31	586	
	1989.05-	1996.12	MT	L	F Coupe Engine AAD/ABK	GDS83003	Drive Shaft	45T	33		53	31	586	
	1989.05-	1996.12	MT&3AT		F Coupe Engine AAD/ABK	GC083051	Outer Joint		33	30	53	30	61	I
2.0 16V (103 kW)	1992.08-	1996.12			F Coupe Engine ACE	GCI61007	Inner Joint				33		32	
	1992.08-	1996.12	MT	R	F Coupe Engine ACE	GDS83044	Drive Shaft	45T	33		53	31	563	
	1992.08-	1996.12	MT		F Coupe Engine ACE	GC083051	Outer Joint		33	30	53	30	61	I
2.3 (100 kW)	1988.10-	1994.07	MT	R	F Coupe Engine NG	GDS83044	Drive Shaft	45T	33		53	31	563	
2.3 (98 kW)	1990.03-	1996.12	MT	R	F Coupe Engine NG	GDS83044	Drive Shaft	45T	33		53	31	563	
2.3 20V (123 kW)	1990.08-	1991.07	MT/AT		F Coupe Engine 7A	GC083017	Outer Joint	45T	38	27	59.5	34.5	68.5	I
2.3 20V (125 kW)	1989.08-	1991.07	MT/AT		F Coupe Engine 7A	GC083017	Outer Joint	45T	38	27	59.5	34.5	68.5	I
2.6 (110 kW)	1992.08-	1996.12	MT/AT		F Coupe Engine ABC	GC083017	Outer Joint	45T	38	27	59.5	34.5	68.5	I









		TRANSM	L/R	F/R		G-AP Ref.	PRODUCT	ABS	Technical Specifications								
									YEAR	A	B	C	H	L	P		
<b>AUDI</b>																	
<b>COUPE (89, 8B)</b>																	
2.8 (128 kW)	1991.09-	1996.12	MT/AT		F	Coupe Engine AAH	GC083017	Outer Joint	45T	38	27	59.5	34.5	68.5		I	
2.8 Quattro (128 kW)	1991.08-	1996.12	MT		F	Coupe Engine AAH	GC083016	Outer Joint	45T	38	30	59.5	34	61		I	
<b>PHAETON (3D2)</b>																	
3.0 V6 TDi 4motion (165 kW)	2004.09-						GC083077	Outer Joint		38	27	59.5	34	63		M	
3.2 V6 (177 kW)	2003.10-						GC083077	Outer Joint		38	27	59.5	34	63		M	
3.2 V6 4motion (177 kW)	2002.04-						GC083077	Outer Joint		38	27	59.5	34	63		M	
4.2 V8 4motion (246 kW)	2003.05-						GC083077	Outer Joint		38	27	59.5	34	63		M	
4.9 V10 TDi 4motion (230 kW)	2002.11-						GC083077	Outer Joint		38	27	59.5	34	63		M	
6.0 W12 4motion (309 kW)	2002.04-						GC083077	Outer Joint		38	27	59.5	34	63		M	
6.0 W12 4motion (331 kW)	2002.04-						GC083077	Outer Joint		38	27	59.5	34	63		M	
<b>Q3 (8U)</b>																	
1.4 TFSi (110 kW)	2013.10-		MT	L	F	Closed Off-Road Vehicle Engine CHPB/CZDA/CZEA	GDS61146	Drive Shaft		36		59.5	40	490			
	2013.10-		MT	L	F	Closed Off-Road Vehicle Engine CHPB/CZDA/CZEA	GCI83016	Inner Joint			28		32				
	2013.10-		MT	R	F	Closed Off-Road Vehicle Engine CHPB/CZDA/CZEA	GDS61147	Drive Shaft		36		59.5	40	795			
	2013.10-		MT	R	F	Closed Off-Road Vehicle Engine CHPB/CZDA/CZEA	GCI83016	Inner Joint			28		32				
2.0 TDi (100 kW)	2011.09-		MT	L	F	Closed Off-Road Vehicle Engine CFFA	GDS61146	Drive Shaft		36		59.5	40	490			
	2011.09-		MT	L	F	Closed Off-Road Vehicle Engine CFFA	GCI83016	Inner Joint			28		32				
	2011.09-		MT	R	F	Closed Off-Road Vehicle Engine CFFA	GDS61147	Drive Shaft		36		59.5	40	795			
	2011.09-		MT	R	F	Closed Off-Road Vehicle Engine CFFA	GCI83016	Inner Joint			28		32				
2.0 TDi (103 kW)	2011.09-		MT	L	F	Closed Off-Road Vehicle Engine CFFB/CLJA	GDS61146	Drive Shaft		36		59.5	40	490			
	2011.09-		MT	L	F	Closed Off-Road Vehicle Engine CFFB/CLJA	GCI83016	Inner Joint			28		32				
	2011.09-		MT	R	F	Closed Off-Road Vehicle Engine CFFB/CLJA	GDS61147	Drive Shaft		36		59.5	40	795			
	2011.09-		MT	R	F	Closed Off-Road Vehicle Engine CFFB/CLJA	GCI83016	Inner Joint			28		32				
	2011.09-						GCI83016	Inner Joint			28		32				
2.0 TDi (130 kW)	2013.05-		MT	L	F	Closed Off-Road Vehicle Engine CFGC	GDS61146	Drive Shaft		36		59.5	40	490			
	2013.05-		MT	L	F	Closed Off-Road Vehicle Engine CFGC	GCI83016	Inner Joint			28		32				
	2013.05-		MT	R	F	Closed Off-Road Vehicle Engine CFGC	GDS61147	Drive Shaft		36		59.5	40	795			
	2013.05-		MT	R	F	Closed Off-Road Vehicle Engine CFGC	GCI83016	Inner Joint			28		32				
2.0 TDi Quattro (103 kW)	2012.01-						GCI83016	Inner Joint			28		32				
	2012.01-						GC083002	Outer Joint		36	27	59.5	40	66		I	
2.0 TFSi Quattro (125 kW)	2011.06-						GCI83016	Inner Joint			28		32				
	2011.06-						GC083002	Outer Joint		36	27	59.5	40	66		I	
<b>Q5 (8R)</b>																	
2.0 TDi (100 kW)	2010.11-			L/R	F	Closed Off-Road Vehicle Engine CJCB	GDS83316	Drive Shaft		42		76.5	34	490			
	2012.06-	2013.05					GCI83022	Inner Joint			34		88				
2.0 TDi (105 kW)	2010.11-			L/R	F	Closed Off-Road Vehicle Engine CJCA	GDS83316	Drive Shaft		42		76.5	34	490			
	2012.06-	2013.05					GCI83022	Inner Joint			34		88				
2.0 TDi (110 kW)	2012.06-	2013.05				GCI83022	Inner Joint			34		88					
2.0 TDi Quattro (100 kW)	2012.06-	2013.05	AT			Double Clutch	GCI83022	Inner Joint			34		88				
2.0 TDi Quattro (105 kW)	2009.08-			L/R		Closed Off-Road Vehicle Engine CAGA/CJCA	GDS83316	Drive Shaft		42		76.5	34	490			
	2012.06-	2013.05	AT			Double Clutch	GCI83022	Inner Joint			34		88				
2.0 TDi Quattro (110 kW)	2012.06-	2013.05	AT			Double Clutch	GCI83022	Inner Joint			34		88				
	2013.05-					Closed Off-Road Vehicle Engine CJCD/CSUA	GC083107	Outer Joint		42	25	76.5	34	47.5		I	
2.0 TDi Quattro (120 kW)	2012.06-	2013.05	AT			Double Clutch	GCI83022	Inner Joint			34		88				
2.0 TDi Quattro (125 kW)	2008.11-		6MT	L/R		Closed Off-Road Vehicle Engine CAHA/CGLB/CMGA	GDS83316	Drive Shaft		42		76.5	34	490			
	2008.11-		7AT	L/R		Closed Off-Road Vehicle Engine CAHA/CGLB/CMGA	GC083087	Outer Joint		42	27	76.5	34	54.5		M	
	2008.11-		7AT	L/R		Closed Off-Road Vehicle Engine CAHA/CGLB/CMGA	GDS83317	Drive Shaft		42		76.5	34	490			
	2008.11-		6MT		F	Closed Off-Road Vehicle Engine CAHA/CGLB/CMGA	GC083086	Outer Joint		42	33	76.5	34	45.5		M	
2.0 TDi Quattro (130 kW)	2012.06-	2013.05	AT			Double Clutch	GCI83022	Inner Joint			34		88				
	2011.06-			L/R		Closed Off-Road Vehicle Engine CHJA	GC083087	Outer Joint		42	27	76.5	34	54.5		M	
2.0 TFSi Hybrid Quattro (155 kW)	2011.06-			L/R		Closed Off-Road Vehicle Engine CHJA	GDS83317	Drive Shaft		42		76.5	34	490			
	2011.06-			L/R		Closed Off-Road Vehicle Engine CHJA	GCI83022	Inner Joint			34		88				
	2009.08-		MT	L/R		Closed Off-Road Vehicle Engine CDNB/CNCB	GDS83316	Drive Shaft		42		76.5	34	490			
2.0 TFSi Quattro (155 kW)	2008.11-		6MT/7AT	L/R		Closed Off-Road Vehicle Engine CAEB/CDNC/CPMA	GDS83316	Drive Shaft		42		76.5	34	490			
	2008.11-		6MT/7AT		F	Closed Off-Road Vehicle Engine CAEB/CDNC/CPMA	GC083086	Outer Joint		42	33	76.5	34	45.5		M	
2.0 TFSi Quattro hybrid (155 kW)	2011.06-	2013.02					GCI83022	Inner Joint			34		88				
3.0 TDi Quattro (176 kW)	2008.11-		6AT/7AT	L/R		Closed Off-Road Vehicle Engine CCWA	GC083087	Outer Joint		42	27	76.5	34	54.5		M	
	2008.11-		6AT/7AT	L/R		Closed Off-Road Vehicle Engine CCWA	GDS83317	Drive Shaft		42		76.5	34	490			
	2008.11-		6AT/7AT	L/R		Closed Off-Road Vehicle Engine CCWA	GCI83022	Inner Joint			34		88				
	2012.06-	2013.05					GCI83022	Inner Joint			34		88				
3.0 TDi Quattro (180 kW)	2012.06-	2013.05					GCI83022	Inner Joint			34		88				

	 YEAR	TRANSM	L/R	F/R		G-AP Ref.	PRODUCT	ABS	Technical Specifications									
									A	B	C	H	L	P				
<b>AUDI Q5 (8R)</b>																		
3.0 TFSi Quattro (200 kW)	2011.06-	2013.05				GCI83022	Inner Joint			34		88						
3.0 TFSi Quattro (260 kW)	2011.06-	2013.05				GCI83022	Inner Joint			34		88						
3.2 FSi Quattro (199 kW)	2008.11-		6AT/7AT	L/R	Closed Off-Road Vehicle Engine CALB	GC083087	Outer Joint		42	27	76.5	34	54.5	M				
	2008.11-		6AT/7AT	L/R	Closed Off-Road Vehicle Engine CALB	GDS83317	Drive Shaft		42		76.5	34	490					
	2008.11-		6AT/7AT	L/R	Closed Off-Road Vehicle Engine CALB	GCI83022	Inner Joint			34		88						
SQ5 Quattro (230 kW)	2012.12-					GCI83022	Inner Joint			34		88						
<b>Q7 (4L)</b>																		
3.0 TDi (150 kW)	2010.05-			L/R	F	Closed Off-Road Vehicle Engine CJGC/CJMA	GCI99148	Inner Joint			28		34					
3.0 TDi (155 kW)	2006.03-	2010.05				Closed Off-Road Vehicle Engine BUN/CASB	GC061050	Outer Joint		30	27	64	103.5	63.5	M			
	2006.03-	2010.05		L/R		Closed Off-Road Vehicle Engine BUN/CASB	GCI83027	Inner Joint			28		28					
	2006.03-	2010.05		L/R	F	Closed Off-Road Vehicle Engine BUN/CASB	GDS99213	Drive Shaft		30		64	103.5	523				
	2006.03-	2010.05		L/R	F	Closed Off-Road Vehicle Engine BUN/CASB	GCI99148	Inner Joint			28		34					
	2006.03-	2010.05		L/R	R	Closed Off-Road Vehicle Engine BUN/CASB	GDS85098	Drive Shaft		30		64	103	740				
3.0 TDi (165 kW)	2009.06-	2012.05	6AT	L/R		Closed Off-Road Vehicle Engine CATA	GCI83027	Inner Joint			28		28					
	2009.06-	2012.05		L/R	F	Closed Off-Road Vehicle Engine CATA	GCI99148	Inner Joint			28		34					
3.0 TDi (171 kW)	2009.06-	2012.05	6AT	L/R	R	Closed Off-Road Vehicle Engine CATA	GDS85098	Drive Shaft		30		64	103	740				
	2009.06-	2012.05		L/R	F	Closed Off-Road Vehicle Engine CATA	GCI83027	Inner Joint			28		28					
3.0 TDi (171 kW)	2006.03-	2008.05			F	Closed Off-Road Vehicle Engine BUG	GC061050	Outer Joint		30	27	64	103.5	63.5	M			
	2006.03-	2008.05		L/R	F	Closed Off-Road Vehicle Engine BUG	GDS99213	Drive Shaft		30		64	103.5	523				
	2006.03-	2008.05		L/R	F	Closed Off-Road Vehicle Engine BUG	GCI99148	Inner Joint			28		34					
	2006.03-	2008.05		L/R	R	Closed Off-Road Vehicle Engine BUG	GDS85098	Drive Shaft		30		64	103	740				
	2006.03-	2008.05		L/R	F	Closed Off-Road Vehicle Engine BUG	GCI99148	Inner Joint			28		34					
3.0 TDi (176 kW)	2007.11-			L/R		Closed Off-Road Vehicle Engine CASA/CCMA/CJGA/CNRB	GCI83027	Inner Joint			28		28					
	2007.11-				F	Closed Off-Road Vehicle Engine CASA/CCMA/CJGA/CNRB	GC061050	Outer Joint		30	27	64	103.5	63.5	M			
	2007.11-			L/R	F	Closed Off-Road Vehicle Engine CASA/CCMA/CJGA/CNRB	GDS99213	Drive Shaft		30		64	103.5	523				
	2007.11-			L/R	F	Closed Off-Road Vehicle Engine CASA/CCMA/CJGA/CNRB	GCI99148	Inner Joint			28		34					
	2007.11-		6AT	L/R	R	Closed Off-Road Vehicle Engine CASA/CCMA/CJGA/CNRB	GDS85098	Drive Shaft		30		64	103	740				
3.0 TDi (180 kW)	2011.05-			L/R	F	Closed Off-Road Vehicle Engine CJGD/CLZB/CRCA	GCI99148	Inner Joint			28		34					
3.0 TDi Quattro (155 kW)	2006.03-	2010.05				GC061050	Outer Joint		30	27	64	103.5	63.5	M				
3.0 TDi Quattro (171 kW)	2006.03-	2010.05				GC061050	Outer Joint		30	27	64	103.5	63.5	M				
3.0 TDi Quattro (176 kW)	2006.03-	2010.05				GC061050	Outer Joint		30	27	64	103.5	63.5	M				
3.0 TFSi (200 kW)	2010.05-			L/R	F	Closed Off-Road Vehicle Engine CJTC/CJWC	GCI99148	Inner Joint			28		34					
3.0 TFSi (206 kW)	2011.05-			L/R	F	Closed Off-Road Vehicle Engine CJWE/CTWB	GCI99148	Inner Joint			28		34					
3.0 TFSi (245 kW)	2010.05-			L/R	F	Closed Off-Road Vehicle Engine CJTB/CJWB/CNAA/CTWA	GCI99148	Inner Joint			28		34					
3.6 FSi (206 kW)	2006.12-	2007.11		L/R		Closed Off-Road Vehicle Engine BHK	GCI83027	Inner Joint			28		28					
	2006.12-	2007.11			F	Closed Off-Road Vehicle Engine BHK	GC061050	Outer Joint		30	27	64	103.5	63.5	M			
	2006.12-	2007.11		L/R	F	Closed Off-Road Vehicle Engine BHK	GDS99213	Drive Shaft		30		64	103.5	523				
	2006.12-	2007.11		L/R	F	Closed Off-Road Vehicle Engine BHK	GCI99148	Inner Joint			28		34					
	2006.12-	2007.11		L/R	R	Closed Off-Road Vehicle Engine BHK	GDS85098	Drive Shaft		30		64	103	740				
3.6 FSi Quattro (206 kW)	2006.06-	2009.06				GC061050	Outer Joint		30	27	64	103.5	63.5	M				
4.2 FSi (257 kW)	2006.03-	2010.05		L/R		Closed Off-Road Vehicle Engine BAR	GCI83027	Inner Joint			28		28					
	2006.03-	2010.05			F	Closed Off-Road Vehicle Engine BAR	GC061050	Outer Joint		30	27	64	103.5	63.5	M			
	2006.03-	2010.05		L/R	F	Closed Off-Road Vehicle Engine BAR	GDS99213	Drive Shaft		30		64	103.5	523				
	2006.03-	2010.05		L/R	F	Closed Off-Road Vehicle Engine BAR	GCI99148	Inner Joint			28		34					
	2006.03-	2010.05		L/R	R	Closed Off-Road Vehicle Engine BAR	GDS85098	Drive Shaft		30		64	103	740				
4.2 FSi Quattro (257 kW)	2006.03-	2009.06				GC061050	Outer Joint		30	27	64	103.5	63.5	M				
4.2 TDi (240 kW)	2007.03-	2007.11			F	Closed Off-Road Vehicle Engine BTR	GC083085	Outer Joint		30	29	64	103	72.5	M			
	2007.03-	2007.11		L/R	R	Closed Off-Road Vehicle Engine BTR	GCI35051	Inner Joint			30		30.5					
4.2 TDi (250 kW)	2009.05-			L/R	F	Closed Off-Road Vehicle Engine CCFA/CCFC	GCI99148	Inner Joint			28		34					
	2009.05-		6AT	L/R	R	Closed Off-Road Vehicle Engine CCFA/CCFC	GCI35051	Inner Joint			30		30.5					
6.0 TDi (368 kW)	2008.09-			L/R	R	Closed Off-Road Vehicle Engine CCGA	GCI35051	Inner Joint			30		30.5					
<b>QUATTRO (85)</b>																		
2.1 20V Turbo (225 kW)	1984.05-	1987.07			R	Coupe Engine KW	GC083003	Outer Joint		26	28	56.5	84.5	66.5	O			
2.1 Turbo (147 kW)	1980.07-	1987.07			R	Coupe Engine GV/WR	GC083003	Outer Joint		26	28	56.5	84.5	66.5	O			
2.2 20V Turbo (162 kW)	1989.08-	1991.07			R	Coupe Engine RR	GC083003	Outer Joint		26	28	56.5	84.5	66.5	O			
2.2 Turbo (147 kW)	1987.08-	1989.07			R	Coupe Engine 1B/MB	GC083003	Outer Joint		26	28	56.5	84.5	66.5	O			
<b>TT (8J3)</b>																		
1.8 TFSi (118 kW)	2008.06-				F	Coupe Engine CDAA	GC083002	Outer Joint		36	27	59.5	40	66	I			
2.0 Quattro (195 kW)	2008.05-		AT	L	F	Coupe Engine CDLA/CDMA	GDS83303	Drive Shaft		36		59.5	40	495				
2.0 TDi Quattro (125 kW)	2008.06-		AT	L		Coupe Engine CBBB/CFGB	GDS54013	Drive Shaft		36		59.5	40	479.5				
	2008.06-				F	Coupe Engine CBBB/CFGB	GC083002	Outer Joint		36	27	59.5	40	66	I			
	2008.06-				R	Coupe Engine CBBB/CFGB	GCI83011	Inner Joint			33		34					
	2008.06-		MT	L	F	Coupe Engine CBBB/CFGB	GDS83350	Drive Shaft		36		59.5	40	495				



		TRANSM	L/R	F/R		G-AP Ref.	PRODUCT	ABS	Technical Specifications									
									YEAR	A	B	C	H	L	P			
<b>AUDI</b>																		
<b>TT (8J3)</b>																		
2.0 TDi Quattro (125 kW)	2008.06-		MT	R	F	Coupe Engine CBBB/CFGB	GDS83322	Drive Shaft		36		59.5	40	613				
2.0 TFSi (147 kW)	2006.08-	2010.06	MT		F	Coupe Engine BWA	GC083002	Outer Joint		36	27	59.5	40	66	I			
	2006.08-	2010.06		L	F	Coupe Engine BWA	GDS83350	Drive Shaft		36		59.5	40	495				
2.0 TFSi (155 kW)	2010.05-		MT	L	F	Coupe Engine CESA	GDS83303	Drive Shaft		36		59.5	40	495				
2.0 TFSi Quattro (147 kW)	2008.06-	2010.06	AT	L	F	Coupe Engine CCZA/BWA	GDS83350	Drive Shaft		36		59.5	40	495				
	2008.06-	2010.06	AT	R	F	Coupe Engine CCZA/BWA	GDS83322	Drive Shaft		36		59.5	40	613				
2.0 TFSi Quattro (155 kW)	2010.05-		MT	L	F	Coupe Engine CESA/CETA	GDS83303	Drive Shaft		36		59.5	40	495				
2.0 TFSi Quattro (200 kW)	2008.05-				R	Coupe Engine CDLB	GCI83011	Inner Joint			33		34					
	2008.05-		MT	L	F	Coupe Engine CDLB	GDS83303	Drive Shaft		36		59.5	40	495				
3.2 V6 Quattro (184 kW)	2006.08-	2010.06				Coupe Engine BUB	GC061021	Outer Joint		36	27	53	40	65	I			
	2006.08-	2010.06	MT			Coupe Engine BUB	GCI53002	Inner Joint			33		34					
	2006.08-	2010.06	MT			Coupe Engine BUB	GC083037	Outer Joint		36	30	59.5	40.5	55	I			
	2006.08-	2010.06	AT	L	F	Coupe Engine BUB	GDS83241	Drive Shaft		36		59.5	40	475				
	2006.08-	2010.06	MT	L	F	Coupe Engine BUB	GDS83350	Drive Shaft		36		59.5	40	495				
	2006.08-	2010.06			R	Coupe Engine BUB	GCI83011	Inner Joint			33		34					
<b>TT (8J3, 8J9)</b>																		
3.2 V6 Quattro (184 kW)	2006.08-	2010.06	MT				GC083037	Outer Joint		36	30	59.5	40.5	55	I			
<b>TT (8J3, 8J9), ROADSTER</b>																		
1.8 TFSi (118 kW)	2008.06-	2010.06					GCI83016	Inner Joint			28		32					
	2008.06-	2010.06					GC083002	Outer Joint		36	27	59.5	40	66	I			
2.0 TDi Quattro (125 kW)	2008.06-	2010.06					GCI83016	Inner Joint			28		32					
	2008.06-	2010.06					GC083002	Outer Joint		36	27	59.5	40	66	I			
2.0 TFSi (147 kW)	2006.08-	2010.06					GC083002	Outer Joint		36	27	59.5	40	66	I			
	2008.06-	2010.06					GCI83016	Inner Joint			28		32					
2.0 TFSi (155 kW)	2006.08-	2010.06					GC083002	Outer Joint		36	27	59.5	40	66	I			
	2008.06-	2010.06					GCI83016	Inner Joint			28		32					
2.0 TFSi Quattro (147 kW)	2006.08-	2010.06					GC083002	Outer Joint		36	27	59.5	40	66	I			
	2008.06-	2010.06					GCI83016	Inner Joint			28		32					
2.0 TFSi Quattro (155 kW)	2006.08-	2010.06					GC083002	Outer Joint		36	27	59.5	40	66	I			
	2008.06-	2010.06					GCI83016	Inner Joint			28		32					
2.0 TFSi Quattro (200 kW)	2008.05-						GCI83016	Inner Joint			28		32					
	2008.05-						GC083002	Outer Joint		36	27	59.5	40	66	I			
3.2 V6 Quattro (184 kW)	2006.08-	2010.06				Double Clutch	GC083002	Outer Joint		36	27	59.5	40	66	I			
	2008.06-	2010.06				DOUBLE CLUTCH	GCI83016	Inner Joint			28		32					
<b>TT (8N3)</b>																		
1.8 T (110 kW)	2002.09-	2006.06			F	Coupe Engine AUM	GC083036	Outer Joint		36	30	53.2	77.5	61	I			
	2002.09-	2006.06		L	F	Coupe Engine AUM	GDS61156	Drive Shaft		36		53	78	554.5				
	2002.09-	2006.06		L	F	Coupe Engine AUM	GCI61062	Inner Joint			30		59					
1.8 T (120 kW)	2005.09-	2006.06			F	Coupe Engine BVP	GC083036	Outer Joint		36	30	53.2	77.5	61	I			
	2005.09-	2006.06		L	F	Coupe Engine BVP	GDS61156	Drive Shaft		36		53	78	554.5				
	2005.09-	2006.06		L	F	Coupe Engine BVP	GCI61062	Inner Joint			30		59					
1.8 T (132 kW)	1998.10-	2006.06			F	Coupe Engine AJQ/APP/ATC/AUQ	GC083036	Outer Joint		36	30	53.2	77.5	61	I			
	1998.10-	2006.06	5MT		F	Coupe Engine AJQ/APP/ATC/AUQ	GC061021	Outer Joint		36	27	53	40	65	I			
	1998.10-	2006.06	MT	L	F	Coupe Engine AJQ/APP/ATC/AUQ	GDS61156	Drive Shaft		36		53	78	554.5				
	1998.10-	2006.06	MT	L	F	Coupe Engine AJQ/APP/ATC/AUQ	GCI61062	Inner Joint			30		59					
1.8 T (140 kW)	2004.06-	2006.08			F	Coupe Engine BVR	GC061021	Outer Joint		36	27	53	40	65	I			
	2004.06-	2006.08			F	Coupe Engine BVR	GC083036	Outer Joint		36	30	53.2	77.5	61	I			
	2004.06-	2006.08	MT	L	F	Coupe Engine BVR	GDS61156	Drive Shaft		36		53	78	554.5				
	2004.06-	2006.08	MT	L	F	Coupe Engine BVR	GCI61062	Inner Joint			30		59					
	1.8 T Quattro (132 kW)	1998.10-	2006.06				Coupe Engine AJQ/ARY/AUQ	GC083036	Outer Joint		36	30	53.2	77.5	61	I		
		1998.10-	2006.06	6MT			Coupe Engine AJQ/ARY/AUQ	GC061021	Outer Joint		36	27	53	40	65	I		
		1998.10-	2006.06	MT		F	Coupe Engine AJQ/ARY/AUQ	GC083035	Outer Joint		36	27	53	77.5	65	I		
		1998.10-	2006.06	MT	L	F	Coupe Engine AJQ/ARY/AUQ	GDS83304	Drive Shaft		36		59.5	40	481			
		1998.10-	2006.06	MT	L	F	Coupe Engine AJQ/ARY/AUQ	GDS61123	Drive Shaft		36		53	77.5	520			
		1998.10-	2006.06	MT	R	F	Coupe Engine AJQ/ARY/AUQ	GDS61186	Drive Shaft		36		53	77.5	653			
1998.10-		2006.06	MT	R	F	Coupe Engine AJQ/ARY/AUQ	GCI61002	Inner Joint			28		31.8					
1.8 T Quattro (140 kW)	1998.10-	2006.06	MT	R	F	Coupe Engine AJQ/ARY/AUQ	GC083035	Outer Joint		36	27	53	77.5	65	I			
	1998.10-	2006.06	6MT		R	Coupe Engine AJQ/ARY/AUQ	GCI83011	Inner Joint			33		34					
	2005.09-	2006.08				Coupe Engine BVR	GC061021	Outer Joint		36	27	53	40	65	I			
	2005.09-	2006.08				Coupe Engine BVR	GC083036	Outer Joint		36	30	53.2	77.5	61	I			
	2005.09-	2006.08	MT	L	F	Coupe Engine BVR	GDS83304	Drive Shaft		36		59.5	40	481				
2005.09-	2006.08			R	Coupe Engine BVR	GCI83011	Inner Joint			33		34						





		YEAR	TRANSM	L/R	F/R		G-AP Ref.	PRODUCT	ABS	Technical Specifications						
										A	B	C	H	L	P	
<b>AUDI</b>																
<b>TT (8N3)</b>																
1.8 T Quattro (165 kW)	1998.10-	2006.06	MT		F	Coupe Engine APX/BAM	GC083035	Outer Joint		36	27	53	77.5	65	I	
	1998.10-	2006.06	MT	L	F	Coupe Engine APX/BAM	GDS83304	Drive Shaft		36		59.5	40	481		
	1998.10-	2006.06	MT	L	F	Coupe Engine APX/BAM	GDS61123	Drive Shaft		36		53	77.5	520		
	1998.10-	2006.06	MT	R	F	Coupe Engine APX/BAM	GDS61186	Drive Shaft		36		53	77.5	653		
	1998.10-	2006.06	MT	R	F	Coupe Engine APX/BAM	GCI61002	Inner Joint			28		31.8			
	1998.10-	2006.06	MT	R	F	Coupe Engine APX/BAM	GC083035	Outer Joint		36	27	53	77.5	65	I	
	1998.10-	2006.06	6MT		R	Coupe Engine APX/BAM	GCI83011	Inner Joint			33		34			
1.8 T Quattro (176 kW)	2005.03-	2006.08	MT	L	F	Coupe Engine BFV	GDS83304	Drive Shaft		36		59.5	40	481		
	2005.03-	2006.08	6MT		R	Coupe Engine BFV	GCI83011	Inner Joint			33		34			
3.2 VR6 Quattro (184 kW)	2003.07-	2006.06				Coupe Engine BHE/BPF	GC061021	Outer Joint		36	27	53	40	65	I	
	2003.07-	2006.06	AT	L	F	Coupe Engine BHE/BPF	GDS83241	Drive Shaft		36		59.5	40	475		
	2003.07-	2006.06			R	Coupe Engine BHE/BPF	GCI83011	Inner Joint			33		34			
<b>TT ROADSTER (8J9)</b>																
1.8 TFSi (118 kW)	2008.06-				F	Convertible Engine CDAA	GC083002	Outer Joint		36	27	59.5	40	66	I	
2.0 Quattro (195 kW)	2008.05-		MT	L	F	Convertible Engine CDLA/CDMA	GDS83303	Drive Shaft		36		59.5	40	495		
2.0 TDi Quattro (125 kW)	2008.06-		AT	L		Convertible Engine CBBB/CFGB	GDS54013	Drive Shaft		36		59.5	40	479.5		
	2008.06-				F	Convertible Engine CBBB/CFGB	GC083002	Outer Joint		36	27	59.5	40	66	I	
	2008.06-				R	Convertible Engine CBBB/CFGB	GCI83011	Inner Joint			33		34			
	2008.06-		AT	L	F	Convertible Engine CBBB/CFGB	GDS83350	Drive Shaft		36		59.5	40	495		
	2008.06-		AT	R	F	Convertible Engine CBBB/CFGB	GDS83322	Drive Shaft		36		59.5	40	613		
2.0 TFSi (147 kW)	2007.03-	2010.06	MT		F	Convertible Engine BWA	GC083002	Outer Joint		36	27	59.5	40	66	I	
	2007.03-	2010.06	MT/AT	L	F	Convertible Engine BWA	GDS83350	Drive Shaft		36		59.5	40	495		
2.0 TFSi (155 kW)	2010.05-		MT	L	F	Convertible Engine CESA	GDS83303	Drive Shaft		36		59.5	40	495		
2.0 TFSi Quattro (147 kW)	2008.06-	2010.06	AT	L	F	Convertible Engine CCZA	GDS83350	Drive Shaft		36		59.5	40	495		
	2008.06-	2010.06	AT	R	F	Convertible Engine CCZA	GDS83322	Drive Shaft		36		59.5	40	613		
2.0 TFSi Quattro (155 kW)	2010.05-		MT	L	F	Convertible Engine CESA/CETA	GDS83303	Drive Shaft		36		59.5	40	495		
2.0 TFSi Quattro (200 kW)	2008.05-				R	Convertible Engine CDLB	GCI83011	Inner Joint			33		34			
	2008.05-		MT	L	F	Convertible Engine CDLB	GDS83303	Drive Shaft		36		59.5	40	495		
3.2 V6 Quattro (184 kW)	2007.03-	2010.06				Convertible Engine BUB	GC061021	Outer Joint		36	27	53	40	65	I	
	2007.03-	2010.06	MT			Convertible Engine BUB	GCI53002	Inner Joint			33		34			
	2007.03-	2010.06	MT			Convertible Engine BUB	GC083037	Outer Joint		36	30	59.5	40.5	55	I	
	2007.03-	2010.06	MT	L	F	Convertible Engine BUB	GDS83241	Drive Shaft		36		59.5	40	475		
	2007.03-	2010.06	MT	L	F	Convertible Engine BUB	GDS83350	Drive Shaft		36		59.5	40	495		
	2007.03-	2010.06			R	Convertible Engine BUB	GCI83011	Inner Joint			33		34			
<b>TT ROADSTER (8N9)</b>																
1.8 T (110 kW)	2001.01-	2006.06			F	Convertible Engine AUM	GC083036	Outer Joint		36	30	53.2	77.5	61	I	
	2001.01-	2006.06		L	F	Convertible Engine AUM	GDS61156	Drive Shaft		36		53	78	554.5		
	2001.01-	2006.06		L	F	Convertible Engine AUM	GCI61062	Inner Joint			30		59			
1.8 T (120 kW)	2005.09-	2006.06			F	Convertible Engine BVP	GC083036	Outer Joint		36	30	53.2	77.5	61	I	
	2005.09-	2006.06		L	F	Convertible Engine BVP	GDS61156	Drive Shaft		36		53	78	554.5		
	2005.09-	2006.06		L	F	Convertible Engine BVP	GCI61062	Inner Joint			30		59			
1.8 T (132 kW)	1999.10-	2006.06			F	Convertible Engine AJQ/APP/AUQ/ATC	GC083036	Outer Joint		36	30	53.2	77.5	61	I	
	1999.10-	2006.06	5MT		F	Convertible Engine AJQ/APP/AUQ/ATC	GC061021	Outer Joint		36	27	53	40	65	I	
	1999.10-	2006.06	MT	L	F	Convertible Engine AJQ/APP/AUQ/ATC	GDS61156	Drive Shaft		36		53	78	554.5		
	1999.10-	2006.06	MT	L	F	Convertible Engine AJQ/APP/AUQ/ATC	GCI61062	Inner Joint			30		59			
1.8 T (140 kW)	2005.09-	2006.06			F	Convertible Engine BVR	GC061021	Outer Joint		36	27	53	40	65	I	
	2005.09-	2006.06			F	Convertible Engine BVR	GC083036	Outer Joint		36	30	53.2	77.5	61	I	
	2005.09-	2006.06	MT	L	F	Convertible Engine BVR	GDS61156	Drive Shaft		36		53	78	554.5		
	2005.09-	2006.06	MT	L	F	Convertible Engine BVR	GCI61062	Inner Joint			30		59			
1.8 T Quattro (132 kW)	2000.02-	2006.06				Convertible Engine AJQ/ARY/AUQ	GC083036	Outer Joint		36	30	53.2	77.5	61	I	
	2000.02-	2006.06	6MT			Convertible Engine AJQ/ARY/AUQ	GC061021	Outer Joint		36	27	53	40	65	I	
	2000.02-	2006.06	MT		F	Convertible Engine AJQ/ARY/AUQ	GC083035	Outer Joint		36	27	53	77.5	65	I	
	2000.02-	2006.06	MT	L	F	Convertible Engine AJQ/ARY/AUQ	GDS83304	Drive Shaft		36		59.5	40	481		
	2000.02-	2006.06	MT	L	F	Convertible Engine AJQ/ARY/AUQ	GDS61123	Drive Shaft		36		53	77.5	520		
	2000.02-	2006.06	MT	R	F	Convertible Engine AJQ/ARY/AUQ	GDS61186	Drive Shaft		36		53	77.5	653		
	2000.02-	2006.06	MT	R	F	Convertible Engine AJQ/ARY/AUQ	GCI61002	Inner Joint			28		31.8			
	2000.02-	2006.06	MT	R	F	Convertible Engine AJQ/ARY/AUQ	GC083035	Outer Joint		36	27	53	77.5	65	I	
	2000.02-	2006.06	6MT		R	Convertible Engine AJQ/ARY/AUQ	GCI83011	Inner Joint			33		34			
1.8 T Quattro (140 kW)	2005.09-	2006.11				Convertible Engine BVR	GC061021	Outer Joint		36	27	53	40	65	I	
	2005.09-	2006.11				Convertible Engine BVR	GC083036	Outer Joint		36	30	53.2	77.5	61	I	
	2005.09-	2006.11	MT	L	F	Convertible Engine BVR	GDS83304	Drive Shaft		36		59.5	40	481		
	2005.09-	2006.11			R	Convertible Engine BVR	GCI83011	Inner Joint			33		34			



		YEAR	TRANSM	L/R	F/R		G-AP Ref.	PRODUCT	ABS	Technical Specifications						
										A	B	C	H	L	P	
<b>AUDI</b>																
<b>TT ROADSTER (8N9)</b>																
1.8 T Quattro (165 kW)	1999.10-	2006.06	MT		F	Convertible Engine BAM/APX	GC083035	Outer Joint		36	27	53	77.5	65	I	
	1999.10-	2006.06	MT	L	F	Convertible Engine BAM/APX	GDS61123	Drive Shaft		36		53	77.5	520		
	1999.10-	2006.06	MT	R	F	Convertible Engine BAM/APX	GDS61186	Drive Shaft		36		53	77.5	653		
	1999.10-	2006.06	MT	R	F	Convertible Engine BAM/APX	GCI61002	Inner Joint			28		31.8			
	1999.10-	2006.06	MT	R	F	Convertible Engine BAM/APX	GC083035	Outer Joint		36	27	53	77.5	65	I	
	1999.10-	2006.06	6MT		R	Convertible Engine BAM/APX	GCI83011	Inner Joint			33		34			
3.2 VR6 Quattro (184 kW)	2003.07-	2006.06				Convertible Engine BHE/BPF	GC061021	Outer Joint		36	27	53	40	65	I	
	2003.07-	2006.06	MT	L	F	Convertible Engine BHE/BPF	GDS83241	Drive Shaft		36		59.5	40	475		
	2003.07-	2006.06			R	Convertible Engine BHE/BPF	GCI83011	Inner Joint			33		34			
<b>V8 (44_, 4C_)</b>																
3.6 Quattro (180 kW)	1993.04-	1994.02				Saloon Engine PT	GC083056	Outer Joint		38	27	59.5	34.5	68.5	I	
3.6 Quattro (184 kW)	1988.10-	1994.02				Saloon Engine PT	GC083056	Outer Joint		38	27	59.5	34.5	68.5	I	
	1988.10-	1994.02	MT/AT		F	Saloon Engine PT	GC083017	Outer Joint	45T	38	27	59.5	34.5	68.5	I	
4.2 Quattro (206 kW)	1991.10-	1994.02				Saloon Engine ABH	GC083056	Outer Joint		38	27	59.5	34.5	68.5	I	
	1991.10-	1994.02	MT/AT		F	Saloon Engine ABH	GC083017	Outer Joint	45T	38	27	59.5	34.5	68.5	I	
<b>AUDI FAW</b>																
<b>A6 (C5)</b>																
1.8 (92 kW)	2000.01-	2005.12	MT		F	Saloon Engine ADR/ANQ	GC083045	Outer Joint		33	30	53	30	62	I	
1.8 Turbo (110 kW)	2000.07-	2005.12	AT		F	Saloon Engine AWL	GC083049	Outer Joint		38	30	59.5	34	59.5	I	
	2000.07-	2005.12	MT		F	Saloon Engine AWL	GC083045	Outer Joint		33	30	53	30	62	I	
<b>AUSTIN</b>																
<b>ALLEGRO (ADO 67)</b>																
1.3 (43 kW)	1975.08-	1982.03			F	Estate Engine 12L	GC051013	Outer Joint		29	19	48	106	57	I	
<b>MINI</b>																
1.0 Mayfair (31 kW)	1982.08-	1993.06	MT/AT		F	Hatchback Engine 99H997P/99HA53P/99HC20P	GC051013	Outer Joint		29	19	48	106	57	I	
1.0 Mayfair Sport (30 kW)	1988.09-	1993.06	MT/AT		F	Hatchback Engine 99HD81	GC051013	Outer Joint		29	19	48	106	57	I	
<b>BMW</b>																
<b>1 (E81)</b>																
116 i (85 kW)	2007.03-	2012.09	MT	L	R	Hatchback Engine N43B16A/N45B16A	GDS85040	Drive Shaft	48W	27		69.3	68	611		
	2007.03-	2012.09	MT	R	R	Hatchback Engine N43B16A/N45B16A	GDS85036	Drive Shaft	48W	27		69.3	68	664		
	2007.03-	2012.09	MT&AT	R	R	Hatchback Engine N43B16A/N45B16A	GDS85032	Drive Shaft	48W	27		69.3	68	664		
116 i (90 kW)	2007.03-	2012.09		L	R	Hatchback Engine N43B16A/N45B16A	GDS85040	Drive Shaft	48W	27		69.3	68	611		
	2007.03-	2012.09		R	R	Hatchback Engine N43B16A/N45B16A	GDS85032	Drive Shaft	48W	27		69.3	68	664		
118 D (105 kW)	2006.09-	2012.09		L	R	Hatchback Engine N47D20A/N47D20C	GDS85022	Drive Shaft	48W	27		69	68	607		
	2006.09-	2012.09		R	R	Hatchback Engine N47D20A/N47D20C	GDS85023	Drive Shaft	48W	27		69	68	660		
118 D (90 kW)	2006.09-	2012.09	MT	L	R	Hatchback Engine M47D20(204D4)/N47D20A/N47D20C	GDS85034	Drive Shaft	48W	27		69.3	68	611		
	2006.09-	2012.09	MT	R	R	Hatchback Engine M47D20(204D4)/N47D20A/N47D20C	GDS85033	Drive Shaft	48W	27		69.3	68	664		
118 i (105 kW)	2006.09-	2012.09		L	R	Hatchback Engine N43B20A/N43B20B	GDS85040	Drive Shaft	48W	27		69.3	68	611		
	2006.09-	2012.09		R	R	Hatchback Engine N43B20A/N43B20B	GDS85032	Drive Shaft	48W	27		69.3	68	664		
118 i (95 kW)	2006.09-	2012.09	MT	L	R	Hatchback Engine N43B20A/N46B20B	GDS85040	Drive Shaft	48W	27		69.3	68	611		
	2006.09-	2012.09	MT	R	R	Hatchback Engine N43B20A/N46B20B	GDS85032	Drive Shaft	48W	27		69.3	68	664		
120 D (120 kW)	2006.09-	2012.09	MT	L	R	Hatchback Engine M47D20(204D4)/N47D20A/N47D20C	GDS85022	Drive Shaft	48W	27		69	68	607		
	2006.09-	2012.09	MT	R	R	Hatchback Engine M47D20(204D4)/N47D20A/N47D20C	GDS85023	Drive Shaft	48W	27		69	68	660		
120 D (130 kW)	2006.09-	2012.09		L	R	Hatchback Engine N47D20A/N47D20C	GDS85022	Drive Shaft	48W	27		69	68	607		
	2006.09-	2012.09		R	R	Hatchback Engine N47D20A/N47D20C	GDS85023	Drive Shaft	48W	27		69	68	660		
120 i (110 kW)	2006.09-	2012.09	MT	L	R	Hatchback Engine N42B20A/N46B20B/N46B20C	GDS85022	Drive Shaft	48W	27		69	68	607		
	2006.09-	2012.09	MT	L	R	Hatchback Engine N42B20A/N46B20B/N46B20C	GDS85040	Drive Shaft	48W	27		69.3	68	611		
	2006.09-	2012.09	MT	R	R	Hatchback Engine N42B20A/N46B20B/N46B20C	GDS85023	Drive Shaft	48W	27		69	68	660		
	2006.09-	2012.09	MT&AT	R	R	Hatchback Engine N42B20A/N46B20B/N46B20C	GDS85032	Drive Shaft	48W	27		69.3	68	664		
120 i (125 kW)	2006.09-	2012.09		L	R	Hatchback Engine N43B20A/N46B20B/N46B20C	GDS85040	Drive Shaft	48W	27		69.3	68	611		
	2006.09-	2012.09		R	R	Hatchback Engine N43B20A/N46B20B/N46B20C	GDS85032	Drive Shaft	48W	27		69.3	68	664		
123 D (150 kW)	2007.03-	2012.09	MT	L	R	Hatchback Engine N47D20B/N47D20D	GDS85085	Drive Shaft		30		58.7	73	598		
	2007.03-	2012.09	MT	R	R	Hatchback Engine N47D20B/N47D20D	GDS85079	Drive Shaft		30		58.7	73	653		
130 i (190 kW)	2006.09-	2012.09	AT	L	R	Hatchback Engine N52B30A/N52B30B/N52B30BF	GDS85039	Drive Shaft		30		58.7	73	610		
130 i (195 kW)	2006.09-	2012.09	AT	L	R	Hatchback Engine N52B30B/N52B30A/N52B30BF	GDS85039	Drive Shaft		30		58.7	73	610		
	2006.09-	2012.09	MT	L	R	Hatchback Engine N52B30B/N52B30A/N52B30BF	GDS85039	Drive Shaft		30		58.7	73	610		
	2006.09-	2012.09	AT	R	R	Hatchback Engine N52B30B/N52B30A/N52B30BF	GDS85038	Drive Shaft		30		58.7	73	663		
	2006.09-	2012.09	MT	R	R	Hatchback Engine N52B30B/N52B30A/N52B30BF	GDS85038	Drive Shaft		30		58.7	73	663		





		TRANSM	L/R	F/R		G-AP Ref.	PRODUCT	ABS	Technical Specifications					
									YEAR	A	B	C	H	L
<b>BMW</b>														
<b>1 (E82)</b>														
120 D (130 kW)	2007.10-			L	R	Coupe Engine N47D20A/N47D20C	GDS85022	Drive Shaft	48W	27		69	68	607
	2007.10-			R	R	Coupe Engine N47D20A/N47D20C	GDS85023	Drive Shaft	48W	27		69	68	660
123 D (150 kW)	2007.10-		MT	R	R	Coupe Engine N47D20B/N47D20D	GDS85079	Drive Shaft		30		58.7	73	653
	2007.10-		MT	L	R	Coupe Engine N47D20B/N47D20D	GDS85085	Drive Shaft		30		58.7	73	598
135 i (225 kW)	2007.10-			L	R	Coupe Engine N54B30A/N55B30A	GDS85039	Drive Shaft		30		58.7	73	610
	2007.10-			R	R	Coupe Engine N54B30A/N55B30A	GDS85038	Drive Shaft		30		58.7	73	663
<b>1 (E87)</b>														
123 D (150 kW)	2007.03-	2012.09	MT	L	R	Hatchback Engine N47D20B/N47D20D/N47D20C	GDS85085	Drive Shaft		30		58.7	73	598
	2007.03-	2012.09	MT	R	R	Hatchback Engine N47D20B/N47D20D/N47D20C	GDS85079	Drive Shaft		30		58.7	73	653
<b>1 (E88)</b>														
118 i (105 kW)	2008.03-			L	R	Convertible Engine N43B20A	GDS85022	Drive Shaft	48W	27		69	68	607
	2008.03-			R	R	Convertible Engine N43B20A	GDS85023	Drive Shaft	48W	27		69	68	660
120 D (130 kW)	2008.03-			L	R	Convertible Engine N47D20A/N47D20C	GDS85022	Drive Shaft	48W	27		69	68	607
	2008.03-			R	R	Convertible Engine N47D20A/N47D20C	GDS85023	Drive Shaft	48W	27		69	68	660
120 i (125 kW)	2008.03-			L	R	Convertible Engine N43B20A	GDS85040	Drive Shaft	48W	27		69.3	68	611
	2008.03-			R	R	Convertible Engine N43B20A	GDS85032	Drive Shaft	48W	27		69.3	68	664
123 D (150 kW)	2008.09-		MT	R	R	Convertible Engine N47D20B/N47D20D	GDS85079	Drive Shaft		30		58.7	73	653
	2008.09-		MT	L	R	Convertible Engine N47D20B/N47D20D	GDS85085	Drive Shaft		30		58.7	73	598
125 i (160 kW)	2008.03-			L	R	Convertible Engine N52B30A	GDS85022	Drive Shaft	48W	27		69	68	607
	2008.03-			R	R	Convertible Engine N52B30A	GDS85023	Drive Shaft	48W	27		69	68	660
<b>1 (F20)</b>														
116 D (85 kW)	2010.12-		AT	L	R	Hatchback Engine N47D20C	GDS85066	Drive Shaft		28	27	57.4	71	739
	2010.12-		AT	R	R	Hatchback Engine N47D20C	GDS85067	Drive Shaft		28	27	57.4	71	793
	2012.11-		AT	L	R	Hatchback Engine N47D16A	GDS85066	Drive Shaft		28	27	57.4	71	739
	2012.11-		AT	R	R	Hatchback Engine N47D16A	GDS85067	Drive Shaft		28	27	57.4	71	793
116 i (100 kW)	2010.12-		AT	L	R	Hatchback Engine N13B16A	GDS85107	Drive Shaft		28	27	57.4	71	749
118 D (100 kW)	2010.12-		MT	L	R	Hatchback Engine N47D20C	GDS85066	Drive Shaft		28	27	57.4	71	739
	2010.12-		MT	R	R	Hatchback Engine N47D20C	GDS85067	Drive Shaft		28	27	57.4	71	793
118 D (105 kW)	2010.12-		MT	L	R	Hatchback Engine N47D20C	GDS85066	Drive Shaft		28	27	57.4	71	739
	2010.12-		MT	R	R	Hatchback Engine N47D20C	GDS85067	Drive Shaft		28	27	57.4	71	793
118 i (100 kW)	2015.03-		AT	L	R	Hatchback Engine B38 B15 A	GDS85107	Drive Shaft		28	27	57.4	71	749
	2015.03-		AT	L	R	Hatchback Engine N13 B16 A	GDS85107	Drive Shaft		28	27	57.4	71	749
118 i (125 kW)	2010.11-		AT	L	R	Hatchback Engine N13B16A	GDS85107	Drive Shaft		28	27	57.4	71	749
120 D (120 kW)	2010.12-		MT	L	R	Hatchback Engine N47D20C	GDS85066	Drive Shaft		28	27	57.4	71	739
	2010.12-		MT	R	R	Hatchback Engine N47D20C	GDS85067	Drive Shaft		28	27	57.4	71	793
120 D (135 kW)	2010.12-		MT	L	R	Hatchback Engine N47D20C	GDS85066	Drive Shaft		28	27	57.4	71	739
	2010.12-		MT	R	R	Hatchback Engine N47D20C	GDS85067	Drive Shaft		28	27	57.4	71	793
120 i (130 kW)	2015.03-		AT	L	R	Hatchback Engine N13 B16 A	GDS85107	Drive Shaft		28	27	57.4	71	749
<b>1 (F21)</b>														
116 D (85 kW)	2011.12-		AT	L	R	Hatchback Engine N47D16A	GDS85066	Drive Shaft		28	27	57.4	71	739
	2011.12-		AT	R	R	Hatchback Engine N47D16A	GDS85067	Drive Shaft		28	27	57.4	71	793
	2012.01-		AT	L	R	Hatchback Engine N47D20C	GDS85066	Drive Shaft		28	27	57.4	71	739
	2012.01-		AT	R	R	Hatchback Engine N47D20C	GDS85067	Drive Shaft		28	27	57.4	71	793
116 i (100 kW)	2011.12-		AT	L	R	Hatchback Engine N13B16A	GDS85107	Drive Shaft		28	27	57.4	71	749
118 D (100 kW)	2011.12-			L	R	Hatchback Engine N47D20C	GDS85066	Drive Shaft		28	27	57.4	71	739
	2011.12-			R	R	Hatchback Engine N47D20C	GDS85067	Drive Shaft		28	27	57.4	71	793
118 D (105 kW)	2011.12-			L	R	Hatchback Engine N47D20C	GDS85066	Drive Shaft		28	27	57.4	71	739
	2011.12-			R	R	Hatchback Engine N47D20C	GDS85067	Drive Shaft		28	27	57.4	71	793
118 i (100 kW)	2015.03-		AT	L	R	Hatchback Engine B38 B15 A	GDS85107	Drive Shaft		28	27	57.4	71	749
	2015.03-		AT	L	R	Hatchback Engine N13 B16 A	GDS85107	Drive Shaft		28	27	57.4	71	749
118 i (125 kW)	2012.07-		AT	L	R	Hatchback Engine N13B16A	GDS85107	Drive Shaft		28	27	57.4	71	749
	2012.07-			L	R	Hatchback Engine N47D20C	GDS85066	Drive Shaft		28	27	57.4	71	739
120 D (120 kW)	2012.07-			L	R	Hatchback Engine N47D20C	GDS85066	Drive Shaft		28	27	57.4	71	739
	2012.07-			R	R	Hatchback Engine N47D20C	GDS85067	Drive Shaft		28	27	57.4	71	793
120 D (135 kW)	2012.07-			L	R	Hatchback Engine N47D20C	GDS85066	Drive Shaft		28	27	57.4	71	739
	2012.07-			R	R	Hatchback Engine N47D20C	GDS85067	Drive Shaft		28	27	57.4	71	793
120 i (130 kW)	2015.03-		AT	L	R	Hatchback Engine N13 B16 A	GDS85107	Drive Shaft		28	27	57.4	71	749
<b>3 (E30)</b>														
324 TD (85 kW)	1987.09-	1991.08	MT/AT	L/R	R	Saloon Engine M21D24/M21D24WA	GDS85004	Drive Shaft	48T	27		63.8	66.5	574
	1987.09-	1991.08	MT/AT		R	Saloon Engine M21D24/M21D24WA	GCI99052	Inner Joint			25		32	
	1987.09-	1991.08	MT/AT	L/R	R	Saloon Engine M21D24/M21D24WA	GDS85003	Drive Shaft		27		63.8	66.5	574
325 i (125 kW)	1986.12-	1991.06	MT/AT	L/R	R	Saloon Engine M20B25/M20B25(256E11)/M20B25(256E2)/M20B25(256E3)/M20B25(256E4)/M20B25(256E5)	GDS85004	Drive Shaft	48T	27		63.8	66.5	574
	1986.12-	1991.06	MT/AT		R	Saloon Engine M20B25/M20B25(256E11)/M20B25(256E2)/M20B25(256E3)/M20B25(256E4)/M20B25(256E5)	GCI99052	Inner Joint			25		32	





		YEAR	TRANSM	L/R	F/R		G-AP Ref.	PRODUCT	ABS	Technical Specifications										
										A	B	C	H	L	P					
<b>BMW</b>																				
<b>3 (E30)</b>																				
325 i (125 kW)	1987.09-	1993.10	MT/AT	L/R	R	Convertible Engine M20B25/M20B25(256E2)/M20B25(256EX)/M20B25(256K1)	GDS85004	Drive Shaft	48T	27		63.8	66.5	574						
	1987.09-	1993.10	MT/AT		R	Convertible Engine M20B25/M20B25(256E2)/M20B25(256EX)/M20B25(256K1)	GCI99052	Inner Joint			25		32							
325 i (126 kW)	1983.09-	1989.11	MT/AT	L/R	R	Saloon Engine M20B25	GDS85004	Drive Shaft	48T	27		63.8	66.5	574						
	1983.09-	1989.11	MT/AT		R	Saloon Engine M20B25	GCI99052	Inner Joint			25		32							
	1983.09-	1989.11	MT/AT	L/R	R	Saloon Engine M20B25	GDS85003	Drive Shaft		27		63.8	66.5	574						
	1985.12-	1987.12	MT/AT	L/R	R	Convertible Engine M20B25	GDS85004	Drive Shaft	48T	27		63.8	66.5	574						
	1985.12-	1987.12	MT/AT		R	Convertible Engine M20B25	GCI99052	Inner Joint			25		32							
	1985.12-	1987.12	MT/AT	L/R	R	Convertible Engine M20B25	GDS85003	Drive Shaft		27		63.8	66.5	574						
M3 2.3 (143 kW)	1986.07-	1991.06	MT/AT	L/R	R	Saloon Engine S14B23/S14B23(234EA)/S14B23(234S1)/S14B23(234S2)	GDS85004	Drive Shaft	48T	27		63.8	66.5	574						
	1986.07-	1991.06	MT/AT		R	Saloon Engine S14B23/S14B23(234EA)/S14B23(234S1)/S14B23(234S2)	GCI99052	Inner Joint			25		32							
M3 2.3 (147 kW)	1987.02-	1989.05	MT/AT	L/R	R	Saloon Engine S14B23	GDS85004	Drive Shaft	48T	27		63.8	66.5	574						
	1987.02-	1989.05	MT/AT		R	Saloon Engine S14B23	GCI99052	Inner Joint			25		32							
M3 2.3 (158 kW)	1989.06-	1991.06	MT/AT	L/R	R	Saloon Engine S14B23	GDS85004	Drive Shaft	48T	27		63.8	66.5	574						
	1989.06-	1991.06	MT/AT		R	Saloon Engine S14B23	GCI99052	Inner Joint			25		32							
<b>3 (E36)</b>																				
316 i (73 kW)	1990.09-	1993.09		L/R	R	Saloon Engine M40B16	GCI85009	Inner Joint		27	24	64	68.5	58						
	1990.09-	1993.09		L/R	R	Saloon Engine M40B16	GDS85002	Drive Shaft	48W	27		64	68.5	615						
	1990.09-	1993.09		L/R	R	Saloon Engine M40B16	GDS85014	Drive Shaft		27		64	68.5	615						
316 i (75 kW)	1990.09-	1993.09		L/R	R	Saloon Engine M40B16/M43B16	GCI85009	Inner Joint		27	24	64	68.5	58						
	1990.09-	1993.09		L/R	R	Saloon Engine M40B16/M43B16	GDS85002	Drive Shaft	48W	27		64	68.5	615						
	1990.09-	1993.09		L/R	R	Saloon Engine M40B16/M43B16	GDS85014	Drive Shaft		27		64	68.5	615						
	1993.07-	1998.02		L/R	R	Saloon Engine M43B16/M40B16	GCI85009	Inner Joint		27	24	64	68.5	58						
	1993.07-	1998.02		L/R	R	Saloon Engine M43B16/M40B16	GDS85002	Drive Shaft	48W	27		64	68.5	615						
	1993.07-	1998.02		L/R	R	Saloon Engine M43B16/M40B16	GDS85014	Drive Shaft		27		64	68.5	615						
	1993.09-	1999.04		L/R	R	Coupe Engine M43B16	GCI85009	Inner Joint		27	24	64	68.5	58						
	1993.09-	1999.04		L/R	R	Coupe Engine M43B16	GDS85002	Drive Shaft	48W	27		64	68.5	615						
318 i (83 kW)	1990.12-	1993.10		L/R	R	Saloon Engine M40B18	GCI85009	Inner Joint		27	24	64	68.5	58						
	1990.12-	1993.10		L/R	R	Saloon Engine M40B18	GDS85002	Drive Shaft	48W	27		64	68.5	615						
	1990.12-	1993.10		L/R	R	Saloon Engine M40B18	GDS85014	Drive Shaft		27		64	68.5	615						
318 i (85 kW)	1993.10-	1998.02		L/R	R	Saloon Engine M43B18	GCI85009	Inner Joint		27	24	64	68.5	58						
	1993.10-	1998.02		L/R	R	Saloon Engine M43B18	GDS85002	Drive Shaft	48W	27		64	68.5	615						
	1993.10-	1998.02		L/R	R	Saloon Engine M43B18	GDS85014	Drive Shaft		27		64	68.5	615						
	1994.01-	1999.04		L/R	R	Convertible Engine M43B18	GCI85009	Inner Joint		27	24	64	68.5	58						
	1994.01-	1999.04		L/R	R	Convertible Engine M43B18	GDS85002	Drive Shaft	48W	27		64	68.5	615						
318 iS (103 kW)	1992.03-	1995.10		L/R	R	Coupe Engine M42B18	GCI85009	Inner Joint		27	24	64	68.5	58						
	1992.03-	1995.10		L/R	R	Coupe Engine M42B18	GDS85002	Drive Shaft	48W	27		64	68.5	615						
	1992.03-	1995.10		L/R	R	Coupe Engine M42B18	GDS85014	Drive Shaft		27		64	68.5	615						
	1993.03-	1998.02		L/R	R	Saloon Engine M42B18	GCI85009	Inner Joint		27	24	64	68.5	58						
	1993.03-	1998.02		L/R	R	Saloon Engine M42B18	GDS85002	Drive Shaft	48W	27		64	68.5	615						
	1993.03-	1998.02		L/R	R	Saloon Engine M42B18	GDS85014	Drive Shaft		27		64	68.5	615						
	1995.09-	1998.02		L/R	R	Saloon Engine M44B19	GCI85009	Inner Joint		27	24	64	68.5	58						
	1995.09-	1999.04		L/R	R	Coupe Engine M44B19/M44B19(194S1)	GCI85009	Inner Joint		27	24	64	68.5	58						
318 TDS (66 kW)	1995.09-	1998.02		L/R	R	Saloon Engine M44B19	GDS85002	Drive Shaft	48W	27		64	68.5	615						
	1995.09-	1999.04		L/R	R	Coupe Engine M44B19/M44B19(194S1)	GDS85002	Drive Shaft	48W	27		64	68.5	615						
	1995.09-	1998.02		L/R	R	Saloon Engine M44B19	GDS85014	Drive Shaft		27		64	68.5	615						
	1995.09-	1999.04		L/R	R	Coupe Engine M44B19/M44B19(194S1)	GDS85014	Drive Shaft		27		64	68.5	615						
	1995.09-	1999.04		L/R	R	Coupe Engine M44B19/M44B19(194S1)	GDS85014	Drive Shaft		27		64	68.5	615						
	1995.01-	1998.02		L/R	R	Saloon Engine M41D18(Inter.)	GCI85009	Inner Joint		27	24	64	68.5	58						
	1995.01-	1998.02		L/R	R	Saloon Engine M41D18(Inter.)	GDS85002	Drive Shaft	48W	27		64	68.5	615						
	1995.01-	1998.02		L/R	R	Saloon Engine M41D18(Inter.)	GDS85014	Drive Shaft		27		64	68.5	615						
320 i (110 kW)	1990.09-	1998.02		L/R	R	Saloon Engine M52B20(M52B20S1)/M52B20S2(M52B20S2)/M52B20S3(M52B20S3)	GCI85009	Inner Joint		27	24	64	68.5	58						
	1990.09-	1998.02		L/R	R	Saloon Engine M52B20(M52B20S1)/M52B20S2(M52B20S2)/M52B20S3(M52B20S3)	GDS85002	Drive Shaft	48W	27		64	68.5	615						
	1990.09-	1998.02		L/R	R	Saloon Engine M52B20(M52B20S1)/M52B20S2(M52B20S2)/M52B20S3(M52B20S3)	GDS85014	Drive Shaft		27		64	68.5	615						
	1992.03-	1999.04		L/R	R	Coupe Engine M52B20(M52B20S1)/M52B20S2(M52B20S2)/M52B20S3(M52B20S3)	GCI85009	Inner Joint		27	24	64	68.5	58						
	1992.03-	1999.04		L/R	R	Coupe Engine M52B20(M52B20S1)/M52B20S2(M52B20S2)/M52B20S3(M52B20S3)	GDS85002	Drive Shaft	48W	27		64	68.5	615						
	1992.03-	1999.04		L/R	R	Coupe Engine M52B20(M52B20S1)/M52B20S2(M52B20S2)/M52B20S3(M52B20S3)	GDS85014	Drive Shaft		27		64	68.5	615						
	1993.12-	1999.04		L/R	R	Convertible Engine M52B20(M52B20S1)/M52B20S2(M52B20S2)/M52B20S3(M52B20S3)	GCI85009	Inner Joint		27	24	64	68.5	58						
323 i (125 kW)	1993.12-	1999.04		L/R	R	Convertible Engine M52B20(M52B20S1)/M52B20S2(M52B20S2)/M52B20S3(M52B20S3)	GDS85002	Drive Shaft	48W	27		64	68.5	615						
	1993.12-	1999.04		L/R	R	Convertible Engine M52B20(M52B20S1)/M52B20S2(M52B20S2)/M52B20S3(M52B20S3)	GDS85014	Drive Shaft		27		64	68.5	615						
323 i (125 kW)	1995.03-	1999.04	AT	L/R	R	Coupe Engine M52B25(Vanos)/M52B25(256S3)	GDS85007	Drive Shaft	48W	27		64	68.5	615						



		TRANSM	L/R	F/R		G-AP Ref.	PRODUCT	ABS	Technical Specifications									
									YEAR	A	B	C	H	L	P			
<b>BMW</b>																		
<b>3 (E36)</b>																		
325 i (141 kW)	1990.09-	1995.09	MT/AT	L/R	R	Saloon Engine M50B25(Vanos)/M50B25/M50B25TU/M50B25(256S1)/M50B25(256S2)	GDS85007	Drive Shaft	48W	27		64	68.5	615				
	1992.03-	1999.04	MT/AT	L/R	R	Coupe Engine M50B25(Vanos)/M50B25/M50B25(256S1)/M50B25(256S2)	GDS85007	Drive Shaft	48W	27		64	68.5	615				
	1993.03-	1995.03	MT/AT	L/R	R	Convertible Engine M50B25/M50B25TU	GDS85007	Drive Shaft	48W	27		64	68.5	615				
325 TD (85 kW)	1991.09-	1998.02	MT/AT	L/R	R	Saloon Engine M51D25	GDS85007	Drive Shaft	48W	27		64	68.5	615				
325 TDS (105 kW)	1993.05-	1998.02	MT/AT	L/R	R	Saloon Engine M51D25(Inter.)	GDS85007	Drive Shaft	48W	27		64	68.5	615				
328 i (142 kW)	1995.01-	1999.04	AT	L/R	R	Coupe Engine M52B28/M52B28TU/M52B28(286S1)	GDS85007	Drive Shaft	48W	27		64	68.5	615				
<b>3 (E46)</b>																		
316 Ci (85 kW)	2002.06-		MT/AT	R	R	Coupe Engine N45B16A	GDS85017	Drive Shaft	48W	27		64	68.5	675				
316 i (77 kW)	1998.09-	2005.02	MT/AT	R	R	Saloon Engine M43B19(194E1)	GDS85017	Drive Shaft	48W	27		64	68.5	675				
	2000.04-	2005.02	MT/AT	R	R	Saloon Engine M43B16/M43B16(164E3)	GDS85017	Drive Shaft	48W	27		64	68.5	675				
316 i (85 kW)	2002.02-	2005.02	MT/AT	R	R	Saloon Engine N42B18/N46B18/N46B18A	GDS85017	Drive Shaft	48W	27		64	68.5	675				
	2002.06-	2005.02	MT/AT	R	R	Saloon Engine N45B16/N45B16A	GDS85017	Drive Shaft	48W	27		64	68.5	675				
318 Ci (105 kW)	2001.09-		MT/AT	R	R	Convertible Engine N42B20/N46B20A	GDS85017	Drive Shaft	48W	27		64	68.5	675				
	2001.09-		MT/AT	R	R	Coupe Engine N42B20/N46B20A	GDS85017	Drive Shaft	48W	27		64	68.5	675				
318 Ci (110 kW)	2005.09-	2007.02	MT/AT	R	R	Convertible Engine N46B20A/N46B20B	GDS85017	Drive Shaft	48W	27		64	68.5	675				
	2005.09-	2007.02	MT/AT	R	R	Coupe Engine N46B20A	GDS85017	Drive Shaft	48W	27		64	68.5	675				
318 D (85 kW)	2001.09-	2003.03		L	R	Saloon Engine M47204D1/M47D20	GDS85051	Drive Shaft	48W	27		64	69	608				
	2001.09-	2003.03		R	R	Saloon Engine M47204D1/M47D20	GDS85042	Drive Shaft	48W	27		64	69	665				
	2003.03-	2005.02		L	R	Saloon Engine M47D20(204D4)	GDS85051	Drive Shaft	48W	27		64	69	608				
	2003.03-	2005.02		R	R	Saloon Engine M47D20(204D4)	GDS85042	Drive Shaft	48W	27		64	69	665				
318 i (105 kW)	2001.09-	2005.02	MT/AT	R	R	Saloon Engine N42B20/N46B20A	GDS85017	Drive Shaft	48W	27		64	68.5	675				
320 CD (110 kW)	2003.07-	2007.02	AT	L	R	Coupe Engine M47D20(204D4)	GDS85051	Drive Shaft	48W	27		64	69	608				
	2003.07-	2007.02	AT	R	R	Coupe Engine M47D20(204D4)	GDS85042	Drive Shaft	48W	27		64	69	665				
	2004.12-	2007.02	AT	L	R	Convertible Engine M47D20(204D4)	GDS85051	Drive Shaft	48W	27		64	69	608				
	2004.12-	2007.02	AT	R	R	Convertible Engine M47D20(204D4)	GDS85042	Drive Shaft	48W	27		64	69	665				
320 D (110 kW)	2001.09-	2005.02	AT	L	R	Saloon Engine M47D20(204D4)	GDS85051	Drive Shaft	48W	27		64	69	608				
	2001.09-	2005.02	AT	R	R	Saloon Engine M47D20(204D4)	GDS85042	Drive Shaft	48W	27		64	69	665				
320 i (125 kW)	2000.09-	2005.02	MT/AT	L	R	Saloon Engine M54B22(226S1)	GDS85051	Drive Shaft	48W	27		64	69	608				
	2000.09-	2005.02	MT	R	R	Saloon Engine M54B22(226S1)	GDS85017	Drive Shaft	48W	27		64	68.5	675				
	2000.09-	2005.02	MT/AT	R	R	Saloon Engine M54B22(226S1)	GDS85042	Drive Shaft	48W	27		64	69	665				
325 i (141 kW)	2000.09-	2005.02		L	R	Saloon Engine M54B25(256S5)	GDS85051	Drive Shaft	48W	27		64	69	608				
	2000.09-	2005.02		R	R	Saloon Engine M54B25(256S5)	GDS85042	Drive Shaft	48W	27		64	69	665				
325 xi (141 kW)	2000.09-	2005.02	MT/AT	L	F	Saloon Engine M54B25(256S5)	GDS85047	Drive Shaft		30	27	59	73	577				
	2000.09-	2005.02	MT/AT	L/R	F	Saloon Engine M54B25(256S5)	GC085002	Outer Joint		30	27	59	73	69	M			
	2000.09-	2005.02	MT/AT	R	F	Saloon Engine M54B25(256S5)	GDS85048	Drive Shaft		30	27	59	73	897				
	2000.09-	2005.02		L	R	Saloon Engine M54B25(256S5)	GDS85051	Drive Shaft	48W	27		64	69	608				
	2000.09-	2005.02	MT/AT	R	R	Saloon Engine M54B25(256S5)	GDS85042	Drive Shaft	48W	27		64	69	665				
330 D (135 kW)	1999.10-	2005.02				GC085002	Outer Joint		30	27	59	73	69	M				
330 xD (135 kW)	2000.06-	2005.02	MT/AT	L	F	Saloon Engine M57D30	GDS85047	Drive Shaft		30	27	59	73	577				
	2000.06-	2005.02	MT/AT	L/R	F	Saloon Engine M57D30	GC085002	Outer Joint		30	27	59	73	69	M			
	2000.06-	2005.02	MT/AT	R	F	Saloon Engine M57D30	GDS85048	Drive Shaft		30	27	59	73	897				
330 xD (150 kW)	2003.03-	2005.02	MT/AT	L	F	Saloon Engine M57D30(306D2)	GDS85047	Drive Shaft		30	27	59	73	577				
	2003.03-	2005.02	MT/AT	L/R	F	Saloon Engine M57D30(306D2)	GC085002	Outer Joint		30	27	59	73	69	M			
	2003.03-	2005.02	MT/AT	R	F	Saloon Engine M57D30(306D2)	GDS85048	Drive Shaft		30	27	59	73	897				
330 xi (170 kW)	2000.06-	2005.02	MT/AT	L	F	Saloon Engine M54B30(306S3)	GDS85047	Drive Shaft		30	27	59	73	577				
	2000.06-	2005.02	MT/AT	L/R	F	Saloon Engine M54B30(306S3)	GC085002	Outer Joint		30	27	59	73	69	M			
	2000.06-	2005.02	MT/AT	R	F	Saloon Engine M54B30(306S3)	GDS85048	Drive Shaft		30	27	59	73	897				
<b>3 (E90)</b>																		
318 D (105 kW)	2007.09-	2011.12		L	R	Saloon Engine N47D20A/N47D20C	GDS85022	Drive Shaft	48W	27		69	68	607				
	2007.09-	2011.12		R	R	Saloon Engine N47D20A/N47D20C	GDS85023	Drive Shaft	48W	27		69	68	660				
318 D (90 kW)	2005.09-	2007.08	MT	L	R	Saloon Engine M47N204D4	GDS85022	Drive Shaft	48W	27		69	68	607				
	2005.09-	2007.08	MT	R	R	Saloon Engine M47N204D4	GDS85023	Drive Shaft	48W	27		69	68	660				
318 i (105 kW)	2007.09-	2011.12		L	R	Saloon Engine N43B20A	GDS85040	Drive Shaft	48W	27		69.3	68	611				
	2007.09-	2011.12		R	R	Saloon Engine N43B20A	GDS85032	Drive Shaft	48W	27		69.3	68	664				
318 i (95 kW)	2005.09-	2007.08	AT	L	R	Saloon Engine N46B20/N46B20B	GDS85040	Drive Shaft	48W	27		69.3	68	611				
	2005.09-	2007.08	AT	R	R	Saloon Engine N46B20/N46B20B	GDS85032	Drive Shaft	48W	27		69.3	68	664				
320 D (110 kW)	2005.09-	2011.12	MT	L	R	Saloon Engine M47N204D4	GDS85022	Drive Shaft	48W	27		69	68	607				
	2005.09-	2011.12	MT	R	R	Saloon Engine M47N204D4	GDS85023	Drive Shaft	48W	27		69	68	660				
320 D (120 kW)	2005.01-	2011.12	MT	L	R	Saloon Engine N47D20C	GDS85022	Drive Shaft	48W	27		69	68	607				
	2005.01-	2011.12	MT	R	R	Saloon Engine N47D20C	GDS85023	Drive Shaft	48W	27		69	68	660				
320 i (110 kW)	2005.01-	2007.08	AT	L	R	Saloon Engine N46B20B/N46B20A/N46B20C	GDS85040	Drive Shaft	48W	27		69.3	68	611				
	2005.01-	2007.08	AT	R	R	Saloon Engine N46B20B/N46B20A/N46B20C	GDS85032	Drive Shaft	48W	27		69.3	68	664				





		YEAR	TRANSM	L/R	F/R		G-AP Ref.	PRODUCT	ABS	Technical Specifications										
										A	B	C	H	L	P					
<b>BMW</b>																				
<b>3 (E90)</b>																				
320 i (125 kW)	2007.09-	2011.12		L	R	Saloon Engine N43B20A	GDS85040	Drive Shaft	48W	27		69.3	68	611						
	2007.09-	2011.12		R	R	Saloon Engine N43B20A	GDS85032	Drive Shaft	48W	27		69.3	68	664						
320 Si (127 kW)	2006.03-	2006.07	MT	L	R	Saloon Engine N45B20A	GDS85039	Drive Shaft		30		58.7	73	610						
	2006.03-	2006.07	MT	R	R	Saloon Engine N45B20A	GDS85038	Drive Shaft		30		58.7	73	663						
325 D (145 kW)	2006.08-	2007.08	MT	L	R	Saloon Engine M57D30(306D3)	GDS85085	Drive Shaft		30		58.7	73	598						
	2006.08-	2007.08	MT	R	R	Saloon Engine M57D30(306D3)	GDS85079	Drive Shaft		30		58.7	73	653						
325 D (150 kW)	2010.01-	2011.12	MT	L	R	Saloon Engine N57D30A	GDS85085	Drive Shaft		30		58.7	73	598						
	2010.01-	2011.12		R	R	Saloon Engine N57D30A	GDS85079	Drive Shaft		30		58.7	73	653						
325 i (160 kW)	2005.01-	2007.08	AT	L	R	Saloon Engine N52B25/N52B25A	GDS85039	Drive Shaft		30		58.7	73	610						
	2005.01-	2007.08	MT	L	R	Saloon Engine N52B25/N52B25A	GDS85039	Drive Shaft		30		58.7	73	610						
	2005.01-	2007.08	MT	L	R	Saloon Engine N52B25/N52B25A	GDS85022	Drive Shaft	48W	27		69	68	607						
	2005.01-	2007.08	AT	R	R	Saloon Engine N52B25/N52B25A	GDS85038	Drive Shaft		30		58.7	73	663						
	2005.01-	2007.08	MT	R	R	Saloon Engine N52B25/N52B25A	GDS85038	Drive Shaft		30		58.7	73	663						
	2005.01-	2007.08	MT	R	R	Saloon Engine N52B25/N52B25A	GDS85023	Drive Shaft	48W	27		69	68	660						
325 xi (160 kW)	2005.01-	2011.12	AT	L	R	Saloon Engine N52B25A	GDS85039	Drive Shaft		30		58.7	73	610						
	2005.01-	2011.12	MT	L	R	Saloon Engine N52B25A	GDS85039	Drive Shaft		30		58.7	73	610						
	2005.01-	2011.12	AT	R	R	Saloon Engine N52B25A	GDS85038	Drive Shaft		30		58.7	73	663						
	2005.01-	2011.12	MT	R	R	Saloon Engine N52B25A	GDS85038	Drive Shaft		30		58.7	73	663						
330 D (170 kW)	2005.09-	2007.08	AT	L	R	Saloon Engine M57306D3/M57D30TU2	GDS85085	Drive Shaft		30		58.7	73	598						
	2005.09-	2007.08		R	R	Saloon Engine M57306D3/M57D30TU2	GDS85079	Drive Shaft		30		58.7	73	653						
330 D (180 kW)	2008.07-	2011.12	MT/AT	L	R	Saloon Engine N57D30A/M57N2306D3	GDS85085	Drive Shaft		30		58.7	73	598						
	2008.07-	2011.12		R	R	Saloon Engine N57D30A/M57N2306D3	GDS85079	Drive Shaft		30		58.7	73	653						
330 d xDrive (180 kW)	2009.01-	2011.12	MT	R		Saloon Engine N57D30A	GDS85079	Drive Shaft		30		58.7	73	653						
	2009.01-	2011.12	MT	L	R	Saloon Engine N57D30A	GDS85085	Drive Shaft		30		58.7	73	598						
330 i (190 kW)	2005.01-	2007.08	AT	L	R	Saloon Engine N52B30A/N52B30	GDS85039	Drive Shaft		30		58.7	73	610						
	2005.01-	2007.08	MT	L	R	Saloon Engine N52B30A/N52B30	GDS85039	Drive Shaft		30		58.7	73	610						
	2005.01-	2007.08	AT	R	R	Saloon Engine N52B30A/N52B30	GDS85038	Drive Shaft		30		58.7	73	663						
	2005.01-	2007.08	MT	R	R	Saloon Engine N52B30A/N52B30	GDS85038	Drive Shaft		30		58.7	73	663						
330 xD (170 kW)	2005.09-	2011.12	MT	R		Saloon Engine M57306D3/M57D30TU2	GDS85079	Drive Shaft		30		58.7	73	653						
	2005.09-	2011.12	MT	L	R	Saloon Engine M57306D3/M57D30TU2	GDS85085	Drive Shaft		30		58.7	73	598						
330 xi (190 kW)	2005.01-	2011.12	AT	L	R	Saloon Engine N52B30A	GDS85039	Drive Shaft		30		58.7	73	610						
	2005.01-	2011.12	MT	L	R	Saloon Engine N52B30A	GDS85039	Drive Shaft		30		58.7	73	610						
	2005.01-	2011.12	AT	R	R	Saloon Engine N52B30A	GDS85038	Drive Shaft		30		58.7	73	663						
	2005.01-	2011.12	MT	R	R	Saloon Engine N52B30A	GDS85038	Drive Shaft		30		58.7	73	663						
335 D (210 kW)	2006.08-	2007.08	AT	L	R	Saloon Engine M57D30(306D5)	GDS85085	Drive Shaft		30		58.7	73	598						
	2006.08-	2007.08		R	R	Saloon Engine M57D30(306D5)	GDS85079	Drive Shaft		30		58.7	73	653						
<b>3 (E92)</b>																				
320 D (130 kW)	2007.03-	2007.08		L	R	Coupe Engine N47D20A	GDS85022	Drive Shaft	48W	27		69	68	607						
	2007.03-	2007.08		R	R	Coupe Engine N47D20A	GDS85023	Drive Shaft	48W	27		69	68	660						
320 i (125 kW)	2007.03-	2007.08		L	R	Coupe Engine N43B20A	GDS85040	Drive Shaft	48W	27		69.3	68	611						
	2007.03-	2007.08		R	R	Coupe Engine N43B20A	GDS85032	Drive Shaft	48W	27		69.3	68	664						
325 D (145 kW)	2007.03-	2007.08	MT	R	R	Coupe Engine M57D30(306D3)	GDS85079	Drive Shaft		30		58.7	73	653						
325 D (150 kW)	2010.04-			R	R	Coupe Engine M57N2306D3/N57D30A	GDS85079	Drive Shaft		30		58.7	73	653						
	2010.04-		MT	L	R	Coupe Engine M57N2306D3/N57D30A	GDS85085	Drive Shaft		30		58.7	73	598						
325 i (160 kW)	2006.09-		MT	L	R	Coupe Engine N52B25A/N52B25C	GDS85022	Drive Shaft	48W	27		69	68	607						
	2006.09-		MT	R	R	Coupe Engine N52B25A/N52B25C	GDS85023	Drive Shaft	48W	27		69	68	660						
	2007.09-			L	R	Coupe Engine N53B30/N53B30A/N51B30A	GDS85022	Drive Shaft	48W	27		69	68	607						
	2007.09-			R	R	Coupe Engine N53B30/N53B30A/N51B30A	GDS85023	Drive Shaft	48W	27		69	68	660						
325 xi (160 kW)	2006.09-		MT	L	R	Coupe Engine N52B25A/N52B25C	GDS85039	Drive Shaft		30		58.7	73	610						
	2006.09-		MT	R	R	Coupe Engine N52B25A/N52B25C	GDS85038	Drive Shaft		30		58.7	73	663						
330 D (170 kW)	2006.08-	2007.08		R	R	Coupe Engine M57306D3/M57D30TU2	GDS85079	Drive Shaft		30		58.7	73	653						
330 D (180 kW)	2008.07-			R	R	Coupe Engine N57D30A/M57N2306D3	GDS85079	Drive Shaft		30		58.7	73	653						
	2008.07-		MT/AT	L	R	Coupe Engine N57D30A/M57N2306D3	GDS85085	Drive Shaft		30		58.7	73	598						
330 d xDrive (180 kW)	2009.01-		MT	R		Coupe Engine N57D30A	GDS85079	Drive Shaft		30		58.7	73	653						
	2009.01-		MT	L	R	Coupe Engine N57D30A	GDS85085	Drive Shaft		30		58.7	73	598						
330 i (200 kW)	2006.08-	2007.08	MT	L	R	Coupe Engine N52B30A/N53B30A	GDS85039	Drive Shaft		30		58.7	73	610						
	2006.08-	2007.08	MT	R	R	Coupe Engine N52B30A/N53B30A	GDS85038	Drive Shaft		30		58.7	73	663						
330 xD (170 kW)	2006.09-		MT	R		Coupe Engine M57306D3/M57D30TU2	GDS85079	Drive Shaft		30		58.7	73	653						
330 xD (180 kW)	2009.01-		MT	R		Coupe Engine M57N2306D3/N57D30A	GDS85079	Drive Shaft		30		58.7	73	653						
	2009.01-		MT	L	R	Coupe Engine M57N2306D3/N57D30A	GDS85085	Drive Shaft		30		58.7	73	598						
330 xi (190 kW)	2006.09-		MT			Coupe Engine N52B30A	GCI53002	Inner Joint			33		34							





		YEAR	TRANSM	L/R	F/R		G-AP Ref.	PRODUCT	ABS	Technical Specifications					
										A	B	C	H	L	P
<b>BMW</b>															
<b>3 (E92)</b>															
330 xi (200 kW)	2006.09-		MT	L	R	Coupe Engine N52B30A/N53B30A	GDS85039	Drive Shaft	30		58.7	73	610		
	2006.09-		MT	R	R	Coupe Engine N52B30A/N53B30A	GDS85038	Drive Shaft	30		58.7	73	663		
335 D (210 kW)	2006.08-	2007.08	MT/AT	L	R	Coupe Engine M57D(306D5)	GDS85085	Drive Shaft	30		58.7	73	598		
	2006.08-	2007.08		R	R	Coupe Engine M57D(306D5)	GDS85079	Drive Shaft	30		58.7	73	653		
335 i (225 kW)	2006.09-			L	R	Coupe Engine N54B30A/N55B30A	GDS85039	Drive Shaft	30		58.7	73	610		
	2006.09-			R	R	Coupe Engine N54B30A/N55B30A	GDS85038	Drive Shaft	30		58.7	73	663		
<b>3 (E93)</b>															
325 D (145 kW)	2007.03-		MT	R	R	Convertible Engine N57D30(306D3)	GDS85079	Drive Shaft	30		58.7	73	653		
	2007.03-		MT	L	R	Convertible Engine N57D30(306D3)	GDS85085	Drive Shaft	30		58.7	73	598		
325 D (150 kW)	2010.02-		MT	L	R	Convertible Engine N57D30A	GDS85085	Drive Shaft	30		58.7	73	598		
325 i (160 kW)	2007.03-		MT	L	R	Convertible Engine N52B25/N52B25A	GDS85039	Drive Shaft	30		58.7	73	610		
	2007.03-		MT	L	R	Convertible Engine N53B30/N53B30A/N51B30A	GDS85039	Drive Shaft	30		58.7	73	610		
	2007.03-		MT	R	R	Convertible Engine N52B25/N52B25A	GDS85038	Drive Shaft	30		58.7	73	663		
	2007.03-		MT	R	R	Convertible Engine N53B30/N53B30A/N51B30A	GDS85038	Drive Shaft	30		58.7	73	663		
330 D (170 kW)	2007.03-	2007.08	MT	L	R	Convertible Engine N57D30(306D3)	GDS85085	Drive Shaft	30		58.7	73	598		
	2007.03-	2007.08		R	R	Convertible Engine N57D30(306D3)	GDS85079	Drive Shaft	30		58.7	73	653		
330 D (180 kW)	2009.01-			R	R	Convertible Engine N57D30A/N57N2306D3	GDS85079	Drive Shaft	30		58.7	73	653		
	2009.01-		MT/AT	L	R	Convertible Engine N57D30A/N57N2306D3	GDS85085	Drive Shaft	30		58.7	73	598		
330 i (200 kW)	2007.03-	2007.08	MT	L	R	Convertible Engine N52B30A/N53B30A	GDS85039	Drive Shaft	30		58.7	73	610		
	2007.03-	2007.08	MT	R	R	Convertible Engine N52B30A/N53B30A	GDS85038	Drive Shaft	30		58.7	73	663		
335 i (225 kW)	2007.03-			L	R	Convertible Engine N54B30A/N54B30B/N55B30A	GDS85039	Drive Shaft	30		58.7	73	610		
	2007.03-			R	R	Convertible Engine N54B30A/N54B30B/N55B30A	GDS85038	Drive Shaft	30		58.7	73	663		
<b>3 (F30, F35, F80)</b>															
316 i (100 kW)	2012.10-		AT	L	R	Saloon Engine N13B16A	GDS85107	Drive Shaft	28	27	57.4	71	749		
318 D (105 kW)	2012.02-			L	R	Saloon Engine N47D20C	GDS85066	Drive Shaft	28	27	57.4	71	739		
	2012.02-			R	R	Saloon Engine N47D20C	GDS85067	Drive Shaft	28	27	57.4	71	793		
318 d xDrive (105 kW)	2012.11-		MT/AT	L	R	Saloon Engine N47D20C	GDS85066	Drive Shaft	28	27	57.4	71	739		
	2012.11-		MT/AT	R	R	Saloon Engine N47D20C	GDS85067	Drive Shaft	28	27	57.4	71	793		
320 D (120 kW)	2011.10-			L	R	Saloon Engine N47D20C	GDS85066	Drive Shaft	28	27	57.4	71	739		
	2011.10-			R	R	Saloon Engine N47D20C	GDS85067	Drive Shaft	28	27	57.4	71	793		
320 D (135 kW)	2011.10-			L	R	Saloon Engine N47D20C	GDS85066	Drive Shaft	28	27	57.4	71	739		
	2011.10-			R	R	Saloon Engine N47D20C	GDS85067	Drive Shaft	28	27	57.4	71	793		
320 d xDrive (135 kW)	2011.10-		MT/AT	L	R	Saloon Engine N47D20C	GDS85066	Drive Shaft	28	27	57.4	71	739		
	2011.10-		MT/AT	R	R	Saloon Engine N47D20C	GDS85067	Drive Shaft	28	27	57.4	71	793		
320 i (125 kW)	2012.02-		AT	L	R	Saloon Engine N13B16A	GDS85107	Drive Shaft	28	27	57.4	71	749		
<b>3 COMPACT (E36)</b>															
316 G (75 kW)	1994.03-	2000.08			R	Hatchback Engine M43B16	GCI85009	Inner Joint	27	24	64	68.5	58		
316 i (75 kW)	1994.03-	2000.08			R	Hatchback Engine M43B16	GCI85009	Inner Joint	27	24	64	68.5	58		
316 i (77 kW)	1998.12-	2000.08			R	Hatchback Engine M43B19(19E1)	GCI85009	Inner Joint	27	24	64	68.5	58		
318 TDS (66 kW)	1995.01-	2000.08			R	Hatchback Engine M41D18(Inter.)	GCI85009	Inner Joint	27	24	64	68.5	58		
<b>3 COMPACT (E46)</b>															
316 TI (85 kW)	2001.06-	2005.02	MT/AT	R	R	Hatchback Engine N42B18/N46B18A	GDS85017	Drive Shaft	48W	27		64	68.5	675	
318 TD (85 kW)	2003.03-	2005.02		L	R	Hatchback Engine M47D20(204D4)	GDS85051	Drive Shaft	48W	27		64	69	608	
	2003.03-	2005.02		R	R	Hatchback Engine M47D20(204D4)	GDS85042	Drive Shaft	48W	27		64	69	665	
318 TI (105 kW)	2001.09-	2005.02	MT/AT	R	R	Hatchback Engine N42B20/N46B20A	GDS85017	Drive Shaft	48W	27		64	68.5	675	
320 TD (110 kW)	2001.09-	2005.02	AT	L	R	Hatchback Engine M47D20(204D4)	GDS85051	Drive Shaft	48W	27		64	69	608	
	2001.09-	2005.02		R	R	Hatchback Engine M47D20(204D4)	GDS85042	Drive Shaft	48W	27		64	69	665	
325 TI (141 kW)	2001.06-	2005.02		L	R	Hatchback Engine M54B25(256S5)	GDS85051	Drive Shaft	48W	27		64	69	608	
	2001.06-	2005.02		R	R	Hatchback Engine M54B25(256S5)	GDS85042	Drive Shaft	48W	27		64	69	665	
<b>3 SERIES (E46)</b>															
1.6 i	2000-	2005		L	R		GDS85019	Drive Shaft	48W	27		64	68.5	622.5	
<b>3 SERIES E36</b>															
316	1990.09-		MT/AT	L/R			GDS85005	Drive Shaft	48W	27		63.8	68.5	625	
318	1990.12-		MT/AT	L/R		Incl. cabriolet	GDS85005	Drive Shaft	48W	27		63.8	68.5	625	
320	1990.09-		MT/AT	L/R		Incl. cabriolet	GDS85005	Drive Shaft	48W	27		63.8	68.5	625	
<b>3 TOURING (E30)</b>															
316 i (73 kW)	1991.09-	1994.06	MT	L/R	R	Estate Engine M40B16	GDS85004	Drive Shaft	48T	27		63.8	66.5	574	
	1991.09-	1994.06	MT		R	Estate Engine M40B16	GCI99052	Inner Joint			25		32		
	1991.09-	1994.06	MT	L/R	R	Estate Engine M40B16	GDS85003	Drive Shaft	27			63.8	66.5	574	
316 i (75 kW)	1991.09-	1994.06	MT	L/R	R	Estate Engine M40B16	GDS85004	Drive Shaft	48T	27		63.8	66.5	574	
	1991.09-	1994.06	MT		R	Estate Engine M40B16	GCI99052	Inner Joint			25		32		
	1991.09-	1994.06	MT	L/R	R	Estate Engine M40B16	GDS85003	Drive Shaft	27			63.8	66.5	574	



		YEAR	TRANSM	L/R	F/R		G-AP Ref.	PRODUCT	ABS	Technical Specifications					
										A	B	C	H	L	P
<b>BMW</b>															
<b>3 TOURING (E30)</b>															
318 i (83 kW)	1989.04-	1994.06	MT	L/R	R	Estate Engine M40B18	GDS85004	Drive Shaft	48T	27		63.8	66.5	574	
	1989.04-	1994.06	MT		R	Estate Engine M40B18	GCI99052	Inner Joint			25		32		
	1989.04-	1994.06	MT	L/R	R	Estate Engine M40B18	GDS85003	Drive Shaft		27		63.8	66.5	574	
318 i (85 kW)	1987.09-	1991.06	MT	L/R	R	Estate Engine M40B18	GDS85004	Drive Shaft	48T	27		63.8	66.5	574	
	1987.09-	1991.06	MT		R	Estate Engine M40B18	GCI99052	Inner Joint			25		32		
	1987.09-	1991.06	MT	L/R	R	Estate Engine M40B18	GDS85003	Drive Shaft		27		63.8	66.5	574	
320 i (95 kW)	1988.01-	1991.12	MT	L/R	R	Estate Engine M20B20	GDS85004	Drive Shaft	48T	27		63.8	66.5	574	
	1988.01-	1991.12	MT		R	Estate Engine M20B20	GCI99052	Inner Joint			25		32		
	1988.01-	1991.12	MT	L/R	R	Estate Engine M20B20	GDS85003	Drive Shaft		27		63.8	66.5	574	
324 TD (85 kW)	1988.01-	1993.06	MT/AT	L/R	R	Estate Engine M21D24/M21D24WA	GDS85004	Drive Shaft	48T	27		63.8	66.5	574	
	1988.01-	1993.06	MT/AT		R	Estate Engine M21D24/M21D24WA	GCI99052	Inner Joint			25		32		
	1988.01-	1993.06	MT/AT	L/R	R	Estate Engine M21D24/M21D24WA	GDS85003	Drive Shaft		27		63.8	66.5	574	
325 i (125 kW)	1987.07-	1993.03	MT/AT	L/R	R	Estate Engine M20B25	GDS85004	Drive Shaft	48T	27		63.8	66.5	574	
	1987.07-	1993.03	MT/AT		R	Estate Engine M20B25	GCI99052	Inner Joint			25		32		
<b>3 TOURING (E36)</b>															
316 i (75 kW)	1996.01-	1999.10		L/R	R	Estate Engine M43B16	GCI85009	Inner Joint		27	24	64	68.5	58	
	1996.01-	1999.10		L/R	R	Estate Engine M43B16	GDS85002	Drive Shaft	48W	27		64	68.5	615	
	1996.01-	1999.10		L/R	R	Estate Engine M43B16	GDS85014	Drive Shaft		27		64	68.5	615	
318 i (85 kW)	1995.07-	1999.10		L/R	R	Estate Engine M43B18	GCI85009	Inner Joint		27	24	64	68.5	58	
	1995.07-	1999.10		L/R	R	Estate Engine M43B18	GDS85002	Drive Shaft	48W	27		64	68.5	615	
	1995.07-	1999.10		L/R	R	Estate Engine M43B18	GDS85014	Drive Shaft		27		64	68.5	615	
318 TDS (66 kW)	1995.01-	1999.10		L/R	R	Estate Engine M41D18(Inter.)	GCI85009	Inner Joint		27	24	64	68.5	58	
	1995.01-	1999.10		L/R	R	Estate Engine M41D18(Inter.)	GDS85002	Drive Shaft	48W	27		64	68.5	615	
	1995.01-	1999.10		L/R	R	Estate Engine M41D18(Inter.)	GDS85014	Drive Shaft		27		64	68.5	615	
320 i (110 kW)	1995.01-	1999.10		L/R	R	Estate Engine M52B20/M50B20/M50B20TU/M52B(206S3)/Vanos	GCI85009	Inner Joint		27	24	64	68.5	58	
	1995.01-	1999.10		L/R	R	Estate Engine M52B20/M50B20/M50B20TU/M52B(206S3)/Vanos	GDS85002	Drive Shaft	48W	27		64	68.5	615	
	1995.01-	1999.10	MT	L/R	R	Estate Engine M52B20/M50B20/M50B20TU/M52B(206S3)/Vanos	GDS85007	Drive Shaft	48W	27		64	68.5	615	
	1995.01-	1999.10		L/R	R	Estate Engine M52B20/M50B20/M50B20TU/M52B(206S3)/Vanos	GDS85014	Drive Shaft		27		64	68.5	615	
323 i (125 kW)	1995.09-	1999.10	AT	L/R	R	Estate Engine M52B25(Vanos)	GDS85007	Drive Shaft	48W	27		64	68.5	615	
325 TDS (105 kW)	1995.01-	1999.10	AT	L/R	R	Estate Engine M51D25(Inter.)	GDS85007	Drive Shaft	48W	27		64	68.5	615	
328 i (142 kW)	1995.01-	1999.10	AT	L/R	R	Estate Engine M52B28TU/M52B28/M52B28(286S1)	GDS85007	Drive Shaft	48W	27		64	68.5	615	
<b>3 TOURING (E46)</b>															
316 i (85 kW)	2002.03-	2005.02	MT/AT	R	R	Estate Engine N42B18/N46B18/N46B18A	GDS85017	Drive Shaft	48W	27		64	68.5	675	
318 D (85 kW)	2002.03-	2005.02		L	R	Estate Engine M47204D1/M47D20	GDS85051	Drive Shaft	48W	27		64	69	608	
	2002.03-	2005.02			R	Estate Engine M47204D1/M47D20	GDS85042	Drive Shaft	48W	27		64	69	665	
	2003.03-	2005.02		L	R	Estate Engine M47D20(204D4)	GDS85051	Drive Shaft	48W	27		64	69	608	
	2003.03-	2005.02			R	Estate Engine M47D20(204D4)	GDS85042	Drive Shaft	48W	27		64	69	665	
318 i (105 kW)	2001.09-	2005.02	MT/AT	R	R	Estate Engine N42B20/N46B20/N46B20A	GDS85017	Drive Shaft	48W	27		64	68.5	675	
320 D (110 kW)	2001.09-	2005.02	AT	L	R	Estate Engine M47D20(204D4)	GDS85051	Drive Shaft	48W	27		64	69	608	
	2001.09-	2005.02	AT		R	Estate Engine M47D20(204D4)	GDS85042	Drive Shaft	48W	27		64	69	665	
320 i (125 kW)	2000.09-	2005.02	MT/AT	L	R	Estate Engine M54B22(226S1)	GDS85051	Drive Shaft	48W	27		64	69	608	
	2000.09-	2005.02	MT		R	Estate Engine M54B22(226S1)	GDS85017	Drive Shaft	48W	27		64	68.5	675	
	2000.09-	2005.02	MT/AT	R	R	Estate Engine M54B22(226S1)	GDS85042	Drive Shaft	48W	27		64	69	665	
325 i (141 kW)	2000.09-	2005.02		L	R	Estate Engine M54B25(256S5)	GDS85051	Drive Shaft	48W	27		64	69	608	
	2000.09-	2005.02		R	R	Estate Engine M54B25(256S5)	GDS85042	Drive Shaft	48W	27		64	69	665	
325 xi (141 kW)	2000.09-	2005.02	MT/AT	L	F	Estate Engine M54B25(256S5)	GDS85047	Drive Shaft		30	27	59	73	577	
	2000.09-	2005.02	MT/AT	L/R	F	Estate Engine M54B25(256S5)	GC085002	Outer Joint		30	27	59	73	69 M	
	2000.09-	2005.02	MT/AT	R	F	Estate Engine M54B25(256S5)	GDS85048	Drive Shaft		30	27	59	73	897	
	2000.09-	2005.02	MT/AT	L	R	Estate Engine M54B25(256S5)	GDS85051	Drive Shaft	48W	27		64	69	608	
	2000.09-	2005.02	MT/AT	R	R	Estate Engine M54B25(256S5)	GDS85042	Drive Shaft	48W	27		64	69	665	
	2000.09-	2005.02	MT/AT	L	R	Estate Engine M54B25(256S5)	GDS85047	Drive Shaft		30	27	59	73	577	
330 xD (135 kW)	2000.06-	2005.02	MT/AT	L	F	Estate Engine M57D30	GDS85047	Drive Shaft		30	27	59	73	577	
	2000.06-	2005.02	MT/AT	L/R	F	Estate Engine M57D30	GC085002	Outer Joint		30	27	59	73	69 M	
	2000.06-	2005.02	MT/AT	R	F	Estate Engine M57D30	GDS85048	Drive Shaft		30	27	59	73	897	
330 xD (150 kW)	2003.03-	2005.02	MT/AT	L	F	Estate Engine M57D30(306D2)	GDS85047	Drive Shaft		30	27	59	73	577	
	2003.03-	2005.02	MT/AT	L/R	F	Estate Engine M57D30(306D2)	GC085002	Outer Joint		30	27	59	73	69 M	
	2003.03-	2005.02	MT/AT	R	F	Estate Engine M57D30(306D2)	GDS85048	Drive Shaft		30	27	59	73	897	
330 xi (170 kW)	2000.06-	2005.02	MT/AT	L	F	Estate Engine M54B30(306S3)	GDS85047	Drive Shaft		30	27	59	73	577	
	2000.06-	2005.02	MT/AT	L/R	F	Estate Engine M54B30(306S3)	GC085002	Outer Joint		30	27	59	73	69 M	
	2000.06-	2005.02	MT/AT	R	F	Estate Engine M54B30(306S3)	GDS85048	Drive Shaft		30	27	59	73	897	
<b>3 TOURING (E91)</b>															
325 D (145 kW)	2006.08-	2007.08	MT	L	R	Estate Engine M57D30(306D3)	GDS85085	Drive Shaft		30		58.7	73	598	
	2006.08-	2007.08	MT		R	Estate Engine M57D30(306D3)	GDS85079	Drive Shaft		30		58.7	73	653	





		TRANSM	L/R	F/R		G-AP Ref.	PRODUCT	ABS	Technical Specifications					
									YEAR	A	B	C	H	L
<b>BMW</b>														
<b>3 TOURING (E91)</b>														
325 D (150 kW)	2010.04-			R	R	Estate Engine M57N2306D3/N57D30A	GDS85079	Drive Shaft		30		58.7	73	653
	2010.04-		MT	L	R	Estate Engine M57N2306D3/N57D30A	GDS85085	Drive Shaft		30		58.7	73	598
325 i (160 kW)	2005.09-		AT	L	R	Estate Engine N52B25/N52B25A/N52B25C	GDS85039	Drive Shaft		30		58.7	73	610
	2005.09-		MT	L	R	Estate Engine N52B25/N52B25A/N52B25C	GDS85039	Drive Shaft		30		58.7	73	610
	2005.09-		AT	R	R	Estate Engine N52B25/N52B25A/N52B25C	GDS85038	Drive Shaft		30		58.7	73	663
	2005.09-		MT	R	R	Estate Engine N52B25/N52B25A/N52B25C	GDS85038	Drive Shaft		30		58.7	73	663
325 xi (160 kW)	2005.09-		AT	L	R	Estate Engine N52B25C/N52B25A	GDS85039	Drive Shaft		30		58.7	73	610
	2005.09-		MT	L	R	Estate Engine N52B25C/N52B25A	GDS85039	Drive Shaft		30		58.7	73	610
	2005.09-		AT	R	R	Estate Engine N52B25C/N52B25A	GDS85038	Drive Shaft		30		58.7	73	663
	2005.09-		MT	R	R	Estate Engine N52B25C/N52B25A	GDS85038	Drive Shaft		30		58.7	73	663
330 D (170 kW)	2005.09-	2007.08	MT/AT	L	R	Estate Engine M57306D3	GDS85085	Drive Shaft		30		58.7	73	598
	2005.09-	2007.08		R	R	Estate Engine M57306D3	GDS85079	Drive Shaft		30		58.7	73	653
330 D (180 kW)	2008.07-			R	R	Estate Engine N57D30A/M57N2306D3	GDS85079	Drive Shaft		30		58.7	73	653
	2008.07-		MT/AT	L	R	Estate Engine N57D30A/M57N2306D3	GDS85085	Drive Shaft		30		58.7	73	598
330 d xDrive (180 kW)	2009.01-		MT	R		Estate Engine N57D30A	GDS85079	Drive Shaft		30		58.7	73	653
	2009.01-		MT	L	R	Estate Engine N57D30A	GDS85085	Drive Shaft		30		58.7	73	598
330 i (190 kW)	2005.09-	2007.08	AT	L	R	Estate Engine N52B30/N52B30A	GDS85039	Drive Shaft		30		58.7	73	610
	2005.09-	2007.08	MT	L	R	Estate Engine N52B30/N52B30A	GDS85039	Drive Shaft		30		58.7	73	610
	2005.09-	2007.08	AT	R	R	Estate Engine N52B30/N52B30A	GDS85038	Drive Shaft		30		58.7	73	663
	2005.09-	2007.08	MT	R	R	Estate Engine N52B30/N52B30A	GDS85038	Drive Shaft		30		58.7	73	663
330 xD (170 kW)	2005.09-		MT	R		Estate Engine M57306D3/M57D30TU2	GDS85079	Drive Shaft		30		58.7	73	653
330 xi (190 kW)	2005.09-		AT	L	R	Estate Engine N52B30A	GDS85039	Drive Shaft		30		58.7	73	610
	2005.09-		MT	L	R	Estate Engine N52B30A	GDS85039	Drive Shaft		30		58.7	73	610
	2005.09-		AT	R	R	Estate Engine N52B30A	GDS85038	Drive Shaft		30		58.7	73	663
	2005.09-		MT	R	R	Estate Engine N52B30A	GDS85038	Drive Shaft		30		58.7	73	663
335 D (210 kW)	2006.08-	2007.08	MT/AT	L	R	Estate Engine M57D30(306D5)	GDS85085	Drive Shaft		30		58.7	73	598
	2006.08-	2007.08		R	R	Estate Engine M57D30(306D5)	GDS85079	Drive Shaft		30		58.7	73	653
<b>3 TOURING (F31)</b>														
316 i (100 kW)	2013.03-		AT	L	R	Estate Engine N13B16A	GDS85107	Drive Shaft		28	27	57.4	71	749
318 D (105 kW)	2012.06-			L	R	Estate Engine N47D20C	GDS85066	Drive Shaft		28	27	57.4	71	739
	2012.06-			R	R	Estate Engine N47D20C	GDS85067	Drive Shaft		28	27	57.4	71	793
318 d xDrive (105 kW)	2013.01-			L	R	Estate Engine N47D20C	GDS85066	Drive Shaft		28	27	57.4	71	739
	2013.01-			R	R	Estate Engine N47D20C	GDS85067	Drive Shaft		28	27	57.4	71	793
320 D (120 kW)	2012.06-		MT/AT	L	R	Estate Engine N47D20C	GDS85066	Drive Shaft		28	27	57.4	71	739
	2012.06-		MT/AT	R	R	Estate Engine N47D20C	GDS85067	Drive Shaft		28	27	57.4	71	793
320 D (135 kW)	2012.06-			L	R	Estate Engine N47D20C	GDS85066	Drive Shaft		28	27	57.4	71	739
	2012.06-			R	R	Estate Engine N47D20C	GDS85067	Drive Shaft		28	27	57.4	71	793
320 d xDrive (135 kW)	2012.06-		MT/AT	L	R	Estate Engine N47D20C	GDS85066	Drive Shaft		28	27	57.4	71	739
	2012.06-		MT/AT	R	R	Estate Engine N47D20C	GDS85067	Drive Shaft		28	27	57.4	71	793
<b>5 (E34)</b>														
518 i (83 kW)	1989.08-	1995.09	MT/AT	L/R	R	Saloon Engine M40B18	GDS85001	Drive Shaft					32	465
	1989.08-	1995.09	MT/AT		R	Saloon Engine M40B18	GCI99052	Inner Joint		25			32	
518 i (85 kW)	1989.08-	1995.09	MT/AT	L/R	R	Saloon Engine M43B18	GDS85001	Drive Shaft					32	465
	1989.08-	1995.09	MT/AT		R	Saloon Engine M43B18	GCI99052	Inner Joint		25			32	
520 i (95 kW)	1988.01-	1991.08	MT/AT	L/R	R	Saloon Engine M20B20	GDS85001	Drive Shaft					32	465
	1988.01-	1991.08	MT/AT		R	Saloon Engine M20B20	GCI99052	Inner Joint		25			32	
520 i 24V (110 kW)	1989.09-	1995.09	AT	L/R	R	Saloon Engine M50B20/M50B20TU/M50B(206S1)/M50B(206S2)/Vanos	GDS85001	Drive Shaft					32	465
	1989.09-	1995.09	AT		R	Saloon Engine M50B20/M50B20TU/M50B(206S1)/M50B(206S2)/Vanos	GCI99052	Inner Joint		25			32	
524 TD (85 kW)	1988.03-	1995.09	MT/AT	L/R	R	Saloon Engine M21D24/M21D24WA	GDS85001	Drive Shaft					32	465
	1988.03-	1995.09	MT/AT		R	Saloon Engine M21D24/M21D24WA	GCI99052	Inner Joint		25			32	
525 i (125 kW)	1988.01-	1991.08	MT/AT	L/R	R	Saloon Engine M20B25	GDS85001	Drive Shaft					32	465
	1988.01-	1991.08	MT/AT		R	Saloon Engine M20B25	GCI99052	Inner Joint		25			32	
525 i 24V (141 kW)	1989.09-	1995.09	MT/AT	L/R	R	Saloon Engine M50B25/M52B25(Vanos)/M50B25TU/M50B25(256S2)	GDS85001	Drive Shaft					32	465
	1989.09-	1995.09	MT/AT		R	Saloon Engine M50B25/M52B25(Vanos)/M50B25TU/M50B25(256S2)	GCI99052	Inner Joint		25			32	
525 iX 24V (141 kW)	1991.10-	1995.09	MT/AT	L/R	R	Saloon Engine M52B25(Vanos)	GDS85001	Drive Shaft					32	465
	1991.10-	1995.09	MT/AT		R	Saloon Engine M52B25(Vanos)	GCI99052	Inner Joint		25			32	
525 TD (85 kW)	1993.04-	1995.09	MT/AT	L/R	R	Saloon Engine M51D25	GDS85001	Drive Shaft					32	465
	1993.04-	1995.09	MT/AT		R	Saloon Engine M51D25	GCI99052	Inner Joint		25			32	
525 TDS (105 kW)	1991.09-	1995.09	MT/AT	L/R	R	Saloon Engine M51D25(Inter.)	GDS85001	Drive Shaft					32	465
	1991.09-	1995.09	MT/AT		R	Saloon Engine M51D25(Inter.)	GCI99052	Inner Joint		25			32	
530 i V8 (160 kW)	1992.09-	1995.09	AT	L/R	R	Saloon Engine M60B30/M60B30(308S1)	GDS85001	Drive Shaft					32	465
	1992.09-	1995.09	AT		R	Saloon Engine M60B30/M60B30(308S1)	GCI99052	Inner Joint		25			32	





		YEAR	TRANSM	L/R	F/R		G-AP Ref.	PRODUCT	ABS	Technical Specifications										
										A	B	C	H	L	P					
<b>BMW</b>																				
<b>5 (E39)</b>																				
525 D (120 kW)	2000.02-	2003.06	MT/AT		R	Saloon Engine M5725(256D1)/M57D25	GDS85064	Drive Shaft		30		58.9	73	618						
525 i (141 kW)	2000.09-	2003.06		L/R	R	Saloon Engine M54256S5/M54B25/M54B25(256S5)	GDS85021	Drive Shaft		30		59	73	615						
525 TDS (105 kW)	1996.01-	2003.06	MT/AT		R	Saloon Engine M51D25(INTER.)	GDS85064	Drive Shaft		30		58.9	73	618						
530 D (142 kW)	2000.09-	2003.06	MT/AT		R	Saloon Engine M57D30	GDS85064	Drive Shaft		30		58.9	73	618						
535 i (180 kW)	1999.04-	2003.06	MT		R	Saloon Engine M62B(358S2)/M62B35TU	GDS85064	Drive Shaft		30		58.9	73	618						
540 i (210 kW)	1996.04-	2003.06	MT		R	Saloon Engine M62B44(448S1)/M62B44(448S2)	GDS85064	Drive Shaft		30		58.9	73	618						
<b>5 (E60)</b>																				
520 D (110 kW)	2005.09-	2010.03	MT	L/R	R	Saloon Engine M47N204D4	GDS85091	Drive Shaft		30		58.7	73	658						
	2005.09-	2010.03	MT	L/R	R	Saloon Engine M47N204D4	GCI85033	Inner Joint		30	28	58.7	73	62						
	2005.09-	2010.03	MT	L/R	R	Saloon Engine M47N204D4	GCI61075	Inner Joint			28		26							
	2005.09-	2010.03	AT	L/R	R	Saloon Engine M47N204D4	GDS85082	Drive Shaft		30		58.7	73	653						
520 D (120 kW)	2005.09-	2007.08	MT	L/R	R	Saloon Engine M47D20(204D4)/N47D20A/N47D20C	GDS85091	Drive Shaft		30		58.7	73	658						
	2005.09-	2007.08	MT	L/R	R	Saloon Engine M47D20(204D4)/N47D20A/N47D20C	GCI85033	Inner Joint		30	28	58.7	73	62						
	2005.09-	2007.08	MT	L/R	R	Saloon Engine M47D20(204D4)/N47D20A/N47D20C	GCI61075	Inner Joint			28		26							
	2005.09-	2007.08	AT	L/R	R	Saloon Engine M47D20(204D4)/N47D20A/N47D20C	GDS85082	Drive Shaft		30		58.7	73	653						
520 D (130 kW)	2007.09-	2010.03	MT	L/R	R	Saloon Engine M47D20(204D4)/N47D20A/N47D20C	GDS85091	Drive Shaft		30		58.7	73	658						
	2007.09-	2010.03	MT	L/R	R	Saloon Engine M47D20(204D4)/N47D20A/N47D20C	GCI85033	Inner Joint		30	28	58.7	73	62						
	2007.09-	2010.03	MT	L/R	R	Saloon Engine M47D20(204D4)/N47D20A/N47D20C	GCI61075	Inner Joint			28		26							
	2007.09-	2010.03	AT	L/R	R	Saloon Engine M47D20(204D4)/N47D20A/N47D20C	GDS85082	Drive Shaft		30		58.7	73	653						
520 i (115 kW)	2006.04-	2009.12	AT	L/R	R	Saloon Engine N46B20B	GDS85082	Drive Shaft		30		58.7	73	653						
520 i (125 kW)	2003.07-	2010.03	AT	L/R	R	Saloon Engine M54B22(226S1)	GDS85082	Drive Shaft		30		58.7	73	653						
	2007.09-	2010.03	AT	L/R	R	Saloon Engine N43B20A	GDS85082	Drive Shaft		30		58.7	73	653						
523 i (130 kW)	2005.01-	2007.02	AT	L/R	R	Saloon Engine N52B25/N52B25A	GDS85082	Drive Shaft		30		58.7	73	653						
523 i (140 kW)	2007.03-	2007.08	AT	L/R	R	Saloon Engine N52B25A/N53B25A	GDS85082	Drive Shaft		30		58.7	73	653						
525 D (120 kW)	2004.12-	2010.03		L/R	R	Saloon Engine M57D(256D1)	GDS85073	Drive Shaft		30		58.8	73	649						
	2004.12-	2010.03	AT	L/R	R	Saloon Engine M57D(256D1)	GDS85082	Drive Shaft		30		58.7	73	653						
525 D (130 kW)	2004.03-	2007.02		L/R	R	Saloon Engine M57N256D4/M57D25TU	GDS85073	Drive Shaft		30		58.8	73	649						
	2004.03-	2007.02	AT	L/R	R	Saloon Engine M57N256D4/M57D25TU	GDS85082	Drive Shaft		30		58.7	73	653						
525 D (145 kW)	2007.03-	2007.08	MT	L/R	R	Saloon Engine M57306D3	GDS85073	Drive Shaft		30		58.8	73	649						
	2007.03-	2007.08	AT	L/R	R	Saloon Engine M57306D3	GDS85082	Drive Shaft		30		58.7	73	653						
525 d xDrive (145 kW)	2008.09-	2010.03	AT	L/R	R	Saloon Engine M57D30(306D3)	GDS85082	Drive Shaft		30		58.7	73	653						
525 i (141 kW)	2003.08-	2005.01	AT	L/R	R	Saloon Engine M54B25(256S5)	GDS85082	Drive Shaft		30		58.7	73	653						
525 i (160 kW)	2005.01-	2007.08	AT	L/R	R	Saloon Engine N52B25A/N52B25	GDS85082	Drive Shaft		30		58.7	73	653						
	2007.01-	2010.03	MT	L/R	R	Saloon Engine N53B30A/N53B30	GDS85091	Drive Shaft		30		58.7	73	658						
	2007.01-	2010.03	MT	L/R	R	Saloon Engine N53B30A/N53B30	GCI85033	Inner Joint		30	28	58.7	73	62						
	2007.01-	2010.03	MT	L/R	R	Saloon Engine N53B30A/N53B30	GCI61075	Inner Joint			28		26							
	2007.01-	2010.03	AT	L/R	R	Saloon Engine N53B30A/N53B30	GDS85082	Drive Shaft		30		58.7	73	653						
525 i xDrive (160 kW)	2008.09-	2010.03	AT	L/R	R	Saloon Engine N53B30A	GDS85082	Drive Shaft		30		58.7	73	653						
525 xD (145 kW)	2007.01-	2010.03	AT	L/R	R	Saloon Engine M57306D3	GDS85082	Drive Shaft		30		58.7	73	653						
525 xi (160 kW)	2005.07-	2010.03	AT	L/R	R	Saloon Engine N52B25A	GDS85082	Drive Shaft		30		58.7	73	653						
	2007.01-	2010.03	AT	L/R	R	Saloon Engine N53B30A	GDS85082	Drive Shaft		30		58.7	73	653						
530 D (155 kW)	2003.07-	2010.03	AT	L/R	R	Saloon Engine M57D30(306D2)/M57D30(306D3)	GDS85082	Drive Shaft		30		58.7	73	653						
530 D (160 kW)	2003.07-	2010.03		L/R	R	Saloon Engine N57D30(306D2)	GDS85073	Drive Shaft		30		58.8	73	649						
	2003.07-	2010.03	AT	L/R	R	Saloon Engine N57D30(306D2)	GDS85082	Drive Shaft		30		58.7	73	653						
530 D (170 kW)	2005.09-	2007.02		L/R	R	Saloon Engine M57306D3	GDS85073	Drive Shaft		30		58.8	73	649						
	2005.09-	2007.02	AT	L/R	R	Saloon Engine M57306D3	GDS85082	Drive Shaft		30		58.7	73	653						
530 D (173 kW)	2007.03-	2007.08		L/R	R	Saloon Engine M57D30(306D3)	GDS85073	Drive Shaft		30		58.8	73	649						
	2007.03-	2007.08	AT	L/R	R	Saloon Engine M57D30(306D3)	GDS85082	Drive Shaft		30		58.7	73	653						
530 d xDrive (173 kW)	2008.09-	2010.03	AT	L/R	R	Saloon Engine M57D30(306D3)	GDS85082	Drive Shaft		30		58.7	73	653						
530 i (170 kW)	2003.07-	2010.03	AT	L/R	R	Saloon Engine M54B30(306S3)	GDS85082	Drive Shaft		30		58.7	73	653						
530 i (187 kW)	2005.03-	2010.03	AT	L/R	R	Saloon Engine N52B30A	GDS85082	Drive Shaft		30		58.7	73	653						
530 i (190 kW)	2005.01-	2007.08	MT	L/R	R	Saloon Engine N52B30/N52B30A	GDS85091	Drive Shaft		30		58.7	73	658						
	2005.01-	2007.08	MT	L/R	R	Saloon Engine N52B30/N52B30A	GCI85033	Inner Joint		30	28	58.7	73	62						
	2005.01-	2007.08	MT	L/R	R	Saloon Engine N52B30/N52B30A	GCI61075	Inner Joint			28		26							
	2005.01-	2007.08	AT	L/R	R	Saloon Engine N52B30/N52B30A	GDS85082	Drive Shaft		30		58.7	73	653						
530 i (200 kW)	2007.03-	2007.08	MT	L/R	R	Saloon Engine N52B30A/N53B30A	GDS85091	Drive Shaft		30		58.7	73	658						
	2007.03-	2007.08	MT	L/R	R	Saloon Engine N52B30A/N53B30A	GCI85033	Inner Joint		30	28	58.7	73	62						
	2007.03-	2007.08	MT	L/R	R	Saloon Engine N52B30A/N53B30A	GCI61075	Inner Joint			28		26							
	2007.03-	2007.08	AT	L/R	R	Saloon Engine N52B30A/N53B30A	GDS85082	Drive Shaft		30		58.7	73	653						
530 i xDrive (200 kW)	2008.09-	2010.03	AT	L/R	R	Saloon Engine N52B30A/N53B30A	GDS85082	Drive Shaft		30		58.7	73	653						
530 xD (170 kW)	2005.07-	2010.03	AT	L/R	R	Saloon Engine M57306D3	GDS85073	Drive Shaft		30		58.8	73	649						
	2005.07-	2010.03	AT	L/R	R	Saloon Engine M57306D3	GDS85082	Drive Shaft		30		58.7	73	653						



		TRANSM	L/R	F/R		G-AP Ref.	PRODUCT	ABS	Technical Specifications									
									YEAR	A	B	C	H	L	P			
<b>BMW</b>																		
<b>5 (E60)</b>																		
530 xD (173 kW)	2007.01-	2010.03	AT	L/R	R	Saloon Engine M57D30(306D3)	GDS85082	Drive Shaft		30		58.7	73	653				
530 xi (190 kW)	2005.07-	2010.03	AT	L/R	R	Saloon Engine N52B30A	GDS85082	Drive Shaft		30		58.7	73	653				
530 xi (200 kW)	2007.01-	2010.03	AT	L/R	R	Saloon Engine N52B30A/N53B30A	GDS85082	Drive Shaft		30		58.7	73	653				
535 D (200 kW)	2004.07-	2007.08		L/R	R	Saloon Engine M57D30(306D4)	GDS85073	Drive Shaft		30		58.8	73	649				
	2004.07-	2007.08	AT	L/R	R	Saloon Engine M57D30(306D4)	GDS85082	Drive Shaft		30		58.7	73	653				
535 D (210 kW)	2007.03-	2007.08		L/R	R	Saloon Engine M57D30(306D5)	GDS85073	Drive Shaft		30		58.8	73	649				
	2007.03-	2007.08	AT	L/R	R	Saloon Engine M57D30(306D5)	GDS85082	Drive Shaft		30		58.7	73	653				
540 i (225 kW)	2005.09-	2007.08	MT	L/R	R	Saloon Engine N62B40A	GDS85073	Drive Shaft		30		58.8	73	649				
545 i (245 kW)	2003.08-	2005.12	MT	L/R	R	Saloon Engine N62B44A	GDS85073	Drive Shaft		30		58.8	73	649				
550 i (270 kW)	2005.09-	2007.08	MT	L/R	R	Saloon Engine N62B48B/N62B48A	GDS85073	Drive Shaft		30		58.8	73	649				
<b>5 TOURING (E34)</b>																		
518 G (85 kW)	1995.11-	1996.06	MT/AT	L/R	R	Estate Engine M43B18	GDS85001	Drive Shaft					32	465				
	1995.11-	1996.06	MT/AT		R	Estate Engine M43B18	GCI99052	Inner Joint		25			32					
518 i (83 kW)	1993.03-	1994.09	MT/AT	L/R	R	Estate Engine M40B18	GDS85001	Drive Shaft					32	465				
	1993.03-	1994.09	MT/AT		R	Estate Engine M40B18	GCI99052	Inner Joint		25			32					
518 i (85 kW)	1994.09-	1997.01	MT/AT	L/R	R	Estate Engine M43B18	GDS85001	Drive Shaft					32	465				
	1994.09-	1997.01	MT/AT		R	Estate Engine M43B18	GCI99052	Inner Joint		25			32					
520 i (110 kW)	1991.11-	1997.01	AT	L/R	R	Estate Engine M50B20TU/M50B(206S1)/M50B(206S2)/Vanos/M50B20	GDS85001	Drive Shaft					32	465				
	1991.11-	1997.01	AT		R	Estate Engine M50B20TU/M50B(206S1)/M50B(206S2)/Vanos/M50B20	GCI99052	Inner Joint		25			32					
525 i (141 kW)	1991.11-	1997.01	AT	L/R	R	Estate Engine M50B25/M50B25(256S1)/M50B25(256S2)/M50B25TU	GDS85001	Drive Shaft					32	465				
	1991.11-	1997.01	AT		R	Estate Engine M50B25/M50B25(256S1)/M50B25(256S2)/M50B25TU	GCI99052	Inner Joint		25			32					
525 ix (141 kW)	1992.02-	1997.01	MT/AT	L/R	R	Estate Engine M50B25/M52B25(Vanos)	GDS85001	Drive Shaft					32	465				
	1992.02-	1997.01	MT/AT		R	Estate Engine M50B25/M52B25(Vanos)	GCI99052	Inner Joint		25			32					
525 TD (85 kW)	1993.03-	1997.01	MT/AT	L/R	R	Estate Engine M51D25	GDS85001	Drive Shaft					32	465				
	1993.03-	1997.01	MT/AT		R	Estate Engine M51D25	GCI99052	Inner Joint		25			32					
525 TDS (105 kW)	1991.12-	1997.01	MT/AT	L/R	R	Estate Engine M51D25(Inter.)	GDS85001	Drive Shaft					32	465				
	1991.12-	1997.01	MT/AT		R	Estate Engine M51D25(Inter.)	GCI99052	Inner Joint		25			32					
530 i V8 (160 kW)	1992.09-	1997.01	AT	L/R	R	Estate Engine M60B30/M60B30(308S1)	GDS85001	Drive Shaft					32	465				
	1992.09-	1997.01	AT		R	Estate Engine M60B30/M60B30(308S1)	GCI99052	Inner Joint		25			32					
<b>5 TOURING (E39)</b>																		
525 D (120 kW)	2000.02-	2004.05	MT/AT		R	Estate Engine M57D25(256D1)/M57D25	GDS85064	Drive Shaft		30		58.9	73	618				
525 i (141 kW)	2000.09-	2004.05		L/R	R	Estate Engine M54B25(256S5)	GDS85021	Drive Shaft		30		59	73	615				
525 TDS (105 kW)	1997.03-	2004.05	MT/AT		R	Estate Engine M51D25(inter.)	GDS85064	Drive Shaft		30		58.9	73	618				
530 D (142 kW)	2000.09-	2004.05	MT		R	Estate Engine M57D30(306D1)	GDS85064	Drive Shaft		30		58.9	73	618				
540 i (210 kW)	1997.01-	2004.05	MT		R	Estate Engine M62B44(448S1)/M62B44(448S2)	GDS85064	Drive Shaft		30		58.9	73	618				
<b>5 TOURING (E61)</b>																		
520 D (110 kW)	2005.09-		MT	L/R	R	Estate Engine M47D20(204D4)/M47D20A/M47D20C	GDS85091	Drive Shaft		30		58.7	73	658				
	2005.09-		MT	L/R	R	Estate Engine M47D20(204D4)/M47D20A/M47D20C	GCI85033	Inner Joint		30	28	58.7	73	62				
	2005.09-		MT	L/R	R	Estate Engine M47D20(204D4)/M47D20A/M47D20C	GCI61075	Inner Joint		28			26					
	2005.09-		AT	L/R	R	Estate Engine M47D20(204D4)/M47D20A/M47D20C	GDS85082	Drive Shaft		30		58.7	73	653				
520 D (120 kW)	2005.09-	2007.08	MT	L/R	R	Estate Engine N47D20A/N47D20C/M47D20(204D4)	GDS85091	Drive Shaft		30		58.7	73	658				
	2005.09-	2007.08	MT	L/R	R	Estate Engine N47D20A/N47D20C/M47D20(204D4)	GCI85033	Inner Joint		30	28	58.7	73	62				
	2005.09-	2007.08	MT	L/R	R	Estate Engine N47D20A/N47D20C/M47D20(204D4)	GCI61075	Inner Joint		28			26					
	2005.09-	2007.08	AT	L/R	R	Estate Engine N47D20A/N47D20C/M47D20(204D4)	GDS85082	Drive Shaft		30		58.7	73	653				
520 D (130 kW)	2007.09-		MT	L/R	R	Estate Engine N47D20A/N47D20C	GDS85091	Drive Shaft		30		58.7	73	658				
	2007.09-		MT	L/R	R	Estate Engine N47D20A/N47D20C	GCI85033	Inner Joint		30	28	58.7	73	62				
	2007.09-		MT	L/R	R	Estate Engine N47D20A/N47D20C	GCI61075	Inner Joint		28			26					
	2007.09-		AT	L/R	R	Estate Engine N47D20A/N47D20C	GDS85082	Drive Shaft		30		58.7	73	653				
520 i (120 kW)	2007.07-	2010.08	AT	L/R	R	Estate Engine N43 B20 A	GDS85082	Drive Shaft		30		58.7	73	653				
520 i (125 kW)	2007.09-		AT	L/R	R	Estate Engine N43B20A	GDS85082	Drive Shaft		30		58.7	73	653				
523 i (130 kW)	2005.01-	2007.02	AT	L/R	R	Estate Engine N52B25A/N52B25	GDS85082	Drive Shaft		30		58.7	73	653				
523 i (140 kW)	2007.03-	2007.08	AT	L/R	R	Estate Engine N52B25A/N53B25A	GDS85082	Drive Shaft		30		58.7	73	653				
525 D (120 kW)	2004.12-			L/R	R	Estate Engine M57N256D4	GDS85073	Drive Shaft		30		58.8	73	649				
	2004.12-		AT	L/R	R	Estate Engine M57N256D4	GDS85082	Drive Shaft		30		58.7	73	653				
525 D (130 kW)	2004.06-			L/R	R	Estate Engine M57N256D4/M57D25TU	GDS85073	Drive Shaft		30		58.8	73	649				
	2004.06-		AT	L/R	R	Estate Engine M57N256D4/M57D25TU	GDS85082	Drive Shaft		30		58.7	73	653				
525 D (145 kW)	2007.03-	2007.08	MT	L/R	R	Estate Engine M57D30(306D3)	GDS85073	Drive Shaft		30		58.8	73	649				
	2007.03-	2007.08	AT	L/R	R	Estate Engine M57D30(306D3)	GDS85082	Drive Shaft		30		58.7	73	653				
525 d xDrive (145 kW)	2008.09-		AT	L/R	R	Estate Engine M57D30(306D3)	GDS85082	Drive Shaft		30		58.7	73	653				
525 i (141 kW)	2004.06-		AT	L/R	R	Estate Engine M54B25(256S5)	GDS85082	Drive Shaft		30		58.7	73	653				
525 i (160 kW)	2005.01-	2007.02	AT	L/R	R	Estate Engine N52B25A/N52B25	GDS85082	Drive Shaft		30		58.7	73	653				
	2007.03-	2007.08	MT	L/R	R	Estate Engine N53B30A/N53B30	GDS85091	Drive Shaft		30		58.7	73	658				





		YEAR	TRANSM	L/R	F/R		G-AP Ref.	PRODUCT	ABS	Technical Specifications							
										A	B	C	H	L	P		
<b>BMW</b>																	
<b>5 TOURING (E61)</b>																	
525 i (160 kW)	2007.03-	2007.08	MT	L/R	R	Estate Engine N53B30A/N53B30	GCI85033	Inner Joint		30	28	58.7	73	62			
	2007.03-	2007.08	MT	L/R	R	Estate Engine N53B30A/N53B30	GCI161075	Inner Joint			28		26				
	2007.03-	2007.08	AT	L/R	R	Estate Engine N53B30A/N53B30	GDS85082	Drive Shaft		30		58.7	73	653			
525 i xDrive (160 kW)	2008.09-		AT	L/R	R	Estate Engine N53B30A	GDS85082	Drive Shaft		30		58.7	73	653			
525 xD (145 kW)	2007.01-		AT	L/R	R	Estate Engine M57306D3	GDS85082	Drive Shaft		30		58.7	73	653			
525 xi (160 kW)	2005.07-		AT	L/R	R	Estate Engine N52B25A	GDS85082	Drive Shaft		30		58.7	73	653			
	2007.01-		AT	L/R	R	Estate Engine N53B30A/N52B30A	GDS85082	Drive Shaft		30		58.7	73	653			
530 D (155 kW)	2005.11-		AT	L/R	R	Estate Engine M57D30(306D3)	GDS85082	Drive Shaft		30		58.7	73	653			
530 D (160 kW)	2004.06-			L/R	R	Estate Engine N57D30(306D2)	GDS85073	Drive Shaft		30		58.8	73	649			
	2004.06-		AT	L/R	R	Estate Engine N57D30(306D2)	GDS85082	Drive Shaft		30		58.7	73	653			
530 D (170 kW)	2005.09-	2007.02		L/R	R	Estate Engine M57306D3	GDS85073	Drive Shaft		30		58.8	73	649			
	2005.09-	2007.02	AT	L/R	R	Estate Engine M57306D3	GDS85082	Drive Shaft		30		58.7	73	653			
530 D (173 kW)	2007.03-	2007.08		L/R	R	Estate Engine M57D30(306D3)	GDS85073	Drive Shaft		30		58.8	73	649			
	2007.03-	2007.08	AT	L/R	R	Estate Engine M57D30(306D3)	GDS85082	Drive Shaft		30		58.7	73	653			
530 d xDrive (173 kW)	2008.09-		AT	L/R	R	Estate Engine M57D30(306D3)	GDS85082	Drive Shaft		30		58.7	73	653			
530 i (190 kW)	2005.01-	2007.08	MT	L/R	R	Estate Engine N52B30A/N52B30	GDS85091	Drive Shaft		30		58.7	73	658			
	2005.01-	2007.08	MT	L/R	R	Estate Engine N52B30A/N52B30	GCI85033	Inner Joint		30	28	58.7	73	62			
	2005.01-	2007.08	MT	L/R	R	Estate Engine N52B30A/N52B30	GCI161075	Inner Joint			28		26				
	2005.01-	2007.08	AT	L/R	R	Estate Engine N52B30A/N52B30	GDS85082	Drive Shaft		30		58.7	73	653			
530 i (200 kW)	2007.03-	2007.08	MT	L/R	R	Estate Engine N52B30A/N53B30A	GDS85091	Drive Shaft		30		58.7	73	658			
	2007.03-	2007.08	MT	L/R	R	Estate Engine N52B30A/N53B30A	GCI85033	Inner Joint		30	28	58.7	73	62			
	2007.03-	2007.08	MT	L/R	R	Estate Engine N52B30A/N53B30A	GCI161075	Inner Joint			28		26				
	2007.03-	2007.08	AT	L/R	R	Estate Engine N52B30A/N53B30A	GDS85082	Drive Shaft		30		58.7	73	653			
530 i xDrive (200 kW)	2008.09-		AT	L/R	R	Estate Engine N53B30A/N52B30A	GDS85082	Drive Shaft		30		58.7	73	653			
530 xD (170 kW)	2005.07-		AT	L/R	R	Estate Engine M57306D3	GDS85073	Drive Shaft		30		58.8	73	649			
	2005.07-		AT	L/R	R	Estate Engine M57306D3	GDS85082	Drive Shaft		30		58.7	73	653			
530 xD (173 kW)	2007.01-		AT	L/R	R	Estate Engine M57306D3	GDS85082	Drive Shaft		30		58.7	73	653			
530 xi (190 kW)	2005.07-		AT	L/R	R	Estate Engine N52B30A	GDS85082	Drive Shaft		30		58.7	73	653			
530 xi (200 kW)	2007.01-		AT	L/R	R	Estate Engine N53B30A/N52B30A	GDS85082	Drive Shaft		30		58.7	73	653			
535 D (200 kW)	2004.07-	2007.08		L/R	R	Estate Engine M57D30(306D4)	GDS85073	Drive Shaft		30		58.8	73	649			
	2004.07-	2007.08	AT	L/R	R	Estate Engine M57D30(306D4)	GDS85082	Drive Shaft		30		58.7	73	653			
535 D (210 kW)	2007.03-	2007.08		L/R	R	Estate Engine M57D30(306D5)	GDS85073	Drive Shaft		30		58.8	73	649			
	2007.03-	2007.08	AT	L/R	R	Estate Engine M57D30(306D5)	GDS85082	Drive Shaft		30		58.7	73	653			
545 i (245 kW)	2004.06-		MT	L/R	R	Estate Engine N62B44A	GDS85073	Drive Shaft		30		58.8	73	649			
550 i (270 kW)	2005.09-	2007.08	MT	L/R	R	Estate Engine N62B48A/N62B48B	GDS85073	Drive Shaft		30		58.8	73	649			
<b>6 (E63)</b>																	
630 i (190 kW)	2004.09-	2007.08	MT	L/R	R	Coupe Engine N52B30A/N52B30A	GDS85091	Drive Shaft		30		58.7	73	658			
	2004.09-	2007.08	MT	L/R	R	Coupe Engine N52B30A/N52B30A	GCI85033	Inner Joint		30	28	58.7	73	62			
	2004.09-	2007.08	MT	L/R	R	Coupe Engine N52B30A/N52B30A	GCI161075	Inner Joint			28		26				
630 i (200 kW)	2007.07-			L/R	R	Coupe Engine N53B30/N52B30A	GDS85091	Drive Shaft		30		58.7	73	658			
	2007.07-			L/R	R	Coupe Engine N53B30/N52B30A	GCI85033	Inner Joint		30	28	58.7	73	62			
	2007.07-			L/R	R	Coupe Engine N53B30/N52B30A	GCI161075	Inner Joint			28		26				
635 D (210 kW)	2007.07-			L/R	R	Coupe Engine M57D30(306D5)	GDS85073	Drive Shaft		30		58.8	73	649			
645 Ci (245 kW)	2004.01-			L/R	R	Coupe Engine N62B44/N62B44A	GDS85073	Drive Shaft		30		58.8	73	649			
650 i (270 kW)	2005.09-	2007.08	MT	L/R	R	Coupe Engine N62B48B	GDS85073	Drive Shaft		30		58.8	73	649			
<b>6 (E64)</b>																	
630 i (190 kW)	2004.09-	2007.08	MT	L/R	R	Convertible Engine N52B30A/N52B30	GDS85091	Drive Shaft		30		58.7	73	658			
	2004.09-	2007.08	MT	L/R	R	Convertible Engine N52B30A/N52B30	GCI85033	Inner Joint		30	28	58.7	73	62			
	2004.09-	2007.08	MT	L/R	R	Convertible Engine N52B30A/N52B30	GCI161075	Inner Joint			28		26				
630 i (200 kW)	2007.07-			L/R	R	Convertible Engine N53B30/N53B30A	GDS85091	Drive Shaft		30		58.7	73	658			
	2007.07-			L/R	R	Convertible Engine N53B30/N53B30A	GCI85033	Inner Joint		30	28	58.7	73	62			
	2007.07-			L/R	R	Convertible Engine N53B30/N53B30A	GCI161075	Inner Joint			28		26				
635 D (210 kW)	2007.07-			L/R	R	Convertible Engine M57D30(306D5)	GDS85073	Drive Shaft		30		58.8	73	649			
645 Ci (245 kW)	2004.04-		MT	L/R	R	Convertible Engine N62B44/N62B44A	GDS85073	Drive Shaft		30		58.8	73	649			
650 i (270 kW)	2005.09-	2007.08	MT	L/R	R	Convertible Engine N62B48B	GDS85073	Drive Shaft		30		58.8	73	649			
<b>7 (E65, E66, E67)</b>																	
730 D (160 kW)	2002.10-			L/R	R	Saloon Engine M57D30(306D2)	GDS85073	Drive Shaft		30		58.8	73	649			
730 LD (170 kW)	2005.07-			L/R	R	Saloon Engine M57D30(306D3)/N57N306D2	GDS85073	Drive Shaft		30		58.8	73	649			
<b>X3 (E83)</b>																	
1.8 D (105 kW)	2006-						GC085010	Outer Joint		30	33	64.8	77	60	M		
2.0 D (110 kW)	2004.09-	2007.08				Closed Off-Road Vehicle Engine M47D20(204D4)	GC085010	Outer Joint		30	33	64.8	77	60	M		
	2004.09-	2007.08	MT	R		Closed Off-Road Vehicle Engine M47D20(204D4)	GDS85074	Drive Shaft	48W	30		69	73	675			





		TRANSM	L/R	F/R		G-AP Ref.	PRODUCT	ABS	Technical Specifications									
									YEAR	A	B	C	H	L	P			
<b>BMW</b>																		
<b>X3 (E83)</b>																		
2.0 D (110 kW)	2004.09-	2007.08	MT/AT	R		Closed Off-Road Vehicle Engine M47D20(204D4)	GDS85078	Drive Shaft		30	27	64.8	77	919				
	2004.09-	2007.08	MT/AT	L	F	Closed Off-Road Vehicle Engine M47D20(204D4)	GDS99215	Drive Shaft		30	27	64.8	77	598				
	2004.09-	2007.08	MT	R	F	Closed Off-Road Vehicle Engine M47D20(204D4)	GDS85044	Drive Shaft		30	27	64.8	77	921				
	2004.09-	2007.08	MT	L	R	Closed Off-Road Vehicle Engine M47D20(204D4)	GDS85062	Drive Shaft	48W	30		69	73	621				
	2004.09-	2007.08	AT	R	R	Closed Off-Road Vehicle Engine M47D20(204D4)	GDS85093	Drive Shaft	48W	30		69	73	678				
	2004.09-	2007.08	MT	R	R	Closed Off-Road Vehicle Engine M47D20(204D4)	GDS85074	Drive Shaft	48W	30		69	73	675				
	2004.10-						GC085010	Outer Joint		30	33	64.8	77	60	M			
2.0 D (130 kW)	2007.09-					Closed Off-Road Vehicle Engine N47D20A	GC085010	Outer Joint		30	33	64.8	77	60	M			
	2007.09-		AT	L	R	Closed Off-Road Vehicle Engine N47D20A	GDS85062	Drive Shaft	48W	30		69	73	621				
	2007.09-		MT	R	R	Closed Off-Road Vehicle Engine N47D20A	GDS85074	Drive Shaft	48W	30		69	73	675				
	2007.09-		MT	R	F	Closed Off-Road Vehicle Engine N47D20A	GDS85044	Drive Shaft		30	27	64.8	77	921				
	2007.09-		AT	R	R	Closed Off-Road Vehicle Engine N47D20A	GDS85093	Drive Shaft	48W	30		69	73	678				
	2007.09-						GC085010	Outer Joint		30	33	64.8	77	60	M			
2.0 i (110 kW)	2005.07-						GC085010	Outer Joint		30	33	64.8	77	60	M			
	2005.09-	2006.07	MT	R		Closed Off-Road Vehicle Engine N46B20/N46B20B	GDS85074	Drive Shaft	48W	30		69	73	675				
	2005.09-	2006.07		L	F	Closed Off-Road Vehicle Engine N46B20/N46B20B	GDS99215	Drive Shaft		30	27	64.8	77	598				
	2005.09-	2006.07	MT	R	F	Closed Off-Road Vehicle Engine N46B20/N46B20B	GDS85044	Drive Shaft		30	27	64.8	77	921				
	2005.09-	2006.07		L	R	Closed Off-Road Vehicle Engine N46B20/N46B20B	GDS85062	Drive Shaft	48W	30		69	73	621				
2.5 i (141 kW)	2004.01-						GC085010	Outer Joint		30	33	64.8	77	60	M			
	2004.03-	2006.07				Closed Off-Road Vehicle Engine M54B25(256S5)	GC085010	Outer Joint		30	33	64.8	77	60	M			
	2004.03-	2006.07	MT/AT	R		Closed Off-Road Vehicle Engine M54B25(256S5)	GDS85078	Drive Shaft		30	27	64.8	77	919				
	2004.03-	2006.07	MT/AT	L	F	Closed Off-Road Vehicle Engine M54B25(256S5)	GDS99215	Drive Shaft		30	27	64.8	77	598				
	2004.03-	2006.07	MT/AT	R	F	Closed Off-Road Vehicle Engine M54B25(256S5)	GDS85044	Drive Shaft		30	27	64.8	77	921				
	2004.03-	2006.07	AT	L	R	Closed Off-Road Vehicle Engine M54B25(256S5)	GDS85069	Drive Shaft	48W	30		69	73	625				
	2004.03-	2006.07	MT	L	R	Closed Off-Road Vehicle Engine M54B25(256S5)	GDS85062	Drive Shaft	48W	30		69	73	621				
	2004.03-	2006.07	AT	R	R	Closed Off-Road Vehicle Engine M54B25(256S5)	GDS85093	Drive Shaft	48W	30		69	73	678				
	2004.03-	2006.07	MT	R	R	Closed Off-Road Vehicle Engine M54B25(256S5)	GDS85074	Drive Shaft	48W	30		69	73	675				
2.5 Si (160 kW)	2006.08-	2007.08				Closed Off-Road Vehicle Engine N52B25A	GC085010	Outer Joint		30	33	64.8	77	60	M			
	2006.08-	2007.08		R		Closed Off-Road Vehicle Engine N52B25A	GDS85078	Drive Shaft		30	27	64.8	77	919				
	2006.08-	2007.08		L	F	Closed Off-Road Vehicle Engine N52B25A	GDS99215	Drive Shaft		30	27	64.8	77	598				
	2006.08-	2007.08	MT/AT	R	F	Closed Off-Road Vehicle Engine N52B25A	GDS85044	Drive Shaft		30	27	64.8	77	921				
	2006.08-	2007.08	AT	L	R	Closed Off-Road Vehicle Engine N52B25A	GDS85069	Drive Shaft	48W	30		69	73	625				
	2006.09-						GC085010	Outer Joint		30	33	64.8	77	60	M			
3.0 D (150 kW)	2004.01-					Closed Off-Road Vehicle Engine M57D30(306D2)	GC085010	Outer Joint		30	33	64.8	77	60	M			
	2004.01-		AT	R		Closed Off-Road Vehicle Engine M57D30(306D2)	GDS85074	Drive Shaft	48W	30		69	73	675				
	2004.01-		MT/AT	R		Closed Off-Road Vehicle Engine M57D30(306D2)	GDS85078	Drive Shaft		30	27	64.8	77	919				
	2004.01-		MT	L	R	Closed Off-Road Vehicle Engine M57D30(306D2)	GDS85062	Drive Shaft	48W	30		69	73	621				
	2004.01-		MT	R	R	Closed Off-Road Vehicle Engine M57D30(306D2)	GDS85074	Drive Shaft	48W	30		69	73	675				
	2004.01-		MT/AT	L	F	Closed Off-Road Vehicle Engine M57D30(306D2)	GDS99215	Drive Shaft		30	27	64.8	77	598				
	2004.01-		MT/AT	R	F	Closed Off-Road Vehicle Engine M57D30(306D2)	GDS85044	Drive Shaft		30	27	64.8	77	921				
	2004.01-			L	R	Closed Off-Road Vehicle Engine M57D30(306D2)	GDS85069	Drive Shaft	48W	30		69	73	625				
	2004.01-						GC085010	Outer Joint		30	33	64.8	77	60	M			
3.0 D (160 kW)	2004.01-						GC085010	Outer Joint		30	33	64.8	77	60	M			
	2005.09-	2007.08	AT	L	R	Closed Off-Road Vehicle Engine M57D30(306D3)/M57N2306D2	GDS85069	Drive Shaft	48W	30		69	73	625				
	2005.09-	2007.08	Semi-AT	L	R	Closed Off-Road Vehicle Engine M57D30(306D3)/M57N2306D2	GDS85062	Drive Shaft	48W	30		69	73	621				
	2005.09-	2007.08		R	R	Closed Off-Road Vehicle Engine M57D30(306D3)/M57N2306D2	GDS85074	Drive Shaft	48W	30		69	73	675				
	2005.09-	2007.08				Closed Off-Road Vehicle Engine M57D30(306D3)/M57N2306D2	GC085010	Outer Joint		30	33	64.8	77	60	M			
	2005.09-	2007.08	MT/Semi-AT	R		Closed Off-Road Vehicle Engine M57D30(306D3)/M57N2306D2	GDS85078	Drive Shaft		30	27	64.8	77	919				
	2005.09-	2007.08	MT/Semi-AT	L	F	Closed Off-Road Vehicle Engine M57D30(306D3)/M57N2306D2	GDS99215	Drive Shaft		30	27	64.8	77	598				
	2005.09-	2007.08	MT/AT	R	F	Closed Off-Road Vehicle Engine M57D30(306D3)/M57N2306D2	GDS85044	Drive Shaft		30	27	64.8	77	921				
	2004.01-						GC085010	Outer Joint		30	33	64.8	77	60	M			
	3.0 i (170 kW)	2004.03-	2006.07				Closed Off-Road Vehicle Engine M54B30(306S3)	GC085010	Outer Joint		30	33	64.8	77	60	M		
2004.03-		2006.07	MT	R		Closed Off-Road Vehicle Engine M54B30(306S3)	GDS85074	Drive Shaft	48W	30		69	73	675				
2004.03-		2006.07	MT/AT	R		Closed Off-Road Vehicle Engine M54B30(306S3)	GDS85078	Drive Shaft		30	27	64.8	77	919				
2004.03-		2006.07	MT/AT	L	F	Closed Off-Road Vehicle Engine M54B30(306S3)	GDS99215	Drive Shaft		30	27	64.8	77	598				
2004.03-		2006.07	MT/AT	R	F	Closed Off-Road Vehicle Engine M54B30(306S3)	GDS85044	Drive Shaft		30	27	64.8	77	921				
2004.03-		2006.07	AT	L	R	Closed Off-Road Vehicle Engine M54B30(306S3)	GDS85069	Drive Shaft	48W	30		69	73	625				
2004.03-		2006.07	MT	L	R	Closed Off-Road Vehicle Engine M54B30(306S3)	GDS85062	Drive Shaft	48W	30		69	73	621				
2004.03-		2006.07	AT	R	R	Closed Off-Road Vehicle Engine M54B30(306S3)	GDS85093	Drive Shaft	48W	30		69	73	678				
2004.03-		2006.07	MT	R	R	Closed Off-Road Vehicle Engine M54B30(306S3)	GDS85074	Drive Shaft	48W	30		69	73	675				
3.0 SD (210 kW)	2006.08-	2007.08				Closed Off-Road Vehicle Engine M57D30(306D5)	GC085010	Outer Joint		30	33	64.8	77	60	M			
	2006.08-	2007.08		R		Closed Off-Road Vehicle Engine M57D30(306D5)	GDS85078	Drive Shaft		30	27	64.8	77	919				
	2006.08-	2007.08		L	F	Closed Off-Road Vehicle Engine M57D30(306D5)	GDS99215	Drive Shaft		30	27	64.8	77	598				



		YEAR	TRANSM	L/R	F/R		G-AP Ref.	PRODUCT	ABS	Technical Specifications								
										A	B	C	H	L	P			
<b>BMW</b>																		
<b>X3 (E83)</b>																		
3.0 SD (210 kW)	2006.08-	2007.08		L	R	Closed Off-Road Vehicle Engine M57D30(306D5)	GDS85062	Drive Shaft	48W	30		69	73	621				
	2006.09-						GC085010	Outer Joint		30	33	64.8	77	60	M			
3.0 Si (200 kW)	2006.08-	2007.08				Closed Off-Road Vehicle Engine N52B30A	GC085010	Outer Joint		30	33	64.8	77	60	M			
	2006.08-	2007.08		R		Closed Off-Road Vehicle Engine N52B30A	GDS85078	Drive Shaft		30	27	64.8	77	919				
	2006.08-	2007.08		L	F	Closed Off-Road Vehicle Engine N52B30A	GDS99215	Drive Shaft		30	27	64.8	77	598				
	2006.08-	2007.08	MT/AT	R	F	Closed Off-Road Vehicle Engine N52B30A	GDS85044	Drive Shaft		30	27	64.8	77	921				
	2006.08-	2007.08	AT	L	R	Closed Off-Road Vehicle Engine N52B30A	GDS85069	Drive Shaft	48W	30		69	73	625				
xDrive 18 D (105 kW)	2008.09-					Closed Off-Road Vehicle Engine N47D20C	GC085010	Outer Joint		30	33	64.8	77	60	M			
	2008.09-			L	R	Closed Off-Road Vehicle Engine N47D20C	GDS85062	Drive Shaft	48W	30		69	73	621				
	2008.09-			R	R	Closed Off-Road Vehicle Engine N47D20C	GDS85074	Drive Shaft	48W	30		69	73	675				
	2008.09-		AT	L	R	Closed Off-Road Vehicle Engine N47D20C	GDS85069	Drive Shaft	48W	30		69	73	625				
xDrive 20 D (120 kW)	2008.09-		MT	L	R	Closed Off-Road Vehicle Engine N47D20C	GDS85062	Drive Shaft	48W	30		69	73	621				
	2008.09-		MT	R	R	Closed Off-Road Vehicle Engine N47D20C	GDS85074	Drive Shaft	48W	30		69	73	675				
	2008.09-		AT	R	R	Closed Off-Road Vehicle Engine N47D20C	GDS85093	Drive Shaft	48W	30		69	73	678				
xDrive 20 D (130 kW)	2008.09-					Closed Off-Road Vehicle Engine N47D20C	GC085010	Outer Joint		30	33	64.8	77	60	M			
	2008.09-		MT	L	R	Closed Off-Road Vehicle Engine N47D20C	GDS85062	Drive Shaft	48W	30		69	73	621				
	2008.09-		MT	R	R	Closed Off-Road Vehicle Engine N47D20C	GDS85074	Drive Shaft	48W	30		69	73	675				
	2008.09-		MT	R	F	Closed Off-Road Vehicle Engine N47D20C	GDS85044	Drive Shaft		30	27	64.8	77	921				
	2008.09-		AT	L	R	Closed Off-Road Vehicle Engine N47D20C	GDS85069	Drive Shaft	48W	30		69	73	625				
xDrive 20 i (110 kW)	2008.09-				R	Closed Off-Road Vehicle Engine N46B20B	GDS85074	Drive Shaft	48W	30		69	73	675				
	2008.09-			L	R	Closed Off-Road Vehicle Engine N46B20B	GDS85062	Drive Shaft	48W	30		69	73	621				
xDrive 25 i (160 kW)	2008.09-					Closed Off-Road Vehicle Engine N52B25A	GC085010	Outer Joint		30	33	64.8	77	60	M			
	2008.09-			L	R	Closed Off-Road Vehicle Engine N52B25A	GDS85062	Drive Shaft	48W	30		69	73	621				
	2008.09-			R	R	Closed Off-Road Vehicle Engine N52B25A	GDS85074	Drive Shaft	48W	30		69	73	675				
	2008.09-		MT/AT	R	F	Closed Off-Road Vehicle Engine N52B25A	GDS85044	Drive Shaft		30	27	64.8	77	921				
xDrive 30 D (155 kW)	2008.09-		AT	L	R	Closed Off-Road Vehicle Engine M57D30(306D3)	GDS85062	Drive Shaft	48W	30		69	73	621				
	2008.09-		AT	R	R	Closed Off-Road Vehicle Engine M57D30(306D3)	GDS85074	Drive Shaft	48W	30		69	73	675				
	2008.09-		MT/AT	R	F	Closed Off-Road Vehicle Engine M57D30(306D3)	GDS85044	Drive Shaft		30	27	64.8	77	921				
xDrive 30 D (160 kW)	2008.09-					Closed Off-Road Vehicle Engine M57D30(306D3)	GC085010	Outer Joint		30	33	64.8	77	60	M			
	2008.09-		Semi-AT	L	R	Closed Off-Road Vehicle Engine M57D30(306D3)	GDS85062	Drive Shaft	48W	30		69	73	621				
	2008.09-		Semi-AT	R	R	Closed Off-Road Vehicle Engine M57D30(306D3)	GDS85074	Drive Shaft	48W	30		69	73	675				
	2008.09-		MT/AT	R	F	Closed Off-Road Vehicle Engine M57D30(306D3)	GDS85044	Drive Shaft		30	27	64.8	77	921				
xDrive 30 i (200 kW)	2008.09-					Closed Off-Road Vehicle Engine N52B30A	GC085010	Outer Joint		30	33	64.8	77	60	M			
	2008.09-		MT/AT	R	F	Closed Off-Road Vehicle Engine N52B30A	GDS85044	Drive Shaft		30	27	64.8	77	921				
	2008.09-		AT	L	R	Closed Off-Road Vehicle Engine N52B30A	GDS85069	Drive Shaft	48W	30		69	73	625				
xDrive 35 D (210 kW)	2008.09-					Closed Off-Road Vehicle Engine M57D30(306D5)	GC085010	Outer Joint		30	33	64.8	77	60	M			
	2008.09-			L	R	Closed Off-Road Vehicle Engine M57D30(306D5)	GDS85062	Drive Shaft	48W	30		69	73	621				
<b>X5 (E53)</b>																		
3.0 D	2000-	2008		L	F		GDS85010	Drive Shaft		30	27	64.8	77	586				
	2000-	2008			R	F		GDS85011	Drive Shaft		30	27	64.8	77	970			
3.0 D (135 kW)	2001.05-		5AT			Closed Off-Road Vehicle Engine M57D30(306D1)	GC085001	Outer Joint		30	27	64.8	77	67.5	M			
	2001.05-		MT/AT	L	F	Closed Off-Road Vehicle Engine M57D30(306D1)	GDS85029	Drive Shaft		30	27	64.8	77	586				
	2001.05-		MT/AT	R	F	Closed Off-Road Vehicle Engine M57D30(306D1)	GDS85018	Drive Shaft		30	27	64.8	77	970				
	2001.05-		5AT	L/R	R	Closed Off-Road Vehicle Engine M57D30(306D1)	GDS85049	Drive Shaft		30		58.9	73	640				
	2001.05-		AT	L/R	R	Closed Off-Road Vehicle Engine M57D30(306D1)	GDS85050	Drive Shaft		30		58.8	73	637				
	2001.05-				R		GCI85014	Inner Joint		27	26	30	448	114.5				
3.0 D (160 kW)	2003.09-	2007.08				Closed Off-Road Vehicle Engine M57N306D4/M57D30(306D2)	GC085001	Outer Joint		30	27	64.8	77	67.5	M			
	2003.09-	2007.08	MT/AT	L	F	Closed Off-Road Vehicle Engine M57N306D4/M57D30(306D2)	GDS85029	Drive Shaft		30	27	64.8	77	586				
	2003.09-	2007.08	MT/AT	R	F	Closed Off-Road Vehicle Engine M57N306D4/M57D30(306D2)	GDS85018	Drive Shaft		30	27	64.8	77	970				
	2003.09-	2007.08		L/R	R	Closed Off-Road Vehicle Engine M57N306D4/M57D30(306D2)	GDS85049	Drive Shaft		30		58.9	73	640				
	2003.09-	2007.08	AT	L/R	R	Closed Off-Road Vehicle Engine M57N306D4/M57D30(306D2)	GDS85050	Drive Shaft		30		58.8	73	637				
	2003.12-				R		GCI85014	Inner Joint		27	26	30	448	114.5				
	2003.12-						GC085001	Outer Joint		30	27	64.8	77	67.5	M			
3.0 i	2000-	2008		L	F		GDS85010	Drive Shaft		30	27	64.8	77	586				
	2000-	2008			R	F		GDS85011	Drive Shaft		30	27	64.8	77	970			
3.0 i (163 kW)	2000.05-				R		GCI85014	Inner Joint		27	26	30	448	114.5				
	2000.05-						GC085001	Outer Joint		30	27	64.8	77	67.5	M			
3.0 i (170 kW)	2000.05-				R		GCI85014	Inner Joint		27	26	30	448	114.5				
	2000.05-						GC085001	Outer Joint		30	27	64.8	77	67.5	M			





		TRANSM	L/R	F/R		G-AP Ref.	PRODUCT	ABS	Technical Specifications										
									YEAR	A	B	C	H	L	P				
<b>BMW</b>																			
<b>X5 (E53)</b>																			
3.0 i (170 kW)	2000.09-	2007.08				Closed Off-Road Vehicle Engine M54B30(306S3)	GC085001	Outer Joint		30	27	64.8	77	67.5	M				
	2000.09-	2007.08	MT/AT	L	F	Closed Off-Road Vehicle Engine M54B30(306S3)	GDS85029	Drive Shaft		30	27	64.8	77	586					
	2000.09-	2007.08	MT/AT	R	F	Closed Off-Road Vehicle Engine M54B30(306S3)	GDS85018	Drive Shaft		30	27	64.8	77	970					
	2000.09-	2007.08	AT	L/R	R	Closed Off-Road Vehicle Engine M54B30(306S3)	GDS85050	Drive Shaft		30		58.8	73	637					
4.4 i	2000-	2008		L	F		GDS85010	Drive Shaft		30	27	64.8	77	586					
	2000-	2008		R	F		GDS85011	Drive Shaft		30	27	64.8	77	970					
4.4 i (210 kW)	2000.05-			R			GCI85014	Inner Joint		27	26	30	448	114.5					
	2000.05-						GC085001	Outer Joint		30	27	64.8	77	67.5	M				
4.4 i (235 kW)	2003.09-	2007.08				Closed Off-Road Vehicle Engine N62B44/N62B44A	GC085001	Outer Joint		30	27	64.8	77	67.5	M				
	2003.09-	2007.08	MT/AT	L	F	Closed Off-Road Vehicle Engine N62B44/N62B44A	GDS85029	Drive Shaft		30	27	64.8	77	586					
	2003.09-	2007.08	MT/AT	R	F	Closed Off-Road Vehicle Engine N62B44/N62B44A	GDS85018	Drive Shaft		30	27	64.8	77	970					
	2003.09-	2007.08		L/R	R	Closed Off-Road Vehicle Engine N62B44/N62B44A	GDS85049	Drive Shaft		30		58.9	73	640					
	2003.12-			R			GCI85014	Inner Joint		27	26	30	448	114.5					
	2003.12-						GC085001	Outer Joint		30	27	64.8	77	67.5	M				
4.6 iS	2000-	2008		L	F		GDS85010	Drive Shaft		30	27	64.8	77	586					
	2000-	2008		R	F		GDS85011	Drive Shaft		30	27	64.8	77	970					
4.6 iS (255 kW)	2002.02-		5AT			Closed Off-Road Vehicle Engine M62B46(468S1)	GC085001	Outer Joint		30	27	64.8	77	67.5	M				
	2002.02-		MT/AT	L	F	Closed Off-Road Vehicle Engine M62B46(468S1)	GDS85029	Drive Shaft		30	27	64.8	77	586					
	2002.02-		MT/AT	R	F	Closed Off-Road Vehicle Engine M62B46(468S1)	GDS85018	Drive Shaft		30	27	64.8	77	970					
	2002.02-		5AT	L/R	R	Closed Off-Road Vehicle Engine M62B46(468S1)	GDS85049	Drive Shaft		30		58.9	73	640					
	2002.02-			R			GCI85014	Inner Joint		27	26	30	448	114.5					
	2002.02-						GC085001	Outer Joint		30	27	64.8	77	67.5	M				
4.8 iS (265 kW)	2004.03-	2007.08				Closed Off-Road Vehicle Engine N62B48A	GC085001	Outer Joint		30	27	64.8	77	67.5	M				
	2004.03-	2007.08	MT/AT	L	F	Closed Off-Road Vehicle Engine N62B48A	GDS85029	Drive Shaft		30	27	64.8	77	586					
	2004.03-	2007.08	MT/AT	R	F	Closed Off-Road Vehicle Engine N62B48A	GDS85018	Drive Shaft		30	27	64.8	77	970					
	2004.03-	2007.08		L/R	R	Closed Off-Road Vehicle Engine N62B48A	GDS85049	Drive Shaft		30		58.9	73	640					
	2004.04-			R			GCI85014	Inner Joint		27	26	30	448	114.5					
	2004.04-						GC085001	Outer Joint		30	27	64.8	77	67.5	M				
<b>X5 (E70)</b>																			
-	2006-						GC085006	Outer Joint		30	33	64.8	86.5	59.5	M				
3.0 D (155 kW)	2007.02-	2008.09		L	F	Closed Off-Road Vehicle Engine M57D30(306D3)	GDS85052	Drive Shaft		30	27	64.8	86.5	634					
	2007.02-	2008.09		L	F	Closed Off-Road Vehicle Engine M57D30(306D3)	GCI85030	Inner Joint		27	26	44	62	116					
	2007.02-	2008.09		L/R	F	Closed Off-Road Vehicle Engine M57D30(306D3)	GC085006	Outer Joint		30	33	64.8	86.5	59.5	M				
	2007.02-	2008.09		R	F	Closed Off-Road Vehicle Engine M57D30(306D3)	GDS85043	Drive Shaft		30	27	64.8	86.5	1019					
	2007.02-	2008.09		R	F	Closed Off-Road Vehicle Engine M57D30(306D3)	GCI85014	Inner Joint		27	26	30	448	114.5					
3.0 D (173 kW)	2007.02-	2008.09		L	F	Closed Off-Road Vehicle Engine M57D30(306D3)	GDS85052	Drive Shaft		30	27	64.8	86.5	634					
	2007.02-	2008.09		L	F	Closed Off-Road Vehicle Engine M57D30(306D3)	GCI85030	Inner Joint		27	26	44	62	116					
	2007.02-	2008.09		L/R	F	Closed Off-Road Vehicle Engine M57D30(306D3)	GC085006	Outer Joint		30	33	64.8	86.5	59.5	M				
	2007.02-	2008.09		R	F	Closed Off-Road Vehicle Engine M57D30(306D3)	GDS85043	Drive Shaft		30	27	64.8	86.5	1019					
	2007.02-	2008.09		R	F	Closed Off-Road Vehicle Engine M57D30(306D3)	GCI85014	Inner Joint		27	26	30	448	114.5					
	2007.02-						GC085006	Outer Joint		30	33	64.8	86.5	59.5	M				
3.0 DxDrive (155 kW)	2008.09-			L	F	Closed Off-Road Vehicle Engine N57D30A	GDS85052	Drive Shaft		30	27	64.8	86.5	634					
	2008.09-			L	F	Closed Off-Road Vehicle Engine N57D30A	GCI85030	Inner Joint		27	26	44	62	116					
	2008.09-			L/R	F	Closed Off-Road Vehicle Engine N57D30A	GC085006	Outer Joint		30	33	64.8	86.5	59.5	M				
	2008.09-			R	F	Closed Off-Road Vehicle Engine N57D30A	GDS85043	Drive Shaft		30	27	64.8	86.5	1019					
	2008.09-			R	F	Closed Off-Road Vehicle Engine N57D30A	GCI85014	Inner Joint		27	26	30	448	114.5					
	2008.09-		AT		R	Closed Off-Road Vehicle Engine N57D30A	GDS85081	Drive Shaft		30	37	68.7	84	810					
3.0 SD (210 kW)	2007.07-	2009.02		L	F	Closed Off-Road Vehicle Engine M57D30(306D5)	GDS85052	Drive Shaft		30	27	64.8	86.5	634					
	2007.07-	2009.02		L	F	Closed Off-Road Vehicle Engine M57D30(306D5)	GCI85030	Inner Joint		27	26	44	62	116					
	2007.07-	2009.02		L/R	F	Closed Off-Road Vehicle Engine M57D30(306D5)	GC085006	Outer Joint		30	33	64.8	86.5	59.5	M				
	2007.07-	2009.02		R	F	Closed Off-Road Vehicle Engine M57D30(306D5)	GDS85043	Drive Shaft		30	27	64.8	86.5	1019					
	2007.07-	2009.02		R	F	Closed Off-Road Vehicle Engine M57D30(306D5)	GCI85014	Inner Joint		27	26	30	448	114.5					
	2007.07-	2009.02	AT		R	Closed Off-Road Vehicle Engine M57D30(306D5)	GDS85070	Drive Shaft		30	32	68.7	84	809					
	2007.09-						GC085006	Outer Joint		30	33	64.8	86.5	59.5	M				
3.0 Si (200 kW)	2007.02-	2008.09		L	F	Closed Off-Road Vehicle Engine N52B30/N52B30A	GDS85052	Drive Shaft		30	27	64.8	86.5	634					
	2007.02-	2008.09		L	F	Closed Off-Road Vehicle Engine N52B30/N52B30A	GCI85030	Inner Joint		27	26	44	62	116					
	2007.02-	2008.09		L/R	F	Closed Off-Road Vehicle Engine N52B30/N52B30A	GC085006	Outer Joint		30	33	64.8	86.5	59.5	M				
	2007.02-	2008.09		R	F	Closed Off-Road Vehicle Engine N52B30/N52B30A	GDS85043	Drive Shaft		30	27	64.8	86.5	1019					
	2007.02-	2008.09		R	F	Closed Off-Road Vehicle Engine N52B30/N52B30A	GCI85014	Inner Joint		27	26	30	448	114.5					
	2007.02-						GC085006	Outer Joint		30	33	64.8	86.5	59.5	M				
4.5 M (408 kW)	2009.04-			L	F	Closed Off-Road Vehicle Engine S63B44A	GDS85052	Drive Shaft		30	27	64.8	86.5	634					
	2009.04-			L	F	Closed Off-Road Vehicle Engine S63B44A	GCI85030	Inner Joint		27	26	44	62	116					









		TRANSM	L/R	F/R		G-AP Ref.	PRODUCT	ABS	Technical Specifications									
									YEAR	A	B	C	H	L	P			
<b>BMW</b>																		
<b>X5 (E70)</b>																		
4.5 M (408 kW)	2009.04-			L/R	F	Closed Off-Road Vehicle Engine S63B44A	GC085006	Outer Joint	30	33	64.8	86.5	59.5	M				
	2009.04-			R	F	Closed Off-Road Vehicle Engine S63B44A	GDS85043	Drive Shaft	30	27	64.8	86.5	1019					
	2009.04-			R	F	Closed Off-Road Vehicle Engine S63B44A	GCI85014	Inner Joint	27	26	30	448	114.5					
4.8 i (261 kW)	2007.02-						GC085006	Outer Joint	30	33	64.8	86.5	59.5	M				
4.8 i xDrive (261 kW)	2007.09-2008.09			L	F	Closed Off-Road Vehicle Engine N62B48B	GDS85052	Drive Shaft	30	27	64.8	86.5	634					
	2007.09-2008.09			L	F	Closed Off-Road Vehicle Engine N62B48B	GCI85030	Inner Joint	27	26	44	62	116					
	2007.09-2008.09			L/R	F	Closed Off-Road Vehicle Engine N62B48B	GC085006	Outer Joint	30	33	64.8	86.5	59.5	M				
	2007.09-2008.09			R	F	Closed Off-Road Vehicle Engine N62B48B	GDS85043	Drive Shaft	30	27	64.8	86.5	1019					
	2007.09-2008.09			R	F	Closed Off-Road Vehicle Engine N62B48B	GCI85014	Inner Joint	27	26	30	448	114.5					
	2007.09-2008.09				R	Closed Off-Road Vehicle Engine N62B48B	GDS85070	Drive Shaft	30	32	68.7	84	809					
xDrive 30 D (173 kW)	2008.09-			L	F	Closed Off-Road Vehicle Engine N57D30A	GDS85052	Drive Shaft	30	27	64.8	86.5	634					
	2008.09-			L	F	Closed Off-Road Vehicle Engine N57D30A	GCI85030	Inner Joint	27	26	44	62	116					
	2008.09-			L/R	F	Closed Off-Road Vehicle Engine N57D30A	GC085006	Outer Joint	30	33	64.8	86.5	59.5	M				
	2008.09-			R	F	Closed Off-Road Vehicle Engine N57D30A	GDS85043	Drive Shaft	30	27	64.8	86.5	1019					
	2008.09-			R	F	Closed Off-Road Vehicle Engine N57D30A	GCI85014	Inner Joint	27	26	30	448	114.5					
	2008.09-		AT		R	Closed Off-Road Vehicle Engine N57D30A	GDS85070	Drive Shaft	30	32	68.7	84	809					
xDrive 30 D (180 kW)	2010.09-		AT		R	Closed Off-Road Vehicle Engine N57D30A	GDS85070	Drive Shaft	30	32	68.7	84	809					
xDrive 30 i (200 kW)	2008.09-2010.03			L	F	Closed Off-Road Vehicle Engine N52B30A	GDS85052	Drive Shaft	30	27	64.8	86.5	634					
	2008.09-2010.03			L	F	Closed Off-Road Vehicle Engine N52B30A	GCI85030	Inner Joint	27	26	44	62	116					
	2008.09-2010.03			L/R	F	Closed Off-Road Vehicle Engine N52B30A	GC085006	Outer Joint	30	33	64.8	86.5	59.5	M				
	2008.09-2010.03			R	F	Closed Off-Road Vehicle Engine N52B30A	GDS85043	Drive Shaft	30	27	64.8	86.5	1019					
	2008.09-2010.03			R	F	Closed Off-Road Vehicle Engine N52B30A	GCI85014	Inner Joint	27	26	30	448	114.5					
xDrive 35 D (210 kW)	2008.09-			L	F	Closed Off-Road Vehicle Engine M57N306D5	GDS85052	Drive Shaft	30	27	64.8	86.5	634					
	2008.09-			L	F	Closed Off-Road Vehicle Engine M57N306D5	GCI85030	Inner Joint	27	26	44	62	116					
	2008.09-			L/R	F	Closed Off-Road Vehicle Engine M57N306D5	GC085006	Outer Joint	30	33	64.8	86.5	59.5	M				
	2008.09-			R	F	Closed Off-Road Vehicle Engine M57N306D5	GDS85043	Drive Shaft	30	27	64.8	86.5	1019					
	2008.09-			R	F	Closed Off-Road Vehicle Engine M57N306D5	GCI85014	Inner Joint	27	26	30	448	114.5					
	2008.09-				R	Closed Off-Road Vehicle Engine M57N306D5	GDS85070	Drive Shaft	30	32	68.7	84	809					
xDrive 35 i (225 kW)	2010.09-			L	F	Closed Off-Road Vehicle Engine N55B30A	GDS85052	Drive Shaft	30	27	64.8	86.5	634					
	2010.09-			L	F	Closed Off-Road Vehicle Engine N55B30A	GCI85030	Inner Joint	27	26	44	62	116					
	2010.09-			L/R	F	Closed Off-Road Vehicle Engine N55B30A	GC085006	Outer Joint	30	33	64.8	86.5	59.5	M				
	2010.09-			R	F	Closed Off-Road Vehicle Engine N55B30A	GDS85043	Drive Shaft	30	27	64.8	86.5	1019					
	2010.09-			R	F	Closed Off-Road Vehicle Engine N55B30A	GCI85014	Inner Joint	27	26	30	448	114.5					
xDrive 40 D (225 kW)	2010.09-				R	Closed Off-Road Vehicle Engine N57SD30B	GDS85070	Drive Shaft	30	32	68.7	84	809					
xDrive 48 i (261 kW)	2008.09-			L	F	Closed Off-Road Vehicle Engine N62B48B	GDS85052	Drive Shaft	30	27	64.8	86.5	634					
	2008.09-			L	F	Closed Off-Road Vehicle Engine N62B48B	GCI85030	Inner Joint	27	26	44	62	116					
	2008.09-			L/R	F	Closed Off-Road Vehicle Engine N62B48B	GC085006	Outer Joint	30	33	64.8	86.5	59.5	M				
	2008.09-			R	F	Closed Off-Road Vehicle Engine N62B48B	GDS85043	Drive Shaft	30	27	64.8	86.5	1019					
	2008.09-			R	F	Closed Off-Road Vehicle Engine N62B48B	GCI85014	Inner Joint	27	26	30	448	114.5					
	2008.09-				R	Closed Off-Road Vehicle Engine N62B48B	GDS85070	Drive Shaft	30	32	68.7	84	809					
xDrive 50 i (300 kW)	2010.06-			L	F	Closed Off-Road Vehicle Engine N63B44A	GDS85052	Drive Shaft	30	27	64.8	86.5	634					
	2010.06-			L	F	Closed Off-Road Vehicle Engine N63B44A	GCI85030	Inner Joint	27	26	44	62	116					
	2010.06-			L/R	F	Closed Off-Road Vehicle Engine N63B44A	GC085006	Outer Joint	30	33	64.8	86.5	59.5	M				
	2010.06-			R	F	Closed Off-Road Vehicle Engine N63B44A	GDS85043	Drive Shaft	30	27	64.8	86.5	1019					
	2010.06-			R	F	Closed Off-Road Vehicle Engine N63B44A	GCI85014	Inner Joint	27	26	30	448	114.5					
	2010.06-				R	Closed Off-Road Vehicle Engine N63B44A	GDS85070	Drive Shaft	30	32	68.7	84	809					
<b>X6 (E71)</b>																		
-	2008-						GC085006	Outer Joint	30	33	64.8	86.5	59.5	M				
30 DX 3.0 (173 kW)	2008.05-						GC085006	Outer Joint	30	33	64.8	86.5	59.5	M				
35 DX 3.5 (210 kW)	2008.05-						GC085006	Outer Joint	30	33	64.8	86.5	59.5	M				
35 ix 3.5 (225 kW)	2008.05-						GC085006	Outer Joint	30	33	64.8	86.5	59.5	M				
50 ix 5.0 (300 kW)	2008.05-						GC085006	Outer Joint	30	33	64.8	86.5	59.5	M				
50 M 4.4 (408 kW)	2008.06-						GC085006	Outer Joint	30	33	64.8	86.5	59.5	M				
<b>X6 (E71, E72)</b>																		
30 D (173 kW)	2008.05-			L	F	Closed Off-Road Vehicle Engine M57N2306D3	GDS85052	Drive Shaft	30	27	64.8	86.5	634					
	2008.05-			L	F	Closed Off-Road Vehicle Engine M57N2306D3	GCI85030	Inner Joint	27	26	44	62	116					
	2008.05-			L/R	F	Closed Off-Road Vehicle Engine M57N2306D3	GC085006	Outer Joint	30	33	64.8	86.5	59.5	M				
	2008.05-			R	F	Closed Off-Road Vehicle Engine M57N2306D3	GDS85043	Drive Shaft	30	27	64.8	86.5	1019					
	2008.05-			R	F	Closed Off-Road Vehicle Engine M57N2306D3	GCI85014	Inner Joint	27	26	30	448	114.5					
	2008.05-				R	Closed Off-Road Vehicle Engine M57N2306D3	GDS85070	Drive Shaft	30	32	68.7	84	809					
35 i (225 kW)	2008.05-			L	F	Closed Off-Road Vehicle Engine N54B30A	GDS85052	Drive Shaft	30	27	64.8	86.5	634					
	2008.05-			L	F	Closed Off-Road Vehicle Engine N54B30A	GCI85030	Inner Joint	27	26	44	62	116					
	2008.05-			L/R	F	Closed Off-Road Vehicle Engine N54B30A	GC085006	Outer Joint	30	33	64.8	86.5	59.5	M				



	 YEAR	TRANSM	L/R	F/R		G-AP Ref.	PRODUCT	ABS	Technical Specifications							
									A	B	C	H	L	P		
<b>BMW</b>																
<b>X6 (E71, E72)</b>																
35 i (225 kW)	2008.05-			R	F	Closed Off-Road Vehicle Engine N54B30A	GDS85043	Drive Shaft		30	27	64.8	86.5	1019		
	2008.05-			R	F	Closed Off-Road Vehicle Engine N54B30A	GCI85014	Inner Joint		27	26	30	448	114.5		
4.5 ActiveHybrid (357 kW)	2010.10-			L	F	Closed Off-Road Vehicle Engine N63B44A	GDS85052	Drive Shaft		30	27	64.8	86.5	634		
	2010.10-			L	F	Closed Off-Road Vehicle Engine N63B44A	GCI85030	Inner Joint		27	26	44	62	116		
	2010.10-			L/R	F	Closed Off-Road Vehicle Engine N63B44A	GC085006	Outer Joint		30	33	64.8	86.5	59.5	M	
	2010.10-			R	F	Closed Off-Road Vehicle Engine N63B44A	GDS85043	Drive Shaft		30	27	64.8	86.5	1019		
	2010.10-			R	F	Closed Off-Road Vehicle Engine N63B44A	GCI85014	Inner Joint		27	26	30	448	114.5		
4.5 M (408 kW)	2009.09-			L	F	Closed Off-Road Vehicle Engine S63B44A	GDS85052	Drive Shaft		30	27	64.8	86.5	634		
	2009.09-			L	F	Closed Off-Road Vehicle Engine S63B44A	GCI85030	Inner Joint		27	26	44	62	116		
	2009.09-			L/R	F	Closed Off-Road Vehicle Engine S63B44A	GC085006	Outer Joint		30	33	64.8	86.5	59.5	M	
	2009.09-			R	F	Closed Off-Road Vehicle Engine S63B44A	GDS85043	Drive Shaft		30	27	64.8	86.5	1019		
	2009.09-			R	F	Closed Off-Road Vehicle Engine S63B44A	GCI85014	Inner Joint		27	26	30	448	114.5		
50 i (300 kW)	2008.05-			L	F	Closed Off-Road Vehicle Engine N63B44A	GDS85052	Drive Shaft		30	27	64.8	86.5	634		
	2008.05-			L	F	Closed Off-Road Vehicle Engine N63B44A	GCI85030	Inner Joint		27	26	44	62	116		
	2008.05-			L/R	F	Closed Off-Road Vehicle Engine N63B44A	GC085006	Outer Joint		30	33	64.8	86.5	59.5	M	
	2008.05-			R	F	Closed Off-Road Vehicle Engine N63B44A	GDS85043	Drive Shaft		30	27	64.8	86.5	1019		
	2008.05-			R	F	Closed Off-Road Vehicle Engine N63B44A	GCI85014	Inner Joint		27	26	30	448	114.5		
xDrive 30 D (173 kW)	2008.09-			L	F	Closed Off-Road Vehicle Engine N57D30A	GDS85052	Drive Shaft		30	27	64.8	86.5	634		
	2008.09-			L	F	Closed Off-Road Vehicle Engine N57D30A	GCI85030	Inner Joint		27	26	44	62	116		
	2008.09-			L/R	F	Closed Off-Road Vehicle Engine N57D30A	GC085006	Outer Joint		30	33	64.8	86.5	59.5	M	
	2008.09-			R	F	Closed Off-Road Vehicle Engine N57D30A	GDS85043	Drive Shaft		30	27	64.8	86.5	1019		
	2008.09-			R	F	Closed Off-Road Vehicle Engine N57D30A	GCI85014	Inner Joint		27	26	30	448	114.5		
xDrive 35 D (210 kW)	2008.09-			L	F	Closed Off-Road Vehicle Engine M57D30(306D5)	GDS85052	Drive Shaft		30	27	64.8	86.5	634		
	2008.09-			L	F	Closed Off-Road Vehicle Engine M57D30(306D5)	GCI85030	Inner Joint		27	26	44	62	116		
	2008.09-			L/R	F	Closed Off-Road Vehicle Engine M57D30(306D5)	GC085006	Outer Joint		30	33	64.8	86.5	59.5	M	
	2008.09-			R	F	Closed Off-Road Vehicle Engine M57D30(306D5)	GDS85043	Drive Shaft		30	27	64.8	86.5	1019		
	2008.09-			R	F	Closed Off-Road Vehicle Engine M57D30(306D5)	GCI85014	Inner Joint		27	26	30	448	114.5		
xDrive 35 i (225 kW)	2008.09-			L	F	Closed Off-Road Vehicle Engine N54B30A/N55B30A	GDS85052	Drive Shaft		30	27	64.8	86.5	634		
	2008.09-			L	F	Closed Off-Road Vehicle Engine N54B30A/N55B30A	GCI85030	Inner Joint		27	26	44	62	116		
	2008.09-			L/R	F	Closed Off-Road Vehicle Engine N54B30A/N55B30A	GC085006	Outer Joint		30	33	64.8	86.5	59.5	M	
	2008.09-			R	F	Closed Off-Road Vehicle Engine N54B30A/N55B30A	GDS85043	Drive Shaft		30	27	64.8	86.5	1019		
	2008.09-			R	F	Closed Off-Road Vehicle Engine N54B30A/N55B30A	GCI85014	Inner Joint		27	26	30	448	114.5		
xDrive 50 i (300 kW)	2008.09-			L	F	Closed Off-Road Vehicle Engine N63B44A	GDS85052	Drive Shaft		30	27	64.8	86.5	634		
	2008.09-			L	F	Closed Off-Road Vehicle Engine N63B44A	GCI85030	Inner Joint		27	26	44	62	116		
	2008.09-			L/R	F	Closed Off-Road Vehicle Engine N63B44A	GC085006	Outer Joint		30	33	64.8	86.5	59.5	M	
	2008.09-			R	F	Closed Off-Road Vehicle Engine N63B44A	GDS85043	Drive Shaft		30	27	64.8	86.5	1019		
	2008.09-			R	F	Closed Off-Road Vehicle Engine N63B44A	GCI85014	Inner Joint		27	26	30	448	114.5		
<b>Z3 (E36)</b>																
1.8 (85 kW)	1995.10-	1998.10			R	Convertible Engine M43B18	GCI85009	Inner Joint		27	24	64	68.5	58		
1.9 (103 kW)	1995.10-	1999.03			R	Convertible Engine M44B19/M44B19(194S1)	GCI85009	Inner Joint		27	24	64	68.5	58		
1.9 (85 kW)	1999.01-	2003.01			R	Convertible Engine M43B19(194E1)	GCI85009	Inner Joint		27	24	64	68.5	58		
	1999.01-	2003.01			R	Convertible Engine M43B19(194E1)	GDS85006	Drive Shaft	48W	27		64	68.5	585		
	1999.01-	2003.01			R	Convertible Engine M43B19(194E1)	GCI85001	Inner Joint			24		24			
1.9 (87 kW)	1998.07-	2003.01			R	Convertible Engine M43B19(194E1)	GCI85009	Inner Joint		27	24	64	68.5	58		
	1998.07-	2003.01	MT/AT		R	Convertible Engine M43B19(194E1)	GCI85001	Inner Joint			24		24			
	1998.07-	2003.01			R	Convertible Engine M43B19(194E1)	GDS85006	Drive Shaft	48W	27		64	68.5	585		
2.0 (110 kW)	1999.04-	2003.01	MT/AT		R	Convertible Engine M52B(206S4)/M52B20	GCI85001	Inner Joint			24		24			
<b>Z4 (E85)</b>																
2.5 i (141 kW)	2003.02-		MT	L	R	Convertible Engine M54B25(256S5)	GDS85051	Drive Shaft	48W	27		64	69	608		
	2003.02-		MT/Semi-AT	R	R	Convertible Engine M54B25(256S5)	GDS85042	Drive Shaft	48W	27		64	69	665		
3.0 i (170 kW)	2003.02-		MT	L	R	Convertible Engine M54B30(306S3)	GDS85051	Drive Shaft	48W	27		64	69	608		
	2003.02-		MT/Semi-AT	R	R	Convertible Engine M54B30(306S3)	GDS85042	Drive Shaft	48W	27		64	69	665		
<b>BUICK</b>																
<b>CELEBRITY</b>																
-	1982-	1985					GC099019	Outer Joint		33	23	47.5	109.5	59.5	I	
<b>CENTURY</b>																
-	1982-				A	Body	GC086001	Outer Joint		33	29	47.6	108	63	O	
	1983-	1985					GC099019	Outer Joint		33	23	47.5	109.5	59.5	I	
All Models	1991-	1993					GC021007	Outer Joint		27	32	61.5	120	63	I	
<b>CENTURY SS</b>																
-	1983-	1985					GC099019	Outer Joint		33	23	47.5	109.5	59.5	I	

		YEAR	TRANSM	L/R	F/R		G-AP Ref.	PRODUCT	ABS	Technical Specifications										
										A	B	C	H	L	P					
<b>BUICK</b>																				
<b>RANIER</b>																				
-	2004-	2005				America SUV/Truck/VAN	GC088011	Outer Joint			27	34	55.8	127.5	64	O				
<b>REGAL</b>																				
-	1988-	1996					GC086002	Outer Joint			33	32	73	88	55	O				
	1988-	1996					GC086011	Outer Joint	47T		33	32	73	88	55	O				
3.0							GC186001	Inner Joint			34	32	35	56.5	79.5					
							GC186003	Inner Joint			34	32	35	56.8	120.7					
<b>RIVIERA</b>																				
-	1979-	1985				E-Body	GC088007	Outer Joint			27	34	55.8	127.5	64	O				
All Models	1979.01-	1979.12					GC088005	Outer Joint			27	34	56	109	63	O				
	1980.01-	1984.12					GC088005	Outer Joint			27	34	56	109	63	O				
<b>SKYHAWK</b>																				
-	1982-					J-Body	GC086001	Outer Joint			33	29	47.6	108	63	O				
<b>SKYLARK (N-BODY)</b>																				
-	1986-						GC086001	Outer Joint			33	29	47.6	108	63	O				
	1991-	1995	AT			3 Speed	GC021018	Outer Joint	48T		33	29	47.6	108	63	O				
<b>BYD</b>																				
<b>F3</b>																				
1.6	2006-		MT				GCI99089	Inner Joint			25	29	41	62.5	87					
<b>CADILLAC</b>																				
<b>ELDORADO</b>																				
-	1979-	1984					GC088007	Outer Joint			27	34	55.8	127.5	64	O				
	1985-					E-Body	GC088007	Outer Joint			27	34	55.8	127.5	64	O				
4.6 (224 kW)	1994.09-	2002.09			F	Coupe Engine L37/LD8	GC088008	Outer Joint			27	32	61.5	120	64.5	O				
All Models	1979.01-	1979.12					GC088005	Outer Joint			27	34	56	109	63	O				
	1980.01-	1984.12					GC088005	Outer Joint			27	34	56	109	63	O				
<b>SEVILLE</b>																				
-	1980-	1985				K-Body	GC088007	Outer Joint			27	34	55.8	127.5	64	O				
4.6 SLS V8 (205 kW)	1997.09-	2004.09			R	Saloon Engine LH2	GC088008	Outer Joint			27	32	61.5	120	64.5	O				
All Models	1980.01-	1984.12					GC088005	Outer Joint			27	34	56	109	63	O				
	1985.01-	1990.12					GC088005	Outer Joint			27	34	56	109	63	O				
<b>CHEVROLET</b>																				
<b>ASTRO</b>																				
-	1990-	2000				VAN M-Body 4WD	GC088006	Outer Joint			33	35	77	112.5	73.5	O				
	1990-	2000				VAN M-Body 4WD	GC021019	Outer Joint	55T		33	35	77	112.5	73.5	O				
<b>AVEO</b>																				
-							GC088025	Outer Joint	47T		22	23	52	96	56	M				
1.5							GC088016	Outer Joint			22	22	52	96.5	53.5	O				
<b>AVEO (T200)</b>																				
-	2003-	2008					GC088037	Outer Joint			22	19	52	95.5	53	O				
	2003-	2008					GCI12009	Inner Joint			34	22	35	80.5	58					
1.5	2003.09-	2008.10					GC088025	Outer Joint	47T		22	23	52	96	56	M				
<b>AVEO (T250)</b>																				
-	2006-	2008					GC088037	Outer Joint			22	19	52	95.5	53	O				
	2006-	2008					GCI12009	Inner Joint			34	22	35	80.5	58					
<b>AVEO (T250, T255)</b>																				
1.2 (55 kW)	2008.01-		MT	L	F	Saloon Engine B12D1/LMU	GDS44069	Drive Shaft	47T		22	22	52	96.5	657					
	2008.01-		MT	R	F	Saloon Engine B12D1/LMU	GDS44070	Drive Shaft	47T		22	22	52	96.5	875					
	2008.01-		MT	R	F	Saloon Engine B12D1/LMU	GCI88021	Inner Joint			22	22	35	50	76	O				
	2008.01-					Saloon Engine B12D1/LMU	GC012042	Outer Joint	47T		22	22	52	96.5	53.5	O				
1.2 (56 kW)	2008.01-		MT	R	F	Saloon Engine B12S1/LY4	GDS60035	Drive Shaft			33	22	52	109	961					
1.2 (62 kW)	2008.01-			L/R	F	Saloon Engine B12D1/LMU	GC088021	Outer Joint	47T		22	22	52	96.5	53.5	O				
	2008.01-		MT	R	F	Saloon Engine B12D1/LMU	GDS44070	Drive Shaft	47T		22	22	52	96.5	875					
	2008.01-		MT	R	F	Saloon Engine B12D1/LMU	GCI88021	Inner Joint			22	22	35	50	76	O				
	2008.01-					Saloon Engine B12D1/LMU	GC012042	Outer Joint	47T		22	22	52	96.5	53.5	O				
	2008.01-		MT	L	F	Saloon Engine B12D1/LMU	GDS44069	Drive Shaft	47T		22	22	52	96.5	657					
	2008.04-				F	Hatchback Engine B12D1/LMU	GC088034	Outer Joint	47T		22	19	52	95.5	53	O				
	2008.04-			L	F	Hatchback Engine B12D1/LMU	GDS44069	Drive Shaft	47T		22	22	52	96.5	657					
	2008.04-			L/R	F	Hatchback Engine B12D1/LMU	GC088021	Outer Joint	47T		22	22	52	96.5	53.5	O				
	2008.04-			R	F	Hatchback Engine B12D1/LMU	GDS44070	Drive Shaft	47T		22	22	52	96.5	875					
	2008.04-			R	F	Hatchback Engine B12D1/LMU	GCI88021	Inner Joint			22	22	35	50	76	O				









		YEAR	TRANSM	L/R	F/R		G-AP Ref.	PRODUCT	ABS	Technical Specifications								
										A	B	C	H	L	P			
<b>CHEVROLET</b>																		
<b>AVEO (T250, T255)</b>																		
1.2 (62 kW)	2008.04-					Hatchback Engine B12D1/LMU	GC012042	Outer Joint	47T	22	22	52	96.5	53.5	O			
	2008.04-						GCI88021	Inner Joint		22	22	35	50	76	O			
1.2 LPG (62 kW)	2008.04-		MT	L	F	Hatchback Engine LMU/B12D1	GDS44069	Drive Shaft	47T	22	22	52	96.5	657				
	2008.04-			L/R	F	Hatchback Engine LMU/B12D1	GC088021	Outer Joint	47T	22	22	52	96.5	53.5	O			
	2008.04-		MT	R	F	Hatchback Engine LMU/B12D1	GDS44070	Drive Shaft	47T	22	22	52	96.5	875				
	2008.04-		MT	R	F	Hatchback Engine LMU/B12D1	GCI88021	Inner Joint		22	22	35	50	76	O			
	2008.04-					Hatchback Engine LMU/B12D1	GC012042	Outer Joint	47T	22	22	52	96.5	53.5	O			
	2009.01-		MT	L	F	Saloon Engine LMU/B12D1	GDS44069	Drive Shaft	47T	22	22	52	96.5	657				
	2009.01-		MT	R	F	Saloon Engine LMU/B12D1	GDS44070	Drive Shaft	47T	22	22	52	96.5	875				
	2009.01-		MT	R	F	Saloon Engine LMU/B12D1	GCI88021	Inner Joint		22	22	35	50	76	O			
	2009.01-					Saloon Engine LMU/B12D1	GC012042	Outer Joint	47T	22	22	52	96.5	53.5	O			
1.4 (69 kW)	2006.03-	2007.12		L/R	F	Saloon Engine F14D3	GC088021	Outer Joint	47T	22	22	52	96.5	53.5	O			
1.4 (74 kW)	2008.04-			L/R	F	Hatchback Engine F14D4/LDT/A14XER	GC088021	Outer Joint	47T	22	22	52	96.5	53.5	O			
	2008.04-						GCI88021	Inner Joint		22	22	35	50	76	O			
	2008.09-			L/R	F	Saloon Engine F14D4	GC088021	Outer Joint	47T	22	22	52	96.5	53.5	O			
	2008.09-					Saloon Engine F14D4	GC012042	Outer Joint	47T	22	22	52	96.5	53.5	O			
<b>BERETTA (L-BODY)</b>																		
-	1987-						GC086001	Outer Joint		33	29	47.6	108	63	O			
2.2	1992-	1995	MT				GC021018	Outer Joint	48T	33	29	47.6	108	63	O			
3.1	1992-	1993				W.O FE3.FE7 Option	GC021018	Outer Joint	48T	33	29	47.6	108	63	O			
<b>BLAZER / K1500 / K2500 / K3500</b>																		
-	1988-	1997					GC088009	Outer Joint		33	29	80	112	88.5	O			
<b>CAPTIVA</b>																		
2.0 D 4WD	2006-	2012	AT	L			GDS88093	Drive Shaft		30	27	54	105.5	618.5				
	2006-	2012	AT	L			GCI88034	Inner Joint		27	34	35	68.5	111.5				
	2006-	2012	AT	L/R			GC022009	Outer Joint		30	34	54	105.5	64.5	O			
	2006-	2012	AT	R			GDS88094	Drive Shaft		30	27	54	105.5	542				
	2006-	2012	AT	R			GCI88035	Inner Joint		27	34	43.3	51	77				
<b>CAPTIVA (C100)</b>																		
-	2007-						GC021047	Outer Joint		30	22		105.5	53.5	O			
	2007-						GCI88034	Inner Joint		27	34	35	68.5	111.5				
	2007-						GCI12009	Inner Joint		34	22	35	80.5	58				
<b>CAPTIVA (C100, C140)</b>																		
2.0 D (110 kW)	2007.09-			L/R	F	Closed Off-Road Vehicle Engine Z20S	GC022009	Outer Joint		30	34	54	105.5	64.5	O			
2.0 D 4WD (110 kW)	2007.01-	2008.03		L/R	F	Closed Off-Road Vehicle Engine Z20S	GC022009	Outer Joint		30	34	54	105.5	64.5	O			
2.0 D 4WD (93 kW)	2006.10-			L/R		Closed Off-Road Vehicle Engine Z20S	GC022009	Outer Joint		30	34	54	105.5	64.5	O			
2.4 (100 kW)	2006.06-			L/R	F	Closed Off-Road Vehicle Engine Z24SED	GC022009	Outer Joint		30	34	54	105.5	64.5	O			
2.4 4WD (100 kW)	2007.01-			L/R		Closed Off-Road Vehicle Engine Z24SED	GC022009	Outer Joint		30	34	54	105.5	64.5	O			
2.4 LPG (100 kW)	2007.01-			L/R	F	Closed Off-Road Vehicle Engine Z24SED	GC022009	Outer Joint		30	34	54	105.5	64.5	O			
2.4 LPG 4WD (100 kW)	2007.01-			L/R		Closed Off-Road Vehicle Engine Z24SED	GC022009	Outer Joint		30	34	54	105.5	64.5	O			
	2007.01-					Closed Off-Road Vehicle Engine Z24SED	GC061059	Outer Joint		36	33	59.5	40	59.5	I			
3.2 4WD (169 kW)	2006.06-			L/R		Closed Off-Road Vehicle Engine 10HM	GC022009	Outer Joint		30	34	54	105.5	64.5	O			
<b>CAVALIER (J-BODY)</b>																		
-	1982-						GC086001	Outer Joint		33	29	47.6	108	63	O			
	1992-	1995				LD Driveline&Brakes	GC021018	Outer Joint	48T	33	29	47.6	108	63	O			
<b>CELEBRITY</b>																		
-	1982-	1985					GC099019	Outer Joint		33	23	47.5	109.5	59.5	I			
<b>CORSA</b>																		
-				L			GDS44019	Drive Shaft		22	22	52	97.5	562				
				R			GDS44018	Drive Shaft		22	22	52	97.5	912				
<b>CORSA TH</b>																		
-							GC099065	Outer Joint		22	30	52.2	97.5	55	O			
<b>CORSICA (L-BODY)</b>																		
-	1987-						GC086001	Outer Joint		33	29	47.6	108	63	O			
	1992-	1993				LD Driveline&Brakes	GC021018	Outer Joint	48T	33	29	47.6	108	63	O			
<b>CRUZE</b>																		
1.6 16V	2009-		AT	L	F		GDS99246	Drive Shaft		33	34	59	94.5	621				
	2009-		MT	L	F		GDS88107	Drive Shaft		33	34	59	94.5	640				
	2009-		AT	R	F		GDS99247	Drive Shaft		33	34	59	94.5	970				
-	2008-		AT	L	F		GC021043	Outer Joint		33	31	59	94.5	62.5	M			
	2008-		AT	R	F		GC021043	Outer Joint		33	31	59	94.5	62.5	M			



		TRANSM	L/R	F/R		G-AP Ref.	PRODUCT	ABS	Technical Specifications									
									YEAR	A	B	C	H	L	P			
<b>CHEVROLET CRUZE</b>																		
-	2008-		AT	L		GDS88107	Drive Shaft		33	34	59	94.5	640					
	2008-		AT	L		GCI88041	Inner Joint		34	31	35	138	98					
	2008-		MT	L		GDS99246	Drive Shaft		33	34	59	94.5	621					
	2008-		MT	L		GC021043	Outer Joint		33	31	59	94.5	62.5	M				
	2008-		MT	L		GCI88039	Inner Joint		34	31	35	56.5	141.5					
	2008-		AT	R		GDS88108	Drive Shaft		33	34	59	94.5	951					
	2008-		AT	R		GCI88040	Inner Joint		34	31	35	55.5	142					
	2008-		MT	R		GDS99247	Drive Shaft		33	34	59	94.5	970					
	2008-		MT	R		GC021043	Outer Joint		33	31	59	94.5	62.5	M				
	2008-		MT	R		GCI88039	Inner Joint		34	31	35	56.5	141.5					
<b>CRUZE (J300)</b>																		
-	2009-					GCI88054	Inner Joint		34	23	37.5		121.5					
1.6 (91 kW)	2009.05-				Saloon Engine F16D4	GC021043	Outer Joint		33	31	59	94.5	62.5	M				
1.7 D (96 kW)	2012.01-				Saloon Engine LUD	GC088066	Outer Joint		30	34	59	95	65	M				
2.0 CDi (110 kW)	2009.05-		MT	L	F	Saloon Engine Z20S1	GDS88095	Drive Shaft		30	27	57.5	95	582				
2.0 CDi (120 kW)	2010.08-		MT	L	F	Saloon Engine Z20D1	GDS88095	Drive Shaft		30	27	57.5	95	582				
	2010.08-				Saloon Engine Z20D1	GC088066	Outer Joint		30	34	59	95	65	M				
2.0 CDi (90 kW)	2009.05-		MT	L	F	Saloon Engine Z20S1	GDS88095	Drive Shaft		30	27	57.5	95	582				
<b>CRUZE (J305)</b>																		
1.4 (103 kW)	2012.06-				Hatchback Engine LUJ	GC088066	Outer Joint		30	34	59	95	65	M				
1.6 (91 kW)	2011.06-				Hatchback Engine F16D4	GC021043	Outer Joint		33	31	59	94.5	62.5	M				
1.7 D (96 kW)	2012.01-				Hatchback Engine LUD	GC088066	Outer Joint		30	34	59	95	65	M				
2.0 CDi (120 kW)	2011.06-				Hatchback Engine Z20D1	GC088066	Outer Joint		30	34	59	95	65	M				
<b>CRUZE STATION WAGON (J308)</b>																		
1.4 (103 kW)	2012.08-				Estate Engine LUJ	GC088066	Outer Joint		30	34	59	95	65	M				
1.6 (91 kW)	2012.08-				Estate Engine LDE	GC021043	Outer Joint		33	31	59	94.5	62.5	M				
1.7 TD (96 kW)	2012.08-				Estate Engine LUD	GC088066	Outer Joint		30	34	59	95	65	M				
2.0 TD (120 kW)	2012.08-				Estate Engine LNP	GC088066	Outer Joint		30	34	59	95	65	M				
<b>EPICA</b>																		
-			MT	L		GDS12027	Drive Shaft		28	34	55.5	99	643					
			MT	R		GDS12026	Drive Shaft		28	26	55.5	99	682					
2.0	2007-2008		MT	L		GDS88072	Drive Shaft		28	34	55.5	99	622					
	2007-2008		MT	R		GDS88071	Drive Shaft		28	26	55.5	99	554					
<b>EPICA (KL1_)</b>																		
2.0 (105 kW)	2008.04-				Saloon Engine X20D1	GC088038	Outer Joint		28	32	55.5	99	66	O				
2.0 (94 kW)	2005.01-2006.12				Saloon Engine X20XEV	GC088038	Outer Joint		28	32	55.5	99	66	O				
2.0 (98 kW)	2005.01-2006.12				Saloon Engine T20SED	GC088038	Outer Joint		28	32	55.5	99	66	O				
2.0 D (110 kW)	2008.04-				F Saloon Engine Z20S	GC068008	Outer Joint		28	34	55.5	99	66	O				
	2008.04-		MT	L	F	Saloon Engine Z20S	GDS39183	Drive Shaft		28	27	55.5	99	622				
	2008.04-		MT	R	F	Saloon Engine Z20S	GDS39182	Drive Shaft		28	27	55.5	99	529				
	2008.04-				Saloon Engine Z20S	GC088038	Outer Joint		28	32	55.5	99	66	O				
<b>K 1500</b>																		
-	1988-1997				4WD GVW	GC088006	Outer Joint		33	35	77	112.5	73.5	O				
	1988-1997				4WD GVW	GC021019	Outer Joint	55T	33	35	77	112.5	73.5	O				
	1999-2000				4WD GVW	GC088006	Outer Joint		33	35	77	112.5	73.5	O				
	1999-2000				4WD GVW	GC021019	Outer Joint	55T	33	35	77	112.5	73.5	O				
<b>K 2500</b>																		
-	1988-1997				4WD GVW	GC088006	Outer Joint		33	35	77	112.5	73.5	O				
	1988-1997				4WD GVW	GC021019	Outer Joint	55T	33	35	77	112.5	73.5	O				
<b>KALOS</b>																		
-	2003-2008					GC088037	Outer Joint		22	19	52	95.5	53	O				
	2003-2008					GCI12009	Inner Joint		34	22	35	80.5	58					
1.2 (53 kW)	2005.03-				F Hatchback Engine B12S1	GC088034	Outer Joint	47T	22	19	52	95.5	53	O				
	2005.03-				F Saloon Engine F12S3	GC088034	Outer Joint	47T	22	19	52	95.5	53	O				
	2005.03-		MT	L	F	Hatchback Engine B12S1	GDS44071	Drive Shaft	47T	22	22	52	95.5	661				
	2005.03-			L/R	F	Saloon Engine F12S3	GC088021	Outer Joint	47T	22	22	52	96.5	53.5	O			
	2005.03-		MT	R	F	Hatchback Engine B12S1	GDS44072	Drive Shaft	47T	22	22	52	95.5	880				
1.2 16V	2004-2006			L/R	F		GCI99107	Inner Joint		22	19	35	50.5	78				
1.2 8V	2004-2006			L/R	F		GCI99107	Inner Joint		22	19	35	50.5	78				
1.4	2003-				L		GDS88012	Drive Shaft	48T	22	22	52	95.5	602				
1.4 (61 kW)	2005.03-		MT	L	F	Hatchback Engine F14S3	GDS12058	Drive Shaft	47T	22	34	52	96.5	611				
	2005.03-		MT	L	F	Saloon Engine F14S3	GDS12058	Drive Shaft	47T	22	34	52	96.5	611				

	 YEAR	TRANSM	L/R	F/R		G-AP Ref.	PRODUCT	ABS	Technical Specifications							
									A	B	C	H	L	P		
<b>CHEVROLET KALOS</b>																
1.4 (61 kW)	2005.03-			L/R	F	Hatchback Engine F14S3	GC088021	Outer Joint	47T	22	22	52	96.5	53.5	O	
	2005.03-			L/R	F	Saloon Engine F14S3	GC088021	Outer Joint	47T	22	22	52	96.5	53.5	O	
	2005.03-					Hatchback Engine F14S3	GC012042	Outer Joint	47T	22	22	52	96.5	53.5	O	
	2005.03-					Saloon Engine F14S3	GC012042	Outer Joint	47T	22	22	52	96.5	53.5	O	
1.4 16V (69 kW)	2005.03-		MT	L	F	Hatchback Engine F14D3	GDS12058	Drive Shaft	47T	22	34	52	96.5	611		
	2005.03-		MT	L	F	Saloon Engine F14D3	GDS12058	Drive Shaft	47T	22	34	52	96.5	611		
	2005.03-			L/R	F	Hatchback Engine F14D3	GC088021	Outer Joint	47T	22	22	52	96.5	53.5	O	
	2005.03-			L/R	F	Saloon Engine F14D3	GC088021	Outer Joint	47T	22	22	52	96.5	53.5	O	
	2005.03-					Hatchback Engine F14D3	GC012042	Outer Joint	47T	22	22	52	96.5	53.5	O	
	2005.03-					Saloon Engine F14D3	GC012042	Outer Joint	47T	22	22	52	96.5	53.5	O	
1.5 GL						GCI12004	Inner Joint		22	29	38	59	116			
<b>LACETTI (J200)</b>																
1.4 16V (70 kW)	2005.03-				F	Hatchback Engine F14D3	GC012005	Outer Joint	47T	22	22	52	96	56	I	
	2005.03-				F	Hatchback Engine F14D3	GC012011	Outer Joint		33	22	52	95.5	53	O	
	2005.03-				F	Hatchback Engine F14D3	GC088019	Outer Joint	47T	33	22	52	95.5	53	O	
	2005.03-					Hatchback Engine F14D3	GC044086	Outer Joint	47T	33	22	52	96	56	O	
	2005.03-															
1.6 (80 kW)	2005.03-				F	Hatchback Engine F16D3	GC012011	Outer Joint		33	22	52	95.5	53	O	
	2005.03-				F	Hatchback Engine F16D3	GC088019	Outer Joint	47T	33	22	52	95.5	53	O	
	2005.03-					Estate Engine F16D3	GC044086	Outer Joint	47T	33	22	52	96	56	O	
	2005.03-					Hatchback Engine F16D3	GC044086	Outer Joint	47T	33	22	52	96	56	O	
1.8 (89 kW)	2005.08-				F	Hatchback Engine F18D3	GC012011	Outer Joint		33	22	52	95.5	53	O	
	2005.08-				F	Hatchback Engine F18D3	GC088019	Outer Joint	47T	33	22	52	95.5	53	O	
1.8 (90 kW)	2005.03-				F	Hatchback Engine T18SED	GC012011	Outer Joint		33	22	52	95.5	53	O	
	2005.03-				F	Hatchback Engine T18SED	GC088019	Outer Joint	47T	33	22	52	95.5	53	O	
<b>LUMINA</b>																
-	1990-2001					Excl. A/T, 3 Speed.	GC086002	Outer Joint		33	32	73	88	55	O	
	1990-1993	AT				3 Speed	GC088024	Outer Joint		33	29	73	88	54.5	O	
	1990-2001					Excl. A/T, 3 Speed.	GC086011	Outer Joint	47T	33	32	73	88	55	O	
<b>MATIZ (M200, M250)</b>																
0.8 (38 kW)	2005.03-		MT		F	Hatchback Engine F8CV	GC012021	Outer Joint	40T	23	19	46	92	56.5	O	
	2005.03-			L	F	Hatchback Engine F8CV	GDS12025	Drive Shaft	40T	23	22	46	92	616		
	2005.03-					Hatchback Engine F8CV	GC012046	Outer Joint	40T	23	19	46	92	56.5	O	
0.8 LPG (38 kW)	2005.03-			L/R	F	Hatchback Engine F8CV	GC012046	Outer Joint	40T	23	19	46	92	56.5	O	
1.0 (47 kW)	2005.03-		MT		F	Hatchback Engine B10S	GC012021	Outer Joint	40T	23	19	46	92	56.5	O	
	2005.03-		MT	L	F	Hatchback Engine B10S	GDS57177	Drive Shaft	40T	23	22	46	92	562		
	2005.03-		MT	R	F	Hatchback Engine B10S	GDS57176	Drive Shaft	40T	23	22	46	92	831		
	2005.03-					Hatchback Engine B10S	GC012046	Outer Joint	40T	23	19	46	92	56.5	O	
	2005.03-															
1.0 (48 kW)	2007.01-		MT	L	F	Hatchback Engine LA2	GDS57177	Drive Shaft	40T	23	22	46	92	562		
	2007.01-		MT	R	F	Hatchback Engine LA2	GDS57176	Drive Shaft	40T	23	22	46	92	831		
1.0 (49 kW)	2005.03-		MT		F	Hatchback Engine B10S1	GC012021	Outer Joint	40T	23	19	46	92	56.5	O	
	2005.03-		MT	L	F	Hatchback Engine B10S1	GDS57177	Drive Shaft	40T	23	22	46	92	562		
	2005.03-		MT	R	F	Hatchback Engine B10S1	GDS57176	Drive Shaft	40T	23	22	46	92	831		
	2005.03-					Hatchback Engine B10S1	GC012046	Outer Joint	40T	23	19	46	92	56.5	O	
1.0 LPG (49 kW)	2005.03-			L	F	Hatchback Engine B10S1	GDS57177	Drive Shaft	40T	23	22	46	92	562		
	2005.03-			L/R	F	Hatchback Engine B10S1	GC012046	Outer Joint	40T	23	19	46	92	56.5	O	
	2005.03-		MT	R	F	Hatchback Engine B10S1	GDS57176	Drive Shaft	40T	23	22	46	92	831		
<b>MONTANA</b>																
1.8 8V	2002-			L			GDS44034	Drive Shaft		22	22	52	97.5	580		
	2002-			R			GDS44035	Drive Shaft		22	22	52	97.5	929		
	2002-			L/R			GC044066	Outer Joint		22	23	52	97.5	61	M	
	2002-			L/R			GCI44015	Inner Joint		22	23	35	57.5	82		
<b>MONTE CARLO</b>																
-	1995-1999						GC086002	Outer Joint		33	32	73	88	55	O	
	1995-1999						GC086011	Outer Joint	47T	33	32	73	88	55	O	
<b>NOVA</b>																
-	1985-1988	MT	L			W/ Twin cam	GDS88016	Drive Shaft		26	23	56	96.5	599.5		
	1985-1988		L			Excl. Twin cam	GDS88016	Drive Shaft		26	23	56	96.5	599.5		
	1985-1988	MT	R			W/ Twin cam	GDS88017	Drive Shaft		26	23	56	96.5	910		
	1985-1988		R			Excl. Twin cam	GDS88017	Drive Shaft		26	23	56	96.5	910		
	1985-1988	MT				W/ Twin cam	GCI88015	Inner Joint		23	23	34	61	116		
	1985-1988					Excl. Twin cam	GCI88015	Inner Joint		23	23	34	61	116		
All Models	1985-1988						GC021001	Outer Joint		26	29	56	96	62	O	









		YEAR	TRANSM	L/R	F/R		G-AP Ref.	PRODUCT	ABS	Technical Specifications											
										A	B	C	H	L	P						
<b>CHEVROLET</b>																					
<b>NOVA S</b>																					
All Models	1985-	1988					GC021001	Outer Joint			26	29	56	96	62	O					
<b>NUBIRA</b>																					
1.6 (80 kW)	2005.03-				F	Estate Engine F16D3	GC012011	Outer Joint			33	22	52	95.5	53	O					
	2005.03-				F	Estate Engine F16D3	GC088019	Outer Joint	47T		33	22	52	95.5	53	O					
	2005.03-				F	Saloon Engine F16D3	GC012011	Outer Joint			33	22	52	95.5	53	O					
	2005.03-				F	Saloon Engine F16D3	GC088019	Outer Joint	47T		33	22	52	95.5	53	O					
	2005.03-					Estate Engine F16D3	GC012014	Outer Joint			33	22	52	96	56	I					
	2005.03-					Estate Engine F16D3	GC012022	Outer Joint	47T		33	22	52	96	56	I					
	2005.03-					Saloon Engine F16D3	GC012014	Outer Joint			33	22	52	96	56	I					
	2005.03-					Saloon Engine F16D3	GC012022	Outer Joint	47T		33	22	52	96	56	I					
<b>OPTRA</b>																					
-							GCI12004	Inner Joint			22	29	38	59	116						
	2006-	2008	AT	L			GDS12015	Drive Shaft			33	22	52	95.5	615						
	2006-	2008	MT	L			GDS21019	Drive Shaft			33	34	52	95.5	611						
	2006-	2008	AT	R			GDS21021	Drive Shaft			33	22	52	95.5	945						
	2006-	2008	MT	R			GDS21020	Drive Shaft			33	34	52	95.5	932						
1.6	2004-	2007	MT	L			GDS12045	Drive Shaft			33	34	52	95.5	612.5						
	2004-	2007	MT	R			GDS12046	Drive Shaft			33	34	52	95.5	934						
<b>ORLANDO (J309)</b>																					
2.0 D (120 kW)	2011.02-					MPV Engine Z20D1	GC088066	Outer Joint			30	34	59	95	65	M					
2.0 D (96 kW)	2011.02-					MPV Engine Z20D1	GC088066	Outer Joint			30	34	59	95	65	M					
<b>PRIZM</b>																					
-	1989-	1992		L		W/O GSI	GDS88016	Drive Shaft			26	23	56	96.5	599.5						
	1989-	1992		R		W/O GSI	GDS88017	Drive Shaft			26	23	56	96.5	910						
	1989-	1992				W/O GSI	GCI88015	Inner Joint			23	23	34	61	116						
	1993-	2000					GC059163	Outer Joint	48T		26	29	56	99.5	62.5	O					
<b>S10</b>																					
-	1998-			R		4WD	GDS88080	Drive Shaft			27	26	55.8	127.5	542						
	1998-			L		4WD	GDS88081	Drive Shaft			27	26	55.8	127.5	594						
<b>S10 / S10 BLAZER</b>																					
-	1997-	2005					GCI88008	Inner Joint			26	34	40	92	98						
	1997-	2005				4WD SUV/Truck/VAN	GC088011	Outer Joint			27	34	55.8	127.5	64	O					
<b>S10 BLAZER</b>																					
-	1983-	1984				4WD S& T-Body	GC088007	Outer Joint			27	34	55.8	127.5	64	O					
	1985-	1993				4WD S& T-Body w/HD Shocks	GC088007	Outer Joint			27	34	55.8	127.5	64	O					
	1985-	1993				4WD S& T-Body w/Std Shocks	GC088007	Outer Joint			27	34	55.8	127.5	64	O					
All Models	1985.01-	1990.12					GC088005	Outer Joint			27	34	56	109	63	O					
<b>S10 PICK UP</b>																					
-	1983-	1984				4WD S& T-Body	GC088007	Outer Joint			27	34	55.8	127.5	64	O					
	1985-	1993				4WD S& T-Body w/HD Shocks	GC088007	Outer Joint			27	34	55.8	127.5	64	O					
	1985-	1993				4WD S& T-Body w/Std Shocks	GC088007	Outer Joint			27	34	55.8	127.5	64	O					
<b>SPARK</b>																					
0.8 (37 kW)	2005.05-			L/R	F	Hatchback Engine F8CV	GC012046	Outer Joint	40T		23	19	46	92	56.5	O					
1.0 SX (46 kW)	2005.05-		MT	L	F	Hatchback Engine B10S/LA2	GDS57179	Drive Shaft	47T		22	22	52	96	623						
<b>SPARK (M300)</b>																					
1.0 (50 kW)	2010.03-		MT	L	F	Hatchback Engine B10D1	GDS57179	Drive Shaft	47T		22	22	52	96	623						
	2010.03-			L/R	F	Hatchback Engine B10D1	GC044090	Outer Joint	47T		22	20	52	96	52	M					
1.0 LPG (50 kW)	2010.03-		MT	L	F	Hatchback Engine B10D1	GDS57179	Drive Shaft	47T		22	22	52	96	623						
1.2 (60 kW)	2010.03-		MT	L	F	Hatchback Engine LMU/B12D1	GDS57179	Drive Shaft	47T		22	22	52	96	623						
	2010.03-			L/R	F	Hatchback Engine LMU/B12D1	GC044090	Outer Joint	47T		22	20	52	96	52	M					
1.2 LPG (60 kW)	2010.03-		MT	L	F	Hatchback Engine LMU/B12D1	GDS57179	Drive Shaft	47T		22	22	52	96	623						
<b>SPRINT</b>																					
-							GC039044	Outer Joint			23	20	44	89	54	O					
							GCI99100	Inner Joint			22	19	35	51.5	83						
<b>STORM</b>																					
-	1990-	1993	MT			DOHC	GC088015	Outer Joint			24	30	50	87.5	55	M					
<b>SUBURBAN / TAHOE</b>																					
-	1988-	1997					GC088009	Outer Joint			33	29	80	112	88.5	O					
<b>VECTRA / MONZA / KADETT</b>																					
-							GC044107	Outer Joint			33	25	52	109.5	61	O					



	 YEAR	TRANSM	L/R	F/R		G-AP Ref.	PRODUCT	ABS	Technical Specifications									
									A	B	C	H	L	P				
<b>CHEVROLET / GEO</b>																		
<b>AVALANCHE</b>																		
-	2002-2005				4WD SUV/Truck/VAN	GC039029	Outer Joint		33	41	80	112	88.5	O				
<b>BLAZER / K1500 / K2500 / K3500</b>																		
-	1992-1994				4WD Suv/Truck/Van	GC021022	Outer Joint	55T	33	29	80	112	88.5	O				
<b>METRO</b>																		
-	1995-2000					GC057043	Outer Joint	42T	23	19	46	92	56.5	I				
-	1995-2000				Housing Stamped 75 LAC	GC088018	Outer Joint		23	19	46	92	56.5	I				
<b>S10 / S10 BLAZER</b>																		
-	1997-2005				4WD	GCT88009	Inner Joint		26	34	40	55	85					
<b>SILVERADO PICK UP</b>																		
-	1999-2005				SUV/Truck/VAN	GC039029	Outer Joint		33	41	80	112	88.5	O				
<b>SUBURBAN / TAHOE</b>																		
-	1992-1994				Suv/Truck/Van	GC021022	Outer Joint	55T	33	29	80	112	88.5	O				
-	1998-2005				SUV/Truck/VAN	GC039029	Outer Joint		33	41	80	112	88.5	O				
<b>CHRYSLER</b>																		
<b>300 M</b>																		
-	2002-2004					GCI99062	Inner Joint		27	32	39.5	49	76					
-	2002-2004				Excl. Special	GC089039	Outer Joint	50T	33	32	49.6	102.5	57	O				
<b>BREZZE</b>																		
-	1996-1999					GC089043	Outer Joint	56T	26	32	54.1	95	63.5	I				
<b>CARAVAN</b>																		
-						GC089034	Outer Joint	47T	26	32	54	98.5	61.5	I				
<b>CIRRUS</b>																		
-	1996-1997					GC089043	Outer Joint	56T	26	32	54.1	95	63.5	I				
<b>CIRRUS / STRATUS</b>																		
-	1996-1998		AT			GC089043	Outer Joint	56T	26	32	54.1	95	63.5	I				
-	1999-		MT/AT			GC089041	Outer Joint	46T	26	32	54.1	95	63.5	I				
-	2000-2004		MT/AT			GC015012	Outer Joint	46T	26	32	54	98.5	61.5	I				
-	2000-2004		MT/AT			GCI89023	Inner Joint		25	32	40	74	113					
-	2000-2004		MT/AT			GC089014	Outer Joint		26	32	54.1	95	63.5	I				
-	2000-2004		MT/AT			GC089037	Outer Joint	46T	26	32	54.1	95	63.5	I				
<b>CONCORDE</b>																		
-	1993-1995					GC089016	Outer Joint		33	32	49.6	102.5	60	O				
-	1993-1995					GC089038	Outer Joint	50W	33	32	49.6	102.5	60	O				
-	1993-2004					GCI99062	Inner Joint		27	32	39.5	49	76					
-	1996-1997					GC089016	Outer Joint		33	32	49.6	102.5	60	O				
-	1996-1997			R		GDS89013	Drive Shaft	50T	33	27	49.6	102.5	537					
-	1996-1997					GC088022	Outer Joint	50T	33	32	49.6	102.5	60	O				
-	1996-1997					GCI89009	Inner Joint		27	32	39.8	47.5	77.5					
-	1998-2004					GC089039	Outer Joint	50T	33	32	49.6	102.5	57	O				
2.7 LX (149 kW)	1997.10-2003.09			F	Saloon Engine EER	GC089017	Outer Joint		33	32	49.6	102.5	57	O				
3.5 LX (174 kW)	1997.10-2003.09			F	Saloon Engine EWZ	GC089017	Outer Joint		33	32	49.6	102.5	57	O				
3.5 LX SuperchargeD (186 kW)	1997.10-2003.09			F	Saloon Engine EWZ	GC089017	Outer Joint		33	32	49.6	102.5	57	O				
<b>DART / LE BARON</b>																		
-	1987-1988		AT			GC089012	Outer Joint		26	24	54	90	63.5	I				
<b>DART / LE BARON / NEW YORKER</b>																		
-	1984-1986		AT			GC089006	Outer Joint		26	23	54	98	59.5	I				
-	1984-1986		AT			GCI89024	Inner Joint		23	24	40	57	100					
<b>DART / VOLARE</b>																		
-	1984-1987		MT			GC089006	Outer Joint		26	23	54	98	59.5	I				
<b>DART / VOLARE / LE BARON</b>																		
-	1982-1983		AT			GCI89024	Inner Joint		23	24	40	57	100					
-	1982-1993		AT			GC089026	Outer Joint		26	23	54	98.5	61.5	I				
<b>FIFTH AVENUE</b>																		
-	1990-				Saginaw	GC089010	Outer Joint		26	29	54	99.5	62.5	O				
<b>GRAND VOYAGER V (RT)</b>																		
2.8 CRD (120 kW)	2007.10-			R	F	MPV Engine ENS	GDS88137	Drive Shaft	32	29	55	105.5	1058					
	2007.10-					MPV Engine ENS	GC089051	Outer Joint	32	34	55	105.5	60	M				
2.8 CRD (132 kW)	2012.09-		AT	R	F	MPV Engine ENS	GDS88137	Drive Shaft	32	29	55	105.5	1058					
	2012.09-		AT			MPV Engine ENS	GC089051	Outer Joint	32	34	55	105.5	60	M				
3.3 (125 kW)	2008.01-			R	F	MPV Engine EGV	GDS88137	Drive Shaft	32	29	55	105.5	1058					
	2008.01-					MPV Engine EGV	GC089051	Outer Joint	32	34	55	105.5	60	M				

		YEAR	TRANSM	L/R	F/R		G-AP Ref.	PRODUCT	ABS	Technical Specifications									
										A	B	C	H	L	P				
<b>CHRYSLER</b>																			
<b>GRAND VOYAGER V (RT)</b>																			
3.8 (142 kW)	2007.10-				R	F	MPV Engine EGL	GDS88137	Drive Shaft		32	29	55	105.5	1058				
	2007.10-					F	MPV Engine EGL	GC089051	Outer Joint		32	34	55	105.5	60	M			
<b>IMPERIAL</b>																			
-	1990-						Saginaw	GC089010	Outer Joint		26	29	54	99.5	62.5	O			
<b>JEEP LIBERTY</b>																			
-	2002-	2010	AT					GCI16003	Inner Joint		29	35	45	55.5	101				
<b>LE BARON</b>																			
-	1987-	1995						GC089008	Outer Joint		26	28	54	98	58	I			
	1988-	1990						GC089012	Outer Joint		26	24	54	90	63.5	I			
<b>LE BARON / CONVERTIBLE / COUPE / SEDAN / GTC / GTS</b>																			
-	1986-	1991					Saginaw	GC089010	Outer Joint		26	29	54	99.5	62.5	O			
	1991-	1993						GCI89026	Inner Joint		25	32	40	71	124				
<b>LHS</b>																			
-	1994-	1995						GC089016	Outer Joint		33	32	49.6	102.5	60	O			
	1994-	1995						GC089038	Outer Joint	50W	33	32	49.6	102.5	60	O			
	1996-	1997						GC089016	Outer Joint		33	32	49.6	102.5	60	O			
	1996-	1997						GC088022	Outer Joint	50T	33	32	49.6	102.5	60	O			
<b>MAGNUM</b>																			
-	1987-	1989	MT/AT					GC089012	Outer Joint		26	24	54	90	63.5	I			
<b>MAGNUM / LE BARON / NEW YORKER</b>																			
-	1984-	1986						GCI89024	Inner Joint		23	24	40	57	100				
	1984-	1986						GC089006	Outer Joint		26	23	54	98	59.5	I			
<b>MAGNUM / VOLARE / PHANTOM / NEW YORKER</b>																			
-	1987-	1988	MT					GC089012	Outer Joint		26	24	54	90	63.5	I			
<b>NEON</b>																			
-	1994-	1995						GC089036	Outer Joint	56T	23	28	57.7	91.8	58	I			
	1998-	1999	AT					GC089035	Outer Joint	46T	23	28	57.7	91.8	58	I			
	1998-	1999	MT					GC089035	Outer Joint	46T	23	28	57.7	91.8	58	I			
	2000-	2004						GC089022	Outer Joint		26	23	57.7	92.5	58	M			
	2000-	2004						GC089040	Outer Joint	46T	26	23	57.7	92.5	58	M			
	2000-	2004	MT/AT					GCI89017	Inner Joint		25	23	40	74	113.5				
	2000-	2008	MT/AT					GCI88057	Inner Joint		25	23	40	73.5	111				
<b>NEW YORKER</b>																			
-	1986-	1990					Saginaw	GC089010	Outer Joint		26	29	54	99.5	62.5	O			
	1994-	1995					SAGINAW	GC089016	Outer Joint		33	32	49.6	102.5	60	O			
	1994-	1995					SAGINAW	GC089038	Outer Joint	50W	33	32	49.6	102.5	60	O			
	1996-						SAGINAW	GC089016	Outer Joint		33	32	49.6	102.5	60	O			
	1996-							GC088022	Outer Joint	50T	33	32	49.6	102.5	60	O			
3.5 i 24V (155 kW)	1993.04-	1998.09				F	Saloon Engine F01	GC089005	Outer Joint		26	32	54.1	98	62	I			
<b>NEW YORKER / PHANTOM / LE BARON</b>																			
-	1988-	1990						GC089012	Outer Joint		26	24	54	90	63.5	I			
<b>NEW YORKER / PHANTOM / SHADOW</b>																			
-	1988-	1989	MT					GC089012	Outer Joint		26	24	54	90	63.5	I			
<b>NEW YORKER / PHANTOM / SPIRIT / SHADOW</b>																			
-	1990-	1994	AT					GC089019	Outer Joint		26	32	54	90	63.5	I			
	1990-	1994	AT					GCI89003	Inner Joint		25	25	40	71.5	107.5				
<b>NEW YORKER / SPIRIT / SHADOW</b>																			
-	1990-	1994	AT					GCI89003	Inner Joint		25	25	40	71.5	107.5				
<b>PT CRUISER</b>																			
-	2000-	2004						GC089040	Outer Joint	46T	26	23	57.7	92.5	58	M			
	2000-	2004	MT/AT					GCI89017	Inner Joint		25	23	40	74	113.5				
	2000-	2008	MT/AT					GCI88057	Inner Joint		25	23	40	73.5	111				
	2006-	2008	AT	L				GDS89048	Drive Shaft		26	25	57.7	92.5	595				
	2006-	2008	AT	R				GDS89049	Drive Shaft		26	25	57.7	92.5	950				
<b>PT CRUISER (PT_)</b>																			
1.6 (85 kW)	2001.11-	2010.12				F	Estate Engine EJD	GC089040	Outer Joint	46T	26	23	57.7	92.5	58	M			
	2001.11-	2010.12					Estate Engine EJD	GC044026	Outer Joint	51T	28	36	65	96	71	I			
2.0 (104 kW)	2000.06-	2010.12				F	Estate Engine ECC	GC089040	Outer Joint	46T	26	23	57.7	92.5	58	M			
2.2 CRD (110 kW)	2005.08-	2010.12	MT	L	F	Estate Engine EDJ	GDS89074	Drive Shaft	46T	26	28	57.7	92.5	556					
	2005.08-	2010.12	MT	R	F	Estate Engine EDJ	GDS89073	Drive Shaft	46T	26	32	57.7	92.5	490					
2.2 CRD (89 kW)	2002.03-	2010.12				F	Estate Engine EDJ	GC089040	Outer Joint	46T	26	23	57.7	92.5	58	M			
	2002.03-	2010.12	MT	L	F	Estate Engine EDJ	GDS89074	Drive Shaft	46T	26	28	57.7	92.5	556					









		YEAR	TRANSM	L/R	F/R		G-AP Ref.	PRODUCT	ABS	Technical Specifications										
										A	B	C	H	L	P					
<b>CHRYSLER</b>																				
<b>PT CRUISER (PT_)</b>																				
2.2 CRD (89 kW)	2002.03-	2010.12	MT	R	F	Estate Engine EDJ	GDS89073	Drive Shaft	46T	26	32	57.7	92.5	490						
2.4 (110 kW)	2000.06-	2010.12			F	Estate Engine EDZ	GC089040	Outer Joint	46T	26	23	57.7	92.5	58	M					
2.4 GT (164 kW)	2003.08-	2010.12			F	Estate Engine EDV	GC089040	Outer Joint	46T	26	23	57.7	92.5	58	M					
<b>PT TUBRO MTX</b>																				
-	2003-	2006	MT				GC089032	Outer Joint	46T	26	24	57.7	92.5	58	M					
<b>PT TURBO ATX</b>																				
-	2003-	2006	AT				GC089028	Outer Joint		26	24	57.7	92.5	58	M					
-	2003-	2006	AT				GC089032	Outer Joint	46T	26	24	57.7	92.5	58	M					
<b>SEBRING CONV</b>																				
-	1996-	1997					GC089043	Outer Joint	56T	26	32	54.1	95	63.5	I					
<b>SEBRING COUPE</b>																				
-	1995-	1999					GC039041	Outer Joint		25	25	54	95.5	65	M					
-	1995-	1999					GC039078	Outer Joint	43T	25	25	54	95.5	63.5	I					
<b>SHADOW</b>																				
-	1988-	1989	MT				GC089012	Outer Joint		26	24	54	90	63.5	I					
<b>SPIRIT</b>																				
-	1990-		MT				GC089012	Outer Joint		26	24	54	90	63.5	I					
<b>SPIRIT / SHADOW</b>																				
-	1991-	1994	AT				GCI89003	Inner Joint		25	25	40	71.5	107.5						
-	1991-	1994	MT/AT				GCI89003	Inner Joint		25	25	40	71.5	107.5						
<b>STRATUS</b>																				
-	1996-	1997					GC089043	Outer Joint	56T	26	32	54.1	95	63.5	I					
<b>STRATUS TURBO</b>																				
-	2000-	2004	MT/AT				GCI89023	Inner Joint		25	32	40	74	113						
-	2000-	2004	MT/AT				GC089037	Outer Joint	46T	26	32	54.1	95	63.5	I					
<b>TOWN / COUNTRY</b>																				
-	1991-	1995					GCI89026	Inner Joint		25	32	40	71	124						
-	1996-	2000				SUV/Truck/VAN	GCI89021	Inner Joint		25	32	28	173	107						
-	1996-	2004				SUV/Truck/VAN	GCI99059	Inner Joint		25	32	40	71.5	107						
<b>TOWN / COUNTRY MINI VAN</b>																				
-	1996-	1997		L		Truck 2WD	GDS89004	Drive Shaft	47T	26	25	54	98.5	638						
-	1996-	1997		L		Truck 4WD	GDS89004	Drive Shaft	47T	26	25	54	98.5	638						
<b>TOWN / COUNTRY VAN</b>																				
-	1991-	1995			F	Truck	GCI89006	Inner Joint		25	32	28	172.3	122						
<b>VISION</b>																				
3.5 TSi (155 kW)	1993.09-	1997.12			F	Saloon Engine EGE/F00/F01	GC089045	Outer Joint		33	32	50	90.5	56.5	O					
<b>VOYAGER</b>																				
-	1996-	2000	AT				GCI89021	Inner Joint		25	32	28	173	107						
3.3 (110 kW)	1991.03-	1995.01		L			GDS15004	Drive Shaft		26	25	54	98.5	611						
3.3 (120 kW)	1991.03-	1995.01		L			GDS15004	Drive Shaft		26	25	54	98.5	611						
<b>VOYAGER I (ES)</b>																				
-	1990.08-	1995.09					GCI89005	Inner Joint		25	32	40	71	122						
-	1990.08-	1995.09					GCI89006	Inner Joint		25	32	28	172.3	122						
<b>VOYAGER II (ES)</b>																				
2.5 i (72 kW)	1991.01-	1995.09			F	MPV Engine K00	GC089005	Outer Joint		26	32	54.1	98	62	I					
2.5 i (74 kW)	1990.08-	1995.09	MT	L	F	MPV Engine K	GDS89002	Drive Shaft	47T	26	25	54	98.5	611						
	1990.08-	1995.09	MT	R	F	MPV Engine K	GDS89028	Drive Shaft	47T	26	25	54	98.5	1001						
	1990.08-	1995.09			F	MPV Engine K	GC089005	Outer Joint		26	32	54.1	98	62	I					
2.5 TD (87 kW)	1992.01-	1995.09			F	MPV Engine 09B/M00	GC089009	Outer Joint		26	32	54	98.5	61.5	I					
	1992.01-	1995.09	MT		F	MPV Engine 09B/M00	GC089005	Outer Joint		26	32	54.1	98	62	I					
3.0 i (108 kW)	1991.01-	1995.09			F	MPV Engine 300/6G72	GC089005	Outer Joint		26	32	54.1	98	62	I					
3.3 i (110 kW)	1990.08-	1995.09	MT/AT	L	F	MPV Engine EGA	GDS89002	Drive Shaft	47T	26	25	54	98.5	611						
	1990.08-	1995.09	MT/AT	R	F	MPV Engine EGA	GDS89028	Drive Shaft	47T	26	25	54	98.5	1001						
	1990.08-	1995.09	AT		F	MPV Engine EGA	GC089009	Outer Joint		26	32	54	98.5	61.5	I					
	1990.08-	1995.09			F	MPV Engine EGA	GC089005	Outer Joint		26	32	54.1	98	62	I					
3.3 i (120 kW)	1990.08-	1995.09	MT/AT	L	F	MPV Engine EGA	GDS89002	Drive Shaft	47T	26	25	54	98.5	611						
	1990.08-	1995.09	MT/AT	R	F	MPV Engine EGA	GDS89028	Drive Shaft	47T	26	25	54	98.5	1001						
	1990.08-	1995.09	AT		F	MPV Engine EGA	GC089009	Outer Joint		26	32	54	98.5	61.5	I					
3.3 i AWD (110 kW)	1990.08-	1995.09	AT			MPV Engine EGA	GC089009	Outer Joint		26	32	54	98.5	61.5	I					
	1990.08-	1995.09				MPV Engine EGA	GC089005	Outer Joint		26	32	54.1	98	62	I					
3.3 i AWD (120 kW)	1990.08-	1995.09	AT			MPV Engine R00	GC089009	Outer Joint		26	32	54	98.5	61.5	I					
	1990.08-	1995.09				MPV Engine R00	GC089005	Outer Joint		26	32	54.1	98	62	I					

		YEAR	TRANSM	L/R	F/R		G-AP Ref.	PRODUCT	ABS	Technical Specifications										
										A	B	C	H	L	P					
<b>CHRYSLER VOYAGER II (GS)</b>																				
2.0 i (98 kW)	1995.01-	2001.03	MT	L	F	MPV Engine C00	GDS88024	Drive Shaft	47T	26	25	54	98.5	640						
	1995.01-	2001.03	MT	R	F	MPV Engine C00	GDS89039	Drive Shaft	47T	26	25	54	98.5	1028						
	1995.01-	2001.03			F	MPV Engine C00	GC089009	Outer Joint		26	32	54	98.5	61.5	I					
	1995.01-	2001.03			F	MPV Engine C00	GC089029	Outer Joint	47T	26	32	54	98.5	61.5	I					
2.4 AWD (111 kW)	1997.02-	2001.03				MPV Engine EDZ	GC089029	Outer Joint	47T	26	32	54	98.5	61.5	I					
2.4 i (111 kW)	1995.01-	2001.03	MT	L	F	MPV Engine B00	GDS88024	Drive Shaft	47T	26	25	54	98.5	640						
	1995.01-	2001.03	MT	R	F	MPV Engine B00	GDS89039	Drive Shaft	47T	26	25	54	98.5	1028						
	1995.01-	2001.03	AT	L	F	MPV Engine B00	GDS88024	Drive Shaft	47T	26	25	54	98.5	640						
	1995.01-	2001.03	AT	R	F	MPV Engine B00	GDS89039	Drive Shaft	47T	26	25	54	98.5	1028						
	1995.01-	2001.03			F	MPV Engine B00	GC089009	Outer Joint		26	32	54	98.5	61.5	I					
	1995.01-	2001.03			F	MPV Engine B00	GC089029	Outer Joint	47T	26	32	54	98.5	61.5	I					
2.5 TD (85 kW)	1995.01-	2001.03			F	MPV Engine 425CLIRS/X/ENC	GC089029	Outer Joint	47T	26	32	54	98.5	61.5	I					
	1995.01-	2001.03	MT	L	F	MPV Engine 425CLIRS/X/ENC	GDS88024	Drive Shaft	47T	26	25	54	98.5	640						
	1995.01-	2001.03	MT	R	F	MPV Engine 425CLIRS/X/ENC	GDS89039	Drive Shaft	47T	26	25	54	98.5	1028						
	1995.01-	2001.03			F	MPV Engine 425CLIRS/X/ENC	GC089009	Outer Joint		26	32	54	98.5	61.5	I					
3.0 (112 kW)	1995.01-	2001.03	AT	L	F	MPV Engine EFA	GDS88024	Drive Shaft	47T	26	25	54	98.5	640						
	1995.01-	2001.03	AT	R	F	MPV Engine EFA	GDS89039	Drive Shaft	47T	26	25	54	98.5	1028						
3.3 i (116 kW)	1995.01-	2001.03	AT	L	F	MPV Engine R00	GDS88024	Drive Shaft	47T	26	25	54	98.5	640						
	1995.01-	2001.03	AT	R	F	MPV Engine R00	GDS89039	Drive Shaft	47T	26	25	54	98.5	1028						
3.8 i AWD (122 kW)	1995.01-	2001.03	AT	L	F	MPV Engine L00	GDS88024	Drive Shaft	47T	26	25	54	98.5	640						
	1995.01-	2001.03	AT	R	F	MPV Engine L00	GDS89039	Drive Shaft	47T	26	25	54	98.5	1028						
3.8 i AWD (131 kW)	1995.01-	2001.03	AT	L	F	MPV Engine EGH	GDS88024	Drive Shaft	47T	26	25	54	98.5	640						
	1995.01-	2001.03	AT	R	F	MPV Engine EGH	GDS89039	Drive Shaft	47T	26	25	54	98.5	1028						
<b>VOYAGER III (RG, RS)</b>																				
2.4 (108 kW)	2000.02-	2008.12	MT	L	F	MPV Engine EDZ	GDS89067	Drive Shaft	47T	26	27	54.1	98	639						
	2000.02-	2008.12	MT	R	F	MPV Engine EDZ	GDS89082	Drive Shaft	47T	26	27	54	98.5	1031						
2.5 CRD (105 kW)	2000.02-	2008.12	MT	L	F	MPV Engine ENC	GDS89067	Drive Shaft	47T	26	27	54.1	98	639						
	2000.02-	2008.12	MT	R	F	MPV Engine ENC	GDS89082	Drive Shaft	47T	26	27	54	98.5	1031						
2.5 CRD (88 kW)	2005.08-	2008.12	MT	L	F	MPV Engine EDK	GDS89067	Drive Shaft	47T	26	27	54.1	98	639						
	2005.08-	2008.12	MT	R	F	MPV Engine EDK	GDS89082	Drive Shaft	47T	26	27	54	98.5	1031						
<b>CHRYSLER TRUCK TOWN / COUNTRY MINI VAN</b>																				
-	1996-	1997		R		Truck 2WD	GDS89005	Drive Shaft	47T	26	25	54	98.5	1030						
	1996-	1997					GCI89011	Inner Joint		25	32	40	71.5	107						
<b>CHRYSLER TRUCK / VAN TOWN / COUNTRY VAN</b>																				
-	1987-	1995					GCI89005	Inner Joint		25	32	40	71	122						
<b>CITROEN AX</b>																				
1.4	1991.07-			R			GDS10093	Drive Shaft		21	22	56.4	76	796						
	1991.07-			L			GDS10094	Drive Shaft		21	22	56.4	76	615						
1.5	1991.05-			R			GDS10093	Drive Shaft		21	22	56.4	76	796						
	1991.05-			L			GDS10094	Drive Shaft		21	22	56.4	76	615						
<b>AX (ZA-)</b>																				
1.0 (32 kW)	1986.07-	1998.12	MT	L	F	Hatchback Engine CDY(TU9M)	GDS10005	Drive Shaft		21	22	50	81.5	619						
	1986.07-	1998.12	MT	R	F	Hatchback Engine CDY(TU9M)	GDS10003	Drive Shaft		21	22	49	81	798						
	1986.09-	1992.06	MT	L	F	Hatchback Engine C1A	GDS10005	Drive Shaft		21	22	50	81.5	619						
	1986.09-	1992.06	MT	R	F	Hatchback Engine C1A	GDS10003	Drive Shaft		21	22	49	81	798						
1.0 E (30 kW)	1986.12-	1988.12	MT	L	F	Hatchback Engine C3A	GDS10005	Drive Shaft		21	22	50	81.5	619						
	1986.12-	1988.12	MT	R	F	Hatchback Engine C3A	GDS10003	Drive Shaft		21	22	49	81	798						
1.1 (40 kW)	1986.12-	1994.04	MT	L	F	Hatchback Engine H1A/H1B	GDS10005	Drive Shaft		21	22	50	81.5	619						
	1986.12-	1994.04	MT	R	F	Hatchback Engine H1A/H1B	GDS10003	Drive Shaft		21	22	49	81	798						
1.1 (44 kW)	1986.09-	1997.12	MT	L	F	Hatchback Engine H1B/HDZ(TU1M)	GDS10005	Drive Shaft		21	22	50	81.5	619						
	1986.09-	1997.12	MT	R	F	Hatchback Engine H1B/HDZ(TU1M)	GDS10003	Drive Shaft		21	22	49	81	798						
1.1 CAT (40 kW)	1988.09-	1989.12	MT	L	F	Hatchback Engine HAZ(TU1CP)	GDS10005	Drive Shaft		21	22	50	81.5	619						
	1988.09-	1989.12	MT	R	F	Hatchback Engine HAZ(TU1CP)	GDS10003	Drive Shaft		21	22	49	81	798						
1.3 Sport (70 kW)	1987.04-	1988.12	MT	L	F	Hatchback Engine M4A	GDS10005	Drive Shaft		21	22	50	81.5	619						
	1987.04-	1988.12	MT	R	F	Hatchback Engine M4A	GDS10003	Drive Shaft		21	22	49	81	798						
1.4 (44 kW)	1986.12-	1988.12	MT	L	F	Hatchback Engine KAY(TU3CP)	GDS10005	Drive Shaft		21	22	50	81.5	619						
	1986.12-	1988.12	MT	R	F	Hatchback Engine KAY(TU3CP)	GDS10003	Drive Shaft		21	22	49	81	798						



		YEAR	TRANSM	L/R	F/R		G-AP Ref.	PRODUCT	ABS	Technical Specifications								
										A	B	C	H	L	P			
<b>CITROEN</b>																		
<b>AX (ZA-)</b>																		
1.4 (49 kW)	1988.06-	1989.12	MT	L	F	Hatchback Engine K1F	GDS10005	Drive Shaft		21	22	50	81.5	619				
	1988.06-	1989.12	MT	R	F	Hatchback Engine K1F	GDS10003	Drive Shaft		21	22	49	81	798				
1.4 (55 kW)	1987.04-	1997.04	MT	L	F	Hatchback Engine KDX(TU3M/Z)/KDY(TU3FM)/KDY(TU3M)/KDZ(TU3M/Z)	GDS10005	Drive Shaft		21	22	50	81.5	619				
	1987.04-	1997.04	MT	R	F	Hatchback Engine KDX(TU3M/Z)/KDY(TU3FM)/KDY(TU3M)/KDZ(TU3M/Z)	GDS10003	Drive Shaft		21	22	49	81	798				
1.4 (62 kW)	1988.01-	1992.12	MT	L	F	Hatchback Engine K2A/K2B	GDS10005	Drive Shaft		21	22	50	81.5	619				
	1988.01-	1992.12	MT	R	F	Hatchback Engine K2A/K2B	GDS10003	Drive Shaft		21	22	49	81	798				
1.4 D (37 kW)	1991.08-	1997.12	MT	L	F	Hatchback Engine K9Y(TUD3Y)	GDS10005	Drive Shaft		21	22	50	81.5	619				
	1991.08-	1997.12	MT	R	F	Hatchback Engine K9Y(TUD3Y)	GDS10003	Drive Shaft		21	22	49	81	798				
1.4 D (38 kW)	1988.09-	1992.06	MT	L	F	Hatchback Engine K9A(TUD3)	GDS10005	Drive Shaft		21	22	50	81.5	619				
	1988.09-	1992.06	MT	R	F	Hatchback Engine K9A(TUD3)	GDS10003	Drive Shaft		21	22	49	81	798				
<b>BERLINGO</b>																		
-							GC045042	Outer Joint	29T	25	25	55	79.5	56	O			
1.6 (66 kW)	2008.04-		MT	L	F	Box Engine NFR(TU5JP4B)	GDS45105	Drive Shaft		25	24	58	79	625				
	2008.04-		MT	L	F	MPV Engine NFR(TU5JP4B)	GDS10255	Drive Shaft		25	24	58.5	79	616				
	2008.04-		MT	R	F	Box Engine NFR(TU5JP4B)	GDS45104	Drive Shaft		25	24	58	79	925				
	2008.04-		MT	R	F	MPV Engine NFR(TU5JP4B)	GDS10254	Drive Shaft		25	24	58.5	79	939				
	2008.04-		MT	L	F	Box Engine NFR(TU5JP4B)	GDS99019	Drive Shaft	29T	25	24	55.7	79	620				
	2008.04-		MT	R	F	Box Engine NFR(TU5JP4B)	GDS10229	Drive Shaft		25	24	58.5	79	935				
	2008.04-					Box Engine NFR(TU5JP4B)	GC099366	Outer Joint		25	34	58.5	79	55	I			
	2008.04-					MPV Engine NFR(TU5JP4B)	GC099366	Outer Joint		25	34	58.5	79	55	I			
1.6 (80 kW)	2008.04-		MT	L	F	Box Engine NFU(TU5JP4)	GDS45105	Drive Shaft		25	24	58	79	625				
	2008.04-		MT	L	F	MPV Engine NFU(TU5JP4)	GDS10255	Drive Shaft		25	24	58.5	79	616				
	2008.04-		MT	R	F	Box Engine NFU(TU5JP4)	GDS45104	Drive Shaft		25	24	58	79	925				
	2008.04-		MT	R	F	MPV Engine NFU(TU5JP4)	GDS10254	Drive Shaft		25	24	58.5	79	939				
	2008.04-		MT	L	F	Box Engine NFU(TU5JP4)	GDS99019	Drive Shaft	29T	25	24	55.7	79	620				
	2008.04-		MT	L	F	MPV Engine NFU(TU5JP4)	GDS99019	Drive Shaft	29T	25	24	55.7	79	620				
	2008.04-		MT	R	F	Box Engine NFU(TU5JP4)	GDS10229	Drive Shaft		25	24	58.5	79	935				
	2008.04-		MT	R	F	MPV Engine NFU(TU5JP4)	GDS10229	Drive Shaft		25	24	58.5	79	935				
	2008.04-					Box Engine NFU(TU5JP4)	GC099366	Outer Joint		25	34	58.5	79	55	I			
	2008.04-					MPV Engine NFU(TU5JP4)	GC099366	Outer Joint		25	34	58.5	79	55	I			
1.6 16V Essenc				R			GDS10078	Drive Shaft	29W	25	24	55.7	79	872				
1.6 HDi (55 kW)	2008.04-					MPV Engine 9HT(DV6BTED4)	GC099366	Outer Joint		25	34	58.5	79	55	I			
	2008.04-		MT	L	F	Box Engine 9HT(DV6BUTED4)	GDS45105	Drive Shaft		25	24	58	79	625				
	2008.04-		MT	R	F	Box Engine 9HT(DV6BUTED4)	GDS45104	Drive Shaft		25	24	58	79	925				
	2008.04-		MT	L	F	Box Engine 9HT(DV6BUTED4)	GDS99019	Drive Shaft	29T	25	24	55.7	79	620				
	2008.04-		MT	L	F	MPV Engine 9HT(DV6BTED4)	GDS99019	Drive Shaft	29T	25	24	55.7	79	620				
	2008.04-		MT	R	F	Box Engine 9HT(DV6BUTED4)	GDS10229	Drive Shaft		25	24	58.5	79	935				
	2008.04-		MT	R	F	MPV Engine 9HT(DV6BTED4)	GDS10229	Drive Shaft		25	24	58.5	79	935				
	2008.04-					Box Engine 9HT(DV6BUTED4)	GC099366	Outer Joint		25	34	58.5	79	55	I			
1.6 HDi (66 kW)	2008.04-		MT	L	F	Box Engine 9HX(DV6ATED4)/9HS(DV6TED4BU)	GDS45105	Drive Shaft		25	24	58	79	625				
	2008.04-		MT	R	F	Box Engine 9HX(DV6ATED4)/9HS(DV6TED4BU)	GDS45104	Drive Shaft		25	24	58	79	925				
	2008.04-					Box Engine 9HX(DV6ATED4)/9HS(DV6TED4BU)	GC099366	Outer Joint		25	34	58.5	79	55	I			
	2008.04-					MPV Engine 9HX(DV6ATED4)	GC099366	Outer Joint		25	34	58.5	79	55	I			
	2008.04-					Platform/Chassis	GC099366	Outer Joint		25	34	58.5	79	55	I			
1.6 HDi (68 kW)	2010.07-			L	F	MPV Engine 9HX(DV6ATED4)	GDS10255	Drive Shaft		25	24	58.5	79	616				
	2010.07-			R	F	MPV Engine 9HX(DV6ATED4)	GDS10254	Drive Shaft		25	24	58.5	79	939				
	2010.07-					Box Engine 9HP(DV6DTEED)	GC099366	Outer Joint		25	34	58.5	79	55	I			
	2010.07-					MPV Engine 9HX(DV6ATED4)	GC099366	Outer Joint		25	34	58.5	79	55	I			
1.6 HDi (80 kW)	2008.04-		MT	L	F	Box Engine 9HZ(DV6TED4)	GDS45105	Drive Shaft		25	24	58	79	625				
	2008.04-		MT	L	F	MPV Engine 9HZ(DV6TED4)	GDS10255	Drive Shaft		25	24	58.5	79	616				
	2008.04-		MT	R	F	Box Engine 9HZ(DV6TED4)	GDS45104	Drive Shaft		25	24	58	79	925				
	2008.04-		MT	R	F	MPV Engine 9HZ(DV6TED4)	GDS10254	Drive Shaft		25	24	58.5	79	939				
	2008.04-		MT			Box Engine 9HZ(DV6TED4)	GC099293	Outer Joint	48W	25	34	58.5	79	55	I			
	2008.04-		MT			MPV Engine 9HZ(DV6TED4)	GC099293	Outer Joint	48W	25	34	58.5	79	55	I			
	2008.04-					Box Engine 9HZ(DV6TED4)	GC099366	Outer Joint		25	34	58.5	79	55	I			
	2008.04-					MPV Engine 9HZ(DV6TED4)	GC099366	Outer Joint		25	34	58.5	79	55	I			
1.6 HDi (82 kW)	2010.07-			L	F	Box Engine 9HR(DV6C)/9HL(DV6C)	GDS10255	Drive Shaft		25	24	58.5	79	616				
	2010.07-			L	F	MPV Engine 9HR(DV6C)/9HL(DV6C)	GDS10255	Drive Shaft		25	24	58.5	79	616				
	2010.07-			R	F	Box Engine 9HR(DV6C)/9HL(DV6C)	GDS10254	Drive Shaft		25	24	58.5	79	939				
	2010.07-			R	F	MPV Engine 9HR(DV6C)/9HL(DV6C)	GDS10254	Drive Shaft		25	24	58.5	79	939				
	2010.07-					Box Engine 9HR(DV6C)/9HL(DV6C)	GC099366	Outer Joint		25	34	58.5	79	55	I			
	2010.07-					MPV Engine 9HR(DV6C)/9HL(DV6C)	GC099366	Outer Joint		25	34	58.5	79	55	I			





		TRANSM	L/R	F/R		G-AP Ref.	PRODUCT	ABS	Technical Specifications					
									YEAR	A	B	C	H	L
<b>CITROEN BERLINGO</b>														
1.6 HDi (84 kW)	2010.07-			L	F	Box Engine 9HL(DV6C)	GDS10255	Drive Shaft		25	24	58.5	79	616
	2010.07-			L	F	MPV Engine 9HR(DV6C)	GDS10255	Drive Shaft		25	24	58.5	79	616
	2010.07-			R	F	Box Engine 9HL(DV6C)	GDS10254	Drive Shaft		25	24	58.5	79	939
	2010.07-			R	F	MPV Engine 9HR(DV6C)	GDS10254	Drive Shaft		25	24	58.5	79	939
1.6 VTi (72 kW)	2010.07-					Box Engine 5FK(EP6CB)	GC099366	Outer Joint		25	34	58.5	79	55 I
	2010.07-					MPV Engine 5FK(EP6CB)	GC099366	Outer Joint		25	34	58.5	79	55 I
1.6 VTi (88 kW)	2009.11-		MT	L	F	Box Engine 5FS(EP6C)	GDS99019	Drive Shaft	29T	25	24	55.7	79	620
	2009.11-		MT	L	F	MPV Engine 5FS(EP6C)	GDS99019	Drive Shaft	29T	25	24	55.7	79	620
	2009.11-		MT	R	F	Box Engine 5FS(EP6C)	GDS10229	Drive Shaft		25	24	58.5	79	935
	2009.11-		MT	R	F	MPV Engine 5FS(EP6C)	GDS10229	Drive Shaft		25	24	58.5	79	935
	2009.11-					Box Engine 5FS(EP6C)	GC099366	Outer Joint		25	34	58.5	79	55 I
	2009.11-					MPV Engine 5FS(EP6C)	GC099366	Outer Joint		25	34	58.5	79	55 I
1.8	1980.01-	1990.12	MT				GC010038	Outer Joint		25	25	60	79	61.5 O
<b>BERLINGO (MF)</b>														
1.1 i (44 kW)	1996.07-			L	F	MPV Engine HDZ(TU1M)/HFX(TU1JP)	GDS10187	Drive Shaft	29T	25	22	54.5	79.5	590.5
	1996.07-			R	F	MPV Engine HDZ(TU1M)/HFX(TU1JP)	GDS10188	Drive Shaft	29T	25	22	54.5	79.5	860
	1996.07-		MT	R	F	MPV Engine HDZ(TU1M)/HFX(TU1JP)	GDS10015	Drive Shaft		25	22	56.7	79	868
1.4 i (55 kW)	1996.07-			L	F	MPV Engine KFW(TU3JP)/KFX(TU3JP)	GDS10187	Drive Shaft	29T	25	22	54.5	79.5	590.5
	1996.07-			R	F	MPV Engine KFW(TU3JP)/KFX(TU3JP)	GDS10188	Drive Shaft	29T	25	22	54.5	79.5	860
	1996.07-		MT	R	F	MPV Engine KFW(TU3JP)/KFX(TU3JP)	GDS10015	Drive Shaft		25	22	56.7	79	868
1.6 16V (80 kW)	2000.10-		MT	L	F	MPV Engine NFU(TU5JP4)	GDS99025	Drive Shaft	29W	25	24	55.7	79	597
1.6 16V (81 kW)	2005.11-		MT	L	F	MPV Engine NFU(TU5JP4)	GDS99025	Drive Shaft	29W	25	24	55.7	79	597
	2005.11-			L	F	MPV Engine NFU(TU5JP4)	GDS99195	Drive Shaft	48W	25	24	58.5	79	585
	2005.11-			R	F	MPV Engine NFU(TU5JP4)	GDS99196	Drive Shaft	48W	25	24	58.5	79	869
	2005.11-					MPV Engine NFU(TU5JP4)	GC010042	Outer Joint		25	34	54.8	78.5	56 I
1.6 HDi (55 kW)	2005.10-	2007.05			F	MPV Engine 9HW(DV6ETED)/DV6B	GC010067	Outer Joint	48W	25	34	58.5	79	55 I
	2005.10-	2007.05		L	F	MPV Engine 9HW(DV6ETED)/DV6B	GDS99195	Drive Shaft	48W	25	24	58.5	79	585
	2005.10-	2007.05		R	F	MPV Engine 9HW(DV6ETED)/DV6B	GDS99196	Drive Shaft	48W	25	24	58.5	79	869
	2005.10-	2007.05				MPV Engine 9HW(DV6ETED)/DV6B	GC099293	Outer Joint	48W	25	34	58.5	79	55 I
1.6 HDi (66 kW)	2005.10-	2007.05			F	MPV Engine 9HX(DV6ATED4)	GC010067	Outer Joint	48W	25	34	58.5	79	55 I
	2005.10-	2007.05		L	F	MPV Engine 9HX(DV6ATED4)	GDS99195	Drive Shaft	48W	25	24	58.5	79	585
	2005.10-	2007.05		R	F	MPV Engine 9HX(DV6ATED4)	GDS99196	Drive Shaft	48W	25	24	58.5	79	869
	2005.10-	2007.05				MPV Engine 9HX(DV6ATED4)	GC099293	Outer Joint	48W	25	34	58.5	79	55 I
1.6 HDi (80 kW)	2005.08-			L	F	MPV Engine 9HZ(DV6TED4)	GDS99195	Drive Shaft	48W	25	24	58.5	79	585
	2005.08-			R	F	MPV Engine 9HZ(DV6TED4)	GDS99196	Drive Shaft	48W	25	24	58.5	79	869
	2005.08-					MPV Engine 9HZ(DV6TED4)	GC099293	Outer Joint	48W	25	34	58.5	79	55 I
1.8 D (43 kW)	1998.07-			R	F	MPV Engine A9A(XUD7)	GDS10226	Drive Shaft	29T	25	24	58	78.5	867
	1998.07-			L	F	MPV Engine A9A(XUD7)	GDS10227	Drive Shaft		25	24	58.5	78.5	595
1.8 i (66 kW)	1997.05-			R	F	MPV Engine LFX(XU7JB)	GDS10226	Drive Shaft	29T	25	24	58	78.5	867
	1997.05-			L	F	MPV Engine LFX(XU7JB)	GDS10227	Drive Shaft		25	24	58.5	78.5	595
	1997.05-				F	MPV Engine LFX(XU7JB)	GC010020	Outer Joint	29T	25	34	58	78.5	55 I
1.8 i 4WD (66 kW)	1997.04-			R	F	MPV Engine LFX(XU7JB)	GDS10226	Drive Shaft	29T	25	24	58	78.5	867
	1997.04-			L	F	MPV Engine LFX(XU7JB)	GDS10227	Drive Shaft		25	24	58.5	78.5	595
	1997.04-					MPV Engine LFX(XU7JB)	GC010020	Outer Joint	29T	25	34	58	78.5	55 I
1.9 D (50 kW)	1996.07-			R	F	MPV Engine D9B(XUD9A/L)/DJY(XUD9A)	GDS10226	Drive Shaft	29T	25	24	58	78.5	867
	1996.07-			L	F	MPV Engine D9B(XUD9A/L)/DJY(XUD9A)	GDS10227	Drive Shaft		25	24	58.5	78.5	595
	1996.07-				F	MPV Engine D9B(XUD9A/L)/DJY(XUD9A)	GC010020	Outer Joint	29T	25	34	58	78.5	55 I
1.9 D (51 kW)	1998.07-			R	F	MPV Engine WJY(DW8B)/WJZ(DW8)	GDS10226	Drive Shaft	29T	25	24	58	78.5	867
	1998.07-			L	F	MPV Engine WJY(DW8B)/WJZ(DW8)	GDS10227	Drive Shaft		25	24	58.5	78.5	595
1.9 D 4WD (51 kW)	1998.07-			R	F	MPV Engine WJZ(DW8)/WJY(DW8B)	GDS10226	Drive Shaft	29T	25	24	58	78.5	867
	1998.07-			L	F	MPV Engine WJZ(DW8)/WJY(DW8B)	GDS10227	Drive Shaft		25	24	58.5	78.5	595
2.0 HDi 4x4 (66 kW)	2002.11-	2005.10				MPV Engine RHY(DW10TD)	GC010022	Outer Joint	29W	25	34	55.7	79	55 I
<b>BERLINGO (M_)</b>														
1.1 i (44 kW)	1996.07-			L	F	Box Engine HDZ(TU1M)/HFX(TU1JP)	GDS10187	Drive Shaft	29T	25	22	54.5	79.5	590.5
	1996.07-			R	F	Box Engine HDZ(TU1M)/HFX(TU1JP)	GDS10188	Drive Shaft	29T	25	22	54.5	79.5	860
	1996.07-		MT	R	F	Box Engine HDZ(TU1M)/HFX(TU1JP)	GDS10015	Drive Shaft		25	22	56.7	79	868
1.4 i (55 kW)	1996.07-			L	F	Box Engine KFW(TU3JP)/KFX(TU3JP)	GDS10187	Drive Shaft	29T	25	22	54.5	79.5	590.5
	1996.07-			R	F	Box Engine KFW(TU3JP)/KFX(TU3JP)	GDS10188	Drive Shaft	29T	25	22	54.5	79.5	860
	1996.07-		MT	R	F	Box Engine KFW(TU3JP)/KFX(TU3JP)	GDS10015	Drive Shaft		25	22	56.7	79	868
1.6 16V (80 kW)	2000.10-		MT	L	F	Box Engine NFU(TU5JP4)	GDS99025	Drive Shaft	29W	25	24	55.7	79	597
	2000.10-			L	F	Box Engine NFU(TU5JP4)	GDS99195	Drive Shaft	48W	25	24	58.5	79	585
	2000.10-			R	F	Box Engine NFU(TU5JP4)	GDS99196	Drive Shaft	48W	25	24	58.5	79	869



		TRANSM	L/R	F/R		G-AP Ref.	PRODUCT	ABS	Technical Specifications								
									YEAR	A	B	C	H	L	P		
<b>CITROEN BERLINGO (M_)</b>																	
1.6 HDi (55 kW)	2005.07-			F	Box Engine 9HW(DV6ETED)/DV6B	GC010067	Outer Joint	48W	25	34	58.5	79	55	I			
	2005.07-		L	F	Box Engine 9HW(DV6ETED)/DV6B	GDS99195	Drive Shaft	48W	25	24	58.5	79	585				
	2005.07-		R	F	Box Engine 9HW(DV6ETED)/DV6B	GDS99196	Drive Shaft	48W	25	24	58.5	79	869				
	2005.07-				Box Engine 9HW(DV6ETED)/DV6B	GC099293	Outer Joint	48W	25	34	58.5	79	55	I			
1.6 HDi (66 kW)	2005.07-			F	Box Engine 9HX(DV6ATED4)	GC010067	Outer Joint	48W	25	34	58.5	79	55	I			
	2005.07-				Box Engine 9HX(DV6ATED4)	GC099293	Outer Joint	48W	25	34	58.5	79	55	I			
1.8 D (43 kW)	1996.07-		R	F	Box Engine A9A(XUD7)	GDS10226	Drive Shaft	29T	25	24	58	78.5	867				
	1996.07-		L	F	Box Engine A9A(XUD7)	GDS10227	Drive Shaft		25	24	58.5	78.5	595				
1.8 i (66 kW)	1998.06-2000.06		R	F	Box Engine LFX(XU7JB)	GDS10226	Drive Shaft	29T	25	24	58	78.5	867				
	1998.06-2000.06		L	F	Box Engine LFX(XU7JB)	GDS10227	Drive Shaft		25	24	58.5	78.5	595				
1.9 D (51 kW)	1996.07-		R	F	Box Engine DJY(XUD9A)	GDS10226	Drive Shaft	29T	25	24	58	78.5	867				
	1996.07-		L	F	Box Engine DJY(XUD9A)	GDS10227	Drive Shaft		25	24	58.5	78.5	595				
	1996.07-				Box Engine DJY(XUD9A)	GC010020	Outer Joint	29T	25	34	58	78.5	55	I			
	1999.04-		R	F	Box Engine WJY(DW8B)/WJZ(DW8)	GDS10226	Drive Shaft	29T	25	24	58	78.5	867				
	1999.04-		L	F	Box Engine WJY(DW8B)/WJZ(DW8)	GDS10227	Drive Shaft		25	24	58.5	78.5	595				
1.9 D 4WD (51 kW)	1998.07-		R	F	Box Engine WJY(DW8B)/WJZ(DW8)	GDS10226	Drive Shaft	29T	25	24	58	78.5	867				
	1998.07-		L	F	Box Engine WJY(DW8B)/WJZ(DW8)	GDS10227	Drive Shaft		25	24	58.5	78.5	595				
2.0 HDi 4WD (66 kW)	2000.11-		L	F	Box Engine RHY(DW10TD)	GDS99195	Drive Shaft	48W	25	24	58.5	79	585				
	2000.11-		R	F	Box Engine RHY(DW10TD)	GDS99196	Drive Shaft	48W	25	24	58.5	79	869				
<b>BERLINGO / XANTIA / XSARA</b>																	
-						GC010042	Outer Joint		25	34	54.8	78.5	56	I			
<b>BERLINGO MULTISPACE</b>																	
1.6 HDi	2005.10-		MT/AT	F		GC045047	Outer Joint	48T	25	34	59	78.5	54	I			
<b>BX (XB-)</b>																	
1.1 (40 kW)	1988.10-	1992.06	MT	F	Hatchback Engine HDZ(TU1M)	GC010001	Outer Joint		25	22	54.8	79	48	I			
1.4 (47 kW)	1989.01-	1989.12	MT	F	Hatchback Engine K1H(TU3A)	GC010001	Outer Joint		25	22	54.8	79	48	I			
1.4 (55 kW)	1989.01-	1993.02	MT	F	Hatchback Engine KDY(TU3M)/KDZ(TU3M/Z)	GC010001	Outer Joint		25	22	54.8	79	48	I			
1.4 E (49 kW)	1985.09-	1993.02	MT	F	Hatchback Engine 150F	GC010001	Outer Joint		25	22	54.8	79	48	I			
1.4 E (52 kW)	1983.04-	1989.07	MT	F	Hatchback Engine 150C/K1G	GC010001	Outer Joint		25	22	54.8	79	48	I			
1.4 E (53 kW)	1983.04-	1993.02	MT	F	Hatchback Engine 150C	GC010001	Outer Joint		25	22	54.8	79	48	I			
1.6 (53 kW)	1987.01-	1993.02	MT	F	Hatchback Engine B1E(XU51C)	GC010001	Outer Joint		25	22	54.8	79	48	I			
	1987.01-	1993.02	MT	L	F	Hatchback Engine B1E(XU51C)	GDS10278	Drive Shaft	25	24	54.8	79	595				
	1987.01-	1993.02	MT	R	F	Hatchback Engine B1E(XU51C)	GDS10024	Drive Shaft	25	24	54.8	79	867				
1.6 (55 kW)	1988.09-	1993.02	MT	F	Hatchback Engine BAY(XU5CP)/BAZ(XU5CP)	GC010001	Outer Joint		25	22	54.8	79	48	I			
	1988.09-	1993.02	MT	L	F	Hatchback Engine BAY(XU5CP)/BAZ(XU5CP)	GDS10278	Drive Shaft	25	24	54.8	79	595				
	1988.09-	1993.02	MT	R	F	Hatchback Engine BAY(XU5CP)/BAZ(XU5CP)	GDS10024	Drive Shaft	25	24	54.8	79	867				
1.6 (59 kW)	1987.10-	1992.05	MT	F	Hatchback Engine B1E(XU51C)	GC010001	Outer Joint		25	22	54.8	79	48	I			
	1987.10-	1992.05	MT	L	F	Hatchback Engine B1E(XU51C)	GDS10278	Drive Shaft	25	24	54.8	79	595				
	1987.10-	1992.05	MT	R	F	Hatchback Engine B1E(XU51C)	GDS10024	Drive Shaft	25	24	54.8	79	867				
1.6 (64 kW)	1985.07-	1993.02	MT	F	Hatchback Engine 171D	GC010005	Outer Joint	90T	25	23	54.8	78.5	56	I			
	1985.07-	1993.02	MT	F	Hatchback Engine 171D	GC010001	Outer Joint		25	22	54.8	79	48	I			
	1985.07-	1993.02	MT	L	F	Hatchback Engine 171D	GDS10278	Drive Shaft	25	24	54.8	79	595				
	1985.07-	1993.02	MT	R	F	Hatchback Engine 171D	GDS10024	Drive Shaft	25	24	54.8	79	867				
1.6 (66 kW)	1982.10-	1988.06	L	F	Hatchback Engine 171A/171B/171C	GDS10117	Drive Shaft		25	24	54.8	79	592.5				
	1982.10-	1988.06	MT	F	Hatchback Engine 171A/171B/171C	GC010005	Outer Joint	90T	25	23	54.8	78.5	56	I			
	1982.10-	1988.06	MT	F	Hatchback Engine 171A/171B/171C	GC010001	Outer Joint		25	22	54.8	79	48	I			
	1982.10-	1988.06	MT	L	F	Hatchback Engine 171A/171B/171C	GDS10278	Drive Shaft	25	24	54.8	79	595				
	1982.10-	1988.06	MT	R	F	Hatchback Engine 171A/171B/171C	GDS10024	Drive Shaft	25	24	54.8	79	867				
1.6 (68 kW)	1982.10-	1992.12	L	F	Hatchback Engine XU52C	GDS10117	Drive Shaft		25	24	54.8	79	592.5				
	1982.10-	1992.12	MT	F	Hatchback Engine XU52C	GC010001	Outer Joint		25	22	54.8	79	48	I			
	1982.10-	1992.12	MT	L	F	Hatchback Engine XU52C	GDS10278	Drive Shaft	25	24	54.8	79	595				
	1982.10-	1992.12	MT	R	F	Hatchback Engine XU52C	GDS10024	Drive Shaft	25	24	54.8	79	867				
1.6 (76 kW)	1986.03-	1993.02	MT	F	Hatchback Engine 180Z	GC010005	Outer Joint	90T	25	23	54.8	78.5	56	I			
	1986.03-	1993.02	MT	F	Hatchback Engine 180Z	GC010001	Outer Joint		25	22	54.8	79	48	I			
	1986.03-	1993.02	MT	L	F	Hatchback Engine 180Z	GDS10278	Drive Shaft	25	24	54.8	79	595				
	1986.03-	1993.02	MT	R	F	Hatchback Engine 180Z	GDS10024	Drive Shaft	25	24	54.8	79	867				
1.6 E (65 kW)	1989.05-	1993.02	MT	F	Hatchback Engine BDY(XU5M)/BDZ(XU5M)	GC010001	Outer Joint		25	22	54.8	79	48	I			
	1989.05-	1993.02	MT	L	F	Hatchback Engine BDY(XU5M)/BDZ(XU5M)	GDS10278	Drive Shaft	25	24	54.8	79	595				
	1989.05-	1993.02	MT	R	F	Hatchback Engine BDY(XU5M)/BDZ(XU5M)	GDS10024	Drive Shaft	25	24	54.8	79	867				
1.8 D (44 kW)	1985.10-	1993.09	MT	F	Hatchback Engine 161(XUD7)	GC010001	Outer Joint		25	22	54.8	79	48	I			
	1985.10-	1993.09	MT	L	F	Hatchback Engine 161(XUD7)	GDS10278	Drive Shaft	25	24	54.8	79	595				
	1985.10-	1993.09	MT	R	F	Hatchback Engine 161(XUD7)	GDS10024	Drive Shaft	25	24	54.8	79	867				





		TRANSM	L/R	F/R		G-AP Ref.	PRODUCT	ABS	Technical Specifications											
									YEAR	A	B	C	H	L	P					
<b>CITROEN BX (XB-)</b>																				
1.8 TRD Turbo (66 kW)	1988.03-	1993.02	MT	L	F	Hatchback Engine A8A(XUD7TE)/AJZ(XUD7TE)	GDS10090	Drive Shaft		25	24	54.8	78.5	593						
1.9 (70 kW)	1986.09-	1989.11	MT	L	F	Hatchback Engine D2C(XU92C)	GDS10278	Drive Shaft		25	24	54.8	79	595						
	1986.09-	1989.11	MT	R	F	Hatchback Engine D2C(XU92C)	GDS10024	Drive Shaft		25	24	54.8	79	867						
	1986.09-	1989.11	MT		F	Hatchback Engine D2C(XU92C)	GC010001	Outer Joint		25	22	54.8	79	48	I					
1.9 (75 kW)	1986.07-	1989.05	MT		F	Hatchback Engine 159A	GC010001	Outer Joint		25	22	54.8	79	48	I					
	1986.07-	1989.05	MT	L	F	Hatchback Engine 159A	GDS10278	Drive Shaft		25	24	54.8	79	595						
	1986.07-	1989.05	MT	R	F	Hatchback Engine 159A	GDS10024	Drive Shaft		25	24	54.8	79	867						
1.9 (77 kW)	1986.07-	1989.05	MT		F	Hatchback Engine D2A(XU92C)	GC010001	Outer Joint		25	22	54.8	79	48	I					
	1986.07-	1989.05	MT	L	F	Hatchback Engine D2A(XU92C)	GDS10278	Drive Shaft		25	24	54.8	79	595						
	1986.07-	1989.05	MT	R	F	Hatchback Engine D2A(XU92C)	GDS10024	Drive Shaft		25	24	54.8	79	867						
1.9 D (47 kW)	1983.09-	1993.09		L	F	Hatchback Engine 162(XUD9)/DJZ(XUD9Y)/D9A(XUD9)	GDS10117	Drive Shaft		25	24	54.8	79	592.5						
	1983.09-	1993.09	MT		F	Hatchback Engine 162(XUD9)/DJZ(XUD9Y)/D9A(XUD9)	GC010005	Outer Joint	90T	25	23	54.8	78.5	56	I					
	1983.09-	1993.09	MT		F	Hatchback Engine 162(XUD9)/DJZ(XUD9Y)/D9A(XUD9)	GC010001	Outer Joint		25	22	54.8	79	48	I					
	1983.09-	1993.09	MT	L	F	Hatchback Engine 162(XUD9)/DJZ(XUD9Y)/D9A(XUD9)	GDS10278	Drive Shaft		25	24	54.8	79	595						
	1983.09-	1993.09	MT	R	F	Hatchback Engine 162(XUD9)/DJZ(XUD9Y)/D9A(XUD9)	GDS10024	Drive Shaft		25	24	54.8	79	867						
1.9 D (51 kW)	1987.03-	1993.02	MT		F	Hatchback Engine D9B(XUD9A/U)	GC010001	Outer Joint		25	22	54.8	79	48	I					
	1987.03-	1993.02	MT	L	F	Hatchback Engine D9B(XUD9A/U)	GDS10278	Drive Shaft		25	24	54.8	79	595						
	1987.03-	1993.02	MT	R	F	Hatchback Engine D9B(XUD9A/U)	GDS10024	Drive Shaft		25	24	54.8	79	867						
1.9 E (80 kW)	1988.06-	1993.02	MT		F	Hatchback Engine DDZ(XU9M)	GC010001	Outer Joint		25	22	54.8	79	48	I					
	1988.06-	1993.02	MT	L	F	Hatchback Engine DDZ(XU9M)	GDS10278	Drive Shaft		25	24	54.8	79	595						
	1988.06-	1993.02	MT	R	F	Hatchback Engine DDZ(XU9M)	GDS10024	Drive Shaft		25	24	54.8	79	867						
1.9 E 4x4 (80 kW)	1989.04-	1993.02	MT		F	Hatchback Engine D2F	GC010001	Outer Joint		25	22	54.8	79	48	I					
	1989.04-	1993.02	MT	L	F	Hatchback Engine D2F	GDS10278	Drive Shaft		25	24	54.8	79	595						
	1989.04-	1993.02	MT	R	F	Hatchback Engine D2F	GDS10024	Drive Shaft		25	24	54.8	79	867						
19 GTi (88 kW)	1988.06-	1993.02	MT		F	Hatchback Engine DKZ(XU9JA)	GC010001	Outer Joint		25	22	54.8	79	48	I					
	1988.06-	1993.02	MT	L	F	Hatchback Engine DKZ(XU9JA)	GDS10278	Drive Shaft		25	24	54.8	79	595						
	1988.06-	1993.02	MT	R	F	Hatchback Engine DKZ(XU9JA)	GDS10024	Drive Shaft		25	24	54.8	79	867						
19 GTi (90 kW)	1986.07-	1993.02	MT		F	Hatchback Engine D6A(XU9J2)	GC010005	Outer Joint	90T	25	23	54.8	78.5	56	I					
	1986.07-	1993.02	MT	L	F	Hatchback Engine D6A(XU9J2)	GDS10090	Drive Shaft		25	24	54.8	78.5	593						
19 GTi 4x4 (88 kW)	1988.06-	1993.02	MT		F	Hatchback Engine DKZ(XU9JA)	GC010001	Outer Joint		25	22	54.8	79	48	I					
	1988.06-	1993.02	MT	L	F	Hatchback Engine DKZ(XU9JA)	GDS10278	Drive Shaft		25	24	54.8	79	595						
	1988.06-	1993.02	MT	R	F	Hatchback Engine DKZ(XU9JA)	GDS10024	Drive Shaft		25	24	54.8	79	867						
<b>BX BREAK (XB-)</b>																				
1.4 (47 kW)	1989.01-	1989.12	MT		F	Estate Engine K1H(TU3A)	GC010001	Outer Joint		25	22	54.8	79	48	I					
1.4 (55 kW)	1989.01-	1993.02	MT		F	Estate Engine KDY(TU3M)	GC010001	Outer Joint		25	22	54.8	79	48	I					
1.6 (53 kW)	1988.09-	1994.12	MT		F	Estate Engine B1E(XU51C)	GC010001	Outer Joint		25	22	54.8	79	48	I					
	1988.09-	1994.12	MT	L	F	Estate Engine B1E(XU51C)	GDS10278	Drive Shaft		25	24	54.8	79	595						
	1988.09-	1994.12	MT	R	F	Estate Engine B1E(XU51C)	GDS10024	Drive Shaft		25	24	54.8	79	867						
1.6 (59 kW)	1987.10-	1992.05	MT		F	Estate Engine B1E(XU51C)	GC010001	Outer Joint		25	22	54.8	79	48	I					
	1987.10-	1992.05	MT	L	F	Estate Engine B1E(XU51C)	GDS10278	Drive Shaft		25	24	54.8	79	595						
	1987.10-	1992.05	MT	R	F	Estate Engine B1E(XU51C)	GDS10024	Drive Shaft		25	24	54.8	79	867						
1.6 (64 kW)	1985.07-	1994.12	MT		F	Estate Engine 171D	GC010005	Outer Joint	90T	25	23	54.8	78.5	56	I					
	1985.07-	1994.12	MT		F	Estate Engine 171D	GC010001	Outer Joint		25	22	54.8	79	48	I					
	1985.07-	1994.12	MT	L	F	Estate Engine 171D	GDS10278	Drive Shaft		25	24	54.8	79	595						
	1985.07-	1994.12	MT	R	F	Estate Engine 171D	GDS10024	Drive Shaft		25	24	54.8	79	867						
1.6 (65 kW)	1989.05-	1994.12	MT		F	Estate Engine BDY(XU5M)/BDZ(XU5M)	GC010001	Outer Joint		25	22	54.8	79	48	I					
	1989.05-	1994.12	MT	L	F	Estate Engine BDY(XU5M)/BDZ(XU5M)	GDS10278	Drive Shaft		25	24	54.8	79	595						
	1989.05-	1994.12	MT	R	F	Estate Engine BDY(XU5M)/BDZ(XU5M)	GDS10024	Drive Shaft		25	24	54.8	79	867						
1.6 (66 kW)	1985.06-	1988.06	MT		F	Estate Engine 171A/171B/171C	GC010005	Outer Joint	90T	25	23	54.8	78.5	56	I					
	1985.06-	1988.06	MT		F	Estate Engine 171A/171B/171C	GC010001	Outer Joint		25	22	54.8	79	48	I					
	1985.06-	1988.06	MT	L	F	Estate Engine 171A/171B/171C	GDS10278	Drive Shaft		25	24	54.8	79	595						
	1985.06-	1988.06	MT	R	F	Estate Engine 171A/171B/171C	GDS10024	Drive Shaft		25	24	54.8	79	867						
1.6 (76 kW)	1986.03-	1994.12	MT		F	Estate Engine 180Z	GC010005	Outer Joint	90T	25	23	54.8	78.5	56	I					
	1986.03-	1994.12	MT		F	Estate Engine 180Z	GC010001	Outer Joint		25	22	54.8	79	48	I					
	1986.03-	1994.12	MT	L	F	Estate Engine 180Z	GDS10278	Drive Shaft		25	24	54.8	79	595						
	1986.03-	1994.12	MT	R	F	Estate Engine 180Z	GDS10024	Drive Shaft		25	24	54.8	79	867						
1.8 D (44 kW)	1985.10-	1993.09	MT		F	Estate Engine 161A(XUD7)	GC010001	Outer Joint		25	22	54.8	79	48	I					
	1985.10-	1993.09	MT	L	F	Estate Engine 161A(XUD7)	GDS10278	Drive Shaft		25	24	54.8	79	595						
	1985.10-	1993.09	MT	R	F	Estate Engine 161A(XUD7)	GDS10024	Drive Shaft		25	24	54.8	79	867						
1.8 TRD Turbo (66 kW)	1988.03-	1994.12	MT	L	F	Estate Engine A8A(XUD7TE)/AJZ(XUD7TE)	GDS10090	Drive Shaft		25	24	54.8	78.5	593						
1.9 (70 kW)	1987.12-	1989.12	MT		F	Estate Engine D2C(XU92C)	GC010001	Outer Joint		25	22	54.8	79	48	I					
	1987.12-	1989.12	MT	L	F	Estate Engine D2C(XU92C)	GDS10278	Drive Shaft		25	24	54.8	79	595						





		YEAR	TRANSM	L/R	F/R		G-AP Ref.	PRODUCT	ABS	Technical Specifications						
										A	B	C	H	L	P	
<b>CITROEN BX BREAK (XB-)</b>																
1.9 (70 kW)	1987.12-	1989.12	MT	R	F	Estate Engine D2C(XU92C)	GDS10024	Drive Shaft		25	24	54.8	79	867		
1.9 (75 kW)	1986.07-	1994.12	MT		F	Estate Engine D2A(XU92C)	GC010001	Outer Joint		25	22	54.8	79	48	I	
	1986.07-	1994.12	MT	L	F	Estate Engine D2A(XU92C)	GDS10278	Drive Shaft		25	24	54.8	79	595		
	1986.07-	1994.12	MT	R	F	Estate Engine D2A(XU92C)	GDS10024	Drive Shaft		25	24	54.8	79	867		
1.9 (80 kW)	1988.06-	1994.12	MT		F	Estate Engine DDZ(XU9M)	GC010001	Outer Joint		25	22	54.8	79	48	I	
	1988.06-	1994.12	MT	L	F	Estate Engine DDZ(XU9M)	GDS10278	Drive Shaft		25	24	54.8	79	595		
	1988.06-	1994.12	MT	R	F	Estate Engine DDZ(XU9M)	GDS10024	Drive Shaft		25	24	54.8	79	867		
1.9 (88 kW)	1988.06-	1994.12	MT		F	Estate Engine DKZ(XU9JA)	GC010001	Outer Joint		25	22	54.8	79	48	I	
	1988.06-	1994.12	MT	L	F	Estate Engine DKZ(XU9JA)	GDS10278	Drive Shaft		25	24	54.8	79	595		
	1988.06-	1994.12	MT	R	F	Estate Engine DKZ(XU9JA)	GDS10024	Drive Shaft		25	24	54.8	79	867		
1.9 4x4 (80 kW)	1990.10-	1991.05	MT		F	Estate Engine DDZ(XU9M)	GC010001	Outer Joint		25	22	54.8	79	48	I	
	1990.10-	1991.05	MT	L	F	Estate Engine DDZ(XU9M)	GDS10278	Drive Shaft		25	24	54.8	79	595		
	1990.10-	1991.05	MT	R	F	Estate Engine DDZ(XU9M)	GDS10024	Drive Shaft		25	24	54.8	79	867		
1.9 CAT (75 kW)	1986.07-	1994.12	MT		F	Estate Engine DFZ(XU9J1)	GC010001	Outer Joint		25	22	54.8	79	48	I	
	1986.07-	1994.12	MT	L	F	Estate Engine DFZ(XU9J1)	GDS10278	Drive Shaft		25	24	54.8	79	595		
	1986.07-	1994.12	MT	R	F	Estate Engine DFZ(XU9J1)	GDS10024	Drive Shaft		25	24	54.8	79	867		
1.9 D (47 kW)	1983.09-	1994.11		L	F	Estate Engine D9A(XUD9)/DJZ(XUD9Y)/162(XUD9)	GDS10117	Drive Shaft		25	24	54.8	79	592.5		
	1983.09-	1994.11	MT		F	Estate Engine D9A(XUD9)/DJZ(XUD9Y)/162(XUD9)	GC010005	Outer Joint	90T	25	23	54.8	78.5	56	I	
	1983.09-	1994.11	MT		F	Estate Engine D9A(XUD9)/DJZ(XUD9Y)/162(XUD9)	GC010001	Outer Joint		25	22	54.8	79	48	I	
	1983.09-	1994.11	MT	L	F	Estate Engine D9A(XUD9)/DJZ(XUD9Y)/162(XUD9)	GDS10278	Drive Shaft		25	24	54.8	79	595		
	1983.09-	1994.11	MT	R	F	Estate Engine D9A(XUD9)/DJZ(XUD9Y)/162(XUD9)	GDS10024	Drive Shaft		25	24	54.8	79	867		
1.9 D (51 kW)	1987.03-	1994.12	MT		F	Estate Engine D9B(XUD9A/U)	GC010001	Outer Joint		25	22	54.8	79	48	I	
	1987.03-	1994.12	MT	L	F	Estate Engine D9B(XUD9A/U)	GDS10278	Drive Shaft		25	24	54.8	79	595		
	1987.03-	1994.12	MT	R	F	Estate Engine D9B(XUD9A/U)	GDS10024	Drive Shaft		25	24	54.8	79	867		
<b>C-CROSSER (EP_)</b>																
2.2 HDi (115 kW)	2007.07-		MT	L	F	Closed Off-Road Vehicle Engine 4HN(DW12MTED4)	GDS51047	Drive Shaft		28	24	59.5	94.5	631		
	2007.07-		MT	L	F	Closed Off-Road Vehicle Engine 4HN(DW12MTED4)	GCI59140	Inner Joint		24	36	50	67	116		
	2007.07-		MT	L/R	F	Closed Off-Road Vehicle Engine 4HN(DW12MTED4)	GC039137	Outer Joint		28	37	59.5	94.5	71.5	I	
	2007.07-		MT	R	F	Closed Off-Road Vehicle Engine 4HN(DW12MTED4)	GDS51050	Drive Shaft		28	24	59.5	94.5	993		
	2007.07-		MT	R	F	Closed Off-Road Vehicle Engine 4HN(DW12MTED4)	GCI51021	Inner Joint		24	36	32	280.5	129		
<b>C1 (PM, PN)</b>																
1.0 (50 kW)	2002.06-						GCI59069	Inner Joint		23	19	34	60	101		
1.4 HDi (40 kW)	2005.06-						GCI59069	Inner Joint		23	19	34	60	101		
<b>C1 (PM_, PN_)</b>																
1.0 (50 kW)	2005.06-			L	F	Hatchback Engine 1KR-FE	GDS10232	Drive Shaft		24	23	49.5	91	650		
	2005.06-			R	F	Hatchback Engine 1KR-FE	GDS10231	Drive Shaft		24	23	49.5	91	841		
	2005.06-			L/R	F	Hatchback Engine 1KR-FE	GCI59069	Inner Joint		23	19	34	60	101		
	2005.06-			L/R	F	Hatchback Engine 1KR-FE	GC099128	Outer Joint		24	19	49.5	91	46	M	
1.4 HDi (40 kW)	2005.06-			L	F	Hatchback Engine DV4D	GDS59495	Drive Shaft		24	23	49.5	91	593		
	2005.06-			L	F	Hatchback Engine DV4D	GCI59069	Inner Joint		23	19	34	60	101		
	2005.06-			L/R	F	Hatchback Engine DV4D	GC045058	Outer Joint		24	20	49.5	91	46	M	
<b>C15</b>																
1.1 (44 kW)	1988.08-	1996.07	MT		F	Estate Engine HDZ(TU1M)	GC010009	Outer Joint		21	22	56	79	60	I	
1.4 (44 kW)	1987.05-	1992.10	MT		F	Estate Engine 150D(XY7)	GC010009	Outer Joint		21	22	56	79	60	I	
1.4 (49 kW)	1987.05-	1992.09	MT		F	Estate	GC010009	Outer Joint		21	22	56	79	60	I	
1.4 (55 kW)	1991.05-	1996.07	MT		F	Estate Engine KDY(TU3M)	GC010009	Outer Joint		21	22	56	79	60	I	
1.8 D (44 kW)	1987.04-	2000.08	MT		F	Estate Engine 161A(XUD7)	GC010017	Outer Joint		21	31	56	77	59	I	
<b>C15 (VD-)</b>																
1.0 (33 kW)	1984.10-	1997.12			F	Box Engine TU9/XV8	GC010048	Outer Joint		21	22	56	76	58	I	
	1984.10-	1997.12	MT	L	F	Box Engine TU9/XV8	GDS10010	Drive Shaft		21	22	54	76	572		
	1984.10-	1997.12	MT	R	F	Box Engine TU9/XV8	GDS10044	Drive Shaft		21	22	56.4	76	832.5		
	1984.10-	1997.12	MT	L/R	F	Box Engine TU9/XV8	GDS10130	Drive Shaft		21	22	54	90	683		
	1984.10-	1997.12	MT		F	Box Engine TU9/XV8	GC010009	Outer Joint		21	22	56	79	60	I	
1.1 (35 kW)	1984.10-	1996.12			F	Box Engine 109K/E1A	GC010048	Outer Joint		21	22	56	76	58	I	
	1984.10-	1996.12	MT	L/R	F	Box Engine 109K/E1A	GDS10130	Drive Shaft		21	22	54	90	683		
	1984.10-	1996.12	MT		F	Box Engine 109K/E1A	GC010009	Outer Joint		21	22	56	79	60	I	
1.1 i (44 kW)	1988.07-	1996.12	MT	L	F	Box Engine HDZ(TU1M)	GDS10010	Drive Shaft		21	22	54	76	572		
	1988.07-	1996.12	MT	R	F	Box Engine HDZ(TU1M)	GDS10044	Drive Shaft		21	22	56.4	76	832.5		
	1988.07-	1996.12	MT		F	Box Engine HDZ(TU1M)	GC010009	Outer Joint		21	22	56	79	60	I	
1.3 (47 kW)	1987.07-	1988.05			F	Box Engine G1A	GC010048	Outer Joint		21	22	56	76	58	I	
	1987.07-	1988.05	MT		F	Box Engine G1A	GC010009	Outer Joint		21	22	56	79	60	I	



		TRANSM	L/R	F/R		G-AP Ref.	PRODUCT	ABS	Technical Specifications										
									YEAR	A	B	C	H	L	P				
<b>CITROEN</b>																			
<b>C15 (VD_)</b>																			
1.4 (49 kW)	1987.07-1996.12	MT	L	F	Box Engine K1H(TU3A)	GDS10010	Drive Shaft		21	22	54	76	572						
	1987.07-1996.12	MT	R	F	Box Engine K1H(TU3A)	GDS10044	Drive Shaft		21	22	56.4	76	832.5						
	1987.07-1996.12	MT	L/R	F	Box Engine K1H(TU3A)	GDS10130	Drive Shaft		21	22	54	90	683						
	1987.07-1996.12	MT		F	Box Engine K1H(TU3A)	GC010009	Outer Joint		21	22	56	79	60	I					
1.4 E (44 kW)	1987.05-1996.12			F	Box Engine 150D(XY7)	GC010048	Outer Joint		21	22	56	76	58	I					
	1987.05-1996.12	MT	L	F	Box Engine 150D(XY7)	GDS10010	Drive Shaft		21	22	54	76	572						
	1987.05-1996.12	MT	R	F	Box Engine 150D(XY7)	GDS10044	Drive Shaft		21	22	56.4	76	832.5						
	1987.05-1996.12	MT	L/R	F	Box Engine 150D(XY7)	GDS10130	Drive Shaft		21	22	54	90	683						
	1987.05-1996.12	MT		F	Box Engine 150D(XY7)	GC010009	Outer Joint		21	22	56	79	60	I					
1.4 i (55 kW)	1991.05-1996.12	MT	L	F	Box Engine KDY(TU3FM)/KDY(TU3M)	GDS10010	Drive Shaft		21	22	54	76	572						
	1991.05-1996.12	MT	R	F	Box Engine KDY(TU3FM)/KDY(TU3M)	GDS10044	Drive Shaft		21	22	56.4	76	832.5						
	1991.05-1996.12	MT		F	Box Engine KDY(TU3FM)/KDY(TU3M)	GC010009	Outer Joint		21	22	56	79	60	I					
1.8 D (44 kW)	1986.07-2000.12			F	Box Engine 161A(XUD7)	GC010048	Outer Joint		21	22	56	76	58	I					
	1986.07-2000.12	MT		F	Box Engine 161A(XUD7)	GC010017	Outer Joint		21	31	56	77	59	I					
1.9 D (44 kW)	2000.12-2005.12	MT	L	F	Box Engine WJX(DW8B)	GDS10039	Drive Shaft		21	24	56.4	76	567						
	2000.12-2005.12			R	Box Engine WJX(DW8B)	GDS10087	Drive Shaft		21	24	56	79	851.5						
	2000.12-2005.12	MT	R	F	Box Engine WJX(DW8B)	GDS10007	Drive Shaft		21	24	48	75.5	845						
<b>C2 (JM_)</b>																			
1.1 (44 kW)	2003.09-			F	Hatchback Engine HFX(TU1JP)	GC010053	Outer Joint		21	20	49	86	51	M					
	2003.09-			L	Hatchback Engine HFX(TU1JP)	GDS10030	Drive Shaft		21	22	48	86.5	643						
	2003.09-			R	Hatchback Engine HFX(TU1JP)	GDS10031	Drive Shaft		21	22	48	86.5	841						
1.4 (54 kW)	2003.09-			F	Hatchback Engine KFV(TU3JP)	GC010053	Outer Joint		21	20	49	86	51	M					
	2003.09-	AT	L	F	Hatchback Engine KFV(TU3JP)	GDS10181	Drive Shaft		21	26	48.5	86	618						
	2003.09-	MT	L	F	Hatchback Engine KFV(TU3JP)	GDS10030	Drive Shaft		21	22	48	86.5	643						
	2003.09-	AT	R	F	Hatchback Engine KFV(TU3JP)	GDS10206	Drive Shaft		21	26	48.5	86	754						
	2003.09-	MT	R	F	Hatchback Engine KFV(TU3JP)	GDS10031	Drive Shaft		21	22	48	86.5	841						
	2003.09-			F	Hatchback Engine TU3JP	GC010053	Outer Joint		21	20	49	86	51	M					
1.4 (55 kW)	2006.10-			F	Hatchback Engine TU3JP	GC010053	Outer Joint		21	20	49	86	51	M					
1.4 16V (65 kW)	2005.12-			F	Hatchback Engine KFU(ET3J4)	GC010053	Outer Joint		21	20	49	86	51	M					
	2005.12-			L	Hatchback Engine KFU(ET3J4)	GDS10146	Drive Shaft		21	22	48	86.5	642						
	2005.12-			R	Hatchback Engine KFU(ET3J4)	GDS10144	Drive Shaft		21	22	48	86.5	843						
1.4 HDi (50 kW)	2003.09-			L	Hatchback Engine 8HX(DV4TD)	GDS10147	Drive Shaft		21	24	48	86.5	633						
	2003.09-			L	Hatchback Engine 8HX(DV4TD)	GDS10276	Drive Shaft		21	22	48	86.5	643						
	2003.09-			R	Hatchback Engine 8HX(DV4TD)	GDS45103	Drive Shaft		21	24	48	86.5	854						
	2003.09-			R	Hatchback Engine 8HX(DV4TD)	GDS10259	Drive Shaft		21	22	48.5	86	849						
	2003.09-			F	Hatchback Engine NFU(TU5JP4)	GC045057	Outer Joint		21	22	48	86.5	54	I					
1.6 (80 kW)	2003.09-			L	Hatchback Engine NFU(TU5JP4)	GDS10241	Drive Shaft		21	22	48	86.5	642						
	2003.09-			R	Hatchback Engine NFU(TU5JP4)	GDS10242	Drive Shaft		21	22	48	86.5	844						
	2003.09-			F	Hatchback Engine NFU(TU5JP4)	GDS10242	Drive Shaft		21	22	48	86.5	844						
1.6 HDi (80 kW)	2005.09-			L	Hatchback Engine 9HZ-DV6TED4	GDS10364	Drive Shaft		21	24	50	85	631						
	2005.09-			L	Hatchback Engine 9HZ-DV6TED4	GCI10092	Inner Joint		24	22	40	69	86						
	2005.09-			L	Hatchback Engine 9HZ-DV6TED4	GC099301	Outer Joint		21	22	50	85	53	I					
	2005.09-	MT	R	F	Hatchback Engine 9HZ-DV6TED4	GDS10288	Drive Shaft		21	24	48	86.5	858						
1.6 VTS (90 kW)	2005.10-2008.03			F	Hatchback Engine NFS(TU5JP4S)	GC010077	Outer Joint		21	28	49	86	56.5	O					
	2005.10-2008.03			L	Hatchback Engine NFS(TU5JP4S)	GDS10146	Drive Shaft		21	22	48	86.5	642						
	2005.10-2008.03			R	Hatchback Engine NFS(TU5JP4S)	GDS10144	Drive Shaft		21	22	48	86.5	843						
	2005.10-2008.03	MT			Hatchback Engine NFS(TU5JP4S)	GC010069	Outer Joint		21	21	48	86.5	54	I					
<b>C25</b>																			
-						GC010104	Outer Joint	54T	28	27	63	112.5	63	I					
<b>C25 (280_, 290_)</b>																			
1.8 (50 kW)	1981.11-1994.01			F	Box Engine 169(XM7T)	GC010010	Outer Joint		28	27	63	112.5	63	I					
	1981.11-1994.01			F	Bus Engine 169(XM7T)	GC010010	Outer Joint		28	27	63	112.5	63	I					
1.8 E (51 kW)	1987.07-1994.02	MT	R	F	Bus Engine 169(XM7T)	GDS10068	Drive Shaft		28	25	63	112.5	1068						
	1987.07-1994.02			F	Bus Engine 169(XM7T)	GC010010	Outer Joint		28	27	63	112.5	63	I					
	1987.07-1994.02	MT	L	F	Bus Engine 169(XM7T)	GDS10034	Drive Shaft		28	25	63	112.5	701						
1.9 D (51 kW)	1987.07-1994.02	MT	R	F	Bus Engine D9B(XUD9A/U)	GDS10068	Drive Shaft		28	25	63	112.5	1068						
	1987.07-1994.02			R	Bus Engine D9B(XUD9A/U)	GDS10013	Drive Shaft		28	25	63	112.5	1072						
	1987.07-1994.02	MT	L	F	Bus Engine D9B(XUD9A/U)	GDS10034	Drive Shaft		28	25	63	112.5	701						
1.9 TD (60 kW)	1992.04-1994.02			F	Bus Engine M705	GC010010	Outer Joint		28	27	63	112.5	63	I					
	1992.04-1994.02			R	Bus Engine M705	GDS10013	Drive Shaft		28	25	63	112.5	1072						
2.0 (57 kW)	1981.11-1986.12			F	Platform/Chassis	GC010010	Outer Joint		28	27	63	112.5	63	I					
2.0 (62 kW)	1987.01-1994.03	MT	R	F	Platform/Chassis Engine 170C(XN1T)	GDS10068	Drive Shaft		28	25	63	112.5	1068						
	1987.01-1994.03			F	Platform/Chassis Engine 170C(XN1T)	GC010010	Outer Joint		28	27	63	112.5	63	I					
	1987.01-1994.03	MT	L	F	Platform/Chassis Engine 170C(XN1T)	GDS10034	Drive Shaft		28	25	63	112.5	701						





		TRANSM	L/R	F/R		G-AP Ref.	PRODUCT	ABS	Technical Specifications									
									YEAR	A	B	C	H	L	P			
<b>CITROEN</b> <b>C25 (280_, 290_)</b>																		
2.0 (62 kW)	1991.02-1994.02	MT	R	F	Bus Engine 170C(XN1T)	GDS10068	Drive Shaft		28	25	63	112.5	1068					
	1991.02-1994.03	MT	R	F	Box Engine 170C(XN1T)	GDS10068	Drive Shaft		28	25	63	112.5	1068					
	1991.02-1994.02			F	Bus Engine 170C(XN1T)	GC010010	Outer Joint		28	27	63	112.5	63	I				
	1991.02-1994.03			F	Box Engine 170C(XN1T)	GC010010	Outer Joint		28	27	63	112.5	63	I				
	1991.02-1994.02	MT	L	F	Bus Engine 170C(XN1T)	GDS10034	Drive Shaft		28	25	63	112.5	701					
	1991.02-1994.03	MT	L	F	Box Engine 170C(XN1T)	GDS10034	Drive Shaft		28	25	63	112.5	701					
2.0 E (58 kW)	1981.09-1994.02	MT	R	F	Bus Engine 170A(XN1T)/170B(XN1T)	GDS10068	Drive Shaft		28	25	63	112.5	1068					
	1981.09-1994.03	MT	R	F	Box Engine 170A(XN1T)/170B(XN1T)	GDS10068	Drive Shaft		28	25	63	112.5	1068					
	1981.09-1994.02			F	Bus Engine 170A(XN1T)/170B(XN1T)	GC010010	Outer Joint		28	27	63	112.5	63	I				
	1981.09-1994.03			F	Box Engine 170A(XN1T)/170B(XN1T)	GC010010	Outer Joint		28	27	63	112.5	63	I				
	1981.09-1994.02	MT	L	F	Bus Engine 170A(XN1T)/170B(XN1T)	GDS10034	Drive Shaft		28	25	63	112.5	701					
	1981.09-1994.03	MT	L	F	Box Engine 170A(XN1T)/170B(XN1T)	GDS10034	Drive Shaft		28	25	63	112.5	701					
2.5 D (54 kW)	1985.10-1994.02	MT	R	F	Bus Engine CRD93L(U25-661)	GDS10068	Drive Shaft		28	25	63	112.5	1068					
	1985.10-1994.02			F	Bus Engine CRD93L(U25-661)	GC010010	Outer Joint		28	27	63	112.5	63	I				
	1985.10-1994.02	MT	L	F	Bus Engine CRD93L(U25-661)	GDS10034	Drive Shaft		28	25	63	112.5	701					
2.5 D (55 kW)	1981.11-1994.01			F	Box Engine CRD93L(U25-661)	GC010010	Outer Joint		28	27	63	112.5	63	I				
	1981.11-1994.01			F	Bus	GC010010	Outer Joint		28	27	63	112.5	63	I				
	1983.11-1994.01			F	Platform/Chassis Engine CRD93L(U25-661)	GC010010	Outer Joint		28	27	63	112.5	63	I				
2.5 D 4x4 (54 kW)	1987.01-1994.02			Bus Engine CRD93L(U25-661)	GC010010	Outer Joint		28	27	63	112.5	63	I					
2.5 D 4x4 (55 kW)	1983.11-1986.12			Box	GC010010	Outer Joint		28	27	63	112.5	63	I					
2.5 D Turbo (70 kW)	1987.08-1994.02	MT	R	F	Bus Engine CRD93LS(U25-673)	GDS10068	Drive Shaft		28	25	63	112.5	1068					
	1987.08-1994.02			F	Bus Engine CRD93LS(U25-673)	GC010010	Outer Joint		28	27	63	112.5	63	I				
	1987.08-1994.02	MT	L	F	Bus Engine CRD93LS(U25-673)	GDS10034	Drive Shaft		28	25	63	112.5	701					
2.5 D Turbo 4x4 (70 kW)	1987.08-1994.02	MT	R	F	Bus Engine CRD93LS(U25-673)	GDS10068	Drive Shaft		28	25	63	112.5	1068					
	1987.08-1994.02				Bus Engine CRD93LS(U25-673)	GC010010	Outer Joint		28	27	63	112.5	63	I				
	1987.08-1994.02	MT	L		Bus Engine CRD93LS(U25-673)	GDS10034	Drive Shaft		28	25	63	112.5	701					
2.5 DT (70 kW)	1987.01-1994.01			F	Platform/Chassis Engine CRD93LS(U25-673)	GC010010	Outer Joint		28	27	63	112.5	63	I				
	1991.08-1994.01			F	Box Engine CRD93LS(U25-673)	GC010010	Outer Joint		28	27	63	112.5	63	I				
2.5 DT 4x4 (70 kW)	1991.08-1994.01				Box Engine CRD93LS(U25-673)	GC010010	Outer Joint		28	27	63	112.5	63	I				
<b>C3 I (FC_)</b>																		
1.1 i (44 kW)	2002.02-			F	Hatchback Engine HFX(TU1JP)	GC010026	Outer Joint		21	21	48	86.5	54	I				
	2002.02-		L	F	Hatchback Engine HFX(TU1JP)	GDS10030	Drive Shaft		21	22	48	86.5	643					
	2002.02-		R	F	Hatchback Engine HFX(TU1JP)	GDS10031	Drive Shaft		21	22	48	86.5	841					
1.4 16V (65 kW)	2004.01-2006.09			F	Hatchback Engine KFV(ET3J4)	GC045057	Outer Joint		21	22	48	86.5	54	I				
	2004.01-2006.09		L	F	Hatchback Engine KFV(ET3J4)	GDS10146	Drive Shaft		21	22	48	86.5	642					
	2004.01-2006.09		R	F	Hatchback Engine KFV(ET3J4)	GDS10144	Drive Shaft		21	22	48	86.5	843					
	2004.01-2006.09				Hatchback Engine KFV(ET3J4)	GC010069	Outer Joint		21	21	48	86.5	54	I				
1.4 16V HDi (66 kW)	2002.02-			F	Hatchback Engine 8HY(DV4TED4)	GC045057	Outer Joint		21	22	48	86.5	54	I				
	2002.02-			F	Hatchback Engine 8HY(DV4TED4)	GC010026	Outer Joint		21	21	48	86.5	54	I				
	2002.02-		L	F	Hatchback Engine 8HY(DV4TED4)	GDS10001	Drive Shaft		21	22	48	86.5	636					
	2002.02-		L	F	Hatchback Engine 8HY(DV4TED4)	GDS10147	Drive Shaft		21	24	48	86.5	633					
	2002.02-		R	F	Hatchback Engine 8HY(DV4TED4)	GDS10002	Drive Shaft		21	22	48	86.5	852					
	2002.02-		R	F	Hatchback Engine 8HY(DV4TED4)	GDS45103	Drive Shaft		21	24	48	86.5	854					
	2002.02-		MT	R	F	Hatchback Engine 8HY(DV4TED4)	GDS10288	Drive Shaft		21	24	48	86.5	858				
1.4 HDi (50 kW)	2002.02-			F	Hatchback Engine 8HX(DV4TD)	GC010026	Outer Joint		21	21	48	86.5	54	I				
	2002.02-		L	F	Hatchback Engine 8HX(DV4TD)	GDS10001	Drive Shaft		21	22	48	86.5	636					
	2002.02-		L	F	Hatchback Engine 8HX(DV4TD)	GDS10147	Drive Shaft		21	24	48	86.5	633					
	2002.02-		L	F	Hatchback Engine 8HX(DV4TD)	GDS10276	Drive Shaft		21	22	48	86.5	643					
	2002.02-		R	F	Hatchback Engine 8HX(DV4TD)	GDS10002	Drive Shaft		21	22	48	86.5	852					
	2002.02-		R	F	Hatchback Engine 8HX(DV4TD)	GDS45103	Drive Shaft		21	24	48	86.5	854					
	2002.02-		R	F	Hatchback Engine 8HX(DV4TD)	GDS10259	Drive Shaft		21	22	48.5	86	849					
	2002.02-		L	F	Hatchback Engine 8HX(DV4TD)	GDS10419	Drive Shaft		21	22	48.5	86	643					
	2002.02-		L	F	Hatchback Engine 8HX(DV4TD)	GDS10420	Drive Shaft		21	22	48	86.5	637					
1.4 i (54 kW)	2008.01-	MT/AT		F	Hatchback Engine KFV(TU3JP)/KFV(TU3A)	GC010026	Outer Joint		21	21	48	86.5	54	I				
	2008.01-	AT	L	F	Hatchback Engine KFV(TU3JP)/KFV(TU3A)	GDS10181	Drive Shaft		21	26	48.5	86	618					
	2008.01-	MT	L	F	Hatchback Engine KFV(TU3JP)/KFV(TU3A)	GDS10030	Drive Shaft		21	22	48	86.5	643					
	2008.01-		R	F	Hatchback Engine KFV(TU3JP)/KFV(TU3A)	GDS10031	Drive Shaft		21	22	48	86.5	841					
	2008.01-	AT	R	F	Hatchback Engine KFV(TU3JP)/KFV(TU3A)	GDS10206	Drive Shaft		21	26	48.5	86	754					
1.4 i Bivalent (54 kW)	2002.02-	MT/AT		F	Hatchback Engine KFV(TU3JP)	GC010026	Outer Joint		21	21	48	86.5	54	I				
	2002.02-	AT	L	F	Hatchback Engine KFV(TU3JP)	GDS10181	Drive Shaft		21	26	48.5	86	618					
	2002.02-	MT	L	F	Hatchback Engine KFV(TU3JP)	GDS10030	Drive Shaft		21	22	48	86.5	643					
	2002.02-	AT	R	F	Hatchback Engine KFV(TU3JP)	GDS10206	Drive Shaft		21	26	48.5	86	754					









		TRANSM	L/R	F/R		G-AP Ref.	PRODUCT	ABS	Technical Specifications								
									YEAR	A	B	C	H	L	P		
<b>CITROEN</b>																	
<b>C3 I (FC_)</b>																	
1.4 i Bivalent (54 kW)	2002.02-		MT	R	F	Hatchback Engine KFV(TU3JP)	GDS10031	Drive Shaft		21	22	48	86.5	841			
1.6 16V (80 kW)	2002.02-				F	Hatchback Engine NFU(TU5JP4)	GC045057	Outer Joint		21	22	48	86.5	54	I		
	2002.02-			L	F	Hatchback Engine NFU(TU5JP4)	GDS10241	Drive Shaft		21	22	48	86.5	642			
	2002.02-			R	F	Hatchback Engine NFU(TU5JP4)	GDS10144	Drive Shaft		21	22	48	86.5	843			
	2002.02-			R	F	Hatchback Engine NFU(TU5JP4)	GDS10242	Drive Shaft		21	22	48	86.5	844			
	2002.02-					Hatchback Engine NFU(TU5JP4)	GC010069	Outer Joint		21	21	48	86.5	54	I		
1.6 16V (81 kW)	2003.5-	2005.9			Hatchback Engine NFU(TU5JP4)	GC010069	Outer Joint		21	21	48	86.5	54	I			
1.6 16V HDi (66 kW)	2005.05-	2008.03			F	Hatchback Engine 9HX(DV6ATED4)	GC045057	Outer Joint		21	22	48	86.5	54	I		
	2005.05-	2008.03		L	F	Hatchback Engine 9HX(DV6ATED4)	GDS10147	Drive Shaft		21	24	48	86.5	633			
	2005.05-	2008.03		L	F	Hatchback Engine 9HX(DV6ATED4)	GDS10364	Drive Shaft		21	24	50	85	631			
	2005.05-	2008.03		L	F	Hatchback Engine 9HX(DV6ATED4)	GCI10092	Inner Joint		24	22	40	69	86			
	2005.05-	2008.03		L	F	Hatchback Engine 9HX(DV6ATED4)	GC099301	Outer Joint		21	22	50	85	53	I		
	2005.05-	2008.03		R	F	Hatchback Engine 9HX(DV6ATED4)	GDS45103	Drive Shaft		21	24	48	86.5	854			
	2005.05-	2008.03	MT	R	F	Hatchback Engine 9HX(DV6ATED4)	GDS10288	Drive Shaft		21	24	48	86.5	858			
1.6 16V HDi (80 kW)	2005.05-	2008.03				Hatchback Engine 9HX(DV6ATED4)	GC010069	Outer Joint		21	21	48	86.5	54	I		
	2005.10-	2008.03			F	Hatchback Engine DV6TED4	GC045057	Outer Joint		21	22	48	86.5	54	I		
	2005.10-	2008.03		L	F	Hatchback Engine DV6TED4	GDS10364	Drive Shaft		21	24	50	85	631			
	2005.10-	2008.03		L	F	Hatchback Engine DV6TED4	GCI10092	Inner Joint		24	22	40	69	86			
	2005.10-	2008.03	MT	R	F	Hatchback Engine DV6TED4	GDS10288	Drive Shaft		21	24	48	86.5	858			
2005.10-	2008.03				Hatchback Engine DV6TED4	GC010069	Outer Joint		21	21	48	86.5	54	I			
<b>C3 II</b>																	
1.0 VTi (50 kW)	2012.08-					Hatchback	GC099366	Outer Joint		25	34	58.5	79	55	I		
1.2 VTi (60 kW)	2012.06-					Hatchback	GC099366	Outer Joint		25	34	58.5	79	55	I		
1.4 HDi (50 kW)	2009.11-			L	F	Hatchback Engine 8HR(DV4C)/8HZ(DV4TD)	GDS10311	Drive Shaft		21	22	48	86.5	647			
	2009.11-			R	F	Hatchback Engine 8HR(DV4C)/8HZ(DV4TD)	GDS99271	Drive Shaft		21	22	48	86.5	858			
1.4 VTi (70 kW)	2009.11-			L	F	Hatchback Engine 8FP(EP3)	GDS10311	Drive Shaft		21	22	48	86.5	647			
	2009.11-			R	F	Hatchback Engine 8FP(EP3)	GDS99271	Drive Shaft		21	22	48	86.5	858			
1.6 HDi (66 kW)	2009.11-		MT	L	F	Hatchback Engine 9HX(DV6ATED4)	GDS10309	Drive Shaft		21	24	48.3	86.5	641			
1.6 HDi (68 kW)	2009.11-		MT	L	F	Hatchback Engine 9HP(DV6DTE4)	GDS10309	Drive Shaft		21	24	48.3	86.5	641			
1.6 HDi (82 kW)	2009.11-			L	F	Hatchback Engine 9HR(DV6C)	GDS10253	Drive Shaft		25	24	58.5	79	626			
	2009.11-			L	F	Hatchback Engine 9HR(DV6C)	GCI10057	Inner Joint		24	34	40	52.5	90			
	2009.11-			L	F	Hatchback Engine 9HR(DV6C)	GC010148	Outer Joint		25	34	58.5	79	55.5	I		
1.6 HDi (84 kW)	2012.09-		MT	L	F	Hatchback	GDS10253	Drive Shaft		25	24	58.5	79	626			
	2012.09-		MT	L	F	Hatchback	GCI10057	Inner Joint		24	34	40	52.5	90			
	2012.09-		MT	L	F	Hatchback	GC010148	Outer Joint		25	34	58.5	79	55.5	I		
1.6 VTi (88 kW)	2009.11-				Hatchback Engine 5FS(EP6C)	GC010097	Outer Joint		25	30	58.5	79.5	55	I			
<b>C3 PICASSO</b>																	
1.4 VTi (70 kW)	2009.02-					MPV Engine 8FS(EP3)	GC010156	Outer Joint		25	22	58.5	78.5	55	I		
1.6 HDi (66 kW)	2009.02-				F	MPV Engine 9HX(DV6ATED4)	GC010067	Outer Joint	48W	25	34	58.5	79	55	I		
	2009.02-		MT	L	F	MPV Engine 9HX(DV6ATED4)	GDS10250	Drive Shaft		25	24	58.5	79	634			
	2009.02-		MT	R	F	MPV Engine 9HX(DV6ATED4)	GDS10249	Drive Shaft		25	24	58.5	79	864			
1.6 HDi (80 kW)	2009.02-				F	MPV Engine 9HZ(DV6ATED4)	GC010067	Outer Joint	48W	25	34	58.5	79	55	I		
	2009.02-		MT	L	F	MPV Engine 9HZ(DV6ATED4)	GDS10250	Drive Shaft		25	24	58.5	79	634			
	2009.02-		MT	R	F	MPV Engine 9HZ(DV6ATED4)	GDS10249	Drive Shaft		25	24	58.5	79	864			
1.6 HDi (82 kW)	2010.05-			L	F	MPV Engine 9HR(DV6C)	GDS10253	Drive Shaft		25	24	58.5	79	626			
	2010.05-			L	F	MPV Engine 9HR(DV6C)	GCI10057	Inner Joint		24	34	40	52.5	90			
	2010.05-			L	F	MPV Engine 9HR(DV6C)	GC010148	Outer Joint		25	34	58.5	79	55.5	I		
	2010.05-		MT	R	F	MPV Engine 9HR(DV6C)	GDS10249	Drive Shaft		25	24	58.5	79	864			
1.6 HDi (84 kW)	2013.01-		MT	L	F	MPV Engine 9HL(DV6C)	GDS10253	Drive Shaft		25	24	58.5	79	626			
	2013.01-		MT	L	F	MPV Engine 9HL(DV6C)	GCI10057	Inner Joint		24	34	40	52.5	90			
	2013.01-		MT	L	F	MPV Engine 9HL(DV6C)	GC010148	Outer Joint		25	34	58.5	79	55.5	I		
	2013.01-		MT	R	F	MPV Engine 9HL(DV6C)	GDS10249	Drive Shaft		25	24	58.5	79	864			
1.6 VTi (88 kW)	2009.02-				MPV Engine 5FS(EP6C)/5FW(EP6)	GC010156	Outer Joint		25	22	58.5	78.5	55	I			
<b>C3 PLURIEL (HB_)</b>																	
1.4 (54 kW)	2003.05-				F	Convertible Engine KFV(TU3JP)	GC010077	Outer Joint		21	28	49	86	56.5	O		
	2003.05-		MT/AT		F	Convertible Engine KFV(TU3JP)	GC010026	Outer Joint		21	21	48	86.5	54	I		
	2003.05-		AT	L	F	Convertible Engine KFV(TU3JP)	GDS10181	Drive Shaft		21	26	48.5	86	618			
	2003.05-		MT	L	F	Convertible Engine KFV(TU3JP)	GDS10030	Drive Shaft		21	22	48	86.5	643			
	2003.05-		AT	R	F	Convertible Engine KFV(TU3JP)	GDS10206	Drive Shaft		21	26	48.5	86	754			
	2003.05-		MT	R	F	Convertible Engine KFV(TU3JP)	GDS10031	Drive Shaft		21	22	48	86.5	841			

		TRANSM	L/R	F/R		G-AP Ref.	PRODUCT	ABS	Technical Specifications								
									YEAR	A	B	C	H	L	P		
<b>CITROEN</b>																	
<b>C3 PLURIEL (HB_)</b>																	
1.4 HDi (50 kW)	2005.10-2006.11			F	Convertible Engine 8HX(DV4TD)	GC045057	Outer Joint		21	22	48	86.5	54	I			
	2005.10-2006.11			F	Convertible Engine 8HX(DV4TD)	GC010026	Outer Joint		21	21	48	86.5	54	I			
	2005.10-2006.11		L	F	Convertible Engine 8HX(DV4TD)	GDS10147	Drive Shaft		21	24	48	86.5	633				
	2005.10-2006.11		L	F	Convertible Engine 8HX(DV4TD)	GDS10276	Drive Shaft		21	22	48	86.5	643				
	2005.10-2006.11		L	F	Convertible Engine 8HX(DV4TD)	GDS10420	Drive Shaft		21	22	48	86.5	637				
	2005.10-2006.11		R	F	Convertible Engine 8HX(DV4TD)	GDS45103	Drive Shaft		21	24	48	86.5	854				
	2005.10-2006.11		R	F	Convertible Engine 8HX(DV4TD)	GDS10259	Drive Shaft		21	22	48.5	86	849				
1.4 HybriD (54 kW)	2006.01-2008.04			F	Convertible Engine KFV(TU3JP)	GC010077	Outer Joint		21	28	49	86	56.5	O			
1.6 (80 kW)	2003.05-			F	Convertible Engine NFU(TU5JP4)	GC045057	Outer Joint		21	22	48	86.5	54	I			
	2003.05-		L	F	Convertible Engine NFU(TU5JP4)	GDS10241	Drive Shaft		21	22	48	86.5	642				
	2003.05-		R	F	Convertible Engine NFU(TU5JP4)	GDS10144	Drive Shaft		21	22	48	86.5	843				
	2003.05-		R	F	Convertible Engine NFU(TU5JP4)	GDS10242	Drive Shaft		21	22	48	86.5	844				
	2003.05-				Convertible Engine NFU(TU5JP4)	GC010069	Outer Joint		21	21	48	86.5	54	I			
<b>C4</b>																	
1.6 16V (80 kW)	2006.07-			F	Saloon Engine NFU(TU5JP4)	GC010025	Outer Joint		25	22	60	80	54	I			
	2006.07-		AT	L	Saloon Engine NFU(TU5JP4)	GDS10286	Drive Shaft		25	26	58.5	79	613				
	2006.07-		MT	L	Saloon Engine NFU(TU5JP4)	GDS99019	Drive Shaft	29T	25	24	55.7	79	620				
	2006.07-		AT	R	Saloon Engine NFU(TU5JP4)	GDS10291	Drive Shaft		25	26	58.5	79	833				
	2006.07-		MT	R	Saloon Engine NFU(TU5JP4)	GDS10229	Drive Shaft		25	24	58.5	79	935				
1.6 HDi (80 kW)	2006.07-			F	Saloon Engine DV6TED4	GC010028	Outer Joint		25	34	58	89	56	I			
	2006.07-		MT	L	Saloon Engine DV6TED4	GDS99019	Drive Shaft	29T	25	24	55.7	79	620				
	2006.07-		MT	R	Saloon Engine DV6TED4	GDS10229	Drive Shaft		25	24	58.5	79	935				
2.0 16V (103 kW)	2006.07-			F	Saloon Engine RFJ(EW10A)	GC010028	Outer Joint		25	34	58	89	56	I			
2.0 Flex (103 kW)	2006.07-		AT	L	Saloon Engine RFJ(EW10A)	GDS61304	Drive Shaft		36		59.5	40	511				
<b>C4 (LA_)</b>																	
1.4 16V (65 kW)	2004.11-			F	Coupe Engine KFU(ET3J4)	GC010025	Outer Joint		25	22	60	80	54	I			
	2004.11-		AT	L	Coupe Engine KFU(ET3J4)	GDS10255	Drive Shaft		25	24	58.5	79	616				
	2004.11-		MT	L	Coupe Engine KFU(ET3J4)	GDS45119	Drive Shaft		25	22	58.5	79.5	633				
	2004.11-		MT	L	Coupe Engine KFU(ET3J4)	GDS45126	Drive Shaft		25	24	58.5	89	630				
	2004.11-		AT	R	Coupe Engine KFU(ET3J4)	GDS10254	Drive Shaft		25	24	58.5	79	939				
	2004.11-		MT	R	Coupe Engine KFU(ET3J4)	GDS45113	Drive Shaft		25	22	58.5	79.5	915				
	2004.11-		MT	R	Coupe Engine KFU(ET3J4)	GDS45104	Drive Shaft		25	24	58	79	925				
	2004.11-		MT	R	Coupe Engine KFU(ET3J4)	GDS99170	Drive Shaft		25	22	60	80	910				
	2004.11-				Coupe Engine KFU(ET3J4)	GC010097	Outer Joint		25	30	58.5	79.5	55	I			
1.6 16V (80 kW)	2004.11-			F	Coupe Engine NFU(TU5JP4)	GC010025	Outer Joint		25	22	60	80	54	I			
	2004.11-		MT	L	Coupe Engine NFU(TU5JP4)	GDS45119	Drive Shaft		25	22	58.5	79.5	633				
	2004.11-		MT	L	Coupe Engine NFU(TU5JP4)	GDS45126	Drive Shaft		25	24	58.5	89	630				
	2004.11-		MT	R	Coupe Engine NFU(TU5JP4)	GDS45113	Drive Shaft		25	22	58.5	79.5	915				
	2004.11-		MT	R	Coupe Engine NFU(TU5JP4)	GDS45104	Drive Shaft		25	24	58	79	925				
	2004.11-		AT	L	Coupe Engine NFU(TU5JP4)	GDS10286	Drive Shaft		25	26	58.5	79	613				
	2004.11-		MT	L	Coupe Engine NFU(TU5JP4)	GDS99019	Drive Shaft	29T	25	24	55.7	79	620				
	2004.11-		AT	R	Coupe Engine NFU(TU5JP4)	GDS10291	Drive Shaft		25	26	58.5	79	833				
	2004.11-		MT	R	Coupe Engine NFU(TU5JP4)	GDS10229	Drive Shaft		25	24	58.5	79	935				
	2004.11-		MT	R	Coupe Engine NFU(TU5JP4)	GDS99170	Drive Shaft		25	22	60	80	910				
2004.11-				Coupe Engine NFU(TU5JP4)	GC010097	Outer Joint		25	30	58.5	79.5	55	I				
1.6 HDi (66 kW)	2004.11-			F	Coupe Engine 9HX(DV6ATED4)	GC010028	Outer Joint		25	34	58	89	56	I			
	2004.11-		MT	L	Coupe Engine 9HX(DV6ATED4)	GDS45105	Drive Shaft		25	24	58	79	625				
	2004.11-		MT	R	Coupe Engine 9HX(DV6ATED4)	GDS45104	Drive Shaft		25	24	58	79	925				
	2004.11-		MT/AT	L	Coupe Engine 9HX(DV6ATED4)	GDS99019	Drive Shaft	29T	25	24	55.7	79	620				
	2004.11-		MT/AT	R	Coupe Engine 9HX(DV6ATED4)	GDS10229	Drive Shaft		25	24	58.5	79	935				
2004.11-			R	Coupe Engine 9HX(DV6ATED4)	GDS10173	Drive Shaft	29W	25	24	58.5	79	921					
1.6 HDi (80 kW)	2006.02-			F	Coupe Engine 9HY(DV6TED4)/9HZ(DV6TED4)	GC010028	Outer Joint		25	34	58	89	56	I			
	2006.02-			L	Coupe Engine 9HY(DV6TED4)/9HZ(DV6TED4)	GDS10255	Drive Shaft		25	24	58.5	79	616				
	2006.02-		MT	L	Coupe Engine 9HY(DV6TED4)/9HZ(DV6TED4)	GDS45105	Drive Shaft		25	24	58	79	625				
	2006.02-		AT	R	Coupe Engine 9HY(DV6TED4)/9HZ(DV6TED4)	GDS10254	Drive Shaft		25	24	58.5	79	939				
	2006.02-		MT	R	Coupe Engine 9HY(DV6TED4)/9HZ(DV6TED4)	GDS45104	Drive Shaft		25	24	58	79	925				
	2006.02-		MT	L	Coupe Engine 9HY(DV6TED4)/9HZ(DV6TED4)	GDS99019	Drive Shaft	29T	25	24	55.7	79	620				
	2006.02-		MT	R	Coupe Engine 9HY(DV6TED4)/9HZ(DV6TED4)	GDS10229	Drive Shaft		25	24	58.5	79	935				
2006.02-			R	Coupe Engine 9HY(DV6TED4)/9HZ(DV6TED4)	GDS10173	Drive Shaft	29W	25	24	58.5	79	921					
1.6 THP (110 kW)	2008.07-		MT	L	Coupe Engine 5FX(EP6DT)	GDS99019	Drive Shaft	29T	25	24	55.7	79	620				
	2008.07-		MT	R	Coupe Engine 5FX(EP6DT)	GDS10229	Drive Shaft		25	24	58.5	79	935				
	2008.07-		AT		Coupe Engine 5FX(EP6DT)	GC099366	Outer Joint		25	34	58.5	79	55	I			



	 YEAR	TRANSM	L/R	F/R		G-AP Ref.	PRODUCT	ABS	Technical Specifications									
									A	B	C	H	L	P				
<b>CITROEN</b>																		
<b>C4 (LA_)</b>																		
1.6 VTi (88 kW)	2008.07-	MT	L	F	Coupe Engine 5FW(EP6)	GDS99019	Drive Shaft	29T	25	24	55.7	79	620					
	2008.07-	AT	R	F	Coupe Engine 5FW(EP6)	GDS10229	Drive Shaft		25	24	58.5	79	935					
	2008.07-	AT			Coupe Engine 5FW(EP6)	GC099366	Outer Joint		25	34	58.5	79	55	I				
2.0 16V (100 kW)	2004.11-		R	F	Coupe Engine RFN(EW10J4)	GDS10173	Drive Shaft	29W	25	24	58.5	79	921					
	2004.11-			F	Coupe Engine RFN(EW10J4)	GC010028	Outer Joint		25	34	58	89	56	I				
	2004.11-	MT	L	F	Coupe Engine RFN(EW10J4)	GDS45105	Drive Shaft		25	24	58	79	625					
	2004.11-	MT	R	F	Coupe Engine RFN(EW10J4)	GDS45104	Drive Shaft		25	24	58	79	925					
2.0 16V (130 kW)	2004.11-	MT	L	F	Coupe Engine RFK(EW10J4S)	GDS45105	Drive Shaft		25	24	58	79	625					
	2004.11-	MT	R	F	Coupe Engine RFK(EW10J4S)	GDS45104	Drive Shaft		25	24	58	79	925					
	2004.11-	MT	L	F	Coupe Engine RFK(EW10J4S)	GDS99019	Drive Shaft	29T	25	24	55.7	79	620					
	2004.11-	MT	R	F	Coupe Engine RFK(EW10J4S)	GDS10229	Drive Shaft		25	24	58.5	79	935					
	2004.11-		R	F	Coupe Engine RFK(EW10J4S)	GDS10173	Drive Shaft	29W	25	24	58.5	79	921					
	2004.11-				Coupe Engine RFK(EW10J4S)	GC099366	Outer Joint		25	34	58.5	79	55	I				
2.0 HDi (100 kW)	2004.11-			F	Coupe Engine RHR(DW10BTED4)	GC010085	Outer Joint		25	39	59	89	63.5	I				
	2004.11-	6MT	L	F	Coupe Engine RHR(DW10BTED4)	GDS10268	Drive Shaft		25	37	58.5	89	621					
	2004.11-	AT	L	F	Coupe Engine RHR(DW10BTED4)	GDS10293	Drive Shaft		25	24	58.7	79	610					
	2004.11-	AT	R	F	Coupe Engine RHR(DW10BTED4)	GDS10295	Drive Shaft		25	24	58.7	79	948					
	2004.11-	MT	R	F	Coupe Engine RHR(DW10BTED4)	GDS88082	Drive Shaft		25	37	58.5	89	949					
2.0 HDi (103 kW)	2008.07-	AT	L	F	Coupe Engine RHF(DW10BTED4)	GDS10293	Drive Shaft		25	24	58.7	79	610					
	2008.07-	AT	R	F	Coupe Engine RHF(DW10BTED4)	GDS10295	Drive Shaft		25	24	58.7	79	948					
	2008.07-	MT	R	F	Coupe Engine RHF(DW10BTED4)	GDS88082	Drive Shaft		25	37	58.5	89	949					
<b>C4 GRAND PICASSO I (UA_)</b>																		
1.6 16V (103 kW)	2008.07-	MT	L	F	MPV Engine 5FT(EP6DT)	GDS99019	Drive Shaft	29T	25	24	55.7	79	620					
	2008.07-	AT	R	F	MPV Engine 5FT(EP6DT)	GDS10229	Drive Shaft		25	24	58.5	79	935					
	2008.07-	MT/AT			MPV Engine 5FT(EP6DT)	GC099366	Outer Joint		25	34	58.5	79	55	I				
1.6 16V (110 kW)	2008.10-		L	F	MPV Engine 5FX(EP6DT)	GDS10255	Drive Shaft		25	24	58.5	79	616					
	2008.10-		R	F	MPV Engine 5FX(EP6DT)	GDS10254	Drive Shaft		25	24	58.5	79	939					
	2008.10-	MT	L	F	MPV Engine 5FX(EP6DT)	GDS99019	Drive Shaft	29T	25	24	55.7	79	620					
	2008.10-	MT	R	F	MPV Engine 5FX(EP6DT)	GDS10229	Drive Shaft		25	24	58.5	79	935					
	2008.10-	MT/AT			MPV Engine 5FX(EP6DT)	GC099366	Outer Joint		25	34	58.5	79	55	I				
1.6 HDi (80 kW)	2006.12-		L	F	MPV Engine 9HY(DV6TED4)/9HZ(DV6TED4)	GDS45105	Drive Shaft		25	24	58	79	625					
	2006.12-	MT	L	F	MPV Engine 9HY(DV6TED4)/9HZ(DV6TED4)	GDS10255	Drive Shaft		25	24	58.5	79	616					
	2006.12-		R	F	MPV Engine 9HY(DV6TED4)/9HZ(DV6TED4)	GDS45104	Drive Shaft		25	24	58	79	925					
	2006.12-	AT	R	F	MPV Engine 9HY(DV6TED4)/9HZ(DV6TED4)	GDS10254	Drive Shaft		25	24	58.5	79	939					
	2006.12-	MT	L	F	MPV Engine 9HY(DV6TED4)/9HZ(DV6TED4)	GDS99019	Drive Shaft	29T	25	24	55.7	79	620					
	2006.12-	MT	R	F	MPV Engine 9HY(DV6TED4)/9HZ(DV6TED4)	GDS10229	Drive Shaft		25	24	58.5	79	935					
	2006.12-				MPV Engine 9HY(DV6TED4)/9HZ(DV6TED4)	GC099366	Outer Joint		25	34	58.5	79	55	I				
1.6 HDi (82 kW)	2010.09-	AT	L	F	MPV Engine 9HL(DV6C)	GDS10255	Drive Shaft		25	24	58.5	79	616					
	2010.09-	AT	L	F	MPV Engine 9HR(DV6C)/9HL(DV6C)	GDS10255	Drive Shaft		25	24	58.5	79	616					
	2010.09-	AT	R	F	MPV Engine 9HL(DV6C)	GDS10254	Drive Shaft		25	24	58.5	79	939					
	2010.09-	AT	R	F	MPV Engine 9HR(DV6C)/9HL(DV6C)	GDS10254	Drive Shaft		25	24	58.5	79	939					
	2010.09-	MT	L	F	MPV Engine 9HR(DV6C)/9HL(DV6C)	GDS99019	Drive Shaft	29T	25	24	55.7	79	620					
	2010.09-	MT	R	F	MPV Engine 9HR(DV6C)/9HL(DV6C)	GDS10229	Drive Shaft		25	24	58.5	79	935					
	2010.09-	MT/AT/4MT			MPV Engine 9HR(DV6C)/9HL(DV6C)	GC099366	Outer Joint		25	34	58.5	79	55	I				
1.6 THP (115 kW)	2010.09-		L	F	MPV Engine 5FV(EP6CDT)	GDS10255	Drive Shaft		25	24	58.5	79	616					
	2010.09-		R	F	MPV Engine 5FV(EP6CDT)	GDS10254	Drive Shaft		25	24	58.5	79	939					
	2010.09-	AT	L	F	MPV Engine 5FV(EP6CDT)	GDS99019	Drive Shaft	29T	25	24	55.7	79	620					
	2010.09-	AT	R	F	MPV Engine 5FV(EP6CDT)	GDS10229	Drive Shaft		25	24	58.5	79	935					
	2010.09-				MPV Engine 5FV(EP6CDT)	GC099366	Outer Joint		25	34	58.5	79	55	I				
1.6 VTi (88 kW)	2008.07-		L	F	MPV Engine 5FW(EP6)	GDS45105	Drive Shaft		25	24	58	79	625					
	2008.07-		R	F	MPV Engine 5FW(EP6)	GDS45104	Drive Shaft		25	24	58	79	925					
	2008.07-				MPV Engine 5FW(EP6)	GC099366	Outer Joint		25	34	58.5	79	55	I				
1.8 i 16V (92 kW)	2006.12-		L	F	MPV Engine 6FY(EW7A)	GDS45105	Drive Shaft		25	24	58	79	625					
	2006.12-		R	F	MPV Engine 6FY(EW7A)	GDS45104	Drive Shaft		25	24	58	79	925					
	2006.12-	MT	L	F	MPV Engine 6FY(EW7A)	GDS99019	Drive Shaft	29T	25	24	55.7	79	620					
	2006.12-	MT	R	F	MPV Engine 6FY(EW7A)	GDS10229	Drive Shaft		25	24	58.5	79	935					
	2006.12-				MPV Engine 6FY(EW7A)	GC099366	Outer Joint		25	34	58.5	79	55	I				
2.0 HDi (100 kW)	2006.12-		L	F	MPV Engine RHJ-DW10BTED4/RHR(DW10BTED4)	GDS10293	Drive Shaft		25	24	58.7	79	610					
	2006.12-	Semi-AT	R	F	MPV Engine RHJ-DW10BTED4/RHR(DW10BTED4)	GDS10295	Drive Shaft		25	24	58.7	79	948					
	2006.12-				MPV Engine RHJ-DW10BTED4/RHR(DW10BTED4)	GC010118	Outer Joint		25	26	58.7	79	61.5	M				
2.0 HDi (110 kW)	2009.07-		L	F	MPV Engine RHE(DW10CTED4)	GDS10293	Drive Shaft		25	24	58.7	79	610					
	2009.07-		R	F	MPV Engine RHE(DW10CTED4)	GDS10295	Drive Shaft		25	24	58.7	79	948					





		TRANSM	L/R	F/R		G-AP Ref.	PRODUCT	ABS	Technical Specifications								
									YEAR	A	B	C	H	L	P		
<b>CITROEN</b>																	
<b>C4 GRAND PICASSO I (UA_)</b>																	
2.0 HDi (110 kW)	2009.07-	4MT/AT			MPV Engine RHE(DW10CTED4)	GC099366	Outer Joint		25	34	58.5	79	55	I			
2.0 HDi (120 kW)	2010.09-	4MT/AT			MPV Engine RHH(DW10CTED4)	GC099366	Outer Joint		25	34	58.5	79	55	I			
2.0 i 16V (103 kW)	2006.12-	MT	R	F	MPV Engine RFJ(EW10A)	GDS10254	Drive Shaft		25	24	58.5	79	939				
	2006.12-	AT	L	F	MPV Engine RFJ(EW10A)	GDS10286	Drive Shaft		25	26	58.5	79	613				
	2006.12-	AT	R	F	MPV Engine RFJ(EW10A)	GDS10291	Drive Shaft		25	26	58.5	79	833				
	2006.12-	MT/AT			MPV Engine RFJ(EW10A)	GC099366	Outer Joint		25	34	58.5	79	55	I			
<b>C4 I (LC_)</b>																	
1.4 16V (65 kW)	2004.11-			F	Hatchback Engine KFU(ET3J4)	GC010025	Outer Joint		25	22	60	80	54	I			
	2004.11-	AT	L	F	Hatchback Engine KFU(ET3J4)	GDS10255	Drive Shaft		25	24	58.5	79	616				
	2004.11-	MT	L	F	Hatchback Engine KFU(ET3J4)	GDS45119	Drive Shaft		25	22	58.5	79.5	633				
	2004.11-	MT	L	F	Hatchback Engine KFU(ET3J4)	GDS45126	Drive Shaft		25	24	58.5	89	630				
	2004.11-	AT	R	F	Hatchback Engine KFU(ET3J4)	GDS10254	Drive Shaft		25	24	58.5	79	939				
	2004.11-	MT	R	F	Hatchback Engine KFU(ET3J4)	GDS45113	Drive Shaft		25	22	58.5	79.5	915				
	2004.11-	MT	R	F	Hatchback Engine KFU(ET3J4)	GDS45104	Drive Shaft		25	24	58	79	925				
	2004.11-	MT	R	F	Hatchback Engine KFU(ET3J4)	GDS99170	Drive Shaft		25	22	60	80	910				
1.6 16V (80 kW)	2004.11-			F	Hatchback Engine KFU(ET3J4)	GC010097	Outer Joint		25	30	58.5	79.5	55	I			
	2004.11-			F	Hatchback Engine NFU(TU5JP4)	GC010025	Outer Joint		25	22	60	80	54	I			
	2004.11-	MT	L	F	Hatchback Engine NFU(TU5JP4)	GDS45119	Drive Shaft		25	22	58.5	79.5	633				
	2004.11-	MT	L	F	Hatchback Engine NFU(TU5JP4)	GDS45126	Drive Shaft		25	24	58.5	89	630				
	2004.11-	MT	R	F	Hatchback Engine NFU(TU5JP4)	GDS45113	Drive Shaft		25	22	58.5	79.5	915				
	2004.11-	MT	R	F	Hatchback Engine NFU(TU5JP4)	GDS45104	Drive Shaft		25	24	58	79	925				
	2004.11-	AT	L	F	Hatchback Engine NFU(TU5JP4)	GDS10286	Drive Shaft		25	26	58.5	79	613				
	2004.11-	MT	L	F	Hatchback Engine NFU(TU5JP4)	GDS99019	Drive Shaft	29T	25	24	55.7	79	620				
	2004.11-	AT	R	F	Hatchback Engine NFU(TU5JP4)	GDS10291	Drive Shaft		25	26	58.5	79	833				
	2004.11-	MT	R	F	Hatchback Engine NFU(TU5JP4)	GDS10229	Drive Shaft		25	24	58.5	79	935				
2004.11-	MT	R	F	Hatchback Engine NFU(TU5JP4)	GDS99170	Drive Shaft		25	22	60	80	910					
1.6 16V Bio-Flex (80 kW)	2004.11-			F	Hatchback Engine NFU(TU5JP4)	GC010097	Outer Joint		25	30	58.5	79.5	55	I			
1.6 HDi (66 kW)	2007.09-			F	Hatchback Engine NFU(TU5JP4)	GC010097	Outer Joint		25	30	58.5	79.5	55	I			
	2004.11-			F	Hatchback Engine 9HX(DV6ATED4)	GC010028	Outer Joint		25	34	58	89	56	I			
	2004.11-	MT	L	F	Hatchback Engine 9HX(DV6ATED4)	GDS45105	Drive Shaft		25	24	58	79	625				
	2004.11-	MT	R	F	Hatchback Engine 9HX(DV6ATED4)	GDS45104	Drive Shaft		25	24	58	79	925				
	2004.11-	MT	L	F	Hatchback Engine 9HX(DV6ATED4)	GDS99019	Drive Shaft	29T	25	24	55.7	79	620				
	2004.11-	MT	R	F	Hatchback Engine 9HX(DV6ATED4)	GDS10229	Drive Shaft		25	24	58.5	79	935				
1.6 HDi (80 kW)	2004.11-			F	Hatchback Engine 9HX(DV6ATED4)	GDS10173	Drive Shaft	29W	25	24	58.5	79	921				
	2004.11-			F	Hatchback Engine 9HY(DV6TED4)/9HZ(DV6TED4)	GC010028	Outer Joint		25	34	58	89	56	I			
	2004.11-	MT	L	F	Hatchback Engine 9HY(DV6TED4)/9HZ(DV6TED4)	GDS45105	Drive Shaft		25	24	58	79	625				
	2004.11-	MT	R	F	Hatchback Engine 9HY(DV6TED4)/9HZ(DV6TED4)	GDS45104	Drive Shaft		25	24	58	79	925				
	2004.11-	MT	L	F	Hatchback Engine 9HY(DV6TED4)/9HZ(DV6TED4)	GDS99019	Drive Shaft	29T	25	24	55.7	79	620				
	2004.11-	MT	R	F	Hatchback Engine 9HY(DV6TED4)/9HZ(DV6TED4)	GDS10229	Drive Shaft		25	24	58.5	79	935				
1.6 THP (103 kW)	2008.07-	AT			Hatchback Engine 5FT(EP6DT)	GC099366	Outer Joint		25	34	58.5	79	55	I			
	2008.07-	MT	L	F	Hatchback Engine 5FX(EP6DT)	GDS99019	Drive Shaft	29T	25	24	55.7	79	620				
1.6 THP (110 kW)	2008.07-	MT	R	F	Hatchback Engine 5FX(EP6DT)	GDS10229	Drive Shaft		25	24	58.5	79	935				
	2008.07-	AT			Hatchback Engine 5FX(EP6DT)	GC099366	Outer Joint		25	34	58.5	79	55	I			
	2008.07-	AT			Hatchback Engine 5FX(EP6DT)	GC099366	Outer Joint		25	34	58.5	79	55	I			
1.6 VTi (88 kW)	2008.07-		L	F	Hatchback Engine 5FW(EP6)	GDS45105	Drive Shaft		25	24	58	79	625				
	2008.07-		R	F	Hatchback Engine 5FW(EP6)	GDS45104	Drive Shaft		25	24	58	79	925				
	2008.07-	AT	L	F	Hatchback Engine 5FW(EP6)	GDS10286	Drive Shaft		25	26	58.5	79	613				
	2008.07-	AT	R	F	Hatchback Engine 5FW(EP6)	GDS10291	Drive Shaft		25	26	58.5	79	833				
	2008.07-	AT			Hatchback Engine 5FW(EP6)	GC099366	Outer Joint		25	34	58.5	79	55	I			
	2008.07-	AT			Hatchback Engine 5FW(EP6)	GC099366	Outer Joint		25	34	58.5	79	55	I			
2.0 16V (100 kW)	2004.11-			F	Hatchback Engine RFN(EW10J4)	GC010028	Outer Joint		25	34	58	89	56	I			
	2004.11-	MT	L	F	Hatchback Engine RFN(EW10J4)	GDS45105	Drive Shaft		25	24	58	79	625				
	2004.11-	MT	R	F	Hatchback Engine RFN(EW10J4)	GDS45104	Drive Shaft		25	24	58	79	925				
	2004.11-	MT	L	F	Hatchback Engine RFN(EW10J4)	GDS99019	Drive Shaft	29T	25	24	55.7	79	620				
	2004.11-	MT	R	F	Hatchback Engine RFN(EW10J4)	GDS10229	Drive Shaft		25	24	58.5	79	935				
	2004.11-	MT	R	F	Hatchback Engine RFN(EW10J4)	GDS10173	Drive Shaft	29W	25	24	58.5	79	921				
2.0 16V (103 kW)	2004.11-			F	Hatchback Engine RFJ(EW10A)	GC010028	Outer Joint		25	34	58	89	56	I			
	2004.11-	MT	L	F	Hatchback Engine RFJ(EW10A)	GDS45105	Drive Shaft		25	24	58	79	625				
	2004.11-	MT	R	F	Hatchback Engine RFJ(EW10A)	GDS45104	Drive Shaft		25	24	58	79	925				
	2004.11-	MT	L	F	Hatchback Engine RFJ(EW10A)	GDS99019	Drive Shaft	29T	25	24	55.7	79	620				
	2004.11-	MT	R	F	Hatchback Engine RFJ(EW10A)	GDS10229	Drive Shaft		25	24	58.5	79	935				
	2004.11-	MT	R	F	Hatchback Engine RFJ(EW10A)	GDS10173	Drive Shaft	29W	25	24	58.5	79	921				
	2004.11-			F	Hatchback Engine RFJ(EW10A)	GC010028	Outer Joint		25	34	58	89	56	I			
	2004.11-	MT	L	F	Hatchback Engine RFJ(EW10A)	GDS45105	Drive Shaft		25	24	58	79	625				
2.0 16V (103 kW)	2004.11-	MT	R	F	Hatchback Engine RFJ(EW10A)	GDS45104	Drive Shaft		25	24	58	79	925				
	2004.11-	AT	L	F	Hatchback Engine RFJ(EW10A)	GDS10286	Drive Shaft		25	26	58.5	79	613				
	2004.11-	MT	L	F	Hatchback Engine RFJ(EW10A)	GDS99019	Drive Shaft	29T	25	24	55.7	79	620				
	2004.11-	AT	R	F	Hatchback Engine RFJ(EW10A)	GDS10291	Drive Shaft		25	26	58.5	79	833				
	2004.11-	MT	R	F	Hatchback Engine RFJ(EW10A)	GDS10229	Drive Shaft		25	24	58.5	79	935				
	2004.11-	MT	R	F	Hatchback Engine RFJ(EW10A)	GDS10229	Drive Shaft		25	24	58.5	79	935				



		TRANSM	L/R	F/R		G-AP Ref.	PRODUCT	ABS	Technical Specifications									
									YEAR	A	B	C	H	L	P			
<b>CITROEN</b>																		
<b>C4 I (LC_)</b>																		
2.0 16V (103 kW)	2004.11-				Hatchback Engine RFJ(EW10A)	GDS10173	Drive Shaft	29W	25	24	58.5	79	921					
2.0 16V (130 kW)	2004.11-		MT	L	F	Hatchback Engine RFK(EW10J4S)	GDS45105	Drive Shaft		25	24	58	79	625				
	2004.11-		MT	R	F	Hatchback Engine RFK(EW10J4S)	GDS45104	Drive Shaft		25	24	58	79	925				
	2004.11-		MT	L	F	Hatchback Engine RFK(EW10J4S)	GDS99019	Drive Shaft	29T	25	24	55.7	79	620				
	2004.11-		MT	R	F	Hatchback Engine RFK(EW10J4S)	GDS10229	Drive Shaft		25	24	58.5	79	935				
	2004.11-				R	F	Hatchback Engine RFK(EW10J4S)	GDS10173	Drive Shaft	29W	25	24	58.5	79	921			
	2004.11-					Hatchback Engine RFK(EW10J4S)	GC099366	Outer Joint		25	34	58.5	79	55	I			
2.0 HDi (100 kW)	2006.02-	2007.10			F	Hatchback Engine RHR(DW10BTED4)	GC010085	Outer Joint		25	39	59	89	63.5	I			
	2006.02-	2007.10	6MT	L	F	Hatchback Engine RHR(DW10BTED4)	GDS10268	Drive Shaft		25	37	58.5	89	621				
	2006.02-	2007.10	AT	L	F	Hatchback Engine RHR(DW10BTED4)	GDS10293	Drive Shaft		25	24	58.7	79	610				
	2006.02-	2007.10	AT	R	F	Hatchback Engine RHR(DW10BTED4)	GDS10295	Drive Shaft		25	24	58.7	79	948				
	2006.02-	2007.10	MT	R	F	Hatchback Engine RHR(DW10BTED4)	GDS88082	Drive Shaft		25	37	58.5	89	949				
2.0 HDi (103 kW)	2008.07-				L	F	Hatchback Engine RHF(DW10BTED4)	GDS10268	Drive Shaft		25	37	58.5	89	621			
	2008.07-				AT	L	F	Hatchback Engine RHF(DW10BTED4)	GDS10293	Drive Shaft		25	24	58.7	79	610		
	2008.07-				AT	R	F	Hatchback Engine RHF(DW10BTED4)	GDS10295	Drive Shaft		25	24	58.7	79	948		
	2008.07-				MT	R	F	Hatchback Engine RHF(DW10BTED4)	GDS88082	Drive Shaft		25	37	58.5	89	949		
<b>C4 II (B7)</b>																		
1.4 VTi (70 kW)	2009.11-				R	F	Hatchback Engine 8FP(EP3)	GDS10251	Drive Shaft		25	24	58.5	79	935			
1.6 BlueHdi (73 kW)	2014.07-		MT	R	F	Hatchback Engine BHY (DV6FD)	GDS10251	Drive Shaft		25	24	58.5	79	935				
1.6 HDi (68 kW)	2009.11-				R	F	Hatchback Engine 9HP(DV6DTEd)	GDS10251	Drive Shaft		25	24	58.5	79	935			
1.6 HDi (82 kW)	2009.11-				L	F	Hatchback Engine 9HR(DV6C)	GDS10253	Drive Shaft		25	24	58.5	79	626			
	2009.11-				L	F	Hatchback Engine 9HR(DV6C)	GCI10057	Inner Joint		24	34	40	52.5	90			
	2009.11-				L/R	F	Hatchback Engine 9HR(DV6C)	GC010148	Outer Joint		25	34	58.5	79	55.5	I		
	2009.11-				R	F	Hatchback Engine 9HR(DV6C)	GDS10325	Drive Shaft		25	24	58.5	79	940			
	2009.11-				R	F	Hatchback Engine 9HR(DV6C)	GCI10058	Inner Joint		24	34	29.8	365	88			
1.6 HDi (84 kW)	2012.07-		MT	L	F	Hatchback Engine 9HR(DV6C)	GDS10255	Drive Shaft		25	24	58.5	79	616				
	2012.07-		MT	R	F	Hatchback Engine 9HR(DV6C)	GDS10254	Drive Shaft		25	24	58.5	79	939				
	2012.07-		MT	L	F	Hatchback Engine 9HR(DV6C)	GDS10250	Drive Shaft		25	24	58.5	79	634				
	2012.07-		MT/AT	L	F	Hatchback Engine 9HR(DV6C)	GDS10253	Drive Shaft		25	24	58.5	79	626				
	2012.07-		MT/AT	L	F	Hatchback Engine 9HR(DV6C)	GCI10057	Inner Joint		24	34	40	52.5	90				
	2012.07-		MT/AT	L/R	F	Hatchback Engine 9HR(DV6C)	GC010148	Outer Joint		25	34	58.5	79	55.5	I			
	2012.07-		MT/AT	R	F	Hatchback Engine 9HR(DV6C)	GDS10325	Drive Shaft		25	24	58.5	79	940				
	2012.07-		MT/AT	R	F	Hatchback Engine 9HR(DV6C)	GCI10058	Inner Joint		24	34	29.8	365	88				
1.6 THP (115 kW)	2009.11-				L	F	Hatchback Engine 5FV(EP6CDT)	GDS10253	Drive Shaft		25	24	58.5	79	626			
	2009.11-				L	F	Hatchback Engine 5FV(EP6CDT)	GCI10057	Inner Joint		24	34	40	52.5	90			
	2009.11-				L/R	F	Hatchback Engine 5FV(EP6CDT)	GC010148	Outer Joint		25	34	58.5	79	55.5	I		
	2009.11-				R	F	Hatchback Engine 5FV(EP6CDT)	GDS10325	Drive Shaft		25	24	58.5	79	940			
	2009.11-				R	F	Hatchback Engine 5FV(EP6CDT)	GCI10058	Inner Joint		24	34	29.8	365	88			
	2009.11-		AT			Hatchback Engine 5FV(EP6CDT)	GC099366	Outer Joint		25	34	58.5	79	55	I			
1.6 VTi (88 kW)	2009.11-		AT	L	F	Hatchback Engine 5FS(EP6C)	GDS10362	Drive Shaft		25	26	58.5	79	624				
	2009.11-		AT	L	F	Hatchback Engine 5FS(EP6C)	GCI99001	Inner Joint		26	34	42.5	46.5	103.5				
	2009.11-		AT	L	F	Hatchback Engine 5FS(EP6C)	GC099366	Outer Joint		25	34	58.5	79	55	I			
	2009.11-		AT	R	F	Hatchback Engine 5FS(EP6C)	GDS10383	Drive Shaft		25	26	58	79	842				
	2009.11-		MT	R	F	Hatchback Engine 5FS(EP6C)	GDS10251	Drive Shaft		25	24	58.5	79	935				
	2009.11-		AT			Hatchback Engine 5FS(EP6C)	GC099366	Outer Joint		25	34	58.5	79	55	I			
	2009.11-					Hatchback Engine 5FS(EP6C)	GDS10251	Drive Shaft		25	24	58.5	79	935				
1.6 VTi LPG (88 kW)	2011.09-				R	F	Hatchback Engine 5FS(EP6C)	GDS10251	Drive Shaft		25	24	58.5	79	935			
2.0 HDi (110 kW)	2009.11-				L	F	Hatchback Engine RHE(DW10CTED4)	GDS10427	Drive Shaft		25	37	58.5	89	638			
	2009.11-				R	F	Hatchback Engine RHE(DW10CTED4)	GDS10421	Drive Shaft		25	37	58.5	89	972			
	2009.11-					Hatchback Engine RHE(DW10CTED4)	GC099366	Outer Joint		25	34	58.5	79	55	I			
<b>C4 PICASSO I (UD_)</b>																		
1.6 16V (110 kW)	2008.07-				L	F	MPV Engine 5FX(EP6DT)	GDS10255	Drive Shaft		25	24	58.5	79	616			
	2008.07-				R	F	MPV Engine 5FX(EP6DT)	GDS10254	Drive Shaft		25	24	58.5	79	939			
	2008.07-		AT	L	F	MPV Engine 5FX(EP6DT)	GDS99019	Drive Shaft	29T	25	24	55.7	79	620				
	2008.07-		AT	R	F	MPV Engine 5FX(EP6DT)	GDS10229	Drive Shaft		25	24	58.5	79	935				
	2008.07-		AT			MPV Engine 5FX(EP6DT)	GC099366	Outer Joint		25	34	58.5	79	55	I			
	2008.07-					MPV Engine 5FX(EP6DT)	GDS10251	Drive Shaft		25	24	58.5	79	935				
1.6 HDi (80 kW)	2007.03-				L	F	MPV Engine 9HY(DV6TED4)/9HZ(DV6TED4)	GDS45105	Drive Shaft		25	24	58	79	625			
	2007.03-		AT	L	F	MPV Engine 9HY(DV6TED4)/9HZ(DV6TED4)	GDS10255	Drive Shaft		25	24	58.5	79	616				
	2007.03-		AT	R	F	MPV Engine 9HY(DV6TED4)/9HZ(DV6TED4)	GDS10254	Drive Shaft		25	24	58.5	79	939				
	2007.03-		MT	L	F	MPV Engine 9HY(DV6TED4)/9HZ(DV6TED4)	GDS99019	Drive Shaft	29T	25	24	55.7	79	620				
	2007.03-		MT	R	F	MPV Engine 9HY(DV6TED4)/9HZ(DV6TED4)	GDS10229	Drive Shaft		25	24	58.5	79	935				
	2007.03-					MPV Engine 9HY(DV6TED4)/9HZ(DV6TED4)	GC099366	Outer Joint		25	34	58.5	79	55	I			





	 <b>YEAR</b>	<b>TRANSM</b>	<b>L/R</b>	<b>F/R</b>		<b>G-AP Ref.</b>	<b>PRODUCT</b>	<b>ABS</b>	<b>Technical Specifications</b>						
									<b>A</b>	<b>B</b>	<b>C</b>	<b>H</b>	<b>L</b>	<b>P</b>	
<b>CITROEN C4 PICASSO I (UD_)</b>															
1.6 HDi (82 kW)	2010.09-		AT	L	F	MPV Engine 9HL(DV6C)	GDS10255	Drive Shaft		25	24	58.5	79	616	
	2010.09-		AT	L	F	MPV Engine 9HR(DV6C)	GDS10255	Drive Shaft		25	24	58.5	79	616	
	2010.09-		AT	R	F	MPV Engine 9HL(DV6C)	GDS10254	Drive Shaft		25	24	58.5	79	939	
	2010.09-		AT	R	F	MPV Engine 9HR(DV6C)	GDS10254	Drive Shaft		25	24	58.5	79	939	
	2010.09-		MT	L	F	MPV Engine 9HR(DV6C)	GDS99019	Drive Shaft	29T	25	24	55.7	79	620	
	2010.09-		MT	R	F	MPV Engine 9HR(DV6C)	GDS10229	Drive Shaft		25	24	58.5	79	935	
	2010.09-		AT			MPV Engine 9HR(DV6C)	GC099366	Outer Joint		25	34	58.5	79	55	I
1.6 THP (103 kW)	2008.07-		MT	L	F	MPV Engine 5FT(EP6DT)	GDS99019	Drive Shaft	29T	25	24	55.7	79	620	
	2008.07-		AT	R	F	MPV Engine 5FT(EP6DT)	GDS10229	Drive Shaft		25	24	58.5	79	935	
	2008.07-		AT			MPV Engine 5FT(EP6DT)	GC099366	Outer Joint		25	34	58.5	79	55	I
1.6 THP (115 kW)	2010.09-			L	F	MPV Engine 5FV(EP6CDT)	GDS10255	Drive Shaft		25	24	58.5	79	616	
	2010.09-			R	F	MPV Engine 5FV(EP6CDT)	GDS10254	Drive Shaft		25	24	58.5	79	939	
	2010.09-		AT	L	F	MPV Engine 5FV(EP6CDT)	GDS99019	Drive Shaft	29T	25	24	55.7	79	620	
	2010.09-		AT	R	F	MPV Engine 5FV(EP6CDT)	GDS10229	Drive Shaft		25	24	58.5	79	935	
	2010.09-		AT			MPV Engine 5FV(EP6CDT)	GC099366	Outer Joint		25	34	58.5	79	55	I
1.6 VTi (88 kW)	2008.07-			L	F	MPV Engine 5FW(EP6)	GDS45105	Drive Shaft		25	24	58	79	625	
	2008.07-			R	F	MPV Engine 5FW(EP6)	GDS45104	Drive Shaft		25	24	58	79	925	
	2008.07-		MT	L	F	MPV Engine 5FW(EP6)	GDS99019	Drive Shaft	29T	25	24	55.7	79	620	
	2008.07-		MT	R	F	MPV Engine 5FW(EP6)	GDS10229	Drive Shaft		25	24	58.5	79	935	
	2008.07-		AT			MPV Engine 5FW(EP6)	GC099366	Outer Joint		25	34	58.5	79	55	I
1.8 i 16V (92 kW)	2007.03-			L	F	MPV Engine 6FY(EW7A)	GDS45105	Drive Shaft		25	24	58	79	625	
	2007.03-			R	F	MPV Engine 6FY(EW7A)	GDS45104	Drive Shaft		25	24	58	79	925	
	2007.03-		MT	L	F	MPV Engine 6FY(EW7A)	GDS99019	Drive Shaft	29T	25	24	55.7	79	620	
	2007.03-		MT	R	F	MPV Engine 6FY(EW7A)	GDS10229	Drive Shaft		25	24	58.5	79	935	
	2007.03-					MPV Engine 6FY(EW7A)	GC099366	Outer Joint		25	34	58.5	79	55	I
2.0 HDi (100 kW)	2007.03-		AT	L	F	MPV Engine RHJ-DW10BTED4/RHR(DW10BTED4)	GDS10293	Drive Shaft		25	24	58.7	79	610	
	2007.03-		MT/AT	R	F	MPV Engine RHJ-DW10BTED4/RHR(DW10BTED4)	GDS10295	Drive Shaft		25	24	58.7	79	948	
	2007.03-					MPV Engine RHJ-DW10BTED4/RHR(DW10BTED4)	GC010118	Outer Joint		25	26	58.7	79	61.5	M
2.0 HDi (110 kW)	2009.07-		AT/Semi-AT	R	F	MPV Engine RHE(DW10CTED4)	GDS10295	Drive Shaft		25	24	58.7	79	948	
	2009.07-		AT			MPV Engine RHE(DW10CTED4)	GC099366	Outer Joint		25	34	58.5	79	55	I
2.0 HDi (120 kW)	2010.09-		AT			MPV Engine RHH(DW10CTED4)	GC099366	Outer Joint		25	34	58.5	79	55	I
2.0 i 16V (103 kW)	2007.03-		MT	R	F	MPV Engine RFJ(EW10A)	GDS10254	Drive Shaft		25	24	58.5	79	939	
	2007.03-		AT	L	F	MPV Engine RFJ(EW10A)	GDS10286	Drive Shaft		25	26	58.5	79	613	
	2007.03-		MT	L	F	MPV Engine RFJ(EW10A)	GDS99019	Drive Shaft	29T	25	24	55.7	79	620	
	2007.03-		AT	R	F	MPV Engine RFJ(EW10A)	GDS10291	Drive Shaft		25	26	58.5	79	833	
	2007.03-		MT	R	F	MPV Engine RFJ(EW10A)	GDS10229	Drive Shaft		25	24	58.5	79	935	
	2007.03-		MT/AT			MPV Engine RFJ(EW10A)	GC099366	Outer Joint		25	34	58.5	79	55	I
<b>C4 PICASSO II</b>															
1.6 THP (115 kW)	2013.02-		AT			MPV Engine 5FV(EP6CDT)	GC099366	Outer Joint		25	34	58.5	79	55	I
1.6 VTi (88 kW)	2013.02-		AT			MPV Engine 5FS(EP6C)	GC099366	Outer Joint		25	34	58.5	79	55	I
2.0 BLUE HDi (110 kW)	2013.09-		AT			MPV	GC099366	Outer Joint		25	34	58.5	79	55	I
<b>C5 I (DC_)</b>															
1.8 16V (85 kW)	2001.03-2004.08		MT		F	Hatchback Engine 6FZ(EW7J4)	GC045038	Outer Joint		25	34	58.5	89	55	I
	2001.03-2004.08		MT	L	F	Hatchback Engine 6FZ(EW7J4)	GDS45140	Drive Shaft		25	24	58.5	89	650	
	2001.03-2004.08		MT	L	F	Hatchback Engine 6FZ(EW7J4)	GDS10192	Drive Shaft		25	24	58.5	89	655	
	2001.03-2004.08		MT	R	F	Hatchback Engine 6FZ(EW7J4)	GDS10143	Drive Shaft		25	24	58.5	89	936	
	2001.03-2004.08					Hatchback Engine 6FZ(EW7J4)	GC045041	Outer Joint	48T	25	34	58.5	89	55	I
2.0 16V (100 kW)	2001.03-2004.08				F	Hatchback Engine RFN(EW10J4)	GC045038	Outer Joint		25	34	58.5	89	55	I
	2001.03-2004.08		MT	L	F	Hatchback Engine RFN(EW10J4)	GDS45140	Drive Shaft		25	24	58.5	89	650	
	2001.03-2004.08		MT	L	F	Hatchback Engine RFN(EW10J4)	GDS10142	Drive Shaft		25	24	58.5	89	648	
	2001.03-2004.08		MT	R	F	Hatchback Engine RFN(EW10J4)	GDS10143	Drive Shaft		25	24	58.5	89	936	
	2001.03-2004.08		MT			Hatchback Engine RFN(EW10J4)	GC045041	Outer Joint	48T	25	34	58.5	89	55	I
2.0 16V HPI (103 kW)	2001.03-2004.08				F	Hatchback Engine RLZ(EW10D)	GC045038	Outer Joint		25	34	58.5	89	55	I
	2001.03-2004.08		MT	L	F	Hatchback Engine RLZ(EW10D)	GDS45140	Drive Shaft		25	24	58.5	89	650	
	2001.03-2004.08		MT	L	F	Hatchback Engine RLZ(EW10D)	GDS10142	Drive Shaft		25	24	58.5	89	648	
	2001.03-2004.08		MT	R	F	Hatchback Engine RLZ(EW10D)	GDS10143	Drive Shaft		25	24	58.5	89	936	
	2001.03-2004.08		MT			Hatchback Engine RLZ(EW10D)	GC045041	Outer Joint	48T	25	34	58.5	89	55	I
2.0 HDi (66 kW)	2001.03-2004.08			L	F	Hatchback Engine RHY(DW10TD)	GDS10142	Drive Shaft		25	24	58.5	89	648	
	2001.03-2004.08		MT	L	F	Hatchback Engine RHY(DW10TD)	GDS45140	Drive Shaft		25	24	58.5	89	650	
	2001.03-2004.08			R	F	Hatchback Engine RHY(DW10TD)	GDS10143	Drive Shaft		25	24	58.5	89	936	
	2001.03-2004.08		MT	R	F	Hatchback Engine RHY(DW10TD)	GDS99189	Drive Shaft		25	24	58.5	89	936	
	2001.03-2004.08					Hatchback Engine RHY(DW10TD)	GC045041	Outer Joint	48T	25	34	58.5	89	55	I





		YEAR	TRANSM	L/R	F/R		G-AP Ref.	PRODUCT	ABS	Technical Specifications						
										A	B	C	H	L	P	
<b>CITROEN</b>																
<b>C5 I (DC_)</b>																
2.0 HDi (79 kW)	2001.03-	2004.08	MT	L	F	Hatchback Engine RHS(DW10ATED)/RHZ(DW10ATED)	GDS99172	Drive Shaft		25	37	58.5	89	623		
	2001.03-	2004.08	AT			Hatchback Engine RHS(DW10ATED)/RHZ(DW10ATED)	GC045041	Outer Joint	48T	25	34	58.5	89	55	I	
2.0 HDi (80 kW)	2001.03-	2004.08	MT	L	F	Hatchback Engine RHZ(DW10ATED)	GDS99172	Drive Shaft		25	37	58.5	89	623		
	2001.03-	2004.08	MT	L	F	Hatchback Engine RHZ(DW10ATED)	GDS10141	Drive Shaft		25	37	58.5	89	638		
	2001.03-	2004.08	MT	R	F	Hatchback Engine RHZ(DW10ATED)	GDS10139	Drive Shaft		25	37	58.5	89	944		
	2001.03-	2004.08	AT			Hatchback Engine RHZ(DW10ATED)	GC045041	Outer Joint	48T	25	34	58.5	89	55	I	
	2001.03-	2004.08	AT			Hatchback Engine RHZ(DW10ATED)	GDS99172	Drive Shaft		25	37	58.5	89	623		
2.2 HDi (98 kW)	2001.03-	2004.08			F	Hatchback Engine 4HX(DW12TED4/FAP)	GC010075	Outer Joint		25	26	58.5	89	63	M	
	2001.03-	2004.08	MT		F	Hatchback Engine 4HX(DW12TED4/FAP)	GC045038	Outer Joint		25	34	58.5	89	55	I	
	2001.03-	2004.08	AT	L	F	Hatchback Engine 4HX(DW12TED4/FAP)	GDS10344	Drive Shaft		25	37	58.5	89	607		
	2001.03-	2004.08	AT	L	F	Hatchback Engine 4HX(DW12TED4/FAP)	GDS10207	Drive Shaft		25	37	58.5	89	602		
	2001.03-	2004.08	MT	L	F	Hatchback Engine 4HX(DW12TED4/FAP)	GDS99172	Drive Shaft		25	37	58.5	89	623		
	2001.03-	2004.08	MT	L	F	Hatchback Engine 4HX(DW12TED4/FAP)	GDS10121	Drive Shaft		25	37	58.5	89	628		
	2001.03-	2004.08	AT	R	F	Hatchback Engine 4HX(DW12TED4/FAP)	GDS10208	Drive Shaft		25	37	58.5	89	908		
	2001.03-	2004.08	MT	R	F	Hatchback Engine 4HX(DW12TED4/FAP)	GDS10140	Drive Shaft		25	37	58.5	89	948		
	2001.03-	2004.08			F	Hatchback Engine XFX(ES9J4S)	GC010075	Outer Joint		25	26	58.5	89	63	M	
	2001.03-	2004.08	AT	L	F	Hatchback Engine XFX(ES9J4S)	GDS10344	Drive Shaft		25	37	58.5	89	607		
3.0 V6 (152 kW)	2001.03-	2004.08	MT	L	F	Hatchback Engine XFX(ES9J4S)	GDS10141	Drive Shaft		25	37	58.5	89	638		
	2001.03-	2004.08	MT	R	F	Hatchback Engine XFX(ES9J4S)	GDS10139	Drive Shaft		25	37	58.5	89	944		
	2001.03-	2004.08			F	Hatchback Engine XFX(ES9J4S)	GC010075	Outer Joint		25	26	58.5	89	63	M	
<b>C5 I (DE_)</b>																
1.8 16V (85 kW)	2001.06-	2004.08	MT	R	F	Estate Engine 6FZ(EW7J4)	GDS10143	Drive Shaft		25	24	58.5	89	936		
	2001.06-	2004.08				Estate Engine 6FZ(EW7J4)	GC045041	Outer Joint	48T	25	34	58.5	89	55	I	
	2001.06-	2004.08	MT		F	Estate Engine 6FZ(EW7J4)	GC045038	Outer Joint		25	34	58.5	89	55	I	
	2001.06-	2004.08	MT	L	F	Estate Engine 6FZ(EW7J4)	GDS45140	Drive Shaft		25	24	58.5	89	650		
	2001.06-	2004.08	MT	L	F	Estate Engine 6FZ(EW7J4)	GDS10192	Drive Shaft		25	24	58.5	89	655		
2.0 16V (100 kW)	2001.06-	2004.08			F	Estate Engine RFN(EW10J4)	GC045038	Outer Joint		25	34	58.5	89	55	I	
	2001.06-	2004.08	MT	L	F	Estate Engine RFN(EW10J4)	GDS45140	Drive Shaft		25	24	58.5	89	650		
	2001.06-	2004.08	MT	L	F	Estate Engine RFN(EW10J4)	GDS10142	Drive Shaft		25	24	58.5	89	648		
	2001.06-	2004.08	MT	R	F	Estate Engine RFN(EW10J4)	GDS10143	Drive Shaft		25	24	58.5	89	936		
	2001.06-	2004.08	MT			Estate Engine RFN(EW10J4)	GC045041	Outer Joint	48T	25	34	58.5	89	55	I	
2.0 16V HPi (103 kW)	2001.06-	2004.08			F	Estate Engine RLZ(EW10D)	GC045038	Outer Joint		25	34	58.5	89	55	I	
	2001.06-	2004.08	MT	L	F	Estate Engine RLZ(EW10D)	GDS45140	Drive Shaft		25	24	58.5	89	650		
	2001.06-	2004.08	MT	L	F	Estate Engine RLZ(EW10D)	GDS10142	Drive Shaft		25	24	58.5	89	648		
	2001.06-	2004.08	MT	R	F	Estate Engine RLZ(EW10D)	GDS10143	Drive Shaft		25	24	58.5	89	936		
	2001.06-	2004.08	MT			Estate Engine RLZ(EW10D)	GC045041	Outer Joint	48T	25	34	58.5	89	55	I	
2.0 HDi (66 kW)	2001.06-	2004.08		L	F	Estate Engine RHY(DW10TD)	GDS10142	Drive Shaft		25	24	58.5	89	648		
	2001.06-	2004.08	MT	L	F	Estate Engine RHY(DW10TD)	GDS45140	Drive Shaft		25	24	58.5	89	650		
	2001.06-	2004.08		R	F	Estate Engine RHY(DW10TD)	GDS10143	Drive Shaft		25	24	58.5	89	936		
	2001.06-	2004.08	MT	R	F	Estate Engine RHY(DW10TD)	GDS99189	Drive Shaft		25	24	58.5	89	936		
	2001.06-	2004.08				Estate Engine RHY(DW10TD)	GC045041	Outer Joint	48T	25	34	58.5	89	55	I	
2.0 HDi (79 kW)	2001.06-	2004.08	MT	L	F	Estate Engine RHS(DW10ATED)/RHZ(DW10ATED)	GDS99172	Drive Shaft		25	37	58.5	89	623		
	2001.06-	2004.08	MT	L	F	Estate Engine RHS(DW10ATED)/RHZ(DW10ATED)	GDS10121	Drive Shaft		25	37	58.5	89	628		
	2001.06-	2004.08	MT	R	F	Estate Engine RHS(DW10ATED)/RHZ(DW10ATED)	GDS10140	Drive Shaft		25	37	58.5	89	948		
	2001.06-	2004.08	AT			Estate Engine RHS(DW10ATED)/RHZ(DW10ATED)	GC045041	Outer Joint	48T	25	34	58.5	89	55	I	
	2001.06-	2004.08	AT			Estate Engine RHS(DW10ATED)/RHZ(DW10ATED)	GDS99172	Drive Shaft		25	37	58.5	89	623		
2.0 HDi (80 kW)	2001.06-	2004.08	MT	L	F	Estate Engine RHZ(DW10ATED)	GDS99172	Drive Shaft		25	37	58.5	89	623		
	2001.06-	2004.08	AT			Estate Engine RHZ(DW10ATED)	GC045041	Outer Joint	48T	25	34	58.5	89	55	I	
	2001.06-	2004.08			F	Estate Engine 4HX(DW12TED4/FAP)	GC010075	Outer Joint		25	26	58.5	89	63	M	
	2001.06-	2004.08	MT		F	Estate Engine 4HX(DW12TED4/FAP)	GC045038	Outer Joint		25	34	58.5	89	55	I	
	2001.06-	2004.08	AT	L	F	Estate Engine 4HX(DW12TED4/FAP)	GDS10344	Drive Shaft		25	37	58.5	89	607		
	2001.06-	2004.08	AT	L	F	Estate Engine 4HX(DW12TED4/FAP)	GDS10207	Drive Shaft		25	37	58.5	89	602		
	2001.06-	2004.08	MT	L	F	Estate Engine 4HX(DW12TED4/FAP)	GDS10121	Drive Shaft		25	37	58.5	89	628		
	2001.06-	2004.08	AT	R	F	Estate Engine 4HX(DW12TED4/FAP)	GDS10208	Drive Shaft		25	37	58.5	89	908		
3.0 V6 (152 kW)	2001.06-	2004.08			F	Estate Engine 4HX(DW12TED4/FAP)	GDS10140	Drive Shaft		25	37	58.5	89	948		
	2001.06-	2004.08			F	Estate Engine XFX(ES9J4S)	GC010075	Outer Joint		25	26	58.5	89	63	M	
	2001.06-	2004.08	AT	L	F	Estate Engine XFX(ES9J4S)	GDS10344	Drive Shaft		25	37	58.5	89	607		
	2001.06-	2004.08	MT	L	F	Estate Engine XFX(ES9J4S)	GDS10141	Drive Shaft		25	37	58.5	89	638		
	2001.06-	2004.08	MT	R	F	Estate Engine XFX(ES9J4S)	GDS10139	Drive Shaft		25	37	58.5	89	944		
<b>C5 II (RC_)</b>																
1.6 HDi (80 kW)	2004.09-	2007.06	MT		F	Hatchback Engine 9HY(DV6TED4)	GC045038	Outer Joint		25	34	58.5	89	55	I	
	2004.09-	2007.06		L	F	Hatchback Engine 9HY(DV6TED4)	GDS10142	Drive Shaft		25	24	58.5	89	648		
	2004.09-	2007.06	MT	L	F	Hatchback Engine 9HY(DV6TED4)	GDS45140	Drive Shaft		25	24	58.5	89	650		
	2004.09-	2007.06		R	F	Hatchback Engine 9HY(DV6TED4)	GDS10143	Drive Shaft		25	24	58.5	89	936		
	2004.09-	2007.06	MT	R	F	Hatchback Engine 9HY(DV6TED4)	GDS99189	Drive Shaft		25	24	58.5	89	936		



		TRANSM	L/R	F/R		G-AP Ref.	PRODUCT	ABS	Technical Specifications									
									YEAR	A	B	C	H	L	P			
<b>CITROEN</b>																		
<b>C5 II (RC_)</b>																		
1.6 HDi (80 kW)	2004.09-	2007.06			Hatchback Engine 9HY(DV6TED4)	GCO45041	Outer Joint	48T	25	34	58.5	89	55	I				
1.8 16V (85 kW)	2004.09-	2005.10		F	Hatchback Engine 6FZ(EW7J4)	GCO45038	Outer Joint		25	34	58.5	89	55	I				
	2004.09-	2005.10		L	F	Hatchback Engine 6FZ(EW7J4)	GDS10192	Drive Shaft	25	24	58.5	89	655					
	2004.09-	2005.10	MT	L	F	Hatchback Engine 6FZ(EW7J4)	GDS45140	Drive Shaft	25	24	58.5	89	650					
	2004.09-	2005.10		R	F	Hatchback Engine 6FZ(EW7J4)	GDS10143	Drive Shaft	25	24	58.5	89	936					
	2004.09-	2005.10	MT	R	F	Hatchback Engine 6FZ(EW7J4)	GDS99189	Drive Shaft	25	24	58.5	89	936					
	2004.09-	2005.10				Hatchback Engine 6FZ(EW7J4)	GCO45041	Outer Joint	48T	25	34	58.5	89	55	I			
1.8 16V (92 kW)	2005.10-	2007.06		F	Hatchback Engine 6FY-EW7A	GCO45038	Outer Joint		25	34	58.5	89	55	I				
	2005.10-	2007.06		L	F	Hatchback Engine 6FY-EW7A	GDS10192	Drive Shaft	25	24	58.5	89	655					
	2005.10-	2007.06		R	F	Hatchback Engine 6FY-EW7A	GDS10143	Drive Shaft	25	24	58.5	89	936					
2.0 16V (103 kW)	2004.09-			F	Hatchback Engine RFJ(EW10A)	GCO45038	Outer Joint		25	34	58.5	89	55	I				
	2004.09-		MT	L	F	Hatchback Engine RFJ(EW10A)	GDS10142	Drive Shaft	25	24	58.5	89	648					
	2004.09-		MT	R	F	Hatchback Engine RFJ(EW10A)	GDS10143	Drive Shaft	25	24	58.5	89	936					
2.0 HDi (100 kW)	2007.12-			F	Hatchback Engine RHR(DW10BTED4)	GCO10096	Outer Joint		25	26	58.5	89	61.5	M				
	2007.12-		MT	R	F	Hatchback Engine RHR(DW10BTED4)	GDS99197	Drive Shaft	25	37	58.5	89	947					
	2007.12-		AT	L	F	Hatchback Engine RHR(DW10BTED4)	GDS10344	Drive Shaft	25	37	58.5	89	607					
	2007.12-		MT	L	F	Hatchback Engine RHR(DW10BTED4)	GDS99172	Drive Shaft	25	37	58.5	89	623					
	2007.12-		AT	R	F	Hatchback Engine RHR(DW10BTED4)	GDS10348	Drive Shaft	25	37	58.5	89	927					
	2007.12-		AT	R	F	Hatchback Engine RHR(DW10BTED4)	GCI10090	Inner Joint	37	26	31.5	379.5	112					
	2007.12-		AT	R	F	Hatchback Engine RHR(DW10BTED4)	GCO10096	Outer Joint	25	26	58.5	89	61.5	M				
2.2 HDi (125 kW)	2006.08-		MT	L	F	Hatchback Engine 4HT(DW12BTED4)	GDS10312	Drive Shaft	25	37	58.5	89	625					
	2006.08-		MT	R	F	Hatchback Engine 4HT(DW12BTED4)	GDS10313	Drive Shaft	25	37	58.5	89	950					
	2006.08-		AT	L	F	Hatchback Engine 4HT(DW12BTED4)	GDS10344	Drive Shaft	25	37	58.5	89	607					
2.2 HDi (98 kW)	2004.09-		MT	L	F	Hatchback Engine 4HX(DW12TED4/FAP)	GDS10312	Drive Shaft	25	37	58.5	89	625					
	2004.09-		MT	R	F	Hatchback Engine 4HX(DW12TED4/FAP)	GDS10313	Drive Shaft	25	37	58.5	89	950					
3.0 V6 (152 kW)	2004.09-		AT	L	F	Hatchback Engine XFV(ES9A)/XFV(ES9J4S)/XFU(ES9A)	GDS10381	Drive Shaft	25	37	58.5	89	595					
	2004.09-		AT	R	F	Hatchback Engine XFV(ES9A)/XFV(ES9J4S)/XFU(ES9A)	GDS10382	Drive Shaft	25	37	58.5	89	929					
<b>C5 II BREAK (RE_)</b>																		
1.6 HDi (80 kW)	2004.09-	2007.06	MT		F	Estate Engine 9HY(DV6TED4)/9HZ(DV6TED4)	GCO45038	Outer Joint	25	34	58.5	89	55	I				
	2004.09-	2007.06		L	F	Estate Engine 9HY(DV6TED4)/9HZ(DV6TED4)	GDS10142	Drive Shaft	25	24	58.5	89	648					
	2004.09-	2007.06	MT	L	F	Estate Engine 9HY(DV6TED4)/9HZ(DV6TED4)	GDS45140	Drive Shaft	25	24	58.5	89	650					
	2004.09-	2007.06		R	F	Estate Engine 9HY(DV6TED4)/9HZ(DV6TED4)	GDS10143	Drive Shaft	25	24	58.5	89	936					
	2004.09-	2007.06	MT	R	F	Estate Engine 9HY(DV6TED4)/9HZ(DV6TED4)	GDS99189	Drive Shaft	25	24	58.5	89	936					
1.8 16V (85 kW)	2004.09-				F	Estate Engine 6FZ(EW7J4)	GCO45038	Outer Joint	25	34	58.5	89	55	I				
	2004.09-		MT	L	F	Estate Engine 6FZ(EW7J4)	GDS45140	Drive Shaft	25	24	58.5	89	650					
	2004.09-		MT	R	F	Estate Engine 6FZ(EW7J4)	GDS99189	Drive Shaft	25	24	58.5	89	936					
	2004.09-					Estate Engine 6FZ(EW7J4)	GCO45041	Outer Joint	48T	25	34	58.5	89	55	I			
1.8 16V (92 kW)	2005.10-	2006.11		F	Estate Engine 6FY-EW7A	GCO45038	Outer Joint		25	34	58.5	89	55	I				
2.0 16V (103 kW)	2004.09-			F	Estate Engine RFJ(EW10A)	GCO45038	Outer Joint		25	34	58.5	89	55	I				
	2004.09-		MT	L	F	Estate Engine RFJ(EW10A)	GDS10142	Drive Shaft	25	24	58.5	89	648					
	2004.09-		MT	R	F	Estate Engine RFJ(EW10A)	GDS10143	Drive Shaft	25	24	58.5	89	936					
	2004.09-		MT	L	F	Estate Engine RFJ(EW10A)	GDS99172	Drive Shaft	25	37	58.5	89	623					
2.0 HDi (100 kW)	2004.09-			F	Estate Engine RHR(DW10BTED4)	GCO10096	Outer Joint		25	26	58.5	89	61.5	M				
	2004.09-		MT	R	F	Estate Engine RHR(DW10BTED4)	GDS99197	Drive Shaft	25	37	58.5	89	947					
	2004.09-		AT	L	F	Estate Engine RHR(DW10BTED4)	GDS10381	Drive Shaft	25	37	58.5	89	595					
	2004.09-		AT	R	F	Estate Engine RHR(DW10BTED4)	GDS10348	Drive Shaft	25	37	58.5	89	927					
	2004.09-		AT	R	F	Estate Engine RHR(DW10BTED4)	GCI10090	Inner Joint	37	26	31.5	379.5	112					
	2004.09-		AT	R	F	Estate Engine RHR(DW10BTED4)	GCO10096	Outer Joint	25	26	58.5	89	61.5	M				
2.2 HDi (120 kW)	2006.05-		AT	L	F	Estate Engine 4HR (DW12BTED4)/4HP (DW12BTED4)	GDS10344	Drive Shaft	25	37	58.5	89	607					
2.2 HDi (125 kW)	2006.08-		MT	L	F	Estate Engine 4HT(DW12BTED4)	GDS10312	Drive Shaft	25	37	58.5	89	625					
	2006.08-		MT	R	F	Estate Engine 4HT(DW12BTED4)	GDS10313	Drive Shaft	25	37	58.5	89	950					
	2006.08-		AT	L	F	Estate Engine 4HT(DW12BTED4)	GDS10344	Drive Shaft	25	37	58.5	89	607					
2.2 HDi (98 kW)	2004.09-		MT	L	F	Estate Engine 4HX(DW12TED4/FAP)	GDS10312	Drive Shaft	25	37	58.5	89	625					
	2004.09-		MT	R	F	Estate Engine 4HX(DW12TED4/FAP)	GDS10313	Drive Shaft	25	37	58.5	89	950					
3.0 (173 kW)	2004.09-		AT	L	F	Estate	GDS10381	Drive Shaft	25	37	58.5	89	595					
	2004.09-		AT	R	F	Estate	GDS10382	Drive Shaft	25	37	58.5	89	929					
3.0 V6 (152 kW)	2004.09-	2006.11	AT	L	F	Estate Engine XFV(ES9A)	GDS10381	Drive Shaft	25	37	58.5	89	595					
	2004.09-	2006.11	AT	R	F	Estate Engine XFV(ES9A)	GDS10382	Drive Shaft	25	37	58.5	89	929					
3.0 V6 (155 kW)	2004.10-	2007.04	AT	L	F	Estate Engine XFU (ES9A)	GDS10344	Drive Shaft	25	37	58.5	89	607					
	2004.10-	2007.04	AT	R	F	Estate Engine XFU (ES9A)	GDS10382	Drive Shaft	25	37	58.5	89	929					





	 YEAR	TRANSM	L/R	F/R		G-AP Ref.	PRODUCT	ABS	Technical Specifications									
									A	B	C	H	L	P				
<b>CITROEN</b>																		
<b>C5 III (RD_)</b>																		
1.6 HDi (80 kW)	2008.02-			F	Saloon Engine 9HZ(DV6TED4)	GC010052	Outer Joint		28	34	58.5	92	55	I				
	2008.02-	5MT	L	F	Saloon Engine 9HZ(DV6TED4)	GDS10310	Drive Shaft		28	24	59	91	670					
	2008.02-	5MT	R	F	Saloon Engine 9HZ(DV6TED4)	GDS10265	Drive Shaft		28	24	59	91	951					
	2008.02-	5MT	L	F	Saloon Engine 9HZ(DV6TED4)	GCI45018	Inner Joint		24	34	40	62	88					
1.6 HDi (82 kW)	2010.07-			F	Saloon Engine 9HR(DV6C)	GC010052	Outer Joint		28	34	58.5	92	55	I				
1.8 16V (92 kW)	2008.02-			F	Saloon Engine 6FY(EW7A)	GC045038	Outer Joint		25	34	58.5	89	55	I				
	2008.02-	5MT	L	F	Saloon Engine 6FY(EW7A)	GDS10310	Drive Shaft		28	24	59	91	670					
	2008.02-	5MT	R	F	Saloon Engine 6FY(EW7A)	GDS10265	Drive Shaft		28	24	59	91	951					
	2008.02-	5MT	L	F	Saloon Engine 6FY(EW7A)	GCI45018	Inner Joint		24	34	40	62	88					
2.0 16V (103 kW)	2008.02-			F	Saloon Engine RFJ(EW10A)	GC010052	Outer Joint		28	34	58.5	92	55	I				
	2008.02-	5MT	L	F	Saloon Engine RFJ(EW10A)	GDS10310	Drive Shaft		28	24	59	91	670					
	2008.02-	5MT	R	F	Saloon Engine RFJ(EW10A)	GDS10265	Drive Shaft		28	24	59	91	951					
	2008.02-	5MT	L	F	Saloon Engine RFJ(EW10A)	GCI45018	Inner Joint		24	34	40	62	88					
	2008.02-	AT	L	F	Saloon Engine RFJ(EW10A)	GDS10285	Drive Shaft		28	26	58.5	92	661					
	2008.02-	AT	R	F	Saloon Engine RFJ(EW10A)	GDS10283	Drive Shaft		28	26	58.5	92	866					
2.0 HDi (100 kW)	2008.02-			F	Saloon Engine RHF(DW10BTED4)/RHR(DW10BTED4)	GC010098	Outer Joint		28	39	58.6	93	63	I				
	2008.02-		L	F	Saloon Engine RHF(DW10BTED4)/RHR(DW10BTED4)	GDS10001	Drive Shaft		21	22	48	86.5	636					
	2008.02-	6AT	L	F	Saloon Engine RHF(DW10BTED4)/RHR(DW10BTED4)	GDS10335	Drive Shaft		28	37	58.5	92.5	618					
	2008.02-	6AT	L	F	Saloon Engine RHF(DW10BTED4)/RHR(DW10BTED4)	GCI10043	Inner Joint		37	26	40.5	67.5	104					
	2008.02-	MT	L	F	Saloon Engine RHF(DW10BTED4)/RHR(DW10BTED4)	GDS45133	Drive Shaft		28	37	58.6	94	653					
	2008.02-	AT	R	F	Saloon Engine RHF(DW10BTED4)/RHR(DW10BTED4)	GDS10384	Drive Shaft		28	37	59	91	960					
	2008.02-	MT	R	F	Saloon Engine RHF(DW10BTED4)/RHR(DW10BTED4)	GDS99214	Drive Shaft		28	37	58.6	94	978					
	2008.02-	MT	R	F	Saloon Engine RHF(DW10BTED4)/RHR(DW10BTED4)	GCI10041	Inner Joint		37	39	32	399	95.5					
	2008.02-	MT	R	F	Saloon Engine RHF(DW10BTED4)/RHR(DW10BTED4)	GC010115	Outer Joint		28	26	58.5	92.5	61.5	M				
2.0 HDi (103 kW)	2009.04-	AT	L	F	Saloon Engine RHF(DW10BTED4)	GDS10335	Drive Shaft		28	37	58.5	92.5	618					
	2009.04-	AT	L	F	Saloon Engine RHF(DW10BTED4)	GCI10043	Inner Joint		37	26	40.5	67.5	104					
	2009.04-	MT	L	F	Saloon Engine RHF(DW10BTED4)	GDS45133	Drive Shaft		28	37	58.6	94	653					
	2009.04-	AT	R	F	Saloon Engine RHF(DW10BTED4)	GDS10384	Drive Shaft		28	37	59	91	960					
	2009.04-	MT	R	F	Saloon Engine RHF(DW10BTED4)	GDS99214	Drive Shaft		28	37	58.6	94	978					
	2009.04-	MT	R	F	Saloon Engine RHF(DW10BTED4)	GCI10041	Inner Joint		37	39	32	399	95.5					
	2009.04-	MT	R	F	Saloon Engine RHF(DW10BTED4)	GC010115	Outer Joint		28	26	58.5	92.5	61.5	M				
	2009.04-	MT			Saloon Engine RHF(DW10BTED4)	GC045074	Outer Joint		28	26	59	91	61.5	M				
	2009.04-	MT	L	F	Saloon Engine RHH(DW10CTED4)	GDS45133	Drive Shaft		28	37	58.6	94	653					
2.0 HDi (120 kW)	2009.04-	AT	R	F	Saloon Engine RHH(DW10CTED4)	GDS10384	Drive Shaft		28	37	59	91	960					
	2009.04-	MT	R	F	Saloon Engine RHH(DW10CTED4)	GDS99214	Drive Shaft		28	37	58.6	94	978					
	2009.04-	MT	R	F	Saloon Engine RHH(DW10CTED4)	GCI10041	Inner Joint		37	39	32	399	95.5					
	2009.04-	MT	R	F	Saloon Engine RHH(DW10CTED4)	GC010159	Outer Joint		28	39	58.6	94	63	I				
	2009.04-	MT			Saloon Engine RHH(DW10CTED4)	GC045074	Outer Joint		28	26	59	91	61.5	M				
	2009.04-	MT	L	F	Saloon Engine RHH(DW10CTED4)	GDS45133	Drive Shaft		28	37	58.6	94	653					
2.2 HDi (125 kW)	2008.02-	6MT	L	F	Saloon Engine 4HT(DW12BTED4)	GDS10314	Drive Shaft		28	37	59	91	655					
	2008.02-	6MT	R	F	Saloon Engine 4HT(DW12BTED4)	GDS10320	Drive Shaft		28	37	59	91	980					
2.7 HDi (150 kW)	2008.02-		L	F	Saloon Engine DT17ED4	GDS10335	Drive Shaft		28	37	58.5	92.5	618					
	2008.02-		L	F	Saloon Engine DT17ED4	GCI10043	Inner Joint		37	26	40.5	67.5	104					
	2008.02-	AT	R	F	Saloon Engine DT17ED4	GDS10396	Drive Shaft		28	37	58.6	94	925					
3.0 HDi (177 kW)	2009.04-	AT	R	F	Saloon Engine DT20C	GDS10384	Drive Shaft		28	37	59	91	960					
3.0 V6 (155 kW)	2008.02-		L	F	Saloon Engine XFU(ES9A)	GDS10335	Drive Shaft		28	37	58.5	92.5	618					
	2008.02-		L	F	Saloon Engine XFU(ES9A)	GCI10043	Inner Joint		37	26	40.5	67.5	104					
<b>C5 III BREAK (TD_)</b>																		
1.6 HDi (80 kW)	2008.02-			F	Estate Engine 9HZ(DV6TED4)	GC010052	Outer Joint		28	34	58.5	92	55	I				
	2008.02-		L	F	Estate Engine 9HZ(DV6TED4)	GDS10310	Drive Shaft		28	24	59	91	670					
	2008.02-		R	F	Estate Engine 9HZ(DV6TED4)	GDS10265	Drive Shaft		28	24	59	91	951					
	2008.02-		L	F	Estate Engine 9HZ(DV6TED4)	GCI45018	Inner Joint		24	34	40	62	88					
1.6 HDi (82 kW)	2010.07-			F	Estate Engine 9HR(DV6C)	GC010052	Outer Joint		28	34	58.5	92	55	I				
1.8 16V (92 kW)	2008.02-			F	Estate Engine 6FY(EW7A)	GC045038	Outer Joint		25	34	58.5	89	55	I				
	2008.02-			F	Estate Engine RFJ(EW10A)	GC010052	Outer Joint		28	34	58.5	92	55	I				
2.0 16V (103 kW)	2008.02-	5MT	L	F	Estate Engine RFJ(EW10A)	GDS10310	Drive Shaft		28	24	59	91	670					
	2008.02-	5MT	R	F	Estate Engine RFJ(EW10A)	GDS10265	Drive Shaft		28	24	59	91	951					
	2008.02-	5MT	L	F	Estate Engine RFJ(EW10A)	GCI45018	Inner Joint		24	34	40	62	88					
	2008.02-	AT	L	F	Estate Engine RFJ(EW10A)	GDS10285	Drive Shaft		28	26	58.5	92	661					
	2008.02-	AT	R	F	Estate Engine RFJ(EW10A)	GDS10283	Drive Shaft		28	26	58.5	92	866					
	2008.02-	AT	R	F	Estate Engine RFJ(EW10A)	GDS10283	Drive Shaft		28	26	58.5	92	866					
2.0 HDi (100 kW)	2008.02-			F	Estate Engine RHR(DW10BTED4)	GC010098	Outer Joint		28	39	58.6	93	63	I				
	2008.02-	6AT	L	F	Estate Engine RHR(DW10BTED4)	GDS10335	Drive Shaft		28	37	58.5	92.5	618					









		TRANSM	L/R	F/R		G-AP Ref.	PRODUCT	ABS	Technical Specifications									
									YEAR	A	B	C	H	L	P			
<b>CITROEN</b>																		
<b>C5 III BREAK (TD_)</b>																		
2.0 HDi (100 kW)	2008.02-		6AT	L	F	Estate Engine RHR(DW10BTED4)	GCI10043	Inner Joint		37	26	40.5	67.5	104				
	2008.02-		MT	L	F	Estate Engine RHR(DW10BTED4)	GDS45133	Drive Shaft		28	37	58.6	94	653				
	2008.02-		AT	R	F	Estate Engine RHR(DW10BTED4)	GDS10384	Drive Shaft		28	37	59	91	960				
	2008.02-		MT	R	F	Estate Engine RHR(DW10BTED4)	GDS99214	Drive Shaft		28	37	58.6	94	978				
	2008.02-		MT	R	F	Estate Engine RHR(DW10BTED4)	GCI10041	Inner Joint		37	39	32	399	95.5				
	2008.02-		MT	R	F	Estate Engine RHR(DW10BTED4)	GC010115	Outer Joint		28	26	58.5	92.5	61.5	M			
	2008.02-		MT			Estate Engine RHR(DW10BTED4)	GC045074	Outer Joint		28	26	59	91	61.5	M			
2.0 HDi (103 kW)	2009.04-		AT	L	F	Estate Engine RHF(DW10BTED4)	GDS10335	Drive Shaft		28	37	58.5	92.5	618				
	2009.04-		AT	L	F	Estate Engine RHF(DW10BTED4)	GCI10043	Inner Joint		37	26	40.5	67.5	104				
	2009.04-		MT	L	F	Estate Engine RHF(DW10BTED4)	GDS45133	Drive Shaft		28	37	58.6	94	653				
	2009.04-		AT	R	F	Estate Engine RHF(DW10BTED4)	GDS10384	Drive Shaft		28	37	59	91	960				
	2009.04-		MT	R	F	Estate Engine RHF(DW10BTED4)	GDS99214	Drive Shaft		28	37	58.6	94	978				
	2009.04-		MT	R	F	Estate Engine RHF(DW10BTED4)	GCI10041	Inner Joint		37	39	32	399	95.5				
	2009.04-		MT	R	F	Estate Engine RHF(DW10BTED4)	GC010115	Outer Joint		28	26	58.5	92.5	61.5	M			
	2009.04-		MT			Estate Engine RHF(DW10BTED4)	GC045074	Outer Joint		28	26	59	91	61.5	M			
2.0 HDi (110 kW)	2009.04-		MT	L	F	Estate Engine RHE(DW10CTED4)	GDS45133	Drive Shaft		28	37	58.6	94	653				
	2009.04-		AT	R	F	Estate Engine RHE(DW10CTED4)	GDS10384	Drive Shaft		28	37	59	91	960				
	2009.04-		MT	R	F	Estate Engine RHE(DW10CTED4)	GDS99214	Drive Shaft		28	37	58.6	94	978				
	2009.04-		MT	R	F	Estate Engine RHE(DW10CTED4)	GCI10041	Inner Joint		37	39	32	399	95.5				
	2009.04-		MT	R	F	Estate Engine RHE(DW10CTED4)	GC010159	Outer Joint		28	39	58.6	94	63	I			
	2009.04-		MT			Estate Engine RHE(DW10CTED4)	GC045074	Outer Joint		28	26	59	91	61.5	M			
2.0 HDi (120 kW)	2009.04-		MT	L	F	Estate Engine RHH(DW10CTED4)	GDS45133	Drive Shaft		28	37	58.6	94	653				
	2009.04-		AT	R	F	Estate Engine RHH(DW10CTED4)	GDS10384	Drive Shaft		28	37	59	91	960				
	2009.04-		MT	R	F	Estate Engine RHH(DW10CTED4)	GDS99214	Drive Shaft		28	37	58.6	94	978				
	2009.04-		MT	R	F	Estate Engine RHH(DW10CTED4)	GCI10041	Inner Joint		37	39	32	399	95.5				
	2009.04-		MT	R	F	Estate Engine RHH(DW10CTED4)	GC010159	Outer Joint		28	39	58.6	94	63	I			
	2009.04-		MT			Estate Engine RHH(DW10CTED4)	GC045074	Outer Joint		28	26	59	91	61.5	M			
2.2 HDi (120 kW)	2008.02-			L	F	Estate Engine 4HP(DW12BTED4)	GDS10314	Drive Shaft		28	37	59	91	655				
	2008.02-			R	F	Estate Engine 4HP(DW12BTED4)	GDS10320	Drive Shaft		28	37	59	91	980				
2.2 HDi (125 kW)	2008.02-		6MT	L	F	Estate Engine 4HT(DW12BTED4)	GDS10314	Drive Shaft		28	37	59	91	655				
	2008.02-		6MT	R	F	Estate Engine 4HT(DW12BTED4)	GDS10320	Drive Shaft		28	37	59	91	980				
	2008.02-		AT	R	F	Estate Engine 4HT(DW12BTED4)	GDS10384	Drive Shaft		28	37	59	91	960				
2.7 HDi (150 kW)	2008.02-			L	F	Estate Engine DT17ED4/UHZ(DT17BTED4)	GDS10335	Drive Shaft		28	37	58.5	92.5	618				
	2008.02-			L	F	Estate Engine DT17ED4/UHZ(DT17BTED4)	GCI10043	Inner Joint		37	26	40.5	67.5	104				
3.0 HDi (177 kW)	2009.04-		AT	R	F	Estate Engine DT20C	GDS10384	Drive Shaft		28	37	59	91	960				
3.0 V6 (155 kW)	2008.02-			L	F	Estate Engine XFU(ES9A)	GDS10335	Drive Shaft		28	37	58.5	92.5	618				
	2008.02-			L	F	Estate Engine XFU(ES9A)	GCI10043	Inner Joint		37	26	40.5	67.5	104				
<b>C6 (TD_)</b>																		
2.2 HDi (120 kW)	2006.06-		MT	L	F	Estate Engine 4HP(DW12BTED4)	GDS10314	Drive Shaft		28	37	59	91	655				
	2006.06-		MT	R	F	Estate Engine 4HP(DW12BTED4)	GDS10320	Drive Shaft		28	37	59	91	980				
2.2 HDi (125 kW)	2006.11-			L	F	Saloon Engine 4HT(DW12BTED4)	GDS10314	Drive Shaft		28	37	59	91	655				
	2006.11-			R	F	Saloon Engine 4HT(DW12BTED4)	GDS10320	Drive Shaft		28	37	59	91	980				
2.7 HDi (150 kW)	2006.02-			L	F	Saloon Engine DT17ED4/UHZ(DT17BTED4)	GDS10335	Drive Shaft		28	37	58.5	92.5	618				
	2006.02-			L	F	Saloon Engine DT17ED4/UHZ(DT17BTED4)	GCI10043	Inner Joint		37	26	40.5	67.5	104				
3.0 V6 (155 kW)	2006.02-			L	F	Saloon Engine Xfv(ES9J4S)/Xfv(ES9A)	GDS10335	Drive Shaft		28	37	58.5	92.5	618				
	2006.02-			L	F	Saloon Engine Xfv(ES9J4S)/Xfv(ES9A)	GCI10043	Inner Joint		37	26	40.5	67.5	104				
<b>C8 (EA, EB)</b>																		
2.0 HDi (100 kW)	2006.03-		MT				GC017044	Outer Joint		27	28	58	81.5	62	M			
2.0 HDi (79 kW)	2002.07-						GC017044	Outer Joint		27	28	58	81.5	62	M			
2.0 HDi (88 kW)	2006.03-		MT				GC017044	Outer Joint		27	28	58	81.5	62	M			
2.2 (116 kW)	2002.07-		MT				GC017044	Outer Joint		27	28	58	81.5	62	M			
<b>C8 (EA_, EB_)</b>																		
2.0 (100 kW)	2002.07-		MT	L	F	MPV Engine RFN(EW10J4)	GDS10422	Drive Shaft		27	24	58	81.5	659				
	2002.07-		AT	R	F	MPV Engine RFN(EW10J4)	GDS10425	Drive Shaft		27	26	59	82	855				
2.0 16V (103 kW)	2005.10-	2008.03	MT	L	F	MPV Engine RFJ(EW10A)	GDS10422	Drive Shaft		27	24	58	81.5	659				
	2005.10-	2008.03	AT	R	F	MPV Engine RFJ(EW10A)	GDS10425	Drive Shaft		27	26	59	82	855				
2.0 16V (104 kW)	2005.09-		MT	L	F	MPV Engine RFJ(EW10A)	GDS10422	Drive Shaft		27	24	58	81.5	659				
2.0 HDi (100 kW)	2006.07-	2008.03	MT	R	F	MPV Engine RHR(DW10BTED4)	GDS10313	Drive Shaft		25	37	58.5	89	950				
2.0 HDi (120 kW)	2006.03-		MT	R	F	MPV Engine RHE(DW10CTED4)/RHH(DW10CTED4)	GDS10313	Drive Shaft		25	37	58.5	89	950				
	2006.03-		MT	L	F	MPV Engine RHE(DW10CTED4)/RHH(DW10CTED4)	GDS10424	Drive Shaft		27	37	61.3	84	637				
2.0 HDi (79 kW)	2002.07-				F	MPV Engine RHM(DW10ATED4)/RHT(DW10ATED4)	GC017044	Outer Joint		27	28	58	81.5	62	M			
	2002.07-		AT	L	F	MPV Engine RHM(DW10ATED4)/RHT(DW10ATED4)	GDS10423	Drive Shaft		27	26	58	81.5	635				



	 YEAR	TRANSM	L/R	F/R		G-AP Ref.	PRODUCT	ABS	Technical Specifications									
									A	B	C	H	L	P				
<b>CITROEN</b> <b>C8 (EA_, EB_)</b>																		
2.0 HDi (79 kW)	2002.07-	AT	R	F	MPV Engine RHM(DW10ATED4)/RHT(DW10ATED4)	GDS10425	Drive Shaft		27	26	59	82	855					
	2002.07-	MT	R	F	MPV Engine RHM(DW10ATED4)/RHT(DW10ATED4)	GDS18291	Drive Shaft		27	37	58	81	977					
2.2 (116 kW)	2002.07-	MT	R	F	MPV Engine 3FZ(EW12J4)	GDS18291	Drive Shaft		27	37	58	81	977					
2.2 HDi (120 kW)	2007.06-	MT	L	F	MPV Engine 4HP(DW12BTED4)/4HR(DW12BTED4)	GDS10424	Drive Shaft		27	37	61.3	84	637					
2.2 HDi (125 kW)	2006.06-	MT	L	F	MPV Engine 4HT(DW12BTED4)	GDS10424	Drive Shaft		27	37	61.3	84	637					
2.2 HDi (94 kW)	2002.07-			F	MPV Engine 4HW(DW12TED4)	GC010052	Outer Joint		28	34	58.5	92	55	I				
	2002.07-	MT	R	F	MPV Engine 4HW(DW12TED4)	GDS18291	Drive Shaft		27	37	58	81	977					
<b>DISPATCH</b>																		
1.6 HDi (66 kW)	2007.01-	MT	R	F	Box Engine 9HU(DV6UTED4)	GDS10239	Drive Shaft		28	24	58.5	92	958					
	2007.01-	MT	R	F	MPV Engine 9HU(DV6UTED4)	GDS10239	Drive Shaft		28	24	58.5	92	958					
	2007.01-				Box Engine 9HU(DV6UTED4)	GC010124	Outer Joint		28	34	58.5	92	55	I				
	2007.01-				MPV Engine 9HU(DV6UTED4)	GC010124	Outer Joint		28	34	58.5	92	55	I				
1.6 HDi 8V (66 kW)	2007.01-				Box Engine 9HH(DV6DUM)/9HM(DV6UC)	GC010124	Outer Joint		28	34	58.5	92	55	I				
	2007.01-				MPV Engine 9HH(DV6DUM)/9HM(DV6UC)	GC010124	Outer Joint		28	34	58.5	92	55	I				
2.0 HDi (100 kW)	2007.01-			F	Box Engine RHR(DW10BTED4)	GC010098	Outer Joint		28	39	58.6	93	63	I				
	2007.01-			F	MPV Engine RHR(DW10BTED4)	GC010098	Outer Joint		28	39	58.6	93	63	I				
	2007.01-	MT	L	F	Box Engine RHR(DW10BTED4)	GDS45133	Drive Shaft		28	37	58.6	94	653					
	2007.01-	MT	L	F	MPV Engine RHR(DW10BTED4)	GDS45133	Drive Shaft		28	37	58.6	94	653					
	2007.01-		R	F	Box Engine RHR(DW10BTED4)	GDS99214	Drive Shaft		28	37	58.6	94	978					
	2007.01-		R	F	Box Engine RHR(DW10BTED4)	GCI10041	Inner Joint		37	39	32	399	95.5					
	2007.01-		R	F	Box Engine RHR(DW10BTED4)	GC010159	Outer Joint		28	39	58.6	94	63	I				
	2007.01-		R	F	MPV Engine RHR(DW10BTED4)	GDS99214	Drive Shaft		28	37	58.6	94	978					
	2007.01-		R	F	MPV Engine RHR(DW10BTED4)	GCI10041	Inner Joint		37	39	32	399	95.5					
	2007.01-		R	F	MPV Engine RHR(DW10BTED4)	GC010159	Outer Joint		28	39	58.6	94	63	I				
	2007.01-		R		Box Engine RHR(DW10BTED4)	GDS10244	Drive Shaft		28	37	58.6	93	979					
	2007.01-		R		MPV Engine RHR(DW10BTED4)	GDS10244	Drive Shaft		28	37	58.6	93	979					
2.0 HDi (120 kW)	2010.07-		R	F	MPV Engine RHH(DW10CTED4)	GDS99214	Drive Shaft		28	37	58.6	94	978					
	2010.07-		R	F	MPV Engine RHH(DW10CTED4)	GCI10041	Inner Joint		37	39	32	399	95.5					
	2010.07-		R	F	MPV Engine RHH(DW10CTED4)	GC010159	Outer Joint		28	39	58.6	94	63	I				
	2010.07-		F		Box Engine RHH(DW10CTED4)	GC010098	Outer Joint		28	39	58.6	93	63	I				
	2010.07-		F		MPV Engine RHH(DW10CTED4)	GC010098	Outer Joint		28	39	58.6	93	63	I				
	2010.07-	MT	L	F	Box Engine RHH(DW10CTED4)	GDS45133	Drive Shaft		28	37	58.6	94	653					
	2010.07-	MT	L	F	MPV Engine RHH(DW10CTED4)	GDS45133	Drive Shaft		28	37	58.6	94	653					
	2010.07-		R	F	Box Engine RHH(DW10CTED4)	GDS99214	Drive Shaft		28	37	58.6	94	978					
	2010.07-		R	F	Box Engine RHH(DW10CTED4)	GCI10041	Inner Joint		37	39	32	399	95.5					
	2010.07-		R	F	Box Engine RHH(DW10CTED4)	GC010159	Outer Joint		28	39	58.6	94	63	I				
2.0 HDi (72 kW)	2011.07-	MT	L	F	Box	GDS10234	Drive Shaft		28	37	58.6	93	648					
	2011.07-	MT	L	F	MPV	GDS45133	Drive Shaft		28	37	58.6	94	653					
	2011.07-		R	F	MPV	GDS99214	Drive Shaft		28	37	58.6	94	978					
	2011.07-		R	F	MPV	GCI10041	Inner Joint		37	39	32	399	95.5					
	2011.07-		R	F	MPV	GC010159	Outer Joint		28	39	58.6	94	63	I				
2.0 HDi (88 kW)	2007.01-			F	Box Engine RHK(DW10UTED4)	GC010098	Outer Joint		28	39	58.6	93	63	I				
	2007.01-			F	MPV Engine RHK(DW10UTED4)	GC010098	Outer Joint		28	39	58.6	93	63	I				
	2007.01-	MT	L	F	Box Engine RHK(DW10UTED4)	GDS45133	Drive Shaft		28	37	58.6	94	653					
	2007.01-	MT	L	F	MPV Engine RHK(DW10UTED4)	GDS45133	Drive Shaft		28	37	58.6	94	653					
	2007.01-		R	F	Box Engine RHK(DW10UTED4)	GDS99214	Drive Shaft		28	37	58.6	94	978					
	2007.01-		R	F	Box Engine RHK(DW10UTED4)	GCI10041	Inner Joint		37	39	32	399	95.5					
	2007.01-		R	F	Box Engine RHK(DW10UTED4)	GC010159	Outer Joint		28	39	58.6	94	63	I				
	2007.01-		R	F	MPV Engine RHK(DW10UTED4)	GDS99214	Drive Shaft		28	37	58.6	94	978					
	2007.01-		R	F	MPV Engine RHK(DW10UTED4)	GCI10041	Inner Joint		37	39	32	399	95.5					
	2007.01-		R	F	MPV Engine RHK(DW10UTED4)	GC010159	Outer Joint		28	39	58.6	94	63	I				
	2007.01-		R		Box Engine RHK(DW10UTED4)	GDS10244	Drive Shaft		28	37	58.6	93	979					
	2007.01-		R		MPV Engine RHK(DW10UTED4)	GDS10244	Drive Shaft		28	37	58.6	93	979					
2.0 HDi (94 kW)	2011.07-	MT	L	F	Box	GDS10234	Drive Shaft		28	37	58.6	93	648					
	2011.07-	MT	L	F	MPV	GDS45133	Drive Shaft		28	37	58.6	94	653					
	2011.07-		R	F	MPV	GDS99214	Drive Shaft		28	37	58.6	94	978					
	2011.07-		R	F	MPV	GCI10041	Inner Joint		37	39	32	399	95.5					
	2011.07-		R	F	MPV	GC010159	Outer Joint		28	39	58.6	94	63	I				
2.0 i (103 kW)	2007.01-	MT	R	F	Box Engine RFH(EW10A)	GDS10239	Drive Shaft		28	24	58.5	92	958					
	2007.01-	MT	R	F	MPV Engine RFH(EW10A)	GDS10239	Drive Shaft		28	24	58.5	92	958					
	2007.01-				Box Engine RFH(EW10A)	GC010124	Outer Joint		28	34	58.5	92	55	I				
	2007.01-				MPV Engine RFH(EW10A)	GC010124	Outer Joint		28	34	58.5	92	55	I				

		TRANSM	L/R	F/R		G-AP Ref.	PRODUCT	ABS	Technical Specifications							
									YEAR	A	B	C	H	L	P	
<b>CITROEN DISPATCH (U6U)</b>																
2.0 (100 kW)	2000.04-2006.12			F	MPV Engine RFN(EW10J4)	GCO10018	Outer Joint	48T	27	34	61	82	55	I		
	2000.04-2006.12	5MT	L	F	MPV Engine RFN(EW10J4)	GDS10082	Drive Shaft	48T	27	24	59	82	648			
	2000.04-2006.12	5MT	R	F	MPV Engine RFN(EW10J4)	GDS10120	Drive Shaft		27	24	59	82	928			
<b>DISPATCH VAN (BS_, BT_, BY_, BZ_)</b>																
2.0 HDi (80 kW)	2002.01-			F	Box Engine RHZ(DW10ATED)	GCO10015	Outer Joint	48T	27	39	59	82	63	I		
	2002.01-		L	F	Box Engine RHZ(DW10ATED)	GDS10264	Drive Shaft	48T	27	37	59	82	630			
	2002.01-		R	F	Box Engine RHZ(DW10ATED)	GDS10057	Drive Shaft		27	37	59	82	960			
	2002.01-		R	F	Box Engine RHZ(DW10ATED)	GDS45120	Drive Shaft	48T	27	37	59	82	960			
<b>DS3</b>																
1.4 VTi (70 kW)	2010.04-		L	F	Hatchback Engine 8FP(EP3)	GDS10311	Drive Shaft		21	22	48	86.5	647			
	2010.04-		R	F	Hatchback Engine 8FP(EP3)	GDS99271	Drive Shaft		21	22	48	86.5	858			
1.4 VTi (72 kW)	2009.11-	MT	L	F	Hatchback Engine 8FR(EP3)	GDS10340	Drive Shaft		21	22	49	86	655			
1.4 VTi LPG (70 kW)	2012.08-		L	F	Hatchback Engine 8FN(EP3)	GDS10311	Drive Shaft		21	22	48	86.5	647			
	2012.08-		R	F	Hatchback Engine 8FN(EP3)	GDS99271	Drive Shaft		21	22	48	86.5	858			
1.6 HDi (68 kW)	2009.11-	MT	L	F	Hatchback Engine 9HP(DV6DTEd)	GDS10309	Drive Shaft		21	24	48.3	86.5	641			
	2009.11-	MT			Hatchback Engine 9HP(DV6DTEd)	GC099366	Outer Joint		25	34	58.5	79	55	I		
1.6 HDi (69 kW)	2013.01-	MT	L	F	Convertible Engine 9HP(DV6DTEd)	GDS10309	Drive Shaft		21	24	48.3	86.5	641			
	2013.01-	MT			Convertible Engine 9HP(DV6DTEd)	GC099366	Outer Joint		25	34	58.5	79	55	I		
1.6 HDi (82 kW)	2009.11-		L	F	Hatchback Engine 5HR(DV6C)	GDS10253	Drive Shaft		25	24	58.5	79	626			
	2009.11-		L	F	Hatchback Engine 5HR(DV6C)	GCI10057	Inner Joint		24	34	40	52.5	90			
	2009.11-		L	F	Hatchback Engine 5HR(DV6C)	GC010148	Outer Joint		25	34	58.5	79	55.5	I		
	2009.11-	MT			Hatchback Engine 5HR(DV6C)	GC099366	Outer Joint		25	34	58.5	79	55	I		
1.6 HDi (84 kW)	2012.08-		L	F	Hatchback Engine 9HL(DV6C)	GDS10253	Drive Shaft		25	24	58.5	79	626			
	2012.08-		L	F	Hatchback Engine 9HL(DV6C)	GCI10057	Inner Joint		24	34	40	52.5	90			
	2012.08-		L	F	Hatchback Engine 9HL(DV6C)	GC010148	Outer Joint		25	34	58.5	79	55.5	I		
	2012.08-				Hatchback Engine 9HL(DV6C)	GC099366	Outer Joint		25	34	58.5	79	55	I		
1.6 HDi (85 kW)	2013.10-	MT	L	F	Hatchback Engine BHX(DV6FC)	GDS10253	Drive Shaft		25	24	58.5	79	626			
	2013.10-	MT	L	F	Hatchback Engine BHX(DV6FC)	GCI10057	Inner Joint		24	34	40	52.5	90			
	2013.10-	MT	L	F	Hatchback Engine BHX(DV6FC)	GC010148	Outer Joint		25	34	58.5	79	55.5	I		
1.6 HDi (88 kW)	2013.10-	MT	L	F	Hatchback Engine BHZ(DV6FC)	GDS10253	Drive Shaft		25	24	58.5	79	626			
	2013.10-	MT	L	F	Hatchback Engine BHZ(DV6FC)	GCI10057	Inner Joint		24	34	40	52.5	90			
	2013.10-	MT	L	F	Hatchback Engine BHZ(DV6FC)	GC010148	Outer Joint		25	34	58.5	79	55.5	I		
1.6 Racing (149 kW)	2011.02-		L	F	Hatchback Engine 5FU(EP6CDTX)	GDS10253	Drive Shaft		25	24	58.5	79	626			
	2011.02-		L	F	Hatchback Engine 5FU(EP6CDTX)	GCI10057	Inner Joint		24	34	40	52.5	90			
	2011.02-		L	F	Hatchback Engine 5FU(EP6CDTX)	GC010148	Outer Joint		25	34	58.5	79	55.5	I		
	2011.02-				Hatchback Engine 5FU(EP6CDTX)	GC099366	Outer Joint		25	34	58.5	79	55	I		
	2014.03-	MT	L	F	Convertible Engine 5FU(EP6CDTX)	GDS10253	Drive Shaft		25	24	58.5	79	626			
	2014.03-	MT	L	F	Convertible Engine 5FU(EP6CDTX)	GCI10057	Inner Joint		24	34	40	52.5	90			
	2014.03-	MT	L	F	Convertible Engine 5FU(EP6CDTX)	GC010148	Outer Joint		25	34	58.5	79	55.5	I		
1.6 Racing (152 kW)	2011.02-		L	F	Hatchback Engine 5FD(EP6DTS)	GDS10253	Drive Shaft		25	24	58.5	79	626			
	2011.02-		L	F	Hatchback Engine 5FD(EP6DTS)	GCI10057	Inner Joint		24	34	40	52.5	90			
	2011.02-		L	F	Hatchback Engine 5FD(EP6DTS)	GC010148	Outer Joint		25	34	58.5	79	55.5	I		
	2011.02-				Hatchback Engine 5FD(EP6DTS)	GC099366	Outer Joint		25	34	58.5	79	55	I		
1.6 THP (110 kW)	2010.01-		L	F	Hatchback Engine 5FX(EP6DT)	GDS10253	Drive Shaft		25	24	58.5	79	626			
	2010.01-		L	F	Hatchback Engine 5FX(EP6DT)	GCI10057	Inner Joint		24	34	40	52.5	90			
	2010.01-		L	F	Hatchback Engine 5FX(EP6DT)	GC010148	Outer Joint		25	34	58.5	79	55.5	I		
	2013.01-	MT	L	F	Convertible Engine 5FN(EP6DT)	GDS10253	Drive Shaft		25	24	58.5	79	626			
	2013.01-	MT	L	F	Convertible Engine 5FN(EP6DT)	GCI10057	Inner Joint		24	34	40	52.5	90			
	2013.01-	MT	L	F	Convertible Engine 5FN(EP6DT)	GC010148	Outer Joint		25	34	58.5	79	55.5	I		
1.6 THP (115 kW)	2010.04-		L	F	Hatchback Engine 5FR(EP6DT)	GDS10253	Drive Shaft		25	24	58.5	79	626			
	2010.04-		L	F	Hatchback Engine 5FR(EP6DT)	GCI10057	Inner Joint		24	34	40	52.5	90			
	2010.04-		L	F	Hatchback Engine 5FR(EP6DT)	GC010148	Outer Joint		25	34	58.5	79	55.5	I		
	2010.04-	MT			Hatchback Engine 5FR(EP6DT)	GC099366	Outer Joint		25	34	58.5	79	55	I		
	2013.01-		L	F	Convertible Engine 5FR(EP6DT)/5FV(EP6CDT)	GDS10253	Drive Shaft		25	24	58.5	79	626			
	2013.01-		L	F	Convertible Engine 5FR(EP6DT)/5FV(EP6CDT)	GCI10057	Inner Joint		24	34	40	52.5	90			
	2013.01-		L	F	Convertible Engine 5FR(EP6DT)/5FV(EP6CDT)	GC010148	Outer Joint		25	34	58.5	79	55.5	I		
	2013.01-	MT			Convertible Engine 5FR(EP6DT)/5FV(EP6CDT)	GC099366	Outer Joint		25	34	58.5	79	55	I		
1.6 VTi (88 kW)	2010.04-				Hatchback Engine 5FS(EP6C)	GC010097	Outer Joint		25	30	58.5	79.5	55	I		
	2013.01-	MT	L	F	Convertible Engine 5FS(EP6C)	GDS10340	Drive Shaft		21	22	49	86	655			
	2013.01-				Convertible Engine 5FS(EP6C)	GC010097	Outer Joint		25	30	58.5	79.5	55	I		
<b>DS4</b>																
1.6 HDi (68 kW)	2011.05-		R	F	Hatchback Engine 9HP(DV6DTEd)	GDS10251	Drive Shaft		25	24	58.5	79	935			









		TRANSM	L/R	F/R		G-AP Ref.	PRODUCT	ABS	Technical Specifications							
									YEAR	A	B	C	H	L	P	
<b>CITROEN DS4</b>																
1.6 HDi (81 kW)	2011.04-			L	F	Hatchback	GDS10253	Drive Shaft		25	24	58.5	79	626		
	2011.04-			L	F	Hatchback	GCI10057	Inner Joint		24	34	40	52.5	90		
	2011.04-			L/R	F	Hatchback	GC010148	Outer Joint		25	34	58.5	79	55.5	I	
	2011.04-			R	F	Hatchback	GDS10325	Drive Shaft		25	24	58.5	79	940		
	2011.04-			R	F	Hatchback	GCI10058	Inner Joint		24	34	29.8	365	88		
	2011.04-		6MT			Hatchback	GC010155	Outer Joint		25	39	58.5	89	63.5	I	
1.6 HDi (82 kW)	2011.04-			L	F	Hatchback Engine 9HR(DV6C)	GDS10253	Drive Shaft		25	24	58.5	79	626		
	2011.04-			L	F	Hatchback Engine 9HR(DV6C)	GCI10057	Inner Joint		24	34	40	52.5	90		
	2011.04-			L/R	F	Hatchback Engine 9HR(DV6C)	GC010148	Outer Joint		25	34	58.5	79	55.5	I	
	2011.04-			R	F	Hatchback Engine 9HR(DV6C)	GDS10325	Drive Shaft		25	24	58.5	79	940		
	2011.04-			R	F	Hatchback Engine 9HR(DV6C)	GCI10058	Inner Joint		24	34	29.8	365	88		
	2011.04-		6MT			Hatchback Engine 9HR(DV6C)	GC010155	Outer Joint		25	39	58.5	89	63.5	I	
1.6 HDi (84 kW)	2012.08-		MT	L	F	Hatchback Engine 9HL(DV6C)	GDS10253	Drive Shaft		25	24	58.5	79	626		
	2012.08-		MT	L	F	Hatchback Engine 9HL(DV6C)	GCI10057	Inner Joint		24	34	40	52.5	90		
	2012.08-		MT	L/R	F	Hatchback Engine 9HL(DV6C)	GC010148	Outer Joint		25	34	58.5	79	55.5	I	
	2012.08-		MT	R	F	Hatchback Engine 9HL(DV6C)	GDS10325	Drive Shaft		25	24	58.5	79	940		
	2012.08-		MT	R	F	Hatchback Engine 9HL(DV6C)	GCI10058	Inner Joint		24	34	29.8	365	88		
1.6 THP (115 kW)	2011.04-			L	F	Hatchback Engine 5FV(EP6CDT)	GDS10253	Drive Shaft		25	24	58.5	79	626		
	2011.04-			L	F	Hatchback Engine 5FV(EP6CDT)	GCI10057	Inner Joint		24	34	40	52.5	90		
	2011.04-			L/R	F	Hatchback Engine 5FV(EP6CDT)	GC010148	Outer Joint		25	34	58.5	79	55.5	I	
	2011.04-			R	F	Hatchback Engine 5FV(EP6CDT)	GDS10325	Drive Shaft		25	24	58.5	79	940		
	2011.04-			R	F	Hatchback Engine 5FV(EP6CDT)	GCI10058	Inner Joint		24	34	29.8	365	88		
	2011.04-		6MT			Hatchback Engine 5FV(EP6CDT)	GC010155	Outer Joint		25	39	58.5	89	63.5	I	
	2011.04-		MT/6MT			Hatchback Engine 5FV(EP6CDT)	GC099366	Outer Joint		25	34	58.5	79	55	I	
1.6 THP (147 kW)	2011.04-		6MT		Hatchback Engine 5FU(EP6DTX)	GC010155	Outer Joint		25	39	58.5	89	63.5	I		
1.6 VTi (88 kW)	2011.04-			R	F	Hatchback Engine 5FS(EP6C)	GDS10251	Drive Shaft		25	24	58.5	79	935		
	2011.04-		6AT			Hatchback Engine 5FS(EP6C)	GC099366	Outer Joint		25	34	58.5	79	55	I	
	2011.04-		6MT			Hatchback Engine 5FS(EP6C)	GC010155	Outer Joint		25	39	58.5	89	63.5	I	
2.0 BlueHdi 150 (110 kW)	2014.07-			L	F	Hatchback Engine AHX (DW10FD)	GDS10427	Drive Shaft		25	37	58.5	89	638		
	2014.07-			R	F	Hatchback Engine AHX (DW10FD)	GDS10421	Drive Shaft		25	37	58.5	89	972		
2.0 HDi (100 kW)	2011.09-		MT	L	F	Hatchback Engine RHE (DW10CTED4)	GDS10427	Drive Shaft		25	37	58.5	89	638		
	2011.09-		MT	R	F	Hatchback Engine RHE (DW10CTED4)	GDS10421	Drive Shaft		25	37	58.5	89	972		
2.0 HDi (120 kW)	2011.04-		6MT		Hatchback Engine RHH(DW10CTED4)	GC010155	Outer Joint		25	39	58.5	89	63.5	I		
<b>DS4 / DS4 CROSSBACK</b>																
2.0 BlueHdi (110 kW)	2015.07-			R	F	Hatchback Engine G4HC	GDS10421	Drive Shaft		25	37	58.5	89	972		
<b>DS5</b>																
1.6 HDi (82 kW)	2011.11-					Hatchback Engine 9HR(DV6C)	GC099366	Outer Joint		25	34	58.5	79	55	I	
1.6 THP (115 kW)	2011.11-		MT			Hatchback Engine 5FV(EP6CDT)	GC099366	Outer Joint		25	34	58.5	79	55	I	
1.6 THP (147 kW)	2011.11-					Hatchback Engine 5FU(EP6DTX)	GC099366	Outer Joint		25	34	58.5	79	55	I	
2.0 HDi (120 kW)	2011.11-		MT	R	F	Hatchback Engine RHH(DW10CTED4)	GDS99214	Drive Shaft		28	37	58.6	94	978		
	2011.11-		MT	R	F	Hatchback Engine RHH(DW10CTED4)	GCI10041	Inner Joint		37	39	32	399	95.5		
	2011.11-		MT	R	F	Hatchback Engine RHH(DW10CTED4)	GC010159	Outer Joint		28	39	58.6	94	63	I	
	2011.11-		6MT			Hatchback Engine RHH(DW10CTED4)	GC010155	Outer Joint		25	39	58.5	89	63.5	I	
<b>EVASION (22, U6)</b>																
1.9 TD (66 kW)	1994.06-	2002.07					GC010015	Outer Joint	48T	27	39	59	82	63	I	
1.9 TD (68 kW)	1994.06-	2002.07					GC010015	Outer Joint	48T	27	39	59	82	63	I	
2.0 T.C.T. (108 kW)	1994.06-	2002.07					GC010015	Outer Joint	48T	27	39	59	82	63	I	
2.0 TD (68 kW)	1997.05-	2002.07					GC010015	Outer Joint	48T	27	39	59	82	63	I	
2.1 TD (80 kW)	1996.05-	2002.07					GC010015	Outer Joint	48T	27	39	59	82	63	I	
<b>JUMPER I-II</b>																
2.5 D	1994-	2006		L	F		GDS10033	Drive Shaft	54T	35	41	70	117	762		
2.8 HDi	1994-	2006		L	F		GDS10033	Drive Shaft	54T	35	41	70	117	762		
<b>JUMPER III</b>																
2.2 HDi	2006-			L	F		GDS17053	Drive Shaft		35	41	71.5	127	806		
	2006-			L	F		GCI17028	Inner Joint		41	29	43	69.5	109.5		
	2006-			R	F		GDS17050	Drive Shaft		35	41	71.5	127	1140		
	2006-			R	F		GCI17020	Inner Joint		41	29	34.85	403	109		
	2006-			R/L	F		GC017045	Outer Joint		35	29	71.5	127	71	M	
<b>JUMPY</b>																
1.6 HDi	2006-			L	F		GDS10238	Drive Shaft		28	24	58.5	92	669		
	2006-			L	F		GC010095	Outer Joint		28	34	58.5	92	55	I	
	2006-			L	F		GCI99158	Inner Joint		24	34	40	62	89		

	 YEAR	TRANSM	L/R	F/R		G-AP Ref.	PRODUCT	ABS	Technical Specifications											
									A	B	C	H	L	P						
<b>CITROEN</b>																				
<b>JUMPY</b>																				
1.6 HDi	2006-					GDS10239	Drive Shaft		28	24	58.5	92	958							
	2006-					GC010095	Outer Joint		28	34	58.5	92	55	I						
1.6 MJT	2006-			L	F	GCI99158	Inner Joint		24	34	40	62	89							
	2006-			R	F	GCI99159	Inner Joint		24	34	29.8	350	87.5							
<b>LNA</b>																				
1.0 (33 kW)	1984.07-	1986.10	MT	L/R	F	Hatchback Engine 108C	GDS10130	Drive Shaft	21	22	54	90	683							
1.1 (37 kW)	1982.07-	1985.04	MT	L/R	F	Hatchback Engine 109/5E	GDS10130	Drive Shaft	21	22	54	90	683							
<b>NEMO</b>																				
1.4 (54 kW)	2009.04-			L/R	F	Estate Engine KFV(TU3A)/KFT(TU3A)	GC017070	Outer Joint	22	22	51	79	57.5	M						
1.4 HDi	2007-			L	F		GCI17029	Inner Joint	22	22	40	58.5	101							
1.4 HDi (50 kW)	2009.04-		MT	L	F	Estate Engine 8HS(DV4TD)	GDS17151	Drive Shaft	25	22	51	84	656							
	2009.04-		MT	L	F	Estate Engine 8HS(DV4TD)	GCI17029	Inner Joint	22	22	40	58.5	101							
	2009.04-		MT	L	F	Estate Engine 8HS(DV4TD)	GC017067	Outer Joint	25	22	51	84	57.5	M						
	2009.04-		MT	R	F	Estate Engine 8HS(DV4TD)	GDS17052	Drive Shaft	25	22	51	84	879							
	2009.04-		MT	R	F	Estate Engine 8HS(DV4TD)	GCI17030	Inner Joint	22	22	43.1	96.5	99							
	2009.04-		MT	R	F	Estate Engine 8HS(DV4TD)	GC017068	Outer Joint	25	22	51	84	57.5	M						
<b>NEMO (AA_)</b>																				
1.4 (54 kW)	2008.02-			L/R	F	Box Engine KFV(TU3A)	GC017070	Outer Joint	22	22	51	79	57.5	M						
1.4 HDi (50 kW)	2008.02-		MT	L	F	Box Engine 8HS(DV4TD)	GDS17151	Drive Shaft	25	22	51	84	656							
	2008.02-		MT	L	F	Box Engine 8HS(DV4TD)	GCI17029	Inner Joint	22	22	40	58.5	101							
	2008.02-		MT	L	F	Box Engine 8HS(DV4TD)	GC017067	Outer Joint	25	22	51	84	57.5	M						
	2008.02-		MT	R	F	Box Engine 8HS(DV4TD)	GDS17052	Drive Shaft	25	22	51	84	879							
	2008.02-		MT	R	F	Box Engine 8HS(DV4TD)	GCI17030	Inner Joint	22	22	43.1	96.5	99							
	2008.02-		MT	R	F	Box Engine 8HS(DV4TD)	GC017068	Outer Joint	25	22	51	84	57.5	M						
<b>PHEDRA (179)</b>																				
2.0 (100 kW)	2002.09-						GC017044	Outer Joint	27	28	58	81.5	62	M						
2.0 D Multijet (100 kW)	2006.07-						GC017044	Outer Joint	27	28	58	81.5	62	M						
2.0 JTD (100 kW)	2006.06-						GC017044	Outer Joint	27	28	58	81.5	62	M						
2.0 JTD (79 kW)	2002-						GC017044	Outer Joint	27	28	58	81.5	62	M						
2.0 JTD (80 kW)	2002-						GC017044	Outer Joint	27	28	58	81.5	62	M						
2.0 JTD (88 kW)	2006.06-						GC017044	Outer Joint	27	28	58	81.5	62	M						
2.2 JTD (120 kW)	2002.09-						GC017044	Outer Joint	27	28	58	81.5	62	M						
2.2 JTD (125 kW)	2002.09-						GC017044	Outer Joint	27	28	58	81.5	62	M						
2.2 JTD (94 kW)	2002.09-						GC017044	Outer Joint	27	28	58	81.5	62	M						
<b>RELAY</b>																				
2.2 HDi (74 kW)	2006.04-		5MT/6MT		F	Bus Engine 4HV(P22DTE)	GC017045	Outer Joint	35	29	71.5	127	71	M						
	2006.04-		5MT/6MT		F	Bus Engine 4HV(P22DTE)	GC017055	Outer Joint	35	27	71.5	127	66.5	I						
	2006.04-		5MT/6MT		F	Bus Engine 4HV(P22DTE)	GCI17020	Inner Joint	41	29	34.85	403	109							
	2006.04-		5MT/6MT		F	Bus Engine 4HV(P22DTE)	GCI10038	Inner Joint	41	27	34.85	403	102							
	2006.04-		5MT/6MT		F	Platform/Chassis Engine 4HV(P22DTE)	GC017045	Outer Joint	35	29	71.5	127	71	M						
	2006.04-		5MT/6MT		F	Platform/Chassis Engine 4HV(P22DTE)	GC017055	Outer Joint	35	27	71.5	127	66.5	I						
	2006.04-		5MT/6MT		F	Platform/Chassis Engine 4HV(P22DTE)	GCI17020	Inner Joint	41	29	34.85	403	109							
	2006.04-		5MT/6MT		F	Platform/Chassis Engine 4HV(P22DTE)	GCI10038	Inner Joint	41	27	34.85	403	102							
	2006.04-		5MT/6MT	L	F	Bus Engine 4HV(P22DTE)	GCI17028	Inner Joint	41	29	43	69.5	109.5							
	2006.04-		5MT/6MT	L	F	Bus Engine 4HV(P22DTE)	GCI17042	Inner Joint	41	27	43	70	102							
	2006.04-		5MT/6MT	L	F	Platform/Chassis Engine 4HV(P22DTE)	GCI17028	Inner Joint	41	29	43	69.5	109.5							
	2006.04-		5MT/6MT	L	F	Platform/Chassis Engine 4HV(P22DTE)	GCI17042	Inner Joint	41	27	43	70	102							
	2006.04-			L	F	Bus Engine 4HV(P22DTE)	GDS45176	Drive Shaft	35	41	71.5	127	808							
	2006.04-			L	F	Platform/Chassis Engine 4HV(P22DTE)	GDS45176	Drive Shaft	35	41	71.5	127	808							
	2006.04-			R	F	Bus Engine 4HV(P22DTE)	GDS17050	Drive Shaft	35	41	71.5	127	1140							
	2006.04-			R	F	Platform/Chassis Engine 4HV(P22DTE)	GDS17050	Drive Shaft	35	41	71.5	127	1140							
2.2 HDi (88 kW)	2006.04-		5MT/6MT		F	Bus Engine 4HU(P22DTE)	GC017045	Outer Joint	35	29	71.5	127	71	M						
	2006.04-		5MT/6MT		F	Bus Engine 4HU(P22DTE)	GC017055	Outer Joint	35	27	71.5	127	66.5	I						
	2006.04-		5MT/6MT		F	Bus Engine 4HU(P22DTE)	GCI17020	Inner Joint	41	29	34.85	403	109							
	2006.04-		5MT/6MT		F	Bus Engine 4HU(P22DTE)	GCI10038	Inner Joint	41	27	34.85	403	102							
	2006.04-		5MT/6MT		F	Platform/Chassis Engine 4HU(P22DTE)	GC017045	Outer Joint	35	29	71.5	127	71	M						
	2006.04-		5MT/6MT		F	Platform/Chassis Engine 4HU(P22DTE)	GC017055	Outer Joint	35	27	71.5	127	66.5	I						
	2006.04-		5MT/6MT		F	Platform/Chassis Engine 4HU(P22DTE)	GCI17020	Inner Joint	41	29	34.85	403	109							
	2006.04-		5MT/6MT		F	Platform/Chassis Engine 4HU(P22DTE)	GCI10038	Inner Joint	41	27	34.85	403	102							
	2006.04-		5MT/6MT	L	F	Bus Engine 4HU(P22DTE)	GCI17028	Inner Joint	41	29	43	69.5	109.5							
	2006.04-		5MT/6MT	L	F	Bus Engine 4HU(P22DTE)	GCI17042	Inner Joint	41	27	43	70	102							
	2006.04-		5MT/6MT	L	F	Platform/Chassis Engine 4HU(P22DTE)	GCI17028	Inner Joint	41	29	43	69.5	109.5							
	2006.04-		5MT/6MT	L	F	Platform/Chassis Engine 4HU(P22DTE)	GCI17042	Inner Joint	41	29	43	69.5	109.5							



		TRANSM	L/R	F/R		G-AP Ref.	PRODUCT	ABS	Technical Specifications								
									YEAR	A	B	C	H	L	P		
<b>CITROEN RELAY</b>																	
2.2 HDi (88 kW)	2006.04-		5MT/6MT	L	F	Platform/Chassis Engine 4HU(P22DTE)	GCI17042	Inner Joint		41	27	43	70	102			
	2006.04-			L	F	Bus Engine 4HU(P22DTE)	GDS45176	Drive Shaft		35	41	71.5	127	808			
	2006.04-			L	F	Platform/Chassis Engine 4HU(P22DTE)	GDS45176	Drive Shaft		35	41	71.5	127	808			
	2006.04-			R	F	Bus Engine 4HU(P22DTE)	GDS17050	Drive Shaft		35	41	71.5	127	1140			
	2006.04-			R	F	Platform/Chassis Engine 4HU(P22DTE)	GDS17050	Drive Shaft		35	41	71.5	127	1140			
3.0 HDi (116 kW)	2006.09-		6MT		F	Bus Engine F1CE0481D(F30DT)	GC017060	Outer Joint		35	29	71.5	127	71	I		
	2006.09-		6MT		F	Bus Engine F1CE0481D(F30DT)	GCI17021	Inner Joint		31	29	34.85	530	109			
	2006.09-		6MT		F	Bus Engine F1CE0481D(F30DT)	GCI17022	Inner Joint		31	29	44.95	77	109.5			
	2006.09-		6MT		F	Platform/Chassis Engine F1CE0481D(F30DT)	GC017060	Outer Joint		35	29	71.5	127	71	I		
	2006.09-		6MT		F	Platform/Chassis Engine F1CE0481D(F30DT)	GCI17021	Inner Joint		31	29	34.85	530	109			
	2006.09-		6MT		F	Platform/Chassis Engine F1CE0481D(F30DT)	GCI17022	Inner Joint		31	29	44.95	77	109.5			
	2006.09-			L	F	Bus Engine F1CE0481D(F30DT)	GDS45175	Drive Shaft		35	31	71.5	127	749.5			
	2006.09-			L	F	Bus Engine F1CE0481D(F30DT)	GCI17022	Inner Joint		31	29	44.95	77	109.5			
	2006.09-			L	F	Platform/Chassis Engine F1CE0481D(F30DT)	GDS45175	Drive Shaft		35	31	71.5	127	749.5			
	2006.09-			L	F	Platform/Chassis Engine F1CE0481D(F30DT)	GCI17022	Inner Joint		31	29	44.95	77	109.5			
	2006.09-			L/R	F	Bus Engine F1CE0481D(F30DT)	GC017060	Outer Joint		35	29	71.5	127	71	I		
	2006.09-			L/R	F	Platform/Chassis Engine F1CE0481D(F30DT)	GC017060	Outer Joint		35	29	71.5	127	71	I		
	2006.09-			R	F	Bus Engine F1CE0481D(F30DT)	GDS45174	Drive Shaft		35	31	71.5	127	1199			
	2006.09-			R	F	Bus Engine F1CE0481D(F30DT)	GCI17021	Inner Joint		31	29	34.85	530	109			
	2006.09-			R	F	Platform/Chassis Engine F1CE0481D(F30DT)	GDS45174	Drive Shaft		35	31	71.5	127	1199			
2006.09-			R	F	Platform/Chassis Engine F1CE0481D(F30DT)	GCI17021	Inner Joint		31	29	34.85	530	109				
<b>RELAY (230)</b>																	
1.9 TD (66 kW)	1994.03-	2002.04	MT		F	Platform/Chassis Engine DHX(XUD9TF/BTF)	GC010013	Outer Joint	54T	28	39	63	112.5	63	I		
	1994.03-	2002.04	MT		F	Platform/Chassis Engine DHX(XUD9TF/BTF)	GC010050	Outer Joint		35	45	70	117	73	I		
	1994.03-	2002.04	MT		F	Platform/Chassis Engine DHX(XUD9TF/BTF)	GC010012	Outer Joint		28	39	63	112.5	63	I		
	1994.03-	2002.04	MT		F	Platform/Chassis Engine DHX(XUD9TF/BTF)	GC010011	Outer Joint	54T	35	45	70	117	73	I		
	1994.03-	2002.04	MT	L	F	Platform/Chassis Engine DHX(XUD9TF/BTF)	GDS10035	Drive Shaft	54T	28	41	63	112.5	757.5			
	1994.03-	2002.04	MT	L	F	Platform/Chassis Engine DHX(XUD9TF/BTF)	GDS10102	Drive Shaft		28	41	63	112.5	757.5			
	1994.03-	2002.04	MT	L	F	Platform/Chassis Engine DHX(XUD9TF/BTF)	GDS10037	Drive Shaft	54T	28	37	63	112.5	771			
	1994.03-	2002.04	MT	L	F	Platform/Chassis Engine DHX(XUD9TF/BTF)	GDS10033	Drive Shaft	54T	35	41	70	117	762			
	1994.03-	2002.04	MT	L	F	Platform/Chassis Engine DHX(XUD9TF/BTF)	GDS10105	Drive Shaft		28	37	63	112.5	771			
	1994.03-	2002.04	MT	L	F	Platform/Chassis Engine DHX(XUD9TF/BTF)	GDS10067	Drive Shaft		35	41	70	117	762			
	1994.03-	2002.04	MT	R	F	Platform/Chassis Engine DHX(XUD9TF/BTF)	GDS10032	Drive Shaft	54T	35	41	70	117	1085			
	1994.03-	2002.04	MT	R	F	Platform/Chassis Engine DHX(XUD9TF/BTF)	GDS10069	Drive Shaft		28	37	63	112.5	1072			
	1994.03-	2002.04	MT	R	F	Platform/Chassis Engine DHX(XUD9TF/BTF)	GDS10066	Drive Shaft		35	41	70	117	1085			
	1994.03-	2002.04	MT	R	F	Platform/Chassis Engine DHX(XUD9TF/BTF)	GDS10036	Drive Shaft	54T	28	41	63	112.5	1079			
	1994.03-	2002.04	MT	R	F	Platform/Chassis Engine DHX(XUD9TF/BTF)	GDS10103	Drive Shaft		28	41	63	112.5	1079			
	1994.03-	2002.04	MT	R	F	Platform/Chassis Engine DHX(XUD9TF/BTF)	GDS10104	Drive Shaft	54T	28	37	63	112.5	1072			
	1.9 TD (68 kW)	1994.03-	2002.04	MT		F	Platform/Chassis Engine D8C(XUD9UTF)	GC010013	Outer Joint	54T	28	39	63	112.5	63	I	
1994.03-		2002.04	MT		F	Platform/Chassis Engine D8C(XUD9UTF)	GC010050	Outer Joint		35	45	70	117	73	I		
1994.03-		2002.04	MT		F	Platform/Chassis Engine D8C(XUD9UTF)	GC010012	Outer Joint		28	39	63	112.5	63	I		
1994.03-		2002.04	MT		F	Platform/Chassis Engine D8C(XUD9UTF)	GC010011	Outer Joint	54T	35	45	70	117	73	I		
1994.03-		2002.04	MT	L	F	Platform/Chassis Engine D8C(XUD9UTF)	GDS10035	Drive Shaft	54T	28	41	63	112.5	757.5			
1994.03-		2002.04	MT	L	F	Platform/Chassis Engine D8C(XUD9UTF)	GDS10102	Drive Shaft		28	41	63	112.5	757.5			
1994.03-		2002.04	MT	L	F	Platform/Chassis Engine D8C(XUD9UTF)	GDS10037	Drive Shaft	54T	28	37	63	112.5	771			
1994.03-		2002.04	MT	L	F	Platform/Chassis Engine D8C(XUD9UTF)	GDS10033	Drive Shaft	54T	35	41	70	117	762			
1994.03-		2002.04	MT	L	F	Platform/Chassis Engine D8C(XUD9UTF)	GDS10105	Drive Shaft		28	37	63	112.5	771			
1994.03-		2002.04	MT	L	F	Platform/Chassis Engine D8C(XUD9UTF)	GDS10067	Drive Shaft		35	41	70	117	762			
1994.03-		2002.04	MT	R	F	Platform/Chassis Engine D8C(XUD9UTF)	GDS10032	Drive Shaft	54T	35	41	70	117	1085			
1994.03-		2002.04	MT	R	F	Platform/Chassis Engine D8C(XUD9UTF)	GDS10069	Drive Shaft		28	37	63	112.5	1072			
1994.03-		2002.04	MT	R	F	Platform/Chassis Engine D8C(XUD9UTF)	GDS10066	Drive Shaft		35	41	70	117	1085			
1994.03-		2002.04	MT	R	F	Platform/Chassis Engine D8C(XUD9UTF)	GDS10036	Drive Shaft	54T	28	41	63	112.5	1079			
1994.03-		2002.04	MT	R	F	Platform/Chassis Engine D8C(XUD9UTF)	GDS10103	Drive Shaft		28	41	63	112.5	1079			
1994.03-		2002.04	MT	R	F	Platform/Chassis Engine D8C(XUD9UTF)	GDS10104	Drive Shaft	54T	28	37	63	112.5	1072			
2.0 (80 kW)		1994.03-	2002.04	MT	L	F	Platform/Chassis Engine RFW(XU10J2U)	GDS10035	Drive Shaft	54T	28	41	63	112.5	757.5		
	1994.03-	2002.04	MT	L	F	Platform/Chassis Engine RFW(XU10J2U)	GDS10102	Drive Shaft		28	41	63	112.5	757.5			
	1994.03-	2002.04	MT	L	F	Platform/Chassis Engine RFW(XU10J2U)	GDS10037	Drive Shaft	54T	28	37	63	112.5	771			
	1994.03-	2002.04	MT	L	F	Platform/Chassis Engine RFW(XU10J2U)	GDS10033	Drive Shaft	54T	35	41	70	117	762			
	1994.03-	2002.04	MT	L	F	Platform/Chassis Engine RFW(XU10J2U)	GDS10105	Drive Shaft		28	37	63	112.5	771			
	1994.03-	2002.04	MT	L	F	Platform/Chassis Engine RFW(XU10J2U)	GDS10067	Drive Shaft		35	41	70	117	762			
	1994.03-	2002.04	MT	R	F	Platform/Chassis Engine RFW(XU10J2U)	GDS10032	Drive Shaft	54T	35	41	70	117	1085			
1994.03-	2002.04	MT	R	F	Platform/Chassis Engine RFW(XU10J2U)	GDS10069	Drive Shaft		28	37	63	112.5	1072				





		TRANSM	L/R	F/R		G-AP Ref.	PRODUCT	ABS	Technical Specifications					
									YEAR	A	B	C	H	L
<b>CITROEN RELAY (230)</b> 2.0 (80 kW)	1994.03-2002.04	MT	R	F	Platform/Chassis Engine RFW(XU10J2U)	GDS10066	Drive Shaft		35	41	70	117	1085	
	1994.03-2002.04	MT	R	F	Platform/Chassis Engine RFW(XU10J2U)	GDS10036	Drive Shaft	54T	28	41	63	112.5	1079	
	1994.03-2002.04	MT	R	F	Platform/Chassis Engine RFW(XU10J2U)	GDS10103	Drive Shaft		28	41	63	112.5	1079	
	1994.03-2002.04	MT	R	F	Platform/Chassis Engine RFW(XU10J2U)	GDS10104	Drive Shaft	54T	28	37	63	112.5	1072	
	1994.03-2002.04	MT		F	Platform/Chassis Engine RFW(XU10J2U)	GC010013	Outer Joint	54T	28	39	63	112.5	63	I
	1994.03-2002.04	MT		F	Platform/Chassis Engine RFW(XU10J2U)	GC010050	Outer Joint		35	45	70	117	73	I
	1994.03-2002.04	MT		F	Platform/Chassis Engine RFW(XU10J2U)	GC010012	Outer Joint		28	39	63	112.5	63	I
	1994.03-2002.04	MT		F	Platform/Chassis Engine RFW(XU10J2U)	GC010011	Outer Joint	54T	35	45	70	117	73	I
2.5 D (63 kW)	1994.03-2002.04	MT		F	Platform/Chassis Engine T9A(DJ5)	GC010013	Outer Joint	54T	28	39	63	112.5	63	I
	1994.03-2002.04	MT		F	Platform/Chassis Engine T9A(DJ5)	GC010050	Outer Joint		35	45	70	117	73	I
	1994.03-2002.04	MT		F	Platform/Chassis Engine T9A(DJ5)	GC010012	Outer Joint		28	39	63	112.5	63	I
	1994.03-2002.04	MT		F	Platform/Chassis Engine T9A(DJ5)	GC010011	Outer Joint	54T	35	45	70	117	73	I
	1994.03-2002.04	MT	L	F	Platform/Chassis Engine T9A(DJ5)	GDS10035	Drive Shaft	54T	28	41	63	112.5	757.5	
	1994.03-2002.04	MT	L	F	Platform/Chassis Engine T9A(DJ5)	GDS10102	Drive Shaft		28	41	63	112.5	757.5	
	1994.03-2002.04	MT	L	F	Platform/Chassis Engine T9A(DJ5)	GDS10037	Drive Shaft	54T	28	37	63	112.5	771	
	1994.03-2002.04	MT	L	F	Platform/Chassis Engine T9A(DJ5)	GDS10033	Drive Shaft	54T	35	41	70	117	762	
	1994.03-2002.04	MT	L	F	Platform/Chassis Engine T9A(DJ5)	GDS10105	Drive Shaft		28	37	63	112.5	771	
	1994.03-2002.04	MT	L	F	Platform/Chassis Engine T9A(DJ5)	GDS10067	Drive Shaft		35	41	70	117	762	
	1994.03-2002.04	MT	R	F	Platform/Chassis Engine T9A(DJ5)	GDS10032	Drive Shaft	54T	35	41	70	117	1085	
	1994.03-2002.04	MT	R	F	Platform/Chassis Engine T9A(DJ5)	GDS10069	Drive Shaft		28	37	63	112.5	1072	
	1994.03-2002.04	MT	R	F	Platform/Chassis Engine T9A(DJ5)	GDS10066	Drive Shaft		35	41	70	117	1085	
	1994.03-2002.04	MT	R	F	Platform/Chassis Engine T9A(DJ5)	GDS10036	Drive Shaft	54T	28	41	63	112.5	1079	
	1994.03-2002.04	MT	R	F	Platform/Chassis Engine T9A(DJ5)	GDS10103	Drive Shaft		28	41	63	112.5	1079	
	1994.03-2002.04	MT	R	F	Platform/Chassis Engine T9A(DJ5)	GDS10104	Drive Shaft	54T	28	37	63	112.5	1072	
2.5 D 4x4 (63 kW)	2000.03-2002.04	MT		F	Platform/Chassis Engine T9A(DJ5)	GC010013	Outer Joint	54T	28	39	63	112.5	63	I
	2000.03-2002.04	MT		F	Platform/Chassis Engine T9A(DJ5)	GC010050	Outer Joint		35	45	70	117	73	I
	2000.03-2002.04	MT		F	Platform/Chassis Engine T9A(DJ5)	GC010012	Outer Joint		28	39	63	112.5	63	I
	2000.03-2002.04	MT		F	Platform/Chassis Engine T9A(DJ5)	GC010011	Outer Joint	54T	35	45	70	117	73	I
	2000.03-2002.04	MT	L	F	Platform/Chassis Engine T9A(DJ5)	GDS10035	Drive Shaft	54T	28	41	63	112.5	757.5	
	2000.03-2002.04	MT	L	F	Platform/Chassis Engine T9A(DJ5)	GDS10102	Drive Shaft		28	41	63	112.5	757.5	
	2000.03-2002.04	MT	L	F	Platform/Chassis Engine T9A(DJ5)	GDS10037	Drive Shaft	54T	28	37	63	112.5	771	
	2000.03-2002.04	MT	L	F	Platform/Chassis Engine T9A(DJ5)	GDS10033	Drive Shaft	54T	35	41	70	117	762	
	2000.03-2002.04	MT	L	F	Platform/Chassis Engine T9A(DJ5)	GDS10105	Drive Shaft		28	37	63	112.5	771	
	2000.03-2002.04	MT	L	F	Platform/Chassis Engine T9A(DJ5)	GDS10067	Drive Shaft		35	41	70	117	762	
	2000.03-2002.04	MT	R	F	Platform/Chassis Engine T9A(DJ5)	GDS10032	Drive Shaft	54T	35	41	70	117	1085	
	2000.03-2002.04	MT	R	F	Platform/Chassis Engine T9A(DJ5)	GDS10069	Drive Shaft		28	37	63	112.5	1072	
	2000.03-2002.04	MT	R	F	Platform/Chassis Engine T9A(DJ5)	GDS10066	Drive Shaft		35	41	70	117	1085	
	2000.03-2002.04	MT	R	F	Platform/Chassis Engine T9A(DJ5)	GDS10036	Drive Shaft	54T	28	41	63	112.5	1079	
	2000.03-2002.04	MT	R	F	Platform/Chassis Engine T9A(DJ5)	GDS10103	Drive Shaft		28	41	63	112.5	1079	
	2000.03-2002.04	MT	R	F	Platform/Chassis Engine T9A(DJ5)	GDS10104	Drive Shaft	54T	28	37	63	112.5	1072	
2.5 TD (76 kW)	1994.03-2002.04	MT		F	Platform/Chassis Engine T8A(DJ5T)	GC010013	Outer Joint	54T	28	39	63	112.5	63	I
	1994.03-2002.04	MT		F	Platform/Chassis Engine T8A(DJ5T)	GC010050	Outer Joint		35	45	70	117	73	I
	1994.03-2002.04	MT		F	Platform/Chassis Engine T8A(DJ5T)	GC010012	Outer Joint		28	39	63	112.5	63	I
	1994.03-2002.04	MT		F	Platform/Chassis Engine T8A(DJ5T)	GC010011	Outer Joint	54T	35	45	70	117	73	I
	1994.03-2002.04	MT	L	F	Platform/Chassis Engine T8A(DJ5T)	GDS10035	Drive Shaft	54T	28	41	63	112.5	757.5	
	1994.03-2002.04	MT	L	F	Platform/Chassis Engine T8A(DJ5T)	GDS10102	Drive Shaft		28	41	63	112.5	757.5	
	1994.03-2002.04	MT	L	F	Platform/Chassis Engine T8A(DJ5T)	GDS10037	Drive Shaft	54T	28	37	63	112.5	771	
	1994.03-2002.04	MT	L	F	Platform/Chassis Engine T8A(DJ5T)	GDS10033	Drive Shaft	54T	35	41	70	117	762	
	1994.03-2002.04	MT	L	F	Platform/Chassis Engine T8A(DJ5T)	GDS10105	Drive Shaft		28	37	63	112.5	771	
	1994.03-2002.04	MT	L	F	Platform/Chassis Engine T8A(DJ5T)	GDS10067	Drive Shaft		35	41	70	117	762	
	1994.03-2002.04	MT	R	F	Platform/Chassis Engine T8A(DJ5T)	GDS10032	Drive Shaft	54T	35	41	70	117	1085	
	1994.03-2002.04	MT	R	F	Platform/Chassis Engine T8A(DJ5T)	GDS10069	Drive Shaft		28	37	63	112.5	1072	
	1994.03-2002.04	MT	R	F	Platform/Chassis Engine T8A(DJ5T)	GDS10066	Drive Shaft		35	41	70	117	1085	
	1994.03-2002.04	MT	R	F	Platform/Chassis Engine T8A(DJ5T)	GDS10036	Drive Shaft	54T	28	41	63	112.5	1079	
	1994.03-2002.04	MT	R	F	Platform/Chassis Engine T8A(DJ5T)	GDS10103	Drive Shaft		28	41	63	112.5	1079	
	1994.03-2002.04	MT	R	F	Platform/Chassis Engine T8A(DJ5T)	GDS10104	Drive Shaft	54T	28	37	63	112.5	1072	
2.5 TDi (79 kW)	1996.12-2002.04	MT		F	Platform/Chassis Engine THX(DJ5TED)	GC010013	Outer Joint	54T	28	39	63	112.5	63	I
	1996.12-2002.04	MT		F	Platform/Chassis Engine THX(DJ5TED)	GC010050	Outer Joint		35	45	70	117	73	I
	1996.12-2002.04	MT		F	Platform/Chassis Engine THX(DJ5TED)	GC010012	Outer Joint		28	39	63	112.5	63	I
	1996.12-2002.04	MT		F	Platform/Chassis Engine THX(DJ5TED)	GC010011	Outer Joint	54T	35	45	70	117	73	I
	1996.12-2002.04	MT	L	F	Platform/Chassis Engine THX(DJ5TED)	GDS10035	Drive Shaft	54T	28	41	63	112.5	757.5	
	1996.12-2002.04	MT	L	F	Platform/Chassis Engine THX(DJ5TED)	GDS10102	Drive Shaft		28	41	63	112.5	757.5	
1996.12-2002.04	MT	L	F	Platform/Chassis Engine THX(DJ5TED)	GDS10037	Drive Shaft	54T	28	37	63	112.5	771		



		TRANSM	L/R	F/R		G-AP Ref.	PRODUCT	ABS	Technical Specifications								
									YEAR	A	B	C	H	L	P		
<b>CITROEN RELAY (230)</b>																	
2.5 TDi (79 kW)	1996.12-	2002.04	MT	L	F	Platform/Chassis Engine THX(DJ5TED)	GDS10033	Drive Shaft	54T	35	41	70	117	762			
	1996.12-	2002.04	MT	L	F	Platform/Chassis Engine THX(DJ5TED)	GDS10105	Drive Shaft		28	37	63	112.5	771			
	1996.12-	2002.04	MT	L	F	Platform/Chassis Engine THX(DJ5TED)	GDS10067	Drive Shaft		35	41	70	117	762			
	1996.12-	2002.04	MT	R	F	Platform/Chassis Engine THX(DJ5TED)	GDS10032	Drive Shaft	54T	35	41	70	117	1085			
	1996.12-	2002.04	MT	R	F	Platform/Chassis Engine THX(DJ5TED)	GDS10069	Drive Shaft		28	37	63	112.5	1072			
	1996.12-	2002.04	MT	R	F	Platform/Chassis Engine THX(DJ5TED)	GDS10066	Drive Shaft		35	41	70	117	1085			
	1996.12-	2002.04	MT	R	F	Platform/Chassis Engine THX(DJ5TED)	GDS10036	Drive Shaft	54T	28	41	63	112.5	1079			
	1996.12-	2002.04	MT	R	F	Platform/Chassis Engine THX(DJ5TED)	GDS10103	Drive Shaft		28	41	63	112.5	1079			
	1996.12-	2002.04	MT	R	F	Platform/Chassis Engine THX(DJ5TED)	GDS10104	Drive Shaft	54T	28	37	63	112.5	1072			
2.5 TDi 4x4 (79 kW)	2000.03-	2002.04	MT		F	Platform/Chassis Engine THX(DJ5TED)	GC010013	Outer Joint	54T	28	39	63	112.5	63	I		
	2000.03-	2002.04	MT		F	Platform/Chassis Engine THX(DJ5TED)	GC010050	Outer Joint		35	45	70	117	73	I		
	2000.03-	2002.04	MT		F	Platform/Chassis Engine THX(DJ5TED)	GC010012	Outer Joint		28	39	63	112.5	63	I		
	2000.03-	2002.04	MT		F	Platform/Chassis Engine THX(DJ5TED)	GC010011	Outer Joint	54T	35	45	70	117	73	I		
	2000.03-	2002.04	MT	L	F	Platform/Chassis Engine THX(DJ5TED)	GDS10035	Drive Shaft	54T	28	41	63	112.5	757.5			
	2000.03-	2002.04	MT	L	F	Platform/Chassis Engine THX(DJ5TED)	GDS10102	Drive Shaft		28	41	63	112.5	757.5			
	2000.03-	2002.04	MT	L	F	Platform/Chassis Engine THX(DJ5TED)	GDS10037	Drive Shaft	54T	28	37	63	112.5	771			
	2000.03-	2002.04	MT	L	F	Platform/Chassis Engine THX(DJ5TED)	GDS10033	Drive Shaft	54T	35	41	70	117	762			
	2000.03-	2002.04	MT	L	F	Platform/Chassis Engine THX(DJ5TED)	GDS10105	Drive Shaft		28	37	63	112.5	771			
	2000.03-	2002.04	MT	L	F	Platform/Chassis Engine THX(DJ5TED)	GDS10067	Drive Shaft		35	41	70	117	762			
	2000.03-	2002.04	MT	R	F	Platform/Chassis Engine THX(DJ5TED)	GDS10032	Drive Shaft	54T	35	41	70	117	1085			
	2000.03-	2002.04	MT	R	F	Platform/Chassis Engine THX(DJ5TED)	GDS10069	Drive Shaft		28	37	63	112.5	1072			
	2000.03-	2002.04	MT	R	F	Platform/Chassis Engine THX(DJ5TED)	GDS10066	Drive Shaft		35	41	70	117	1085			
	2000.03-	2002.04	MT	R	F	Platform/Chassis Engine THX(DJ5TED)	GDS10036	Drive Shaft	54T	28	41	63	112.5	1079			
	2000.03-	2002.04	MT	R	F	Platform/Chassis Engine THX(DJ5TED)	GDS10103	Drive Shaft		28	41	63	112.5	1079			
2000.03-	2002.04	MT	R	F	Platform/Chassis Engine THX(DJ5TED)	GDS10104	Drive Shaft	54T	28	37	63	112.5	1072				
2.8 HDi (94 kW)	2000.09-	2002.04	MT		F	Platform/Chassis Engine 8140.43S	GC010050	Outer Joint		35	45	70	117	73	I		
	2000.09-	2002.04	MT		F	Platform/Chassis Engine 8140.43S	GC010011	Outer Joint	54T	35	45	70	117	73	I		
	2000.09-	2002.04	MT	L	F	Platform/Chassis Engine 8140.43S	GDS10033	Drive Shaft	54T	35	41	70	117	762			
	2000.09-	2002.04	MT	L	F	Platform/Chassis Engine 8140.43S	GDS10067	Drive Shaft		35	41	70	117	762			
	2000.09-	2002.04	MT	R	F	Platform/Chassis Engine 8140.43S	GDS10032	Drive Shaft	54T	35	41	70	117	1085			
	2000.09-	2002.04	MT	R	F	Platform/Chassis Engine 8140.43S	GDS10066	Drive Shaft		35	41	70	117	1085			
<b>RELAY (230L)</b>																	
1.9 D (50 kW)	1999.07-	2002.04	MT		F	Box Engine DJY(XUD9A)	GC010013	Outer Joint	54T	28	39	63	112.5	63	I		
	1999.07-	2002.04	MT		F	Box Engine DJY(XUD9A)	GC010050	Outer Joint		35	45	70	117	73	I		
	1999.07-	2002.04	MT		F	Box Engine DJY(XUD9A)	GC010012	Outer Joint		28	39	63	112.5	63	I		
	1999.07-	2002.04	MT		F	Box Engine DJY(XUD9A)	GC010011	Outer Joint	54T	35	45	70	117	73	I		
	1999.07-	2002.04	MT	L	F	Box Engine DJY(XUD9A)	GDS10035	Drive Shaft	54T	28	41	63	112.5	757.5			
	1999.07-	2002.04	MT	L	F	Box Engine DJY(XUD9A)	GDS10102	Drive Shaft		28	41	63	112.5	757.5			
	1999.07-	2002.04	MT	L	F	Box Engine DJY(XUD9A)	GDS10037	Drive Shaft	54T	28	37	63	112.5	771			
	1999.07-	2002.04	MT	L	F	Box Engine DJY(XUD9A)	GDS10033	Drive Shaft	54T	35	41	70	117	762			
	1999.07-	2002.04	MT	L	F	Box Engine DJY(XUD9A)	GDS10105	Drive Shaft		28	37	63	112.5	771			
	1999.07-	2002.04	MT	L	F	Box Engine DJY(XUD9A)	GDS10067	Drive Shaft		35	41	70	117	762			
	1999.07-	2002.04	MT	R	F	Box Engine DJY(XUD9A)	GDS10032	Drive Shaft	54T	35	41	70	117	1085			
	1999.07-	2002.04	MT	R	F	Box Engine DJY(XUD9A)	GDS10069	Drive Shaft		28	37	63	112.5	1072			
	1999.07-	2002.04	MT	R	F	Box Engine DJY(XUD9A)	GDS10066	Drive Shaft		35	41	70	117	1085			
	1999.07-	2002.04	MT	R	F	Box Engine DJY(XUD9A)	GDS10036	Drive Shaft	54T	28	41	63	112.5	1079			
	1999.07-	2002.04	MT	R	F	Box Engine DJY(XUD9A)	GDS10103	Drive Shaft		28	41	63	112.5	1079			
1999.07-	2002.04	MT	R	F	Box Engine DJY(XUD9A)	GDS10104	Drive Shaft	54T	28	37	63	112.5	1072				
1.9 D (51 kW)	1994.02-	2002.04	MT		F	Box Engine D9B(XUD9A/U)	GC010013	Outer Joint	54T	28	39	63	112.5	63	I		
	1994.02-	2002.04	MT		F	Box Engine D9B(XUD9A/U)	GC010050	Outer Joint		35	45	70	117	73	I		
	1994.02-	2002.04	MT		F	Box Engine D9B(XUD9A/U)	GC010012	Outer Joint		28	39	63	112.5	63	I		
	1994.02-	2002.04	MT		F	Box Engine D9B(XUD9A/U)	GC010011	Outer Joint	54T	35	45	70	117	73	I		
	1994.02-	2002.04	MT	L	F	Box Engine D9B(XUD9A/U)	GDS10035	Drive Shaft	54T	28	41	63	112.5	757.5			
	1994.02-	2002.04	MT	L	F	Box Engine D9B(XUD9A/U)	GDS10102	Drive Shaft		28	41	63	112.5	757.5			
	1994.02-	2002.04	MT	L	F	Box Engine D9B(XUD9A/U)	GDS10037	Drive Shaft	54T	28	37	63	112.5	771			
	1994.02-	2002.04	MT	L	F	Box Engine D9B(XUD9A/U)	GDS10033	Drive Shaft	54T	35	41	70	117	762			
	1994.02-	2002.04	MT	L	F	Box Engine D9B(XUD9A/U)	GDS10105	Drive Shaft		28	37	63	112.5	771			
	1994.02-	2002.04	MT	L	F	Box Engine D9B(XUD9A/U)	GDS10067	Drive Shaft		35	41	70	117	762			
	1994.02-	2002.04	MT	R	F	Box Engine D9B(XUD9A/U)	GDS10104	Drive Shaft	54T	28	37	63	112.5	1072			
	1994.02-	2002.04	MT	R	F	Box Engine D9B(XUD9A/U)	GDS10032	Drive Shaft	54T	35	41	70	117	1085			
	1994.02-	2002.04	MT	R	F	Box Engine D9B(XUD9A/U)	GDS10069	Drive Shaft		28	37	63	112.5	1072			
	1994.02-	2002.04	MT	R	F	Box Engine D9B(XUD9A/U)	GDS10066	Drive Shaft		35	41	70	117	1085			





		TRANSM	L/R	F/R		G-AP Ref.	PRODUCT	ABS	Technical Specifications						
									YEAR	A	B	C	H	L	P
<b>CITROEN RELAY (230L)</b>	1.9 D (51 kW)	1994.02-2002.04	MT	R	F	Box Engine D9B(XUD9A/U)	GDS10036	Drive Shaft	54T	28	41	63	112.5	1079	
		1994.02-2002.04	MT	R	F	Box Engine D9B(XUD9A/U)	GDS10103	Drive Shaft		28	41	63	112.5	1079	
1.9 TD (66 kW)		1994.03-2002.04	MT		F	Box Engine DHX(XUD9TF/BTF)	GC010013	Outer Joint	54T	28	39	63	112.5	63	I
		1994.03-2002.04	MT		F	Box Engine DHX(XUD9TF/BTF)	GC010050	Outer Joint		35	45	70	117	73	I
		1994.03-2002.04	MT		F	Box Engine DHX(XUD9TF/BTF)	GC010012	Outer Joint		28	39	63	112.5	63	I
		1994.03-2002.04	MT		F	Box Engine DHX(XUD9TF/BTF)	GC010011	Outer Joint	54T	35	45	70	117	73	I
		1994.03-2002.04	MT	L	F	Box Engine DHX(XUD9TF/BTF)	GDS10035	Drive Shaft	54T	28	41	63	112.5	757.5	
		1994.03-2002.04	MT	L	F	Box Engine DHX(XUD9TF/BTF)	GDS10102	Drive Shaft		28	41	63	112.5	757.5	
		1994.03-2002.04	MT	L	F	Box Engine DHX(XUD9TF/BTF)	GDS10037	Drive Shaft	54T	28	37	63	112.5	771	
		1994.03-2002.04	MT	L	F	Box Engine DHX(XUD9TF/BTF)	GDS10033	Drive Shaft	54T	35	41	70	117	762	
		1994.03-2002.04	MT	L	F	Box Engine DHX(XUD9TF/BTF)	GDS10105	Drive Shaft		28	37	63	112.5	771	
		1994.03-2002.04	MT	L	F	Box Engine DHX(XUD9TF/BTF)	GDS10067	Drive Shaft		35	41	70	117	762	
		1994.03-2002.04	MT	R	F	Box Engine DHX(XUD9TF/BTF)	GDS10104	Drive Shaft	54T	28	37	63	112.5	1072	
		1994.03-2002.04	MT	R	F	Box Engine DHX(XUD9TF/BTF)	GDS10032	Drive Shaft	54T	35	41	70	117	1085	
		1994.03-2002.04	MT	R	F	Box Engine DHX(XUD9TF/BTF)	GDS10069	Drive Shaft		28	37	63	112.5	1072	
		1994.03-2002.04	MT	R	F	Box Engine DHX(XUD9TF/BTF)	GDS10066	Drive Shaft		35	41	70	117	1085	
	1.9 TD (68 kW)		1994.03-2002.04	MT		F	Box Engine D8C(XUD9UTF)	GC010013	Outer Joint	54T	28	39	63	112.5	63
		1994.03-2002.04	MT		F	Box Engine D8C(XUD9UTF)	GC010050	Outer Joint		35	45	70	117	73	I
		1994.03-2002.04	MT		F	Box Engine D8C(XUD9UTF)	GC010012	Outer Joint		28	39	63	112.5	63	I
		1994.03-2002.04	MT		F	Box Engine D8C(XUD9UTF)	GC010011	Outer Joint	54T	35	45	70	117	73	I
		1994.03-2002.04	MT	L	F	Box Engine D8C(XUD9UTF)	GDS10035	Drive Shaft	54T	28	41	63	112.5	757.5	
		1994.03-2002.04	MT	L	F	Box Engine D8C(XUD9UTF)	GDS10102	Drive Shaft		28	41	63	112.5	757.5	
		1994.03-2002.04	MT	L	F	Box Engine D8C(XUD9UTF)	GDS10037	Drive Shaft	54T	28	37	63	112.5	771	
		1994.03-2002.04	MT	L	F	Box Engine D8C(XUD9UTF)	GDS10033	Drive Shaft	54T	35	41	70	117	762	
		1994.03-2002.04	MT	L	F	Box Engine D8C(XUD9UTF)	GDS10105	Drive Shaft		28	37	63	112.5	771	
		1994.03-2002.04	MT	L	F	Box Engine D8C(XUD9UTF)	GDS10067	Drive Shaft		35	41	70	117	762	
		1994.03-2002.04	MT	R	F	Box Engine D8C(XUD9UTF)	GDS10104	Drive Shaft	54T	28	37	63	112.5	1072	
		1994.03-2002.04	MT	R	F	Box Engine D8C(XUD9UTF)	GDS10032	Drive Shaft	54T	35	41	70	117	1085	
		1994.03-2002.04	MT	R	F	Box Engine D8C(XUD9UTF)	GDS10069	Drive Shaft		28	37	63	112.5	1072	
		1994.03-2002.04	MT	R	F	Box Engine D8C(XUD9UTF)	GDS10066	Drive Shaft		35	41	70	117	1085	
2.0 (80 kW)			1994.03-2002.04	MT		F	Box Engine RFW(XU10J2U)	GC010013	Outer Joint	54T	28	39	63	112.5	63
		1994.03-2002.04	MT		F	Box Engine RFW(XU10J2U)	GC010050	Outer Joint		35	45	70	117	73	I
		1994.03-2002.04	MT		F	Box Engine RFW(XU10J2U)	GC010012	Outer Joint		28	39	63	112.5	63	I
		1994.03-2002.04	MT		F	Box Engine RFW(XU10J2U)	GC010011	Outer Joint	54T	35	45	70	117	73	I
		1994.03-2002.04	MT	L	F	Box Engine RFW(XU10J2U)	GDS10035	Drive Shaft	54T	28	41	63	112.5	757.5	
		1994.03-2002.04	MT	L	F	Box Engine RFW(XU10J2U)	GDS10102	Drive Shaft		28	41	63	112.5	757.5	
		1994.03-2002.04	MT	L	F	Box Engine RFW(XU10J2U)	GDS10037	Drive Shaft	54T	28	37	63	112.5	771	
		1994.03-2002.04	MT	L	F	Box Engine RFW(XU10J2U)	GDS10033	Drive Shaft	54T	35	41	70	117	762	
		1994.03-2002.04	MT	L	F	Box Engine RFW(XU10J2U)	GDS10105	Drive Shaft		28	37	63	112.5	771	
		1994.03-2002.04	MT	L	F	Box Engine RFW(XU10J2U)	GDS10067	Drive Shaft		35	41	70	117	762	
		1994.03-2002.04	MT	R	F	Box Engine RFW(XU10J2U)	GDS10104	Drive Shaft	54T	28	37	63	112.5	1072	
		1994.03-2002.04	MT	R	F	Box Engine RFW(XU10J2U)	GDS10032	Drive Shaft	54T	35	41	70	117	1085	
		1994.03-2002.04	MT	R	F	Box Engine RFW(XU10J2U)	GDS10069	Drive Shaft		28	37	63	112.5	1072	
		1994.03-2002.04	MT	R	F	Box Engine RFW(XU10J2U)	GDS10066	Drive Shaft		35	41	70	117	1085	
	2.5 D (63 kW)		1994.03-2002.04	MT		F	Box Engine T9A(DJ5)	GC010013	Outer Joint	54T	28	39	63	112.5	63
		1994.03-2002.04	MT		F	Box Engine T9A(DJ5)	GC010050	Outer Joint		35	45	70	117	73	I
		1994.03-2002.04	MT		F	Box Engine T9A(DJ5)	GC010012	Outer Joint		28	39	63	112.5	63	I
		1994.03-2002.04	MT		F	Box Engine T9A(DJ5)	GC010011	Outer Joint	54T	35	45	70	117	73	I
		1994.03-2002.04	MT	L	F	Box Engine T9A(DJ5)	GDS10035	Drive Shaft	54T	28	41	63	112.5	757.5	
		1994.03-2002.04	MT	L	F	Box Engine T9A(DJ5)	GDS10102	Drive Shaft		28	41	63	112.5	757.5	
		1994.03-2002.04	MT	L	F	Box Engine T9A(DJ5)	GDS10037	Drive Shaft	54T	28	37	63	112.5	771	
		1994.03-2002.04	MT	L	F	Box Engine T9A(DJ5)	GDS10033	Drive Shaft	54T	35	41	70	117	762	
		1994.03-2002.04	MT	L	F	Box Engine T9A(DJ5)	GDS10105	Drive Shaft		28	37	63	112.5	771	
		1994.03-2002.04	MT	L	F	Box Engine T9A(DJ5)	GDS10067	Drive Shaft		35	41	70	117	762	
		1994.03-2002.04	MT	R	F	Box Engine T9A(DJ5)	GDS10104	Drive Shaft	54T	28	37	63	112.5	1072	
		1994.03-2002.04	MT	R	F	Box Engine T9A(DJ5)	GDS10032	Drive Shaft	54T	35	41	70	117	1085	
		1994.03-2002.04	MT	R	F	Box Engine T9A(DJ5)	GDS10069	Drive Shaft		28	37	63	112.5	1072	





		YEAR	TRANSM	L/R	F/R		G-AP Ref.	PRODUCT	ABS	Technical Specifications									
										A	B	C	H	L	P				
<b>CITROEN RELAY (230L)</b>																			
2.5 D (63 kW)	1994.03-	2002.04	MT	R	F	Box Engine T9A(DJ5)	GDS10066	Drive Shaft		35	41	70	117	1085					
	1994.03-	2002.04	MT	R	F	Box Engine T9A(DJ5)	GDS10036	Drive Shaft	54T	28	41	63	112.5	1079					
	1994.03-	2002.04	MT	R	F	Box Engine T9A(DJ5)	GDS10103	Drive Shaft		28	41	63	112.5	1079					
2.5 D 4x4 (63 kW)	2000.03-	2002.04	MT		F	Box Engine T9A(DJ5)	GC010013	Outer Joint	54T	28	39	63	112.5	63	I				
	2000.03-	2002.04	MT		F	Box Engine T9A(DJ5)	GC010050	Outer Joint		35	45	70	117	73	I				
	2000.03-	2002.04	MT		F	Box Engine T9A(DJ5)	GC010012	Outer Joint		28	39	63	112.5	63	I				
	2000.03-	2002.04	MT		F	Box Engine T9A(DJ5)	GC010011	Outer Joint	54T	35	45	70	117	73	I				
	2000.03-	2002.04	MT	L	F	Box Engine T9A(DJ5)	GDS10035	Drive Shaft	54T	28	41	63	112.5	757.5					
	2000.03-	2002.04	MT	L	F	Box Engine T9A(DJ5)	GDS10102	Drive Shaft		28	41	63	112.5	757.5					
	2000.03-	2002.04	MT	L	F	Box Engine T9A(DJ5)	GDS10037	Drive Shaft	54T	28	37	63	112.5	771					
	2000.03-	2002.04	MT	L	F	Box Engine T9A(DJ5)	GDS10033	Drive Shaft	54T	35	41	70	117	762					
	2000.03-	2002.04	MT	L	F	Box Engine T9A(DJ5)	GDS10105	Drive Shaft		28	37	63	112.5	771					
	2000.03-	2002.04	MT	L	F	Box Engine T9A(DJ5)	GDS10067	Drive Shaft		35	41	70	117	762					
	2000.03-	2002.04	MT	R	F	Box Engine T9A(DJ5)	GDS10104	Drive Shaft	54T	28	37	63	112.5	1072					
	2000.03-	2002.04	MT	R	F	Box Engine T9A(DJ5)	GDS10032	Drive Shaft	54T	35	41	70	117	1085					
	2000.03-	2002.04	MT	R	F	Box Engine T9A(DJ5)	GDS10069	Drive Shaft		28	37	63	112.5	1072					
	2000.03-	2002.04	MT	R	F	Box Engine T9A(DJ5)	GDS10066	Drive Shaft		35	41	70	117	1085					
	2000.03-	2002.04	MT	R	F	Box Engine T9A(DJ5)	GDS10036	Drive Shaft	54T	28	41	63	112.5	1079					
2000.03-	2002.04	MT	R	F	Box Engine T9A(DJ5)	GDS10103	Drive Shaft		28	41	63	112.5	1079						
2.5 TD (76 kW)	1994.03-	2002.04	MT		F	Box Engine T8A(DJ5T)	GC010013	Outer Joint	54T	28	39	63	112.5	63	I				
	1994.03-	2002.04	MT		F	Box Engine T8A(DJ5T)	GC010050	Outer Joint		35	45	70	117	73	I				
	1994.03-	2002.04	MT		F	Box Engine T8A(DJ5T)	GC010012	Outer Joint		28	39	63	112.5	63	I				
	1994.03-	2002.04	MT		F	Box Engine T8A(DJ5T)	GC010011	Outer Joint	54T	35	45	70	117	73	I				
	1994.03-	2002.04	MT	L	F	Box Engine T8A(DJ5T)	GDS10035	Drive Shaft	54T	28	41	63	112.5	757.5					
	1994.03-	2002.04	MT	L	F	Box Engine T8A(DJ5T)	GDS10102	Drive Shaft		28	41	63	112.5	757.5					
	1994.03-	2002.04	MT	L	F	Box Engine T8A(DJ5T)	GDS10037	Drive Shaft	54T	28	37	63	112.5	771					
	1994.03-	2002.04	MT	L	F	Box Engine T8A(DJ5T)	GDS10033	Drive Shaft	54T	35	41	70	117	762					
	1994.03-	2002.04	MT	L	F	Box Engine T8A(DJ5T)	GDS10105	Drive Shaft		28	37	63	112.5	771					
	1994.03-	2002.04	MT	L	F	Box Engine T8A(DJ5T)	GDS10067	Drive Shaft		35	41	70	117	762					
	1994.03-	2002.04	MT	R	F	Box Engine T8A(DJ5T)	GDS10104	Drive Shaft	54T	28	37	63	112.5	1072					
	1994.03-	2002.04	MT	R	F	Box Engine T8A(DJ5T)	GDS10032	Drive Shaft	54T	35	41	70	117	1085					
	1994.03-	2002.04	MT	R	F	Box Engine T8A(DJ5T)	GDS10069	Drive Shaft		28	37	63	112.5	1072					
	1994.03-	2002.04	MT	R	F	Box Engine T8A(DJ5T)	GDS10066	Drive Shaft		35	41	70	117	1085					
	1994.03-	2002.04	MT	R	F	Box Engine T8A(DJ5T)	GDS10036	Drive Shaft	54T	28	41	63	112.5	1079					
1994.03-	2002.04	MT	R	F	Box Engine T8A(DJ5T)	GDS10103	Drive Shaft		28	41	63	112.5	1079						
2.8 HDi (94 kW)	2000.09-	2002.04	MT		F	Box Engine 8140.43S	GC010050	Outer Joint		35	45	70	117	73	I				
	2000.09-	2002.04	MT		F	Box Engine 8140.43S	GC010011	Outer Joint	54T	35	45	70	117	73	I				
	2000.09-	2002.04	MT	L	F	Box Engine 8140.43S	GDS10033	Drive Shaft	54T	35	41	70	117	762					
	2000.09-	2002.04	MT	L	F	Box Engine 8140.43S	GDS10067	Drive Shaft		35	41	70	117	762					
	2000.09-	2002.04	MT	R	F	Box Engine 8140.43S	GDS10032	Drive Shaft	54T	35	41	70	117	1085					
	2000.09-	2002.04	MT	R	F	Box Engine 8140.43S	GDS10066	Drive Shaft		35	41	70	117	1085					
<b>RELAY (230P)</b>																			
1.9 D (51 kW)	1999.01-	2002.04	MT		F	Bus Engine D9B(XUD9A/U)	GC010013	Outer Joint	54T	28	39	63	112.5	63	I				
	1999.01-	2002.04	MT		F	Bus Engine D9B(XUD9A/U)	GC010050	Outer Joint		35	45	70	117	73	I				
	1999.01-	2002.04	MT		F	Bus Engine D9B(XUD9A/U)	GC010012	Outer Joint		28	39	63	112.5	63	I				
	1999.01-	2002.04	MT		F	Bus Engine D9B(XUD9A/U)	GC010011	Outer Joint	54T	35	45	70	117	73	I				
	1999.01-	2002.04	MT	L	F	Bus Engine D9B(XUD9A/U)	GDS10035	Drive Shaft	54T	28	41	63	112.5	757.5					
	1999.01-	2002.04	MT	L	F	Bus Engine D9B(XUD9A/U)	GDS10102	Drive Shaft		28	41	63	112.5	757.5					
	1999.01-	2002.04	MT	L	F	Bus Engine D9B(XUD9A/U)	GDS10037	Drive Shaft	54T	28	37	63	112.5	771					
	1999.01-	2002.04	MT	L	F	Bus Engine D9B(XUD9A/U)	GDS10033	Drive Shaft	54T	35	41	70	117	762					
	1999.01-	2002.04	MT	L	F	Bus Engine D9B(XUD9A/U)	GDS10105	Drive Shaft		28	37	63	112.5	771					
	1999.01-	2002.04	MT	L	F	Bus Engine D9B(XUD9A/U)	GDS10067	Drive Shaft		35	41	70	117	762					
	1999.01-	2002.04	MT	R	F	Bus Engine D9B(XUD9A/U)	GDS10104	Drive Shaft	54T	28	37	63	112.5	1072					
	1999.01-	2002.04	MT	R	F	Bus Engine D9B(XUD9A/U)	GDS10032	Drive Shaft	54T	35	41	70	117	1085					
	1999.01-	2002.04	MT	R	F	Bus Engine D9B(XUD9A/U)	GDS10069	Drive Shaft		28	37	63	112.5	1072					
	1999.01-	2002.04	MT	R	F	Bus Engine D9B(XUD9A/U)	GDS10066	Drive Shaft		35	41	70	117	1085					
	1999.01-	2002.04	MT	R	F	Bus Engine D9B(XUD9A/U)	GDS10036	Drive Shaft	54T	28	41	63	112.5	1079					
1999.01-	2002.04	MT	R	F	Bus Engine D9B(XUD9A/U)	GDS10103	Drive Shaft		28	41	63	112.5	1079						
1.9 TD (66 kW)	1994.08-	2002.04	MT	L	F	Bus Engine D8C(XUD9UTF)	GDS10105	Drive Shaft		28	37	63	112.5	771					
	1994.08-	2002.04	MT	L	F	Bus Engine D8C(XUD9UTF)	GDS10067	Drive Shaft		35	41	70	117	762					
	1994.08-	2002.04	MT	R	F	Bus Engine D8C(XUD9UTF)	GDS10104	Drive Shaft	54T	28	37	63	112.5	1072					
	1994.08-	2002.04	MT	R	F	Bus Engine D8C(XUD9UTF)	GDS10032	Drive Shaft	54T	35	41	70	117	1085					



		TRANSM	L/R	F/R		G-AP Ref.	PRODUCT	ABS	Technical Specifications									
									YEAR	A	B	C	H	L	P			
<b>CITROEN RELAY (230P)</b>																		
1.9 TD (66 kW)	1994.08-	2002.04	MT	R	F	Bus Engine D8C(XUD9UTF)	GDS10069	Drive Shaft		28	37	63	112.5	1072				
	1994.08-	2002.04	MT	R	F	Bus Engine D8C(XUD9UTF)	GDS10066	Drive Shaft		35	41	70	117	1085				
	1994.08-	2002.04	MT	R	F	Bus Engine D8C(XUD9UTF)	GDS10036	Drive Shaft	54T	28	41	63	112.5	1079				
	1994.08-	2002.04	MT	R	F	Bus Engine D8C(XUD9UTF)	GDS10103	Drive Shaft		28	41	63	112.5	1079				
	1994.08-	2002.04	MT		F	Bus Engine D8C(XUD9UTF)	GCO10013	Outer Joint	54T	28	39	63	112.5	63	I			
	1994.08-	2002.04	MT		F	Bus Engine D8C(XUD9UTF)	GCO10050	Outer Joint		35	45	70	117	73	I			
	1994.08-	2002.04	MT		F	Bus Engine D8C(XUD9UTF)	GCO10012	Outer Joint		28	39	63	112.5	63	I			
	1994.08-	2002.04	MT		F	Bus Engine D8C(XUD9UTF)	GCO10011	Outer Joint	54T	35	45	70	117	73	I			
	1994.08-	2002.04	MT	L	F	Bus Engine D8C(XUD9UTF)	GDS10035	Drive Shaft	54T	28	41	63	112.5	757.5				
	1994.08-	2002.04	MT	L	F	Bus Engine D8C(XUD9UTF)	GDS10102	Drive Shaft		28	41	63	112.5	757.5				
	1994.08-	2002.04	MT	L	F	Bus Engine D8C(XUD9UTF)	GDS10037	Drive Shaft	54T	28	37	63	112.5	771				
1.9 TD (68 kW)	1994.08-	2002.04	MT	L	F	Bus Engine D8C(XUD9UTF)	GDS10033	Drive Shaft	54T	28	41	63	112.5	771				
	1994.08-	2002.04	MT	L	F	Bus Engine D8C(XUD9UTF)	GDS10037	Drive Shaft	54T	28	37	63	112.5	771				
	1994.08-	2002.04	MT	L	F	Bus Engine D8C(XUD9UTF)	GDS10033	Drive Shaft	54T	35	41	70	117	762				
	1994.08-	2002.04	MT	L	F	Bus Engine D8C(XUD9UTF)	GDS10105	Drive Shaft		28	37	63	112.5	771				
	1994.08-	2002.04	MT	L	F	Bus Engine D8C(XUD9UTF)	GDS10067	Drive Shaft		35	41	70	117	762				
	1994.08-	2002.04	MT	R	F	Bus Engine D8C(XUD9UTF)	GDS10104	Drive Shaft	54T	28	37	63	112.5	1072				
	1994.08-	2002.04	MT	R	F	Bus Engine D8C(XUD9UTF)	GDS10032	Drive Shaft	54T	35	41	70	117	1085				
	1994.08-	2002.04	MT	R	F	Bus Engine D8C(XUD9UTF)	GDS10069	Drive Shaft		28	37	63	112.5	1072				
	1994.08-	2002.04	MT	R	F	Bus Engine D8C(XUD9UTF)	GDS10066	Drive Shaft		35	41	70	117	1085				
	1994.08-	2002.04	MT	R	F	Bus Engine D8C(XUD9UTF)	GDS10036	Drive Shaft	54T	28	41	63	112.5	1079				
	1994.08-	2002.04	MT	R	F	Bus Engine D8C(XUD9UTF)	GDS10103	Drive Shaft		28	41	63	112.5	1079				
	1994.08-	2002.04	MT	R	F	Bus Engine D8C(XUD9UTF)	GDS10032	Drive Shaft	54T	35	41	70	117	1085				
	1994.08-	2002.04	MT	R	F	Bus Engine D8C(XUD9UTF)	GDS10069	Drive Shaft		28	37	63	112.5	1072				
	1994.08-	2002.04	MT	R	F	Bus Engine D8C(XUD9UTF)	GDS10066	Drive Shaft		35	41	70	117	1085				
	1.9 TD 4x4 (68 kW)	1994.08-	2002.04	MT	R	F	Bus Engine D8C(XUD9UTF)	GDS10036	Drive Shaft	54T	28	41	63	112.5	1079			
1994.08-		2002.04	MT	R	F	Bus Engine D8C(XUD9UTF)	GDS10103	Drive Shaft		28	41	63	112.5	1079				
1994.08-		2002.04	MT	R	F	Bus Engine D8C(XUD9UTF)	GDS10032	Drive Shaft	54T	35	41	70	117	1085				
1994.08-		2002.04	MT	R	F	Bus Engine D8C(XUD9UTF)	GDS10069	Drive Shaft		28	37	63	112.5	1072				
1994.08-		2002.04	MT	R	F	Bus Engine D8C(XUD9UTF)	GDS10066	Drive Shaft		35	41	70	117	1085				
1994.08-		2002.04	MT	R	F	Bus Engine D8C(XUD9UTF)	GDS10036	Drive Shaft	54T	28	41	63	112.5	1079				
1994.08-		2002.04	MT	R	F	Bus Engine D8C(XUD9UTF)	GDS10103	Drive Shaft		28	41	63	112.5	1079				
1994.08-		2002.04	MT	R	F	Bus Engine D8C(XUD9UTF)	GDS10032	Drive Shaft	54T	35	41	70	117	1085				
1994.08-		2002.04	MT	R	F	Bus Engine D8C(XUD9UTF)	GDS10069	Drive Shaft		28	37	63	112.5	1072				
1994.08-		2002.04	MT	R	F	Bus Engine D8C(XUD9UTF)	GDS10066	Drive Shaft		35	41	70	117	1085				
1994.08-		2002.04	MT	R	F	Bus Engine D8C(XUD9UTF)	GDS10036	Drive Shaft	54T	28	41	63	112.5	1079				
1994.08-		2002.04	MT	R	F	Bus Engine D8C(XUD9UTF)	GDS10103	Drive Shaft		28	41	63	112.5	1079				
1994.08-		2002.04	MT	R	F	Bus Engine D8C(XUD9UTF)	GDS10032	Drive Shaft	54T	35	41	70	117	1085				
1994.08-		2002.04	MT	R	F	Bus Engine D8C(XUD9UTF)	GDS10069	Drive Shaft		28	37	63	112.5	1072				
2.0 (80 kW)		1994.02-	2002.04	MT		F	Bus Engine RFW(XU10J2U)	GCO10013	Outer Joint	54T	28	39	63	112.5	63	I		
	1994.02-	2002.04	MT		F	Bus Engine RFW(XU10J2U)	GCO10050	Outer Joint		35	45	70	117	73	I			
	1994.02-	2002.04	MT		F	Bus Engine RFW(XU10J2U)	GCO10012	Outer Joint		28	39	63	112.5	63	I			
	1994.02-	2002.04	MT		F	Bus Engine RFW(XU10J2U)	GCO10011	Outer Joint	54T	35	45	70	117	73	I			
	1994.02-	2002.04	MT	L	F	Bus Engine RFW(XU10J2U)	GDS10035	Drive Shaft	54T	28	41	63	112.5	757.5				
	1994.02-	2002.04	MT	L	F	Bus Engine RFW(XU10J2U)	GDS10102	Drive Shaft		28	41	63	112.5	757.5				
	1994.02-	2002.04	MT	L	F	Bus Engine RFW(XU10J2U)	GDS10037	Drive Shaft	54T	28	37	63	112.5	771				
	1994.02-	2002.04	MT	L	F	Bus Engine RFW(XU10J2U)	GDS10033	Drive Shaft	54T	35	41	70	117	762				
	1994.02-	2002.04	MT	L	F	Bus Engine RFW(XU10J2U)	GDS10105	Drive Shaft		28	37	63	112.5	771				
	1994.02-	2002.04	MT	L	F	Bus Engine RFW(XU10J2U)	GDS10067	Drive Shaft		35	41	70	117	762				
	1994.02-	2002.04	MT	R	F	Bus Engine RFW(XU10J2U)	GDS10104	Drive Shaft	54T	28	37	63	112.5	1072				
	1994.02-	2002.04	MT	R	F	Bus Engine RFW(XU10J2U)	GDS10036	Drive Shaft		35	41	70	117	1085				
	1994.02-	2002.04	MT	R	F	Bus Engine RFW(XU10J2U)	GDS10036	Drive Shaft	54T	28	41	63	112.5	1079				
	1994.02-	2002.04	MT	R	F	Bus Engine RFW(XU10J2U)	GDS10103	Drive Shaft		28	41	63	112.5	1079				
	1994.02-	2002.04	MT	R	F	Bus Engine RFW(XU10J2U)	GDS10032	Drive Shaft	54T	35	41	70	117	1085				
2.0 4x4 (80 kW)	1996.08-	2002.04	MT		F	Bus Engine RFW(XU10J2U)	GCO10013	Outer Joint	54T	28	39	63	112.5	63	I			
	1996.08-	2002.04	MT		F	Bus Engine RFW(XU10J2U)	GCO10050	Outer Joint		35	45	70	117	73	I			
	1996.08-	2002.04	MT		F	Bus Engine RFW(XU10J2U)	GCO10012	Outer Joint		28	39	63	112.5	63	I			





		YEAR	TRANSM	L/R	F/R		G-AP Ref.	PRODUCT	ABS	Technical Specifications					
										A	B	C	H	L	P
<b>CITROEN RELAY (230P)</b> 2.0 4x4 (80 kW)	1996.08-	2002.04	MT		F	Bus Engine RFW(XU10J2U)	GC010011	Outer Joint	54T	35	45	70	117	73	I
	1996.08-	2002.04	MT	L	F	Bus Engine RFW(XU10J2U)	GDS10035	Drive Shaft	54T	28	41	63	112.5	757.5	
	1996.08-	2002.04	MT	L	F	Bus Engine RFW(XU10J2U)	GDS10102	Drive Shaft		28	41	63	112.5	757.5	
	1996.08-	2002.04	MT	L	F	Bus Engine RFW(XU10J2U)	GDS10037	Drive Shaft	54T	28	37	63	112.5	771	
	1996.08-	2002.04	MT	L	F	Bus Engine RFW(XU10J2U)	GDS10033	Drive Shaft	54T	35	41	70	117	762	
	1996.08-	2002.04	MT	L	F	Bus Engine RFW(XU10J2U)	GDS10105	Drive Shaft		28	37	63	112.5	771	
	1996.08-	2002.04	MT	L	F	Bus Engine RFW(XU10J2U)	GDS10067	Drive Shaft		35	41	70	117	762	
	1996.08-	2002.04	MT	R	F	Bus Engine RFW(XU10J2U)	GDS10104	Drive Shaft	54T	28	37	63	112.5	1072	
	1996.08-	2002.04	MT	R	F	Bus Engine RFW(XU10J2U)	GDS10032	Drive Shaft	54T	35	41	70	117	1085	
	1996.08-	2002.04	MT	R	F	Bus Engine RFW(XU10J2U)	GDS10069	Drive Shaft		28	37	63	112.5	1072	
	1996.08-	2002.04	MT	R	F	Bus Engine RFW(XU10J2U)	GDS10066	Drive Shaft		35	41	70	117	1085	
	1996.08-	2002.04	MT	R	F	Bus Engine RFW(XU10J2U)	GDS10036	Drive Shaft	54T	28	41	63	112.5	1079	
1996.08-	2002.04	MT	R	F	Bus Engine RFW(XU10J2U)	GDS10103	Drive Shaft		28	41	63	112.5	1079		
2.5 D (63 kW)	1994.08-	2002.04	MT		F	Bus Engine T9A(DJ5)	GC010013	Outer Joint	54T	28	39	63	112.5	63	I
	1994.08-	2002.04	MT		F	Bus Engine T9A(DJ5)	GC010050	Outer Joint		35	45	70	117	73	I
	1994.08-	2002.04	MT		F	Bus Engine T9A(DJ5)	GC010012	Outer Joint		28	39	63	112.5	63	I
	1994.08-	2002.04	MT		F	Bus Engine T9A(DJ5)	GC010011	Outer Joint	54T	35	45	70	117	73	I
	1994.08-	2002.04	MT	L	F	Bus Engine T9A(DJ5)	GDS10067	Drive Shaft		35	41	70	117	762	
	1994.08-	2002.04	MT	L	F	Bus Engine T9A(DJ5)	GDS10035	Drive Shaft	54T	28	41	63	112.5	757.5	
	1994.08-	2002.04	MT	L	F	Bus Engine T9A(DJ5)	GDS10102	Drive Shaft		28	41	63	112.5	757.5	
	1994.08-	2002.04	MT	L	F	Bus Engine T9A(DJ5)	GDS10037	Drive Shaft	54T	28	37	63	112.5	771	
	1994.08-	2002.04	MT	L	F	Bus Engine T9A(DJ5)	GDS10033	Drive Shaft	54T	35	41	70	117	762	
	1994.08-	2002.04	MT	L	F	Bus Engine T9A(DJ5)	GDS10105	Drive Shaft		28	37	63	112.5	771	
	1994.08-	2002.04	MT	R	F	Bus Engine T9A(DJ5)	GDS10104	Drive Shaft	54T	28	37	63	112.5	1072	
	1994.08-	2002.04	MT	R	F	Bus Engine T9A(DJ5)	GDS10032	Drive Shaft	54T	35	41	70	117	1085	
	1994.08-	2002.04	MT	R	F	Bus Engine T9A(DJ5)	GDS10069	Drive Shaft		28	37	63	112.5	1072	
	1994.08-	2002.04	MT	R	F	Bus Engine T9A(DJ5)	GDS10066	Drive Shaft		35	41	70	117	1085	
	1994.08-	2002.04	MT	R	F	Bus Engine T9A(DJ5)	GDS10036	Drive Shaft	54T	28	41	63	112.5	1079	
	1994.08-	2002.04	MT	R	F	Bus Engine T9A(DJ5)	GDS10103	Drive Shaft		28	41	63	112.5	1079	
2.5 D 4x4 (63 kW)	1996.08-	2002.04	MT		F	Bus Engine T9A(DJ5)	GC010013	Outer Joint	54T	28	39	63	112.5	63	I
	1996.08-	2002.04	MT		F	Bus Engine T9A(DJ5)	GC010050	Outer Joint		35	45	70	117	73	I
	1996.08-	2002.04	MT		F	Bus Engine T9A(DJ5)	GC010012	Outer Joint		28	39	63	112.5	63	I
	1996.08-	2002.04	MT		F	Bus Engine T9A(DJ5)	GC010011	Outer Joint	54T	35	45	70	117	73	I
	1996.08-	2002.04	MT	L	F	Bus Engine T9A(DJ5)	GDS10067	Drive Shaft		35	41	70	117	762	
	1996.08-	2002.04	MT	L	F	Bus Engine T9A(DJ5)	GDS10035	Drive Shaft	54T	28	41	63	112.5	757.5	
	1996.08-	2002.04	MT	L	F	Bus Engine T9A(DJ5)	GDS10102	Drive Shaft		28	41	63	112.5	757.5	
	1996.08-	2002.04	MT	L	F	Bus Engine T9A(DJ5)	GDS10037	Drive Shaft	54T	28	37	63	112.5	771	
	1996.08-	2002.04	MT	L	F	Bus Engine T9A(DJ5)	GDS10033	Drive Shaft	54T	35	41	70	117	762	
	1996.08-	2002.04	MT	L	F	Bus Engine T9A(DJ5)	GDS10105	Drive Shaft		28	37	63	112.5	771	
	1996.08-	2002.04	MT	R	F	Bus Engine T9A(DJ5)	GDS10104	Drive Shaft	54T	28	37	63	112.5	1072	
	1996.08-	2002.04	MT	R	F	Bus Engine T9A(DJ5)	GDS10032	Drive Shaft	54T	35	41	70	117	1085	
	1996.08-	2002.04	MT	R	F	Bus Engine T9A(DJ5)	GDS10069	Drive Shaft		28	37	63	112.5	1072	
	1996.08-	2002.04	MT	R	F	Bus Engine T9A(DJ5)	GDS10066	Drive Shaft		35	41	70	117	1085	
	1996.08-	2002.04	MT	R	F	Bus Engine T9A(DJ5)	GDS10036	Drive Shaft	54T	28	41	63	112.5	1079	
	1996.08-	2002.04	MT	R	F	Bus Engine T9A(DJ5)	GDS10103	Drive Shaft		28	41	63	112.5	1079	
2.5 TD (76 kW)	1994.08-	2002.04	MT		F	Bus Engine T8A(DJ5T)	GC010013	Outer Joint	54T	28	39	63	112.5	63	I
	1994.08-	2002.04	MT		F	Bus Engine T8A(DJ5T)	GC010050	Outer Joint		35	45	70	117	73	I
	1994.08-	2002.04	MT		F	Bus Engine T8A(DJ5T)	GC010012	Outer Joint		28	39	63	112.5	63	I
	1994.08-	2002.04	MT		F	Bus Engine T8A(DJ5T)	GC010011	Outer Joint	54T	35	45	70	117	73	I
	1994.08-	2002.04	MT	L	F	Bus Engine T8A(DJ5T)	GDS10067	Drive Shaft		35	41	70	117	762	
	1994.08-	2002.04	MT	L	F	Bus Engine T8A(DJ5T)	GDS10035	Drive Shaft	54T	28	41	63	112.5	757.5	
	1994.08-	2002.04	MT	L	F	Bus Engine T8A(DJ5T)	GDS10102	Drive Shaft		28	41	63	112.5	757.5	
	1994.08-	2002.04	MT	L	F	Bus Engine T8A(DJ5T)	GDS10037	Drive Shaft	54T	28	37	63	112.5	771	
	1994.08-	2002.04	MT	L	F	Bus Engine T8A(DJ5T)	GDS10033	Drive Shaft	54T	35	41	70	117	762	
	1994.08-	2002.04	MT	L	F	Bus Engine T8A(DJ5T)	GDS10105	Drive Shaft		28	37	63	112.5	771	
	1994.08-	2002.04	MT	R	F	Bus Engine T8A(DJ5T)	GDS10104	Drive Shaft	54T	28	37	63	112.5	1072	
	1994.08-	2002.04	MT	R	F	Bus Engine T8A(DJ5T)	GDS10032	Drive Shaft	54T	35	41	70	117	1085	
	1994.08-	2002.04	MT	R	F	Bus Engine T8A(DJ5T)	GDS10069	Drive Shaft		28	37	63	112.5	1072	
	1994.08-	2002.04	MT	R	F	Bus Engine T8A(DJ5T)	GDS10066	Drive Shaft		35	41	70	117	1085	
	1994.08-	2002.04	MT	R	F	Bus Engine T8A(DJ5T)	GDS10036	Drive Shaft	54T	28	41	63	112.5	1079	
	1994.08-	2002.04	MT	R	F	Bus Engine T8A(DJ5T)	GDS10103	Drive Shaft		28	41	63	112.5	1079	
2.5 TD 4x4 (76 kW)	1996.08-	2002.04	MT		F	Bus Engine T8A(DJ5T)	GC010013	Outer Joint	54T	28	39	63	112.5	63	I
	1996.08-	2002.04	MT		F	Bus Engine T8A(DJ5T)	GC010050	Outer Joint		35	45	70	117	73	I





		YEAR	TRANSM	L/R	F/R		G-AP Ref.	PRODUCT	ABS	Technical Specifications										
										A	B	C	H	L	P					
<b>CITROEN RELAY (230P)</b>																				
2.5 TD 4x4 (76 kW)	1996.08-	2002.04	MT		F	Bus Engine T8A(DJ5T)	GC010012	Outer Joint		28	39	63	112.5	63	I					
	1996.08-	2002.04	MT		F	Bus Engine T8A(DJ5T)	GC010011	Outer Joint	54T	35	45	70	117	73	I					
	1996.08-	2002.04	MT	L	F	Bus Engine T8A(DJ5T)	GDS10067	Drive Shaft		35	41	70	117	762						
	1996.08-	2002.04	MT	L	F	Bus Engine T8A(DJ5T)	GDS10035	Drive Shaft	54T	28	41	63	112.5	757.5						
	1996.08-	2002.04	MT	L	F	Bus Engine T8A(DJ5T)	GDS10102	Drive Shaft		28	41	63	112.5	757.5						
	1996.08-	2002.04	MT	L	F	Bus Engine T8A(DJ5T)	GDS10037	Drive Shaft	54T	28	37	63	112.5	771						
	1996.08-	2002.04	MT	L	F	Bus Engine T8A(DJ5T)	GDS10033	Drive Shaft	54T	35	41	70	117	762						
	1996.08-	2002.04	MT	L	F	Bus Engine T8A(DJ5T)	GDS10105	Drive Shaft		28	37	63	112.5	771						
	1996.08-	2002.04	MT	R	F	Bus Engine T8A(DJ5T)	GDS10104	Drive Shaft	54T	28	37	63	112.5	1072						
	1996.08-	2002.04	MT	R	F	Bus Engine T8A(DJ5T)	GDS10032	Drive Shaft	54T	35	41	70	117	1085						
	1996.08-	2002.04	MT	R	F	Bus Engine T8A(DJ5T)	GDS10069	Drive Shaft		28	37	63	112.5	1072						
	1996.08-	2002.04	MT	R	F	Bus Engine T8A(DJ5T)	GDS10066	Drive Shaft		35	41	70	117	1085						
	1996.08-	2002.04	MT	R	F	Bus Engine T8A(DJ5T)	GDS10036	Drive Shaft	54T	28	41	63	112.5	1079						
	1996.08-	2002.04	MT	R	F	Bus Engine T8A(DJ5T)	GDS10103	Drive Shaft		28	41	63	112.5	1079						
2.8 HDi (94 kW)	2000.09-	2002.04	MT		F	Bus Engine 8140.43S	GC010050	Outer Joint		35	45	70	117	73	I					
	2000.09-	2002.04	MT		F	Bus Engine 8140.43S	GC010011	Outer Joint	54T	35	45	70	117	73	I					
	2000.09-	2002.04	MT	L	F	Bus Engine 8140.43S	GDS10067	Drive Shaft		35	41	70	117	762						
	2000.09-	2002.04	MT	L	F	Bus Engine 8140.43S	GDS10033	Drive Shaft	54T	35	41	70	117	762						
	2000.09-	2002.04	MT	R	F	Bus Engine 8140.43S	GDS10032	Drive Shaft	54T	35	41	70	117	1085						
	2000.09-	2002.04	MT	R	F	Bus Engine 8140.43S	GDS10066	Drive Shaft		35	41	70	117	1085						
<b>RELAY (244)</b>																				
2.0 (81 kW)	2002.04-		MT		F	Box Engine XU10J2	GC010013	Outer Joint	54T	28	39	63	112.5	63	I					
	2002.04-		MT		F	Box Engine XU10J2	GC010011	Outer Joint	54T	35	45	70	117	73	I					
2.0 HDi (62 kW)	2002.04-		MT		F	Box Engine RHV(DW10TD)/RHV(DW10UTD)	GC010013	Outer Joint	54T	28	39	63	112.5	63	I					
	2002.04-		MT		F	Platform/Chassis Engine RHV(DW10UTD)	GC010013	Outer Joint	54T	28	39	63	112.5	63	I					
2.8 HDi (94 kW)	2002.04-		MT		F	Box Engine 8140.43S	GC010013	Outer Joint	54T	28	39	63	112.5	63	I					
	2002.04-		MT		F	Box Engine 8140.43S	GC010011	Outer Joint	54T	35	45	70	117	73	I					
	2002.04-		MT		F	Platform/Chassis Engine 8140.43S	GC010013	Outer Joint	54T	28	39	63	112.5	63	I					
	2002.04-		MT		F	Platform/Chassis Engine 8140.43S	GC010011	Outer Joint	54T	35	45	70	117	73	I					
2.8 HDi 4x4 (94 kW)	2002.04-		MT		F	Box Engine 8140.43S	GC010013	Outer Joint	54T	28	39	63	112.5	63	I					
<b>RELAY (244, Z_)</b>																				
2.0 (81 kW)	2002.04-		MT		F	Bus Engine XU10J2	GC010013	Outer Joint	54T	28	39	63	112.5	63	I					
	2002.04-		MT		F	Bus Engine XU10J2	GC010011	Outer Joint	54T	35	45	70	117	73	I					
2.0 HDi (62 kW)	2002.04-		MT		F	Bus Engine RHV(DW10UTD)	GC010013	Outer Joint	54T	28	39	63	112.5	63	I					
2.8 HDi (94 kW)	2002.04-		MT		F	Bus Engine 8140.43S	GC010013	Outer Joint	54T	28	39	63	112.5	63	I					
	2002.04-		MT		F	Bus Engine 8140.43S	GC010011	Outer Joint	54T	35	45	70	117	73	I					
<b>RELAY VNA</b>																				
2.2 HDi (74 kW)	2006.04-		5MT/6MT		F	Box Engine 4HV(P22DTE)	GC017045	Outer Joint		35	29	71.5	127	71	M					
	2006.04-		5MT/6MT		F	Box Engine 4HV(P22DTE)	GC017055	Outer Joint		35	27	71.5	127	66.5	I					
	2006.04-		5MT/6MT		F	Box Engine 4HV(P22DTE)	GCI17020	Inner Joint		41	29	34.85	403	109						
	2006.04-		5MT/6MT		F	Box Engine 4HV(P22DTE)	GCI10038	Inner Joint		41	27	34.85	403	102						
	2006.04-		5MT/6MT	L	F	Box Engine 4HV(P22DTE)	GCI17028	Inner Joint		41	29	43	69.5	109.5						
	2006.04-		5MT/6MT	L	F	Box Engine 4HV(P22DTE)	GCI17042	Inner Joint		41	27	43	70	102						
	2006.04-			L	F	Box Engine 4HV(P22DTE)	GDS45176	Drive Shaft		35	41	71.5	127	808						
	2006.04-			R	F	Box Engine 4HV(P22DTE)	GDS17050	Drive Shaft		35	41	71.5	127	1140						
	2006.04-																			
2.2 HDi (88 kW)	2006.04-		5MT/6MT		F	Box Engine 4HU(P22DTE)	GC017045	Outer Joint		35	29	71.5	127	71	M					
	2006.04-		5MT/6MT		F	Box Engine 4HU(P22DTE)	GC017055	Outer Joint		35	27	71.5	127	66.5	I					
	2006.04-		5MT/6MT		F	Box Engine 4HU(P22DTE)	GCI17020	Inner Joint		41	29	34.85	403	109						
	2006.04-		5MT/6MT		F	Box Engine 4HU(P22DTE)	GCI10038	Inner Joint		41	27	34.85	403	102						
	2006.04-		5MT/6MT	L	F	Box Engine 4HU(P22DTE)	GCI17028	Inner Joint		41	29	43	69.5	109.5						
	2006.04-		5MT/6MT	L	F	Box Engine 4HU(P22DTE)	GCI17042	Inner Joint		41	27	43	70	102						
	2006.04-			L	F	Box Engine 4HU(P22DTE)	GDS45176	Drive Shaft		35	41	71.5	127	808						
	2006.04-			R	F	Box Engine 4HU(P22DTE)	GDS17050	Drive Shaft		35	41	71.5	127	1140						
3.0 HDi (116 kW)	2006.09-		6MT		F	Box Engine F1CE0481D(F30DT)	GC017060	Outer Joint		35	29	71.5	127	71	I					
	2006.09-		6MT		F	Box Engine F1CE0481D(F30DT)	GCI17021	Inner Joint		31	29	34.85	530	109						
	2006.09-		6MT		F	Box Engine F1CE0481D(F30DT)	GCI17022	Inner Joint		31	29	44.95	77	109.5						
	2006.09-			L	F	Box Engine F1CE0481D(F30DT)	GDS45175	Drive Shaft		35	31	71.5	127	749.5						
	2006.09-			L	F	Box Engine F1CE0481D(F30DT)	GCI17022	Inner Joint		31	29	44.95	77	109.5						
	2006.09-			L/R	F	Box Engine F1CE0481D(F30DT)	GC017060	Outer Joint		35	29	71.5	127	71	I					
	2006.09-			R	F	Box Engine F1CE0481D(F30DT)	GDS45174	Drive Shaft		35	31	71.5	127	1199						
	2006.09-			R	F	Box Engine F1CE0481D(F30DT)	GCI17021	Inner Joint		31	29	34.85	530	109						



		TRANSM	L/R	F/R		G-AP Ref.	PRODUCT	ABS	Technical Specifications								
									YEAR	A	B	C	H	L	P		
<b>CITROEN SAXO</b>																	
						GCI10006	Inner Joint		22	22	40	58.5	87				
			L			GDS10045	Drive Shaft	48T	21	22	50	86.5	625				
<b>SAXO (S0, S1)</b>																	
1.0 X (37 kW)	1998.05-2003.06	MT	L	F	Hatchback Engine CDZ(TU9M)	GDS10161	Drive Shaft		21	22	58.5	86	624				
	1998.05-2003.06	MT	L	F	Hatchback Engine CDZ(TU9M)	GDS10009	Drive Shaft		21	22	50	81.5	618				
	1998.05-2003.06	MT	L	F	Hatchback Engine CDZ(TU9M)	GDS99006	Drive Shaft	48T	21	22	58.5	86	624				
	1998.05-2003.06	MT	L	F	Hatchback Engine CDZ(TU9M)	GDS10164	Drive Shaft		21	22	58.5	76	614				
	1998.05-2003.06	MT	L/R	F	Hatchback Engine CDZ(TU9M)	GC010034	Outer Joint		21	20	50	81.5	54	O			
	1998.05-2003.06		R	F	Hatchback Engine CDZ(TU9M)	GDS10186	Drive Shaft	48T	21	22	54	75.5	799				
	1998.05-2003.06	MT	R	F	Hatchback Engine CDZ(TU9M)	GDS10156	Drive Shaft		21	22	58.5	86	807				
	1998.05-2003.06	MT	R	F	Hatchback Engine CDZ(TU9M)	GDS10008	Drive Shaft		21	22	50	81.5	800				
1.1 X,SX (40 kW)	1996.05-2003.09	MT	L	F	Hatchback Engine HDZ(TU1M)	GDS10161	Drive Shaft		21	22	58.5	86	624				
	1996.05-2003.09	MT	L	F	Hatchback Engine HDZ(TU1M)	GDS10009	Drive Shaft		21	22	50	81.5	618				
	1996.05-2003.09	MT	L	F	Hatchback Engine HDZ(TU1M)	GDS99006	Drive Shaft	48T	21	22	58.5	86	624				
	1996.05-2003.09	MT	L	F	Hatchback Engine HDZ(TU1M)	GDS10164	Drive Shaft		21	22	58.5	76	614				
	1996.05-2003.09	MT	L	F	Hatchback Engine HDZ(TU1M)	GDS10038	Drive Shaft	48T	21	22	58.5	76	614				
	1996.05-2003.09	MT	L/R	F	Hatchback Engine HDZ(TU1M)	GC010034	Outer Joint		21	20	50	81.5	54	O			
	1996.05-2003.09		R	F	Hatchback Engine HDZ(TU1M)	GDS10186	Drive Shaft	48T	21	22	54	75.5	799				
	1996.05-2003.09	MT	R	F	Hatchback Engine HDZ(TU1M)	GDS10156	Drive Shaft		21	22	58.5	86	807				
1.1 X,SX (44 kW)	1996.05-2003.09	MT	R	F	Hatchback Engine HDZ(TU1M)	GDS10008	Drive Shaft		21	22	50	81.5	800				
	1996.05-2003.09	MT	R	F	Hatchback Engine HDZ(TU1M)	GDS99010	Drive Shaft	48T	21	22	58.5	86	807				
	1996.05-2003.09	MT	L	F	Hatchback Engine HDZ(TU1M)/HFX(TU1JP)	GDS10161	Drive Shaft		21	22	58.5	86	624				
	1996.05-2003.09	MT	L	F	Hatchback Engine HDZ(TU1M)/HFX(TU1JP)	GDS10009	Drive Shaft		21	22	50	81.5	618				
	1996.05-2003.09	MT	L	F	Hatchback Engine HDZ(TU1M)/HFX(TU1JP)	GDS99006	Drive Shaft	48T	21	22	58.5	86	624				
	1996.05-2003.09	MT	L	F	Hatchback Engine HDZ(TU1M)/HFX(TU1JP)	GDS10164	Drive Shaft		21	22	58.5	76	614				
	1996.05-2003.09	MT	L/R	F	Hatchback Engine HDZ(TU1M)/HFX(TU1JP)	GC010034	Outer Joint		21	20	50	81.5	54	O			
	1996.05-2003.09		R	F	Hatchback Engine HDZ(TU1M)/HFX(TU1JP)	GDS10186	Drive Shaft	48T	21	22	54	75.5	799				
1.4 VTS (55 kW)	1996.05-2003.09	MT	R	F	Hatchback Engine HDZ(TU1M)/HFX(TU1JP)	GDS10156	Drive Shaft		21	22	58.5	86	807				
	1996.05-2003.09	MT	R	F	Hatchback Engine HDZ(TU1M)/HFX(TU1JP)	GDS10008	Drive Shaft		21	22	50	81.5	800				
	1996.05-2003.09	MT	R	F	Hatchback Engine HDZ(TU1M)/HFX(TU1JP)	GDS99010	Drive Shaft	48T	21	22	58.5	86	807				
	1996.05-2003.09	MT	R	F	Hatchback Engine HDZ(TU1M)/HFX(TU1JP)	GDS10038	Drive Shaft	48T	21	22	58.5	76	614				
	1996.05-2003.06	AT	L	F	Hatchback Engine KFW(TU3JP)/KFX(TU3JP)	GDS10138	Drive Shaft	48T	21	29.95	50	86	603.5				
	1996.05-2003.06	MT	L	F	Hatchback Engine KFW(TU3JP)/KFX(TU3JP)	GDS10161	Drive Shaft		21	22	58.5	86	624				
	1996.05-2003.06	MT	L	F	Hatchback Engine KFW(TU3JP)/KFX(TU3JP)	GDS99006	Drive Shaft	48T	21	22	58.5	86	624				
	1996.05-2003.06	MT	L	F	Hatchback Engine KFW(TU3JP)/KFX(TU3JP)	GDS10164	Drive Shaft		21	22	58.5	76	614				
1.5 D (40 kW)	1996.09-2003.09	MT	L	F	Hatchback Engine VJY(TUD5)	GDS10164	Drive Shaft		21	22	58.5	76	614				
	1996.09-2003.09	MT	L	F	Hatchback Engine VJY(TUD5)	GDS99007	Drive Shaft	48T	21	22	58.5	76	608				
	1996.09-2003.09	MT	L	F	Hatchback Engine VJY(TUD5)	GDS99006	Drive Shaft	48T	21	22	58.5	86	624				
	1996.09-2003.09		R	F	Hatchback Engine VJY(TUD5)	GDS10186	Drive Shaft	48T	21	22	54	75.5	799				
	1996.09-2003.09	MT	R	F	Hatchback Engine VJY(TUD5)	GDS10156	Drive Shaft		21	22	58.5	86	807				
	1996.09-2003.09	MT	R	F	Hatchback Engine VJY(TUD5)	GDS99010	Drive Shaft	48T	21	22	58.5	86	807				
1.5 D (43 kW)	2001.07-2004.04		R	F	Hatchback	GDS10186	Drive Shaft	48T	21	22	54	75.5	799				
1.6 (66 kW)	1996.02-2003.06	MT	L	F	Hatchback Engine NFZ(TU5JP)	GDS10020	Drive Shaft	48T	21	22	58.5	76	615				
	1996.02-2003.06	MT	L	F	Hatchback Engine NFZ(TU5JP)	GDS10157	Drive Shaft		21	22	58.5	86	616				
	1996.02-2003.06	MT	L	F	Hatchback Engine NFZ(TU5JP)	GDS10048	Drive Shaft	48T	21	22	58.5	86	616				
	1996.02-2003.06	AT	R	F	Hatchback Engine NFZ(TU5JP)	GDS99014	Drive Shaft		21	23	56	76	704.5				
	1996.02-2003.06	MT	R	F	Hatchback Engine NFZ(TU5JP)	GDS99158	Drive Shaft	48T	21	22	54	75.5	801				
	1996.02-2003.06	MT	R	F	Hatchback Engine NFZ(TU5JP)	GDS10174	Drive Shaft	48T	21	22	58.5	76	800				
	1996.02-2003.06	MT	R	F	Hatchback Engine NFZ(TU5JP)	GDS10152	Drive Shaft		21	22	50	85	812				
1.6 (74 kW)	1996.02-2003.06	MT	R	F	Hatchback Engine NFZ(TU5JP)	GDS10049	Drive Shaft	48T	21	22	58.5	86	811.5				
	2001.02-2004.04		L	F	Hatchback Engine NFT	GDS10157	Drive Shaft		21	22	58.5	86	616				
	2001.02-2004.04		L	F	Hatchback Engine NFT	GDS10048	Drive Shaft	48T	21	22	58.5	86	616				
	2001.02-2004.04	MT	L	F	Hatchback Engine NFT	GDS99027	Drive Shaft		21	22	50	86	620				
	2001.02-2004.04		R	F	Hatchback Engine NFT	GDS10152	Drive Shaft		21	22	50	85	812				
1.6 (88 kW)	2001.02-2004.04		R	F	Hatchback Engine NFT	GDS10049	Drive Shaft	48T	21	22	58.5	86	811.5				
	2001.02-2004.04	MT	R	F	Hatchback Engine NFT	GDS99026	Drive Shaft		21	22	50	86	815				
	1996.02-2004.04		L	F	Hatchback Engine NFX(TU5JP4)	GDS10020	Drive Shaft	48T	21	22	58.5	76	615				





		TRANSM	L/R	F/R		G-AP Ref.	PRODUCT	ABS	Technical Specifications								
									YEAR	A	B	C	H	L	P		
<b>CITROEN SAXO (S0, S1)</b>																	
1.6 (88 kW)	1996.02-	2004.04		L	F	Hatchback Engine NFX(TU5JP4)	GDS10157	Drive Shaft		21	22	58.5	86	616			
	1996.02-	2004.04		L	F	Hatchback Engine NFX(TU5JP4)	GDS10048	Drive Shaft	48T	21	22	58.5	86	616			
	1996.02-	2004.04	MT	L	F	Hatchback Engine NFX(TU5JP4)	GDS99027	Drive Shaft		21	22	50	86	620			
	1996.02-	2004.04		R	F	Hatchback Engine NFX(TU5JP4)	GDS10174	Drive Shaft	48T	21	22	58.5	76	800			
	1996.02-	2004.04		R	F	Hatchback Engine NFX(TU5JP4)	GDS10152	Drive Shaft		21	22	50	85	812			
	1996.02-	2004.04		R	F	Hatchback Engine NFX(TU5JP4)	GDS10049	Drive Shaft	48T	21	22	58.5	86	811.5			
	1996.02-	2004.04	AT	R	F	Hatchback Engine NFX(TU5JP4)	GDS99014	Drive Shaft		21	23	56	76	704.5			
	1996.02-	2004.04	MT	R	F	Hatchback Engine NFX(TU5JP4)	GDS99026	Drive Shaft		21	22	50	86	815			
1.6 VTL,VTR (65 kW)	1996.05-	2003.06	MT	R	F	Hatchback Engine NFZ(TU5JP)	GDS10174	Drive Shaft	48T	21	22	58.5	76	800			
	1996.05-	2003.06	MT	R	F	Hatchback Engine NFZ(TU5JP)	GDS10118	Drive Shaft		21	22	56.4	76	800			
	1996.05-	2003.06	MT	R	F	Hatchback Engine NFZ(TU5JP)	GDS10152	Drive Shaft		21	22	50	85	812			
	1996.05-	2003.06	MT	R	F	Hatchback Engine NFZ(TU5JP)	GDS10049	Drive Shaft	48T	21	22	58.5	86	811.5			
	1996.05-	2003.06	AT	L	F	Hatchback Engine NFZ(TU5JP)	GDS10138	Drive Shaft	48T	21	29.95	50	86	603.5			
	1996.05-	2003.06	MT	L	F	Hatchback Engine NFZ(TU5JP)	GDS10020	Drive Shaft	48T	21	22	58.5	76	615			
	1996.05-	2003.06	MT	L	F	Hatchback Engine NFZ(TU5JP)	GDS10159	Drive Shaft		21	22	58.5	76	615			
	1996.05-	2003.06	MT	L	F	Hatchback Engine NFZ(TU5JP)	GDS10157	Drive Shaft		21	22	58.5	86	616			
	1996.05-	2003.06	MT	L	F	Hatchback Engine NFZ(TU5JP)	GDS10048	Drive Shaft	48T	21	22	58.5	86	616			
	1996.05-	2003.06	AT	R	F	Hatchback Engine NFZ(TU5JP)	GDS99014	Drive Shaft		21	23	56	76	704.5			
1996.05-	2003.06	MT	R	F	Hatchback Engine NFZ(TU5JP)	GDS99158	Drive Shaft	48T	21	22	54	75.5	801				
1.6 VTS (72 kW)	2000.09-	2003.09		L	F	Hatchback Engine NFT	GDS10157	Drive Shaft		21	22	58.5	86	616			
	2000.09-	2003.09		L	F	Hatchback Engine NFT	GDS10048	Drive Shaft	48T	21	22	58.5	86	616			
	2000.09-	2003.09	MT	L	F	Hatchback Engine NFT	GDS99027	Drive Shaft		21	22	50	86	620			
	2000.09-	2003.09		R	F	Hatchback Engine NFT	GDS10152	Drive Shaft		21	22	50	85	812			
	2000.09-	2003.09		R	F	Hatchback Engine NFT	GDS10049	Drive Shaft	48T	21	22	58.5	86	811.5			
	2000.09-	2003.09	MT	R	F	Hatchback Engine NFT	GDS99026	Drive Shaft		21	22	50	86	815			
1.6 VTS (87 kW)	1996.06-	2003.09	MT	L	F	Hatchback Engine NFX(TU5JP4)	GDS99027	Drive Shaft		21	22	50	86	620			
	1996.06-	2003.09	MT	L	F	Hatchback Engine NFX(TU5JP4)	GDS10020	Drive Shaft	48T	21	22	58.5	76	615			
	1996.06-	2003.09	MT	L	F	Hatchback Engine NFX(TU5JP4)	GDS10159	Drive Shaft		21	22	58.5	76	615			
	1996.06-	2003.09	MT	L	F	Hatchback Engine NFX(TU5JP4)	GDS10157	Drive Shaft		21	22	58.5	86	616			
	1996.06-	2003.09	MT	L	F	Hatchback Engine NFX(TU5JP4)	GDS10048	Drive Shaft	48T	21	22	58.5	86	616			
	1996.06-	2003.09	MT	R	F	Hatchback Engine NFX(TU5JP4)	GDS99026	Drive Shaft		21	22	50	86	815			
	1996.06-	2003.09	MT	R	F	Hatchback Engine NFX(TU5JP4)	GDS10174	Drive Shaft	48T	21	22	58.5	76	800			
	1996.06-	2003.09	MT	R	F	Hatchback Engine NFX(TU5JP4)	GDS10118	Drive Shaft		21	22	56.4	76	800			
	1996.06-	2003.09	MT	R	F	Hatchback Engine NFX(TU5JP4)	GDS10152	Drive Shaft		21	22	50	85	812			
1996.06-	2003.09	MT	R	F	Hatchback Engine NFX(TU5JP4)	GDS10049	Drive Shaft	48T	21	22	58.5	86	811.5				
<b>SAXO II</b>																	
1.0/1.1	1999.10-		MT	R	F		GDS10046	Drive Shaft		21	22	50	86.5	806			
1.4/1.5 D	1999.10-		MT	R	F		GDS10046	Drive Shaft		21	22	50	86.5	806			
1.6 16V	1999.10-		MT	R	F		GDS10119	Drive Shaft	48T	21	22	50	85	812			
1.6 8V	1999.10-		MT	R	F		GDS10119	Drive Shaft	48T	21	22	50	85	812			
<b>SYNERGIE (22, U6)</b>																	
1.8 (73 kW)	1997.05-	2002.07			F	MPV Engine LFZ(XU7JP)	GC010018	Outer Joint	48T	27	34	61	82	55	I		
	1997.05-	2002.07	MT	L	F	MPV Engine LFZ(XU7JP)	GDS10052	Drive Shaft		27	24	61	82	648			
	1997.05-	2002.07	MT	L	F	MPV Engine LFZ(XU7JP)	GDS10082	Drive Shaft	48T	27	24	59	82	648			
	1997.05-	2002.07	MT	R	F	MPV Engine LFZ(XU7JP)	GDS10120	Drive Shaft		27	24	59	82	928			
	1997.05-	2002.07	MT	R	F	MPV Engine LFZ(XU7JP)	GDS10012	Drive Shaft	48T	27	24	64	80.5	928			
1.9 TD (66 kW)	1994.11-	2002.07			F	MPV Engine D8B(XUD9TF)/DHX(XUD9TF/BTF)	GC010015	Outer Joint	48T	27	39	59	82	63	I		
	1994.11-	2002.07	MT	L	F	MPV Engine D8B(XUD9TF)/DHX(XUD9TF/BTF)	GDS10016	Drive Shaft	48T	27	37	59	82	641			
	1994.11-	2002.07	MT	L	F	MPV Engine D8B(XUD9TF)/DHX(XUD9TF/BTF)	GDS10072	Drive Shaft		27	37	59	82	641			
	1994.11-	2002.07	MT	R	F	MPV Engine D8B(XUD9TF)/DHX(XUD9TF/BTF)	GDS10155	Drive Shaft		27	37	59	82	947			
	1994.11-	2002.07	MT	R	F	MPV Engine D8B(XUD9TF)/DHX(XUD9TF/BTF)	GDS10014	Drive Shaft	48T	27	37	59	82	947			
2.0 (89 kW)	1994.06-	2002.07			F	MPV Engine RFU(XU10J2/C)	GC010059	Outer Joint	48T	27	34	59	82	55	I		
	1994.06-	2002.07			F	MPV Engine RFU(XU10J2/C)	GC010016	Outer Joint		27	34	59	82	55	I		
	1994.06-	2002.07			F	MPV Engine RFU(XU10J2/C)	GC010018	Outer Joint	48T	27	34	61	82	55	I		
	1994.06-	2002.07	MT	L	F	MPV Engine RFU(XU10J2/C)	GDS10052	Drive Shaft		27	24	61	82	648			
	1994.06-	2002.07	MT	L	F	MPV Engine RFU(XU10J2/C)	GDS10082	Drive Shaft	48T	27	24	59	82	648			
	1994.06-	2002.07	MT	R	F	MPV Engine RFU(XU10J2/C)	GDS10120	Drive Shaft		27	24	59	82	928			
	1994.06-	2002.07	MT	R	F	MPV Engine RFU(XU10J2/C)	GDS10012	Drive Shaft	48T	27	24	64	80.5	928			
2.0 16V (100 kW)	2000.05-	2002.07			F	MPV Engine RFN(EW10J4)	GC010018	Outer Joint	48T	27	34	61	82	55	I		
2.0 HDi (80 kW)	1999.08-	2002.07			F	MPV Engine RHZ(DW10ATED)	GC010014	Outer Joint		27	39	59	82	63	I		
	1999.08-	2002.07			F	MPV Engine RHZ(DW10ATED)	GC010015	Outer Joint	48T	27	39	59	82	63	I		
	1999.08-	2002.07	MT	L	F	MPV Engine RHZ(DW10ATED)	GDS10016	Drive Shaft	48T	27	37	59	82	641			





		TRANSM	L/R	F/R		G-AP Ref.	PRODUCT	ABS	Technical Specifications													
									YEAR	A	B	C	H	L	P							
<b>CITROEN SYNERGIE (22, U6)</b>																						
2.0 HDi (80 kW)	1999.08-	2002.07	MT	L	F	MPV Engine RHZ(DW10ATED)	GDS10072	Drive Shaft		27	37	59	82	641								
	1999.08-	2002.07	MT	R	F	MPV Engine RHZ(DW10ATED)	GDS10155	Drive Shaft		27	37	59	82	947								
	1999.08-	2002.07	MT	R	F	MPV Engine RHZ(DW10ATED)	GDS10014	Drive Shaft	48T	27	37	59	82	947								
	1999.08-	2002.07		R	F	MPV Engine RHZ(DW10ATED)	GDS10237	Drive Shaft	48T	27	37	59	82	953								
2.0 HDi 16V (80 kW)	1999.09-	2002.07			F	MPV Engine RHW(DW10ATED4)	GC010015	Outer Joint	48T	27	39	59	82	63	I							
	1999.09-	2002.07		R	F	MPV Engine RHW(DW10ATED4)	GDS10237	Drive Shaft	48T	27	37	59	82	953								
2.0 Turbo C.T. (108 kW)	1994.06-	2002.07			F	MPV Engine RGX(XU10J2TE)	GC010014	Outer Joint		27	39	59	82	63	I							
	1994.06-	2002.07			F	MPV Engine RGX(XU10J2TE)	GC010015	Outer Joint	48T	27	39	59	82	63	I							
	1994.06-	2002.07	MT	L	F	MPV Engine RGX(XU10J2TE)	GDS10016	Drive Shaft	48T	27	37	59	82	641								
	1994.06-	2002.07	MT	L	F	MPV Engine RGX(XU10J2TE)	GDS10072	Drive Shaft		27	37	59	82	641								
	1994.06-	2002.07	MT	R	F	MPV Engine RGX(XU10J2TE)	GDS10155	Drive Shaft		27	37	59	82	947								
	1994.06-	2002.07	MT	R	F	MPV Engine RGX(XU10J2TE)	GDS10014	Drive Shaft	48T	27	37	59	82	947								
2.1 TD (80 kW)	1996.05-	2002.07			F	MPV Engine P8C(XUD11BTE)	GC010015	Outer Joint	48T	27	39	59	82	63	I							
	1996.05-	2002.07	MT	L	F	MPV Engine P8C(XUD11BTE)	GDS10016	Drive Shaft	48T	27	37	59	82	641								
	1996.05-	2002.07	MT	L	F	MPV Engine P8C(XUD11BTE)	GDS10072	Drive Shaft		27	37	59	82	641								
	1996.05-	2002.07	MT	R	F	MPV Engine P8C(XUD11BTE)	GDS10155	Drive Shaft		27	37	59	82	947								
	1996.05-	2002.07	MT	R	F	MPV Engine P8C(XUD11BTE)	GDS10014	Drive Shaft	48T	27	37	59	82	947								
<b>VISA</b>																						
1.0 (33 kW)	1984.09-	1988.06	MT	L/R	F	Hatchback Engine XV8	GDS10130	Drive Shaft		21	22	54	90	683								
1.1 E (35 kW)	1978.09-	1988.06	MT	L/R	F	Hatchback Engine 109K	GDS10130	Drive Shaft		21	22	54	90	683								
1.1 E (37 kW)	1982.07-	1991.03	MT	L/R	F	Hatchback Engine 109/5F	GDS10130	Drive Shaft		21	22	54	90	683								
1.1 E (42 kW)	1978.09-	1991.03	MT	L/R	F	Hatchback Engine 109/5	GDS10130	Drive Shaft		21	22	54	90	683								
1.1 RE (37 kW)	1983.03-	1988.10	MT	L/R	F	Convertible Engine 109/5F	GDS10130	Drive Shaft		21	22	54	90	683								
1.4 (44 kW)	1984.07-	1991.03	MT	L/R	F	Hatchback Engine 150D(XY7)	GDS10130	Drive Shaft		21	22	54	90	683								
1.6 GTi (76 kW)	1985.01-	1986.06	MT	L	F	Hatchback Engine 180A(XU5J)	GDS45068	Drive Shaft		21	24	56.4	76	563								
	1985.01-	1986.06			F	Hatchback Engine 180A(XU5J)	GC010048	Outer Joint		21	22	56	76	58	I							
	1985.01-	1986.06	MT	R	F	Hatchback Engine 180A(XU5J)	GDS45066	Drive Shaft		21	24	56.4	76	825.5								
	1985.01-	1986.06	MT		F	Hatchback Engine 180A(XU5J)	GC010009	Outer Joint		21	22	56	79	60	I							
1.6 GTi (83 kW)	1986.06-	1991.03	MT	L	F	Hatchback Engine B6D	GDS45068	Drive Shaft		21	24	56.4	76	563								
	1986.06-	1991.03	MT	R	F	Hatchback Engine B6D	GDS45066	Drive Shaft		21	24	56.4	76	825.5								
1.8 D (44 kW)	1984.04-	1991.03	MT		F	Hatchback Engine 161A(XUD7)	GC010009	Outer Joint		21	22	56	79	60	I							
<b>XANTIA</b>																						
-				L			GDS10184	Drive Shaft	48T	25	24	58.5	79	612								
				R			GDS10185	Drive Shaft	48T	25	24	58.5	79	887								
1.6	1993.07-	1997.05	MT/AT		F		GC010065	Outer Joint	48T	25	34	58.5	80	55	I							
1.8	1993.07-	1997.12	MT/AT		F		GC010065	Outer Joint	48T	25	34	58.5	80	55	I							
1.9 D	1993.07-	1996.10	MT/AT		F		GC010065	Outer Joint	48T	25	34	58.5	80	55	I							
1.9 TD	1994.01-	1997.12	MT/AT		F		GC010065	Outer Joint	48T	25	34	58.5	80	55	I							
2.0 16V	1993.05-	1997.12	MT/AT		F		GC010065	Outer Joint	48T	25	34	58.5	80	55	I							
2.0 8V	1993.05-	2001.04	MT/AT		F		GC010065	Outer Joint	48T	25	34	58.5	80	55	I							
<b>XANTIA (X1)</b>																						
1.6 i (65 kW)	1993.03-	1998.01	MT	R	F	Hatchback Engine BFZ(XU5JP)	GDS10195	Drive Shaft	48T	25	24	55.7	79	893								
	1993.03-	1998.01	MT		F	Hatchback Engine BFZ(XU5JP)	GC010004	Outer Joint	48T	25	23	54.8	78.5	56	I							
1.8 i (74 kW)	1993.03-	1998.01	MT	R	F	Hatchback Engine LFX(XU7JP)	GDS10195	Drive Shaft	48T	25	24	55.7	79	893								
1.9 D (50 kW)	1994.06-	1998.01	MT	R	F	Hatchback Engine DJZ(XUD9Y)	GDS10195	Drive Shaft	48T	25	24	55.7	79	893								
1.9 D (51 kW)	1994.06-	1998.01	MT	R	F	Hatchback Engine D9B(XUD9A/L)	GDS10195	Drive Shaft	48T	25	24	55.7	79	893								
1.9 Turbo D (66 kW)	1994.10-	1998.01	MT	L	F	Hatchback Engine DHX(XUD9TF/BTF)/DHY(XUD9TE/Y)	GDS10189	Drive Shaft	48T	25	24	54.8	78.5	610								
	1995.06-	1998.01	MT	L	F	Estate Engine D8B(XUD9TF)/DHX(XUD9TF/BTF)/DHY(XUD9TE/Y)	GDS10189	Drive Shaft	48T	25	24	54.8	78.5	610								
2.0 i (89 kW)	1993.03-	1998.01	MT	L	F	Hatchback Engine RFX(XU10J2C)	GDS10189	Drive Shaft	48T	25	24	54.8	78.5	610								
	1995.06-	1998.01	MT	L	F	Estate Engine RFX(XU10J2C)	GDS10189	Drive Shaft	48T	25	24	54.8	78.5	610								
2.0 i 16V (110 kW)	1994.06-	1998.01	MT	L	F	Hatchback Engine RFT(XU10J4/Z)	GDS10189	Drive Shaft	48T	25	24	54.8	78.5	610								
2.0 i 16V (112 kW)	1993.03-	1998.01	MT	L	F	Hatchback Engine RFX(XU10J4/Z)	GDS10189	Drive Shaft	48T	25	24	54.8	78.5	610								
2.0 i 16V (97 kW)	1995.06-	1998.01	MT	L	F	Estate Engine RFV(XU10J4R)	GDS10189	Drive Shaft	48T	25	24	54.8	78.5	610								
	1995.06-	1998.01	MT	L	F	Hatchback Engine RFV(XU10J4R)	GDS10189	Drive Shaft	48T	25	24	54.8	78.5	610								
<b>XANTIA (X2)</b>																						
1.8 i (66 kW)	1998.01-	2003.04				Estate Engine LFX(XU7JB)	GC010042	Outer Joint		25	34	54.8	78.5	56	I							
	1998.01-	2003.04				Estate Engine LFX(XU7JB)	GC045035	Outer Joint	48T	25	34	58	79	55.5	I							
1.8 i 16V (81 kW)	1998.01-	2003.04			F	Estate Engine LFX(XU7JP4)	GC010024	Outer Joint	48T	25	34	55.7	79	55	I							
	1998.01-	2003.04			F	Hatchback Engine LFX(XU7JP4)	GC010024	Outer Joint	48T	25	34	55.7	79	55	I							
	1998.01-	2003.04	MT	R	F	Hatchback Engine LFX(XU7JP4)	GDS10202	Drive Shaft	48T	25	24	55.7	79	892								
	1998.01-	2003.04				Hatchback Engine LFX(XU7JP4)	GC010042	Outer Joint		25	34	54.8	78.5	56	I							
	1998.01-	2003.04				Hatchback Engine LFX(XU7JP4)	GC045035	Outer Joint	48T	25	34	58	79	55.5	I							



		TRANSM	L/R	F/R		G-AP Ref.	PRODUCT	ABS	Technical Specifications									
									YEAR	A	B	C	H	L	P			
<b>CITROEN</b>																		
<b>XANTIA (X2)</b>																		
1.9 SD (55 kW)	1998.01-	2003.04			Hatchback Engine DHW(XUD9SD)	GC010042	Outer Joint		25	34	54.8	78.5	56	I				
1.9 Turbo D (66 kW)	1998.01-	2003.04	MT	R	Hatchback Engine DHX(XUD9TF/BTF)/DHY(XUD9TE/Y)	GDS10202	Drive Shaft	48T	25	24	55.7	79	892					
	1998.01-	2003.04			Estate Engine D8B(XUD9TF)/DHX(XUD9TF/BTF)	GC010042	Outer Joint		25	34	54.8	78.5	56	I				
	1998.01-	2003.04			Estate Engine D8B(XUD9TF)/DHX(XUD9TF/BTF)	GC045035	Outer Joint	48T	25	34	58	79	55.5	I				
	1998.01-	2003.04			Hatchback Engine DHX(XUD9TF/BTF)/DHY(XUD9TE/Y)	GC010042	Outer Joint		25	34	54.8	78.5	56	I				
	1998.01-	2003.04			Hatchback Engine DHX(XUD9TF/BTF)/DHY(XUD9TE/Y)	GC045035	Outer Joint	48T	25	34	58	79	55.5	I				
2.0 HDi (66 kW)	1999.03-	2003.04			F Hatchback Engine RHY(DW10TD)	GC010043	Outer Joint		25	34	54.8	78.5	56	I				
	1999.03-	2003.04			F Hatchback Engine RHY(DW10TD)	GC010027	Outer Joint	48T	25	34	55.7	79	55	I				
	1999.03-	2003.04			Estate Engine RHY(DW10TD)	GC010042	Outer Joint		25	34	54.8	78.5	56	I				
	1999.03-	2003.04			Estate Engine RHY(DW10TD)	GC045035	Outer Joint	48T	25	34	58	79	55.5	I				
	1999.03-	2003.04			Hatchback Engine RHY(DW10TD)	GC010042	Outer Joint		25	34	54.8	78.5	56	I				
	1999.03-	2003.04			Hatchback Engine RHY(DW10TD)	GC045035	Outer Joint	48T	25	34	58	79	55.5	I				
2.0 HDi (80 kW)	1999.02-	2003.04			F Hatchback Engine RHZ(DW10ATED)	GC010019	Outer Joint	48T	25	39	59	89	63.5	I				
	1999.02-	2003.04		L	F Estate Engine RHZ(DW10ATED)	GDS45178	Drive Shaft	48T	25	37	59	89	621					
	1999.02-	2003.04		L	F Hatchback Engine RHZ(DW10ATED)	GDS45178	Drive Shaft	48T	25	37	59	89	621					
	1999.02-	2003.04		R	F Estate Engine RHZ(DW10ATED)	GDS45179	Drive Shaft	48T	25	37	59	89	918					
	1999.02-	2003.04		R	F Hatchback Engine RHZ(DW10ATED)	GDS45179	Drive Shaft	48T	25	37	59	89	918					
2.0 i (89 kW)	1998.01-	2003.04			F Estate Engine RFX(XU10J2C)	GC010024	Outer Joint	48T	25	34	55.7	79	55	I				
	1998.01-	2003.04			F Hatchback Engine RFX(XU10J2C)	GC010024	Outer Joint	48T	25	34	55.7	79	55	I				
	1998.01-	2003.04			Hatchback Engine RFX(XU10J2C)	GC010042	Outer Joint		25	34	54.8	78.5	56	I				
2.0 i 16V (97 kW)	1998.01-	2003.04			Hatchback Engine RFV(XU10J4R)	GC010042	Outer Joint		25	34	54.8	78.5	56	I				
	1998.01-	2003.04			Hatchback Engine RFV(XU10J4R)	GC045035	Outer Joint	48T	25	34	58	79	55.5	I				
2.0 Turbo (108 kW)	1998.01-	2003.04			F Estate Engine RGX(XU10J2TE)	GC010019	Outer Joint	48T	25	39	59	89	63.5	I				
	1998.01-	2003.04			F Hatchback Engine RGX(XU10J2TE)	GC010019	Outer Joint	48T	25	39	59	89	63.5	I				
	1998.01-	2003.04		L	F Estate Engine RGX(XU10J2TE)	GDS45178	Drive Shaft	48T	25	37	59	89	621					
	1998.01-	2003.04		L	F Hatchback Engine RGX(XU10J2TE)	GDS45178	Drive Shaft	48T	25	37	59	89	621					
	1998.01-	2003.04		R	F Estate Engine RGX(XU10J2TE)	GDS45179	Drive Shaft	48T	25	37	59	89	918					
	1998.01-	2003.04		R	F Hatchback Engine RGX(XU10J2TE)	GDS45179	Drive Shaft	48T	25	37	59	89	918					
3.0 V6 (140 kW)	1998.01-	2003.04		L	F Estate Engine XFZ(ES9J4)	GDS45178	Drive Shaft	48T	25	37	59	89	621					
	1998.01-	2003.04		L	F Hatchback Engine XFZ(ES9J4)	GDS45178	Drive Shaft	48T	25	37	59	89	621					
	1998.01-	2003.04		R	F Estate Engine XFZ(ES9J4)	GDS45179	Drive Shaft	48T	25	37	59	89	918					
	1998.01-	2003.04		R	F Hatchback Engine XFZ(ES9J4)	GDS45179	Drive Shaft	48T	25	37	59	89	918					
<b>XANTIA II (X2)</b>																		
2.0 HDi 90 (66 kW)	1999.03-	2003.04				GC010027	Outer Joint	48T	25	34	55.7	79	55	I				
<b>XANTIA II (X2) BREAK</b>																		
2.0 HDi 90 (66 kW)	1999.03-	2003.04				GC010027	Outer Joint	48T	25	34	55.7	79	55	I				
<b>XM (Y3)</b>																		
2.0 i (79 kW)	1989.05-	1994.04	MT/AT	L	F Hatchback Engine RDZ(XU10MZ)	GDS10113	Drive Shaft		28	24	58	88.5	651					
	1989.05-	1994.04		L	F Hatchback Engine RDZ(XU10MZ)	GDS10083	Drive Shaft	48T	28	24	58	88.5	651					
	1989.05-	1994.04		R	F Hatchback Engine RDZ(XU10MZ)	GDS10084	Drive Shaft	48T	28	24	58	88.5	942.5					
	1989.05-	1994.04	MT/AT	R	F Hatchback Engine RDZ(XU10MZ)	GDS10114	Drive Shaft		28	24	58	88.5	942.5					
	1991.11-	1994.04	MT		F Estate Engine RDZ(XU10MZ)/XU102C	GC010006	Outer Joint		28	23	59	88.5	55	I				
	1991.11-	1994.04	MT		F Estate Engine RDZ(XU10MZ)/XU102C	GC010007	Outer Joint	48T	28	23	58	88.5	55	I				
	1991.11-	1994.04	MT		F Estate Engine RDZ(XU10MZ)/XU102C	GC010021	Outer Joint	29T	28	23	58	88.5	55	I				
	1991.11-	1994.04	MT/AT	L	F Estate Engine RDZ(XU10MZ)/XU102C	GDS10113	Drive Shaft		28	24	58	88.5	651					
	1991.11-	1994.04		L	F Estate Engine RDZ(XU10MZ)/XU102C	GDS10083	Drive Shaft	48T	28	24	58	88.5	651					
	1991.11-	1994.04		R	F Estate Engine RDZ(XU10MZ)/XU102C	GDS10084	Drive Shaft	48T	28	24	58	88.5	942.5					
	1991.11-	1994.04	MT/AT	R	F Estate Engine RDZ(XU10MZ)/XU102C	GDS10114	Drive Shaft		28	24	58	88.5	942.5					
	2.0 i (89 kW)	1989.05-	1994.06	MT		F Hatchback Engine RFZ(XU10J2)	GC010006	Outer Joint		28	23	59	88.5	55	I			
		1989.05-	1994.06	MT		F Hatchback Engine RFZ(XU10J2)	GC010007	Outer Joint	48T	28	23	58	88.5	55	I			
		1989.05-	1994.06	MT		F Hatchback Engine RFZ(XU10J2)	GC010021	Outer Joint	29T	28	23	58	88.5	55	I			
1989.05-		1994.06	MT/AT	L	F Hatchback Engine RFZ(XU10J2)	GDS10113	Drive Shaft		28	24	58	88.5	651					
1989.05-		1994.06		L	F Hatchback Engine RFZ(XU10J2)	GDS10083	Drive Shaft	48T	28	24	58	88.5	651					
1989.05-		1994.06		R	F Hatchback Engine RFZ(XU10J2)	GDS10084	Drive Shaft	48T	28	24	58	88.5	942.5					
1989.05-		1994.06	MT/AT	R	F Hatchback Engine RFZ(XU10J2)	GDS10114	Drive Shaft		28	24	58	88.5	942.5					
1991.11-		1994.04	MT		F Estate Engine RFZ(XU10J2)	GC010006	Outer Joint		28	23	59	88.5	55	I				
1991.11-		1994.04	MT		F Estate Engine RFZ(XU10J2)	GC010007	Outer Joint	48T	28	23	58	88.5	55	I				
1991.11-		1994.04	MT		F Estate Engine RFZ(XU10J2)	GC010021	Outer Joint	29T	28	23	58	88.5	55	I				
1991.11-		1994.04	MT/AT	L	F Estate Engine RFZ(XU10J2)	GDS10113	Drive Shaft		28	24	58	88.5	651					
1991.11-		1994.04		L	F Estate Engine RFZ(XU10J2)	GDS10083	Drive Shaft	48T	28	24	58	88.5	651					
1991.11-		1994.04		R	F Estate Engine RFZ(XU10J2)	GDS10084	Drive Shaft	48T	28	24	58	88.5	942.5					
1991.11-		1994.04	MT/AT	R	F Estate Engine RFZ(XU10J2)	GDS10114	Drive Shaft		28	24	58	88.5	942.5					





	 YEAR	TRANSM	L/R	F/R		G-AP Ref.	PRODUCT	ABS	Technical Specifications									
									A	B	C	H	L	P				
<b>CITROEN XM (Y3)</b>																		
2.0 i Turbo (104 kW)	1992.09-1994.06		L	F	Hatchback Engine RGY(XU10J2TE/Z)	GDS10071	Drive Shaft	48T	28	37	58	89	641.5					
	1992.09-1994.06		R	F	Hatchback Engine RGY(XU10J2TE/Z)	GDS10070	Drive Shaft	48T	28	37	58	89	939					
	1992.09-1994.06		R	F	Hatchback Engine RGY(XU10J2TE/Z)	GDS10190	Drive Shaft	29T	28	37	58	88	935					
	1992.09-1994.06		L	F	Hatchback Engine RGY(XU10J2TE/Z)	GDS10191	Drive Shaft	29T	28	37	58	88	642					
2.0 Turbo (104 kW)	1992.09-1994.04		L	F	Estate Engine RGY(XU10J2TE/Z)	GDS10071	Drive Shaft	48T	28	37	58	89	641.5					
	1992.09-1994.04		R	F	Estate Engine RGY(XU10J2TE/Z)	GDS10070	Drive Shaft	48T	28	37	58	89	939					
	1992.09-1994.04		R	F	Estate Engine RGY(XU10J2TE/Z)	GDS10190	Drive Shaft	29T	28	37	58	88	935					
	1992.09-1994.04		L	F	Estate Engine RGY(XU10J2TE/Z)	GDS10191	Drive Shaft	29T	28	37	58	88	642					
2.1 D 12V (60 kW)	1989.05-1994.06	MT		F	Hatchback Engine P9A(XUD11A)	GC010006	Outer Joint		28	23	59	88.5	55	I				
	1989.05-1994.06	MT		F	Hatchback Engine P9A(XUD11A)	GC010007	Outer Joint	48T	28	23	58	88.5	55	I				
	1989.05-1994.06	MT		F	Hatchback Engine P9A(XUD11A)	GC010021	Outer Joint	29T	28	23	58	88.5	55	I				
	1989.05-1994.06	MT/AT	L	F	Hatchback Engine P9A(XUD11A)	GDS10113	Drive Shaft		28	24	58	88.5	651					
	1989.05-1994.06		L	F	Hatchback Engine P9A(XUD11A)	GDS10083	Drive Shaft	48T	28	24	58	88.5	651					
	1989.05-1994.06		R	F	Hatchback Engine P9A(XUD11A)	GDS10084	Drive Shaft	48T	28	24	58	88.5	942.5					
	1989.05-1994.06	MT/AT	R	F	Hatchback Engine P9A(XUD11A)	GDS10114	Drive Shaft		28	24	58	88.5	942.5					
	1991.11-1994.04			F	Estate Engine P9A(XUD11A)	GC010054	Outer Joint	48T	28	23	59	88.5	55	I				
	1991.11-1994.04	MT		F	Estate Engine P9A(XUD11A)	GC010006	Outer Joint		28	23	59	88.5	55	I				
	1991.11-1994.04	MT		F	Estate Engine P9A(XUD11A)	GC010007	Outer Joint	48T	28	23	58	88.5	55	I				
	1991.11-1994.04	MT		F	Estate Engine P9A(XUD11A)	GC010021	Outer Joint	29T	28	23	58	88.5	55	I				
	1991.11-1994.04	MT/AT	L	F	Estate Engine P9A(XUD11A)	GDS10113	Drive Shaft		28	24	58	88.5	651					
	1991.11-1994.04		L	F	Estate Engine P9A(XUD11A)	GDS10083	Drive Shaft	48T	28	24	58	88.5	651					
	1991.11-1994.04		R	F	Estate Engine P9A(XUD11A)	GDS10084	Drive Shaft	48T	28	24	58	88.5	942.5					
1991.11-1994.04	MT/AT	R	F	Estate Engine P9A(XUD11A)	GDS10114	Drive Shaft		28	24	58	88.5	942.5						
2.1 TD 12V (80 kW)	1989.05-1994.06		L	F	Hatchback Engine P8A(XUD11ATE)/PHZ(XUD11ATE)/PJZ(XUD11ATE)	GDS10071	Drive Shaft	48T	28	37	58	89	641.5					
	1989.05-1994.06		R	F	Hatchback Engine P8A(XUD11ATE)/PHZ(XUD11ATE)/PJZ(XUD11ATE)	GDS10070	Drive Shaft	48T	28	37	58	89	939					
	1989.05-1994.06			F	Hatchback Engine P8A(XUD11ATE)/PHZ(XUD11ATE)/PJZ(XUD11ATE)	GC010029	Outer Joint	29T	28	27	58	89	63	I				
	1989.05-1994.06			F	Hatchback Engine P8A(XUD11ATE)/PHZ(XUD11ATE)/PJZ(XUD11ATE)	GC010008	Outer Joint	48T	28	27	58	89	63	I				
	1989.05-1994.06		R	F	Hatchback Engine P8A(XUD11ATE)/PHZ(XUD11ATE)/PJZ(XUD11ATE)	GDS10190	Drive Shaft	29T	28	37	58	88	935					
	1989.05-1994.06		L	F	Hatchback Engine P8A(XUD11ATE)/PHZ(XUD11ATE)/PJZ(XUD11ATE)	GDS10191	Drive Shaft	29T	28	37	58	88	642					
	1991.11-1994.04		L	F	Estate Engine P8A(XUD11ATE)/P8C(XUD11BTE)/PHZ(XUD11ATE)/PJZ(XUD11ATE)	GDS10071	Drive Shaft	48T	28	37	58	89	641.5					
	1991.11-1994.04		R	F	Estate Engine P8A(XUD11ATE)/P8C(XUD11BTE)/PHZ(XUD11ATE)/PJZ(XUD11ATE)	GDS10070	Drive Shaft	48T	28	37	58	89	939					
	1991.11-1994.04			F	Estate Engine P8A(XUD11ATE)/P8C(XUD11BTE)/PHZ(XUD11ATE)/PJZ(XUD11ATE)	GC010029	Outer Joint	29T	28	27	58	89	63	I				
	1991.11-1994.04			F	Estate Engine P8A(XUD11ATE)/P8C(XUD11BTE)/PHZ(XUD11ATE)/PJZ(XUD11ATE)	GC010008	Outer Joint	48T	28	27	58	89	63	I				
	1991.11-1994.04		R	F	Estate Engine P8A(XUD11ATE)/P8C(XUD11BTE)/PHZ(XUD11ATE)/PJZ(XUD11ATE)	GDS10190	Drive Shaft	29T	28	37	58	88	935					
1991.11-1994.04		L	F	Estate Engine P8A(XUD11ATE)/P8C(XUD11BTE)/PHZ(XUD11ATE)/PJZ(XUD11ATE)	GDS10191	Drive Shaft	29T	28	37	58	88	642						
3.0 (123 kW)	1989.05-1994.05			F	Hatchback Engine UFZ(ZPJ/Z)	GC010029	Outer Joint	29T	28	27	58	89	63	I				
	1989.05-1994.05			F	Hatchback Engine UFZ(ZPJ/Z)	GC010008	Outer Joint	48T	28	27	58	89	63	I				
	1989.05-1994.05		R	F	Hatchback Engine UFZ(ZPJ/Z)	GDS10190	Drive Shaft	29T	28	37	58	88	935					
	1989.05-1994.05		L	F	Hatchback Engine UFZ(ZPJ/Z)	GDS10191	Drive Shaft	29T	28	37	58	88	642					
	1989.05-1994.05		L	F	Hatchback Engine UFZ(ZPJ/Z)	GDS10071	Drive Shaft	48T	28	37	58	89	641.5					
	1989.05-1994.05		R	F	Hatchback Engine UFZ(ZPJ/Z)	GDS10070	Drive Shaft	48T	28	37	58	89	939					
3.0 V6 (123 kW)	1989.05-1994.06		L	F	Hatchback Engine SFZ(ZPJ/Z)/UFZ(ZPJ/Z)	GDS10071	Drive Shaft	48T	28	37	58	89	641.5					
	1989.05-1994.06		R	F	Hatchback Engine SFZ(ZPJ/Z)/UFZ(ZPJ/Z)	GDS10070	Drive Shaft	48T	28	37	58	89	939					
	1989.05-1994.06			F	Hatchback Engine SFZ(ZPJ/Z)/UFZ(ZPJ/Z)	GC010029	Outer Joint	29T	28	27	58	89	63	I				
	1989.05-1994.06			F	Hatchback Engine SFZ(ZPJ/Z)/UFZ(ZPJ/Z)	GC010008	Outer Joint	48T	28	27	58	89	63	I				
	1989.05-1994.06		R	F	Hatchback Engine SFZ(ZPJ/Z)/UFZ(ZPJ/Z)	GDS10190	Drive Shaft	29T	28	37	58	88	935					
	1989.05-1994.06		L	F	Hatchback Engine SFZ(ZPJ/Z)/UFZ(ZPJ/Z)	GDS10191	Drive Shaft	29T	28	37	58	88	642					
	1991.11-1994.04		L	F	Estate Engine SFZ(ZPJ/Z)/UFZ(ZPJ/Z)	GDS10071	Drive Shaft	48T	28	37	58	89	641.5					
	1991.11-1994.04		R	F	Estate Engine SFZ(ZPJ/Z)/UFZ(ZPJ/Z)	GDS10070	Drive Shaft	48T	28	37	58	89	939					
	1991.11-1994.04			F	Estate Engine SFZ(ZPJ/Z)/UFZ(ZPJ/Z)	GC010029	Outer Joint	29T	28	27	58	89	63	I				
	1991.11-1994.04			F	Estate Engine SFZ(ZPJ/Z)/UFZ(ZPJ/Z)	GC010008	Outer Joint	48T	28	27	58	89	63	I				
3.0 V6 24V (147 kW)	1990.07-1994.06		L	F	Hatchback Engine SKZ(ZPJ4/Z)/UKZ(ZPJ4/Z)	GDS10071	Drive Shaft	48T	28	37	58	89	641.5					
	1990.07-1994.06		R	F	Hatchback Engine SKZ(ZPJ4/Z)/UKZ(ZPJ4/Z)	GDS10070	Drive Shaft	48T	28	37	58	89	939					
	1990.07-1994.06			F	Hatchback Engine SKZ(ZPJ4/Z)/UKZ(ZPJ4/Z)	GC010029	Outer Joint	29T	28	27	58	89	63	I				
	1990.07-1994.06			F	Hatchback Engine SKZ(ZPJ4/Z)/UKZ(ZPJ4/Z)	GC010008	Outer Joint	48T	28	27	58	89	63	I				
	1990.07-1994.06		R	F	Hatchback Engine SKZ(ZPJ4/Z)/UKZ(ZPJ4/Z)	GDS10190	Drive Shaft	29T	28	37	58	88	935					
	1990.07-1994.06		L	F	Hatchback Engine SKZ(ZPJ4/Z)/UKZ(ZPJ4/Z)	GDS10191	Drive Shaft	29T	28	37	58	88	642					
<b>XM (Y4)</b>																		
2.0 i 16V (97 kW)	1994.05-2000.10	MT/AT		F	Estate Engine RFV(XU10J4R)	GC010008	Outer Joint	48T	28	27	58	89	63	I				













		YEAR	TRANSM	L/R	F/R		G-AP Ref.	PRODUCT	ABS	Technical Specifications								
										A	B	C	H	L	P			
<b>CITROEN XM (Y4)</b>																		
2.0 Turbo (108 kW)	1994.05-	2000.10	MT/AT			F Estate Engine RGX(XU10J2TE)/RGY(XU10J2TE/Z)	GC010008	Outer Joint	48T	28	27	58	89	63	I			
	1994.05-	2000.10				F Hatchback Engine RGX(XU10J2TE)	GC010008	Outer Joint	48T	28	27	58	89	63	I			
2.1 D12 (60 kW)	1994.07-	1996.06	MT/AT	L	F	Estate Engine P9A(XUD11A)	GDS10113	Drive Shaft		28	24	58	88.5	651				
	1994.07-	1996.06	MT/AT	R	F	Estate Engine P9A(XUD11A)	GDS10114	Drive Shaft		28	24	58	88.5	942.5				
	1994.07-	1996.06	MT/AT		F	Estate Engine P9A(XUD11A)	GC010008	Outer Joint	48T	28	27	58	89	63	I			
2.1 TD 12V (80 kW)	1994.05-	2000.10	MT/AT		F	Estate Engine P8C(XUD11BTE)/PHZ(XUD11ATE)/PJZ(XUD11ATE)	GC010008	Outer Joint	48T	28	27	58	89	63	I			
	1994.05-	2000.10			F	Hatchback Engine P8A(XUD11ATE)/P8C(XUD11BTE)/PHZ(XUD11ATE)/PJZ(XUD11ATE)	GC010008	Outer Joint	48T	28	27	58	89	63	I			
<b>XSARA</b>																		
-						LADO ESQUERDO	GCI45020	Inner Joint		24	34	40	69	89				
1.4	1997.11-						GC045036	Outer Joint	29T	25	22	60	80	54	I			
1.6 16V	2000.10-						GC045036	Outer Joint	29T	25	22	60	80	54	I			
1.6 8V	1997.11-						GC045036	Outer Joint	29T	25	22	60	80	54	I			
2.0 HDi (66 kW)	2000.09-	2005.03		L	F	Box Engine RHY(DW10TD)	GDS99195	Drive Shaft	48W	25	24	58.5	79	585				
	2000.09-	2005.03		R	F	Box Engine RHY(DW10TD)	GDS99196	Drive Shaft	48W	25	24	58.5	79	869				
<b>XSARA (N0)</b>																		
1.4 HDi (50 kW)	2003.01-	2005.03			F	Coupe Engine 8HX(DV4TD)	GC010076	Outer Joint	29W	25	34	58.5	79	55	I			
1.4 i (55 kW)	1998.03-	2005.03	MT	L	F	Coupe Engine KFW(TU3JP)/KFX(TU3JP)	GCI45011	Inner Joint		22	22	40	65.2	87.8				
	1998.03-	2005.03	MT	L	F	Coupe Engine KFW(TU3JP)/KFX(TU3JP)	GDS10043	Drive Shaft		21	22	48	86.5	610				
	1998.03-	2005.03	MT	L	F	Coupe Engine KFW(TU3JP)/KFX(TU3JP)	GDS10018	Drive Shaft	29T	25	22	60	80	603				
	1998.03-	2005.03	MT	R	F	Coupe Engine KFW(TU3JP)/KFX(TU3JP)	GDS10019	Drive Shaft	29T	25	22	60	80	867				
	1998.03-	2005.03	MT	R	F	Coupe Engine KFW(TU3JP)/KFX(TU3JP)	GDS10203	Drive Shaft		21	22	48	86.5	877				
1.6 16V (80 kW)	2000.09-	2005.03	5MT	L	F	Coupe Engine NFU(TU5JP4)	GDS10204	Drive Shaft		25	22	58.5	79	594				
	2000.09-	2005.03	MT	L	F	Coupe Engine NFU(TU5JP4)	GDS10053	Drive Shaft	29T	25	22	54.5	79.5	592				
	2000.09-	2005.03				Coupe Engine NFU(TU5JP4)	GC099006	Outer Joint		25	22	60	78.7	54	M			
	2000.09-	2005.03				Coupe Engine NFU(TU5JP4)	GC099221	Outer Joint	29T	25	22	60	78.7	54	M			
1.9 D (51 kW)	1999.02-	2005.03			F	Coupe Engine WJY(DW8B)/WJZ(DW8)	GC010076	Outer Joint	29W	25	34	58.5	79	55	I			
	1999.02-	2005.03	MT	L	F	Coupe Engine WJY(DW8B)/WJZ(DW8)	GDS99025	Drive Shaft	29W	25	24	55.7	79	597				
	1999.02-	2005.03	MT	L	F	Coupe Engine WJY(DW8B)/WJZ(DW8)	GCI45017	Inner Joint		24	34	40	69	99				
	1999.02-	2005.03	MT	L	F	Coupe Engine WJY(DW8B)/WJZ(DW8)	GDS10165	Drive Shaft		25	24	55.7	79	594				
	1999.02-	2005.03	MT	L	F	Coupe Engine WJY(DW8B)/WJZ(DW8)	GDS10128	Drive Shaft	29T	25	24	55.7	79	594				
	1999.02-	2005.03	MT	R	F	Coupe Engine WJY(DW8B)/WJZ(DW8)	GDS10167	Drive Shaft	25	24	55.7	79	868					
	1999.02-	2005.03	MT	R	F	Coupe Engine WJY(DW8B)/WJZ(DW8)	GDS10023	Drive Shaft	29T	25	24	55.7	79	868				
1.9 TD (66 kW)	1998.02-	2000.09			F	Coupe Engine DHY(XUD9TE/Y)	GC010020	Outer Joint	29T	25	34	58	78.5	55	I			
2.0 16V (100 kW)	2000.09-	2005.03	5MT		F	Coupe Engine RFN(EW10J4)	GC010022	Outer Joint	29W	25	34	55.7	79	55	I			
	2000.09-	2005.03	5MT	L	F	Coupe Engine RFN(EW10J4)	GCI45018	Inner Joint		24	34	40	62	88				
	2000.09-	2005.03	5MT	L	F	Coupe Engine RFN(EW10J4)	GDS10225	Drive Shaft	29T	25	24	55	79.5	585				
	2000.09-	2005.03	MT	L	F	Coupe Engine RFN(EW10J4)	GDS99195	Drive Shaft	48W	25	24	58.5	79	585				
	2000.09-	2005.03	MT	R	F	Coupe Engine RFN(EW10J4)	GDS99196	Drive Shaft	48W	25	24	58.5	79	869				
2.0 HDi (66 kW)	1999.02-	2005.03			F	Coupe Engine RHY(DW10TD)	GC010022	Outer Joint	29W	25	34	55.7	79	55	I			
	1999.02-	2005.03		L	F	Coupe Engine RHY(DW10TD)	GDS10225	Drive Shaft	29T	25	24	55	79.5	585				
	1999.02-	2005.03		L	F	Coupe Engine RHY(DW10TD)	GDS99195	Drive Shaft	48W	25	24	58.5	79	585				
	1999.02-	2005.03		L	F	Coupe Engine RHY(DW10TD)	GCI45018	Inner Joint		24	34	40	62	88				
	1999.02-	2005.03	MT	R	F	Coupe Engine RHY(DW10TD)	GDS10193	Drive Shaft	29T	25	24	55.7	79	867				
	1999.02-	2005.03		R	F	Coupe Engine RHY(DW10TD)	GDS99196	Drive Shaft	48W	25	24	58.5	79	869				
2.0 HDi (80 kW)	2001.05-	2005.03	MT/AT		F	Coupe Engine RHZ(DW10ATED)	GC010022	Outer Joint	29W	25	34	55.7	79	55	I			
	2001.05-	2005.03	MT	L	F	Coupe Engine RHZ(DW10ATED)	GDS99195	Drive Shaft	48W	25	24	58.5	79	585				
	2001.05-	2005.03	MT/AT	L	F	Coupe Engine RHZ(DW10ATED)	GCI45018	Inner Joint		24	34	40	62	88				
	2001.05-	2005.03	MT/AT	L	F	Coupe Engine RHZ(DW10ATED)	GDS10225	Drive Shaft	29T	25	24	55	79.5	585				
	2001.05-	2005.03	MT	R	F	Coupe Engine RHZ(DW10ATED)	GDS99196	Drive Shaft	48W	25	24	58.5	79	869				
	2001.05-	2005.03	MT	R	F	Coupe Engine RHZ(DW10ATED)	GDS10193	Drive Shaft	29T	25	24	55.7	79	867				
2.0 i 16V (120 kW)	1998.02-	2005.03		L	F	Coupe Engine RFS(XU10J4RS)	GDS10225	Drive Shaft	29T	25	24	55	79.5	585				
	1998.02-	2005.03	MT	L	F	Coupe Engine RFS(XU10J4RS)	GDS10163	Drive Shaft		25	24	54.8	78.5	583				
	1998.02-	2005.03	MT	L	F	Coupe Engine RFS(XU10J4RS)	GDS10131	Drive Shaft	29T	25	24	54.8	78.5	583				
	1998.02-	2005.03		L	F	Coupe Engine RFS(XU10J4RS)	GCI45018	Inner Joint		24	34	40	62	88				
	1998.02-	2005.03	MT	R	F	Coupe Engine RFS(XU10J4RS)	GDS10167	Drive Shaft		25	24	55.7	79	868				
	1998.02-	2005.03	MT	R	F	Coupe Engine RFS(XU10J4RS)	GDS10023	Drive Shaft	29T	25	24	55.7	79	868				
<b>XSARA (N1)</b>																		
1.4 HDi (50 kW)	2003.01-	2005.03			F	Hatchback Engine 8HX(DV4TD)	GC010076	Outer Joint	29W	25	34	58.5	79	55	I			
	2003.01-	2005.03		L	F	Hatchback Engine 8HX(DV4TD)	GDS99025	Drive Shaft	29W	25	24	55.7	79	597				
1.4 i (55 kW)	1997.04-	2005.03	MT	L	F	Hatchback Engine KFW(TU3JP)/KFX(TU3JP)	GDS10053	Drive Shaft	29T	25	22	54.5	79.5	592				
	1997.04-	2005.03	MT	L	F	Hatchback Engine KFW(TU3JP)/KFX(TU3JP)	GCI45011	Inner Joint		22	22	40	65.2	87.8				
	1997.04-	2005.03	MT	L	F	Hatchback Engine KFW(TU3JP)/KFX(TU3JP)	GDS10040	Drive Shaft		21	22	56.4	76	595				



		TRANSM	L/R	F/R		G-AP Ref.	PRODUCT	ABS	Technical Specifications									
									YEAR	A	B	C	H	L	P			
<b>CITROEN XSARA (N1)</b>																		
1.4 i (55 kW)	1997.04-2005.03	2005.03	MT	L	F	Hatchback Engine KFW(TU3JP)/KFX(TU3JP)	GDS10043	Drive Shaft		21	22	48	86.5	610				
	1997.04-2005.03	2005.03	MT	L	F	Hatchback Engine KFW(TU3JP)/KFX(TU3JP)	GDS10018	Drive Shaft	29T	25	22	60	80	603				
	1997.04-2005.03	2005.03		L	F	Hatchback Engine KFW(TU3JP)/KFX(TU3JP)	GDS45043	Drive Shaft		21	22	56.4	76	591				
	1997.04-2005.03	2005.03	MT	R	F	Hatchback Engine KFW(TU3JP)/KFX(TU3JP)	GDS10019	Drive Shaft	29T	25	22	60	80	867				
	1997.04-2005.03	2005.03	MT	R	F	Hatchback Engine KFW(TU3JP)/KFX(TU3JP)	GDS10017	Drive Shaft		21	22	56.4	76	860				
	1997.04-2005.03	2005.03	MT	R	F	Hatchback Engine KFW(TU3JP)/KFX(TU3JP)	GDS10203	Drive Shaft		21	22	48	86.5	877				
	1997.04-2005.03	2005.03				Hatchback Engine KFW(TU3JP)/KFX(TU3JP)	GC099006	Outer Joint		25	22	60	78.7	54	M			
	1997.04-2005.03	2005.03				Hatchback Engine KFW(TU3JP)/KFX(TU3JP)	GC099221	Outer Joint	29T	25	22	60	78.7	54	M			
1.6 16V (80 kW)	2000.09-2005.03	2005.03	MT		F	Hatchback Engine NFU(TU5JP4)	GC010002	Outer Joint		25	23	54.8	78.5	56	I			
	2000.09-2005.03	2005.03	MT		F	Hatchback Engine NFU(TU5JP4)	GC010003	Outer Joint	29T	25	23	54.8	78.5	56	I			
	2000.09-2005.03	2005.03	MT	L	F	Hatchback Engine NFU(TU5JP4)	GDS10053	Drive Shaft	29T	25	22	54.5	79.5	592				
	2000.09-2005.03	2005.03	MT	L	F	Hatchback Engine NFU(TU5JP4)	GDS10026	Drive Shaft		25	22	56.7	79	594				
	2000.09-2005.03	2005.03	MT	L	F	Hatchback Engine NFU(TU5JP4)	GDS10021	Drive Shaft	29T	25	22	60	80	593				
	2000.09-2005.03	2005.03	MT/AT	L	F	Hatchback Engine NFU(TU5JP4)	GDS10204	Drive Shaft		25	22	58.5	79	594				
	2000.09-2005.03	2005.03	MT	R	F	Hatchback Engine NFU(TU5JP4)	GDS10205	Drive Shaft		25	22	58.5	79	866				
	2000.09-2005.03	2005.03				Hatchback Engine NFU(TU5JP4)	GC099006	Outer Joint		25	22	60	78.7	54	M			
	2000.09-2005.03	2005.03				Hatchback Engine NFU(TU5JP4)	GC099221	Outer Joint	29T	25	22	60	78.7	54	M			
1.6 i (65 kW)	1997.04-2000.09	2000.09	MT	R	F	Hatchback Engine NFZ(TU5JP)	GDS10027	Drive Shaft		25	22	56.7	79	868				
1.8 D (43 kW)	1997.04-2000.09	2000.09			F	Hatchback Engine 161A(XUD7)/A9A(XUD7)	GC010020	Outer Joint	29T	25	34	58	78.5	55	I			
1.8 i (66 kW)	1997.04-2000.09	2000.09			F	Hatchback Engine LFX(XU7JB)	GC010020	Outer Joint	29T	25	34	58	78.5	55	I			
1.8 i 16V (81 kW)	1997.04-2000.09	2000.09			F	Hatchback Engine LFY(XU7JP4)	GC010020	Outer Joint	29T	25	34	58	78.5	55	I			
1.9 D (50 kW)	1997.04-2000.09	2000.09			F	Hatchback Engine DJY(XUD9A)	GC010020	Outer Joint	29T	25	34	58	78.5	55	I			
1.9 D (51 kW)	1998.07-2005.03	2005.03			F	Hatchback Engine WJY(DW8B)/WJZ(DW8)	GC010076	Outer Joint	29W	25	34	58.5	79	55	I			
	1998.07-2005.03	2005.03	MT	L	F	Hatchback Engine WJY(DW8B)/WJZ(DW8)	GDS99025	Drive Shaft	29W	25	24	55.7	79	597				
	1998.07-2005.03	2005.03	MT	L	F	Hatchback Engine WJY(DW8B)/WJZ(DW8)	GCI45017	Inner Joint		24	34	40	69	99				
	1998.07-2005.03	2005.03	MT	L	F	Hatchback Engine WJY(DW8B)/WJZ(DW8)	GDS10165	Drive Shaft		25	24	55.7	79	594				
	1998.07-2005.03	2005.03	MT	L	F	Hatchback Engine WJY(DW8B)/WJZ(DW8)	GDS10128	Drive Shaft	29T	25	24	55.7	79	594				
	1998.07-2005.03	2005.03	MT	R	F	Hatchback Engine WJY(DW8B)/WJZ(DW8)	GDS10167	Drive Shaft		25	24	55.7	79	868				
	1998.07-2005.03	2005.03	MT	R	F	Hatchback Engine WJY(DW8B)/WJZ(DW8)	GDS10023	Drive Shaft	29T	25	24	55.7	79	868				
1.9 SD (55 kW)	1998.01-2000.09	2000.09			F	Hatchback Engine DHV(XUD9SD)	GC010020	Outer Joint	29T	25	34	58	78.5	55	I			
1.9 TD (66 kW)	1997.04-2000.09	2000.09			F	Hatchback Engine DHY(XUD9TE/Y)	GC010020	Outer Joint	29T	25	34	58	78.5	55	I			
2.0 16V (100 kW)	2000.09-2005.03	2005.03	5MT		F	Hatchback Engine RFN(EW10J4)	GC010022	Outer Joint	29W	25	34	55.7	79	55	I			
	2000.09-2005.03	2005.03	MT		F	Hatchback Engine RFN(EW10J4)	GC010002	Outer Joint		25	23	54.8	78.5	56	I			
	2000.09-2005.03	2005.03	MT		F	Hatchback Engine RFN(EW10J4)	GC010003	Outer Joint	29T	25	23	54.8	78.5	56	I			
	2000.09-2005.03	2005.03	5MT	L	F	Hatchback Engine RFN(EW10J4)	GCI45018	Inner Joint		24	34	40	62	88				
	2000.09-2005.03	2005.03	5MT	L	F	Hatchback Engine RFN(EW10J4)	GDS10225	Drive Shaft	29T	25	24	55	79.5	585				
	2000.09-2005.03	2005.03	MT	L	F	Hatchback Engine RFN(EW10J4)	GDS99195	Drive Shaft	48W	25	24	58.5	79	585				
	2000.09-2005.03	2005.03	MT	L	F	Hatchback Engine RFN(EW10J4)	GDS10163	Drive Shaft		25	24	54.8	78.5	583				
	2000.09-2005.03	2005.03	MT	L	F	Hatchback Engine RFN(EW10J4)	GDS10131	Drive Shaft	29T	25	24	54.8	78.5	583				
	2000.09-2005.03	2005.03	MT	R	F	Hatchback Engine RFN(EW10J4)	GDS99196	Drive Shaft	48W	25	24	58.5	79	869				
	2000.09-2005.03	2005.03	MT	R	F	Hatchback Engine RFN(EW10J4)	GDS10167	Drive Shaft		25	24	55.7	79	868				
	2000.09-2005.03	2005.03	MT	R	F	Hatchback Engine RFN(EW10J4)	GDS10023	Drive Shaft	29T	25	24	55.7	79	868				
2.0 HDi (66 kW)	1999.02-2005.03	2005.03			F	Hatchback Engine RHY(DW10TD)	GC010022	Outer Joint	29W	25	34	55.7	79	55	I			
	1999.02-2005.03	2005.03		L	F	Hatchback Engine RHY(DW10TD)	GDS10225	Drive Shaft	29T	25	24	55	79.5	585				
	1999.02-2005.03	2005.03		L	F	Hatchback Engine RHY(DW10TD)	GDS99195	Drive Shaft	48W	25	24	58.5	79	585				
	1999.02-2005.03	2005.03		L	F	Hatchback Engine RHY(DW10TD)	GCI45018	Inner Joint		24	34	40	62	88				
	1999.02-2005.03	2005.03	MT	R	F	Hatchback Engine RHY(DW10TD)	GDS10193	Drive Shaft	29T	25	24	55.7	79	867				
	1999.02-2005.03	2005.03		R	F	Hatchback Engine RHY(DW10TD)	GDS99196	Drive Shaft	48W	25	24	58.5	79	869				
2.0 HDi (80 kW)	2001.05-2005.03	2005.03	MT/AT		F	Hatchback Engine RHZ(DW10ATED)	GC010022	Outer Joint	29W	25	34	55.7	79	55	I			
	2001.05-2005.03	2005.03	MT	L	F	Hatchback Engine RHZ(DW10ATED)	GDS99195	Drive Shaft	48W	25	24	58.5	79	585				
	2001.05-2005.03	2005.03	MT/AT	L	F	Hatchback Engine RHZ(DW10ATED)	GCI45018	Inner Joint		24	34	40	62	88				
	2001.05-2005.03	2005.03	MT/AT	L	F	Hatchback Engine RHZ(DW10ATED)	GDS10225	Drive Shaft	29T	25	24	55	79.5	585				
	2001.05-2005.03	2005.03	MT	R	F	Hatchback Engine RHZ(DW10ATED)	GDS99196	Drive Shaft	48W	25	24	58.5	79	869				
	2001.05-2005.03	2005.03	MT	R	F	Hatchback Engine RHZ(DW10ATED)	GDS10193	Drive Shaft	29T	25	24	55.7	79	867				
<b>XSARA (N2)</b>																		
1.4 HDi (50 kW)	2003.01-2005.08	2005.08			F	Estate Engine 8HX(DV4TD)	GC010076	Outer Joint	29W	25	34	58.5	79	55	I			
1.4 i (55 kW)	1997.10-2005.08	2005.08	MT	L	F	Estate Engine KFW(TU3JP)/KFX(TU3JP)	GCI45011	Inner Joint		22	22	40	65.2	87.8				
	1997.10-2005.08	2005.08	MT	L	F	Estate Engine KFW(TU3JP)/KFX(TU3JP)	GDS10018	Drive Shaft	29T	25	22	60	80	603				
	1997.10-2005.08	2005.08	MT	L	F	Estate Engine KFW(TU3JP)/KFX(TU3JP)	GDS10040	Drive Shaft		21	22	56.4	76	595				
	1997.10-2005.08	2005.08	MT	L	F	Estate Engine KFW(TU3JP)/KFX(TU3JP)	GDS10043	Drive Shaft		21	22	48	86.5	610				
	1997.10-2005.08	2005.08	MT	R	F	Estate Engine KFW(TU3JP)/KFX(TU3JP)	GDS10019	Drive Shaft	29T	25	22	60	80	867				
	1997.10-2005.08	2005.08	MT	R	F	Estate Engine KFW(TU3JP)/KFX(TU3JP)	GDS10017	Drive Shaft		21	22	56.4	76	860				





		TRANSM	L/R	F/R		G-AP Ref.	PRODUCT	ABS	Technical Specifications								
									YEAR	A	B	C	H	L	P		
<b>CITROEN XSARA (N2)</b>																	
1.4 i (55 kW)	1997.10-	2005.08	MT	R	F	Estate Engine KFW(TU3JP)/KFX(TU3JP)	GDS10203	Drive Shaft		21	22	48	86.5	877			
1.6 16V (80 kW)	2000.09-	2005.08	MT		F	Estate Engine NFU(TU5JP4)	GC010002	Outer Joint		25	23	54.8	78.5	56	I		
	2000.09-	2005.08	MT		F	Estate Engine NFU(TU5JP4)	GC010003	Outer Joint	29T	25	23	54.8	78.5	56	I		
	2000.09-	2005.08	MT	L	F	Estate Engine NFU(TU5JP4)	GDS10053	Drive Shaft	29T	25	22	54.5	79.5	592			
	2000.09-	2005.08	MT/AT	L	F	Estate Engine NFU(TU5JP4)	GDS10204	Drive Shaft		25	22	58.5	79	594			
	2000.09-	2005.08				Estate Engine NFU(TU5JP4)	GC099006	Outer Joint		25	22	60	78.7	54	M		
	2000.09-	2005.08				Estate Engine NFU(TU5JP4)	GC099221	Outer Joint	29T	25	22	60	78.7	54	M		
1.6 i (65 kW)	1997.10-	2000.09	MT	R	F	Estate Engine NFZ(TU5JP)	GDS10027	Drive Shaft		25	22	56.7	79	868			
1.8 i (66 kW)	1997.10-	2000.09			F	Estate Engine LFX(XU7JB)	GC010020	Outer Joint	29T	25	34	58	78.5	55	I		
1.8 i 16V (81 kW)	1997.10-	2000.09			F	Estate Engine LFY(XU7JP4)	GC010020	Outer Joint	29T	25	34	58	78.5	55	I		
1.9 D (50 kW)	1997.10-	2000.09			F	Estate Engine DJY(XUD9A)	GC010020	Outer Joint	29T	25	34	58	78.5	55	I		
1.9 D (51 kW)	1998.07-	2005.08			F	Estate Engine WJY(DW8B)/WJZ(DW8)	GC010076	Outer Joint	29W	25	34	58.5	79	55	I		
	1998.07-	2005.08	MT	L	F	Estate Engine WJY(DW8B)/WJZ(DW8)	GDS99025	Drive Shaft	29W	25	24	55.7	79	597			
	1998.07-	2005.08	MT	L	F	Estate Engine WJY(DW8B)/WJZ(DW8)	GCI45017	Inner Joint		24	34	40	69	99			
	1998.07-	2005.08	MT	L	F	Estate Engine WJY(DW8B)/WJZ(DW8)	GDS10165	Drive Shaft		25	24	55.7	79	594			
	1998.07-	2005.08	MT	L	F	Estate Engine WJY(DW8B)/WJZ(DW8)	GDS10128	Drive Shaft	29T	25	24	55.7	79	594			
	1998.07-	2005.08	MT	R	F	Estate Engine WJY(DW8B)/WJZ(DW8)	GDS10167	Drive Shaft		25	24	55.7	79	868			
1998.07-	2005.08	MT	R	F	Estate Engine WJY(DW8B)/WJZ(DW8)	GDS10023	Drive Shaft	29T	25	24	55.7	79	868				
1.9 TD (66 kW)	1997.10-	2000.09			F	Estate Engine DHY(XUD9TE/Y)	GC010020	Outer Joint	29T	25	34	58	78.5	55	I		
2.0 16V (100 kW)	2000.09-	2005.08			F	Estate Engine RFN(EW10J4)	GC010022	Outer Joint	29W	25	34	55.7	79	55	I		
	2000.09-	2005.08	MT		F	Estate Engine RFN(EW10J4)	GC010002	Outer Joint		25	23	54.8	78.5	56	I		
	2000.09-	2005.08	MT		F	Estate Engine RFN(EW10J4)	GC010003	Outer Joint	29T	25	23	54.8	78.5	56	I		
	2000.09-	2005.08		L	F	Estate Engine RFN(EW10J4)	GDS10225	Drive Shaft	29T	25	24	55	79.5	585			
	2000.09-	2005.08	MT	L	F	Estate Engine RFN(EW10J4)	GDS99195	Drive Shaft	48W	25	24	58.5	79	585			
	2000.09-	2005.08	MT	L	F	Estate Engine RFN(EW10J4)	GDS10163	Drive Shaft		25	24	54.8	78.5	583			
	2000.09-	2005.08	MT	L	F	Estate Engine RFN(EW10J4)	GDS10131	Drive Shaft	29T	25	24	54.8	78.5	583			
	2000.09-	2005.08		L	F	Estate Engine RFN(EW10J4)	GCI45018	Inner Joint		24	34	40	62	88			
	2000.09-	2005.08	MT	R	F	Estate Engine RFN(EW10J4)	GDS99196	Drive Shaft	48W	25	24	58.5	79	869			
	2000.09-	2005.08	MT	R	F	Estate Engine RFN(EW10J4)	GDS10167	Drive Shaft		25	24	55.7	79	868			
	2000.09-	2005.08	MT	R	F	Estate Engine RFN(EW10J4)	GDS10023	Drive Shaft	29T	25	24	55.7	79	868			
	2.0 HDi (66 kW)	1999.02-	2005.08			F	Estate Engine RHY(DW10TD)	GC010022	Outer Joint	29W	25	34	55.7	79	55	I	
1999.02-	2005.08		L	F	Estate Engine RHY(DW10TD)	GDS10225	Drive Shaft	29T	25	24	55	79.5	585				
1999.02-	2005.08		L	F	Estate Engine RHY(DW10TD)	GDS99195	Drive Shaft	48W	25	24	58.5	79	585				
1999.02-	2005.08		L	F	Estate Engine RHY(DW10TD)	GCI45018	Inner Joint		24	34	40	62	88				
1999.02-	2005.08	MT	R	F	Estate Engine RHY(DW10TD)	GDS10193	Drive Shaft	29T	25	24	55.7	79	867				
1999.02-	2005.08		R	F	Estate Engine RHY(DW10TD)	GDS99196	Drive Shaft	48W	25	24	58.5	79	869				
2.0 HDi (80 kW)	2001.05-	2005.08	MT/AT		F	Estate Engine RHZ(DW10ATED)	GC010022	Outer Joint	29W	25	34	55.7	79	55	I		
	2001.05-	2005.08	MT	L	F	Estate Engine RHZ(DW10ATED)	GDS99195	Drive Shaft	48W	25	24	58.5	79	585			
	2001.05-	2005.08	MT/AT	L	F	Estate Engine RHZ(DW10ATED)	GCI45018	Inner Joint		24	34	40	62	88			
	2001.05-	2005.08	MT/AT	L	F	Estate Engine RHZ(DW10ATED)	GDS10225	Drive Shaft	29T	25	24	55	79.5	585			
	2001.05-	2005.08	MT	R	F	Estate Engine RHZ(DW10ATED)	GDS99196	Drive Shaft	48W	25	24	58.5	79	869			
	2001.05-	2005.08	MT	R	F	Estate Engine RHZ(DW10ATED)	GDS10193	Drive Shaft	29T	25	24	55.7	79	867			
<b>XSARA PICASSO</b>																	
1.6 HDi	2004.02-		MT/AT		F		GC045047	Outer Joint	48T	25	34	59	78.5	54	I		
<b>XSARA PICASSO (N68)</b>																	
1.6 (67 kW)	2002.06-			L	F	MPV	GDS10204	Drive Shaft		25	22	58.5	79	594			
	2002.06-		MT	L	F	MPV	GDS10128	Drive Shaft	29T	25	24	55.7	79	594			
	2002.06-		MT	R	F	MPV	GDS10023	Drive Shaft	29T	25	24	55.7	79	868			
	2002.06-		MT	L	F	MPV	GCI45017	Inner Joint		24	34	40	69	99			
1.6 16V (80 kW)	2005.10-				F	MPV Engine NFU(TU5JP4)	GC010067	Outer Joint	48W	25	34	58.5	79	55	I		
	2005.10-			L	F	MPV Engine NFU(TU5JP4)	GDS99195	Drive Shaft	48W	25	24	58.5	79	585			
	2005.10-			R	F	MPV Engine NFU(TU5JP4)	GDS99196	Drive Shaft	48W	25	24	58.5	79	869			
	2005.10-					MPV Engine NFU(TU5JP4)	GC099293	Outer Joint	48W	25	34	58.5	79	55	I		
1.6 16V (81 kW)	2005.06-	2006.09	MT	L	F	MPV Engine NFU(TU5JP4)	GDS99195	Drive Shaft	48W	25	24	58.5	79	585			
	2005.06-	2006.09	MT	R	F	MPV Engine NFU(TU5JP4)	GDS99196	Drive Shaft	48W	25	24	58.5	79	869			
	2005.06-	2006.09	MT			MPV Engine NFU(TU5JP4)	GC099293	Outer Joint	48W	25	34	58.5	79	55	I		
1.6 HDi (66 kW)	2005.10-	2007.03			F	MPV Engine 9HX(DV6ATED4)	GC010067	Outer Joint	48W	25	34	58.5	79	55	I		
	2005.10-	2007.03		L	F	MPV Engine 9HX(DV6ATED4)	GDS99195	Drive Shaft	48W	25	24	58.5	79	585			
	2005.10-	2007.03		R	F	MPV Engine 9HX(DV6ATED4)	GDS99196	Drive Shaft	48W	25	24	58.5	79	869			
	2005.10-	2007.03				MPV Engine 9HX(DV6ATED4)	GC099293	Outer Joint	48W	25	34	58.5	79	55	I		
1.6 HDi (80 kW)	2004.02-	2007.03			F	MPV Engine 9HY(DV6TED4)/9HZ(DV6TED4)	GC010067	Outer Joint	48W	25	34	58.5	79	55	I		
	2004.02-	2007.03		L	F	MPV Engine 9HY(DV6TED4)/9HZ(DV6TED4)	GDS99195	Drive Shaft	48W	25	24	58.5	79	585			









																				
									YEAR	A	B	C	H	L	P					
<b>CITROEN XSARA PICASSO (N68)</b>																				
1.6 HDi (80 kW)	2004.02-	2007.03				MPV Engine 9HY(DV6TED4)/9HZ(DV6TED4)	GDS99196	Drive Shaft	48W	25	24	58.5	79	869						
	2004.02-	2007.03				MPV Engine 9HY(DV6TED4)/9HZ(DV6TED4)	GC099293	Outer Joint	48W	25	34	58.5	79	55	I					
1.8 16V (85 kW)	2000.02-					MPV Engine 6FZ(EW7J4)	GDS99195	Drive Shaft	48W	25	24	58.5	79	585						
	2000.02-					MPV Engine 6FZ(EW7J4)	GDS99196	Drive Shaft	48W	25	24	58.5	79	869						
	2000.02-		MT			MPV Engine 6FZ(EW7J4)	GCI45017	Inner Joint		24	34	40	69	99						
	2000.02-					MPV Engine 6FZ(EW7J4)	GC099293	Outer Joint	48W	25	34	58.5	79	55	I					
2.0 16V (100 kW)	2003.01-	2007.03				MPV Engine RFN(EW10J4)	GC010022	Outer Joint	29W	25	34	55.7	79	55	I					
	2003.01-	2007.03				MPV Engine RFN(EW10J4)	GDS10225	Drive Shaft	29T	25	24	55	79.5	585						
	2003.01-	2007.03	MT			MPV Engine RFN(EW10J4)	GDS99195	Drive Shaft	48W	25	24	58.5	79	585						
	2003.01-	2007.03	MT			MPV Engine RFN(EW10J4)	GDS10131	Drive Shaft	29T	25	24	54.8	78.5	583						
	2003.01-	2007.03				MPV Engine RFN(EW10J4)	GCI45018	Inner Joint		24	34	40	62	88						
	2003.01-	2007.03	MT			MPV Engine RFN(EW10J4)	GDS99196	Drive Shaft	48W	25	24	58.5	79	869						
	2003.01-	2007.03	MT			MPV Engine RFN(EW10J4)	GDS10023	Drive Shaft	29T	25	24	55.7	79	868						
<b>XSARA VAN</b>																				
2.0 HDi	2003.01-						GDS10051	Drive Shaft	29T	25	24	55.7	79	865						
<b>ZX</b>																				
-						LADO ESQUERDO	GCI45018	Inner Joint		24	34	40	62	88						
							GCI45020	Inner Joint		24	34	40	69	89						
1.9 TD	1992.07-	1998.02					GDS10150	Drive Shaft		25	24	54.8	78.5	866						
2.0 i	1992.10-	1996.06	MT/AT				GC010065	Outer Joint	48T	25	34	58.5	80	55	I					
<b>ZX (N2)</b>																				
1.1 (44 kW)	1991.03-	1997.06	MT			Hatchback Engine HDZ(TU1M)	GDS10004	Drive Shaft		21	22	56.4	76	855.5						
1.4 (55 kW)	1991.03-	1997.06	MT			Hatchback Engine KDZ(TU3M/Z)	GDS10004	Drive Shaft		21	22	56.4	76	855.5						
1.4 i (55 kW)	1991.03-	1997.06	MT			Hatchback Engine KDX(TU3M/Z)/KDY(TU3M/Z)/KFX(TU3JP)	GDS10004	Drive Shaft		21	22	56.4	76	855.5						
	1993.10-	1997.10	MT			Estate Engine KDX(TU3M/Z)/KDY(TU3M/Z)/KFX(TU3JP)	GDS10004	Drive Shaft		21	22	56.4	76	855.5						
1.6 i (65 kW)	1991.03-	1997.06				Hatchback Engine BDY(XU5M)/BFZ(XU5JP)	GDS10117	Drive Shaft		25	24	54.8	79	592.5						
	1993.10-	1997.10				Estate Engine BDY(XU5M)/BFZ(XU5JP)	GDS10117	Drive Shaft		25	24	54.8	79	592.5						
1.8 D (44 kW)	1993.06-	1997.06				Hatchback Engine 161A(XUD7)	GDS10117	Drive Shaft		25	24	54.8	79	592.5						
	1993.10-	1997.10				Estate Engine 161A(XUD7)	GDS10117	Drive Shaft		25	24	54.8	79	592.5						
1.8 i (74 kW)	1992.07-	1997.06				Hatchback Engine LFZ(XU7JP)	GDS10117	Drive Shaft		25	24	54.8	79	592.5						
	1993.10-	1997.10				Estate Engine LFZ(XU7JP)	GDS10117	Drive Shaft		25	24	54.8	79	592.5						
1.8 i 16V (81 kW)	1996.01-	1997.06				Hatchback Engine LFY(XU7JP4)	GDS10117	Drive Shaft		25	24	54.8	79	592.5						
	1996.01-	1998.02				Estate Engine LFY(XU7JP4)	GDS10117	Drive Shaft		25	24	54.8	79	592.5						
1.9 D (47 kW)	1991.03-	1997.06				Hatchback Engine DJZ(XUD9Y)	GDS10117	Drive Shaft		25	24	54.8	79	592.5						
	1993.10-	1997.10				Estate Engine DJZ(XUD9Y)	GDS10117	Drive Shaft		25	24	54.8	79	592.5						
1.9 D (50 kW)	1993.07-	1997.06				Hatchback Engine D9B(XUD9A/U)/DJY(XUD9A)	GDS10117	Drive Shaft		25	24	54.8	79	592.5						
	1994.06-	1997.10				Estate Engine D9B(XUD9A/U)	GDS10117	Drive Shaft		25	24	54.8	79	592.5						
2.0 i 16V (110 kW)	1994.06-	1997.06	MT			Hatchback Engine RFT(XU10J4/Z)	GDS10022	Drive Shaft	48T	25	24	54.8	78.5	573						
2.0 i 16V (112 kW)	1992.07-	1994.10	MT			Hatchback Engine RFT(XU10J4/Z)/RFY(XU10J4/Z)	GDS10022	Drive Shaft	48T	25	24	54.8	78.5	573						
<b>CITROEN LCV</b>																				
<b>CITROEN LCV</b>																				
2.2 HDi (110 kW)	2011.07-						GCI17021	Inner Joint		31	29	34.85	530	109						
3.0 HDi (115 kW)	2010.07-						GCI17021	Inner Joint		31	29	34.85	530	109						
<b>JUMPER III</b>																				
2.2 HDi (110 kW)	2011.07-						GC017060	Outer Joint		35	29	71.5	127	71	I					
	2011.07-						GC017061	Outer Joint	54T	35	29	71.5	127	71	I					
2.2 HDi (74 kW)	2006.04-						GCI17042	Inner Joint		41	27	43	70	102						
	2006.04-						GCI10038	Inner Joint		41	27	34.85	403	102						
	2006.04-						GC017055	Outer Joint		35	27	71.5	127	66.5	I					
2.2 HDi (88 kW)	2006.04-						GCI17042	Inner Joint		41	27	43	70	102						
	2006.04-						GCI10038	Inner Joint		41	27	34.85	403	102						
	2006.04-						GC017055	Outer Joint		35	27	71.5	127	66.5	I					
	2011.07-						GCI17028	Inner Joint		41	29	43	69.5	109.5						
	2011.07-						GC017054	Outer Joint		35	29	71.5	127	71	M					
2.2 HDi (96 kW)	2006.04-						GCI17042	Inner Joint		41	27	43	70	102						
	2006.04-						GCI10038	Inner Joint		41	27	34.85	403	102						
	2006.04-						GC017055	Outer Joint		35	27	71.5	127	66.5	I					
	2011.07-						GCI17028	Inner Joint		41	29	43	69.5	109.5						
	2011.07-						GC017054	Outer Joint		35	29	71.5	127	71	M					
3.0 HDi (115 kW)	2006.09-	2011.07					GC017060	Outer Joint		35	29	71.5	127	71	I					
	2006.09-	2011.07					GC017061	Outer Joint	54T	35	29	71.5	127	71	I					
	2006.09-						GCI17021	Inner Joint		31	29	34.85	530	109						



	 YEAR	TRANSM	L/R	F/R		G-AP Ref.	PRODUCT	ABS	Technical Specifications											
									A	B	C	H	L	P						
<b>CITROEN LCV</b>																				
<b>JUMPER III</b>																				
3.0 HDi (130 kW)	2006.09-	2011.07				GC017060	Outer Joint		35	29	71.5	127	71	I						
	2006.09-	2011.07				GC017061	Outer Joint	54T	35	29	71.5	127	71	I						
	2011.07-			R		GCI17021	Inner Joint		31	29	34.85	530	109							
<b>NEMO (AA)</b>																				
1.3 HDi (55 kW)	2012.05-					GC017028	Outer Joint		25	24	51	84.5	62	M						
1.4 (54 kW)	2008.02-			L		GC017070	Outer Joint		22	22	51	79	57.5	M						
<b>CITROEN UTILITAIRES</b>																				
<b>BERLINGO</b>																				
1.8 Essence/Diesel				L		GDS10080	Drive Shaft	29W	25	24	55.7	79	597							
1.8 Essence/Diesel 1.9 Diesel					Engine XU BE3	GC010049	Outer Joint		25	34	55.7	79	55	I						
				R	Engine XU BE3	GDS10078	Drive Shaft	29W	25	24	55.7	79	872							
1.9 D				L	Moterur Xu	GDS10080	Drive Shaft	29W	25	24	55.7	79	597							
<b>DACIA</b>																				
<b>1300</b>																				
1.3 (40 kW)	1972.12-	1983.05	MT		Estate Engine 810-02/-99	GC050081	Outer Joint		20	30	48	107	57.5	O						
<b>1310</b>																				
1.3 (40 kW)	1983.05-	2004.07	MT	L/R	F	Estate Engine 810-02/-99	GCI50059	Inner Joint	23	22	36.3	41	64.5							
	1983.05-	2004.07	MT	L/R	F	Estate Engine 810-02/-99	GDS11001	Drive Shaft	20	23	48	107	645							
	1983.05-	2004.07	MT	L/R	F	Estate Engine 810-02/-99	GDS11004	Drive Shaft	20	23	48	107	650							
<b>1310 (U, X)</b>																				
1.3 (40 kW)	1983.05-	2004.07	MT	L/R	F	Saloon Engine 810-02/-99	GCI50059	Inner Joint	23	22	36.3	41	64.5							
	1983.05-	2004.07	MT	L/R	F	Saloon Engine 810-02/-99	GDS11001	Drive Shaft	20	23	48	107	645							
	1983.05-	2004.07	MT	L/R	F	Saloon Engine 810-02/-99	GDS11004	Drive Shaft	20	23	48	107	650							
<b>DOKKER</b>																				
1.2 TCE (85 kW)	2012.11-				Estate Engine H5F402	GC050162	Outer Joint		25	23	52.5	88.5	60.5	M						
1.5 DCi (55 kW)	2012.11-				Estate Engine K9K612	GC050162	Outer Joint		25	23	52.5	88.5	60.5	M						
1.5 DCi (66 kW)	2012.11-				Estate	GC050162	Outer Joint		25	23	52.5	88.5	60.5	M						
1.6 16V (61 kW)	2012.11-				Estate	GC050162	Outer Joint		25	23	52.5	88.5	60.5	M						
<b>DOKKER EXPRESS</b>																				
1.2 TCE (84 kW)	2012.12-				Box Engine H5F402	GC050162	Outer Joint		25	23	52.5	88.5	60.5	M						
1.5 DCi (55 kW)	2012.12-				Box Engine K9K612	GC050162	Outer Joint		25	23	52.5	88.5	60.5	M						
1.5 DCi (66 kW)	2012.12-				Box	GC050162	Outer Joint		25	23	52.5	88.5	60.5	M						
1.6 16V (61 kW)	2012.12-				Box	GC050162	Outer Joint		25	23	52.5	88.5	60.5	M						
<b>DUSTER</b>																				
1.2 TCe 125 (92 kW)	2013.10-			R	F	Closed Off-Road Vehicle	GDS50569	Drive Shaft	25	26	52.6	89	950							
1.5 DCi (63 kW)	2010.04-		MT	L	F	Closed Off-Road Vehicle Engine K9K796	GDS50498	Drive Shaft	25	26	52.6	89	702							
	2010.04-			R	F	Closed Off-Road Vehicle Engine K9K796	GDS50569	Drive Shaft	25	26	52.6	89	950							
1.5 DCi (66 kW)	2010.10-			L	F	Closed Off-Road Vehicle Engine K9K892	GDS50498	Drive Shaft	25	26	52.6	89	702							
	2010.10-			R	F	Closed Off-Road Vehicle Engine K9K892	GDS50569	Drive Shaft	25	26	52.6	89	950							
	2010.10-				Closed Off-Road Vehicle Engine K9K892	GC050157	Outer Joint		25	33	52.6	89	60	I						
1.5 DCi (79 kW)	2010.06-			R	F	Closed Off-Road Vehicle Engine K9K896	GDS50569	Drive Shaft	25	26	52.6	89	950							
1.5 DCi (80 kW)	2013.08-			R	F	Closed Off-Road Vehicle Engine K9K856	GDS50569	Drive Shaft	25	26	52.6	89	950							
1.5 DCi 2WD	2010-			L	F		GDS50415	Drive Shaft	25	26	52.6	89	704							
	2010-			R	F		GDS50416	Drive Shaft	25	26	52.6	89	950							
1.5 DCi 4x4 (66 kW)	2010.10-				Closed Off-Road Vehicle Engine K9K894	GC050157	Outer Joint		25	33	52.6	89	60	I						
1.6 16V (77 kW)	2010.04-			L	F	Closed Off-Road Vehicle Engine K4M690/K4M696	GDS50498	Drive Shaft	25	26	52.6	89	702							
	2010.04-			R	F	Closed Off-Road Vehicle Engine K4M690/K4M696	GDS50569	Drive Shaft	25	26	52.6	89	950							
	2010.04-				Closed Off-Road Vehicle Engine K4M690/K4M696	GC050157	Outer Joint		25	33	52.6	89	60	I						
1.6 16V 4x4 (77 kW)	2010.06-				Closed Off-Road Vehicle Engine K4M606	GC050157	Outer Joint		25	33	52.6	89	60	I						
1.6 16V Hi-Flex (77 kW)	2010.08-			L	F	Closed Off-Road Vehicle Engine K4M696	GDS50498	Drive Shaft	25	26	52.6	89	702							
	2010.08-			R	F	Closed Off-Road Vehicle Engine K4M696	GDS50569	Drive Shaft	25	26	52.6	89	950							
	2010.08-		6MT		Closed Off-Road Vehicle Engine K4M696	GC010155	Outer Joint		25	39	58.5	89	63.5	I						
	2010.08-				Closed Off-Road Vehicle Engine K4M696	GC050157	Outer Joint		25	33	52.6	89	60	I						
1.6 16V LPG (77 kW)	2011.04-			L	F	Closed Off-Road Vehicle Engine K4M696	GDS50498	Drive Shaft	25	26	52.6	89	702							
	2011.04-			R	F	Closed Off-Road Vehicle Engine K4M696	GDS50569	Drive Shaft	25	26	52.6	89	950							
	2011.04-				Closed Off-Road Vehicle Engine K4M696	GC050157	Outer Joint		25	33	52.6	89	60	I						
<b>LODGY</b>																				
1.2 TCE (85 kW)	2012.03-				Estate Engine H5F402	GC050162	Outer Joint		25	23	52.5	88.5	60.5	M						
1.5 DCi (66 kW)	2012.03-				Estate	GC050162	Outer Joint		25	23	52.5	88.5	60.5	M						
1.5 DCi (79 kW)	2010.06-				Estate	GC050162	Outer Joint		25	23	52.5	88.5	60.5	M						
1.6 (61 kW)	2012.03-				Estate Engine K7MA8	GC050162	Outer Joint		25	23	52.5	88.5	60.5	M						

	 YEAR	TRANSM	L/R	F/R		G-AP Ref.	PRODUCT	ABS	Technical Specifications								
									A	B	C	H	L	P			
<b>DACIA</b>																	
<b>LOGAN</b>																	
1.5 DCi (50 kW)	2008.03-				Pickup	GC099085	Outer Joint		23	30	49	86	59	I			
1.5 DCi (63 kW)	2008.03-				Pickup	GC099085	Outer Joint		23	30	49	86	59	I			
1.6 (64 kW)	2008.03-				Pickup	GC099085	Outer Joint		23	30	49	86	59	I			
<b>LOGAN (LS_)</b>																	
1.4 (55 kW)	2004.09-		MT	L	F	Saloon Engine K7J710	GDS45084	Drive Shaft	21	29.95	49	84	681				
	2004.09-		MT	R	F	Saloon Engine K7J710	GDS45085	Drive Shaft	21	23	49	84	763				
1.5 DCi (48 kW)	2005.09-		MT	L	F	Saloon Engine K9K790	GDS11012	Drive Shaft	23	29.95	49	83.5	681				
	2005.09-		MT	R	F	Saloon Engine K9K790	GDS11014	Drive Shaft	23	23	49	83.5	755				
1.5 DCi (50 kW)	2006.01-				F	Saloon Engine K9K792	GC099085	Outer Joint	23	30	49	86	59	I			
	2006.01-				L	F	Saloon Engine K9K792	GDS50353	Drive Shaft	23	26	49	86	649			
	2006.01-		MT	L	F	Saloon Engine K9K792	GDS11012	Drive Shaft	23	29.95	49	83.5	681				
	2006.01-				R	F	Saloon Engine K9K792	GDS50354	Drive Shaft	23	26	49	86	897			
1.5 DCi (55 kW)	2006.01-		MT	R	F	Saloon Engine K9K792	GDS11014	Drive Shaft	23	23	49	83.5	755				
	2010.05-				L	F	Saloon Engine K9K892	GDS50570	Drive Shaft	23	26	49	83.5	647			
1.5 DCi (63 kW)	2007.09-				L	F	Saloon Engine K9K796	GDS50353	Drive Shaft	23	26	49	86	649			
	2007.09-				R	F	Saloon Engine K9K796	GDS50354	Drive Shaft	23	26	49	86	897			
	2007.09-				L	F	Saloon Engine K9K796	GDS50570	Drive Shaft	23	26	49	83.5	647			
1.5 DCi (65 kW)	2010.05-			L	F	Saloon Engine K9K892	GDS50570	Drive Shaft	23	26	49	83.5	647				
1.6 (64 kW)	2004.09-		MT	L	F	Saloon Engine K7M710	GDS45084	Drive Shaft	21	29.95	49	84	681				
	2004.09-		MT	R	F	Saloon Engine K7M710	GDS45085	Drive Shaft	21	23	49	84	763				
1.6 16V (77 kW)	2006.02-				F	Saloon Engine K4M690/K4M696	GC099085	Outer Joint	23	30	49	86	59	I			
	2006.02-				L	F	Saloon Engine K4M690/K4M696	GDS50353	Drive Shaft	23	26	49	86	649			
	2006.02-				R	F	Saloon Engine K4M690/K4M696	GDS50354	Drive Shaft	23	26	49	86	897			
<b>LOGAN (US_)</b>																	
1.5 DCi (50 kW)	2008.03-				F	Pickup Engine K9K792	GC099085	Outer Joint	23	30	49	86	59	I			
	2008.03-				L	F	Pickup Engine K9K792	GDS50570	Drive Shaft	23	26	49	83.5	647			
1.5 DCi (55 kW)	2010.05-			L	F	Pickup Engine K9K892	GDS50570	Drive Shaft	23	26	49	83.5	647				
1.5 DCi (63 kW)	2008.03-				L	F	Pickup Engine K9K796	GDS50570	Drive Shaft	23	26	49	83.5	647			
1.5 DCi (65 kW)	2010.05-				L	F	Pickup Engine K9K892	GDS50570	Drive Shaft	23	26	49	83.5	647			
1.6 (64 kW)	2008.03-				F	Pickup Engine K7M710	GC099085	Outer Joint	23	30	49	86	59	I			
	2008.03-				L	F	Pickup Engine K7M710	GDS50570	Drive Shaft	23	26	49	83.5	647			
1.6 Bifuel (62 kW)	2010.05-				L	F	Pickup Engine K7M800	GDS50570	Drive Shaft	23	26	49	83.5	647			
1.6 MPI (62 kW)	2010.05-				L	F	Pickup Engine K7M800	GDS50570	Drive Shaft	23	26	49	83.5	647			
<b>LOGAN EXPRESS</b>																	
1.5 DCi (50 kW)	2009.03-					GC099085	Outer Joint		23	30	49	86	59	I			
1.5 DCi (63 kW)	2009.03-					GC099085	Outer Joint		23	30	49	86	59	I			
1.6 (64 kW)	2009.03-					GC099085	Outer Joint		23	30	49	86	59	I			
<b>LOGAN EXPRESS (FS_)</b>																	
1.5 DCi (50 kW)	2009.03-				F	Box Engine K9K792	GC099085	Outer Joint	23	30	49	86	59	I			
	2009.03-				L	F	Box Engine K9K792	GDS50570	Drive Shaft	23	26	49	83.5	647			
1.5 DCi (55 kW)	2010.05-			L	F	Box Engine K9K892	GDS50570	Drive Shaft	23	26	49	83.5	647				
1.5 DCi (63 kW)	2009.03-				L	F	Box Engine K9K796	GDS50570	Drive Shaft	23	26	49	83.5	647			
1.5 DCi (65 kW)	2010.05-				L	F	Box Engine K9K892	GDS50570	Drive Shaft	23	26	49	83.5	647			
1.6 (64 kW)	2009.03-				F	Box Engine K7M710	GC099085	Outer Joint	23	30	49	86	59	I			
	2009.03-				L	F	Box Engine K7M710	GDS50570	Drive Shaft	23	26	49	83.5	647			
1.6 MPI (62 kW)	2010.05-				L	F	Box Engine K7M800	GDS50570	Drive Shaft	23	26	49	83.5	647			
<b>LOGAN MCV</b>																	
1.5 DCi (48 kW)	2005.09-					GC099085	Outer Joint		23	30	49	86	59	I			
1.5 DCi (50 kW)	2006.01-					GC099085	Outer Joint		23	30	49	86	59	I			
1.5 DCi (63 kW)	2007.09-					GC099085	Outer Joint		23	30	49	86	59	I			
1.6 16V (77 kW)	2006.02-					GC099085	Outer Joint		23	30	49	86	59	I			
<b>LOGAN MCV (KS_)</b>																	
1.4 (55 kW)	2007.02-				L	F	Estate Engine K7J710	GDS50353	Drive Shaft	23	26	49	86	649			
	2007.02-		MT	L	F	Estate Engine K7J710	GDS45084	Drive Shaft	21	29.95	49	84	681				
	2007.02-				R	F	Estate Engine K7J710	GDS50354	Drive Shaft	23	26	49	86	897			
	2007.02-		MT	R	F	Estate Engine K7J710	GDS45085	Drive Shaft	21	23	49	84	763				
1.5 DCi (50 kW)	2007.02-				F	Estate Engine K9K792	GC099085	Outer Joint	23	30	49	86	59	I			
	2007.02-				L	F	Estate Engine K9K792	GDS50353	Drive Shaft	23	26	49	86	649			
	2007.02-		MT	L	F	Estate Engine K9K792	GDS11012	Drive Shaft	23	29.95	49	83.5	681				
	2007.02-				R	F	Estate Engine K9K792	GDS50354	Drive Shaft	23	26	49	86	897			
	2007.02-		MT	R	F	Estate Engine K9K792	GDS11014	Drive Shaft	23	23	49	83.5	755				
2007.02-				L	F	Estate Engine K9K792	GDS50570	Drive Shaft	23	26	49	83.5	647				









		TRANSM	L/R	F/R		G-AP Ref.	PRODUCT	ABS	Technical Specifications										
									YEAR	A	B	C	H	L	P				
<b>DACIA</b>																			
<b>LOGAN MCV (KS_)</b>																			
1.5 DCi (55 kW)	2010.05-			L F	Estate Engine K9K892	GDS50570	Drive Shaft		23	26	49	83.5	647						
1.5 DCi (63 kW)	2007.09-			L F	Estate Engine K9K796	GDS50353	Drive Shaft		23	26	49	86	649						
	2007.09-			R F	Estate Engine K9K796	GDS50354	Drive Shaft		23	26	49	86	897						
	2007.09-			L F	Estate Engine K9K796	GDS50570	Drive Shaft		23	26	49	83.5	647						
1.5 DCi (65 kW)	2010.05-			L F	Estate Engine K9K892	GDS50570	Drive Shaft		23	26	49	83.5	647						
1.6 (64 kW)	2007.02-			L F	Estate Engine K7M710	GDS50353	Drive Shaft		23	26	49	86	649						
	2007.02-		MT	L F	Estate Engine K7M710	GDS45084	Drive Shaft		21	29.95	49	84	681						
	2007.02-			R F	Estate Engine K7M710	GDS50354	Drive Shaft		23	26	49	86	897						
	2007.02-		MT	R F	Estate Engine K7M710	GDS45085	Drive Shaft		21	23	49	84	763						
	2007.02-			L F	Estate Engine K7M710	GDS50570	Drive Shaft		23	26	49	83.5	647						
1.6 16V (77 kW)	2007.02-			F	Estate Engine K4M690/K4M696	GC099085	Outer Joint		23	30	49	86	59	I					
	2007.02-			L F	Estate Engine K4M690/K4M696	GDS50353	Drive Shaft		23	26	49	86	649						
	2007.02-			R F	Estate Engine K4M690/K4M696	GDS50354	Drive Shaft		23	26	49	86	897						
	2007.02-		MT	L F	Estate Engine K4M690/K4M696	GDS50570	Drive Shaft		23	26	49	83.5	647						
<b>PICK UP</b>																			
1.4 i	2001-			R F		GDS50098	Drive Shaft		20	23	54	86	630						
	2001-			R F		GCI50058	Inner Joint		23	22	36.3	40	64.5						
1.5 DCi	2001-			R F		GDS50098	Drive Shaft		20	23	54	86	630						
	2001-			R F		GCI50058	Inner Joint		23	22	36.3	40	64.5						
1.9 D	2001-			R F		GDS50098	Drive Shaft		20	23	54	86	630						
	2001-			R F		GCI50058	Inner Joint		23	22	36.3	40	64.5						
<b>SANDERO</b>																			
1.2 16V (55 kW)	2008.11-			L F	Hatchback Engine D4F732	GDS45084	Drive Shaft		21	29.95	49	84	681						
	2008.11-			R F	Hatchback Engine D4F732	GDS45085	Drive Shaft		21	23	49	84	763						
1.4 (55 kW)	2008.06-			L F	Hatchback Engine K7J710	GDS45084	Drive Shaft		21	29.95	49	84	681						
	2008.06-			R F	Hatchback Engine K7J710	GDS45085	Drive Shaft		21	23	49	84	763						
1.5 DCi (50 kW)	2008.11-		MT	L F	Hatchback Engine K9K792	GDS50570	Drive Shaft		23	26	49	83.5	647						
1.5 DCi (55 kW)	2010.05-			L F	Hatchback Engine K9K892	GDS50570	Drive Shaft		23	26	49	83.5	647						
1.5 DCi (63 kW)	2008.11-			L F	Hatchback Engine K9K796	GDS50570	Drive Shaft		23	26	49	83.5	647						
1.5 DCi (65 kW)	2010.05-			L F	Hatchback Engine K9K892	GDS50570	Drive Shaft		23	26	49	83.5	647						
1.6 (64 kW)	2008.06-			L F	Hatchback Engine K7M710	GDS45084	Drive Shaft		21	29.95	49	84	681						
	2008.06-			R F	Hatchback Engine K7M710	GDS45085	Drive Shaft		21	23	49	84	763						
<b>SANDERO,STEPWAY</b>																			
1.5 DCi (65 kW)	2010-					GC099085	Outer Joint		23	30	49	86	59	I					
<b>SOLENZA</b>																			
1.4 (55 kW )	2003.02-			L F	Hatchback Engine K7J710	GDS11006	Drive Shaft		20	29.95	54	86	616						
	2003.02-			L F	Hatchback Engine K7J710	GC050030	Outer Joint		20	25	54	86	58.5	O					
	2003.02-		MT	R F	Hatchback Engine K7J710	GDS11007	Drive Shaft		20	23	54	86	744						
	2003.02-			R F	Hatchback Engine K7J710	GCI50008	Inner Joint		23	30	36.3	52.2	68.5						
1.4 MPI	2003-			L F		GDS11006	Drive Shaft		20	29.95	54	86	616						
	2003-			L/R	F	GC050030	Outer Joint		20	25	54	86	58.5	O					
<b>SUPER NOVA</b>																			
1.4 (55 kW)	1996.01-		MT	L		GDS11002	Drive Shaft		20	29.95	54	86	613						
	1996.01-		MT	R		GDS11003	Drive Shaft		20	23	54	86	734						
<b>DAEWOO</b>																			
1.5	1994-1995.10	AT	L			GDS12023	Drive Shaft		22	34	52	95.5	510						
	1994-1995.10	AT	R			GDS12024	Drive Shaft		22	34	52	95.5	628						
<b>CIELO</b>																			
-				L		GDS12007	Drive Shaft		22	34	52	95	576						
				R		GDS12008	Drive Shaft		22	34	52	95	909						
	1.5	1995.01-1998.04	AT	L		GL 4 Speed	GDS12017	Drive Shaft		22	34	52	95.5	473					
		1995.01-1998.04	AT	R			GDS12018	Drive Shaft		22	34	52	95.5	490					
		1995.01-1998.04	AT				GC012013	Outer Joint		22	22	52	96	56	I				
		1995.01-1998.04	AT			GL 4 Speed	GCI12002	Inner Joint		34	29	34.6	47	80					
		1995.10-1998.04	AT	L			GDS12023	Drive Shaft		22	34	52	95.5	510					
1995.10-1998.04	AT	R			GDS12024	Drive Shaft		22	34	52	95.5	628							
1.5 (66 kW)	1994.06-1998.07			F	Saloon Engine V15L	GC012030	Outer Joint		22	22	52	96	54	I					
<b>CIELO RACER (ETI)</b>																			
1.5	1992.01-		MT/AT		Engine GTI	GC012004	Outer Joint		22	29	52	95.5	57	O					



		TRANSM	L/R	F/R		G-AP Ref.	PRODUCT	ABS	Technical Specifications									
									YEAR	A	B	C	H	L	P			
<b>DAEWOO</b>																		
<b>CIELO RACER (GL)</b>																		
1.6	1992.01-		MT/AT		Engine GLE	GC012004	Outer Joint		22	29	52	95.5	57	O				
<b>CIELO RACER (GS)</b>																		
1.5	1992.01-		MT/AT		Engine VAN	GC012004	Outer Joint		22	29	52	95.5	57	O				
<b>ESPERO</b>																		
-						GCI12003	Inner Joint		34	29	35	56.5	119					
2.0	1995.01-		MT/AT			GC012018	Outer Joint		33	29	52	95.5	62.5	O				
	1995.04-1997		MT/AT			GCI88002	Inner Joint		34	29	35	56	125					
	1995.04-1997		MT/AT	R		GDS12006	Drive Shaft		33	34	52	109	930					
<b>ESPERO (KLEJ)</b>																		
1.5 16V (66 kW)	1995.02-	1999.06			F Saloon Engine A15MF	GC012008	Outer Joint	47T	33	29	52	108.5	63	O				
1.8 (66 kW)	1995.02-	1999.09	MT		F Saloon Engine C18LE	GC012008	Outer Joint	47T	33	29	52	108.5	63	O				
	1995.02-	1999.09			F Saloon Engine C18LE	GC012019	Outer Joint		22	29	52	95	62.5	O				
1.8 (70 kW)	1995.02-	1999.06	MT		F Saloon Engine C18LE	GC012008	Outer Joint	47T	33	29	52	108.5	63	O				
	1995.02-	1999.06			F Saloon Engine C18LE	GC012019	Outer Joint		22	29	52	95	62.5	O				
2.0 (77 kW)	1995.02-	1999.06	MT		F Saloon Engine C20LE	GC012008	Outer Joint	47T	33	29	52	108.5	63	O				
<b>EVANDA (KLAL)</b>																		
2.0 (96 kW)	2002.08-				F Saloon Engine L88/X20SED	GC014030	Outer Joint		28	32	55.5	99	61	O				
	2002.08-				F Saloon Engine L88/X20SED	GC012009	Outer Joint		33	29	52	109	63	O				
<b>KALOS</b>																		
1.2	2003.04-		MT/AT			GC044099	Outer Joint		22	19	52	95.5	53	O				
1.4	2003-			L		GDS88012	Drive Shaft	48T	22	22	52	95.5	602					
	2003-			R		GDS88013	Drive Shaft	48T	22	22	52	95.5	930					
<b>KALOS (KLAS)</b>																		
1.2 (53 kW)	2003.04-				F Hatchback Engine B12S1/F12S3	GC088034	Outer Joint	47T	22	19	52	95.5	53	O				
	2003.04-		MT	L	F Hatchback Engine B12S1/F12S3	GDS44071	Drive Shaft	47T	22	22	52	95.5	661					
	2003.04-		MT	R	F Hatchback Engine B12S1/F12S3	GDS44072	Drive Shaft	47T	22	22	52	95.5	880					
1.4 (61 kW)	2002.09-				F Hatchback Engine F14S3	GC088021	Outer Joint	47T	22	22	52	96.5	53.5	O				
	2002.09-		5MT	L	F Hatchback Engine F14S3	GDS88012	Drive Shaft	48T	22	22	52	95.5	602					
	2002.09-		5MT	R	F Hatchback Engine F14S3	GDS88013	Drive Shaft	48T	22	22	52	95.5	930					
	2002.09-				Hatchback Engine F14S3	GC012042	Outer Joint	47T	22	22	52	96.5	53.5	O				
	2002.11-2004.12			L/R	F Saloon Engine F14S3	GC088021	Outer Joint	47T	22	22	52	96.5	53.5	O				
	2002.11-2004.12				Saloon Engine F14S3	GC012042	Outer Joint	47T	22	22	52	96.5	53.5	O				
1.4 (69 kW)	2003.05-	2004.12		L/R	F Saloon Engine F14D3	GC088021	Outer Joint	47T	22	22	52	96.5	53.5	O				
	2003.05-	2004.12			Saloon Engine F14D3	GC012042	Outer Joint	47T	22	22	52	96.5	53.5	O				
1.4 16V (69 kW)	2003.04-				F Hatchback Engine F14D3	GC088021	Outer Joint	47T	22	22	52	96.5	53.5	O				
	2003.04-			L	F Hatchback Engine F14D3	GDS88012	Drive Shaft	48T	22	22	52	95.5	602					
	2003.04-			R	F Hatchback Engine F14D3	GDS88013	Drive Shaft	48T	22	22	52	95.5	930					
	2003.04-		AT	L	F Hatchback Engine F14D3	GDS12058	Drive Shaft	47T	22	34	52	96.5	611					
	2003.04-				Hatchback Engine F14D3	GC012042	Outer Joint	47T	22	22	52	96.5	53.5	O				
<b>LACETTI (KLAN)</b>																		
1.4 (70 kW)	2004.03-	2005.04			Hatchback Engine F14D3	GC012042	Outer Joint	47T	22	22	52	96.5	53.5	O				
1.6 (80 kW)	2004.03-	2005.04			Hatchback Engine F16D3	GC044086	Outer Joint	47T	33	22	52	96	56	O				
<b>LANOS</b>																		
-			AT	R		GDS12016	Drive Shaft		33	34	52	95.5	505					
1.5	1997.01-		MT		Engine H/B	GC012018	Outer Joint		33	29	52	95.5	62.5	O				
	1997.01-		MT		Engine H/B	GC012004	Outer Joint		22	29	52	95.5	57	O				
	1997.01-	2000.07	AT	L		GDS12017	Drive Shaft		22	34	52	95.5	473					
	1997.01-	2000.07	AT	R		GDS12018	Drive Shaft		22	34	52	95.5	490					
	1997.01-	2000.07	AT			GC012013	Outer Joint		22	22	52	96	56	I				
	1997.01-	2000.07	AT			GCI12002	Inner Joint		34	29	34.6	47	80					
<b>LANOS (KLAT)</b>																		
1.4 (55 kW)	1997.05-		5MT		F Hatchback Engine A14SMS	GC088002	Outer Joint	47T	22	29	52	95.5	63	O				
	1997.05-		5MT		F Saloon Engine A14SMS	GC088002	Outer Joint	47T	22	29	52	95.5	63	O				
	1997.05-		5MT		F Hatchback Engine A14SMS	GC012020	Outer Joint		22	29	52	95.5	63	O				
	1997.05-		5MT		F Saloon Engine A14SMS	GC012020	Outer Joint		22	29	52	95.5	63	O				
	2000-	2003				GCI99025	Inner Joint		34	22	35	80	58					
1.5 (63 kW)	1997.05-				F Hatchback Engine A15SMS	GC088002	Outer Joint	47T	22	29	52	95.5	63	O				
	1997.05-				F Saloon Engine A15SMS	GC088002	Outer Joint	47T	22	29	52	95.5	63	O				
	1997.05-				F Hatchback Engine A15SMS	GC012020	Outer Joint		22	29	52	95.5	63	O				
	1997.05-				F Saloon Engine A15SMS	GC012020	Outer Joint		22	29	52	95.5	63	O				
1.6 16V (78 kW)	1997.05-				F Hatchback Engine A16DMS	GC012027	Outer Joint	47T	33	29	52	95.5	63	O				
	1997.05-				F Saloon Engine A16DMS	GC012027	Outer Joint	47T	33	29	52	95.5	63	O				

		TRANSM	L/R	F/R		G-AP Ref.	PRODUCT	ABS	Technical Specifications									
									YEAR	A	B	C	H	L	P			
<b>DAEWOO LEGANZA</b>																		
-	1997-2001					GCI12006	Inner Joint		24	29	40	95.5	146					
	1998.02-					GC012024	Outer Joint	47T	33	23	52	96	64	I				
2.2	1999-2001	AT	R			GDS88019	Drive Shaft	47T	33	34	52	95.5	971					
<b>LEGANZA (KLAV)</b>																		
2.0 16V (93 kW)	2000.03-2002.11			F	Saloon Engine T20SED	GC012009	Outer Joint		33	29	52	109	63	O				
2.0 16V (98 kW)	1997.06-2002.12			F	Saloon Engine X20SED	GC012009	Outer Joint		33	29	52	109	63	O				
2.2 16V (100 kW)	1999.04-2002.12			F	Saloon Engine T22SED	GC012009	Outer Joint		33	29	52	109	63	O				
<b>MATIZ (KLYA)</b>																		
0.8 (38 kW)	1998-					GCI12001	Inner Joint		22	19	35	54.5	79					
	1998.09-	MT	L	F	Hatchback Engine F8CV	GDS12011	Drive Shaft		23	22	46	92	616					
	1998.09-	MT	R	F	Hatchback Engine F8CV	GDS88059	Drive Shaft		23	22	46	92	785					
	1998.09-		R	F	Hatchback Engine F8CV	GDS12044	Drive Shaft	40T	23	22	46	92	786					
	1998.09-	MT		F	Hatchback Engine F8CV	GC012028	Outer Joint		23	19	46	92	56.5	O				
	1998.09-	MT		F	Hatchback Engine F8CV	GC012031	Outer Joint		23	19	44	89.5	54.5	O				
1.0 (47 kW)	2003.01-	MT		F	Hatchback Engine B10S	GC012021	Outer Joint	40T	23	19	46	92	56.5	O				
	2003.01-	MT	L	F	Hatchback Engine B10S	GDS57177	Drive Shaft	40T	23	22	46	92	562					
	2003.01-	MT	R	F	Hatchback Engine B10S	GDS57176	Drive Shaft	40T	23	22	46	92	831					
	2003.01-				Hatchback Engine B10S	GC012046	Outer Joint	40T	23	19	46	92	56.5	O				
<b>NEXIA</b>																		
1.5	1996.01-	AT			Engine - GLE/GL	GC012004	Outer Joint		22	29	52	95.5	57	O				
<b>NEXIA (KLETN)</b>																		
1.5 (44 kW)	1996.08-1997.08	MT		F	Hatchback Engine G15MF	GC012019	Outer Joint		22	29	52	95	62.5	O				
	1996.08-1997.08	MT		F	Saloon Engine G15MF	GC012019	Outer Joint		22	29	52	95	62.5	O				
1.5 (52 kW)	1995.02-1997.08	MT		F	Hatchback Engine G15MF	GC012019	Outer Joint		22	29	52	95	62.5	O				
	1995.02-1997.08	MT		F	Saloon Engine G15MF	GC012019	Outer Joint		22	29	52	95	62.5	O				
1.5 (55 kW)	1995.02-1997.08	MT		F	Hatchback Engine G15MF	GC012019	Outer Joint		22	29	52	95	62.5	O				
	1995.02-1997.08	MT		F	Saloon Engine G15MF	GC012019	Outer Joint		22	29	52	95	62.5	O				
1.5 16V (66 kW)	1995.02-1997.08	MT		F	Hatchback Engine A15MF	GC012019	Outer Joint		22	29	52	95	62.5	O				
	1995.02-1997.08	MT		F	Saloon Engine A15MF	GC012019	Outer Joint		22	29	52	95	62.5	O				
<b>NUBIRA</b>																		
-						GC099057	Outer Joint		33	22	52	109	56	I				
						GC012022	Outer Joint	47T	33	22	52	96	56	I				
	1998-2002	AT				GCI12005	Inner Joint		34	24	36.7	39	90					
	2000-2002	AT	L/R			GDS12013	Drive Shaft		33	34	52	95.5	519					
2.0	1998.01-2002.12	AT				GC012015	Outer Joint		33	32	52	95.5	66	O				
	1998.01-2002.12	MT				GC012015	Outer Joint		33	32	52	95.5	66	O				
<b>NUBIRA (KLAJ)</b>																		
1.6 16V (76 kW)	1999.07-2002.11			F	Saloon Engine A16DMS	GC012001	Outer Joint		33	29	52	95.5	63	O				
	1999.07-2002.11			F	Saloon Engine A16DMS	GC012009	Outer Joint		33	29	52	109	63	O				
1.6 16V (78 kW)	1997.05-			F	Hatchback Engine A16DMS	GC012027	Outer Joint	47T	33	29	52	95.5	63	O				
	1997.05-			F	Saloon Engine A16DMS	GC012027	Outer Joint	47T	33	29	52	95.5	63	O				
2.0 16V (98 kW)	1997.05-			F	Hatchback Engine X20SED	GC012027	Outer Joint	47T	33	29	52	95.5	63	O				
	1997.05-			F	Saloon Engine X20SED	GC012027	Outer Joint	47T	33	29	52	95.5	63	O				
<b>NUBIRA (KLAN)</b>																		
1.6 (80 kW)	2003.07-				Saloon Engine F16D3	GC012014	Outer Joint		33	22	52	96	56	I				
	2003.07-				Saloon Engine F16D3	GC012022	Outer Joint	47T	33	22	52	96	56	I				
1.8 (90 kW)	2003.07-			F	Saloon Engine T18SED	GC088019	Outer Joint	47T	33	22	52	95.5	53	O				
	2003.07-				Saloon Engine T18SED	GC012014	Outer Joint		33	22	52	96	56	I				
	2003.07-				Saloon Engine T18SED	GC012022	Outer Joint	47T	33	22	52	96	56	I				
<b>NUBIRA OPTRA LACETTI</b>																		
2.0	2000.01-	MT/AT				GC012018	Outer Joint		33	29	52	95.5	62.5	O				
<b>NUBIRA WAGON (KLAJ)</b>																		
1.6 16V (76 kW)	1999.07-2002.11			F	Estate Engine A16DMS	GC012009	Outer Joint		33	29	52	109	63	O				
1.6 16V (78 kW)	1997.05-			F	Estate Engine A16DMS	GC012027	Outer Joint	47T	33	29	52	95.5	63	O				
2.0 16V (98 kW)	1997.05-			F	Estate Engine X20SED	GC012027	Outer Joint	47T	33	29	52	95.5	63	O				
<b>NUBIRA WAGON (KLAN)</b>																		
1.6 (80 kW)	2003.07-				Estate Engine F16D3	GC012014	Outer Joint		33	22	52	96	56	I				
	2003.07-				Estate Engine F16D3	GC012022	Outer Joint	47T	33	22	52	96	56	I				
1.8 (90 kW)	2003.07-			F	Estate Engine T18SED	GC088019	Outer Joint	47T	33	22	52	95.5	53	O				
	2003.07-				Estate Engine T18SED	GC012014	Outer Joint		33	22	52	96	56	I				
	2003.07-				Estate Engine T18SED	GC012022	Outer Joint	47T	33	22	52	96	56	I				









	 YEAR	TRANSM	L/R	F/R		G-AP Ref.	PRODUCT	ABS	Technical Specifications									
									A	B	C	H	L	P				
<b>DAEWOO RACER</b>																		
-						GCI44006	Inner Joint		34	22	35	80	58					
				L		GDS12003	Drive Shaft		22	34	52	95	573					
				R		GDS12004	Drive Shaft		22	34	52	95	906					
<b>RACER / CIELO</b>																		
-						GC044029	Outer Joint		22	30	52	95.5	57.5	O				
						GCI99028	Inner Joint		34	22	35	79.5	58	O				
<b>TACUMA (KLAU)</b>																		
1.8 (72 kW)	2000.09-		MT	F	MPV Engine A18DMS	GC012027	Outer Joint	47T	33	29	52	95.5	63	O				
1.8 (74 kW)	2000.09-		MT	F	F18S2 Engine F18S2	GC012027	Outer Joint	47T	33	29	52	95.5	63	O				
2.0 (89 kW)	2001.09-		MT	F	MPV Engine X20SED	GC012023	Outer Joint	47T	33	32	52	95.5	66	O				
<b>TICO</b>																		
0.8	1993-			L		GDS12009	Drive Shaft		23	22	44	92	564					
	1993-			R		GDS12010	Drive Shaft		23	22	44	92	748					
	1993-					GCI12001	Inner Joint		22	19	35	54.5	79					
<b>TICO (KLY3)</b>																		
0.8 (35 kW)	1995.02-	2000.12		F	Hatchback Engine F8C	GC012006	Outer Joint		23	19	44	92	56.5	O				
	1995.02-	2000.12		F	Hatchback Engine F8C	GC012031	Outer Joint		23	19	44	89.5	54.5	O				
0.8 (38 kW)	1996.01-	2000.12		F	Hatchback Engine F8CV	GC012031	Outer Joint		23	19	44	89.5	54.5	O				
<b>WINSTORM</b>																		
-	2007-					GC021047	Outer Joint		30	22		105.5	53.5	O				
	2007-					GCI88034	Inner Joint		27	34	35	68.5	111.5					
	2007-					GCI12009	Inner Joint		34	22	35	80.5	58					
<b>DAIHATSU</b>																		
-																		
1.0						GCI14009	Inner Joint		23	26	45	52	88.5					
<b>7100</b>																		
-						GCI14001	Inner Joint		23	19	45	52	82					
<b>APPLAUSE</b>																		
-	1989.10-	1997.09	AT	R		GDS14015	Drive Shaft		24	23	54	92	883.5					
	1989.10-	1997.09	AT	L		GDS14016	Drive Shaft		24	23	54	92	636.5					
	1989.10-	1997.09	MT			GCI14007	Inner Joint		25	22	45	52	102					
<b>APPLAUSE (A101, A111)</b>																		
1.6 16V (66 kW)	1989.06-	1997.07		R	F	Saloon Engine HD	GDS14020	Drive Shaft	24	25	54	92	902					
	1989.06-	1997.07		L	F	Saloon Engine HD	GDS14019	Drive Shaft	24	25	54	92	620					
	1989.06-	1997.07	MT/AT		F	Saloon Engine HD	GC014006	Outer Joint	24	22	54	92	53	M				
1.6 16V (77 kW)	1989.06-	1997.07		R	F	Saloon Engine HD-E	GDS14020	Drive Shaft	24	25	54	92	902					
	1989.06-	1997.07		L	F	Saloon Engine HD-E	GDS14019	Drive Shaft	24	25	54	92	620					
	1989.06-	1997.07	MT/AT		F	Saloon Engine HD-E	GC014006	Outer Joint	24	22	54	92	53	M				
1.6 16V 4WD (77 kW)	1989.06-	1997.07		R	F	Saloon Engine HD-E	GDS14020	Drive Shaft	24	25	54	92	902					
	1989.06-	1997.07		L	F	Saloon Engine HD-E	GDS14019	Drive Shaft	24	25	54	92	620					
	1989.06-	1997.07	MT/AT			Saloon Engine HD-E	GC014006	Outer Joint	24	22	54	92	53	M				
<b>BE-GO (J210G)</b>																		
1.5 4WD	2006.01-		4AT/I		Engine 3SZ-VE	GC099290	Outer Joint		24	22	52	89.8	81	M				
	2006.01-		5MT/F		Engine 3SZ-VE	GC099290	Outer Joint		24	22	52	89.8	81	M				
<b>BOON (M300S)</b>																		
1.0	2004.05-		4AT/C		Engine 1KR-FE	GC059268	Outer Joint		24	26	47	85.5	47.5	I				
<b>BOON (M301S)</b>																		
1.3	2004.05-		4AT/C		Engine K3-VE	GC059266	Outer Joint		24	29	47	85.5	51	I				
<b>BOON (M310S)</b>																		
1.0 4WD	2004.05-		4AT/C		Engine 1KR-FE	GC059268	Outer Joint		24	26	47	85.5	47.5	I				
<b>CHARADE</b>																		
-						GCI14001	Inner Joint		23	19	45	52	82					
<b>CHARADE (G10)</b>																		
1.0 (37 kW)	1977.10-	1981.02		F	Hatchback Engine CB20	GC014007	Outer Joint		24	19	40	114	49	M				
1.0 (38 kW)	1981.02-	1983.02		F	Hatchback Engine CB20/CB22	GC014007	Outer Joint		24	19	40	114	49	M				
<b>CHARADE (G100)</b>																		
-	1989.01-	1993.06		R		GDS14014	Drive Shaft		24	23	54	92	834					
	1989.01-	1993.06		L		GDS14013	Drive Shaft		24	23	54	92	638					
	1989.01-	1993.06	AT	R		GDS14012	Drive Shaft		24	23	54	92	866					
<b>CHARADE (G102)</b>																		
-	1988.10-	1993.07	MT	L		GDS14009	Drive Shaft		24	23	54	92	602					



		YEAR	TRANSM	L/R	F/R		G-AP Ref.	PRODUCT	ABS	Technical Specifications									
										A	B	C	H	L	P				
<b>DAIHATSU CHARADE (G102)</b>																			
-	1988.10-	1993.07	AT	L			GDS14007	Drive Shaft			24	23	54	92	570				
	1989.01-	1993.06	MT	L			GDS14031	Drive Shaft			24	25	54	92	601				
	1989.01-	1993.06	MT	R			GDS14032	Drive Shaft			24	25	54	92	881				
<b>CHARADE (G102S)</b>																			
1.3	1988.01-	1989.01	MT&AT			Engine HC/HC-E	GC014016	Outer Joint			24	21	46	86.5	54.5	M			
<b>CHARADE (G200)</b>																			
-	1993.01-	1996.04					GC014019	Outer Joint			24	20	52	92	47.5	M			
	1993.01-	1996.04	AT	L			GDS14017	Drive Shaft			24	22	54	92	588				
	1993.01-	1996.04	AT	R			GDS14018	Drive Shaft			24	22	54	92	897				
1.3	1993.06-	1996.04	MT	L			GDS14009	Drive Shaft			24	23	54	92	602				
<b>CHARADE (G200S)</b>																			
1.3	1993.01-	2000.05	4AT			Engine HC-E	GC041323	Outer Joint			24	22	52	92	53	M			
<b>CHARADE (G201S)</b>																			
1.6	1993.07-	2000.05	4AT			Engine HD-EG	GC041323	Outer Joint			24	22	52	92	53	M			
	1993.08-	2000.05	4AT			Engine HD-EG	GC041323	Outer Joint			24	22	52	92	53	M			
	1993.08-	2000.05	5MT			Engine HD-EG	GC041323	Outer Joint			24	22	52	92	53	M			
<b>CHARADE (G202)</b>																			
1.0	1993.06-	1996.04			R		GDS14014	Drive Shaft			24	23	54	92	834				
	1993.06-	1996.04			L		GDS14013	Drive Shaft			24	23	54	92	638				
<b>CHARADE (G203)</b>																			
-	1996.05-	1998.04	MT	L			GDS14031	Drive Shaft			24	25	54	92	601				
	1996.05-	1998.04	MT	R			GDS14032	Drive Shaft			24	25	54	92	881				
<b>CHARADE (G203S)</b>																			
1.5	1993.08-	2005.05	4AT			Engine HE-EG	GC014096	Outer Joint			24	19	52	93	53	M			
	1993.07-	2000.05	4AT			Engine HE-EG	GC041323	Outer Joint			24	22	52	92	53	M			
	1993.08-	2000.05	4AT			Engine HE-EG	GC041323	Outer Joint			24	22	52	92	53	M			
	1993.08-	2000.05	5MT			Engine HE-EG	GC041323	Outer Joint			24	22	52	92	53	M			
<b>CHARADE (G213S)</b>																			
1.5 4WD	1993.08-	2000.05	5MT			Engine HE-EG	GC041323	Outer Joint			24	22	52	92	53	M			
	1993.08-	2000.05	4AT			Engine HE-EG	GC041323	Outer Joint			24	22	52	92	53	M			
<b>CHARADE (L2 )</b>																			
1.0 (43 kW)	2003.03-	2006.06	MT	L	F	Hatchback Engine EJ-VE	GDS14035	Drive Shaft			24	23	47	84.5	581				
	2003.03-	2006.06	MT	R	F	Hatchback Engine EJ-VE	GDS14036	Drive Shaft			24	23	47	84.5	794				
<b>CHARADE II (G11, G30)</b>																			
1.0 (38 kW)	1983.10-	1987.03	MT/AT		F	Hatchback Engine CB22/CB20	GC014003	Outer Joint			24	19	40	116.5	50	M			
1.0 D (27 kW)	1983.10-	1987.03	MT/AT		F	Hatchback Engine CL10	GC014003	Outer Joint			24	19	40	116.5	50	M			
1.0 TD (34 kW)	1985.02-	1987.03	MT/AT		F	Hatchback Engine CL60	GC014003	Outer Joint			24	19	40	116.5	50	M			
1.0 Turbo (50 kW)	1983.10-	1987.03	MT/AT		F	Hatchback Engine CB60	GC014003	Outer Joint			24	19	40	116.5	50	M			
<b>CHARADE III (G100, G101, G102)</b>																			
1.0 (38 kW)	1987.03-	1992.12	MT/AT		F	Hatchback Engine CB23	GC014012	Outer Joint			24	19	46	86.5	53.5	M			
	1987.03-	1992.12	MT/AT		F	Hatchback Engine CB23	GC014005	Outer Joint			24	19	54	92	47.5	M			
1.0 (40 kW)	1990.11-	1992.12	MT/AT		F	Hatchback Engine CB90	GC014005	Outer Joint			24	19	54	92	47.5	M			
1.0 (41 kW)	1989.04-	1992.12	MT/AT		F	Hatchback Engine CB90	GC014005	Outer Joint			24	19	54	92	47.5	M			
1.0 D (27 kW)	1987.03-	1992.12	MT/AT		F	Hatchback Engine CL11	GC014012	Outer Joint			24	19	46	86.5	53.5	M			
1.0 TD (35 kW)	1987.03-	1992.12	MT/AT		F	Hatchback Engine CL/CL61	GC014012	Outer Joint			24	19	46	86.5	53.5	M			
	1987.03-	1992.12	MT/AT		F	Hatchback Engine CL/CL61	GC014005	Outer Joint			24	19	54	92	47.5	M			
1.0 Turbo (50 kW)	1987.03-	1990.10	MT/AT		F	Hatchback Engine CB61	GC014012	Outer Joint			24	19	46	86.5	53.5	M			
1.3 i (66 kW)	1988.06-	1992.12	MT/AT		F	Hatchback Engine HCE	GC014012	Outer Joint			24	19	46	86.5	53.5	M			
	1988.06-	1992.12	MT/AT		F	Hatchback Engine HCE	GC014005	Outer Joint			24	19	54	92	47.5	M			
	1988.06-	1992.12			F	Hatchback Engine HCE	GC014014	Outer Joint			24	21	54	92	47.5	M			
	1988.06-	1992.12	MT/AT		F	Hatchback Engine HCE	GC014013	Outer Joint			24	21	54	92	50	M			
1.3 i 4WD (66 kW)	1988.06-	1993.01	MT/AT		F	Hatchback Engine HCE	GC014012	Outer Joint			24	19	46	86.5	53.5	M			
<b>CHARADE III (G102)</b>																			
1.3 (66 kW)	1990.11-	1993.02			F	Saloon Engine HCE	GC014014	Outer Joint			24	21	54	92	47.5	M			
<b>CHARADE IV (G200, G202)</b>																			
1.3 (44 kW)	1996.09-	1999.11	MT/AT		F	Hatchback Engine HC	GC014046	Outer Joint			24	22	52	93	53	I			
	1996.09-	1999.11	AT		F	Hatchback Engine HC	GC014033	Outer Joint	48T		24	22	52	93	53	I			
	1996.09-	1999.11	MT/AT		F	Hatchback Engine HC	GC014033	Outer Joint	48T		24	22	52	93	53	I			
	1996.09-	1999.11			F	Hatchback Engine HC	GC014001	Outer Joint	48T		24	22	52	93	54	I			
	1996.09-	1999.11	MT		F	Hatchback Engine HC	GC014073	Outer Joint	48T		24	21	52	93	53	M			
1.3 16V (55 kW)	1996.05-	1999.11	MT/AT		F	Hatchback Engine HCE	GC014046	Outer Joint			24	22	52	93	53	I			
	1996.05-	1999.11	AT		F	Hatchback Engine HCE	GC014033	Outer Joint	48T		24	22	52	93	53	I			

		TRANSM	L/R	F/R		G-AP Ref.	PRODUCT	ABS	Technical Specifications								
									YEAR	A	B	C	H	L	P		
<b>DAIHATSU</b>																	
<b>CHARADE IV (G200, G202)</b>																	
1.3 16V (55 kW)	1996.05-	1999.11	MT/AT		F	Hatchback Engine HCE	GC014033	Outer Joint	48T	24	22	52	93	53	I		
	1996.05-	1999.11			F	Hatchback Engine HCE	GC014001	Outer Joint	48T	24	22	52	93	54	I		
	1996.05-	1999.11	MT		F	Hatchback Engine HCE	GC014073	Outer Joint	48T	24	21	52	93	53	M		
1.3 i 16V (62 kW)	1993.01-	2000.09	MT/AT		F	Hatchback Engine HC/HCE	GC014046	Outer Joint		24	22	52	93	53	I		
	1993.01-	2000.09	AT		F	Hatchback Engine HC/HCE	GC014033	Outer Joint	48T	24	22	52	93	53	I		
	1993.01-	2000.09			F	Hatchback Engine HC/HCE	GC014001	Outer Joint	48T	24	22	52	93	54	I		
	1993.01-	2000.09	MT/AT		F	Hatchback Engine HC/HCE	GC014033	Outer Joint	48T	24	22	52	93	53	I		
	1993.01-	2000.09	MT		F	Hatchback Engine HC/HCE	GC014073	Outer Joint	48T	24	21	52	93	53	M		
1.5 i 16V (66 kW)	1997.01-	1999.11	MT/AT		F	Hatchback Engine HEE	GC014046	Outer Joint		24	22	52	93	53	I		
	1997.01-	1999.11			F	Hatchback Engine HEE	GC014001	Outer Joint	48T	24	22	52	93	54	I		
	1997.01-	1999.11	MT/AT		F	Hatchback Engine HEE	GC014033	Outer Joint	48T	24	22	52	93	53	I		
1.6 GTi (77 kW)	1993.03-	1999.11	MT/AT		F	Hatchback Engine HD-E	GC014046	Outer Joint		24	22	52	93	53	I		
	1993.03-	1999.11			F	Hatchback Engine HD-E	GC014001	Outer Joint	48T	24	22	52	93	54	I		
	1993.03-	1999.11	MT/AT		F	Hatchback Engine HD-E	GC014033	Outer Joint	48T	24	22	52	93	53	I		
<b>CHARADE IV (G203)</b>																	
1.5 16V (55 kW)	1994.10-		MT/AT		F	Saloon Engine HEE	GC014046	Outer Joint		24	22	52	93	53	I		
	1994.10-				F	Saloon Engine HEE	GC014001	Outer Joint	48T	24	22	52	93	54	I		
	1994.10-		MT/AT		F	Saloon Engine HEE	GC014033	Outer Joint	48T	24	22	52	93	53	I		
1.5 i 16V (66 kW)	1994.08-		MT/AT		F	Saloon Engine HEE	GC014046	Outer Joint		24	22	52	93	53	I		
	1994.08-				F	Saloon Engine HEE	GC014001	Outer Joint	48T	24	22	52	93	54	I		
	1994.08-		MT/AT		F	Saloon Engine HEE	GC014033	Outer Joint	48T	24	22	52	93	53	I		
<b>CUORE</b>																	
-	2000.01-	2001.12	MT/AT	L			GDS14006	Drive Shaft		24	23	47	93	584.4			
	2000.01-	2001.12	MT/AT	R			GDS14005	Drive Shaft		24	23	47	93	802			
	2000.01-	2001.12	MT/AT	R			GCI14005	Inner Joint		23	20	45	52	88.5			
	2000.01-	2001.12	MT/AT	R			GC014024	Outer Joint		24	20	47	93	47	I		
0.6	2003.05-		MT/AT			Engine EJ-VE	GC014078	Outer Joint		24	19	47	85.5	47.5	M		
<b>CUORE (M401)</b>																	
0.6	2006.01-		MT/AT			Engine K3-VE	GC014098	Outer Joint		24	29	47	85.5	47.5	M		
<b>CUORE IV (L501)</b>																	
0.8 (32 kW)	1995.01-	1996.11	MT/AT		F	Hatchback Engine ED20	GC012034	Outer Joint		24	20	44	113.5	48.5	I		
<b>CUORE VI (L7_)</b>																	
1.0 i (41 kW)	1998.10-	2003.05			F	Hatchback Engine EJ-DE	GC014062	Outer Joint		24	20	47	86.5	48	M		
	1998.10-	2003.05			F	Hatchback Engine EJ-DE	GC014040	Outer Joint		24	18	47	85.5	45.5	I		
<b>CUORE VII (L251)</b>																	
1.0 (43 kW)	2003.05-				F	Hatchback Engine EJ-VE	GC014008	Outer Joint		24	20	44	111.5	48.5	M		
<b>FEROZA</b>																	
1.3	1990.01-		5MT			Engine HD	GC014017	Outer Joint		24	22	42	155	63	I		
<b>FOURTRAK (F7, F8)</b>																	
2.0 (65 kW)	1985.02-	1993.04			F	Closed Off-Road Vehicle Engine 3Y	GC014004	Outer Joint		26	23	42	165.5	56	I		
	1985.02-	1993.04			F	Open Off-Road Vehicle Engine 3Y	GC014004	Outer Joint		26	23	42	165.5	56	I		
	1985.02-	1993.04				Closed Off-Road Vehicle Engine 3Y	GC014004	Outer Joint		26	23	42	165.5	56	I		
	1985.02-	1993.04				Open Off-Road Vehicle Engine 3Y	GC014004	Outer Joint		26	23	42	165.5	56	I		
2.8 D (54 kW)	1985.02-	1998.12			F	Closed Off-Road Vehicle Engine DL	GC014004	Outer Joint		26	23	42	165.5	56	I		
	1985.02-	1998.12			F	Open Off-Road Vehicle Engine DL	GC014004	Outer Joint		26	23	42	165.5	56	I		
	1985.02-	1998.12				Closed Off-Road Vehicle Engine DL	GC014004	Outer Joint		26	23	42	165.5	56	I		
	1985.02-	1998.12				Open Off-Road Vehicle Engine DL	GC014004	Outer Joint		26	23	42	165.5	56	I		
2.8 TD (67 kW)	1987.12-	1993.04			F	Closed Off-Road Vehicle Engine DL51	GC014004	Outer Joint		26	23	42	165.5	56	I		
	1987.12-	1993.04			F	Open Off-Road Vehicle Engine DL51	GC014004	Outer Joint		26	23	42	165.5	56	I		
	1987.12-	1993.04				Closed Off-Road Vehicle Engine DL51	GC014004	Outer Joint		26	23	42	165.5	56	I		
	1987.12-	1993.04				Open Off-Road Vehicle Engine DL51	GC014004	Outer Joint		26	23	42	165.5	56	I		
2.8 TD (72 kW)	1993.05-	1998.12	MT/AT		F	Closed Off-Road Vehicle Engine DL52/DLT-C	GC014010	Outer Joint		26	26	61.95	161	65	M		
	1993.05-	1998.12				Closed Off-Road Vehicle Engine DL52/DLT-C	GC014004	Outer Joint		26	23	42	165.5	56	I		
2.8 TD (75 kW)	1991.09-	1998.12	MT		F	Closed Off-Road Vehicle Engine DL52	GC014010	Outer Joint		26	26	61.95	161	65	M		
	1991.09-	1998.12				Closed Off-Road Vehicle Engine DL52	GC014004	Outer Joint		26	23	42	165.5	56	I		
	1991.09-	1998.12	MT		F	Open Off-Road Vehicle Engine DL52	GC014010	Outer Joint		26	26	61.95	161	65	M		
	1991.09-	1998.12				Open Off-Road Vehicle Engine DL52	GC014004	Outer Joint		26	23	42	165.5	56	I		
<b>GRAN MOVE (G3)</b>																	
1.5 16V (66 kW)	1996.10-	1998.07			F	MPV Engine HEEG	GC014001	Outer Joint	48T	24	22	52	93	54	I		
1.6 16V (67 kW)	1998.05-				F	MPV Engine HDEP	GC014001	Outer Joint	48T	24	22	52	93	54	I		
<b>HANDIVAN</b>																	
-	1999.01-	2001.12	MT/AT	L			GDS14006	Drive Shaft		24	23	47	93	584.4			









		YEAR	TRANSM	L/R	F/R		G-AP Ref.	PRODUCT	ABS	Technical Specifications									
										A	B	C	H	L	P				
<b>DAIHATSU HANDIVAN</b>																			
-	1999.01-	2001.12	MT/AT	R			GDS14005	Drive Shaft			24	23	47	93	802				
	1999.01-	2001.12	MT/AT	R			GCI14005	Inner Joint			23	20	45	52	88.5				
	1999.01-	2001.12	MT/AT	R			GC014024	Outer Joint			24	20	47	93	47	I			
<b>HIJET</b>																			
-							GC014051	Outer Joint			24	18	44	115	49.5	M			
<b>HIJET (S210P)</b>																			
660	1999.01-		5MT			Engine EF-VE	GC014052	Outer Joint			24	18	47	85	47	M			
	1999.01-		MT/AT			Engine EF-VE	GC014052	Outer Joint			24	18	47	85	47	M			
660 4WD	1999.01-		MT/AT			Engine EF-VE	GC014052	Outer Joint			24	18	47	85	47	M			
<b>HIJET CARGO (S210V)</b>																			
660 4WD	1999.01-		5MT			Engine EF-SE	GC014052	Outer Joint			24	18	47	85	47	M			
	1999.01-		MT/AT			Engine EF-VE	GC014052	Outer Joint			24	18	47	85	47	M			
<b>LEEZA (L100)</b>																			
550	1986.11-	1990.07	2AT			Engine EB	GC014018	Outer Joint			24	19	44	111.5	48.5	M			
	1986.11-	1990.07	AT			Engine EB TBO	GC014018	Outer Joint			24	19	44	111.5	48.5	M			
	1987.08-	1990.07	MT			Engine EB	GC014018	Outer Joint			24	19	44	111.5	48.5	M			
<b>LEEZA (L111S)</b>																			
660	1990.08-	1992.07	MT/AT			Engine EF-HL	GC014018	Outer Joint			24	19	44	111.5	48.5	M			
	1991.01-	1992.07	MT/AT			Engine EF-JL TBO	GC014018	Outer Joint			24	19	44	111.5	48.5	M			
<b>MAIRA II (L80, L81)</b>																			
0.8 (29 kW)	1989.11-	1990.12	MT/AT		F	Hatchback Engine ED10	GC014020	Outer Joint			24	19	44	113.5	48.5	M			
0.8 (32 kW)	1985.09-	1990.06	MT/AT		F	Hatchback Engine ED10	GC014020	Outer Joint			24	19	44	113.5	48.5	M			
	1985.09-	1990.06			F	Hatchback Engine ED10	GC014036	Outer Joint			24	18	44	111.5	49.5	M			
0.8 4WD (32 kW)	1986.09-	1988.10				Hatchback Engine ED10	GC014036	Outer Joint			24	18	44	111.5	49.5	M			
<b>MAIRA III (L201)</b>																			
0.8 (30 kW)	1990.10-	1994.12	MT/AT		F	Hatchback Engine ED10K	GC012034	Outer Joint			24	20	44	113.5	48.5	I			
	1990.10-	1994.12			F	Hatchback Engine ED10K	GC014053	Outer Joint			24	20	44	112	49.5	I			
	1990.10-	1994.12			F	Hatchback Engine ED10K	GC014009	Outer Joint			24	20	44	113.5	48.5	M			
<b>MAX (L960S)</b>																			
660 4WD	2001.11-	2002.01	AT			Engine EF-DET	GC014061	Outer Joint			24	19	47	85.5	47	M			
	2001.11-	2002.01	MT/AT			Engine EF-VE	GC014061	Outer Joint			24	19	47	85.5	47	M			
<b>MAX (L962S)</b>																			
660 4WD	2001.11-	2002.01	AT			Engine JB-DET	GC014061	Outer Joint			24	19	47	85.5	47	M			
<b>MIRA</b>																			
0.9	1998-	2003			R		GDS14024	Drive Shaft			24	23	44	113.5	758.5				
660	1995-	2002			L		GCI14004	Inner Joint			23	20	39	49.7	82				
	1995-	2002			L		GDS14003	Drive Shaft			24	23	44	111.5	600				
	1995-	2002			R		GDS14004	Drive Shaft			24	23	44	111.5	746.5				
	1998.10-		MT/AT			EG CAR Model: L700S-L700V	GC014039	Outer Joint			24	18	47	85.5	45	M			
	1998.10-		MT/AT			EG CAR Model: L900S-L902S	GC014041	Outer Joint			24	24	47	85.5	45	I			
	1999.11-		MT/AT			EG CAR Model: L750S L950 L952	GC014042	Outer Joint			24	26	47	85.5	45	I			
<b>MIRA CUORE (L200S)</b>																			
660	1990.03-	1994.08	MT/AT			Engine EF-JL TBO	GC014018	Outer Joint			24	19	44	111.5	48.5	M			
	1990.03-	1995.01	MT/AT			Engine EF-HL	GC014018	Outer Joint			24	19	44	111.5	48.5	M			
	1991.08-	1994.08	MT/AT			Engine EF-EL	GC014018	Outer Joint			24	19	44	111.5	48.5	M			
	1992.08-	1994.08	MT/AT			Engine EF-KL	GC014018	Outer Joint			24	19	44	111.5	48.5	M			
<b>MIRA CUORE (L200V)</b>																			
660	1990.03-	1994.08	MT/AT			Engine EF-XL TBO	GC014018	Outer Joint			24	19	44	111.5	48.5	M			
<b>MIRA CUORE (L210S)</b>																			
660 4WD	1990.03-	1994.08	MT			Engine EF-HL	GC014018	Outer Joint			24	19	44	111.5	48.5	M			
	1990.11-	1994.08	5MT			Engine EF-JL TBO	GC014018	Outer Joint			24	19	44	111.5	48.5	M			
	1991.09-	1994.08	4AT			Engine EF-JL TBO	GC014018	Outer Joint			24	19	44	111.5	48.5	M			
	1991.10-	1994.04	MT/AT			Engine EF-EL	GC014018	Outer Joint			24	19	44	111.5	48.5	M			
	1992.08-	1995.01	AT			Engine EF-EL	GC014018	Outer Joint			24	19	44	111.5	48.5	M			
<b>MIRA CUORE (L210V)</b>																			
660 4WD	1992.08-	1994.08	3AT			Engine EF-EL	GC014018	Outer Joint			24	19	44	111.5	48.5	M			
<b>MIRA CUORE (L220S)</b>																			
660 4WS	1990.04-	1993.07	MT/AT			Engine EF-JL TBO	GC014018	Outer Joint			24	19	44	111.5	48.5	M			
	1990.12-	1991.09	MT/AT			Engine EF-HL	GC014018	Outer Joint			24	19	44	111.5	48.5	M			
<b>MIRA CUORE (L500S V)</b>																			
660	1994.08-	1995.10	MT/AT			Engine EF-CL	GC014018	Outer Joint			24	19	44	111.5	48.5	M			



		TRANSM	L/R	F/R		G-AP Ref.	PRODUCT	ABS	Technical Specifications									
									YEAR	A	B	C	H	L	P			
<b>DAIHATSU MIRA CUORE (L500S)</b>																		
660	1994.08-	1998.10	3AT		Engine EF-EL/EF-KL	GC014018	Outer Joint		24	19	44	111.5	48.5	M				
	1994.08-	1998.10	MT/AT		Engine EF-EL/EF-JL TBO/EK-KL	GC014018	Outer Joint		24	19	44	111.5	48.5	M				
	1994.12-	1998.10	3AT		Engine EF-FL	GC014018	Outer Joint		24	19	44	111.5	48.5	M				
	1994.12-	1998.10	MT		Engine EF-FL	GC014018	Outer Joint		24	19	44	111.5	48.5	M				
<b>MIRA CUORE (L500V)</b>																		
660	1994.08-	1998.10	3AT		Engine EF-CL	GC014018	Outer Joint		24	19	44	111.5	48.5	M				
	1994.08-	1998.10	5MT		Engine EF-CL	GC014018	Outer Joint		24	19	44	111.5	48.5	M				
<b>MIRA CUORE (L502S)</b>																		
660	1994.08-	1998.10	MT/AT		Engine JB-EL TBO/JB-EL/JB-JL TBO	GC014018	Outer Joint		24	19	44	111.5	48.5	M				
<b>MIRA CUORE (L510S)</b>																		
660	1994.08-	1998.10	3AT		Engine 4WD EF-EL	GC014018	Outer Joint		24	19	44	111.5	48.5	M				
660 4WD	1994.08-	1995.10	3AT		Engine EF-EL	GC014018	Outer Joint		24	19	44	111.5	48.5	M				
	1995.10-	1997.05	AT		Engine EF-ZL	GC014018	Outer Joint		24	19	44	111.5	48.5	M				
	1995.10-	1997.05	MT		Engine EF-EL	GC014018	Outer Joint		24	19	44	111.5	48.5	M				
<b>MIRA CUORE (L510SV)</b>																		
660 4WD	1994.08-	1995.10	5MT		Engine EF-CL/EF-EL	GC014018	Outer Joint		24	19	44	111.5	48.5	M				
<b>MIRA CUORE (L512S)</b>																		
660 4WD	1994.08-	1998.10	5MT		Engine JB-JL TBO	GC014018	Outer Joint		24	19	44	111.5	48.5	M				
	1995.10-	1998.10	4AT		Engine JB-JL TBO	GC014018	Outer Joint		24	19	44	111.5	48.5	M				
<b>MIRA CUORE (L70S V)</b>																		
550	1985.08-	1990.02	2AT		Engine EB	GC014018	Outer Joint		24	19	44	111.5	48.5	M				
	1987.08-	1990.02	MT		Engine EB	GC014018	Outer Joint		24	19	44	111.5	48.5	M				
<b>MIRA CUORE (L70V)</b>																		
550	1985.08-	1990.02	AT		Engine EB TBO	GC014018	Outer Joint		24	19	44	111.5	48.5	M				
<b>MIRA CUORE (L80V)</b>																		
660	1986.01-	1993.01	MT/AT		Engine HANDY	GC014018	Outer Joint		24	19	44	111.5	48.5	M				
<b>MOVE</b>																		
-						GC014029	Outer Joint		24	19	47	84.5	47.5	I				
<b>MOVE (L6, L9)</b>																		
0.8 (31 kW)	1996.10-		MT/AT	F	MPV Engine ED20	GC014074	Outer Joint		24	18	44	111.5	48.5	M				
1.0 i (41 kW)	1998.10-		MT/AT	F	MPV Engine EJ-DE	GC014074	Outer Joint		24	18	44	111.5	48.5	M				
<b>MOVE (L600S)</b>																		
660	1995.08-	1998.10	MT/AT		Engine EF-GL/EF-RL TBO/EF-ZL	GC014018	Outer Joint		24	19	44	111.5	48.5	M				
<b>MOVE (L602S)</b>																		
660	1995.08-	1996.04	MT/AT		Engine JB-JL TBO	GC014018	Outer Joint		24	19	44	111.5	48.5	M				
<b>MOVE (L610S)</b>																		
660 4WD	1995.08-	1998.10	3AT		Engine EF-ZL	GC014018	Outer Joint		24	19	44	111.5	48.5	M				
	1995.08-	1998.10	5MT		Engine EF-ZL	GC014018	Outer Joint		24	19	44	111.5	48.5	M				
	1995.08-	1998.10	MT&AT		Engine EF-ZL	GC014018	Outer Joint		24	19	44	111.5	48.5	M				
	1996.04-	1998.10	AT		Engine EF-RL TBO	GC014018	Outer Joint		24	19	44	111.5	48.5	M				
	1996.04-	1998.10	MT/AT		Engine EF-RL TBO	GC014018	Outer Joint		24	19	44	111.5	48.5	M				
<b>MOVE (L910S)</b>																		
660 4WD	1998.10-	1999.11	MT/AT		Engine EF-DET/EF-VE	GC014052	Outer Joint		24	18	47	85	47	M				
<b>MOVE (L912S)</b>																		
660 4WD	2001.09-	2002.10	MT/AT		Engine JB-DET	GC014061	Outer Joint		24	19	47	85.5	47	M				
<b>MYVI (M301S)</b>																		
1.3	2004.05-		4AT/C		Engine K3-VE	GC059266	Outer Joint		24	29	47	85.5	51	I				
<b>MYVI (MS300S)</b>																		
1.0	2004.05-		4AT/C		Engine 1KR-FE	GC059268	Outer Joint		24	26	47	85.5	47.5	I				
<b>NEW G100</b>																		
-						GCI14001	Inner Joint		23	19	45	52	82					
<b>OPTI (L300S)</b>																		
660	1992.02-	1995.07	MT/AT		Engine EF-EL	GC014018	Outer Joint		24	19	44	111.5	48.5	M				
	1992.08-	1995.10	MT/AT		Engine EF-EL KL	GC014018	Outer Joint		24	19	44	111.5	48.5	M				
	1995.10-	1998.11	MT/AT		Engine EF-ZL KL	GC014018	Outer Joint		24	19	44	111.5	48.5	M				
<b>OPTI (L310S)</b>																		
660 4WD	1992.02-	1995.10	MT&AT		Engine EF-EL	GC014018	Outer Joint		24	19	44	111.5	48.5	M				
<b>OPTI (L800S)</b>																		
660	1998.11-	1999.07	MT/AT		Engine EF-SE /VE	GC014052	Outer Joint		24	18	47	85	47	M				
	1998.11-		MT/CVT		Engine EF-VE	GC014052	Outer Joint		24	18	47	85	47	M				

		YEAR	TRANSM	L/R	F/R		G-AP Ref.	PRODUCT	ABS	Technical Specifications										
										A	B	C	H	L	P					
<b>DAIHATSU</b>																				
<b>PYZAR</b>																				
-	1997-	2001.01	MT	L			GDS14031	Drive Shaft			24	25	54	92	601					
	1997-	2001.01	MT	R			GDS14032	Drive Shaft			24	25	54	92	881					
<b>PYZAR GRANMOVE (G301G)</b>																				
1.6	1996.08-	2002.07	4AT/F			Engine HD-EP	GC014072	Outer Joint	48T		24	22	52	92	53	M				
	1996.08-	2002.07	5MT/F			Engine HD-EP	GC014072	Outer Joint	48T		24	22	52	92	53	M				
<b>PYZAR GRANMOVE (G303G)</b>																				
1.5	1996.08-	2002.07	4AT/F			Engine HE-EG/HE-EP	GC014072	Outer Joint	48T		24	22	52	92	53	M				
	1996.08-	2002.07	5MT/F			Engine HE-EG	GC014072	Outer Joint	48T		24	22	52	92	53	M				
<b>ROCKY (F300)</b>																				
1.6 4WD	1990.07-	1997.05	MT			Engine HDE	GC014017	Outer Joint			24	22	42	155	63	I				
<b>SIRION</b>																				
-	1998-	2001		L			GDS18077	Drive Shaft			24	23	47	93	616					
	1998-	2001		R			GDS18078	Drive Shaft			24	23	47	93	833					
<b>SIRION (M1)</b>																				
1.0 i (43 kW)	2000.09-	2005.01	5MT		F	Hatchback Engine EJ-VE	GC014040	Outer Joint			24	18	47	85.5	45.5	I				
1.0 i 4WD (43 kW)	2000.09-	2005.01	5MT			Hatchback Engine EJ-VE	GC014040	Outer Joint			24	18	47	85.5	45.5	I				
1.3 Sport (75 kW)	2000.08-	2005.01	MT/AT		F	Hatchback Engine K3-VE2	GC014034	Outer Joint			24	21	46	86	53	M				
1.3 Sport 4WD (75 kW)	2000.08-	2005.03			F	Hatchback Engine K3-VE2	GC014034	Outer Joint			24	21	46	86	53	M				
<b>SIRION (M3_)</b>																				
1.0 (51 kW)	2005.02-	2007.12			F	Hatchback Engine 1KR-FE	GC014063	Outer Joint			24	26	47	85.5	45.5	I				
	2005.02-	2007.12			F	Hatchback Engine 1KR-FE	GC056010	Outer Joint	41T		23	19	49	78	57	M				
1.3 4WD (64 kW)	2005.04-					Hatchback Engine K3-VE	GC014063	Outer Joint			24	26	47	85.5	45.5	I				
	2005.04-				F	Hatchback Engine K3-VE	GC056010	Outer Joint	41T		23	19	49	78	57	M				
<b>SIRION II (M3)</b>																				
1.3 (64 kW)	2005.01-						GC014055	Outer Joint			24	29	47	85.5	51	I				
1.3 (67 kW)	2008.03-						GC014055	Outer Joint			24	29	47	85.5	51	I				
1.3 4WD (64 kW)	2005.04-						GC014055	Outer Joint			24	29	47	85.5	51	I				
1.3 4WD (67 kW)	2008.03-						GC014055	Outer Joint			24	29	47	85.5	51	I				
1.5 (76 kW)	2008.03-						GC014055	Outer Joint			24	29	47	85.5	51	I				
<b>SPORTRAK (F300)</b>																				
1.6 16V (63 kW)	1988.10-	1999.12			F	Closed Off-Road Vehicle Engine HDC	GC014001	Outer Joint	48T		24	22	52	93	54	I				
	1988.10-	1999.12			F	Open Off-Road Vehicle Engine HDC	GC014001	Outer Joint	48T		24	22	52	93	54	I				
1.6 i 16V (70 kW)	1988.10-	1999.12			F	Closed Off-Road Vehicle Engine HD-E	GC014001	Outer Joint	48T		24	22	52	93	54	I				
	1988.10-	1999.12			F	Open Off-Road Vehicle Engine HD-E	GC014001	Outer Joint	48T		24	22	52	93	54	I				
<b>TAFT</b>																				
2.8 D 4x4 (51 kW)	1982.08-	1985.02				Closed Off-Road Vehicle Engine DL	GC014004	Outer Joint			26	23	42	165.5	56	I				
<b>TERIOS</b>																				
-				L			GDS14029	Drive Shaft	48T		24	23	52	94	539					
	1997-	2000		L	4WD		GCI14008	Inner Joint			23	19	35	55.5	86					
	1997-	2000		L	4WD		GDS14021	Drive Shaft			24	23	52	94	540.5					
	1997-	2000		R	4WD		GDS14022	Drive Shaft			24	23	52	94	849.5					
<b>TERIOS (J1)</b>																				
1.3 4WD (61 kW)	1997.10-	2000.10	MT/AT		F	Closed Off-Road Vehicle Engine HE-EJ	GC014027	Outer Joint			24	19	52	94	81.5	I				
	1997.10-	2000.10	MT/AT		F	Closed Off-Road Vehicle Engine HE-EJ	GC014002	Outer Joint	48T		24	19	52	94	81.5	I				
<b>TERIOS (J100)</b>																				
1.3	1997.03-		MT/AT			Engine HC-EJ	GC014011	Outer Joint			24	19	52	94	81.5	M				
	1997.03-		MT/AT			Engine HC-EJ	GC014037	Outer Joint	48T		24	19	52	94	81.5	M				
<b>TERIOS KID (J111G)</b>																				
660 4WD	1998.10-		MT/AT			Engine EF-DEM/EF-DET	GC014011	Outer Joint			24	19	52	94	81.5	M				
<b>VIVA</b>																				
1.0							GC014043	Outer Joint			24	19	47	84.5	47.5	M				
<b>VIVA (L250)</b>																				
660	2007.05-		MT/AT			Engine EFVE	GC099299	Outer Joint			24	19	47	85.5	47.5	M				
<b>VIVA (L251)</b>																				
1.0	2007.05-		MT/AT			Engine EJVE	GC099299	Outer Joint			24	19	47	85.5	47.5	M				
<b>VIVA (L252)</b>																				
850	2007.05-		MT/AT			Engine EDVE	GC099299	Outer Joint			24	19	47	85.5	47.5	M				
<b>YRV (M201)</b>																				
1.3	2000.08-		4AT			Engine K3-VET TBO	GC014038	Outer Joint			24	21	47	85	47	M				
	2000.08-		MT/AT			Engine K3-VE	GC014077	Outer Joint			24	20	47	85.5	47	M				









		TRANSM	L/R	F/R		G-AP Ref.	PRODUCT	ABS	Technical Specifications									
									YEAR	A	B	C	H	L	P			
<b>DAIHATSU</b>																		
<b>YRV (M211)</b>																		
1.3 4WD	2000.08-		4AT		Engine K3-VET TBO	GC014038	Outer Joint		24	21	47	85	47	M				
	2000.08-		MT/AT		Engine K3-VE	GC014038	Outer Joint		24	21	47	85	47	M				
<b>DODGE</b>																		
<b>600</b>																		
-	1986-	1988			Saginaw	GC089010	Outer Joint		26	29	54	99.5	62.5	O				
<b>ARIES</b>																		
-	1986-	1989			Saginaw	GC089010	Outer Joint		26	29	54	99.5	62.5	O				
<b>AVENGER</b>																		
-	1995-	1999				GC039041	Outer Joint		25	25	54	95.5	65	M				
	1995-	1999				GC039078	Outer Joint	43T	25	25	54	95.5	63.5	I				
<b>CALIBER</b>																		
-	2007-	2010	MT/AT			GCI18167	Inner Joint		26	26	40	69	116.5					
<b>CALIBER (PM)</b>																		
1.8 i 16V DOHC	2006.04-		5MT	L	F	Hatchback Engine EBA	GDS15053	Drive Shaft		28	27	59.5	95	638				
	2006.04-		5MT	R	F	Hatchback Engine EBA	GDS15051	Drive Shaft		28	28	59.5	95	586				
2.0 D 16V DOHC	2006.04-		6MT	L	F	Hatchback Engine ECN	GDS15054	Drive Shaft		28	24	59.5	95	622				
	2006.04-		6MT	R	F	Hatchback Engine ECN	GDS15052	Drive Shaft		28	28	59.5	95	613				
2.0 i 16V DOHC	2006.04-		6MT/AT	L	F	Hatchback Engine ECN	GDS15053	Drive Shaft		28	27	59.5	95	638				
	2006.04-		6MT/AT	R	F	Hatchback Engine ECN	GDS15051	Drive Shaft		28	28	59.5	95	586				
<b>CARAVAN</b>																		
-	1991-	1995				GCI89026	Inner Joint		25	32	40	71	124					
	1996-	2004			SUV/Truck/VAN	GCI99059	Inner Joint		25	32	40	71.5	107					
	1996-	1997		L	Truck 2WD	GDS89004	Drive Shaft	47T	26	25	54	98.5	638					
	1996-	1997		L	Truck 4WD	GDS89004	Drive Shaft	47T	26	25	54	98.5	638					
	1996-	2000			SUV/Truck/VAN	GCI89021	Inner Joint		25	32	28	173	107					
2.0 i (98 kW)	1995.01-	2001.03			F MPV	GC089013	Outer Joint		26	32	54	98.5	61.5	I				
2.4 i (111 kW)	1995.01-	2001.03			F MPV Engine EDZ	GC089013	Outer Joint		26	32	54	98.5	61.5	I				
2.5 TD (85 kW)	1995.01-	2001.03			F MPV Engine ENC	GC089013	Outer Joint		26	32	54	98.5	61.5	I				
3.0 (112 kW)	1995.01-	2001.03			F MPV Engine EFA	GC089013	Outer Joint		26	32	54	98.5	61.5	I				
3.3 i (116 kW)	1995.01-	2001.03			F MPV Engine EGP	GC089013	Outer Joint		26	32	54	98.5	61.5	I				
3.8 i (122 kW)	1995.01-	2001.03			F MPV Engine EGH	GC089013	Outer Joint		26	32	54	98.5	61.5	I				
3.8 i (131 kW)	1995.01-	2001.03			F MPV Engine EGH	GC089013	Outer Joint		26	32	54	98.5	61.5	I				
3.8 i AWD (122 kW)	1995.01-	2001.03			MPV Engine EGH	GC089013	Outer Joint		26	32	54	98.5	61.5	I				
3.8 i AWD (131 kW)	1995.01-	2001.03			MPV Engine EGH	GC089013	Outer Joint		26	32	54	98.5	61.5	I				
<b>COLT VISTA FWD</b>																		
2.4	1992-	1994	AT			GC039041	Outer Joint		25	25	54	95.5	65	M				
<b>DAKOTA</b>																		
-	1991-	1996			4WD	GC015009	Outer Joint	56T	31	34	61	115.5	64	O				
	1991-	1996			SUV/Truck/VAN 4WD	GC015005	Outer Joint		31	34	61	115.5	64	O				
	2000-					GCI15010	Inner Joint		29	35	47	53	90					
<b>DAYTONA</b>																		
-	1986-	1993			SAGINAW	GC089010	Outer Joint		26	29	54	99.5	62.5	O				
	1987-	1993				GC089008	Outer Joint		26	28	54	98	58	I				
<b>DURANGO</b>																		
-	2000-					GCI15010	Inner Joint		29	35	47	53	90					
<b>DYNASTY</b>																		
-	1989-	1990			Saginaw	GC089010	Outer Joint		26	29	54	99.5	62.5	O				
<b>INTREPID</b>																		
-	1993-	2004				GCI99062	Inner Joint		27	32	39.5	49	76					
	1993-	1995				GC089016	Outer Joint		33	32	49.6	102.5	60	O				
	1993-	1995				GC089038	Outer Joint	50W	33	32	49.6	102.5	60	O				
	1996-	1997				GC089016	Outer Joint		33	32	49.6	102.5	60	O				
	1996-	1997		R		GDS89013	Drive Shaft	50T	33	27	49.6	102.5	537					
	1996-	1997				GC088022	Outer Joint	50T	33	32	49.6	102.5	60	O				
	1996-	1997				GCI89009	Inner Joint		27	32	39.8	47.5	77.5					
	1998-	2004				GC089039	Outer Joint	50T	33	32	49.6	102.5	57	O				
<b>LANCER</b>																		
-	1986-	1989			SAGINAW	GC089010	Outer Joint		26	29	54	99.5	62.5	O				
<b>NEON</b>																		
-	2000-					GC089033	Outer Joint	46T	26	22	57.7	92.5	58	M				
2.0 16V (107 kW)	1994.06-	1999.08			F Saloon Engine ECC	GC089011	Outer Joint		23	28	57.7	91.8	58	I				



		YEAR	TRANSM	L/R	F/R		G-AP Ref.	PRODUCT	ABS	Technical Specifications									
										A	B	C	H	L	P				
<b>DODGE</b>																			
<b>NEON</b>																			
2.0 16V (109 kW)	1996.04-	1999.08			F	Saloon Engine ECC	GC089011	Outer Joint			23	28	57.7	91.8	58	I			
2.0 16V (112 kW)	1996.04-	1999.08			F	Saloon Engine ECC	GC089011	Outer Joint			23	28	57.7	91.8	58	I			
2.0 16V (98 kW)	1994.05-	1999.08			F	Saloon Engine ECB	GC089011	Outer Joint			23	28	57.7	91.8	58	I			
<b>NEON II</b>																			
2.0 16V (112 kW)	1999.08-				F	Saloon Engine ECH	GC089011	Outer Joint			23	28	57.7	91.8	58	I			
2.0 16V (98 kW)	1999.08-				F	Saloon Engine ECB	GC089011	Outer Joint			23	28	57.7	91.8	58	I			
<b>RAM 50</b>																			
-	1982-	1993				4WD	GCI39044	Inner Joint				25		62.5					
<b>SHADOW</b>																			
-	1987-	1994				Saginaw	GC089010	Outer Joint			26	29	54	99.5	62.5	O			
	1987-	1994					GC089008	Outer Joint			26	28	54	98	58	I			
<b>SPIRIT</b>																			
-	1989-	1990				Saginaw	GC089010	Outer Joint			26	29	54	99.5	62.5	O			
	1991-	1993					GCI89026	Inner Joint			25	32	40	71	124				
<b>STEALTH</b>																			
-					F		GC039037	Outer Joint			27	26	60	97	69	I			
<b>STEALTH (FWD)</b>																			
-	1993-	1996					GCI15006	Inner Joint			26	26	42	39.5	78.5				
<b>DODGE TRUCK</b>																			
<b>CARAVAN</b>																			
-	1996-	1997			R	Truck 2WD	GDS89005	Drive Shaft	47T		26	25	54	98.5	1030				
	1996-	1997					GCI89011	Inner Joint			25	32	40	71.5	107				
	1996-	2001			R		GC089013	Outer Joint			26	32	54	98.5	61.5	I			
	1996-	2001			R		GCI89012	Inner Joint			25	32	28	173	107				
<b>EAGLE</b>																			
<b>SUMMIT</b>																			
2.4	1992-	1996					GC039041	Outer Joint			25	25	54	95.5	65	M			
<b>VISION</b>																			
-	1993-	1995					GC089016	Outer Joint			33	32	49.6	102.5	60	O			
	1993-	1995					GC089038	Outer Joint	50W		33	32	49.6	102.5	60	O			
	1996-	1997					GC089016	Outer Joint			33	32	49.6	102.5	60	O			
	1996-	1997			R		GDS89013	Drive Shaft	50T		33	27	49.6	102.5	537				
	1996-	1997					GC088022	Outer Joint	50T		33	32	49.6	102.5	60	O			
	1996-	1997					GCI89009	Inner Joint			27	32	39.8	47.5	77.5				
<b>FIAT</b>																			
<b>127</b>																			
0.9 (29 kW)	1971.06-	1983.05			F	Hatchback Engine 100GL.048	GC017005	Outer Joint			22	20	48.1	90.5	59.5	O			
0.9 (33 kW)	1971.06-	1983.05			F	Hatchback Engine 100GL.000	GC017005	Outer Joint			22	20	48.1	90.5	59.5	O			
1.0 (37 kW)	1977.04-	1986.12	MT		F	Hatchback Engine 127A.000	GC017005	Outer Joint			22	20	48.1	90.5	59.5	O			
1.3 Diesel (33 kW)	1981.04-	1986.12	MT		F	Hatchback Engine 127A5.000	GC017005	Outer Joint			22	20	48.1	90.5	59.5	O			
1.3 Sport (55 kW)	1981.12-	1983.05	MT		F	Hatchback Engine 127A3.000	GC017005	Outer Joint			22	20	48.1	90.5	59.5	O			
<b>127 PANORAMA</b>																			
1.0 (37 kW)	1977.01-	1986.12	MT		F	Estate Engine 127A.000	GC017005	Outer Joint			22	20	48.1	90.5	59.5	O			
1.3 D (33 kW)	1981.06-	1986.12	MT		F	Estate Engine 127A5.000	GC017005	Outer Joint			22	20	48.1	90.5	59.5	O			
<b>128</b>																			
1.1 (33 kW)	1975.02-	1981.09	MT		F	Saloon Engine 128A.048	GC017005	Outer Joint			22	20	48.1	90.5	59.5	O			
1.1 (40 kW)	1969.03-	1984.12			F	Saloon Engine 128A.000	GC017005	Outer Joint			22	20	48.1	90.5	59.5	O			
1.3 Sport (44 kW)	1974.08-	1984.12			F	Saloon Engine 128A1.000	GC017005	Outer Joint			22	20	48.1	90.5	59.5	O			
<b>128 FAMILIARE</b>																			
1.1 (40 kW)	1969.10-	1982.10			F	Estate Engine 128A.000	GC017005	Outer Joint			22	20	48.1	90.5	59.5	O			
<b>500</b>																			
1.2 (51 kW)	2008.01-				F	Hatchback Engine 169A4.000	GC017043	Outer Joint			22	20	47	75.5	54.5	M			
	2008.01-				L	F Hatchback Engine 169A4.000	GDS17170	Drive Shaft			22	29.2	47	75.5	524				
	2008.01-				L	F Hatchback Engine 169A4.000	GC017043	Outer Joint			22	20	47	75.5	54.5	M			
	2008.01-				R	F Hatchback Engine 169A4.000	GDS17171	Drive Shaft			22	29.2	47	75.5	758				
1.2 LPG (51 kW)	2010.12-		MT		L	F Hatchback Engine 169A4.000	GDS17101	Drive Shaft			22	22	47	75.5	613				
	2010.12-				L	F Hatchback Engine 169A4.000	GDS17170	Drive Shaft			22	29.2	47	75.5	524				
	2010.12-				L	F Hatchback Engine 169A4.000	GC017043	Outer Joint			22	20	47	75.5	54.5	M			
	2010.12-		MT/AT		R	F Hatchback Engine 169A4.000	GDS17112	Drive Shaft			22	22	47	75.5	846				
	2010.12-				R	F Hatchback Engine 169A4.000	GDS17171	Drive Shaft			22	29.2	47	75.5	758				

		TRANSM	L/R	F/R		G-AP Ref.	PRODUCT	ABS	Technical Specifications						
									YEAR	A	B	C	H	L	P
<b>FIAT</b>															
<b>500</b>															
1.3 D Multijet (55 kW)	2008.01-			F	Hatchback Engine 169A1.000	GCO17026	Outer Joint		25	22	51	84	57	M	
	2008.01-		MT	L	F	Hatchback Engine 169A1.000	GDS17119	Drive Shaft	25	22	51	84	615		
	2008.01-		MT	R	F	Hatchback Engine 169A1.000	GDS17120	Drive Shaft	25	22	51	84	846		
1.3 D Multijet (70 kW)	2009.12-		MT	L	F	Hatchback Engine 199B1.000	GDS17119	Drive Shaft	25	22	51	84	615		
	2009.12-		MT	R	F	Hatchback Engine 199B1.000	GDS17120	Drive Shaft	25	22	51	84	846		
1.4 (74 kW)	2008.01-			F	Hatchback Engine 169A3.000	GCO17026	Outer Joint		25	22	51	84	57	M	
	2008.01-			L	F	Hatchback Engine 169A3.000	GDS17119	Drive Shaft	25	22	51	84	615		
<b>500 C</b>															
1.2 (51 kW)	2009.09-			F	Convertible Engine 169A4.000	GCO17043	Outer Joint		22	20	47	75.5	54.5	M	
1.3 D Multijet (55 kW)	2009.09-			F	Convertible Engine 169A1.000	GCO17026	Outer Joint		25	22	51	84	57	M	
	2009.09-		MT	L	F	Convertible Engine 169A1.000	GDS17119	Drive Shaft	25	22	51	84	615		
	2009.09-			R	F	Convertible Engine 169A1.000	GDS17120	Drive Shaft	25	22	51	84	846		
1.3 D Multijet (70 kW)	2009.09-		MT	L	F	Convertible Engine 199B1.000	GDS17119	Drive Shaft	25	22	51	84	615		
	2009.09-		MT	R	F	Convertible Engine 199B1.000	GDS17120	Drive Shaft	25	22	51	84	846		
1.4 (74 kW)	2009.09-			F	Convertible Engine 169A3.000	GCO17026	Outer Joint		25	22	51	84	57	M	
	2009.09-		MT	L	F	Convertible Engine 169A3.000	GDS17119	Drive Shaft	25	22	51	84	615		
<b>500 L</b>															
0.9 (70 kW)	2012-					GCI17027	Inner Joint		22	22	36	61.5	93.5		
1.3 DS (62 kW)	2012-			L		GCI99008	Inner Joint		24	24	29.7	86.5	93		
	2012-			R		GCI17015	Inner Joint		24	24	29.7	379	100.5		
1.4 (88 kW)	2013-					GCI17027	Inner Joint		22	22	36	61.5	93.5		
<b>500, 500 C, ABARTH</b>															
0.9 (48 kW)	2012.07-					GCI17027	Inner Joint		22	22	36	61.5	93.5		
0.9 (63 kW)	2010-					GCO17026	Outer Joint		25	22	51	84	57	M	
	2012.07-					GCI17027	Inner Joint		22	22	36	61.5	93.5		
0.9 (77 kW)	2012.07-					GCI17027	Inner Joint		22	22	36	61.5	93.5		
1.2 (51 kW)	2007.10-					GCI17001	Inner Joint		22	19	36	61.5	88.5		
	2007.10-					GCO17043	Outer Joint		22	20	47	75.5	54.5	M	
1.3 D Multijet (55 kW)	2007.10-					GCO17026	Outer Joint		25	22	51	84	57	M	
	2007.10-					GCI17027	Inner Joint		22	22	36	61.5	93.5		
1.4 (70 kW)	2007.10-					GCI17027	Inner Joint		22	22	36	61.5	93.5		
1.4 (74 kW)	2007.10-					GCO17026	Outer Joint		25	22	51	84	57	M	
<b>500L</b>															
0.9 (77 kW)	2012.09-				Hatchback Engine 199B6.000	GCI17027	Inner Joint		22	22	36	61.5	93.5		
<b>ABARTH 500</b>															
1.3 D Multijet (74 kW)	2009.12-			L		GCI17011	Inner Joint		24	23	29.7	86.5	93		
1.4 (103 kW)	2008.08-			L		GCI99008	Inner Joint		24	24	29.7	86.5	93		
1.4 (132 kW)	2008.08-			L		GCI99008	Inner Joint		24	24	29.7	86.5	93		
1.4 (99 kW)	2008.08-			L		GCI99008	Inner Joint		24	24	29.7	86.5	93		
<b>ABARTH 500 C</b>															
1.3 D Multijet (74 kW)	2009.12-			L		GCI17011	Inner Joint		24	23	29.7	86.5	93		
1.4 (103 kW)	2008.08-			L		GCI99008	Inner Joint		24	24	29.7	86.5	93		
1.4 (132 kW)	2008.08-			L		GCI99008	Inner Joint		24	24	29.7	86.5	93		
1.4 (99 kW)	2008.08-			L		GCI99008	Inner Joint		24	24	29.7	86.5	93		
<b>ALBEA</b>															
1.2	2002-					GCI17027	Inner Joint		22	22	36	61.5	93.5		
1.2 16V	2002-			L	F	GDS17029	Drive Shaft		22	31.95	47	89	504		
	2002-			R	F	GDS17030	Drive Shaft		22	31.95	47	89	809		
1.3 MJT	2003-2006			L	F	GDS17003	Drive Shaft		25		51	90	455		
	2003-2006			R	F	GDS17002	Drive Shaft		25		51	90	533		
	2006-				F	GCI99008	Inner Joint		24	24	29.7	86.5	93		
	2006-			L	F	GDS17013	Drive Shaft		25	35.6	51	90	501		
	2006-			R	F	GDS17014	Drive Shaft		25	35.6	51	90	524		
	2006-			L	F	GDS17056	Drive Shaft		25	24	51	90	557		
1.3 MJTD	2006-			L		GDS17034	Drive Shaft		25	35.6	51	90	447		
1.4	2002-					GCI17027	Inner Joint		22	22	36	61.5	93.5		
1.4 16V	2002-			L	F	GDS17029	Drive Shaft		22	31.95	47	89	504		
	2002-			R	F	GDS17030	Drive Shaft		22	31.95	47	89	809		
1.6	2002-					GCI17027	Inner Joint		22	22	36	61.5	93.5		
1.6 16V	2002-			L	F	GDS17029	Drive Shaft		22	31.95	47	89	504		
	2002-			R	F	GDS17030	Drive Shaft		22	31.95	47	89	809		









		YEAR	TRANSM	L/R	F/R		G-AP Ref.	PRODUCT	ABS	Technical Specifications						
										A	B	C	H	L	P	
<b>FIAT</b>																
<b>BARCETTA (183)</b>																
1.8 16V (96 kW)	1995.04-	2005.05	MT		F	Convertible Engine 183A1.000/188A6.000	GCO17042	Outer Joint		25	25	51	85	58	O	
	1995.04-	2005.05	MT		F	Convertible Engine 183A1.000/188A6.000	GCO17004	Outer Joint		25	25	52	85	58	I	
	1995.04-	2005.05	MT		F	Convertible Engine 183A1.000/188A6.000	GCI82005	Inner Joint			25		32			
<b>BRAVA (182)</b>																
1.2 16V (60 kW)	1998.12-	2002.12			F	Hatchback Engine 182B2.000	GCO17008	Outer Joint		22	20	51	79.5	51.5	O	
	1998.12-	2002.12			F	Hatchback Engine 182B2.000	GCI82005	Inner Joint			25		32			
	1998.12-	2002.12	MT	L	F	Hatchback Engine 182B2.000	GDS17010	Drive Shaft		22	31.95	46.8	75.5	569		
	1998.12-	2002.12	MT	L	F	Hatchback Engine 182B2.000	GCO17001	Outer Joint		22	20	46.8	75.5	52	O	
	1998.12-	2002.12	MT	R	F	Hatchback Engine 182B2.000	GDS17011	Drive Shaft		22	31.95	46.8	75.5	928.5		
	1998.12-	2002.12				Hatchback Engine 182B2.000	GCI17027	Inner Joint		22	22	36	61.5	93.5		
1.4 (55 kW)	1995.10-	2001.10	MT	L	F	Hatchback Engine 182A5.000	GDS17010	Drive Shaft		22	31.95	46.8	75.5	569		
	1995.10-	2001.10	MT	R	F	Hatchback Engine 182A5.000	GDS17011	Drive Shaft		22	31.95	46.8	75.5	928.5		
	1995.10-	2001.10	MT	L	F	Hatchback Engine 182A5.000	GCO17001	Outer Joint		22	20	46.8	75.5	52	O	
	1995.10-	2001.10	MT	R	F	Hatchback Engine 182A5.000	GDS17025	Drive Shaft		22	22	46.8	75.5	913		
	1995.10-	2001.10	MT	L	F	Hatchback Engine 182A5.000	GDS17114	Drive Shaft	44T	22	22	46.8	75.5	591		
	1995.10-	2001.10	MT	R	F	Hatchback Engine 182A5.000	GDS17041	Drive Shaft	44T	22	22	46.8	75.5	913		
1.4 12V (59 kW)	1995.10-	1998.08	MT	R	F	Hatchback Engine 182A3.000	GDS17025	Drive Shaft		22	22	46.8	75.5	913		
	1995.10-	1998.08	MT	L	F	Hatchback Engine 182A3.000	GDS17114	Drive Shaft	44T	22	22	46.8	75.5	591		
	1995.10-	1998.08	MT	R	F	Hatchback Engine 182A3.000	GDS17041	Drive Shaft	44T	22	22	46.8	75.5	913		
1.6 16V (66 kW)	1995.10-	2001.10	MT	L	F	Hatchback Engine 182A6.000	GDS17010	Drive Shaft		22	31.95	46.8	75.5	569		
	1995.10-	2001.10	MT	R	F	Hatchback Engine 182A6.000	GDS17011	Drive Shaft		22	31.95	46.8	75.5	928.5		
	1995.10-	2001.10	MT	L	F	Hatchback Engine 182A6.000	GCO17001	Outer Joint		22	20	46.8	75.5	52	O	
	1995.10-	2001.10	MT/AT		F	Hatchback Engine 182A6.000	GCO17021	Outer Joint		22	22	46.8	75.5	52	O	
	1995.10-	2001.10	MT/AT		F	Hatchback Engine 182A6.000	GCO17022	Outer Joint	44T	22	22	46.8	75.5	52	O	
1.6 16V (76 kW)	1996.02-	2001.10	MT/AT		F	Hatchback Engine 182A4.000	GCO17021	Outer Joint		22	22	46.8	75.5	52	O	
	1996.02-	2001.10	MT/AT		F	Hatchback Engine 182A4.000	GCO17022	Outer Joint	44T	22	22	46.8	75.5	52	O	
1.8 GT 16V (83 kW)	1995.10-	2001.10		L/R	F	Hatchback Engine 182A2.000	GDS82005	Drive Shaft		25		51	85	450		
1.9 D (48 kW)	1995.10-	2001.10	MT	L	F	Hatchback Engine 160A7.000	GDS17010	Drive Shaft		22	31.95	46.8	75.5	569		
	1995.10-	2001.10	MT	R	F	Hatchback Engine 160A7.000	GDS17011	Drive Shaft		22	31.95	46.8	75.5	928.5		
	1995.10-	2001.10	MT	L	F	Hatchback Engine 160A7.000	GCO17001	Outer Joint		22	20	46.8	75.5	52	O	
1.9 JTD (74 kW)	2000.09-	2001.10		L/R	F	Hatchback Engine 182B9.000	GDS82005	Drive Shaft		25		51	85	450		
1.9 JTD (77 kW)	1998.12-	2001.10		L/R	F	Hatchback Engine 182B4.000	GDS82005	Drive Shaft		25		51	85	450		
1.9 TD S (55 kW)	1996.03-	2001.10		L/R	F	Hatchback Engine 182A8.000	GDS82005	Drive Shaft		25		51	85	450		
	1996.03-	2001.10	MT	L/R	F	Hatchback Engine 182A8.000	GDS17038	Drive Shaft		25		52	85	452		
	1996.03-	2001.10	MT	L/R	F	Hatchback Engine 182A8.000	GDS17001	Drive Shaft	44T	25		52	85	452		
1.9 TD S (74 kW)	1996.03-	2001.10		L/R	F	Hatchback Engine 182A7.000	GDS82005	Drive Shaft		25		51	85	450		
	1996.03-	2001.10	MT	L/R	F	Hatchback Engine 182A7.000	GDS17038	Drive Shaft		25		52	85	452		
	1996.03-	2001.10	MT	L/R	F	Hatchback Engine 182A7.000	GDS17001	Drive Shaft	44T	25		52	85	452		
<b>BRAVA,BRAVO (182)</b>																
1.2 16V (59 kW)	1998.12-	2001.10					GCI17027	Inner Joint		22	22	36	61.5	93.5		
<b>BRAVO (198)</b>																
1.4 16V (66 kW)	2007.04-						GCO17026	Outer Joint		25	22	51	84	57	M	
1.4 T-JET (110 kW)	2007.09-				L		GCI17035	Inner Joint		25	26	34.9	57.5	114.5		
	2007.09-				R		GCI17058	Inner Joint		25	26	34.9	367	108.5		
	2007.09-						GCO17030	Outer Joint		25	26	51	84.5	64.5	M	
1.4 T-JET (88 kW)	2007.09-				L		GCI17035	Inner Joint		25	26	34.9	57.5	114.5		
	2007.09-				R		GCI17058	Inner Joint		25	26	34.9	367	108.5		
	2007.09-						GCO17030	Outer Joint		25	26	51	84.5	64.5	M	
1.6 D Multijet (66 kW)	2007-	2009					GCO17063	Outer Joint		25	25	51.1	84.5	61	M	
1.6 D Multijet (77 kW)	2007-	2009					GCO17063	Outer Joint		25	25	51.1	84.5	61	M	
1.6 D Multijet (88 kW)	2007-	2009					GCO17063	Outer Joint		25	25	51.1	84.5	61	M	
	2009.07-				L		GCI17035	Inner Joint		25	26	34.9	57.5	114.5		
1.9 D Multijet (110 kW)	2007.04-				L		GCI17005	Inner Joint		25	26	32	91	95		
	2007.04-				R		GCI17006	Inner Joint		25	26	29.8	377	108		
1.9 D Multijet (66 kW)	2007.04-				L		GCI17035	Inner Joint		25	26	34.9	57.5	114.5		
1.9 D Multijet (88 kW)	2007.04-				L		GCI17035	Inner Joint		25	26	34.9	57.5	114.5		
	2007.04-				L		GCI17005	Inner Joint		25	26	32	91	95		
	2007.04-				R		GCI17006	Inner Joint		25	26	29.8	377	108		
	2007.04-						GCO17030	Outer Joint		25	26	51	84.5	64.5	M	
2.0 D Multijet (121 kW)	2008.09-				L		GCI21017	Inner Joint		27	27	35	78.5	112		
	2008.09-						GCO17064	Outer Joint		27	27	59	84.5	64	M	



		YEAR	TRANSM	L/R	F/R		G-AP Ref.	PRODUCT	ABS	Technical Specifications													
										A	B	C	H	L	P								
<b>FIAT BRAVO I (182)</b>																							
1.2 16V (59 kW)	2000.10-	2001.10	MT	L	F	Hatchback Engine 188A5.000	GDS17010	Drive Shaft		22	31.95	46.8	75.5	569									
	2000.10-	2001.10	MT	R	F	Hatchback Engine 188A5.000	GDS17011	Drive Shaft		22	31.95	46.8	75.5	928.5									
	2000.10-	2001.10	MT	L	F	Hatchback Engine 188A5.000	GC017001	Outer Joint		22	20	46.8	75.5	52	O								
1.2 16V (60 kW)	1998.12-	2000.10	MT	L	F	Hatchback Engine 182B2.000	GC017001	Outer Joint		22	20	46.8	75.5	52	O								
1.4 (55 kW)	1995.10-	2001.10	MT	L	F	Hatchback Engine 182A5.000	GDS17010	Drive Shaft		22	31.95	46.8	75.5	569									
	1995.10-	2001.10	MT	R	F	Hatchback Engine 182A5.000	GDS17011	Drive Shaft		22	31.95	46.8	75.5	928.5									
	1995.10-	2001.10	MT	L	F	Hatchback Engine 182A5.000	GC017001	Outer Joint		22	20	46.8	75.5	52	O								
	1995.10-	2001.10	MT	R	F	Hatchback Engine 182A5.000	GDS17025	Drive Shaft		22	22	46.8	75.5	913									
	1995.10-	2001.10	MT	L	F	Hatchback Engine 182A5.000	GDS17114	Drive Shaft	44T	22	22	46.8	75.5	591									
	1995.10-	2001.10	MT	R	F	Hatchback Engine 182A5.000	GDS17041	Drive Shaft	44T	22	22	46.8	75.5	913									
1.4 (59 kW)	1995.10-	2001.10	MT	L	F	Hatchback Engine 182A3.000	GDS17010	Drive Shaft		22	31.95	46.8	75.5	569									
	1995.10-	2001.10	MT	R	F	Hatchback Engine 182A3.000	GDS17011	Drive Shaft		22	31.95	46.8	75.5	928.5									
	1995.10-	2001.10	MT	L	F	Hatchback Engine 182A3.000	GC017001	Outer Joint		22	20	46.8	75.5	52	O								
	1995.10-	2001.10	MT	R	F	Hatchback Engine 182A3.000	GDS17025	Drive Shaft		22	22	46.8	75.5	913									
	1995.10-	2001.10	MT	L	F	Hatchback Engine 182A3.000	GDS17114	Drive Shaft	44T	22	22	46.8	75.5	591									
	1995.10-	2001.10	MT	R	F	Hatchback Engine 182A3.000	GDS17041	Drive Shaft	44T	22	22	46.8	75.5	913									
1.6 16V (66 kW)	1995.10-	2001.10	MT	L	F	Hatchback Engine 182A6.000	GDS17010	Drive Shaft		22	31.95	46.8	75.5	569									
	1995.10-	2001.10	MT	R	F	Hatchback Engine 182A6.000	GDS17011	Drive Shaft		22	31.95	46.8	75.5	928.5									
	1995.10-	2001.10	MT	L	F	Hatchback Engine 182A6.000	GC017001	Outer Joint		22	20	46.8	75.5	52	O								
	1995.10-	2001.10	MT/AT		F	Hatchback Engine 182A6.000	GC017021	Outer Joint		22	22	46.8	75.5	52	O								
	1995.10-	2001.10	MT/AT		F	Hatchback Engine 182A6.000	GC017022	Outer Joint	44T	22	22	46.8	75.5	52	O								
1.6 16V (76 kW)	1996.03-	2001.10	MT/AT		F	Hatchback Engine 182A4.000	GC017021	Outer Joint		22	22	46.8	75.5	52	O								
	1996.03-	2001.10	MT/AT		F	Hatchback Engine 182A4.000	GC017022	Outer Joint	44T	22	22	46.8	75.5	52	O								
1.8 GT (83 kW)	1995.10-	2001.10		L/R	F	Hatchback Engine 182A2.000	GDS82005	Drive Shaft		25		51	85	450									
1.9 D (48 kW)	1995.10-	2001.10	MT	L	F	Hatchback Engine 160A7.000	GDS17010	Drive Shaft		22	31.95	46.8	75.5	569									
	1995.10-	2001.10	MT	R	F	Hatchback Engine 160A7.000	GDS17011	Drive Shaft		22	31.95	46.8	75.5	928.5									
	1995.10-	2001.10	MT	L	F	Hatchback Engine 160A7.000	GC017001	Outer Joint		22	20	46.8	75.5	52	O								
1.9 JTD (74 kW)	2000.09-	2001.10		L/R	F	Hatchback Engine 182B9.000	GDS82005	Drive Shaft		25		51	85	450									
	2000.09-	2001.10	MT	L/R	F	Hatchback Engine 182B9.000	GDS17038	Drive Shaft		25		52	85	452									
	2000.09-	2001.10	MT	L/R	F	Hatchback Engine 182B9.000	GDS17001	Drive Shaft	44T	25		52	85	452									
1.9 JTD (77 kW)	1998.12-	2001.10		L/R	F	Hatchback Engine 182B4.000	GDS82005	Drive Shaft		25		51	85	450									
1.9 TD S (55 kW)	1996.03-	2001.10		L/R	F	Hatchback Engine 182A8.000	GDS82005	Drive Shaft		25		51	85	450									
	1996.03-	2001.10	MT	L/R	F	Hatchback Engine 182A8.000	GDS17038	Drive Shaft		25		52	85	452									
	1996.03-	2001.10	MT	L/R	F	Hatchback Engine 182A8.000	GDS17001	Drive Shaft	44T	25		52	85	452									
1.9 TD S (74 kW)	1996.03-	2001.10		L/R	F	Hatchback Engine 182A7.000	GDS82005	Drive Shaft		25		51	85	450									
	1996.03-	2001.10	MT	L/R	F	Hatchback Engine 182A7.000	GDS17038	Drive Shaft		25		52	85	452									
	1996.03-	2001.10	MT	L/R	F	Hatchback Engine 182A7.000	GDS17001	Drive Shaft	44T	25		52	85	452									
2.0 HGT 20V (108 kW)	1995.10-	1998.07	MT/AT		F	Hatchback Engine 182A1.000	GC017032	Outer Joint	44T	25	25	59	85	58	O								
<b>BRAVO II</b>																							
1.4 16V (66 kW)	2010.01-						GCI17027	Inner Joint		22	22	36	61.5	93.5									
1.4 Multiair Turbo 16V (103 kW)	2010.03-			L			GCI17031	Inner Joint		25	26	32	59	110.5									
1.4 Multiair Turbo 16V (88 kW)	2010.03-			L			GCI17031	Inner Joint		25	26	32	59	110.5									
1.4 T-JET 16V (110 kW)	2010.01-			L			GCI17035	Inner Joint		25	26	34.9	57.5	114.5									
	2010.01-			R			GCI17058	Inner Joint		25	26	34.9	367	108.5									
1.4 T-JET 16V (88 kW)	2010.01-			L			GCI17035	Inner Joint		25	26	34.9	57.5	114.5									
	2010.01-			R			GCI17058	Inner Joint		25	26	34.9	367	108.5									
1.6 JTD 16V (66 kW)	2010.01-			L			GCI17031	Inner Joint		25	26	32	59	110.5									
1.6 JTD 16V (77 kW)	2010.01-			L			GCI17031	Inner Joint		25	26	32	59	110.5									
1.6 JTD 16V (88 kW)	2010.01-			L			GCI17031	Inner Joint		25	26	32	59	110.5									
	2010.01-			L			GCI17035	Inner Joint		25	26	34.9	57.5	114.5									
1.9 JTD (110 kW)	2010.01-			L			GCI17005	Inner Joint		25	26	32	91	95									
	2010.01-			R			GCI17006	Inner Joint		25	26	29.8	377	108									
2.0 JTDM 16V (121 kW)	2010.01-			L			GCI21017	Inner Joint		27	27	35	78.5	112									
<b>BRAVO II (198)</b>																							
1.4 (66 kW)	2007.05-				F	Hatchback Engine 192B2.000	GC017026	Outer Joint		25	22	51	84	57	M								
	2007.05-					Hatchback Engine 192B2.000	GCI17027	Inner Joint		22	22	36	61.5	93.5									
1.4 T-Jet (110 kW)	2007.05-				F	Hatchback Engine 198A1.000	GC017030	Outer Joint		25	26	51	84.5	64.5	M								
	2007.05-		MT	L	F	Hatchback Engine 198A1.000	GDS17180	Drive Shaft		25	25	51	84.5	628									
1.4 T-Jet (88 kW)	2007.10-				F	Hatchback Engine 198A4.000	GC017030	Outer Joint		25	26	51	84.5	64.5	M								
	2007.10-		MT	L	F	Hatchback Engine 198A4.000	GDS17180	Drive Shaft		25	25	51	84.5	628									
1.6 D Multijet (66 kW)	2008.03-			L/R	F	Hatchback Engine 198A6.000	GDS17194	Drive Shaft		25	39.2	51	84.5	523									

		TRANSM	L/R	F/R		G-AP Ref.	PRODUCT	ABS	Technical Specifications						
									YEAR	A	B	C	H	L	P
<b>FIAT</b>															
<b>BRAVO II (198)</b>															
1.6 D Multijet (77 kW)	2008.03-			F	Hatchback Engine 198A3.000	GCO17030	Outer Joint		25	26	51	84.5	64.5	M	
	2008.03-		L	F	Hatchback Engine 198A3.000	GDS17179	Drive Shaft		25	25	51	84.5	632		
	2008.03-		L/R	F	Hatchback Engine 198A3.000	GDS17194	Drive Shaft		25	39.2	51	84.5	523		
	2008.03-		R	F	Hatchback Engine 198A3.000	GDS17178	Drive Shaft		25	25	51	84.5	931		
1.6 D Multijet (85 kW)	2008.11-		L	F	Hatchback Engine 955A4.000	GDS17179	Drive Shaft		25	25	51	84.5	632		
	2008.11-		R	F	Hatchback Engine 955A4.000	GDS17178	Drive Shaft		25	25	51	84.5	931		
1.6 D Multijet (88 kW)	2008.03-			F	Hatchback Engine 198A2.000	GCO17030	Outer Joint		25	26	51	84.5	64.5	M	
	2008.03-		L	F	Hatchback Engine 198A2.000	GDS17179	Drive Shaft		25	25	51	84.5	632		
	2008.03-	MT	L/R	F	Hatchback Engine 198A2.000	GDS17194	Drive Shaft		25	39.2	51	84.5	523		
	2008.03-		R	F	Hatchback Engine 198A2.000	GDS17178	Drive Shaft		25	25	51	84.5	931		
1.9 D Multijet (110 kW)	2007.04-		L	F	Hatchback Engine 937A5.000	GDS17121	Drive Shaft		25	25	59	84	630		
	2007.04-		L	F	Hatchback Engine 937A5.000	GCI17005	Inner Joint		25	26	32	91	95		
	2007.04-		R	F	Hatchback Engine 937A5.000	GDS17136	Drive Shaft		25	25	51	84.5	931		
1.9 D Multijet (66 kW)	2007.04-	2008.12	L/R	F	Hatchback Engine 192B5.000	GDS17194	Drive Shaft		25	39.2	51	84.5	523		
1.9 D Multijet (88 kW)	2007.04-			F	Hatchback Engine 192A8.000	GCO17030	Outer Joint		25	26	51	84.5	64.5	M	
	2007.04-		L	F	Hatchback Engine 192A8.000	GDS17179	Drive Shaft		25	25	51	84.5	632		
	2007.04-	5MT	L/R	F	Hatchback Engine 192A8.000	GDS17194	Drive Shaft		25	39.2	51	84.5	523		
	2007.04-		R	F	Hatchback Engine 192A8.000	GDS17178	Drive Shaft		25	25	51	84.5	931		
<b>BRAVO VAN (198)</b>															
1.6 D Multijet (77 kW)	2008.03-		L/R	F	Box Engine 198A3.000	GDS17194	Drive Shaft		25	39.2	51	84.5	523		
<b>BRAVO, BRAVA (182)</b>															
1.2 16V (59 kW)	2000.10-	2001.10				GCO17008	Outer Joint		22	20	51	79.5	51.5	O	
1.2 16V (60 kW)	1998.12-	2000.10				GCO17008	Outer Joint		22	20	51	79.5	51.5	O	
1.6 16V (66 kW)	1995.10-	2001.10				GCO17011	Outer Joint		25	22	51	84.5	57	O	
1.6 16V (76 kW)	1996.03-	2001.10				GCO17011	Outer Joint		25	22	51	84.5	57	O	
1.9 JTD (77 kW)	1998.12-	2001.10	MT			GCO17042	Outer Joint		25	25	51	85	58	O	
1.9 TD (55 kW)	1996.03-	2001.10	MT			GCO17042	Outer Joint		25	25	51	85	58	O	
1.9 TD (74 kW)	1996.03-	2001.10	MT			GCO17042	Outer Joint		25	25	51	85	58	O	
2.0 HGT 20V (113 kW)	1998.07-	2001.10			Exc Brava	GC082008	Outer Joint		25	25	59	85	58	O	
<b>CAMPAGNOLA</b>															
2.0 (59 kW)	1974.06-	1989.10			Closed Off-Road Vehicle Engine 6132AZ2.000	GCI18070	Inner Joint			25		32			
<b>COUPE (FA/175)</b>															
2.0 16V (102 kW)	1993.11-	1996.08		F	Coupe Engine 836A3.000	GCI18070	Inner Joint			25		32			
2.0 16V Turbo (140 kW)	1993.11-	1996.08		F	Coupe Engine 175A1.000	GCI18070	Inner Joint			25		32			
2.0 20V Turbo (162 kW)	1996.08-	2000.08		F	Coupe Engine 175A3.000	GCI18070	Inner Joint			25		32			
<b>CROMA (154)</b>															
1.6 (61 kW)	1985.12-	1990.12		F	Hatchback Engine 154A.048	GCI18070	Inner Joint			25		32			
	1985.12-	1990.12	MT	F	Hatchback Engine 154A.048	GCO17003	Outer Joint	90T	25	25	54.5	77	58	I	
	1985.12-	1990.12	MT	F	Hatchback Engine 154A.048	GCI48004	Inner Joint			25		32			
	1985.12-	1990.12	MT	F	Hatchback Engine 154A.048	GCO17002	Outer Joint		25	25	54.5	77	58	I	
	1985.12-	1990.12	MT	F	Hatchback Engine 154A.048	GCO17002	Outer Joint		25	25	54.5	77	58	I	
1.9 Turbo D i.D. (66 kW)	1989.05-	1992.10		F	Hatchback Engine 154C6.000	GCI18070	Inner Joint			25		32			
	1989.05-	1992.10	MT	F	Hatchback Engine 154C6.000	GCO17003	Outer Joint	90T	25	25	54.5	77	58	I	
	1989.05-	1992.10	MT	F	Hatchback Engine 154C6.000	GCI48004	Inner Joint			25		32			
	1989.05-	1992.10		F	Hatchback Engine 154C6.000	GCO17018	Outer Joint	90T	25	25	52	85	58	I	
	1989.05-	1992.10	MT	F	Hatchback Engine 154C6.000	GCO17002	Outer Joint		25	25	54.5	77	58	I	
2.0 CHT (66 kW)	1985.12-	1989.02		F	Hatchback Engine 154A1.000	GCI18070	Inner Joint			25		32			
	1985.12-	1989.02	MT	F	Hatchback Engine 154A1.000	GCO17003	Outer Joint	90T	25	25	54.5	77	58	I	
	1985.12-	1989.02	MT	F	Hatchback Engine 154A1.000	GCI48004	Inner Joint			25		32			
	1985.12-	1989.02	MT	F	Hatchback Engine 154A1.000	GCO17002	Outer Joint		25	25	54.5	77	58	I	
2.0 CHT (74 kW)	1991.01-	1992.09		F	Hatchback	GCI18070	Inner Joint			25		32			
	1991.01-	1992.09	MT	F	Hatchback	GCO17003	Outer Joint	90T	25	25	54.5	77	58	I	
	1991.01-	1992.09	MT	F	Hatchback	GCI48004	Inner Joint			25		32			
	1991.01-	1992.09		F	Hatchback	GCO17018	Outer Joint	90T	25	25	52	85	58	I	
	1991.01-	1992.09	MT	F	Hatchback	GCO17002	Outer Joint		25	25	54.5	77	58	I	
2.0 i.e. (83 kW)	1986.03-	1990.09	MT	F	Hatchback Engine 834B.048	GCO17003	Outer Joint	90T	25	25	54.5	77	58	I	
	1986.03-	1990.09	MT	F	Hatchback Engine 834B.048	GCI48004	Inner Joint			25		32			
	1986.03-	1990.09	MT	F	Hatchback Engine 834B.048	GCO17002	Outer Joint		25	25	54.5	77	58	I	
2.0 i.e. (85 kW)	1987.10-	1996.08		F	Hatchback Engine 154C3.046/834B.146	GCI18070	Inner Joint			25		32			
	1987.10-	1996.08	MT	F	Hatchback Engine 154C3.046/834B.146	GCO17033	Outer Joint		27	25	56	85	58	I	
	1987.10-	1996.08		F	Hatchback Engine 154C3.046/834B.146	GCO17013	Outer Joint	44T	27	25	56	85	58	I	
	1987.10-	1996.08	MT	F	Hatchback Engine 154C3.046/834B.146	GCO17003	Outer Joint	90T	25	25	54.5	77	58	I	
	1987.10-	1996.08	MT	F	Hatchback Engine 154C3.046/834B.146	GCI48004	Inner Joint			25		32			









		TRANSM	L/R	F/R		G-AP Ref.	PRODUCT	ABS	Technical Specifications								
									YEAR	A	B	C	H	L	P		
<b>FIAT CROMA (154)</b>																	
2.0 i.e. (85 kW)	1987.10-1996.08			F	Hatchback Engine 154C3.046/834B.146	GCO17018	Outer Joint	90T	25	25	52	85	58	I			
	1987.10-1996.08	MT		F	Hatchback Engine 154C3.046/834B.146	GCO17002	Outer Joint		25	25	54.5	77	58	I			
2.0 i.e. (88 kW)	1987.03-1992.09			F	Hatchback Engine 154C3.000/834B.000	GCI18070	Inner Joint			25		32					
	1987.03-1992.09	MT		F	Hatchback Engine 154C3.000/834B.000	GCO17003	Outer Joint	90T	25	25	54.5	77	58	I			
	1987.03-1992.09	MT		F	Hatchback Engine 154C3.000/834B.000	GCI48004	Inner Joint			25		32					
	1987.03-1992.09			F	Hatchback Engine 154C3.000/834B.000	GCO17018	Outer Joint	90T	25	25	52	85	58	I			
	1987.03-1992.09	MT		F	Hatchback Engine 154C3.000/834B.000	GCO17002	Outer Joint		25	25	54.5	77	58	I			
2.0 i.e. Turbo (110 kW)	1987.06-1996.08			F	Hatchback Engine 154C4.046/834C.146	GCI18070	Inner Joint			25		32					
	1987.06-1996.08	MT		F	Hatchback Engine 154C4.046/834C.146	GCO17033	Outer Joint		27	25	56	85	58	I			
	1987.06-1996.08			F	Hatchback Engine 154C4.046/834C.146	GCO17013	Outer Joint	44T	27	25	56	85	58	I			
	1987.06-1996.08	MT		F	Hatchback Engine 154C4.046/834C.146	GCO17003	Outer Joint	90T	25	25	54.5	77	58	I			
	1987.06-1996.08	MT		F	Hatchback Engine 154C4.046/834C.146	GCI48004	Inner Joint			25		32					
	1987.06-1996.08			F	Hatchback Engine 154C4.046/834C.146	GCO17018	Outer Joint	90T	25	25	52	85	58	I			
	1987.06-1996.08	MT		F	Hatchback Engine 154C4.046/834C.146	GCO17002	Outer Joint		25	25	54.5	77	58	I			
2.0 i.e. Turbo (111 kW)	1986.11-1988.11			F	Hatchback Engine 834C.146	GCI18070	Inner Joint			25		32					
	1986.11-1988.11	MT		F	Hatchback Engine 834C.146	GCO17003	Outer Joint	90T	25	25	54.5	77	58	I			
	1986.11-1988.11	MT		F	Hatchback Engine 834C.146	GCI48004	Inner Joint			25		32					
	1986.11-1988.11			F	Hatchback Engine 834C.146	GCO17018	Outer Joint	90T	25	25	52	85	58	I			
	1986.11-1988.11	MT		F	Hatchback Engine 834C.146	GCO17002	Outer Joint		25	25	54.5	77	58	I			
2.0 i.e. Turbo (114 kW)	1985.12-1990.06			F	Hatchback Engine 154A2.000	GCI18070	Inner Joint			25		32					
	1985.12-1990.06	MT		F	Hatchback Engine 154A2.000	GCO17003	Outer Joint	90T	25	25	54.5	77	58	I			
	1985.12-1990.06	MT		F	Hatchback Engine 154A2.000	GCI48004	Inner Joint			25		32					
	1985.12-1990.06			F	Hatchback Engine 154A2.000	GCO17018	Outer Joint	90T	25	25	52	85	58	I			
	1985.12-1990.06	MT		F	Hatchback Engine 154A2.000	GCO17002	Outer Joint		25	25	54.5	77	58	I			
2.0 Turbo D i.D. (69 kW)	1992.11-1996.12			F	Hatchback Engine 154D1.000	GCI18070	Inner Joint			25		32					
	1992.11-1996.12	MT		F	Hatchback Engine 154D1.000	GCO17033	Outer Joint		27	25	56	85	58	I			
	1992.11-1996.12			F	Hatchback Engine 154D1.000	GCO17013	Outer Joint	44T	27	25	56	85	58	I			
	1992.11-1996.12			F	Hatchback Engine 154D1.000	GCO17018	Outer Joint	90T	25	25	52	85	58	I			
2.5 D (55 kW)	1985.12-1989.12			F	Hatchback Engine 8144.67	GCI18070	Inner Joint			25		32					
	1985.12-1989.12	MT		F	Hatchback Engine 8144.67	GCO17003	Outer Joint	90T	25	25	54.5	77	58	I			
	1985.12-1989.12	MT		F	Hatchback Engine 8144.67	GCI48004	Inner Joint			25		32					
	1985.12-1989.12			F	Hatchback Engine 8144.67	GCO17018	Outer Joint	90T	25	25	52	85	58	I			
	1985.12-1989.12	MT		F	Hatchback Engine 8144.67	GCO17002	Outer Joint		25	25	54.5	77	58	I			
2.5 TD (74 kW)	1985.12-1989.08			F	Hatchback Engine 8144.91.2000	GCI18070	Inner Joint			25		32					
	1985.12-1989.08	MT		F	Hatchback Engine 8144.91.2000	GCO17003	Outer Joint	90T	25	25	54.5	77	58	I			
	1985.12-1989.08	MT		F	Hatchback Engine 8144.91.2000	GCI48004	Inner Joint			25		32					
	1985.12-1989.08			F	Hatchback Engine 8144.91.2000	GCO17018	Outer Joint	90T	25	25	52	85	58	I			
	1985.12-1989.08	MT		F	Hatchback Engine 8144.91.2000	GCO17002	Outer Joint		25	25	54.5	77	58	I			
2.5 TD (85 kW)	1989.05-1996.08			F	Hatchback Engine 8144.97.2400/8144.97Y/8144.97	GCI18070	Inner Joint			25		32					
	1989.05-1996.08	MT		F	Hatchback Engine 8144.97.2400/8144.97Y/8144.97	GCO17033	Outer Joint		27	25	56	85	58	I			
	1989.05-1996.08			F	Hatchback Engine 8144.97.2400/8144.97Y/8144.97	GCO17013	Outer Joint	44T	27	25	56	85	58	I			
	1989.05-1996.08	MT		F	Hatchback Engine 8144.97.2400/8144.97Y/8144.97	GCO17003	Outer Joint	90T	25	25	54.5	77	58	I			
	1989.05-1996.08	MT		F	Hatchback Engine 8144.97.2400/8144.97Y/8144.97	GCI48004	Inner Joint			25		32					
	1989.05-1996.08			F	Hatchback Engine 8144.97.2400/8144.97Y/8144.97	GCO17018	Outer Joint	90T	25	25	52	85	58	I			
	1989.05-1996.08	MT		F	Hatchback Engine 8144.97.2400/8144.97Y/8144.97	GCO17002	Outer Joint		25	25	54.5	77	58	I			
2.5 TDE (77 kW)	1991.12-1996.08	MT		F	Hatchback Engine 8144.97S	GCO17002	Outer Joint		25	25	54.5	77	58	I			
	1991.12-1996.08	MT		F	Hatchback Engine 8144.97S	GCO17003	Outer Joint	90T	25	25	54.5	77	58	I			
	1991.12-1996.08	MT		F	Hatchback Engine 8144.97S	GCI48004	Inner Joint			25		32					
2.5 V6 (119 kW)	1993.06-1996.08			F	Hatchback Engine 834G.000	GCI18070	Inner Joint			25		32					
	1993.06-1996.08	MT		F	Hatchback Engine 834G.000	GCO17033	Outer Joint		27	25	56	85	58	I			
	1993.06-1996.08			F	Hatchback Engine 834G.000	GCO17013	Outer Joint	44T	27	25	56	85	58	I			
<b>CROMA (194)</b>																	
1.8 16V (103 kW)	2005.12-2011.01					GCI99026	Inner Joint		22	25	35	57	82.5				
	2005.12-					GCO17007	Outer Joint		30	25	52.5	105	62	O			
	2006.02-			F	Estate Engine 939A4.000	GCO17007	Outer Joint		30	25	52.5	105	62	O			
	2006.02-	MT	L	F	Estate Engine 939A4.000	GDS44020	Drive Shaft		30	22	52.5	105	617.5				
	2006.02-	MT	L	F	Estate Engine 939A4.000	GCI99026	Inner Joint		22	25	35	57	82.5				
	2006.02-	MT	L	F	Estate Engine 939A4.000	GCO17007	Outer Joint		30	25	52.5	105	62	O			
	2006.02-	MT	R	F	Estate Engine 939A4.000	GDS17040	Drive Shaft		30	22	52.5	105	987				
1.9 D Multijet (100 kW)	2005.06-			L		GCI17035	Inner Joint		25	26	34.9	57.5	114.5				
	2005.06-			R		GCI17036	Inner Joint		25	26	34.9	434.5	108.5				
	2005.06-					GCO17051	Outer Joint		30	26	53.8	94.5	65.5	M			

		TRANSM	L/R	F/R		G-AP Ref.	PRODUCT	ABS	Technical Specifications										
									YEAR	A	B	C	H	L	P				
<b>FIAT CROMA (194)</b>																			
1.9 D Multijet (100 kW)	2005.12-				Estate Engine 939A8.000	GC099023	Outer Joint		30	26	53.8	94.5	65.5	M					
1.9 D Multijet (110 kW)	2005.06-		AT	L		GCI21016	Inner Joint		27	26	35	78.5	112						
	2005.06-			L		GCI17035	Inner Joint		25	26	34.9	57.5	114.5						
	2005.06-		AT	R		GCI17043	Inner Joint		27	26	35	448.5	107						
	2005.06-			R		GCI17036	Inner Joint		25	26	34.9	434.5	108.5						
	2005.06-					GC017051	Outer Joint		30	26	53.8	94.5	65.5	M					
	2005.08-		MT		F	Estate Engine 939A2.000	GC017051	Outer Joint		30	26	53.8	94.5	65.5	M				
	2005.08-					Estate Engine 939A2.000	GC099023	Outer Joint		30	26	53.8	94.5	65.5	M				
1.9 D Multijet (85 kW)	2005.06-			L		GCI17035	Inner Joint		25	26	34.9	57.5	114.5						
	2005.06-			R		GCI17036	Inner Joint		25	26	34.9	434.5	108.5						
	2005.06-				Estate Engine 939A7.000	GC099023	Outer Joint		30	26	53.8	94.5	65.5	M					
	2005.06-					GC017051	Outer Joint		30	26	53.8	94.5	65.5	M					
1.9 D Multijet (88 kW)	2005.06-			L		GCI17035	Inner Joint		25	26	34.9	57.5	114.5						
	2005.06-			R		GCI17036	Inner Joint		25	26	34.9	434.5	108.5						
	2005.06-					GC017051	Outer Joint		30	26	53.8	94.5	65.5	M					
	2005.08-		MT		F	Estate Engine 939A1.000	GC017051	Outer Joint		30	26	53.8	94.5	65.5	M				
	2005.08-				Estate Engine 939A1.000	GC099023	Outer Joint		30	26	53.8	94.5	65.5	M					
2.2 16V (108 kW)	2005.06-2007.06			L		GCI21011	Inner Joint		34	25	35	78	64						
	2005.06-					GC017007	Outer Joint		30	25	52.5	105	62	O					
	2005.08-			F	Estate Engine 194A1.000	GC017007	Outer Joint		30	25	52.5	105	62	O					
2.4 D Multijet (147 kW)	2005.06-			L		GCI21016	Inner Joint		27	26	35	78.5	112						
	2005.06-					GC017051	Outer Joint		30	26	53.8	94.5	65.5	M					
	2005.08-		MT		F	Estate Engine 939A3.000	GC017051	Outer Joint		30	26	53.8	94.5	65.5	M				
	2005.08-				Estate Engine 939A3.000	GC099023	Outer Joint		30	26	53.8	94.5	65.5	M					
<b>DELTA III (844)</b>																			
1.6 D Multijet (88 kW)	2008.09-			R	w/o Selespeed	GCI17006	Inner Joint		25	26	29.8	377	108						
<b>DOBLO</b>																			
1.3 MJT	2005-			F		GCI99008	Inner Joint		24	24	29.7	86.5	93						
	2005-			L	F	GDS17013	Drive Shaft		25	35.6	51	90	501						
	2005-			R	F	GDS17014	Drive Shaft		25	35.6	51	90	524						
	2010-			L	F	GCI17025	Inner Joint		24	24	29.7	86.5	93						
	2010-			L	F	GDS17068	Drive Shaft		25	39.2	51	84.5	492						
	2010-			L	F	GDS17078	Drive Shaft		25	24	51	84.5	602						
	2010-			L/R	F	GC099316	Outer Joint		25	25	51	84.5	61	M					
	2010-			R	F	GCI17026	Inner Joint		24	24	29.7	379	100.5						
	2010-			R	F	GDS17069	Drive Shaft		25	39.2	51	84.5	559						
	2010-			R	F	GDS17079	Drive Shaft		25	24	51	84.5	970						
1.4	2005-			L	F	GDS17102	Drive Shaft		22	22	51	89.5	636						
	2005-			R	F	GDS17113	Drive Shaft		22	22	51	89.5	930.5						
1.6 MJT	2010-			R	F	GDS17081	Drive Shaft		25	25	51	84.5	966.5						
	2010-			L	F	GDS17067	Drive Shaft		25	27.35	51	84.5	500						
	2010-			L	F	GCI17031	Inner Joint		25	26	32	59	110.5						
	2010-			L	F	GDS17076	Drive Shaft		25	25	51	84.5	596						
	2010-			L	F	GC017030	Outer Joint		25	26	51	84.5	64.5	M					
1.8 8V						GCI17018	Inner Joint			25		32							
	2002-2006					GDS17031	Drive Shaft						336						
	2002-2006					GCI17018	Inner Joint			25		32							
1.9 JTD	2001-			L	F	GDS17013	Drive Shaft		25	35.6	51	90	501						
	2001-			R	F	GDS17014	Drive Shaft		25	35.6	51	90	524						
	2005-				F	GCI99008	Inner Joint		24	24	29.7	86.5	93						
<b>DOBLO (119)</b>																			
1.2 (48 kW)	2001.03-			F	MPV Engine 223A5.000	GC082018	Outer Joint		22	22	51	89.5	57	M					
	2001.03-		MT	L	F	MPV Engine 223A5.000	GDS41006	Drive Shaft		22	31.95	51	89.5	618					
1.3 D Multijet (62 kW)	2005.10-			F	MPV Engine 223A9.000	GC082018	Outer Joint		22	22	51	89.5	57	M					
	2005.10-			L	F	MPV Engine 223A9.000	GDS17017	Drive Shaft		25	24	51	90	611					
	2005.10-			R	F	MPV Engine 223A9.000	GDS17019	Drive Shaft		25	24	51	90	928					
	2005.10-			L	F	MPV Engine 223A9.000	GCI99008	Inner Joint		24	24	29.7	86.5	93					
	2005.10-			R	F	MPV Engine 223A9.000	GCI17015	Inner Joint		24	24	29.7	379	100.5					
1.4 (57 kW)	2005.12-			F	MPV Engine 350A1.000	GC082018	Outer Joint		22	22	51	89.5	57	M					
	2005.12-				MPV Engine 350A1.000	GCI17027	Inner Joint		22	22	36	61.5	93.5						
1.6 16V (76 kW)	2001.10-			F	MPV Engine 182B6.000	GC082018	Outer Joint		22	22	51	89.5	57	M					



		TRANSM	L/R	F/R		G-AP Ref.	PRODUCT	ABS	Technical Specifications						
									YEAR	A	B	C	H	L	P
<b>FIAT</b>															
<b>DOBLO (119)</b>															
1.6 Natural Power (76 kW)	2002.09-			F	MPV Engine 182B6.000	GC082018	Outer Joint		22	22	51	89.5	57	M	
1.9 D (46 kW)	2001.03-			F	MPV Engine 223A6.000	GC082018	Outer Joint		22	22	51	89.5	57	M	
	2001.03-		MT	L	F	MPV Engine 223A6.000	GDS41006	Drive Shaft	22	31.95	51	89.5	618		
	2001.03-		MT	R	F	MPV Engine 223A6.000	GDS41007	Drive Shaft	22	31.95	51	89.5	932		
1.9 D Multijet (88 kW)	2005.12-			F	MPV Engine 186A9.000	GC017031	Outer Joint		25	24	51	90	62	M	
	2005.12-			L	F	MPV Engine 186A9.000	GDS17017	Drive Shaft	25	24	51	90	611		
	2005.12-			R	F	MPV Engine 186A9.000	GDS17019	Drive Shaft	25	24	51	90	928		
	2005.12-			L	F	MPV Engine 186A9.000	GCI99008	Inner Joint	24	24	29.7	86.5	93		
	2005.12-			R	F	MPV Engine 186A9.000	GCI17015	Inner Joint	24	24	29.7	379	100.5		
1.9 JTD (74 kW)	2001.10-			F	MPV Engine 182B9.000/223B2.000	GC017031	Outer Joint		25	24	51	90	62	M	
	2001.10-			L	F	MPV Engine 182B9.000/223B2.000	GDS17017	Drive Shaft	25	24	51	90	611		
	2001.10-			R	F	MPV Engine 182B9.000/223B2.000	GDS17019	Drive Shaft	25	24	51	90	928		
	2001.10-			L	F	MPV Engine 182B9.000/223B2.000	GCI99008	Inner Joint	24	24	29.7	86.5	93		
	2001.10-			R	F	MPV Engine 182B9.000/223B2.000	GCI17015	Inner Joint	24	24	29.7	379	100.5		
1.9 JTD (77 kW)	2004.11-	2005.11		F	MPV Engine 223A7.000/223B1.000	GC017031	Outer Joint		25	24	51	90	62	M	
	2004.11-	2005.11		L	F	MPV Engine 223A7.000/223B1.000	GDS17017	Drive Shaft	25	24	51	90	611		
	2004.11-	2005.11		L	F	MPV Engine 223A7.000/223B1.000	GCI99008	Inner Joint	24	24	29.7	86.5	93		
	2004.11-	2005.11		R	F	MPV Engine 223A7.000/223B1.000	GDS17019	Drive Shaft	25	24	51	90	928		
	2004.11-	2005.11		R	F	MPV Engine 223A7.000/223B1.000	GCI17015	Inner Joint	24	24	29.7	379	100.5		
<b>DOBLO (152, 263)</b>															
1.6 D Multijet (66 kW)	2010.02-		MT	L	F	MPV Engine 263A4.000	GDS17152	Drive Shaft	27	25	59	84.5	596		
	2010.02-		MT	R	F	MPV Engine 263A4.000	GDS17153	Drive Shaft	27	25	59	84.5	967		
	2010.02-		MT	R	F	MPV Engine 263A4.000	GCI18100	Inner Joint	25	26	29.7	434	108		
1.6 D Multijet (77 kW)	2010.02-			F	MPV Engine 198A3.000	GC017030	Outer Joint		25	26	51	84.5	64.5	M	
	2010.02-		MT	L	F	MPV Engine 198A3.000	GDS17152	Drive Shaft	27	25	59	84.5	596		
	2010.02-		MT	R	F	MPV Engine 198A3.000	GDS17153	Drive Shaft	27	25	59	84.5	967		
	2010.02-		MT	R	F	MPV Engine 198A3.000	GCI18100	Inner Joint	25	26	29.7	434	108		
<b>DOBLO (263)</b>															
1.6 D Multijet (66 kW)	2010.02-		MT	L	F	Box Body / Estate Engine 263A4.000	GDS17152	Drive Shaft	27	25	59	84.5	596		
	2010.02-		MT	L	F	Platform/Chassis Engine 263A4.000	GDS17152	Drive Shaft	27	25	59	84.5	596		
	2010.02-		MT	R	F	Box Body / Estate Engine 263A4.000	GDS17153	Drive Shaft	27	25	59	84.5	967		
	2010.02-		MT	R	F	Box Body / Estate Engine 263A4.000	GCI18100	Inner Joint	25	26	29.7	434	108		
	2010.02-		MT	R	F	Platform/Chassis Engine 263A4.000	GDS17153	Drive Shaft	27	25	59	84.5	967		
	2010.02-		MT	R	F	Platform/Chassis Engine 263A4.000	GCI18100	Inner Joint	25	26	29.7	434	108		
1.6 D Multijet (74 kW)	2010.02-		MT		F	Box Body / Estate Engine 263A3.000	GC017030	Outer Joint	25	26	51	84.5	64.5	M	
	2010.02-		MT	L	F	Box Body / Estate Engine 263A3.000	GDS17152	Drive Shaft	27	25	59	84.5	596		
	2010.02-		MT	R	F	Box Body / Estate Engine 263A3.000	GDS17153	Drive Shaft	27	25	59	84.5	967		
	2010.02-		MT	R	F	Box Body / Estate Engine 263A3.000	GCI18100	Inner Joint	25	26	29.7	434	108		
	2011.02-		MT	L	F	Platform/Chassis Engine 263A3.000	GDS17152	Drive Shaft	27	25	59	84.5	596		
	2011.02-		MT	R	F	Platform/Chassis Engine 263A3.000	GDS17153	Drive Shaft	27	25	59	84.5	967		
	2011.02-		MT	R	F	Platform/Chassis Engine 263A3.000	GCI18100	Inner Joint	25	26	29.7	434	108		
1.6 D Multijet (77 kW)	2010.02-		MT	L	F	Box Body / Estate Engine 198A3.000	GDS17152	Drive Shaft	27	25	59	84.5	596		
	2010.02-		MT	L	F	Platform/Chassis Engine 198A3.000	GDS17152	Drive Shaft	27	25	59	84.5	596		
	2010.02-		MT	R	F	Box Body / Estate Engine 198A3.000	GDS17153	Drive Shaft	27	25	59	84.5	967		
	2010.02-		MT	R	F	Box Body / Estate Engine 198A3.000	GCI18100	Inner Joint	25	26	29.7	434	108		
	2010.02-		MT	R	F	Platform/Chassis Engine 198A3.000	GDS17153	Drive Shaft	27	25	59	84.5	967		
	2010.02-		MT	R	F	Platform/Chassis Engine 198A3.000	GCI18100	Inner Joint	25	26	29.7	434	108		
<b>DOBLO ADVENTURE</b>															
1.8 8V						GCI17018	Inner Joint			25		32			
<b>DOBLO CARGO (223)</b>															
1.2 (48 kW)	2001.03-			F	Box Engine 223A5.000	GC082018	Outer Joint		22	22	51	89.5	57	M	
	2001.03-		MT	L	F	Box Engine 223A5.000	GDS41006	Drive Shaft	22	31.95	51	89.5	618		
	2001.03-					Box Engine 223A5.000	GCI17027	Inner Joint	22	22	36	61.5	93.5		
1.3 D Multijet (55 kW)	2005.10-	2010.01		F	Box Engine 199A2.000	GC082018	Outer Joint		22	22	51	89.5	57	M	
	2005.10-	2010.01		L	F	Box Engine 199A2.000	GDS17017	Drive Shaft	25	24	51	90	611		
	2005.10-	2010.01		L	F	Box Engine 199A2.000	GCI99008	Inner Joint	24	24	29.7	86.5	93		
	2005.10-	2010.01		R	F	Box Engine 199A2.000	GDS17019	Drive Shaft	25	24	51	90	928		
	2005.10-	2010.01		R	F	Box Engine 199A2.000	GCI17015	Inner Joint	24	24	29.7	379	100.5		
1.3 JTD 16V (51 kW)	2004.02-	2006.01		F	Box Engine 188A9.000/188A8.000	GC017031	Outer Joint		25	24	51	90	62	M	
	2004.02-	2006.01		L	F	Box Engine 188A9.000/188A8.000	GDS17017	Drive Shaft	25	24	51	90	611		
	2004.02-	2006.01		L	F	Box Engine 188A9.000/188A8.000	GCI99008	Inner Joint	24	24	29.7	86.5	93		
	2004.02-	2006.01		R	F	Box Engine 188A9.000/188A8.000	GDS17019	Drive Shaft	25	24	51	90	928		





		TRANSM	L/R	F/R		G-AP Ref.	PRODUCT	ABS	Technical Specifications									
									YEAR	A	B	C	H	L	P			
<b>FIAT</b>																		
<b>DOBLO CARGO (223)</b>																		
1.3 JTD 16V (51 kW)	2004.02-	2006.01		R	F	Box Engine 188A9.000/188A8.000	GCI17015	Inner Joint		24	24	29.7	379	100.5				
1.4 (57 kW)	2005.10-				F	Box Engine 350A1.000	GC082018	Outer Joint		22	22	51	89.5	57	M			
	2005.10-					Box Engine 350A1.000	GCI17027	Inner Joint		22	22	36	61.5	93.5				
1.6 16V (76 kW)	2001.10-				F	Box Engine 182B6.000	GC082018	Outer Joint		22	22	51	89.5	57	M			
	2001.10-					Box Engine 182B6.000	GCI17027	Inner Joint		22	22	36	61.5	93.5				
1.6 Natural Power (76 kW)	2002.09-				F	Box Engine 182B6.000	GC082018	Outer Joint		22	22	51	89.5	57	M			
	2002.09-					Box Engine 182B6.000	GCI17027	Inner Joint		22	22	36	61.5	93.5				
1.9 D (46 kW)	2001.03-				F	Box Engine 223A6.000	GC082018	Outer Joint		22	22	51	89.5	57	M			
	2001.03-		MT	L	F	Box Engine 223A6.000	GDS41006	Drive Shaft		22	31.95	51	89.5	618				
	2001.03-		MT	R	F	Box Engine 223A6.000	GDS41007	Drive Shaft		22	31.95	51	89.5	932				
1.9 JTD (74 kW)	2001.10-				F	Box Engine 182B9.000	GC017031	Outer Joint		25	24	51	90	62	M			
	2001.10-			L	F	Box Engine 182B9.000	GDS17017	Drive Shaft		25	24	51	90	611				
	2001.10-			R	F	Box Engine 182B9.000	GDS17019	Drive Shaft		25	24	51	90	928				
	2001.10-			L	F	Box Engine 182B9.000	GCI99008	Inner Joint		24	24	29.7	86.5	93				
	2001.10-			R	F	Box Engine 182B9.000	GCI17015	Inner Joint		24	24	29.7	379	100.5				
1.9 JTD (77 kW)	2003.07-				F	Box Engine 223A7.000/223B1.000	GC017031	Outer Joint		25	24	51	90	62	M			
	2003.07-			L	F	Box Engine 223A7.000/223B1.000	GDS17017	Drive Shaft		25	24	51	90	611				
	2003.07-			R	F	Box Engine 223A7.000/223B1.000	GDS17019	Drive Shaft		25	24	51	90	928				
	2003.07-			L	F	Box Engine 223A7.000/223B1.000	GCI99008	Inner Joint		24	24	29.7	86.5	93				
	2003.07-			R	F	Box Engine 223A7.000/223B1.000	GCI17015	Inner Joint		24	24	29.7	379	100.5				
<b>DOBLO I (119)</b>																		
1.9 JTD (74 kW)	2005-			L			GCI99008	Inner Joint		24	24	29.7	86.5	93				
1.9 JTD (77 kW)	2005-			L			GCI99008	Inner Joint		24	24	29.7	86.5	93				
13 MTJ (62 kW)	2005-			L			GCI99008	Inner Joint		24	24	29.7	86.5	93				
13 MTJ 16V (55 kW)	2005-			L			GCI99008	Inner Joint		24	24	29.7	86.5	93				
<b>DOBLO I (223)</b>																		
1.3 D Multijet (62 kW)	2005.10-			L			GCI99008	Inner Joint		24	24	29.7	86.5	93				
	2005.10-			R			GCI17015	Inner Joint		24	24	29.7	379	100.5				
1.9 D Multijet (88 kW)	2005.10-			L			GCI99008	Inner Joint		24	24	29.7	86.5	93				
	2005.10-			R			GCI17015	Inner Joint		24	24	29.7	379	100.5				
1.9 JTD (74 kW)	2001.03-	2003.10		L			GCI99008	Inner Joint		24	24	29.7	86.5	93				
	2001.03-	2003.10		R			GCI17015	Inner Joint		24	24	29.7	379	100.5				
1.9 JTD (77 kW)	2001.03-	2003.10		L			GCI99008	Inner Joint		24	24	29.7	86.5	93				
	2001.03-	2003.10		R			GCI17015	Inner Joint		24	24	29.7	379	100.5				
<b>DOBLO II (119)</b>																		
1.3 MTJ (62 kW)	2005-			R			GCI17015	Inner Joint		24	24	29.7	379	100.5				
1.3 MTJ 16V (55 kW)	2005-			R			GCI17015	Inner Joint		24	24	29.7	379	100.5				
1.9 JTD (74 kW)	2005-			R			GCI17015	Inner Joint		24	24	29.7	379	100.5				
1.9 JTD (77 kW)	2005-			R			GCI17015	Inner Joint		24	24	29.7	379	100.5				
<b>DOBLO III (152)</b>																		
1.3 D Multijet (66 kW)	2010.02-			L			GCI17025	Inner Joint		24	24	29.7	86.5	93				
	2010.02-			R			GCI17026	Inner Joint		24	24	29.7	379	100.5				
1.4 (70 kW)	2010.02-						GCI17027	Inner Joint		22	22	36	61.5	93.5				
1.4 Natural Power (88 kW)	2010.02-			L			GCI17031	Inner Joint		25	26	32	59	110.5				
1.6 D Multijet (66 kW)	2010.01-			L			GCI17031	Inner Joint		25	26	32	59	110.5				
1.6 D Multijet (77 kW)	2010.01-			L			GCI17031	Inner Joint		25	26	32	59	110.5				
<b>DOBLO III (223)</b>																		
1.4 (70 kW)	2010.02-						GC017026	Outer Joint		25	22	51	84	57	M			
1.6 D Multijet (66 kW)	2010.01-		MT				GC017030	Outer Joint		25	26	51	84.5	64.5	M			
1.6 D Multijet (77 kW)	2010.01-		MT				GC017030	Outer Joint		25	26	51	84.5	64.5	M			
<b>DOBLO MAXI</b>																		
1.6 MJT	2010-			L	F		GDS17106	Drive Shaft		27	43.2	59	84.5	499.5				
<b>DOBLOII (119)</b>																		
1.4 MPI (55 kW)	2005-						GCI17027	Inner Joint		22	22	36	61.5	93.5				
1.6 16V (76 kW)	2005-						GCI17027	Inner Joint		22	22	36	61.5	93.5				
<b>DUCATO</b>																		
-	2006-						GC010094	Outer Joint	54T	28	27	63.3	116	66.5	I			
<b>DUCATO (230)</b>																		
1.9 D (50 kW)	1998.04-	2002.04	MT		F	Bus Engine D9B/D9B(XUD9A)/DJY	GC010013	Outer Joint	54T	28	39	63	112.5	63	I			
	1998.04-	2002.04	MT		F	Bus Engine D9B/D9B(XUD9A)/DJY	GC010050	Outer Joint		35	45	70	117	73	I			
	1998.04-	2002.04	MT		F	Bus Engine D9B/D9B(XUD9A)/DJY	GC010012	Outer Joint		28	39	63	112.5	63	I			
	1998.04-	2002.04	MT		F	Bus Engine D9B/D9B(XUD9A)/DJY	GC010011	Outer Joint	54T	35	45	70	117	73	I			



		YEAR	TRANSM	L/R	F/R		G-AP Ref.	PRODUCT	ABS	Technical Specifications					
										A	B	C	H	L	P
<b>FIAT</b> <b>DUCATO (230)</b> 1.9 D (50 kW)	1998.04-	2002.04	MT		F	Platform/Chassis Engine DJY	GC010013	Outer Joint	54T	28	39	63	112.5	63	I
	1998.04-	2002.04	MT		F	Platform/Chassis Engine DJY	GC010050	Outer Joint		35	45	70	117	73	I
	1998.04-	2002.04	MT		F	Platform/Chassis Engine DJY	GC010012	Outer Joint		28	39	63	112.5	63	I
	1998.04-	2002.04	MT		F	Platform/Chassis Engine DJY	GC010011	Outer Joint	54T	35	45	70	117	73	I
	1998.04-	2002.04	MT	L	F	Bus Engine D9B/D9B(XUD9A)/DJY	GDS10067	Drive Shaft		35	41	70	117	762	
	1998.04-	2002.04	MT	L	F	Bus Engine D9B/D9B(XUD9A)/DJY	GDS10035	Drive Shaft	54T	28	41	63	112.5	757.5	
	1998.04-	2002.04	MT	L	F	Bus Engine D9B/D9B(XUD9A)/DJY	GDS10102	Drive Shaft		28	41	63	112.5	757.5	
	1998.04-	2002.04	MT	L	F	Bus Engine D9B/D9B(XUD9A)/DJY	GDS10037	Drive Shaft	54T	28	37	63	112.5	771	
	1998.04-	2002.04	MT	L	F	Bus Engine D9B/D9B(XUD9A)/DJY	GDS10033	Drive Shaft	54T	35	41	70	117	762	
	1998.04-	2002.04	MT	L	F	Bus Engine D9B/D9B(XUD9A)/DJY	GDS10105	Drive Shaft		28	37	63	112.5	771	
	1998.04-	2002.04	MT	L	F	Platform/Chassis Engine DJY	GDS10067	Drive Shaft		35	41	70	117	762	
	1998.04-	2002.04	MT	L	F	Platform/Chassis Engine DJY	GDS10035	Drive Shaft	54T	28	41	63	112.5	757.5	
	1998.04-	2002.04	MT	L	F	Platform/Chassis Engine DJY	GDS10102	Drive Shaft		28	41	63	112.5	757.5	
	1998.04-	2002.04	MT	L	F	Platform/Chassis Engine DJY	GDS10037	Drive Shaft	54T	28	37	63	112.5	771	
	1998.04-	2002.04	MT	L	F	Platform/Chassis Engine DJY	GDS10033	Drive Shaft	54T	35	41	70	117	762	
	1998.04-	2002.04	MT	L	F	Platform/Chassis Engine DJY	GDS10105	Drive Shaft		28	37	63	112.5	771	
	1998.04-	2002.04	MT	R	F	Bus Engine D9B/D9B(XUD9A)/DJY	GDS10104	Drive Shaft	54T	28	37	63	112.5	1072	
	1998.04-	2002.04	MT	R	F	Bus Engine D9B/D9B(XUD9A)/DJY	GDS10032	Drive Shaft	54T	35	41	70	117	1085	
	1998.04-	2002.04	MT	R	F	Bus Engine D9B/D9B(XUD9A)/DJY	GDS10069	Drive Shaft		28	37	63	112.5	1072	
	1998.04-	2002.04	MT	R	F	Bus Engine D9B/D9B(XUD9A)/DJY	GDS10066	Drive Shaft		35	41	70	117	1085	
	1998.04-	2002.04	MT	R	F	Bus Engine D9B/D9B(XUD9A)/DJY	GDS10036	Drive Shaft	54T	28	41	63	112.5	1079	
	1998.04-	2002.04	MT	R	F	Bus Engine D9B/D9B(XUD9A)/DJY	GDS10103	Drive Shaft		28	41	63	112.5	1079	
	1998.04-	2002.04	MT	R	F	Platform/Chassis Engine DJY	GDS10104	Drive Shaft	54T	28	37	63	112.5	1072	
	1998.04-	2002.04	MT	R	F	Platform/Chassis Engine DJY	GDS10032	Drive Shaft	54T	35	41	70	117	1085	
	1998.04-	2002.04	MT	R	F	Platform/Chassis Engine DJY	GDS10069	Drive Shaft		28	37	63	112.5	1072	
	1998.04-	2002.04	MT	R	F	Platform/Chassis Engine DJY	GDS10066	Drive Shaft		35	41	70	117	1085	
	1998.04-	2002.04	MT	R	F	Platform/Chassis Engine DJY	GDS10036	Drive Shaft	54T	28	41	63	112.5	1079	
	1998.04-	2002.04	MT	R	F	Platform/Chassis Engine DJY	GDS10103	Drive Shaft		28	41	63	112.5	1079	
1.9 D (51 kW)	1994.03-	2002.04	MT		F	Platform/Chassis Engine 230A2.000	GC010013	Outer Joint	54T	28	39	63	112.5	63	I
	1994.03-	2002.04	MT		F	Platform/Chassis Engine 230A2.000	GC010050	Outer Joint		35	45	70	117	73	I
	1994.03-	2002.04	MT		F	Platform/Chassis Engine 230A2.000	GC010012	Outer Joint		28	39	63	112.5	63	I
	1994.03-	2002.04	MT		F	Platform/Chassis Engine 230A2.000	GC010011	Outer Joint	54T	35	45	70	117	73	I
	1994.03-	2002.04	MT	L	F	Platform/Chassis Engine 230A2.000	GDS10067	Drive Shaft		35	41	70	117	762	
	1994.03-	2002.04	MT	L	F	Platform/Chassis Engine 230A2.000	GDS10035	Drive Shaft	54T	28	41	63	112.5	757.5	
	1994.03-	2002.04	MT	L	F	Platform/Chassis Engine 230A2.000	GDS10102	Drive Shaft		28	41	63	112.5	757.5	
	1994.03-	2002.04	MT	L	F	Platform/Chassis Engine 230A2.000	GDS10037	Drive Shaft	54T	28	37	63	112.5	771	
	1994.03-	2002.04	MT	L	F	Platform/Chassis Engine 230A2.000	GDS10033	Drive Shaft	54T	35	41	70	117	762	
	1994.03-	2002.04	MT	L	F	Platform/Chassis Engine 230A2.000	GDS10105	Drive Shaft		28	37	63	112.5	771	
	1994.03-	2002.04	MT	R	F	Platform/Chassis Engine 230A2.000	GDS10104	Drive Shaft	54T	28	37	63	112.5	1072	
	1994.03-	2002.04	MT	R	F	Platform/Chassis Engine 230A2.000	GDS10032	Drive Shaft	54T	35	41	70	117	1085	
	1994.03-	2002.04	MT	R	F	Platform/Chassis Engine 230A2.000	GDS10069	Drive Shaft		28	37	63	112.5	1072	
	1994.03-	2002.04	MT	R	F	Platform/Chassis Engine 230A2.000	GDS10066	Drive Shaft		35	41	70	117	1085	
	1994.03-	2002.04	MT	R	F	Platform/Chassis Engine 230A2.000	GDS10036	Drive Shaft	54T	28	41	63	112.5	1079	
	1994.03-	2002.04	MT	R	F	Platform/Chassis Engine 230A2.000	GDS10103	Drive Shaft		28	41	63	112.5	1079	
	1.9 D Combinato (51 kW)	1995.06-	2002.04	MT		F	Bus Engine 230A2.000	GC010013	Outer Joint	54T	28	39	63	112.5	63
1995.06-		2002.04	MT		F	Bus Engine 230A2.000	GC010050	Outer Joint		35	45	70	117	73	I
1995.06-		2002.04	MT		F	Bus Engine 230A2.000	GC010012	Outer Joint		28	39	63	112.5	63	I
1995.06-		2002.04	MT		F	Bus Engine 230A2.000	GC010011	Outer Joint	54T	35	45	70	117	73	I
1995.06-		2002.04	MT	L	F	Bus Engine 230A2.000	GDS10067	Drive Shaft		35	41	70	117	762	
1995.06-		2002.04	MT	L	F	Bus Engine 230A2.000	GDS10035	Drive Shaft	54T	28	41	63	112.5	757.5	
1995.06-		2002.04	MT	L	F	Bus Engine 230A2.000	GDS10102	Drive Shaft		28	41	63	112.5	757.5	
1995.06-		2002.04	MT	L	F	Bus Engine 230A2.000	GDS10037	Drive Shaft	54T	28	37	63	112.5	771	
1995.06-		2002.04	MT	L	F	Bus Engine 230A2.000	GDS10033	Drive Shaft	54T	35	41	70	117	762	
1995.06-		2002.04	MT	L	F	Bus Engine 230A2.000	GDS10105	Drive Shaft		28	37	63	112.5	771	
1995.06-		2002.04	MT	R	F	Bus Engine 230A2.000	GDS10104	Drive Shaft	54T	28	37	63	112.5	1072	
1995.06-		2002.04	MT	R	F	Bus Engine 230A2.000	GDS10032	Drive Shaft	54T	35	41	70	117	1085	
1995.06-		2002.04	MT	R	F	Bus Engine 230A2.000	GDS10069	Drive Shaft		28	37	63	112.5	1072	
1995.06-		2002.04	MT	R	F	Bus Engine 230A2.000	GDS10066	Drive Shaft		35	41	70	117	1085	
1995.06-		2002.04	MT	R	F	Bus Engine 230A2.000	GDS10036	Drive Shaft	54T	28	41	63	112.5	1079	
1995.06-		2002.04	MT	R	F	Bus Engine 230A2.000	GDS10103	Drive Shaft		28	41	63	112.5	1079	
1.9 TD (60 kW)		1994.03-	2002.04	MT		F	Platform/Chassis Engine 230A3.000	GC010013	Outer Joint	54T	28	39	63	112.5	63
	1994.03-	2002.04	MT		F	Platform/Chassis Engine 230A3.000	GC010050	Outer Joint		35	45	70	117	73	I
	1994.03-	2002.04	MT		F	Platform/Chassis Engine 230A3.000	GC010012	Outer Joint		28	39	63	112.5	63	I





		TRANSM	L/R	F/R		G-AP Ref.	PRODUCT	ABS	Technical Specifications					
									YEAR	A	B	C	H	L
<b>FIAT DUCATO (230)</b> 1.9 TD (60 kW)	1994.03-2002.04	MT		F	Platform/Chassis Engine 230A3.000	GC010011	Outer Joint	54T	35	45	70	117	73	I
	1994.03-2002.04	MT	L	F	Platform/Chassis Engine 230A3.000	GDS10067	Drive Shaft		35	41	70	117	762	
	1994.03-2002.04	MT	L	F	Platform/Chassis Engine 230A3.000	GDS10035	Drive Shaft	54T	28	41	63	112.5	757.5	
	1994.03-2002.04	MT	L	F	Platform/Chassis Engine 230A3.000	GDS10102	Drive Shaft		28	41	63	112.5	757.5	
	1994.03-2002.04	MT	L	F	Platform/Chassis Engine 230A3.000	GDS10037	Drive Shaft	54T	28	37	63	112.5	771	
	1994.03-2002.04	MT	L	F	Platform/Chassis Engine 230A3.000	GDS10033	Drive Shaft	54T	35	41	70	117	762	
	1994.03-2002.04	MT	L	F	Platform/Chassis Engine 230A3.000	GDS10105	Drive Shaft		28	37	63	112.5	771	
	1994.03-2002.04	MT	R	F	Platform/Chassis Engine 230A3.000	GDS10104	Drive Shaft	54T	28	37	63	112.5	1072	
	1994.03-2002.04	MT	R	F	Platform/Chassis Engine 230A3.000	GDS10032	Drive Shaft	54T	35	41	70	117	1085	
	1994.03-2002.04	MT	R	F	Platform/Chassis Engine 230A3.000	GDS10069	Drive Shaft		28	37	63	112.5	1072	
	1994.03-2002.04	MT	R	F	Platform/Chassis Engine 230A3.000	GDS10066	Drive Shaft		35	41	70	117	1085	
	1994.03-2002.04	MT	R	F	Platform/Chassis Engine 230A3.000	GDS10036	Drive Shaft	54T	28	41	63	112.5	1079	
	1994.03-2002.04	MT	R	F	Platform/Chassis Engine 230A3.000	GDS10103	Drive Shaft		28	41	63	112.5	1079	
1.9 TD (66 kW)	1998.04-2002.04	MT		F	Bus Engine DHX(XUD9TF/L)	GC010013	Outer Joint	54T	28	39	63	112.5	63	I
	1998.04-2002.04	MT		F	Bus Engine DHX(XUD9TF/L)	GC010050	Outer Joint		35	45	70	117	73	I
	1998.04-2002.04	MT		F	Bus Engine DHX(XUD9TF/L)	GC010012	Outer Joint		28	39	63	112.5	63	I
	1998.04-2002.04	MT		F	Bus Engine DHX(XUD9TF/L)	GC010011	Outer Joint	54T	35	45	70	117	73	I
	1998.04-2002.04	MT		F	Platform/Chassis Engine DHX(XUD9TF/L)	GC010013	Outer Joint	54T	28	39	63	112.5	63	I
	1998.04-2002.04	MT		F	Platform/Chassis Engine DHX(XUD9TF/L)	GC010050	Outer Joint		35	45	70	117	73	I
	1998.04-2002.04	MT		F	Platform/Chassis Engine DHX(XUD9TF/L)	GC010012	Outer Joint		28	39	63	112.5	63	I
	1998.04-2002.04	MT		F	Platform/Chassis Engine DHX(XUD9TF/L)	GC010011	Outer Joint	54T	35	45	70	117	73	I
	1998.04-2002.04	MT	L	F	Bus Engine DHX(XUD9TF/L)	GDS10067	Drive Shaft		35	41	70	117	762	
	1998.04-2002.04	MT	L	F	Bus Engine DHX(XUD9TF/L)	GDS10035	Drive Shaft	54T	28	41	63	112.5	757.5	
	1998.04-2002.04	MT	L	F	Bus Engine DHX(XUD9TF/L)	GDS10102	Drive Shaft		28	41	63	112.5	757.5	
	1998.04-2002.04	MT	L	F	Bus Engine DHX(XUD9TF/L)	GDS10037	Drive Shaft	54T	28	37	63	112.5	771	
	1998.04-2002.04	MT	L	F	Bus Engine DHX(XUD9TF/L)	GDS10033	Drive Shaft	54T	35	41	70	117	762	
	1998.04-2002.04	MT	L	F	Bus Engine DHX(XUD9TF/L)	GDS10105	Drive Shaft		28	37	63	112.5	771	
	1998.04-2002.04	MT	L	F	Platform/Chassis Engine DHX(XUD9TF/L)	GDS10067	Drive Shaft		35	41	70	117	762	
	1998.04-2002.04	MT	L	F	Platform/Chassis Engine DHX(XUD9TF/L)	GDS10035	Drive Shaft	54T	28	41	63	112.5	757.5	
	1998.04-2002.04	MT	L	F	Platform/Chassis Engine DHX(XUD9TF/L)	GDS10102	Drive Shaft		28	41	63	112.5	757.5	
	1998.04-2002.04	MT	L	F	Platform/Chassis Engine DHX(XUD9TF/L)	GDS10037	Drive Shaft	54T	28	37	63	112.5	771	
	1998.04-2002.04	MT	L	F	Platform/Chassis Engine DHX(XUD9TF/L)	GDS10033	Drive Shaft	54T	35	41	70	117	762	
	1998.04-2002.04	MT	L	F	Platform/Chassis Engine DHX(XUD9TF/L)	GDS10105	Drive Shaft		28	37	63	112.5	771	
	1998.04-2002.04	MT	R	F	Bus Engine DHX(XUD9TF/L)	GDS10104	Drive Shaft	54T	28	37	63	112.5	1072	
	1998.04-2002.04	MT	R	F	Bus Engine DHX(XUD9TF/L)	GDS10032	Drive Shaft	54T	35	41	70	117	1085	
	1998.04-2002.04	MT	R	F	Bus Engine DHX(XUD9TF/L)	GDS10069	Drive Shaft		28	37	63	112.5	1072	
	1998.04-2002.04	MT	R	F	Bus Engine DHX(XUD9TF/L)	GDS10066	Drive Shaft		35	41	70	117	1085	
	1998.04-2002.04	MT	R	F	Bus Engine DHX(XUD9TF/L)	GDS10036	Drive Shaft	54T	28	41	63	112.5	1079	
	1998.04-2002.04	MT	R	F	Bus Engine DHX(XUD9TF/L)	GDS10103	Drive Shaft		28	41	63	112.5	1079	
	1998.04-2002.04	MT	R	F	Platform/Chassis Engine DHX(XUD9TF/L)	GDS10104	Drive Shaft	54T	28	37	63	112.5	1072	
	1998.04-2002.04	MT	R	F	Platform/Chassis Engine DHX(XUD9TF/L)	GDS10032	Drive Shaft	54T	35	41	70	117	1085	
	1998.04-2002.04	MT	R	F	Platform/Chassis Engine DHX(XUD9TF/L)	GDS10069	Drive Shaft		28	37	63	112.5	1072	
	1998.04-2002.04	MT	R	F	Platform/Chassis Engine DHX(XUD9TF/L)	GDS10066	Drive Shaft		35	41	70	117	1085	
	1998.04-2002.04	MT	R	F	Platform/Chassis Engine DHX(XUD9TF/L)	GDS10036	Drive Shaft	54T	28	41	63	112.5	1079	
	1998.04-2002.04	MT	R	F	Platform/Chassis Engine DHX(XUD9TF/L)	GDS10103	Drive Shaft		28	41	63	112.5	1079	
	1.9 TD CAT (59 kW)	1994.08-2002.04	MT	L	F	Platform/Chassis Engine 230A4.000	GDS10067	Drive Shaft		35	41	70	117	762
1994.08-2002.04		MT	L	F	Platform/Chassis Engine 230A4.000	GDS10035	Drive Shaft	54T	28	41	63	112.5	757.5	
1994.08-2002.04		MT	L	F	Platform/Chassis Engine 230A4.000	GDS10102	Drive Shaft		28	41	63	112.5	757.5	
1994.08-2002.04		MT	L	F	Platform/Chassis Engine 230A4.000	GDS10037	Drive Shaft	54T	28	37	63	112.5	771	
1994.08-2002.04		MT	L	F	Platform/Chassis Engine 230A4.000	GDS10033	Drive Shaft	54T	35	41	70	117	762	
1994.08-2002.04		MT	L	F	Platform/Chassis Engine 230A4.000	GDS10105	Drive Shaft		28	37	63	112.5	771	
1994.08-2002.04		MT	R	F	Platform/Chassis Engine 230A4.000	GDS10104	Drive Shaft	54T	28	37	63	112.5	1072	
1994.08-2002.04		MT	R	F	Platform/Chassis Engine 230A4.000	GDS10032	Drive Shaft	54T	35	41	70	117	1085	
1994.08-2002.04		MT	R	F	Platform/Chassis Engine 230A4.000	GDS10069	Drive Shaft		28	37	63	112.5	1072	
1994.08-2002.04		MT	R	F	Platform/Chassis Engine 230A4.000	GDS10066	Drive Shaft		35	41	70	117	1085	
1994.08-2002.04		MT	R	F	Platform/Chassis Engine 230A4.000	GDS10036	Drive Shaft	54T	28	41	63	112.5	1079	
1994.08-2002.04		MT	R	F	Platform/Chassis Engine 230A4.000	GDS10103	Drive Shaft		28	41	63	112.5	1079	
1994.08-2002.04		MT		F	Platform/Chassis Engine 230A4.000	GC010013	Outer Joint	54T	28	39	63	112.5	63	I
1.9 TD Combinato (59 kW)	1994.08-2002.04	MT		F	Bus Engine 230A4.000	GC010013	Outer Joint	54T	28	39	63	112.5	63	I
	1994.08-2002.04	MT		F	Bus Engine 230A4.000	GC010050	Outer Joint		35	45	70	117	73	I





		TRANSM	L/R	F/R		G-AP Ref.	PRODUCT	ABS	Technical Specifications						
									YEAR	A	B	C	H	L	P
<b>FIAT</b>															
<b>DUCATO (230)</b>															
1.9 TD Combinato (59 kW)	1994.08-	2002.04	MT		F	Bus Engine 230A4.000	GCO10012	Outer Joint		28	39	63	112.5	63	I
	1994.08-	2002.04	MT		F	Bus Engine 230A4.000	GCO10011	Outer Joint	54T	35	45	70	117	73	I
	1994.08-	2002.04	MT	L	F	Bus Engine 230A4.000	GDS10067	Drive Shaft		35	41	70	117	762	
	1994.08-	2002.04	MT	L	F	Bus Engine 230A4.000	GDS10035	Drive Shaft	54T	28	41	63	112.5	757.5	
	1994.08-	2002.04	MT	L	F	Bus Engine 230A4.000	GDS10102	Drive Shaft		28	41	63	112.5	757.5	
	1994.08-	2002.04	MT	L	F	Bus Engine 230A4.000	GDS10037	Drive Shaft	54T	28	37	63	112.5	771	
	1994.08-	2002.04	MT	L	F	Bus Engine 230A4.000	GDS10033	Drive Shaft	54T	35	41	70	117	762	
	1994.08-	2002.04	MT	L	F	Bus Engine 230A4.000	GDS10105	Drive Shaft		28	37	63	112.5	771	
	1994.08-	2002.04	MT	R	F	Bus Engine 230A4.000	GDS10104	Drive Shaft	54T	28	37	63	112.5	1072	
	1994.08-	2002.04	MT	R	F	Bus Engine 230A4.000	GDS10032	Drive Shaft	54T	35	41	70	117	1085	
	1994.08-	2002.04	MT	R	F	Bus Engine 230A4.000	GDS10069	Drive Shaft		28	37	63	112.5	1072	
	1994.08-	2002.04	MT	R	F	Bus Engine 230A4.000	GDS10066	Drive Shaft		35	41	70	117	1085	
	1994.08-	2002.04	MT	R	F	Bus Engine 230A4.000	GDS10036	Drive Shaft	54T	28	41	63	112.5	1079	
	1994.08-	2002.04	MT	R	F	Bus Engine 230A4.000	GDS10103	Drive Shaft		28	41	63	112.5	1079	
1.9 TD Panorama/Combinato (60 kW)	1994.03-	2002.04	MT		F	Bus Engine 230A3.000	GCO10013	Outer Joint	54T	28	39	63	112.5	63	I
	1994.03-	2002.04	MT		F	Bus Engine 230A3.000	GCO10050	Outer Joint		35	45	70	117	73	I
	1994.03-	2002.04	MT		F	Bus Engine 230A3.000	GCO10012	Outer Joint		28	39	63	112.5	63	I
	1994.03-	2002.04	MT	L	F	Bus Engine 230A3.000	GDS10067	Drive Shaft	54T	35	41	70	117	762	
	1994.03-	2002.04	MT	L	F	Bus Engine 230A3.000	GDS10035	Drive Shaft	54T	28	41	63	112.5	757.5	
	1994.03-	2002.04	MT	L	F	Bus Engine 230A3.000	GDS10102	Drive Shaft		28	41	63	112.5	757.5	
	1994.03-	2002.04	MT	L	F	Bus Engine 230A3.000	GDS10037	Drive Shaft	54T	28	37	63	112.5	771	
	1994.03-	2002.04	MT	L	F	Bus Engine 230A3.000	GDS10033	Drive Shaft	54T	35	41	70	117	762	
	1994.03-	2002.04	MT	L	F	Bus Engine 230A3.000	GDS10105	Drive Shaft		28	37	63	112.5	771	
	1994.03-	2002.04	MT	R	F	Bus Engine 230A3.000	GDS10104	Drive Shaft	54T	28	37	63	112.5	1072	
	1994.03-	2002.04	MT	R	F	Bus Engine 230A3.000	GDS10032	Drive Shaft	54T	35	41	70	117	1085	
	1994.03-	2002.04	MT	R	F	Bus Engine 230A3.000	GDS10069	Drive Shaft		28	37	63	112.5	1072	
	1994.03-	2002.04	MT	R	F	Bus Engine 230A3.000	GDS10066	Drive Shaft		35	41	70	117	1085	
	1994.03-	2002.04	MT	R	F	Bus Engine 230A3.000	GDS10036	Drive Shaft	54T	28	41	63	112.5	1079	
1994.03-	2002.04	MT	R	F	Bus Engine 230A3.000	GDS10103	Drive Shaft		28	41	63	112.5	1079		
2.0 (80 kW)	1998.06-	2002.04	MT		F	Platform/Chassis Engine RFW	GCO10013	Outer Joint	54T	28	39	63	112.5	63	I
	1998.06-	2002.04	MT		F	Platform/Chassis Engine RFW	GCO10050	Outer Joint		35	45	70	117	73	I
	1998.06-	2002.04	MT		F	Platform/Chassis Engine RFW	GCO10012	Outer Joint		28	39	63	112.5	63	I
	1998.06-	2002.04	MT	L	F	Platform/Chassis Engine RFW	GDS10067	Drive Shaft	54T	35	41	70	117	762	
	1998.06-	2002.04	MT	L	F	Platform/Chassis Engine RFW	GDS10035	Drive Shaft	54T	28	41	63	112.5	757.5	
	1998.06-	2002.04	MT	L	F	Platform/Chassis Engine RFW	GDS10102	Drive Shaft		28	41	63	112.5	757.5	
	1998.06-	2002.04	MT	L	F	Platform/Chassis Engine RFW	GDS10037	Drive Shaft	54T	28	37	63	112.5	771	
	1998.06-	2002.04	MT	L	F	Platform/Chassis Engine RFW	GDS10033	Drive Shaft	54T	35	41	70	117	762	
	1998.06-	2002.04	MT	L	F	Platform/Chassis Engine RFW	GDS10105	Drive Shaft		28	37	63	112.5	771	
	1998.06-	2002.04	MT	R	F	Platform/Chassis Engine RFW	GDS10104	Drive Shaft	54T	28	37	63	112.5	1072	
	1998.06-	2002.04	MT	R	F	Platform/Chassis Engine RFW	GDS10032	Drive Shaft	54T	35	41	70	117	1085	
	1998.06-	2002.04	MT	R	F	Platform/Chassis Engine RFW	GDS10069	Drive Shaft		28	37	63	112.5	1072	
	1998.06-	2002.04	MT	R	F	Platform/Chassis Engine RFW	GDS10066	Drive Shaft		35	41	70	117	1085	
	1998.06-	2002.04	MT	R	F	Platform/Chassis Engine RFW	GDS10036	Drive Shaft	54T	28	41	63	112.5	1079	
1998.06-	2002.04	MT	R	F	Platform/Chassis Engine RFW	GDS10103	Drive Shaft		28	41	63	112.5	1079		
2.0 Panorama/Combinato (80 kW)	1994.03-	2002.04	MT		F	Bus Engine RFW	GCO10013	Outer Joint	54T	28	39	63	112.5	63	I
	1994.03-	2002.04	MT		F	Bus Engine RFW	GCO10050	Outer Joint		35	45	70	117	73	I
	1994.03-	2002.04	MT		F	Bus Engine RFW	GCO10012	Outer Joint		28	39	63	112.5	63	I
	1994.03-	2002.04	MT	L	F	Bus Engine RFW	GDS10067	Drive Shaft	54T	35	41	70	117	762	
	1994.03-	2002.04	MT	L	F	Bus Engine RFW	GDS10035	Drive Shaft	54T	28	41	63	112.5	757.5	
	1994.03-	2002.04	MT	L	F	Bus Engine RFW	GDS10102	Drive Shaft		28	41	63	112.5	757.5	
	1994.03-	2002.04	MT	L	F	Bus Engine RFW	GDS10037	Drive Shaft	54T	28	37	63	112.5	771	
	1994.03-	2002.04	MT	L	F	Bus Engine RFW	GDS10033	Drive Shaft	54T	35	41	70	117	762	
	1994.03-	2002.04	MT	L	F	Bus Engine RFW	GDS10105	Drive Shaft		28	37	63	112.5	771	
	1994.03-	2002.04	MT	R	F	Bus Engine RFW	GDS10104	Drive Shaft	54T	28	37	63	112.5	1072	
	1994.03-	2002.04	MT	R	F	Bus Engine RFW	GDS10032	Drive Shaft	54T	35	41	70	117	1085	
	1994.03-	2002.04	MT	R	F	Bus Engine RFW	GDS10069	Drive Shaft		28	37	63	112.5	1072	
	1994.03-	2002.04	MT	R	F	Bus Engine RFW	GDS10066	Drive Shaft		35	41	70	117	1085	
	1994.03-	2002.04	MT	R	F	Bus Engine RFW	GDS10036	Drive Shaft	54T	28	41	63	112.5	1079	
1994.03-	2002.04	MT	R	F	Bus Engine RFW	GDS10103	Drive Shaft		28	41	63	112.5	1079		



		TRANSM	L/R	F/R		G-AP Ref.	PRODUCT	ABS	Technical Specifications						
									YEAR	A	B	C	H	L	P
<b>FIAT</b>															
<b>DUCATO (230)</b>															
2.5 D (62 kW)	1994.03-2002.04	MT		F	Platform/Chassis Engine 8140.67	GCO10013	Outer Joint	54T	28	39	63	112.5	63	I	
	1994.03-2002.04	MT		F	Platform/Chassis Engine 8140.67	GCO10050	Outer Joint		35	45	70	117	73	I	
	1994.03-2002.04	MT		F	Platform/Chassis Engine 8140.67	GCO10012	Outer Joint		28	39	63	112.5	63	I	
	1994.03-2002.04	MT		F	Platform/Chassis Engine 8140.67	GCO10011	Outer Joint	54T	35	45	70	117	73	I	
	1994.03-2002.04	MT	L	F	Platform/Chassis Engine 8140.67	GDS10067	Drive Shaft		35	41	70	117	762		
	1994.03-2002.04	MT	L	F	Platform/Chassis Engine 8140.67	GDS10035	Drive Shaft	54T	28	41	63	112.5	757.5		
	1994.03-2002.04	MT	L	F	Platform/Chassis Engine 8140.67	GDS10102	Drive Shaft		28	41	63	112.5	757.5		
	1994.03-2002.04	MT	L	F	Platform/Chassis Engine 8140.67	GDS10037	Drive Shaft	54T	28	37	63	112.5	771		
	1994.03-2002.04	MT	L	F	Platform/Chassis Engine 8140.67	GDS10033	Drive Shaft	54T	35	41	70	117	762		
	1994.03-2002.04	MT	L	F	Platform/Chassis Engine 8140.67	GDS10105	Drive Shaft		28	37	63	112.5	771		
	1994.03-2002.04	MT	R	F	Platform/Chassis Engine 8140.67	GDS10104	Drive Shaft	54T	28	37	63	112.5	1072		
	1994.03-2002.04	MT	R	F	Platform/Chassis Engine 8140.67	GDS10032	Drive Shaft	54T	35	41	70	117	1085		
	1994.03-2002.04	MT	R	F	Platform/Chassis Engine 8140.67	GDS10069	Drive Shaft		28	37	63	112.5	1072		
	1994.03-2002.04	MT	R	F	Platform/Chassis Engine 8140.67	GDS10066	Drive Shaft		35	41	70	117	1085		
	2.5 D 4x4 (62 kW)	1994.03-2002.04	MT		F	Platform/Chassis Engine 8140.67	GCO10013	Outer Joint	54T	28	39	63	112.5	63	I
1994.03-2002.04		MT		F	Platform/Chassis Engine 8140.67	GCO10050	Outer Joint		35	45	70	117	73	I	
1994.03-2002.04		MT		F	Platform/Chassis Engine 8140.67	GCO10012	Outer Joint		28	39	63	112.5	63	I	
1994.03-2002.04		MT		F	Platform/Chassis Engine 8140.67	GCO10011	Outer Joint	54T	35	45	70	117	73	I	
1994.03-2002.04		MT	L	F	Platform/Chassis Engine 8140.67	GDS10067	Drive Shaft		35	41	70	117	762		
1994.03-2002.04		MT	L	F	Platform/Chassis Engine 8140.67	GDS10035	Drive Shaft	54T	28	41	63	112.5	757.5		
1994.03-2002.04		MT	L	F	Platform/Chassis Engine 8140.67	GDS10102	Drive Shaft		28	41	63	112.5	757.5		
1994.03-2002.04		MT	L	F	Platform/Chassis Engine 8140.67	GDS10037	Drive Shaft	54T	28	37	63	112.5	771		
1994.03-2002.04		MT	L	F	Platform/Chassis Engine 8140.67	GDS10033	Drive Shaft	54T	35	41	70	117	762		
1994.03-2002.04		MT	L	F	Platform/Chassis Engine 8140.67	GDS10105	Drive Shaft		28	37	63	112.5	771		
1994.03-2002.04		MT	R	F	Platform/Chassis Engine 8140.67	GDS10104	Drive Shaft	54T	28	37	63	112.5	1072		
1994.03-2002.04		MT	R	F	Platform/Chassis Engine 8140.67	GDS10032	Drive Shaft	54T	35	41	70	117	1085		
1994.03-2002.04		MT	R	F	Platform/Chassis Engine 8140.67	GDS10069	Drive Shaft		28	37	63	112.5	1072		
1994.03-2002.04		MT	R	F	Platform/Chassis Engine 8140.67	GDS10066	Drive Shaft		35	41	70	117	1085		
2.5 D Combinato (62 kW)		1994.08-2002.04	MT		F	Bus Engine 8140.67	GCO10013	Outer Joint	54T	28	39	63	112.5	63	I
	1994.08-2002.04	MT		F	Bus Engine 8140.67	GCO10050	Outer Joint		35	45	70	117	73	I	
	1994.08-2002.04	MT		F	Bus Engine 8140.67	GCO10012	Outer Joint		28	39	63	112.5	63	I	
	1994.08-2002.04	MT		F	Bus Engine 8140.67	GCO10011	Outer Joint	54T	35	45	70	117	73	I	
	1994.08-2002.04	MT	L	F	Bus Engine 8140.67	GDS10067	Drive Shaft		35	41	70	117	762		
	1994.08-2002.04	MT	L	F	Bus Engine 8140.67	GDS10035	Drive Shaft	54T	28	41	63	112.5	757.5		
	1994.08-2002.04	MT	L	F	Bus Engine 8140.67	GDS10102	Drive Shaft		28	41	63	112.5	757.5		
	1994.08-2002.04	MT	L	F	Bus Engine 8140.67	GDS10037	Drive Shaft	54T	28	37	63	112.5	771		
	1994.08-2002.04	MT	L	F	Bus Engine 8140.67	GDS10033	Drive Shaft	54T	35	41	70	117	762		
	1994.08-2002.04	MT	L	F	Bus Engine 8140.67	GDS10105	Drive Shaft		28	37	63	112.5	771		
	1994.08-2002.04	MT	R	F	Bus Engine 8140.67	GDS10104	Drive Shaft	54T	28	37	63	112.5	1072		
	1994.08-2002.04	MT	R	F	Bus Engine 8140.67	GDS10032	Drive Shaft	54T	35	41	70	117	1085		
	1994.08-2002.04	MT	R	F	Bus Engine 8140.67	GDS10069	Drive Shaft		28	37	63	112.5	1072		
	1994.08-2002.04	MT	R	F	Bus Engine 8140.67	GDS10066	Drive Shaft		35	41	70	117	1085		
	2.5 TDi (80 kW)	1994.03-2002.04	MT		F	Platform/Chassis Engine 8140.47R	GCO10013	Outer Joint	54T	28	39	63	112.5	63	I
1994.03-2002.04		MT		F	Platform/Chassis Engine 8140.47R	GCO10050	Outer Joint		35	45	70	117	73	I	
1994.03-2002.04		MT		F	Platform/Chassis Engine 8140.47R	GCO10012	Outer Joint		28	39	63	112.5	63	I	
1994.03-2002.04		MT		F	Platform/Chassis Engine 8140.47R	GCO10011	Outer Joint	54T	35	45	70	117	73	I	
1994.03-2002.04		MT	L	F	Platform/Chassis Engine 8140.47R	GDS10067	Drive Shaft		35	41	70	117	762		
1994.03-2002.04		MT	L	F	Platform/Chassis Engine 8140.47R	GDS10035	Drive Shaft	54T	28	41	63	112.5	757.5		
1994.03-2002.04		MT	L	F	Platform/Chassis Engine 8140.47R	GDS10102	Drive Shaft		28	41	63	112.5	757.5		
1994.03-2002.04		MT	L	F	Platform/Chassis Engine 8140.47R	GDS10037	Drive Shaft	54T	28	37	63	112.5	771		
1994.03-2002.04		MT	L	F	Platform/Chassis Engine 8140.47R	GDS10033	Drive Shaft	54T	35	41	70	117	762		
1994.03-2002.04		MT	L	F	Platform/Chassis Engine 8140.47R	GDS10105	Drive Shaft		28	37	63	112.5	771		
1994.03-2002.04		MT	R	F	Platform/Chassis Engine 8140.47R	GDS10104	Drive Shaft	54T	28	37	63	112.5	1072		
1994.03-2002.04		MT	R	F	Platform/Chassis Engine 8140.47R	GDS10032	Drive Shaft	54T	35	41	70	117	1085		
1994.03-2002.04		MT	R	F	Platform/Chassis Engine 8140.47R	GDS10069	Drive Shaft		28	37	63	112.5	1072		
1994.03-2002.04		MT	R	F	Platform/Chassis Engine 8140.47R	GDS10066	Drive Shaft		35	41	70	117	1085		
1994.03-2002.04		MT	R	F	Platform/Chassis Engine 8140.47R	GDS10036	Drive Shaft	54T	28	41	63	112.5	1079		





		TRANSM	L/R	F/R		G-AP Ref.	PRODUCT	ABS	Technical Specifications												
									YEAR	A	B	C	H	L	P						
<b>FIAT</b>																					
<b>DUCATO (230)</b>																					
2.5 TDi (80 kW)	1994.03-	2002.04	MT	R	F	Platform/Chassis Engine 8140.47R	GDS10103	Drive Shaft		28	41	63	112.5	1079							
2.5 TDi (85 kW)	1994.03-	2002.04	MT		F	Platform/Chassis Engine 8140.47	GC010013	Outer Joint	54T	28	39	63	112.5	63	I						
	1994.03-	2002.04	MT		F	Platform/Chassis Engine 8140.47	GC010050	Outer Joint		35	45	70	117	73	I						
	1994.03-	2002.04	MT		F	Platform/Chassis Engine 8140.47	GC010012	Outer Joint		28	39	63	112.5	63	I						
	1994.03-	2002.04	MT		F	Platform/Chassis Engine 8140.47	GC010011	Outer Joint	54T	35	45	70	117	73	I						
	1994.03-	2002.04	MT	L	F	Platform/Chassis Engine 8140.47	GDS10067	Drive Shaft		35	41	70	117	762							
	1994.03-	2002.04	MT	L	F	Platform/Chassis Engine 8140.47	GDS10035	Drive Shaft	54T	28	41	63	112.5	757.5							
	1994.03-	2002.04	MT	L	F	Platform/Chassis Engine 8140.47	GDS10102	Drive Shaft		28	41	63	112.5	757.5							
	1994.03-	2002.04	MT	L	F	Platform/Chassis Engine 8140.47	GDS10037	Drive Shaft	54T	28	37	63	112.5	771							
	1994.03-	2002.04	MT	L	F	Platform/Chassis Engine 8140.47	GDS10033	Drive Shaft	54T	35	41	70	117	762							
	1994.03-	2002.04	MT	L	F	Platform/Chassis Engine 8140.47	GDS10105	Drive Shaft		28	37	63	112.5	771							
	1994.03-	2002.04	MT	R	F	Platform/Chassis Engine 8140.47	GDS10104	Drive Shaft	54T	28	37	63	112.5	1072							
	1994.03-	2002.04	MT	R	F	Platform/Chassis Engine 8140.47	GDS10032	Drive Shaft	54T	35	41	70	117	1085							
	1994.03-	2002.04	MT	R	F	Platform/Chassis Engine 8140.47	GDS10069	Drive Shaft		28	37	63	112.5	1072							
	1994.03-	2002.04	MT	R	F	Platform/Chassis Engine 8140.47	GDS10066	Drive Shaft		35	41	70	117	1085							
1994.03-	2002.04	MT	R	F	Platform/Chassis Engine 8140.47	GDS10036	Drive Shaft	54T	28	41	63	112.5	1079								
1994.03-	2002.04	MT	R	F	Platform/Chassis Engine 8140.47	GDS10103	Drive Shaft		28	41	63	112.5	1079								
2.5 TDi 4x4 (85 kW)	1997.04-	2002.04	MT		F	Bus Engine 8140.47	GC010013	Outer Joint	54T	28	39	63	112.5	63	I						
	1997.04-	2002.04	MT		F	Bus Engine 8140.47	GC010050	Outer Joint		35	45	70	117	73	I						
	1997.04-	2002.04	MT		F	Bus Engine 8140.47	GC010012	Outer Joint		28	39	63	112.5	63	I						
	1997.04-	2002.04	MT		F	Bus Engine 8140.47	GC010011	Outer Joint	54T	35	45	70	117	73	I						
	1997.04-	2002.04	MT	L	F	Bus Engine 8140.47	GDS10067	Drive Shaft		35	41	70	117	762							
	1997.04-	2002.04	MT	L	F	Bus Engine 8140.47	GDS10035	Drive Shaft	54T	28	41	63	112.5	757.5							
	1997.04-	2002.04	MT	L	F	Bus Engine 8140.47	GDS10102	Drive Shaft		28	41	63	112.5	757.5							
	1997.04-	2002.04	MT	L	F	Bus Engine 8140.47	GDS10037	Drive Shaft	54T	28	37	63	112.5	771							
	1997.04-	2002.04	MT	L	F	Bus Engine 8140.47	GDS10033	Drive Shaft	54T	35	41	70	117	762							
	1997.04-	2002.04	MT	L	F	Bus Engine 8140.47	GDS10105	Drive Shaft		28	37	63	112.5	771							
	1997.04-	2002.04	MT	R	F	Bus Engine 8140.47	GDS10104	Drive Shaft	54T	28	37	63	112.5	1072							
	1997.04-	2002.04	MT	R	F	Bus Engine 8140.47	GDS10032	Drive Shaft	54T	35	41	70	117	1085							
	1997.04-	2002.04	MT	R	F	Bus Engine 8140.47	GDS10069	Drive Shaft		28	37	63	112.5	1072							
	1997.04-	2002.04	MT	R	F	Bus Engine 8140.47	GDS10066	Drive Shaft		35	41	70	117	1085							
	1997.04-	2002.04	MT	R	F	Bus Engine 8140.47	GDS10036	Drive Shaft	54T	28	41	63	112.5	1079							
	1997.04-	2002.04	MT	R	F	Bus Engine 8140.47	GDS10103	Drive Shaft		28	41	63	112.5	1079							
	1998.06-	2002.04	MT		F	Platform/Chassis Engine 8140.47	GC010013	Outer Joint	54T	28	39	63	112.5	63	I						
	1998.06-	2002.04	MT		F	Platform/Chassis Engine 8140.47	GC010050	Outer Joint		35	45	70	117	73	I						
	1998.06-	2002.04	MT		F	Platform/Chassis Engine 8140.47	GC010012	Outer Joint		28	39	63	112.5	63	I						
	1998.06-	2002.04	MT		F	Platform/Chassis Engine 8140.47	GC010011	Outer Joint	54T	35	45	70	117	73	I						
	1998.06-	2002.04	MT	L	F	Platform/Chassis Engine 8140.47	GDS10067	Drive Shaft		35	41	70	117	762							
	1998.06-	2002.04	MT	L	F	Platform/Chassis Engine 8140.47	GDS10035	Drive Shaft	54T	28	41	63	112.5	757.5							
	1998.06-	2002.04	MT	L	F	Platform/Chassis Engine 8140.47	GDS10102	Drive Shaft		28	41	63	112.5	757.5							
	1998.06-	2002.04	MT	L	F	Platform/Chassis Engine 8140.47	GDS10037	Drive Shaft	54T	28	37	63	112.5	771							
	1998.06-	2002.04	MT	L	F	Platform/Chassis Engine 8140.47	GDS10033	Drive Shaft	54T	35	41	70	117	762							
	1998.06-	2002.04	MT	L	F	Platform/Chassis Engine 8140.47	GDS10105	Drive Shaft		28	37	63	112.5	771							
	1998.06-	2002.04	MT	R	F	Platform/Chassis Engine 8140.47	GDS10104	Drive Shaft	54T	28	37	63	112.5	1072							
	1998.06-	2002.04	MT	R	F	Platform/Chassis Engine 8140.47	GDS10032	Drive Shaft	54T	35	41	70	117	1085							
	1998.06-	2002.04	MT	R	F	Platform/Chassis Engine 8140.47	GDS10069	Drive Shaft		28	37	63	112.5	1072							
	1998.06-	2002.04	MT	R	F	Platform/Chassis Engine 8140.47	GDS10066	Drive Shaft		35	41	70	117	1085							
	1998.06-	2002.04	MT	R	F	Platform/Chassis Engine 8140.47	GDS10036	Drive Shaft	54T	28	41	63	112.5	1079							
	1998.06-	2002.04	MT	R	F	Platform/Chassis Engine 8140.47	GDS10103	Drive Shaft		28	41	63	112.5	1079							
	2.5 TDi Panorama/Combinato (80 kW)	1994.07-	2002.04	MT		F	Bus Engine 8140.47R	GC010013	Outer Joint	54T	28	39	63	112.5	63	I					
		1994.07-	2002.04	MT		F	Bus Engine 8140.47R	GC010050	Outer Joint		35	45	70	117	73	I					
1994.07-		2002.04	MT		F	Bus Engine 8140.47R	GC010012	Outer Joint		28	39	63	112.5	63	I						
1994.07-		2002.04	MT		F	Bus Engine 8140.47R	GC010011	Outer Joint	54T	35	45	70	117	73	I						
1994.07-		2002.04	MT	L	F	Bus Engine 8140.47R	GDS10067	Drive Shaft		35	41	70	117	762							
1994.07-		2002.04	MT	L	F	Bus Engine 8140.47R	GDS10035	Drive Shaft	54T	28	41	63	112.5	757.5							
1994.07-		2002.04	MT	L	F	Bus Engine 8140.47R	GDS10102	Drive Shaft		28	41	63	112.5	757.5							
1994.07-		2002.04	MT	L	F	Bus Engine 8140.47R	GDS10037	Drive Shaft	54T	28	37	63	112.5	771							
1994.07-		2002.04	MT	L	F	Bus Engine 8140.47R	GDS10033	Drive Shaft	54T	35	41	70	117	762							
1994.07-		2002.04	MT	L	F	Bus Engine 8140.47R	GDS10105	Drive Shaft		28	37	63	112.5	771							
1994.07-		2002.04	MT	R	F	Bus Engine 8140.47R	GDS10104	Drive Shaft	54T	28	37	63	112.5	1072							
1994.07-		2002.04	MT	R	F	Bus Engine 8140.47R	GDS10032	Drive Shaft	54T	35	41	70	117	1085							
1994.07-		2002.04	MT	R	F	Bus Engine 8140.47R	GDS10069	Drive Shaft		28	37	63	112.5	1072							
1994.07-		2002.04	MT	R	F	Bus Engine 8140.47R	GDS10066	Drive Shaft		35	41	70	117	1085							





		TRANSM	L/R	F/R		G-AP Ref.	PRODUCT	ABS	Technical Specifications									
									YEAR	A	B	C	H	L	P			
<b>FIAT</b>																		
<b>DUCATO (230)</b>																		
2.5 TDi Panorama/Combinato (80 kW)	1994.07-	2002.04	MT	R	F	Bus Engine 8140.47R	GDS10036	Drive Shaft	54T	28	41	63	112.5	1079				
	1994.07-	2002.04	MT	R	F	Bus Engine 8140.47R	GDS10103	Drive Shaft		28	41	63	112.5	1079				
2.5 TDi Panorama/Combinato (85 kW)	1994.03-	2002.04	MT		F	Bus Engine 8140.47	GC010013	Outer Joint	54T	28	39	63	112.5	63	I			
	1994.03-	2002.04	MT		F	Bus Engine 8140.47	GC010050	Outer Joint		35	45	70	117	73	I			
	1994.03-	2002.04	MT		F	Bus Engine 8140.47	GC010012	Outer Joint		28	39	63	112.5	63	I			
	1994.03-	2002.04	MT		F	Bus Engine 8140.47	GC010011	Outer Joint	54T	35	45	70	117	73	I			
	1994.03-	2002.04	MT	L	F	Bus Engine 8140.47	GDS10105	Drive Shaft		28	37	63	112.5	771				
	1994.03-	2002.04	MT	L	F	Bus Engine 8140.47	GDS10067	Drive Shaft		35	41	70	117	762				
	1994.03-	2002.04	MT	L	F	Bus Engine 8140.47	GDS10035	Drive Shaft	54T	28	41	63	112.5	757.5				
	1994.03-	2002.04	MT	L	F	Bus Engine 8140.47	GDS10102	Drive Shaft		28	41	63	112.5	757.5				
	1994.03-	2002.04	MT	L	F	Bus Engine 8140.47	GDS10037	Drive Shaft	54T	28	37	63	112.5	771				
	1994.03-	2002.04	MT	L	F	Bus Engine 8140.47	GDS10033	Drive Shaft	54T	35	41	70	117	762				
	1994.03-	2002.04	MT	R	F	Bus Engine 8140.47	GDS10104	Drive Shaft	54T	28	37	63	112.5	1072				
	1994.03-	2002.04	MT	R	F	Bus Engine 8140.47	GDS10032	Drive Shaft	54T	35	41	70	117	1085				
	1994.03-	2002.04	MT	R	F	Bus Engine 8140.47	GDS10069	Drive Shaft		28	37	63	112.5	1072				
	1994.03-	2002.04	MT	R	F	Bus Engine 8140.47	GDS10066	Drive Shaft		35	41	70	117	1085				
	2.8 D (64 kW)	1998.02-	2002.04	MT	R	F	Bus Engine 8140.63	GDS10036	Drive Shaft	54T	28	41	63	112.5	1079			
1998.02-		2002.04	MT	R	F	Bus Engine 8140.63	GDS10066	Drive Shaft		35	41	70	117	1085				
1998.02-		2002.04	MT	R	F	Bus Engine 8140.63	GDS10036	Drive Shaft	54T	28	41	63	112.5	1079				
1998.02-		2002.04	MT	R	F	Bus Engine 8140.63	GDS10103	Drive Shaft		28	41	63	112.5	1079				
1998.02-		2002.04	MT	R	F	Platform/Chassis Engine 8140.63	GDS10104	Drive Shaft	54T	28	37	63	112.5	1072				
1998.02-		2002.04	MT	R	F	Platform/Chassis Engine 8140.63	GDS10032	Drive Shaft	54T	35	41	70	117	1085				
1998.02-		2002.04	MT	R	F	Platform/Chassis Engine 8140.63	GDS10069	Drive Shaft		28	37	63	112.5	1072				
1998.02-		2002.04	MT	R	F	Platform/Chassis Engine 8140.63	GDS10066	Drive Shaft		35	41	70	117	1085				
1998.02-		2002.04	MT	R	F	Platform/Chassis Engine 8140.63	GDS10036	Drive Shaft	54T	28	41	63	112.5	1079				
1998.02-		2002.04	MT	R	F	Platform/Chassis Engine 8140.63	GDS10103	Drive Shaft		28	41	63	112.5	1079				
1998.02-		2002.04	MT		F	Bus Engine 8140.63	GC010013	Outer Joint	54T	28	39	63	112.5	63	I			
1998.02-		2002.04	MT		F	Bus Engine 8140.63	GC010050	Outer Joint		35	45	70	117	73	I			
1998.02-		2002.04	MT		F	Bus Engine 8140.63	GC010012	Outer Joint		28	39	63	112.5	63	I			
1998.02-		2002.04	MT		F	Bus Engine 8140.63	GC010011	Outer Joint	54T	35	45	70	117	73	I			
1998.02-		2002.04	MT		F	Platform/Chassis Engine 8140.63	GC010013	Outer Joint	54T	28	39	63	112.5	63	I			
1998.02-		2002.04	MT		F	Platform/Chassis Engine 8140.63	GC010050	Outer Joint		35	45	70	117	73	I			
1998.02-		2002.04	MT		F	Platform/Chassis Engine 8140.63	GC010012	Outer Joint		28	39	63	112.5	63	I			
1998.02-		2002.04	MT		F	Platform/Chassis Engine 8140.63	GC010011	Outer Joint	54T	35	45	70	117	73	I			
1998.02-		2002.04	MT	L	F	Bus Engine 8140.63	GDS10105	Drive Shaft		28	37	63	112.5	771				
1998.02-		2002.04	MT	L	F	Bus Engine 8140.63	GDS10067	Drive Shaft		35	41	70	117	762				
1998.02-		2002.04	MT	L	F	Bus Engine 8140.63	GDS10035	Drive Shaft	54T	28	41	63	112.5	757.5				
1998.02-		2002.04	MT	L	F	Bus Engine 8140.63	GDS10102	Drive Shaft		28	41	63	112.5	757.5				
1998.02-		2002.04	MT	L	F	Bus Engine 8140.63	GDS10037	Drive Shaft	54T	28	37	63	112.5	771				
1998.02-		2002.04	MT	L	F	Platform/Chassis Engine 8140.63	GDS10033	Drive Shaft	54T	35	41	70	117	762				
1998.02-		2002.04	MT	L	F	Platform/Chassis Engine 8140.63	GDS10105	Drive Shaft		28	37	63	112.5	771				
1998.02-		2002.04	MT	L	F	Platform/Chassis Engine 8140.63	GDS10067	Drive Shaft		35	41	70	117	762				
1998.02-		2002.04	MT	L	F	Platform/Chassis Engine 8140.63	GDS10035	Drive Shaft	54T	28	41	63	112.5	757.5				
1998.02-		2002.04	MT	L	F	Platform/Chassis Engine 8140.63	GDS10102	Drive Shaft		28	41	63	112.5	757.5				
1998.02-		2002.04	MT	L	F	Platform/Chassis Engine 8140.63	GDS10037	Drive Shaft	54T	28	37	63	112.5	771				
1998.02-		2002.04	MT	L	F	Platform/Chassis Engine 8140.63	GDS10033	Drive Shaft	54T	35	41	70	117	762				
1998.02-	2002.04	MT	R	F	Bus Engine 8140.63	GDS10104	Drive Shaft	54T	28	37	63	112.5	1072					
1998.02-	2002.04	MT	R	F	Bus Engine 8140.63	GDS10032	Drive Shaft	54T	35	41	70	117	1085					
2.8 TDi (90 kW)	1997.10-	2002.04	MT		F	Bus Engine 8140.43	GC010013	Outer Joint	54T	28	39	63	112.5	63	I			
	1997.10-	2002.04	MT		F	Bus Engine 8140.43	GC010050	Outer Joint		35	45	70	117	73	I			
	1997.10-	2002.04	MT		F	Bus Engine 8140.43	GC010012	Outer Joint		28	39	63	112.5	63	I			
	1997.10-	2002.04	MT		F	Bus Engine 8140.43	GC010011	Outer Joint	54T	35	45	70	117	73	I			
	1997.10-	2002.04	MT	L	F	Bus Engine 8140.43	GDS10105	Drive Shaft		28	37	63	112.5	771				
	1997.10-	2002.04	MT	L	F	Bus Engine 8140.43	GDS10067	Drive Shaft		35	41	70	117	762				
	1997.10-	2002.04	MT	L	F	Bus Engine 8140.43	GDS10035	Drive Shaft	54T	28	41	63	112.5	757.5				
	1997.10-	2002.04	MT	L	F	Bus Engine 8140.43	GDS10102	Drive Shaft		28	41	63	112.5	757.5				
	1997.10-	2002.04	MT	L	F	Bus Engine 8140.43	GDS10037	Drive Shaft	54T	28	37	63	112.5	771				
	1997.10-	2002.04	MT	L	F	Bus Engine 8140.43	GDS10033	Drive Shaft	54T	35	41	70	117	762				
	1997.10-	2002.04	MT	R	F	Bus Engine 8140.43	GDS10104	Drive Shaft	54T	28	37	63	112.5	1072				
	1997.10-	2002.04	MT	R	F	Bus Engine 8140.43	GDS10032	Drive Shaft	54T	35	41	70	117	1085				
1997.10-	2002.04	MT	R	F	Bus Engine 8140.43	GDS10069	Drive Shaft		28	37	63	112.5	1072					



	 YEAR	TRANSM	L/R	F/R		G-AP Ref.	PRODUCT	ABS	Technical Specifications						
									A	B	C	H	L	P	
<b>FIAT</b>															
<b>DUCATO (230)</b>															
2.8 TDi (90 kW)	1997.10-2002.04	MT	R	F	Bus Engine 8140.43	GDS10066	Drive Shaft		35	41	70	117	1085		
	1997.10-2002.04	MT	R	F	Bus Engine 8140.43	GDS10036	Drive Shaft	54T	28	41	63	112.5	1079		
	1997.10-2002.04	MT	R	F	Bus Engine 8140.43	GDS10103	Drive Shaft		28	41	63	112.5	1079		
	1998.12-2002.04	MT		F	Platform/Chassis Engine 8140.43	GC010013	Outer Joint	54T	28	39	63	112.5	63	I	
	1998.12-2002.04	MT		F	Platform/Chassis Engine 8140.43	GC010050	Outer Joint		35	45	70	117	73	I	
	1998.12-2002.04	MT		F	Platform/Chassis Engine 8140.43	GC010012	Outer Joint		28	39	63	112.5	63	I	
	1998.12-2002.04	MT		F	Platform/Chassis Engine 8140.43	GC010011	Outer Joint	54T	35	45	70	117	73	I	
	1998.12-2002.04	MT	L	F	Platform/Chassis Engine 8140.43	GDS10105	Drive Shaft		28	37	63	112.5	771		
	1998.12-2002.04	MT	L	F	Platform/Chassis Engine 8140.43	GDS10067	Drive Shaft		35	41	70	117	762		
	1998.12-2002.04	MT	L	F	Platform/Chassis Engine 8140.43	GDS10035	Drive Shaft	54T	28	41	63	112.5	757.5		
	1998.12-2002.04	MT	L	F	Platform/Chassis Engine 8140.43	GDS10102	Drive Shaft		28	41	63	112.5	757.5		
	1998.12-2002.04	MT	L	F	Platform/Chassis Engine 8140.43	GDS10037	Drive Shaft	54T	28	37	63	112.5	771		
	1998.12-2002.04	MT	L	F	Platform/Chassis Engine 8140.43	GDS10033	Drive Shaft	54T	35	41	70	117	762		
	1998.12-2002.04	MT	R	F	Platform/Chassis Engine 8140.43	GDS10104	Drive Shaft	54T	28	37	63	112.5	1072		
	1998.12-2002.04	MT	R	F	Platform/Chassis Engine 8140.43	GDS10032	Drive Shaft	54T	35	41	70	117	1085		
	1998.12-2002.04	MT	R	F	Platform/Chassis Engine 8140.43	GDS10069	Drive Shaft		28	37	63	112.5	1072		
	1998.12-2002.04	MT	R	F	Platform/Chassis Engine 8140.43	GDS10066	Drive Shaft		35	41	70	117	1085		
	1998.12-2002.04	MT	R	F	Platform/Chassis Engine 8140.43	GDS10036	Drive Shaft	54T	28	41	63	112.5	1079		
1998.12-2002.04	MT	R	F	Platform/Chassis Engine 8140.43	GDS10103	Drive Shaft		28	41	63	112.5	1079			
2.8 TDi 4x4 (90 kW)	1999.07-2002.04	MT		F	Bus Engine 8140.43	GC010013	Outer Joint	54T	28	39	63	112.5	63	I	
	1999.07-2002.04	MT		F	Bus Engine 8140.43	GC010050	Outer Joint		35	45	70	117	73	I	
	1999.07-2002.04	MT		F	Bus Engine 8140.43	GC010012	Outer Joint		28	39	63	112.5	63	I	
	1999.07-2002.04	MT		F	Bus Engine 8140.43	GC010011	Outer Joint	54T	35	45	70	117	73	I	
	1999.07-2002.04	MT	L	F	Bus Engine 8140.43	GDS10105	Drive Shaft		28	37	63	112.5	771		
	1999.07-2002.04	MT	L	F	Bus Engine 8140.43	GDS10067	Drive Shaft		35	41	70	117	762		
	1999.07-2002.04	MT	L	F	Bus Engine 8140.43	GDS10035	Drive Shaft	54T	28	41	63	112.5	757.5		
	1999.07-2002.04	MT	L	F	Bus Engine 8140.43	GDS10102	Drive Shaft		28	41	63	112.5	757.5		
	1999.07-2002.04	MT	L	F	Bus Engine 8140.43	GDS10037	Drive Shaft	54T	28	37	63	112.5	771		
	1999.07-2002.04	MT	L	F	Bus Engine 8140.43	GDS10033	Drive Shaft	54T	35	41	70	117	762		
	1999.07-2002.04	MT	R	F	Bus Engine 8140.43	GDS10104	Drive Shaft	54T	28	37	63	112.5	1072		
	1999.07-2002.04	MT	R	F	Bus Engine 8140.43	GDS10032	Drive Shaft	54T	35	41	70	117	1085		
	1999.07-2002.04	MT	R	F	Bus Engine 8140.43	GDS10069	Drive Shaft		28	37	63	112.5	1072		
	1999.07-2002.04	MT	R	F	Bus Engine 8140.43	GDS10066	Drive Shaft		35	41	70	117	1085		
	1999.07-2002.04	MT	R	F	Bus Engine 8140.43	GDS10036	Drive Shaft	54T	28	41	63	112.5	1079		
1999.07-2002.04	MT	R	F	Bus Engine 8140.43	GDS10103	Drive Shaft		28	41	63	112.5	1079			
<b>DUCATO (230L)</b>															
1.9 D (50 kW)	1998.04-2002.04	MT		F	Box Engine DJY	GC010011	Outer Joint	54T	35	45	70	117	73	I	
	1998.04-2002.04	MT		F	Box Engine DJY	GC010013	Outer Joint	54T	28	39	63	112.5	63	I	
	1998.04-2002.04	MT		F	Box Engine DJY	GC010050	Outer Joint		35	45	70	117	73	I	
	1998.04-2002.04	MT		F	Box Engine DJY	GC010012	Outer Joint		28	39	63	112.5	63	I	
	1998.04-2002.04	MT	L	F	Box Engine DJY	GDS10105	Drive Shaft		28	37	63	112.5	771		
	1998.04-2002.04	MT	L	F	Box Engine DJY	GDS10067	Drive Shaft		35	41	70	117	762		
	1998.04-2002.04	MT	L	F	Box Engine DJY	GDS10035	Drive Shaft	54T	28	41	63	112.5	757.5		
	1998.04-2002.04	MT	L	F	Box Engine DJY	GDS10102	Drive Shaft		28	41	63	112.5	757.5		
	1998.04-2002.04	MT	L	F	Box Engine DJY	GDS10037	Drive Shaft	54T	28	37	63	112.5	771		
	1998.04-2002.04	MT	L	F	Box Engine DJY	GDS10033	Drive Shaft	54T	35	41	70	117	762		
	1998.04-2002.04	MT	R	F	Box Engine DJY	GDS10104	Drive Shaft	54T	28	37	63	112.5	1072		
	1998.04-2002.04	MT	R	F	Box Engine DJY	GDS10032	Drive Shaft	54T	35	41	70	117	1085		
	1998.04-2002.04	MT	R	F	Box Engine DJY	GDS10069	Drive Shaft		28	37	63	112.5	1072		
	1998.04-2002.04	MT	R	F	Box Engine DJY	GDS10066	Drive Shaft		35	41	70	117	1085		
	1998.04-2002.04	MT	R	F	Box Engine DJY	GDS10036	Drive Shaft	54T	28	41	63	112.5	1079		
	1998.04-2002.04	MT	R	F	Box Engine DJY	GDS10103	Drive Shaft		28	41	63	112.5	1079		
	1.9 D (51 kW)	1994.03-2002.04	MT		F	Box Engine 230A2.000	GC010011	Outer Joint	54T	35	45	70	117	73	I
		1994.03-2002.04	MT		F	Box Engine 230A2.000	GC010013	Outer Joint	54T	28	39	63	112.5	63	I
1994.03-2002.04		MT		F	Box Engine 230A2.000	GC010050	Outer Joint		35	45	70	117	73	I	
1994.03-2002.04		MT		F	Box Engine 230A2.000	GC010012	Outer Joint		28	39	63	112.5	63	I	
1994.03-2002.04		MT	L	F	Box Engine 230A2.000	GDS10105	Drive Shaft		28	37	63	112.5	771		
1994.03-2002.04		MT	L	F	Box Engine 230A2.000	GDS10067	Drive Shaft		35	41	70	117	762		
1994.03-2002.04		MT	L	F	Box Engine 230A2.000	GDS10035	Drive Shaft	54T	28	41	63	112.5	757.5		
1994.03-2002.04		MT	L	F	Box Engine 230A2.000	GDS10102	Drive Shaft		28	41	63	112.5	757.5		
1994.03-2002.04		MT	L	F	Box Engine 230A2.000	GDS10037	Drive Shaft	54T	28	37	63	112.5	771		
1994.03-2002.04		MT	L	F	Box Engine 230A2.000	GDS10033	Drive Shaft	54T	35	41	70	117	762		





		YEAR	TRANSM	L/R	F/R		G-AP Ref.	PRODUCT	ABS	Technical Specifications						
										A	B	C	H	L	P	
<b>FIAT</b>																
<b>DUCATO (230L)</b>																
1.9 D (51 kW)	1994.03-	2002.04	MT	R	F	Box Engine 230A2.000	GDS10104	Drive Shaft	54T	28	37	63	112.5	1072		
	1994.03-	2002.04	MT	R	F	Box Engine 230A2.000	GDS10032	Drive Shaft	54T	35	41	70	117	1085		
	1994.03-	2002.04	MT	R	F	Box Engine 230A2.000	GDS10069	Drive Shaft		28	37	63	112.5	1072		
	1994.03-	2002.04	MT	R	F	Box Engine 230A2.000	GDS10066	Drive Shaft		35	41	70	117	1085		
	1994.03-	2002.04	MT	R	F	Box Engine 230A2.000	GDS10036	Drive Shaft	54T	28	41	63	112.5	1079		
	1994.03-	2002.04	MT	R	F	Box Engine 230A2.000	GDS10103	Drive Shaft		28	41	63	112.5	1079		
1.9 TD (60 kW)	1994.03-	2002.04	MT		F	Box Engine 230A3.000	GC010011	Outer Joint	54T	35	45	70	117	73	I	
	1994.03-	2002.04	MT		F	Box Engine 230A3.000	GC010013	Outer Joint	54T	28	39	63	112.5	63	I	
	1994.03-	2002.04	MT		F	Box Engine 230A3.000	GC010050	Outer Joint		35	45	70	117	73	I	
	1994.03-	2002.04	MT		F	Box Engine 230A3.000	GC010012	Outer Joint		28	39	63	112.5	63	I	
	1994.03-	2002.04	MT	L	F	Box Engine 230A3.000	GDS10105	Drive Shaft		28	37	63	112.5	771		
	1994.03-	2002.04	MT	L	F	Box Engine 230A3.000	GDS10067	Drive Shaft		35	41	70	117	762		
	1994.03-	2002.04	MT	L	F	Box Engine 230A3.000	GDS10035	Drive Shaft	54T	28	41	63	112.5	757.5		
	1994.03-	2002.04	MT	L	F	Box Engine 230A3.000	GDS10102	Drive Shaft		28	41	63	112.5	757.5		
	1994.03-	2002.04	MT	L	F	Box Engine 230A3.000	GDS10037	Drive Shaft	54T	28	37	63	112.5	771		
	1994.03-	2002.04	MT	L	F	Box Engine 230A3.000	GDS10033	Drive Shaft	54T	35	41	70	117	762		
	1994.03-	2002.04	MT	R	F	Box Engine 230A3.000	GDS10104	Drive Shaft	54T	28	37	63	112.5	1072		
	1994.03-	2002.04	MT	R	F	Box Engine 230A3.000	GDS10032	Drive Shaft	54T	35	41	70	117	1085		
	1994.03-	2002.04	MT	R	F	Box Engine 230A3.000	GDS10069	Drive Shaft		28	37	63	112.5	1072		
	1994.03-	2002.04	MT	R	F	Box Engine 230A3.000	GDS10066	Drive Shaft		35	41	70	117	1085		
	1994.03-	2002.04	MT	R	F	Box Engine 230A3.000	GDS10036	Drive Shaft	54T	28	41	63	112.5	1079		
	1994.03-	2002.04	MT	R	F	Box Engine 230A3.000	GDS10103	Drive Shaft		28	41	63	112.5	1079		
1.9 TD (66 kW)	1998.04-	2002.04	MT		F	Box Engine DHX(XUD9TF/L)	GC010011	Outer Joint	54T	35	45	70	117	73	I	
	1998.04-	2002.04	MT		F	Box Engine DHX(XUD9TF/L)	GC010013	Outer Joint	54T	28	39	63	112.5	63	I	
	1998.04-	2002.04	MT		F	Box Engine DHX(XUD9TF/L)	GC010050	Outer Joint		35	45	70	117	73	I	
	1998.04-	2002.04	MT		F	Box Engine DHX(XUD9TF/L)	GC010012	Outer Joint		28	39	63	112.5	63	I	
	1998.04-	2002.04	MT	L	F	Box Engine DHX(XUD9TF/L)	GDS10105	Drive Shaft		28	37	63	112.5	771		
	1998.04-	2002.04	MT	L	F	Box Engine DHX(XUD9TF/L)	GDS10067	Drive Shaft		35	41	70	117	762		
	1998.04-	2002.04	MT	L	F	Box Engine DHX(XUD9TF/L)	GDS10035	Drive Shaft	54T	28	41	63	112.5	757.5		
	1998.04-	2002.04	MT	L	F	Box Engine DHX(XUD9TF/L)	GDS10102	Drive Shaft		28	41	63	112.5	757.5		
	1998.04-	2002.04	MT	L	F	Box Engine DHX(XUD9TF/L)	GDS10037	Drive Shaft	54T	28	37	63	112.5	771		
	1998.04-	2002.04	MT	L	F	Box Engine DHX(XUD9TF/L)	GDS10033	Drive Shaft	54T	35	41	70	117	762		
	1998.04-	2002.04	MT	R	F	Box Engine DHX(XUD9TF/L)	GDS10104	Drive Shaft	54T	28	37	63	112.5	1072		
	1998.04-	2002.04	MT	R	F	Box Engine DHX(XUD9TF/L)	GDS10032	Drive Shaft	54T	35	41	70	117	1085		
	1998.04-	2002.04	MT	R	F	Box Engine DHX(XUD9TF/L)	GDS10069	Drive Shaft		28	37	63	112.5	1072		
	1998.04-	2002.04	MT	R	F	Box Engine DHX(XUD9TF/L)	GDS10066	Drive Shaft		35	41	70	117	1085		
	1998.04-	2002.04	MT	R	F	Box Engine DHX(XUD9TF/L)	GDS10036	Drive Shaft	54T	28	41	63	112.5	1079		
	1998.04-	2002.04	MT	R	F	Box Engine DHX(XUD9TF/L)	GDS10103	Drive Shaft		28	41	63	112.5	1079		
1.9 TD CAT (59 kW)	1994.08-	2002.04	MT		F	Box Engine 230A4.000	GC010011	Outer Joint	54T	35	45	70	117	73	I	
	1994.08-	2002.04	MT		F	Box Engine 230A4.000	GC010013	Outer Joint	54T	28	39	63	112.5	63	I	
	1994.08-	2002.04	MT		F	Box Engine 230A4.000	GC010050	Outer Joint		35	45	70	117	73	I	
	1994.08-	2002.04	MT		F	Box Engine 230A4.000	GC010012	Outer Joint		28	39	63	112.5	63	I	
	1994.08-	2002.04	MT	L	F	Box Engine 230A4.000	GDS10105	Drive Shaft		28	37	63	112.5	771		
	1994.08-	2002.04	MT	L	F	Box Engine 230A4.000	GDS10067	Drive Shaft		35	41	70	117	762		
	1994.08-	2002.04	MT	L	F	Box Engine 230A4.000	GDS10035	Drive Shaft	54T	28	41	63	112.5	757.5		
	1994.08-	2002.04	MT	L	F	Box Engine 230A4.000	GDS10102	Drive Shaft		28	41	63	112.5	757.5		
	1994.08-	2002.04	MT	L	F	Box Engine 230A4.000	GDS10037	Drive Shaft	54T	28	37	63	112.5	771		
	1994.08-	2002.04	MT	L	F	Box Engine 230A4.000	GDS10033	Drive Shaft	54T	35	41	70	117	762		
	1994.08-	2002.04	MT	R	F	Box Engine 230A4.000	GDS10104	Drive Shaft	54T	28	37	63	112.5	1072		
	1994.08-	2002.04	MT	R	F	Box Engine 230A4.000	GDS10032	Drive Shaft	54T	35	41	70	117	1085		
	1994.08-	2002.04	MT	R	F	Box Engine 230A4.000	GDS10069	Drive Shaft		28	37	63	112.5	1072		
	1994.08-	2002.04	MT	R	F	Box Engine 230A4.000	GDS10066	Drive Shaft		35	41	70	117	1085		
	1994.08-	2002.04	MT	R	F	Box Engine 230A4.000	GDS10036	Drive Shaft	54T	28	41	63	112.5	1079		
	1994.08-	2002.04	MT	R	F	Box Engine 230A4.000	GDS10103	Drive Shaft		28	41	63	112.5	1079		
2.0 (80 kW)	1994.03-	2002.04	MT		F	Box Engine RFW	GC010011	Outer Joint	54T	35	45	70	117	73	I	
	1994.03-	2002.04	MT		F	Box Engine RFW	GC010013	Outer Joint	54T	28	39	63	112.5	63	I	
	1994.03-	2002.04	MT		F	Box Engine RFW	GC010050	Outer Joint		35	45	70	117	73	I	
	1994.03-	2002.04	MT		F	Box Engine RFW	GC010012	Outer Joint		28	39	63	112.5	63	I	
	1994.03-	2002.04	MT	L	F	Box Engine RFW	GDS10105	Drive Shaft		28	37	63	112.5	771		
	1994.03-	2002.04	MT	L	F	Box Engine RFW	GDS10067	Drive Shaft		35	41	70	117	762		
	1994.03-	2002.04	MT	L	F	Box Engine RFW	GDS10035	Drive Shaft	54T	28	41	63	112.5	757.5		
	1994.03-	2002.04	MT	L	F	Box Engine RFW	GDS10102	Drive Shaft		28	41	63	112.5	757.5		
1994.03-	2002.04	MT	L	F	Box Engine RFW	GDS10037	Drive Shaft	54T	28	37	63	112.5	771			









		TRANSM	L/R	F/R		G-AP Ref.	PRODUCT	ABS	Technical Specifications								
									YEAR	A	B	C	H	L	P		
<b>FIAT</b>																	
<b>DUCATO (230L)</b>																	
2.0 (80 kW)	1994.03-	2002.04	MT	L	F	Box Engine RFW	GDS10033	Drive Shaft	54T	35	41	70	117	762			
	1994.03-	2002.04	MT	R	F	Box Engine RFW	GDS10104	Drive Shaft	54T	28	37	63	112.5	1072			
	1994.03-	2002.04	MT	R	F	Box Engine RFW	GDS10032	Drive Shaft	54T	35	41	70	117	1085			
	1994.03-	2002.04	MT	R	F	Box Engine RFW	GDS10069	Drive Shaft		28	37	63	112.5	1072			
	1994.03-	2002.04	MT	R	F	Box Engine RFW	GDS10066	Drive Shaft		35	41	70	117	1085			
	1994.03-	2002.04	MT	R	F	Box Engine RFW	GDS10036	Drive Shaft	54T	28	41	63	112.5	1079			
	1994.03-	2002.04	MT	R	F	Box Engine RFW	GDS10103	Drive Shaft		28	41	63	112.5	1079			
2.5 D (62 kW)	1994.03-	2002.04	MT		F	Box Engine 8140.67	GC010011	Outer Joint	54T	35	45	70	117	73	I		
	1994.03-	2002.04	MT		F	Box Engine 8140.67	GC010013	Outer Joint	54T	28	39	63	112.5	63	I		
	1994.03-	2002.04	MT		F	Box Engine 8140.67	GC010050	Outer Joint		35	45	70	117	73	I		
	1994.03-	2002.04	MT		F	Box Engine 8140.67	GC010012	Outer Joint		28	39	63	112.5	63	I		
	1994.03-	2002.04	MT	L	F	Box Engine 8140.67	GDS10105	Drive Shaft		28	37	63	112.5	771			
	1994.03-	2002.04	MT	L	F	Box Engine 8140.67	GDS10067	Drive Shaft		35	41	70	117	762			
	1994.03-	2002.04	MT	L	F	Box Engine 8140.67	GDS10035	Drive Shaft	54T	28	41	63	112.5	757.5			
	1994.03-	2002.04	MT	L	F	Box Engine 8140.67	GDS10102	Drive Shaft		28	41	63	112.5	757.5			
	1994.03-	2002.04	MT	L	F	Box Engine 8140.67	GDS10037	Drive Shaft	54T	28	37	63	112.5	771			
	1994.03-	2002.04	MT	L	F	Box Engine 8140.67	GDS10033	Drive Shaft	54T	35	41	70	117	762			
	1994.03-	2002.04	MT	R	F	Box Engine 8140.67	GDS10104	Drive Shaft	54T	28	37	63	112.5	1072			
	1994.03-	2002.04	MT	R	F	Box Engine 8140.67	GDS10032	Drive Shaft	54T	35	41	70	117	1085			
	1994.03-	2002.04	MT	R	F	Box Engine 8140.67	GDS10069	Drive Shaft		28	37	63	112.5	1072			
	1994.03-	2002.04	MT	R	F	Box Engine 8140.67	GDS10066	Drive Shaft		35	41	70	117	1085			
	1994.03-	2002.04	MT	R	F	Box Engine 8140.67	GDS10036	Drive Shaft	54T	28	41	63	112.5	1079			
	1994.03-	2002.04	MT	R	F	Box Engine 8140.67	GDS10103	Drive Shaft		28	41	63	112.5	1079			
	2.5 TDi (80 kW)	1994.03-	2002.04	MT		F	Box Engine 8140.47R	GC010011	Outer Joint	54T	35	45	70	117	73	I	
1994.03-		2002.04	MT		F	Box Engine 8140.47R	GC010013	Outer Joint	54T	28	39	63	112.5	63	I		
1994.03-		2002.04	MT		F	Box Engine 8140.47R	GC010050	Outer Joint		35	45	70	117	73	I		
1994.03-		2002.04	MT		F	Box Engine 8140.47R	GC010012	Outer Joint		28	39	63	112.5	63	I		
1994.03-		2002.04	MT	L	F	Box Engine 8140.47R	GDS10105	Drive Shaft		28	37	63	112.5	771			
1994.03-		2002.04	MT	L	F	Box Engine 8140.47R	GDS10067	Drive Shaft		35	41	70	117	762			
1994.03-		2002.04	MT	L	F	Box Engine 8140.47R	GDS10035	Drive Shaft	54T	28	41	63	112.5	757.5			
1994.03-		2002.04	MT	L	F	Box Engine 8140.47R	GDS10102	Drive Shaft		28	41	63	112.5	757.5			
1994.03-		2002.04	MT	L	F	Box Engine 8140.47R	GDS10037	Drive Shaft	54T	28	37	63	112.5	771			
1994.03-		2002.04	MT	L	F	Box Engine 8140.47R	GDS10033	Drive Shaft	54T	35	41	70	117	762			
1994.03-		2002.04	MT	R	F	Box Engine 8140.47R	GDS10104	Drive Shaft	54T	28	37	63	112.5	1072			
1994.03-		2002.04	MT	R	F	Box Engine 8140.47R	GDS10032	Drive Shaft	54T	35	41	70	117	1085			
1994.03-		2002.04	MT	R	F	Box Engine 8140.47R	GDS10069	Drive Shaft		28	37	63	112.5	1072			
1994.03-		2002.04	MT	R	F	Box Engine 8140.47R	GDS10066	Drive Shaft		35	41	70	117	1085			
1994.03-		2002.04	MT	R	F	Box Engine 8140.47R	GDS10036	Drive Shaft	54T	28	41	63	112.5	1079			
2.5 TDi (85 kW)	1994.03-	2002.04	MT		F	Box Engine 8140.47	GC010011	Outer Joint	54T	35	45	70	117	73	I		
	1994.03-	2002.04	MT		F	Box Engine 8140.47	GC010013	Outer Joint	54T	28	39	63	112.5	63	I		
	1994.03-	2002.04	MT		F	Box Engine 8140.47	GC010050	Outer Joint		35	45	70	117	73	I		
	1994.03-	2002.04	MT		F	Box Engine 8140.47	GC010012	Outer Joint		28	39	63	112.5	63	I		
	1994.03-	2002.04	MT	L	F	Box Engine 8140.47	GDS10105	Drive Shaft		28	37	63	112.5	771			
	1994.03-	2002.04	MT	L	F	Box Engine 8140.47	GDS10067	Drive Shaft		35	41	70	117	762			
	1994.03-	2002.04	MT	L	F	Box Engine 8140.47	GDS10035	Drive Shaft	54T	28	41	63	112.5	757.5			
	1994.03-	2002.04	MT	L	F	Box Engine 8140.47	GDS10102	Drive Shaft		28	41	63	112.5	757.5			
	1994.03-	2002.04	MT	L	F	Box Engine 8140.47	GDS10037	Drive Shaft	54T	28	37	63	112.5	771			
	1994.03-	2002.04	MT	L	F	Box Engine 8140.47	GDS10033	Drive Shaft	54T	35	41	70	117	762			
	1994.03-	2002.04	MT	R	F	Box Engine 8140.47	GDS10104	Drive Shaft	54T	28	37	63	112.5	1072			
	1994.03-	2002.04	MT	R	F	Box Engine 8140.47	GDS10032	Drive Shaft	54T	35	41	70	117	1085			
	1994.03-	2002.04	MT	R	F	Box Engine 8140.47	GDS10069	Drive Shaft		28	37	63	112.5	1072			
1994.03-	2002.04	MT	R	F	Box Engine 8140.47	GDS10066	Drive Shaft		35	41	70	117	1085				
1994.03-	2002.04	MT	R	F	Box Engine 8140.47	GDS10036	Drive Shaft	54T	28	41	63	112.5	1079				
2.5 TDi 4x4 (85 kW)	1998.05-	2002.04	MT		F	Box Engine 8140.47	GC010011	Outer Joint	54T	35	45	70	117	73	I		
	1998.05-	2002.04	MT		F	Box Engine 8140.47	GC010013	Outer Joint	54T	28	39	63	112.5	63	I		
	1998.05-	2002.04	MT		F	Box Engine 8140.47	GC010050	Outer Joint		35	45	70	117	73	I		
	1998.05-	2002.04	MT		F	Box Engine 8140.47	GC010012	Outer Joint		28	39	63	112.5	63	I		
	1998.05-	2002.04	MT	L	F	Box Engine 8140.47	GDS10105	Drive Shaft		28	37	63	112.5	771			
	1998.05-	2002.04	MT	L	F	Box Engine 8140.47	GDS10067	Drive Shaft		35	41	70	117	762			
	1998.05-	2002.04	MT	L	F	Box Engine 8140.47	GDS10035	Drive Shaft	54T	28	41	63	112.5	757.5			
1998.05-	2002.04	MT	L	F	Box Engine 8140.47	GDS10102	Drive Shaft		28	41	63	112.5	757.5				



		TRANSM	L/R	F/R		G-AP Ref.	PRODUCT	ABS	Technical Specifications							
									YEAR	A	B	C	H	L	P	
<b>FIAT</b>																
<b>DUCATO (230L)</b>																
2.5 TDi 4x4 (85 kW)	1998.05-	2002.04	MT	L	F	Box Engine 8140.47	GDS10037	Drive Shaft	54T	28	37	63	112.5	771		
	1998.05-	2002.04	MT	L	F	Box Engine 8140.47	GDS10033	Drive Shaft	54T	35	41	70	117	762		
	1998.05-	2002.04	MT	R	F	Box Engine 8140.47	GDS10104	Drive Shaft	54T	28	37	63	112.5	1072		
	1998.05-	2002.04	MT	R	F	Box Engine 8140.47	GDS10032	Drive Shaft	54T	35	41	70	117	1085		
	1998.05-	2002.04	MT	R	F	Box Engine 8140.47	GDS10069	Drive Shaft		28	37	63	112.5	1072		
	1998.05-	2002.04	MT	R	F	Box Engine 8140.47	GDS10066	Drive Shaft		35	41	70	117	1085		
	1998.05-	2002.04	MT	R	F	Box Engine 8140.47	GDS10036	Drive Shaft	54T	28	41	63	112.5	1079		
	1998.05-	2002.04	MT	R	F	Box Engine 8140.47	GDS10103	Drive Shaft		28	41	63	112.5	1079		
2.8 D (64 kW)	1998.05-	2002.04	MT		F	Box Engine 8140.63	GC010011	Outer Joint	54T	35	45	70	117	73	I	
	1998.05-	2002.04	MT		F	Box Engine 8140.63	GC010013	Outer Joint	54T	28	39	63	112.5	63	I	
	1998.05-	2002.04	MT		F	Box Engine 8140.63	GC010050	Outer Joint		35	45	70	117	73	I	
	1998.05-	2002.04	MT		F	Box Engine 8140.63	GC010012	Outer Joint		28	39	63	112.5	63	I	
	1998.05-	2002.04	MT	L	F	Box Engine 8140.63	GDS10105	Drive Shaft		28	37	63	112.5	771		
	1998.05-	2002.04	MT	L	F	Box Engine 8140.63	GDS10067	Drive Shaft		35	41	70	117	762		
	1998.05-	2002.04	MT	L	F	Box Engine 8140.63	GDS10035	Drive Shaft	54T	28	41	63	112.5	757.5		
	1998.05-	2002.04	MT	L	F	Box Engine 8140.63	GDS10102	Drive Shaft		28	41	63	112.5	757.5		
	1998.05-	2002.04	MT	L	F	Box Engine 8140.63	GDS10037	Drive Shaft	54T	28	37	63	112.5	771		
	1998.05-	2002.04	MT	L	F	Box Engine 8140.63	GDS10033	Drive Shaft	54T	35	41	70	117	762		
	1998.05-	2002.04	MT	R	F	Box Engine 8140.63	GDS10104	Drive Shaft	54T	28	37	63	112.5	1072		
	1998.05-	2002.04	MT	R	F	Box Engine 8140.63	GDS10032	Drive Shaft	54T	35	41	70	117	1085		
	1998.05-	2002.04	MT	R	F	Box Engine 8140.63	GDS10069	Drive Shaft		28	37	63	112.5	1072		
	1998.05-	2002.04	MT	R	F	Box Engine 8140.63	GDS10066	Drive Shaft		35	41	70	117	1085		
	1998.05-	2002.04	MT	R	F	Box Engine 8140.63	GDS10036	Drive Shaft	54T	28	41	63	112.5	1079		
	1998.05-	2002.04	MT	R	F	Box Engine 8140.63	GDS10103	Drive Shaft		28	41	63	112.5	1079		
	2.8 D 4x4 (64 kW)	1998.08-	2002.04	MT		F	Box Engine 8140.63	GC010011	Outer Joint	54T	35	45	70	117	73	I
		1998.08-	2002.04	MT		F	Box Engine 8140.63	GC010013	Outer Joint	54T	28	39	63	112.5	63	I
1998.08-		2002.04	MT		F	Box Engine 8140.63	GC010050	Outer Joint		35	45	70	117	73	I	
1998.08-		2002.04	MT		F	Box Engine 8140.63	GC010012	Outer Joint		28	39	63	112.5	63	I	
1998.08-		2002.04	MT	L	F	Box Engine 8140.63	GDS10105	Drive Shaft		28	37	63	112.5	771		
1998.08-		2002.04	MT	L	F	Box Engine 8140.63	GDS10067	Drive Shaft		35	41	70	117	762		
1998.08-		2002.04	MT	L	F	Box Engine 8140.63	GDS10035	Drive Shaft	54T	28	41	63	112.5	757.5		
1998.08-		2002.04	MT	L	F	Box Engine 8140.63	GDS10102	Drive Shaft		28	41	63	112.5	757.5		
1998.08-		2002.04	MT	L	F	Box Engine 8140.63	GDS10037	Drive Shaft	54T	28	37	63	112.5	771		
1998.08-		2002.04	MT	L	F	Box Engine 8140.63	GDS10033	Drive Shaft	54T	35	41	70	117	762		
1998.08-		2002.04	MT	R	F	Box Engine 8140.63	GDS10103	Drive Shaft		28	41	63	112.5	1079		
1998.08-		2002.04	MT	R	F	Box Engine 8140.63	GDS10104	Drive Shaft	54T	28	37	63	112.5	1072		
1998.08-		2002.04	MT	R	F	Box Engine 8140.63	GDS10032	Drive Shaft	54T	35	41	70	117	1085		
1998.08-		2002.04	MT	R	F	Box Engine 8140.63	GDS10069	Drive Shaft		28	37	63	112.5	1072		
1998.08-		2002.04	MT	R	F	Box Engine 8140.63	GDS10066	Drive Shaft		35	41	70	117	1085		
1998.08-		2002.04	MT	R	F	Box Engine 8140.63	GDS10036	Drive Shaft	54T	28	41	63	112.5	1079		
2.8 TDi (90 kW)		1997.10-	2002.04	MT	L	F	Box Engine 8140.43	GDS10035	Drive Shaft	54T	28	41	63	112.5	757.5	
		1997.10-	2002.04	MT	L	F	Box Engine 8140.43	GDS10102	Drive Shaft		28	41	63	112.5	757.5	
	1997.10-	2002.04	MT	L	F	Box Engine 8140.43	GDS10037	Drive Shaft	54T	28	37	63	112.5	771		
	1997.10-	2002.04	MT	L	F	Box Engine 8140.43	GDS10033	Drive Shaft	54T	35	41	70	117	762		
	1997.10-	2002.04	MT	R	F	Box Engine 8140.43	GDS10103	Drive Shaft		28	41	63	112.5	1079		
	1997.10-	2002.04	MT	R	F	Box Engine 8140.43	GDS10104	Drive Shaft	54T	28	37	63	112.5	1072		
	1997.10-	2002.04	MT	R	F	Box Engine 8140.43	GDS10032	Drive Shaft	54T	35	41	70	117	1085		
	1997.10-	2002.04	MT	R	F	Box Engine 8140.43	GDS10069	Drive Shaft		28	37	63	112.5	1072		
	1997.10-	2002.04	MT	R	F	Box Engine 8140.43	GDS10066	Drive Shaft		35	41	70	117	1085		
	1997.10-	2002.04	MT	R	F	Box Engine 8140.43	GDS10036	Drive Shaft	54T	28	41	63	112.5	1079		
	1997.10-	2002.04	MT		F	Box Engine 8140.43	GC010011	Outer Joint	54T	35	45	70	117	73	I	
	1997.10-	2002.04	MT		F	Box Engine 8140.43	GC010013	Outer Joint	54T	28	39	63	112.5	63	I	
	1997.10-	2002.04	MT		F	Box Engine 8140.43	GC010050	Outer Joint		35	45	70	117	73	I	
	1997.10-	2002.04	MT		F	Box Engine 8140.43	GC010012	Outer Joint		28	39	63	112.5	63	I	
	1997.10-	2002.04	MT	L	F	Box Engine 8140.43	GDS10105	Drive Shaft		28	37	63	112.5	771		
	1997.10-	2002.04	MT	L	F	Box Engine 8140.43	GDS10067	Drive Shaft		35	41	70	117	762		
	2.8 TDi 4x4 (90 kW)	1999.06-	2002.04	MT		F	Box Engine 8140.43	GC010011	Outer Joint	54T	35	45	70	117	73	I
		1999.06-	2002.04	MT		F	Box Engine 8140.43	GC010013	Outer Joint	54T	28	39	63	112.5	63	I
1999.06-		2002.04	MT		F	Box Engine 8140.43	GC010050	Outer Joint		35	45	70	117	73	I	
1999.06-		2002.04	MT		F	Box Engine 8140.43	GC010012	Outer Joint		28	39	63	112.5	63	I	
1999.06-		2002.04	MT	L	F	Box Engine 8140.43	GDS10033	Drive Shaft	54T	35	41	70	117	762		
1999.06-		2002.04	MT	L	F	Box Engine 8140.43	GDS10105	Drive Shaft		28	37	63	112.5	771		
1999.06-		2002.04	MT	L	F	Box Engine 8140.43	GDS10067	Drive Shaft		35	41	70	117	762		

		TRANSM	L/R	F/R		G-AP Ref.	PRODUCT	ABS	Technical Specifications						
									YEAR	A	B	C	H	L	P
<b>FIAT</b>															
<b>DUCATO (230L)</b>															
2.8 TDi 4x4 (90 kW)	1999.06-	2002.04	MT	L	F	Box Engine 8140.43	GDS10035	Drive Shaft	54T	28	41	63	112.5	757.5	
	1999.06-	2002.04	MT	L	F	Box Engine 8140.43	GDS10102	Drive Shaft		28	41	63	112.5	757.5	
	1999.06-	2002.04	MT	L	F	Box Engine 8140.43	GDS10037	Drive Shaft	54T	28	37	63	112.5	771	
	1999.06-	2002.04	MT	R	F	Box Engine 8140.43	GDS10103	Drive Shaft		28	41	63	112.5	1079	
	1999.06-	2002.04	MT	R	F	Box Engine 8140.43	GDS10104	Drive Shaft	54T	28	37	63	112.5	1072	
	1999.06-	2002.04	MT	R	F	Box Engine 8140.43	GDS10032	Drive Shaft	54T	35	41	70	117	1085	
	1999.06-	2002.04	MT	R	F	Box Engine 8140.43	GDS10069	Drive Shaft		28	37	63	112.5	1072	
	1999.06-	2002.04	MT	R	F	Box Engine 8140.43	GDS10066	Drive Shaft		35	41	70	117	1085	
1999.06-	2002.04	MT	R	F	Box Engine 8140.43	GDS10036	Drive Shaft	54T	28	41	63	112.5	1079		
<b>DUCATO (244)</b>															
2.0 (81 kW)	2002.04-		MT		F	Box Engine RFL	GC010011	Outer Joint	54T	35	45	70	117	73	I
	2002.04-		MT		F	Box Engine RFL	GC010013	Outer Joint	54T	28	39	63	112.5	63	I
2.0 JTD (62 kW)	2002.04-		MT		F	Box Engine RHV(DW10)	GC010013	Outer Joint	54T	28	39	63	112.5	63	I
	2002.04-	2006.07	MT		F	Platform/Chassis Engine RHV(DW10)	GC010013	Outer Joint	54T	28	39	63	112.5	63	I
2.3 JTD (81 kW)	2002.04-		MT		F	Box Engine F1AE0481C	GC010011	Outer Joint	54T	35	45	70	117	73	I
	2002.04-		MT		F	Box Engine F1AE0481C	GC010013	Outer Joint	54T	28	39	63	112.5	63	I
	2002.04-	2006.07	MT		F	Platform/Chassis Engine F1AE0481C	GC010011	Outer Joint	54T	35	45	70	117	73	I
2.8 JTD (94 kW)	2002.04-		MT		F	Platform/Chassis Engine F1AE0481C	GC010013	Outer Joint	54T	28	39	63	112.5	63	I
	2002.04-		MT		F	Box Engine 8140.43S	GC010011	Outer Joint	54T	35	45	70	117	73	I
	2002.04-		MT		F	Box Engine 8140.43S	GC010013	Outer Joint	54T	28	39	63	112.5	63	I
2.8 JTD (94 kW)	2002.04-	2006.07	MT		F	Platform/Chassis Engine 8140.43S	GC010011	Outer Joint	54T	35	45	70	117	73	I
	2002.04-	2006.07	MT		F	Platform/Chassis Engine 8140.43S	GC010013	Outer Joint	54T	28	39	63	112.5	63	I
	2002.04-	2006.07	MT		F	Platform/Chassis Engine 8140.43S	GC010013	Outer Joint	54T	28	39	63	112.5	63	I
2.8 JTD 4x4 (94 kW)	2002.07-		MT		F	Box Engine 8140.43S	GC010013	Outer Joint	54T	28	39	63	112.5	63	I
	2002.10-	2006.07	MT		F	Platform/Chassis Engine 8140.43S	GC010013	Outer Joint	54T	28	39	63	112.5	63	I
<b>DUCATO (244, Z_)</b>															
2.0 (81 kW)	2002.04-		MT		F	Bus Engine RFL	GC010011	Outer Joint	54T	35	45	70	117	73	I
	2002.04-		MT		F	Bus Engine RFL	GC010013	Outer Joint	54T	28	39	63	112.5	63	I
2.0 JTD (62 kW)	2002.04-		MT		F	Bus Engine RHV(DW10)	GC010013	Outer Joint	54T	28	39	63	112.5	63	I
2.3 JTD (81 kW)	2002.04-		MT		F	Bus Engine F1AE0481C	GC010011	Outer Joint	54T	35	45	70	117	73	I
	2002.04-		MT		F	Bus Engine F1AE0481C	GC010013	Outer Joint	54T	28	39	63	112.5	63	I
2.8 JTD (94 kW)	2002.04-		MT		F	Bus Engine 8140.43S	GC010011	Outer Joint	54T	35	45	70	117	73	I
2.8 JTD (94 kW)	2002.04-		MT		F	Bus Engine 8140.43S	GC010013	Outer Joint	54T	28	39	63	112.5	63	I
2.8 JTD 4x4 (94 kW)	2002.07-		MT		F	Bus Engine 8140.43S	GC010013	Outer Joint	54T	28	39	63	112.5	63	I
<b>DUCATO (250)</b>															
2,2 D Multijet (74 kW)	2006.07-		5MT/6MT		F	Box Engine 4HV	GC017045	Outer Joint		35	29	71.5	127	71	M
	2006.07-		5MT/6MT		F	Box Engine 4HV	GC017055	Outer Joint		35	27	71.5	127	66.5	I
	2006.07-		5MT/6MT		F	Box Engine 4HV	GCI17020	Inner Joint		41	29	34.85	403	109	
	2006.07-		5MT/6MT		F	Box Engine 4HV	GCI10038	Inner Joint		41	27	34.85	403	102	
	2006.07-		5MT/6MT		F	Bus Engine 4HV	GC017045	Outer Joint		35	29	71.5	127	71	M
	2006.07-		5MT/6MT		F	Bus Engine 4HV	GC017055	Outer Joint		35	27	71.5	127	66.5	I
	2006.07-		5MT/6MT		F	Bus Engine 4HV	GCI17020	Inner Joint		41	29	34.85	403	109	
	2006.07-		5MT/6MT		F	Bus Engine 4HV	GCI10038	Inner Joint		41	27	34.85	403	102	
	2006.07-		5MT/6MT		F	Bus Engine 4HV	GCI17042	Inner Joint		41	27	43	70	102	
	2006.07-		5MT/6MT		F	Bus Engine 4HV	GCI17042	Inner Joint		41	27	43	70	102	
	2006.07-		5MT/6MT		F	Platform/Chassis Engine 4HV	GC017045	Outer Joint		35	29	71.5	127	71	M
	2006.07-		5MT/6MT		F	Platform/Chassis Engine 4HV	GC017055	Outer Joint		35	27	71.5	127	66.5	I
	2006.07-		5MT/6MT		F	Platform/Chassis Engine 4HV	GCI17020	Inner Joint		41	29	34.85	403	109	
	2006.07-		5MT/6MT		F	Platform/Chassis Engine 4HV	GCI10038	Inner Joint		41	27	34.85	403	102	
	2006.07-			L	F	Box Engine 4HV	GCI17042	Inner Joint		41	27	43	70	102	
	2006.07-			L	F	Platform/Chassis Engine 4HV	GCI17042	Inner Joint		41	27	43	70	102	
	2006.07-		5MT/6MT	L	F	Box Engine 4HV	GCI17028	Inner Joint		41	29	43	69.5	109.5	
	2006.07-		5MT/6MT	L	F	Bus Engine 4HV	GCI17028	Inner Joint		41	29	43	69.5	109.5	
	2006.07-		5MT/6MT	L	F	Bus Engine 4HV	GCI17042	Inner Joint		41	27	43	70	102	
	2006.07-		5MT/6MT	L	F	Platform/Chassis Engine 4HV	GCI17028	Inner Joint		41	29	43	69.5	109.5	
	2006.07-			L	F	Box Engine 4HV	GDS45176	Drive Shaft		35	41	71.5	127	808	
	2006.07-			L	F	Bus Engine 4HV	GDS45176	Drive Shaft		35	41	71.5	127	808	
	2006.07-			L	F	Platform/Chassis Engine 4HV	GDS45176	Drive Shaft		35	41	71.5	127	808	
	2006.07-			R	F	Box Engine 4HV	GDS17050	Drive Shaft		35	41	71.5	127	1140	
	2006.07-			R	F	Bus Engine 4HV	GDS17050	Drive Shaft		35	41	71.5	127	1140	
	2006.07-			R	F	Platform/Chassis Engine 4HV	GDS17050	Drive Shaft		35	41	71.5	127	1140	
2006.07-			R	F	Platform/Chassis Engine 4HV	GDS17050	Drive Shaft		35	41	71.5	127	1140		
2,3 D Multijet (83 kW)	2011.10-		MT	L	F	Box Engine F1AE3481G	GDS45176	Drive Shaft		35	41	71.5	127	808	
	2011.10-		MT	L	F	Bus Engine F1AE3481G	GDS45176	Drive Shaft		35	41	71.5	127	808	
	2011.10-		MT	L	F	Platform/Chassis Engine F1AE3481G	GDS45176	Drive Shaft		35	41	71.5	127	808	
	2011.10-		MT	R	F	Box Engine F1AE3481G	GDS17050	Drive Shaft		35	41	71.5	127	1140	









	 YEAR	TRANSM	L/R	F/R		G-AP Ref.	PRODUCT	ABS	Technical Specifications											
									A	B	C	H	L	P						
<b>FIAT</b>																				
<b>DUCATO (250)</b>																				
2,3 D Multijet (83 kW)	2011.10-	MT	R	F	Bus Engine F1AE3481G	GDS17050	Drive Shaft		35	41	71.5	127	1140							
	2011.10-	MT	R	F	Platform/Chassis Engine F1AE3481G	GDS17050	Drive Shaft		35	41	71.5	127	1140							
2,3 D Multijet (88 kW)	2006.07-	5MT/6MT		F	Box Engine F1AE0481D	GC017045	Outer Joint		35	29	71.5	127	71	M						
	2006.07-	5MT/6MT		F	Box Engine F1AE0481D	GC017055	Outer Joint		35	27	71.5	127	66.5	I						
	2006.07-	5MT/6MT		F	Box Engine F1AE0481D	GCI17020	Inner Joint		41	29	34.85	403	109							
	2006.07-	5MT/6MT		F	Box Engine F1AE0481D	GCI10038	Inner Joint		41	27	34.85	403	102							
	2006.07-	5MT/6MT		F	Bus Engine F1AE0481D	GC017045	Outer Joint		35	29	71.5	127	71	M						
	2006.07-	5MT/6MT		F	Bus Engine F1AE0481D	GC017055	Outer Joint		35	27	71.5	127	66.5	I						
	2006.07-	5MT/6MT		F	Bus Engine F1AE0481D	GCI17020	Inner Joint		41	29	34.85	403	109							
	2006.07-	5MT/6MT		F	Bus Engine F1AE0481D	GCI10038	Inner Joint		41	27	34.85	403	102							
	2006.07-	5MT/6MT		F	Platform/Chassis Engine F1AE0481D	GC017045	Outer Joint		35	29	71.5	127	71	M						
	2006.07-	5MT/6MT		F	Platform/Chassis Engine F1AE0481D	GC017055	Outer Joint		35	27	71.5	127	66.5	I						
	2006.07-	5MT/6MT		F	Platform/Chassis Engine F1AE0481D	GCI17020	Inner Joint		41	29	34.85	403	109							
	2006.07-	5MT/6MT		F	Platform/Chassis Engine F1AE0481D	GCI10038	Inner Joint		41	27	34.85	403	102							
	2006.07-	5MT/6MT	L	F	Box Engine F1AE0481D	GCI17028	Inner Joint		41	29	43	69.5	109.5							
	2006.07-	5MT/6MT	L	F	Box Engine F1AE0481D	GCI17042	Inner Joint		41	27	43	70	102							
	2006.07-	5MT/6MT	L	F	Bus Engine F1AE0481D	GCI17028	Inner Joint		41	29	43	69.5	109.5							
	2006.07-	5MT/6MT	L	F	Bus Engine F1AE0481D	GCI17042	Inner Joint		41	27	43	70	102							
	2006.07-	5MT/6MT	L	F	Platform/Chassis Engine F1AE0481D	GCI17028	Inner Joint		41	29	43	69.5	109.5							
	2006.07-	5MT/6MT	L	F	Platform/Chassis Engine F1AE0481D	GCI17042	Inner Joint		41	27	43	70	102							
	2006.07-		L	F	Box Engine F1AE0481D	GDS45176	Drive Shaft		35	41	71.5	127	808							
	2006.07-		L	F	Bus Engine F1AE0481D	GDS45176	Drive Shaft		35	41	71.5	127	808							
	2006.07-		L	F	Platform/Chassis Engine F1AE0481D	GDS45176	Drive Shaft		35	41	71.5	127	808							
	2006.07-		R	F	Box Engine F1AE0481D	GDS17050	Drive Shaft		35	41	71.5	127	1140							
	2006.07-		R	F	Bus Engine F1AE0481D	GDS17050	Drive Shaft		35	41	71.5	127	1140							
	2006.07-		R	F	Platform/Chassis Engine F1AE0481D	GDS17050	Drive Shaft		35	41	71.5	127	1140							
2,3 D Multijet (96 kW)	2007.01-		L	F	Box Engine F1AE0481N/F1AE3481D	GDS45176	Drive Shaft		35	41	71.5	127	808							
	2007.01-		L	F	Bus Engine F1AE3481D	GDS45176	Drive Shaft		35	41	71.5	127	808							
	2007.01-		L	F	Platform/Chassis Engine F1AE0481N/F1AE3481D	GDS45176	Drive Shaft		35	41	71.5	127	808							
	2007.01-		R	F	Box Engine F1AE0481N/F1AE3481D	GDS17050	Drive Shaft		35	41	71.5	127	1140							
	2007.01-		R	F	Bus Engine F1AE3481D	GDS17050	Drive Shaft		35	41	71.5	127	1140							
	2007.01-		R	F	Platform/Chassis Engine F1AE0481N/F1AE3481D	GDS17050	Drive Shaft		35	41	71.5	127	1140							
3.0 D Multijet (115 kW)	2006.07-	6MT		F	Box Engine F1CE3481M	GC017060	Outer Joint		35	29	71.5	127	71	I						
	2006.07-	6MT		F	Box Engine F1CE3481M	GCI17021	Inner Joint		31	29	34.85	530	109							
	2006.07-	6MT		F	Box Engine F1CE3481M	GCI17022	Inner Joint		31	29	44.95	77	109.5							
	2006.07-	6MT		F	Platform/Chassis Engine F1CE3481M	GC017060	Outer Joint		35	29	71.5	127	71	I						
	2006.07-	6MT		F	Platform/Chassis Engine F1CE3481M	GCI17021	Inner Joint		31	29	34.85	530	109							
	2006.07-	6MT		F	Platform/Chassis Engine F1CE3481M	GCI17022	Inner Joint		31	29	44.95	77	109.5							
	2006.07-		L	F	Box Engine F1CE3481M	GDS45175	Drive Shaft		35	31	71.5	127	749.5							
	2006.07-		L	F	Box Engine F1CE3481M	GCI17022	Inner Joint		31	29	44.95	77	109.5							
	2006.07-		L	F	Platform/Chassis Engine F1CE3481M	GDS45175	Drive Shaft		35	31	71.5	127	749.5							
	2006.07-		L	F	Platform/Chassis Engine F1CE3481M	GCI17022	Inner Joint		31	29	44.95	77	109.5							
	2006.07-		L/R	F	Box Engine F1CE3481M	GC017060	Outer Joint		35	29	71.5	127	71	I						
	2006.07-		L/R	F	Platform/Chassis Engine F1CE3481M	GC017060	Outer Joint		35	29	71.5	127	71	I						
	2006.07-		R	F	Box Engine F1CE3481M	GDS45174	Drive Shaft		35	31	71.5	127	1199							
	2006.07-		R	F	Box Engine F1CE3481M	GCI17021	Inner Joint		31	29	34.85	530	109							
	2006.07-		R	F	Platform/Chassis Engine F1CE3481M	GDS45174	Drive Shaft		35	31	71.5	127	1199							
	2006.07-		R	F	Platform/Chassis Engine F1CE3481M	GCI17021	Inner Joint		31	29	34.85	530	109							
	2006.10-	6MT		F	Bus Engine F1CE0481D	GCI17021	Inner Joint		31	29	34.85	530	109							
	2006.10-	6MT		F	Bus Engine F1CE0481D	GCI17022	Inner Joint		31	29	44.95	77	109.5							
	2006.10-		L	F	Bus Engine F1CE0481D	GDS45175	Drive Shaft		35	31	71.5	127	749.5							
	2006.10-		L	F	Bus Engine F1CE0481D	GCI17022	Inner Joint		31	29	44.95	77	109.5							
	2006.10-		L/R	F	Bus Engine F1CE0481D	GC017060	Outer Joint		35	29	71.5	127	71	I						
	2006.10-		R	F	Bus Engine F1CE0481D	GDS45174	Drive Shaft		35	31	71.5	127	1199							
	2006.10-		R	F	Bus Engine F1CE0481D	GCI17021	Inner Joint		31	29	34.85	530	109							
3.0 D Multijet (116 kW)	2006.07-	6MT		F	Box Engine F1CE0481D	GC017060	Outer Joint		35	29	71.5	127	71	I						
	2006.07-	6MT		F	Bus Engine F1CE0481D/F1CE3481M	GC017060	Outer Joint		35	29	71.5	127	71	I						
	2006.07-		L	F	Box Engine F1CE0481D	GDS45175	Drive Shaft		35	31	71.5	127	749.5							
	2006.07-		L	F	Box Engine F1CE0481D	GCI17022	Inner Joint		31	29	44.95	77	109.5							
	2006.07-		L	F	Platform/Chassis Engine F1CE0481D	GDS45175	Drive Shaft		35	31	71.5	127	749.5							
	2006.07-		L	F	Platform/Chassis Engine F1CE0481D	GCI17022	Inner Joint		31	29	44.95	77	109.5							
	2006.07-		L/R	F	Box Engine F1CE0481D	GC017060	Outer Joint		35	29	71.5	127	71	I						
	2006.07-		L/R	F	Platform/Chassis Engine F1CE0481D	GC017060	Outer Joint		35	29	71.5	127	71	I						



		TRANSM	L/R	F/R		G-AP Ref.	PRODUCT	ABS	Technical Specifications							
									YEAR	A	B	C	H	L	P	
<b>FIAT</b>																
<b>DUCATO (250)</b>																
3.0 D Multijet (116 kW)	2006.07-			R	F	Box Engine F1CE0481D	GDS45174	Drive Shaft		35	31	71.5	127	1199		
	2006.07-			R	F	Box Engine F1CE0481D	GCI17021	Inner Joint		31	29	34.85	530	109		
	2006.07-			R	F	Bus Engine F1CE0481D/F1CE3481M	GDS45174	Drive Shaft		35	31	71.5	127	1199		
	2006.07-			R	F	Bus Engine F1CE0481D/F1CE3481M	GCI17021	Inner Joint		31	29	34.85	530	109		
	2006.07-			R	F	Bus Engine F1CE0481D/F1CE3481M	GC017060	Outer Joint		35	29	71.5	127	71	I	
	2006.07-			R	F	Platform/Chassis Engine F1CE0481D	GDS45174	Drive Shaft		35	31	71.5	127	1199		
	2006.07-			R	F	Platform/Chassis Engine F1CE0481D	GCI17021	Inner Joint		31	29	34.85	530	109		
<b>DUCATO (280)</b>																
-							GC010104	Outer Joint	54T	28	27	63	112.5	63	I	
1.8 (49 kW)	1982.01-	1988.10		R	F	Box Engine 169B	GDS10013	Drive Shaft		28	25	63	112.5	1072		
	1982.01-	1988.10	MT		F	Box Engine 169B	GC010010	Outer Joint		28	27	63	112.5	63	I	
	1982.01-	1988.10	MT	L	F	Box Engine 169B	GDS10034	Drive Shaft		28	25	63	112.5	701		
	1982.01-	1988.10	MT	R	F	Box Engine 169B	GDS10068	Drive Shaft		28	25	63	112.5	1068		
1.9 D (52 kW)	1988.01-	1990.08		R	F	Box Engine 149B1.000	GDS10013	Drive Shaft		28	25	63	112.5	1072		
	1988.01-	1990.08		R	F	Platform/Chassis Engine 149B1.000	GDS10013	Drive Shaft		28	25	63	112.5	1072		
	1988.01-	1990.08	MT		F	Box Engine 149B1.000	GC010010	Outer Joint		28	27	63	112.5	63	I	
	1988.01-	1990.08	MT		F	Platform/Chassis Engine 149B1.000	GC010010	Outer Joint		28	27	63	112.5	63	I	
	1988.01-	1990.08	MT	L	F	Box Engine 149B1.000	GDS10034	Drive Shaft		28	25	63	112.5	701		
1.9 TD (60 kW)	1988.01-	1990.08	MT	L	F	Platform/Chassis Engine 149B1.000	GDS10034	Drive Shaft		28	25	63	112.5	701		
	1989.03-	1990.08		R	F	Box Engine 280A1.000	GDS10013	Drive Shaft		28	25	63	112.5	1072		
	1989.03-	1990.08		R	F	Platform/Chassis Engine 280A1.000	GDS10013	Drive Shaft		28	25	63	112.5	1072		
	1989.03-	1990.08	MT		F	Box Engine 280A1.000	GC010010	Outer Joint		28	27	63	112.5	63	I	
	1989.03-	1990.08	MT		F	Platform/Chassis Engine 280A1.000	GC010010	Outer Joint		28	27	63	112.5	63	I	
	1989.03-	1990.08	MT	L	F	Box Engine 280A1.000	GDS10034	Drive Shaft		28	25	63	112.5	701		
2.0 (55 kW)	1989.03-	1990.08	MT	L	F	Platform/Chassis Engine 280A1.000	GDS10034	Drive Shaft		28	25	63	112.5	701		
	1985.07-	1990.08	MT	R	F	Box Engine 170B	GDS10068	Drive Shaft		28	25	63	112.5	1068		
	1985.07-	1990.08	MT	R	F	Platform/Chassis Engine 170B	GDS10068	Drive Shaft		28	25	63	112.5	1068		
	1985.07-	1990.08		R	F	Box Engine 170B	GDS10013	Drive Shaft		28	25	63	112.5	1072		
	1985.07-	1990.08		R	F	Platform/Chassis Engine 170B	GDS10013	Drive Shaft		28	25	63	112.5	1072		
	1985.07-	1990.08	MT		F	Box Engine 170B	GC010010	Outer Joint		28	27	63	112.5	63	I	
	1985.07-	1990.08	MT		F	Platform/Chassis Engine 170B	GC010010	Outer Joint		28	27	63	112.5	63	I	
	1985.07-	1990.08	MT	L	F	Box Engine 170B	GDS10034	Drive Shaft		28	25	63	112.5	701		
2.0 (58 kW)	1985.07-	1990.08	MT	L	F	Platform/Chassis Engine 170B	GDS10034	Drive Shaft		28	25	63	112.5	701		
	1982.01-	1990.08	MT	R	F	Box Engine XN1T	GDS10068	Drive Shaft		28	25	63	112.5	1068		
	1982.01-	1990.08		R	F	Box Engine XN1T	GDS10013	Drive Shaft		28	25	63	112.5	1072		
	1982.01-	1990.08	MT		F	Box Engine XN1T	GC010010	Outer Joint		28	27	63	112.5	63	I	
	1982.01-	1990.08	MT	L	F	Box Engine XN1T	GDS10034	Drive Shaft		28	25	63	112.5	701		
2.0 (62 kW)	1988.08-	1990.08	MT	R	F	Platform/Chassis Engine 170D	GDS10068	Drive Shaft		28	25	63	112.5	1068		
	1988.08-	1990.08		R	F	Platform/Chassis Engine 170D	GDS10013	Drive Shaft		28	25	63	112.5	1072		
	1988.08-	1990.08	MT		F	Platform/Chassis Engine 170D	GC010010	Outer Joint		28	27	63	112.5	63	I	
	1988.08-	1990.08	MT	L	F	Platform/Chassis Engine 170D	GDS10034	Drive Shaft		28	25	63	112.5	701		
	1989.03-	1990.08	MT	R	F	Box Engine 170D	GDS10068	Drive Shaft		28	25	63	112.5	1068		
	1989.03-	1990.08		R	F	Box Engine 170D	GDS10013	Drive Shaft		28	25	63	112.5	1072		
	1989.03-	1990.08	MT		F	Box Engine 170D	GC010010	Outer Joint		28	27	63	112.5	63	I	
	1989.03-	1990.08	MT	L	F	Box Engine 170D	GDS10034	Drive Shaft		28	25	63	112.5	701		
2.4 D (53 kW)	1982.01-	1990.08		R	F	Box Engine 8144.61	GDS10013	Drive Shaft		28	25	63	112.5	1072		
2.5 D (55 kW)	1982.01-	1990.08	MT	R	F	Box Engine 8144.67/CRD93L(U25-661)	GDS10068	Drive Shaft		28	25	63	112.5	1068		
	1982.01-	1990.08		R	F	Box Engine 8144.67/CRD93L(U25-661)	GDS10013	Drive Shaft		28	25	63	112.5	1072		
	1982.01-	1990.08	MT		F	Box Engine 8144.67/CRD93L(U25-661)	GC010010	Outer Joint		28	27	63	112.5	63	I	
	1982.01-	1990.08	MT	L	F	Box Engine 8144.67/CRD93L(U25-661)	GDS10034	Drive Shaft		28	25	63	112.5	701		
	1982.07-	1990.08	MT	R	F	Platform/Chassis Engine 8144.67/CRD93L(U25-661)	GDS10068	Drive Shaft		28	25	63	112.5	1068		
	1982.07-	1990.08		R	F	Platform/Chassis Engine 8144.67/CRD93L(U25-661)	GDS10013	Drive Shaft		28	25	63	112.5	1072		
	1982.07-	1990.08	MT		F	Platform/Chassis Engine 8144.67/CRD93L(U25-661)	GC010010	Outer Joint		28	27	63	112.5	63	I	
	1982.07-	1990.08	MT	L	F	Platform/Chassis Engine 8144.67/CRD93L(U25-661)	GDS10034	Drive Shaft		28	25	63	112.5	701		
2.5 D 4x4 (55 kW)	1989.03-	1990.08	MT	R	F	Box Engine 8144.67	GDS10068	Drive Shaft		28	25	63	112.5	1068		
	1989.03-	1990.08	MT	R	F	Platform/Chassis Engine 8144.67	GDS10068	Drive Shaft		28	25	63	112.5	1068		
	1989.03-	1990.08		R	F	Box Engine 8144.67	GDS10013	Drive Shaft		28	25	63	112.5	1072		
	1989.03-	1990.08		R	F	Platform/Chassis Engine 8144.67	GDS10013	Drive Shaft		28	25	63	112.5	1072		
	1989.03-	1990.08	MT			Box Engine 8144.67	GC010010	Outer Joint		28	27	63	112.5	63	I	
	1989.03-	1990.08	MT			Platform/Chassis Engine 8144.67	GC010010	Outer Joint		28	27	63	112.5	63	I	
	1989.03-	1990.08	MT	L		Box Engine 8144.67	GDS10034	Drive Shaft		28	25	63	112.5	701		
	1989.03-	1990.08	MT	L		Platform/Chassis Engine 8144.67	GDS10034	Drive Shaft		28	25	63	112.5	701		

		TRANSM	L/R	F/R		G-AP Ref.	PRODUCT	ABS	Technical Specifications					
									YEAR	A	B	C	H	L
<b>FIAT</b>														
<b>DUCATO (280)</b>														
2.5 TD (68 kW)	1986.01-	1990.08	MT	R	F	Platform/Chassis Engine 8144.21	GDS10068	Drive Shaft		28	25	63	112.5	1068
	1986.01-	1990.08		R	F	Platform/Chassis Engine 8144.21	GDS10013	Drive Shaft		28	25	63	112.5	1072
	1986.01-	1990.08	MT		F	Platform/Chassis Engine 8144.21	GC010010	Outer Joint		28	27	63	112.5	63 I
	1986.01-	1990.08	MT	L	F	Platform/Chassis Engine 8144.21	GDS10034	Drive Shaft		28	25	63	112.5	701
<b>DUCATO (290)</b>														
-							GC010104	Outer Joint	54T	28	27	63	112.5	63 I
1.9 D (52 kW)	1990.07-	1994.03		R	F	Box Engine 149B1.000	GDS10013	Drive Shaft		28	25	63	112.5	1072
	1990.07-	1994.03	MT		F	Box Engine 149B1.000	GC010010	Outer Joint		28	27	63	112.5	63 I
	1990.07-	1994.03	MT	L	F	Box Engine 149B1.000	GDS10034	Drive Shaft		28	25	63	112.5	701
1.9 TD (60 kW)	1989.03-	1994.03	MT	R	F	Box Engine 280A1.000	GDS10068	Drive Shaft		28	25	63	112.5	1068
	1989.03-	1994.03	MT	R	F	Platform/Chassis Engine 280A1.000	GDS10068	Drive Shaft		28	25	63	112.5	1068
	1989.03-	1994.03		R	F	Box Engine 280A1.000	GDS10013	Drive Shaft		28	25	63	112.5	1072
	1989.03-	1994.03		R	F	Platform/Chassis Engine 280A1.000	GDS10013	Drive Shaft		28	25	63	112.5	1072
	1989.03-	1994.03	MT		F	Box Engine 280A1.000	GC010010	Outer Joint		28	27	63	112.5	63 I
	1989.03-	1994.03	MT		F	Platform/Chassis Engine 280A1.000	GC010010	Outer Joint		28	27	63	112.5	63 I
	1989.03-	1994.03	MT	L	F	Box Engine 280A1.000	GDS10034	Drive Shaft		28	25	63	112.5	701
	1989.03-	1994.03	MT	L	F	Platform/Chassis Engine 280A1.000	GDS10034	Drive Shaft		28	25	63	112.5	701
2.0 (62 kW)	1990.07-	1994.03	MT	R	F	Platform/Chassis Engine 170D	GDS10068	Drive Shaft		28	25	63	112.5	1068
	1990.07-	1994.03		R	F	Platform/Chassis Engine 170D	GDS10013	Drive Shaft		28	25	63	112.5	1072
	1990.07-	1994.03	MT		F	Platform/Chassis Engine 170D	GC010010	Outer Joint		28	27	63	112.5	63 I
	1990.07-	1994.03	MT	L	F	Platform/Chassis Engine 170D	GDS10034	Drive Shaft		28	25	63	112.5	701
2.5 D (55 kW)	1990.07-	1994.03	MT	R	F	Platform/Chassis Engine 8144.67	GDS10068	Drive Shaft		28	25	63	112.5	1068
	1990.07-	1994.03		R	F	Platform/Chassis Engine 8144.67	GDS10013	Drive Shaft		28	25	63	112.5	1072
	1990.07-	1994.03	MT		F	Platform/Chassis Engine 8144.67	GC010010	Outer Joint		28	27	63	112.5	63 I
	1990.07-	1994.03	MT	L	F	Platform/Chassis Engine 8144.67	GDS10034	Drive Shaft		28	25	63	112.5	701
2.5 D 4x4 (55 kW)	1990.07-	1994.03	MT	R	F	Box Engine 8144.67	GDS10068	Drive Shaft		28	25	63	112.5	1068
	1990.07-	1994.03	MT	R	F	Platform/Chassis Engine 8144.67	GDS10068	Drive Shaft		28	25	63	112.5	1068
	1990.07-	1994.03		R	F	Box Engine 8144.67	GDS10013	Drive Shaft		28	25	63	112.5	1072
	1990.07-	1994.03		R	F	Platform/Chassis Engine 8144.67	GDS10013	Drive Shaft		28	25	63	112.5	1072
	1990.07-	1994.03	MT			Box Engine 8144.67	GC010010	Outer Joint		28	27	63	112.5	63 I
	1990.07-	1994.03	MT			Platform/Chassis Engine 8144.67	GC010010	Outer Joint		28	27	63	112.5	63 I
	1990.07-	1994.03	MT	L		Box Engine 8144.67	GDS10034	Drive Shaft		28	25	63	112.5	701
	1990.07-	1994.03	MT	L		Platform/Chassis Engine 8144.67	GDS10034	Drive Shaft		28	25	63	112.5	701
2.5 TD (70 kW)	1990.07-	1994.03	MT	R	F	Box Engine 8140.27	GDS10068	Drive Shaft		28	25	63	112.5	1068
	1990.07-	1994.03	MT	R	F	Platform/Chassis Engine 8140.27	GDS10068	Drive Shaft		28	25	63	112.5	1068
	1990.07-	1994.03		R	F	Box Engine 8140.27	GDS10013	Drive Shaft		28	25	63	112.5	1072
	1990.07-	1994.03		R	F	Platform/Chassis Engine 8140.27	GDS10013	Drive Shaft		28	25	63	112.5	1072
	1990.07-	1994.03	MT		F	Box Engine 8140.27	GC010010	Outer Joint		28	27	63	112.5	63 I
	1990.07-	1994.03	MT		F	Platform/Chassis Engine 8140.27	GC010010	Outer Joint		28	27	63	112.5	63 I
	1990.07-	1994.03	MT	L	F	Box Engine 8140.27	GDS10034	Drive Shaft		28	25	63	112.5	701
	1990.07-	1994.03	MT	L	F	Platform/Chassis Engine 8140.27	GDS10034	Drive Shaft		28	25	63	112.5	701
	1990.07-	1994.03	MT	L	F	Box Engine 8140.27	GDS10068	Drive Shaft		28	25	63	112.5	1068
2.5 TD 4x4 (70 kW)	1990.07-	1994.03	MT	R	F	Box Engine 8140.27	GDS10068	Drive Shaft		28	25	63	112.5	1068
	1990.07-	1994.03	MT	R	F	Platform/Chassis Engine 8140.27	GDS10068	Drive Shaft		28	25	63	112.5	1068
	1990.07-	1994.03		R	F	Box Engine 8140.27	GDS10013	Drive Shaft		28	25	63	112.5	1072
	1990.07-	1994.03		R	F	Platform/Chassis Engine 8140.27	GDS10013	Drive Shaft		28	25	63	112.5	1072
	1990.07-	1994.03	MT			Box Engine 8140.27	GC010010	Outer Joint		28	27	63	112.5	63 I
	1990.07-	1994.03	MT			Platform/Chassis Engine 8140.27	GC010010	Outer Joint		28	27	63	112.5	63 I
	1990.07-	1994.03	MT	L		Box Engine 8140.27	GDS10034	Drive Shaft		28	25	63	112.5	701
	1990.07-	1994.03	MT	L		Platform/Chassis Engine 8140.27	GDS10034	Drive Shaft		28	25	63	112.5	701
	1990.07-	1994.03	MT	L	F	Box Engine 8140.27	GDS10068	Drive Shaft		28	25	63	112.5	1068
<b>DUCATO 250)</b>														
130 Multijet 2,3 D (93 kW)	2006.08-			L	F	Box Engine F1AE0481T	GDS45176	Drive Shaft		35	41	71.5	127	808
<b>DUCATO III-IV</b>														
2.5 D	1994-	2006		L	F		GDS10033	Drive Shaft	54T	35	41	70	117	762
2.8 TDI	1994-	2006		L	F		GDS10033	Drive Shaft	54T	35	41	70	117	762
<b>DUCATO PANORAMA (280)</b>														
1.8 (51 kW)	1982.07-	1988.12	MT	R	F	Bus Engine XM7T	GDS10068	Drive Shaft		28	25	63	112.5	1068
	1982.07-	1988.12		R	F	Bus Engine XM7T	GDS10013	Drive Shaft		28	25	63	112.5	1072
	1982.07-	1988.12	MT		F	Bus Engine XM7T	GC010010	Outer Joint		28	27	63	112.5	63 I
	1982.07-	1988.12	MT	L	F	Bus Engine XM7T	GDS10034	Drive Shaft		28	25	63	112.5	701
1.9 D (52 kW)	1987.02-	1990.08		R	F	Bus Engine 149B1.000	GDS10013	Drive Shaft		28	25	63	112.5	1072
	1987.02-	1990.08	MT		F	Bus Engine 149B1.000	GC010010	Outer Joint		28	27	63	112.5	63 I
	1987.02-	1990.08	MT	L	F	Bus Engine 149B1.000	GDS10034	Drive Shaft		28	25	63	112.5	701











		TRANSM	L/R	F/R		G-AP Ref.	PRODUCT	ABS	Technical Specifications														
									YEAR	A	B	C	H	L	P								
<b>FIAT</b>																							
<b>DUCATO PANORAMA (280)</b>																							
1.9 TD (60 kW)	1989.03-1990.08			R	F	Bus Engine 280A1.000	GDS10013	Drive Shaft		28	25	63	112.5	1072									
	1989.03-1990.08	MT			F	Bus Engine 280A1.000	GC010010	Outer Joint		28	27	63	112.5	63	I								
	1989.03-1990.08	MT	L		F	Bus Engine 280A1.000	GDS10034	Drive Shaft		28	25	63	112.5	701									
2.0 (55 kW)	1986.01-1990.08	MT	R		F	Bus Engine 170B	GDS10068	Drive Shaft		28	25	63	112.5	1068									
	1986.01-1990.08			R	F	Bus Engine 170B	GDS10013	Drive Shaft		28	25	63	112.5	1072									
	1986.01-1990.08	MT			F	Bus Engine 170B	GC010010	Outer Joint		28	27	63	112.5	63	I								
	1986.01-1990.08	MT	L		F	Bus Engine 170B	GDS10034	Drive Shaft		28	25	63	112.5	701									
2.0 (58 kW)	1982.07-1985.05	MT	R		F	Bus Engine XN1T	GDS10068	Drive Shaft		28	25	63	112.5	1068									
	1982.07-1985.05			R	F	Bus Engine XN1T	GDS10013	Drive Shaft		28	25	63	112.5	1072									
	1982.07-1985.05	MT			F	Bus Engine XN1T	GC010010	Outer Joint		28	27	63	112.5	63	I								
	1982.07-1985.05	MT	L		F	Bus Engine XN1T	GDS10034	Drive Shaft		28	25	63	112.5	701									
2.0 (62 kW)	1988.09-1990.08	MT	R		F	Bus Engine 170D	GDS10068	Drive Shaft		28	25	63	112.5	1068									
	1988.09-1990.08			R	F	Bus Engine 170D	GDS10013	Drive Shaft		28	25	63	112.5	1072									
	1988.09-1990.08	MT			F	Bus Engine 170D	GC010010	Outer Joint		28	27	63	112.5	63	I								
	1988.09-1990.08	MT	L		F	Bus Engine 170D	GDS10034	Drive Shaft		28	25	63	112.5	701									
2.4 D (53 kW)	1982.07-1985.12			R	F	Bus Engine 8144.61	GDS10013	Drive Shaft		28	25	63	112.5	1072									
2.5 D (55 kW)	1986.01-1990.08	MT	R		F	Bus Engine 8144.67/CRD93L(U25-661)	GDS10068	Drive Shaft		28	25	63	112.5	1068									
	1986.01-1990.08			R	F	Bus Engine 8144.67/CRD93L(U25-661)	GDS10013	Drive Shaft		28	25	63	112.5	1072									
	1986.01-1990.08	MT			F	Bus Engine 8144.67/CRD93L(U25-661)	GC010010	Outer Joint		28	27	63	112.5	63	I								
	1986.01-1990.08	MT	L		F	Bus Engine 8144.67/CRD93L(U25-661)	GDS10034	Drive Shaft		28	25	63	112.5	701									
2.5 D 4x4 (55 kW)	1987.01-1990.08	MT	R		F	Bus Engine 8144.67	GDS10068	Drive Shaft		28	25	63	112.5	1068									
	1987.01-1990.08			R	F	Bus Engine 8144.67	GDS10013	Drive Shaft		28	25	63	112.5	1072									
	1987.01-1990.08	MT				Bus Engine 8144.67	GC010010	Outer Joint		28	27	63	112.5	63	I								
	1987.01-1990.08	MT	L			Bus Engine 8144.67	GDS10034	Drive Shaft		28	25	63	112.5	701									
2.5 TD (68 kW)	1987.01-1990.08	MT	R		F	Bus Engine 8144.21/8144.21.220	GDS10068	Drive Shaft		28	25	63	112.5	1068									
	1987.01-1990.08			R	F	Bus Engine 8144.21/8144.21.220	GDS10013	Drive Shaft		28	25	63	112.5	1072									
	1987.01-1990.08	MT			F	Bus Engine 8144.21/8144.21.220	GC010010	Outer Joint		28	27	63	112.5	63	I								
	1987.01-1990.08	MT	L		F	Bus Engine 8144.21/8144.21.220	GDS10034	Drive Shaft		28	25	63	112.5	701									
2.5 TD 4x4 (68 kW)	1986.01-1990.08	MT	R		F	Bus Engine 8144.21	GDS10068	Drive Shaft		28	25	63	112.5	1068									
	1986.01-1990.08			R	F	Bus Engine 8144.21	GDS10013	Drive Shaft		28	25	63	112.5	1072									
	1986.01-1990.08	MT				Bus Engine 8144.21	GC010010	Outer Joint		28	27	63	112.5	63	I								
	1986.01-1990.08	MT	L			Bus Engine 8144.21	GDS10034	Drive Shaft		28	25	63	112.5	701									
<b>DUCATO PANORAMA (290)</b>																							
1.9 D (52 kW)	1990.07-1994.03			R	F	Bus Engine 149B1.000	GDS10013	Drive Shaft		28	25	63	112.5	1072									
	1990.07-1994.03	MT			F	Bus Engine 149B1.000	GC010010	Outer Joint		28	27	63	112.5	63	I								
	1990.07-1994.03	MT	L		F	Bus Engine 149B1.000	GDS10034	Drive Shaft		28	25	63	112.5	701									
1.9 TD (60 kW)	1990.07-1994.03	MT	R		F	Bus Engine 280A1.000	GDS10068	Drive Shaft		28	25	63	112.5	1068									
	1990.07-1994.03			R	F	Bus Engine 280A1.000	GDS10013	Drive Shaft		28	25	63	112.5	1072									
	1990.07-1994.03	MT			F	Bus Engine 280A1.000	GC010010	Outer Joint		28	27	63	112.5	63	I								
	1990.07-1994.03	MT	L		F	Bus Engine 280A1.000	GDS10034	Drive Shaft		28	25	63	112.5	701									
2.0 (62 kW)	1990.07-1994.03	MT	R		F	Bus Engine 170D	GDS10068	Drive Shaft		28	25	63	112.5	1068									
	1990.07-1994.03			R	F	Bus Engine 170D	GDS10013	Drive Shaft		28	25	63	112.5	1072									
	1990.07-1994.03	MT			F	Bus Engine 170D	GC010010	Outer Joint		28	27	63	112.5	63	I								
	1990.07-1994.03	MT	L		F	Bus Engine 170D	GDS10034	Drive Shaft		28	25	63	112.5	701									
2.5 D (55 kW)	1990.07-1994.03	MT	R		F	Bus Engine 8144.67	GDS10068	Drive Shaft		28	25	63	112.5	1068									
	1990.07-1994.03			R	F	Bus Engine 8144.67	GDS10013	Drive Shaft		28	25	63	112.5	1072									
	1990.07-1994.03	MT			F	Bus Engine 8144.67	GC010010	Outer Joint		28	27	63	112.5	63	I								
	1990.07-1994.03	MT	L		F	Bus Engine 8144.67	GDS10034	Drive Shaft		28	25	63	112.5	701									
2.5 D 4x4 (55 kW)	1990.07-1994.03	MT	R		F	Bus Engine 8144.67	GDS10068	Drive Shaft		28	25	63	112.5	1068									
	1990.07-1994.03			R	F	Bus Engine 8144.67	GDS10013	Drive Shaft		28	25	63	112.5	1072									
	1990.07-1994.03	MT				Bus Engine 8144.67	GC010010	Outer Joint		28	27	63	112.5	63	I								
	1990.07-1994.03	MT	L			Bus Engine 8144.67	GDS10034	Drive Shaft		28	25	63	112.5	701									
2.5 TD (70 kW)	1990.08-1994.03	MT	R		F	Bus Engine 8140.27	GDS10068	Drive Shaft		28	25	63	112.5	1068									
	1990.08-1994.03			R	F	Bus Engine 8140.27	GDS10013	Drive Shaft		28	25	63	112.5	1072									
	1990.08-1994.03	MT			F	Bus Engine 8140.27	GC010010	Outer Joint		28	27	63	112.5	63	I								
	1990.08-1994.03	MT	L		F	Bus Engine 8140.27	GDS10034	Drive Shaft		28	25	63	112.5	701									
2.5 TD 4x4 (70 kW)	1991.01-1994.03	MT	R		F	Bus Engine 8140.27	GDS10068	Drive Shaft		28	25	63	112.5	1068									
	1991.01-1994.03			R	F	Bus Engine 8140.27	GDS10013	Drive Shaft		28	25	63	112.5	1072									
	1991.01-1994.03	MT				Bus Engine 8140.27	GC010010	Outer Joint		28	27	63	112.5	63	I								
	1991.01-1994.03	MT	L			Bus Engine 8140.27	GDS10034	Drive Shaft		28	25	63	112.5	701									



		TRANSM	L/R	F/R		G-AP Ref.	PRODUCT	ABS	Technical Specifications					
									YEAR	A	B	C	H	L
<b>FIAT DUCATO V</b>														
2.2 MJT	2006-		L	F		GDS17053	Drive Shaft		35	41	71.5	127	806	
	2006-		L	F		GCI17028	Inner Joint		41	29	43	69.5	109.5	
	2006-		R	F		GDS17050	Drive Shaft		35	41	71.5	127	1140	
	2006-		R	F		GCI17020	Inner Joint		41	29	34.85	403	109	
	2006-		R/L	F		GC017045	Outer Joint		35	29	71.5	127	71	M
2.3 MJT	2006-		L	F		GDS17053	Drive Shaft		35	41	71.5	127	806	
	2006-		L	F		GCI17028	Inner Joint		41	29	43	69.5	109.5	
	2006-		R	F		GDS17050	Drive Shaft		35	41	71.5	127	1140	
	2006-		R	F		GCI17020	Inner Joint		41	29	34.85	403	109	
	2006-		R/L	F		GC017045	Outer Joint		35	29	71.5	127	71	M
3.0 MJT	2006-		L	F		GCI17028	Inner Joint		41	29	43	69.5	109.5	
	2006-		R	F		GCI17020	Inner Joint		41	29	34.85	403	109	
	2006-		R/L	F		GC017045	Outer Joint		35	29	71.5	127	71	M
<b>DUNA (146 B)</b>														
1.1 (43 kW)	1987.01-	1991.12	MT	F	Saloon Engine 146A6.000	GC017005	Outer Joint		22	20	48.1	90.5	59.5	O
1.3 (49 kW)	1987.01-	1991.12	MT	F	Saloon Engine 146A5.000	GC017005	Outer Joint		22	20	48.1	90.5	59.5	O
1.7 DS (44 kW)	1987.01-	1991.12	MT	F	Saloon Engine 149B3.000	GC017005	Outer Joint		22	20	48.1	90.5	59.5	O
<b>DUNA WEEKEND (146 B)</b>														
1.1 (43 kW)	1987.01-	1991.12	MT	F	Estate Engine 146A6.000	GC017005	Outer Joint		22	20	48.1	90.5	59.5	O
1.3 (49 kW)	1987.01-	1991.12	MT	F	Estate Engine 146A5.000	GC017005	Outer Joint		22	20	48.1	90.5	59.5	O
1.7 DS (44 kW)	1987.01-	1991.12	MT	F	Estate Engine 149B3.000	GC017005	Outer Joint		22	20	48.1	90.5	59.5	O
<b>FIORINO</b>														
1.3 MJT	2007-			F		GCI99008	Inner Joint		24	24	29.7	86.5	93	
	2007-		R	F		GDS17061	Drive Shaft		25	24	51	84.5	953	
	2007-		R	F		GDS17055	Drive Shaft		25	35.45	51	84.5	543	
	2007-		L	F		GDS17062	Drive Shaft		25	24	51	84.5	582	
	2007-		L	F		GDS17054	Drive Shaft		25	35.45	51	84.5	472	
	2007-		L	F		GC017028	Outer Joint		25	24	51	84.5	62	M
	2007-		L	F		GCI99008	Inner Joint		24	24	29.7	86.5	93	
<b>FIORINO (127)</b>														
1.1 (37 kW)	1980.01-	1987.12	MT	F	Box Engine 127A.000	GC017005	Outer Joint		22	20	48.1	90.5	59.5	O
900 (33 kW)	1977.10-	1984.12	MT	F	Box Engine 100GL.000	GC017005	Outer Joint		22	20	48.1	90.5	59.5	O
<b>FIORINO (146)</b>														
1.4 i.e. (49 kW)	1994.05-	2001.05	MT	F	Box Engine 146C5.000/146D5.000	GC017017	Outer Joint		22	20	52	91	60.5	O
1.6 (55 kW)	1994.01-	2001.05	MT	F	Pickup Engine 146C6.000/146D6.000	GC017017	Outer Joint		22	20	52	91	60.5	O
1.6 i.e. (55 kW)	1993.10-	2001.05	MT	F	Box Engine 146C6.000/146D6.000	GC017017	Outer Joint		22	20	52	91	60.5	O
1.7 D (42 kW)	1988.05-	1996.10	MT	F	Box Engine 146B2.000	GCI48004	Inner Joint			25		32		
	1993.10-	1999.10	MT	F	Pickup Engine 146B2.000	GC017017	Outer Joint		22	20	52	91	60.5	O
1.7 D (44 kW)	1988.05-	2000.05	MT	F	Box Engine 149B3.000	GCI18070	Inner Joint			25		32		
	1988.05-	1999.10	MT	F	Pickup Engine 149B3.000	GCI18070	Inner Joint			25		32		
	1988.05-	1999.10	MT	F	Pickup Engine 149B3.000	GC017005	Outer Joint		22	20	48.1	90.5	59.5	O
1.7 TD (46 kW)	1997.01-	2001.05	MT	F	Box Engine 146D7.000	GC017020	Outer Joint	44T	22	22	52	91	60.5	O
	1997.01-	2001.05	MT	F	Pickup Engine 146D7.000	GC017020	Outer Joint	44T	22	22	52	91	60.5	O
	1997.01-	2001.05	MT	F	Box Engine 146D7.000	GC017019	Outer Joint		22	22	52	91	60.5	O
	1997.01-	2001.05	MT	F	Pickup Engine 146D7.000	GC017019	Outer Joint		22	22	52	91	60.5	O
<b>FIORINO (147)</b>														
1.0 (37 kW)	1980.01-	1987.12	MT	F	Box Engine 127A.000	GC017005	Outer Joint		22	20	48.1	90.5	59.5	O
1.3 D (33 kW)	1982.03-	1987.12	MT	F	Box Engine 127A5.000	GC017005	Outer Joint		22	20	48.1	90.5	59.5	O
1.7 D (42 kW)	1988.01-	1993.10	MT	F	Box Engine 149B2.000	GCI18070	Inner Joint			25		32		
1.7 D (44 kW)	1987.12-	1990.12	MT	F	Box Engine 149B3.000	GCI18070	Inner Joint			25		32		
<b>FIORINO (225)</b>														
1.3 D Multijet (55 kW)	2007.11-		MT	F	Box Body / Estate Engine 199A2.000/199A9.000	GC017028	Outer Joint		25	24	51	84.5	62	M
	2007.11-		MT	L	F	Box Body / Estate Engine 199A2.000/199A9.000	GDS17147	Drive Shaft		25		51	84.5	480
	2007.11-			R	F	Box Body / Estate Engine 199A2.000/199A9.000	GDS17146	Drive Shaft		25		51	84.5	522
	2007.11-		MT	R	F	Box Body / Estate Engine 199A2.000/199A9.000	GDS17061	Drive Shaft		25	24	51	84.5	953
	2007.11-			R	F	Box Body / Estate Engine 199A2.000/199A9.000	GDS17157	Drive Shaft		25	24	51	84.5	919
	2007.11-			R	F	Box Body / Estate Engine 199A2.000/199A9.000	GCI17059	Inner Joint		24	24	29.8	394	100
1.4 (54 kW)	2007.11-		L/R	F	Box Body / Estate Engine KFT/KFV	GC017070	Outer Joint		22	22	51	79	57.5	M
1.4 Natural Power (57 kW)	2009.10-		L/R	F	Box Body / Estate Engine 350A1.000	GC017070	Outer Joint		22	22	51	79	57.5	M
<b>FREEMONT (JC)</b>														
2.0 JTD (100 kW)	2011.08-		MT	L		GCI17031	Inner Joint		25	26	32	59	110.5	

		TRANSM	L/R	F/R		G-AP Ref.	PRODUCT	ABS	Technical Specifications											
									YEAR	A	B	C	H	L	P					
<b>FIAT</b>																				
<b>FREEMONT (JC)</b>																				
2.0 JTD (103 kW)	2011.08-		AT	L		GCI17031	Inner Joint		25	26	32	59	110.5							
	2011.08-		MT	L		GCI17031	Inner Joint		25	26	32	59	110.5							
2.0 JTD (125 kW)	2011.08-		AT	L		GCI17031	Inner Joint		25	26	32	59	110.5							
2.0 JTD 4x4 (103 kW)	2011.08-			L		GCI17031	Inner Joint		25	26	32	59	110.5							
2.0 JTD 4x4 (125 kW)	2011.08-			L		GCI17031	Inner Joint		25	26	32	59	110.5							
<b>GRANDE PUNTO</b>																				
1.3 MJT	2005-			L	F	GDS17060	Drive Shaft		25	24	51	84.5	608							
	2005-			L	F	GCI17011	Inner Joint		24	23	29.7	86.5	93							
	2005-			L/R	F	GCO17053	Outer Joint		25	23	51	84.5	60	M						
	2005-			R	F	GDS17059	Drive Shaft		25	24	51	84.5	925							
	2005-			R	F	GCI17012	Inner Joint		24	23	29.7	379	100.5							
<b>GRANDE PUNTO (199)</b>																				
1.2 (48 kW)	2005.10-				Type GKN	GCI17027	Inner Joint		22	22	36	61.5	93.5							
1.3 D Multijet (51 kW)	2005.10-			L		GCI17011	Inner Joint		24	23	29.7	86.5	93							
	2005.10-			R		GCI17012	Inner Joint		24	23	29.7	379	100.5							
1.3 D Multijet (55 kW)	2005.10-			L		GCI17011	Inner Joint		24	23	29.7	86.5	93							
	2005.10-			R		GCI17012	Inner Joint		24	23	29.7	379	100.5							
1.3 D Multijet (56 kW)	2009.06-		MT	R	F	Hatchback Engine 199 A2.000	GDS17109	Drive Shaft	25	24	51	84.5	908							
	2009.06-		MT	R	F	Hatchback Engine 199 A2.000	GCI17012	Inner Joint	24	23	29.7	379	100.5							
1.3 D Multijet (61 kW)	2005.10-			L		GCI17025	Inner Joint		24	24	29.7	86.5	93							
	2005.10-			R		GCI17026	Inner Joint		24	24	29.7	379	100.5							
1.3 D Multijet (62 kW)	2005.10-			L		GCI17011	Inner Joint		24	23	29.7	86.5	93							
	2005.10-			R		GCI17012	Inner Joint		24	23	29.7	379	100.5							
1.3 D Multijet (66 kW)	2005.10-			L		GCI99008	Inner Joint		24	24	29.7	86.5	93							
	2005.10-			L		GCI44014	Inner Joint		25	23	34.9	57.5	102							
	2005.10-			R		GCI17056	Inner Joint		25	23	34.9	400	97							
	2005.10-					GCO17028	Outer Joint		25	24	51	84.5	62	M						
1.4 16V (70 kW)	2005.10-				GCI17027	Inner Joint		22	22	36	61.5	93.5								
1.4 16V (88 kW)	2005.10-				GCO17063	Outer Joint		25	25	51.1	84.5	61	M							
1.4 Abarth (114 kW)	2007.12-				GCO17065	Outer Joint		25	33	51.1	84.5	61	I							
1.4 LPG Natural Power (57 kW)	2005.10-				GCI17027	Inner Joint		22	22	36	61.5	93.5								
1.4 T-Jet (88 kW)	2007.09-			L		GCI17025	Inner Joint		24	24	29.7	86.5	93							
1.6 D Multijet (88 kW)	2008.07-					GCO17065	Outer Joint		25	33	51.1	84.5	61	I						
	2005.10-					GCO17065	Outer Joint		25	33	51.1	84.5	61	I						
	2006.06-		MT	L	F	Hatchback Engine 939 A7.000	GDS17142	Drive Shaft	25	25	51.1	84.5	588							
	2006.06-		MT	R	F	Hatchback Engine 939 A7.000	GDS17143	Drive Shaft	25	25	51.1	84.5	953							
1.9 D Multijet (88 kW)	2005.10-					GCO17065	Outer Joint		25	33	51.1	84.5	61	I						
1.9 D Multijet (96 kW)	2005.10-					GCO17065	Outer Joint		25	33	51.1	84.5	61	I						
<b>GRANDE PUNTO (199), VAN</b>																				
1.4 (55 kW)	2009.03-					GCI17027	Inner Joint		22	22	36	61.5	93.5							
1.4 (57 kW)	2009.03-					GCI17027	Inner Joint		22	22	36	61.5	93.5							
1.4 LPG, Natural Power (57 kW)	2009.03-					GCI17027	Inner Joint		22	22	36	61.5	93.5							
<b>IDEA</b>																				
1.2 16V (59 kW)	2004.01-				F	MPV Engine 188A5.000	GCO17014	Outer Joint	22	21	51	79.5	54	M						
	2004.01-					MPV Engine 188A5.000	GCI17027	Inner Joint	22	22	36	61.5	93.5							
	2004.01-					MPV Engine 188A5.000	GC083099	Outer Joint	38	27	59.5	34.5	64	M						
1.3 D Multijet (66 kW)	2005.10-				F	MPV Engine 199A3.000	GCO17028	Outer Joint	25	24	51	84.5	62	M						
	2005.10-	2008.05		L			GCI99008	Inner Joint	24	24	29.7	86.5	93							
	2005.10-			L	F	MPV Engine 199A3.000	GDS17054	Drive Shaft	25	35.45	51	84.5	472							
	2005.10-						GCO17028	Outer Joint	25	24	51	84.5	62	M						
1.3 D Multijet (66kW)	2005.10-	2008.05		R		GCI17015	Inner Joint	24	24	29.7	379	100.5								
1.3 D Multijet (70 kW)	2005.10-	2008.05		L			GCI99008	Inner Joint	24	24	29.7	86.5	93							
	2005.10-	2008.05		R			GCI17015	Inner Joint	24	24	29.7	379	100.5							
1.3 JTD (51 kW)	2004.01-				F	MPV Engine 188A9.000	GCO17027	Outer Joint	25	23	51	84.5	60	M						
	2004.01-				F	MPV Engine 188A9.000	GCI82005	Inner Joint		25		32								
	2004.01-		5MT	L	F	MPV Engine 188A9.000	GDS17147	Drive Shaft	25		51	84.5	480							
	2004.01-		5MT	R	F	MPV Engine 188A9.000	GDS17066	Drive Shaft	25	33.9	51	84.5	497							
	2004.01-			L			GCI17011	Inner Joint	24	23	29.7	86.5	93							
	2004.01-			R			GCI17012	Inner Joint	24	23	29.7	379	100.5							
	2004.01-						GCO17027	Outer Joint	25	23	51	84.5	60	M						
1.4 (57 kW)	2003.12-	2005.10					GCI17027	Inner Joint	22	22	36	61.5	93.5							
	2005.10-				F	MPV Engine 350A1.000	GCO17014	Outer Joint	22	21	51	79.5	54	M						









		TRANSM	L/R	F/R		G-AP Ref.	PRODUCT	ABS	Technical Specifications						
									YEAR	A	B	C	H	L	P
<b>FIAT</b>															
<b>IDEA</b>															
1.4 (66 kW)	2003.12-				MPV Engine 192B2.000	GCI17027	Inner Joint		22	22	36	61.5	93.5		
1.4 16V (70 kW)	2004.01-			F	MPV Engine 843A1.000	GC017014	Outer Joint		22	21	51	79.5	54	M	
	2004.01-				MPV Engine 843A1.000	GCI17027	Inner Joint		22	22	36	61.5	93.5		
1.4 8V	2003.01-	2010.12				GC017059	Outer Joint		22	21	47	89	54	M	
1.6 D Multijet (88 kW)	2008.05-			L		GCI17005	Inner Joint		25	26	32	91	95		
	2008.05-			R		GCI17006	Inner Joint		25	26	29.8	377	108		
1.8 8V						GCI17018	Inner Joint			25		32			
						GDS17031	Drive Shaft						336		
	NULL-					GCI17018	Inner Joint			25		32			
1.9 JTD (74 kW)	2004-					GC017028	Outer Joint		25	24	51	84.5	62	M	
	2004.01-			F	MPV Engine 188B2.000	GC017028	Outer Joint		25	24	51	84.5	62	M	
	2004.01-			R		GCI17062	Inner Joint		34	24	34.9	300	102.5		
<b>LINEA</b>															
1.3 JTD (63 kW)	2007.06-			L		GCI17025	Inner Joint		24	24	29.7	86.5	93		
	2007.06-			R		GCI17026	Inner Joint		24	24	29.7	379	100.5		
	2007.06-					GC017063	Outer Joint		25	25	51.1	84.5	61	M	
1.3 MJT	2007-			L	F	GDS17064	Drive Shaft		25	39.2	51.1	84.5	471		
	2007-			L	F	GDS17058	Drive Shaft		25	24	51.1	84.5	582		
	2007-			R	F	GDS17063	Drive Shaft		25	39.2	51.1	84.5	538		
	2007-			L	F	GCI17025	Inner Joint		24	24	29.7	86.5	93		
	2007-			R	F	GCI17026	Inner Joint		24	24	29.7	379	100.5		
	2007-			R	F	GDS17057	Drive Shaft		25	24	51.1	84.5	949		
1.4	2007-			L	F	GDS17088	Drive Shaft		22	31.95	51	79	552		
	2007-			L/R	F	GC017070	Outer Joint		22	22	51	79	57.5	M	
	2007-			R	F	GDS17089	Drive Shaft		22	31.95	51	79	793		
1.4 (57 kW)	2007.06-				GC017070	Outer Joint		22	22	51	79	57.5	M		
1.4 T-Jet (88 kW)	2007.09-			L		GCI17025	Inner Joint		24	24	29.7	86.5	93		
	2007.09-					GC017063	Outer Joint		25	25	51.1	84.5	61	M	
1.6 D Multijet (77 kW)	2009.06-			L		GCI17031	Inner Joint		25	26	32	59	110.5		
	2009.06-					GC017063	Outer Joint		25	25	51.1	84.5	61	M	
<b>LINEA (323)</b>															
1.3 D Multijet (66 kW)	2007.06-		MT	L/R	F	Saloon Engine 199A3.000	GC017063	Outer Joint		25	25	51.1	84.5	61	M
1.4 (57 kW)	2007.06-			L/R	F	Saloon Engine 350A1.000	GC017070	Outer Joint		22	22	51	79	57.5	M
	2007.06-					Saloon Engine 350A1.000	GCI17027	Inner Joint		22	22	36	61.5	93.5	
1.4 T-Jet (88 kW)	2007.09-			L/R	F	Saloon Engine 198A4.000	GC017063	Outer Joint		25	25	51.1	84.5	61	M
1.6 D Multijet (77 kW)	2009.06-			L/R	F	Saloon Engine 198A3.000	GC017063	Outer Joint		25	25	51.1	84.5	61	M
<b>LYBRA (839AX, BX), SW</b>															
2.0 20V (110 kW)	2000.09-					GC082008	Outer Joint		25	25	59	85	58	O	
<b>MAREA</b>															
1.6 16V	2006.01-	2007.12	MT		Exceto Turbo / Excepto Turbo / Except Turbo	GCI82011	Inner Joint			25		32			
1.8 16V	1998.01-	2004.12	MT		Exceto Turbo / excepto Turbo / Except Turbo	GCI82011	Inner Joint			25		32			
2.0 16V	1998.01-	2004.12	MT			GCI17038	Inner Joint			25		32			
2.0 20V	1998.01-	2004.12	MT			GCI17038	Inner Joint			25		32			
<b>MAREA (185)</b>															
1.2 16V (60 kW)	1998.10-	2002.05			F	Saloon Engine 182B2.000	GC017015	Outer Joint		22	22	51	79.5	54	O
1.4 12V (59 kW)	1996.09-	2002.05	5MT		F	Saloon Engine 182A3.000	GCI82005	Inner Joint			25		32		
	1996.09-	2002.05	MT/AT		F	Saloon Engine 182A3.000	GC017039	Outer Joint	44T	22	20	46.8	75.5	52	O
	1996.09-	2002.05	MT/AT		F	Saloon Engine 182A3.000	GC017001	Outer Joint		22	20	46.8	75.5	52	O
	1996.09-	2002.05	MT	L	F	Saloon Engine 182A3.000	GDS17010	Drive Shaft		22	31.95	46.8	75.5	569	
	1996.09-	2002.05	MT	L	F	Saloon Engine 182A3.000	GC017001	Outer Joint		22	20	46.8	75.5	52	O
	1996.09-	2002.05	MT	R	F	Saloon Engine 182A3.000	GDS17011	Drive Shaft		22	31.95	46.8	75.5	928.5	
1.6 100 16V Bipower (76 kW)	1999.04-	2002.05	MT/AT		F	Saloon Engine 185A3.000/186A4.000	GC017011	Outer Joint		25	22	51	84.5	57	O
1.6 16V (76 kW)	1996.09-	2002.05	MT/AT		F	Saloon Engine 182A4.000	GC017023	Outer Joint		25	22	52	84	57	O
	1996.09-	2002.05	MT/AT		F	Saloon Engine 182A4.000	GCI82005	Inner Joint			25		32		
	1996.09-	2002.05	MT/AT		F	Saloon Engine 182A4.000	GC082005	Outer Joint	44T	25	22	52	84	57	O
1.8 16V (83 kW)	1996.09-	2002.05	5MT		F	Saloon Engine 182A2.000	GC017042	Outer Joint		25	25	51	85	58	O
	1996.09-	2002.05	5MT		F	Saloon Engine 182A2.000	GCI82005	Inner Joint			25		32		
	1996.09-	2002.05	MT/AT		F	Saloon Engine 182A2.000	GC082006	Outer Joint	44T	25	25	52	85	58	O
	1996.09-	2002.05	MT/AT		F	Saloon Engine 182A2.000	GC082003	Outer Joint		25	25	52	85	58	O
1.9 JTD (81 kW)	2001-					GC017042	Outer Joint		25	25	51	85	58	O	
	2001.01-	2002.05			F	Saloon Engine 186A6.000	GC017042	Outer Joint		25	25	51	85	58	O

						G-AP Ref.	PRODUCT	ABS	Technical Specifications						
									A	B	C	H	L	P	
YEAR	YEAR														
<b>FIAT</b>															
<b>MAREA (185)</b>															
1.9 TD (55 kW)	1996.09-	2002.05	5MT		F	Saloon Engine 182A8.000	GC017042	Outer Joint		25	25	51	85	58	O
	1996.09-	2002.05	5MT		F	Saloon Engine 182A8.000	GCI82005	Inner Joint			25		32		
	1996.09-	2002.05	MT/AT		F	Saloon Engine 182A8.000	GC082006	Outer Joint	44T	25	25	52	85	58	O
	1996.09-	2002.05	MT/AT		F	Saloon Engine 182A8.000	GC082003	Outer Joint		25	25	52	85	58	O
	1996.09-	2002.05		L	F	Saloon Engine 182A8.000	GDS99048	Drive Shaft		25		52	85	467	
1.9 TD (74 kW)	1996.09-	2002.05	5MT		F	Saloon Engine 182A7.000	GC017042	Outer Joint		25	25	51	85	58	O
	1996.09-	2002.05	5MT		F	Saloon Engine 182A7.000	GCI82005	Inner Joint			25		32		
	1996.09-	2002.05	MT/AT		F	Saloon Engine 182A7.000	GC082006	Outer Joint	44T	25	25	52	85	58	O
	1996.09-	2002.05	MT/AT		F	Saloon Engine 182A7.000	GC082003	Outer Joint		25	25	52	85	58	O
2.0 20V (108 kW)	1996.09-	1999.04	MT/AT		F	Saloon Engine 182A1.000	GC017032	Outer Joint	44T	25	25	59	85	58	O
2.0 20V (110 kW)	2001-						GC082008	Outer Joint		25	25	59	85	58	O
2.4 JTD (96 kW)	1999.04-	2002.05	MT		F	Saloon Engine 185A6.000/839A5.000	GC082012	Outer Joint		25	28	59	85	63	O
2.4 TD (91 kW)	1996.09-	1999.04	MT/AT		F	Saloon Engine 185A2.000	GC082019	Outer Joint		25	28	56	85	63.5	O
<b>MAREA WEEKEND</b>															
1.8 16V	1998.01-	2006.12	MT			Exceto Turbo / excepto Turbo / Except Turbo	GCI82011	Inner Joint			25		32		
2.0 16V	1998.01-	2006.12	MT				GCI17038	Inner Joint			25		32		
<b>MAREA WEEKEND (185)</b>															
1.2 16V (60 kW)	1998.10-	2002.05			F	Estate Engine 182B2.000	GC017015	Outer Joint		22	22	51	79.5	54	O
	1998.10-	2002.05				Estate Engine 182B2.000	GCI17027	Inner Joint		22	22	36	61.5	93.5	
1.4 12V (59 kW)	1996.09-	2002.05	5MT		F	Estate Engine 182A3.000	GCI82005	Inner Joint			25		32		
	1996.09-	2002.05	MT/AT		F	Estate Engine 182A3.000	GC017039	Outer Joint	44T	22	20	46.8	75.5	52	O
	1996.09-	2002.05	MT/AT		F	Estate Engine 182A3.000	GC017001	Outer Joint		22	20	46.8	75.5	52	O
	1996.09-	2002.05	MT	L	F	Estate Engine 182A3.000	GDS17010	Drive Shaft		22	31.95	46.8	75.5	569	
	1996.09-	2002.05	MT	L	F	Estate Engine 182A3.000	GC017001	Outer Joint		22	20	46.8	75.5	52	O
	1996.09-	2002.05	MT	R	F	Estate Engine 182A3.000	GDS17011	Drive Shaft		22	31.95	46.8	75.5	928.5	
1.6 16V (76 kW)	1996.09-	2002.05	MT/AT		F	Estate Engine 182A4.000	GC017023	Outer Joint		25	22	52	84	57	O
	1996.09-	2002.05	MT/AT		F	Estate Engine 182A4.000	GCI82005	Inner Joint			25		32		
	1996.09-	2002.05	MT/AT		F	Estate Engine 182A4.000	GC082005	Outer Joint	44T	25	22	52	84	57	O
1.8 16V (83 kW)	1996.09-	2002.05	5MT		F	Estate Engine 182A2.000	GC017042	Outer Joint		25	25	51	85	58	O
	1996.09-	2002.05	5MT		F	Estate Engine 182A2.000	GCI82005	Inner Joint			25		32		
	1996.09-	2002.05	MT/AT		F	Estate Engine 182A2.000	GC082006	Outer Joint	44T	25	25	52	85	58	O
	1996.09-	2002.05	MT/AT		F	Estate Engine 182A2.000	GC082003	Outer Joint		25	25	52	85	58	O
1.9 JTD (77 kW)	1999.04-	2002.05	5MT		F	Estate Engine 182B4.000	GC017042	Outer Joint		25	25	51	85	58	O
1.9 JTD (81 kW)	1999.03-	2003.02			F	Estate Engine 186A6.000	GC017042	Outer Joint		25	25	51	85	58	O
1.9 TD (55 kW)	1996.09-	2002.05	5MT		F	Estate Engine 182A8.000	GC017042	Outer Joint		25	25	51	85	58	O
	1996.09-	2002.05	5MT		F	Estate Engine 182A8.000	GCI82005	Inner Joint			25		32		
	1996.09-	2002.05	MT/AT		F	Estate Engine 182A8.000	GC082006	Outer Joint	44T	25	25	52	85	58	O
	1996.09-	2002.05	MT/AT		F	Estate Engine 182A8.000	GC082003	Outer Joint		25	25	52	85	58	O
	1996.09-	2002.05		L	F	Estate Engine 182A8.000	GDS99048	Drive Shaft		25		52	85	467	
1.9 TD (74 kW)	1996.09-	2002.05	5MT		F	Estate Engine 182A7.000/182B9.000	GC017042	Outer Joint		25	25	51	85	58	O
	1996.09-	2002.05	5MT		F	Estate Engine 182A7.000/182B9.000	GCI82005	Inner Joint			25		32		
	1996.09-	2002.05	MT/AT		F	Estate Engine 182A7.000/182B9.000	GC082006	Outer Joint	44T	25	25	52	85	58	O
	1996.09-	2002.05	MT/AT		F	Estate Engine 182A7.000/182B9.000	GC082003	Outer Joint		25	25	52	85	58	O
2.0 20V (108 kW)	1996.09-	1999.04	MT/AT		F	Estate Engine 182A1.000	GC017032	Outer Joint	44T	25	25	59	85	58	O
2.0 20V (113 kW)	1999.04-	2003.02	MT		F	Estate Engine 182B7.000	GC082003	Outer Joint		25	25	52	85	58	O
	1999.04-	2003.02	MT		F	Estate Engine 182B7.000	GC082006	Outer Joint	44T	25	25	52	85	58	O
2.4 JTD (96 kW)	1999.04-	2002.05	MT		F	Estate Engine 185A6.000/839A5.000	GC082012	Outer Joint		25	28	59	85	63	O
2.4 TD (91 kW)	1996.09-	1999.04	MT/AT		F	Estate Engine 185A2.000	GC082019	Outer Joint		25	28	56	85	63.5	O
<b>MULTIPLA (186)</b>															
1.6 16V (76 kW)	1999.04-	2010.06	5MT		F	MPV Engine 182A4.000	GCI82005	Inner Joint			25		32		
	1999.04-	2010.06	MT		F	MPV Engine 182A4.000	GC017011	Outer Joint		25	22	51	84.5	57	O
1.6 16V Bipower (76 kW)	1999.04-	2010.06	MT		F	MPV Engine 186A4.000	GC017011	Outer Joint		25	22	51	84.5	57	O
1.6 16V Blupower (70 kW)	1999.04-	2010.06	5MT		F	MPV Engine 186A3.000	GCI82005	Inner Joint			25		32		
	1999.04-	2010.06	MT		F	MPV Engine 186A3.000	GC017011	Outer Joint		25	22	51	84.5	57	O
1.9 JTD (77 kW)	1999.04-	2010.06	MT		F	MPV Engine 182B4.000	GC017042	Outer Joint		25	25	51	85	58	O
	1999.04-	2010.06	MT		F	MPV Engine 182B4.000	GCI82005	Inner Joint			25		32		
1.9 JTD (81 kW)	2001.03-	2002.07			F	MPV Engine 186A6.000	GC017042	Outer Joint		25	25	51	85	58	O
	2002.07-	2010.06			F	MPV Engine 186A8.000	GC017042	Outer Joint		25	25	51	85	58	O
1.9 JTD (85 kW)	2002.07-	2010.06			F	MPV Engine 186A8.000	GCI82005	Inner Joint			25		32		
	2006.02-	2010.06			F	MPV Engine 186A9.000	GC017042	Outer Joint		25	25	51	85	58	O
1.9 JTD (88 kW)	2006.02-	2010.06			F	MPV Engine 186A9.000	GCI82005	Inner Joint			25		32		



		TRANSM	L/R	F/R		G-AP Ref.	PRODUCT	ABS	Technical Specifications								
									YEAR	A	B	C	H	L	P		
<b>FIAT PALIO</b>																	
1.0 8V	2008-2006					GCO17093	Outer Joint		22	28	47	89	57	O			
1.2	2002-					GCI17027	Inner Joint		22	22	36	61.5	93.5				
1.2 16V	2002-		L	F		GDS17029	Drive Shaft		22	31.95	47	89	504				
	2002-		R	F		GDS17030	Drive Shaft		22	31.95	47	89	809				
1.2/1.4	1997-2002		L	F		GDS16002	Drive Shaft		22	31.95	47	89	571.5				
	1997-2002		R	F		GDS16001	Drive Shaft		22	31.95	47	89	918.5				
1.3 MJT	2003-2006		L	F		GDS17003	Drive Shaft		25		51	90	455				
	2003-2006		R	F		GDS17002	Drive Shaft		25		51	90	533				
	2005-		L	F		GDS17013	Drive Shaft		25	35.6	51	90	501				
	2005-		R	F		GDS17014	Drive Shaft		25	35.6	51	90	524				
	2005-		L	F		GDS17056	Drive Shaft		25	24	51	90	557				
1.4	2002-					GCI17027	Inner Joint		22	22	36	61.5	93.5				
1.4 16V	2002-		L	F		GDS17029	Drive Shaft		22	31.95	47	89	504				
	2002-		R	F		GDS17030	Drive Shaft		22	31.95	47	89	809				
1.4 8V	2008-					GCO17093	Outer Joint		22	28	47	89	57	O			
1.4/1.6			L			GDS17029	Drive Shaft		22	31.95	47	89	504				
			R			GDS17030	Drive Shaft		22	31.95	47	89	809				
1.6	1996-		R	F		GDS17007	Drive Shaft		22	31.95	52	91	904.5				
1.6 16V	2002-		L	F		GDS17029	Drive Shaft		22	31.95	47	89	504				
	2002-		R	F		GDS17030	Drive Shaft		22	31.95	47	89	809				
1.8 8V						GCI17018	Inner Joint			25		32					
<b>PALIO (178BX)</b>																	
1.0 (45 kW)	1996.04-		MT	F	Hatchback	GCO17020	Outer Joint	44T	22	22	52	91	60.5	O			
	1996.04-		MT	F	Hatchback	GCO17017	Outer Joint		22	20	52	91	60.5	O			
1.2 (44 kW)	1997.07-2002.08			F	Hatchback Engine 178B7.045/178C4.066/188A4.000	GCO17029	Outer Joint		22	20	47	89	61	O			
1.2 (54 kW)	1998.06-		MT	F	Hatchback Engine 176A8.000/178B5.000/178E2.000	GCO17020	Outer Joint	44T	22	22	52	91	60.5	O			
	1998.06-		MT	F	Hatchback Engine 176A8.000/178B5.000/178E2.000	GCO17017	Outer Joint		22	20	52	91	60.5	O			
1.4 (51 kW)	1996.04-		MT	F	Hatchback Engine 178B2.000	GCO17020	Outer Joint	44T	22	22	52	91	60.5	O			
	1996.04-		MT	F	Hatchback Engine 178B2.000	GCO17017	Outer Joint		22	20	52	91	60.5	O			
1.4 CAT (51 kW)	1996.04-		MT	F	Hatchback Engine 178B2.016	GCO17020	Outer Joint	44T	22	22	52	91	60.5	O			
	1996.04-		MT	F	Hatchback Engine 178B2.016	GCO17017	Outer Joint		22	20	52	91	60.5	O			
1.5 (57 kW)	1996.04-		MT	F	Hatchback	GCO17020	Outer Joint	44T	22	22	52	91	60.5	O			
	1996.04-		MT	F	Hatchback	GCO17019	Outer Joint		22	22	52	91	60.5	O			
1.6 16V (74 kW)	1996.04-		MT	F	Hatchback Engine 178B3.000	GCO17020	Outer Joint	44T	22	22	52	91	60.5	O			
	1996.04-		MT	F	Hatchback Engine 178B3.000	GCO17019	Outer Joint		22	22	52	91	60.5	O			
<b>PALIO (178BX, 178DX)</b>																	
1.3 MJT (55 kW)	2005.11-			L		GCI99008	Inner Joint		24	24	29.7	86.5	93				
<b>PALIO (178BX, 178DX), WEEKEND</b>																	
1.2 (44 kW)	1997.07-2002.08					GCI17027	Inner Joint		22	22	36	61.5	93.5				
1.2 (59 kW)	1997.07-2002.08					GCI17027	Inner Joint		22	22	36	61.5	93.5				
1.2 (70 kW)	1997.07-2002.08					GCI17027	Inner Joint		22	22	36	61.5	93.5				
1.3 MJT (55 kW)	2005-2011		R		India	GCI17015	Inner Joint		24	24	29.7	379	100.5				
1.4 (51 kW)	2002-					GCI17027	Inner Joint		22	22	36	61.5	93.5				
1.4 Kat (51 kW)	2002.07-					GCI17027	Inner Joint		22	22	36	61.5	93.5				
<b>PALIO SIENA (178BX)</b>																	
1.2 (54 kW)	2002-					GCO17029	Outer Joint		22	20	47	89	61	O			
1.4 Kat (51 kW)	2002-					GCO17037	Outer Joint		22	22	51	89	61	O			
1.4 SPI (51 kW)	2002-					GCO17037	Outer Joint		22	22	51	89	61	O			
1.6 16V (76 kW)	2001.02-					GCO17029	Outer Joint		22	20	47	89	61	O			
<b>PALIO WEEKEND</b>																	
1.3 MJT (55 kW)	2005.11-			L		GCI99008	Inner Joint		24	24	29.7	86.5	93				
1.8 8V						GCI17018	Inner Joint			25		32					
<b>PALIO WEEKEND (178DX)</b>																	
1.2 (44 kW)	2001.02-			F	Estate Engine 178C4.066/188A4.000	GCO17016	Outer Joint		22	22	47	89	61	O			
1.2 (54 kW)	1996.04-2001.02		L		Estate Engine 178B5.000	GDS17005	Drive Shaft		22	31.95	52	91	554				
	1996.04-2001.02			F	Estate Engine 178B5.000	GCO17056	Outer Joint		22	22	52	90	59.5	O			
	1996.04-2001.02		MT	F	Estate Engine 178B5.000	GCO17020	Outer Joint	44T	22	22	52	91	60.5	O			
	1996.04-2001.02		MT	F	Estate Engine 178B5.000	GCO17017	Outer Joint		22	20	52	91	60.5	O			
1.2 (59 kW)	2001.09-			F	Estate Engine 188A5.000	GCO17016	Outer Joint		22	22	47	89	61	O			
1.6 16V (74 kW)	1996.04-2001.02		MT	F	Estate Engine 178B3.000	GCO17020	Outer Joint	44T	22	22	52	91	60.5	O			
	1996.04-2001.02		MT	F	Estate Engine 178B3.000	GCO17019	Outer Joint		22	22	52	91	60.5	O			





		TRANSM	L/R	F/R		G-AP Ref.	PRODUCT	ABS	Technical Specifications							
									YEAR	A	B	C	H	L	P	
<b>FIAT</b>																
<b>PALIO WEEKEND (178DX)</b>																
1.6 16V (76 kW)	2001.02-				F	Estate Engine 182B6.000	GC017016	Outer Joint		22	22	47	89	61	O	
	2001.02-					Estate Engine 182B6.000	GCI17027	Inner Joint		22	22	36	61.5	93.5		
1.7 TD (51 kW)	1996.04-	2001.03			L	Estate Engine 176A3.000	GDS17005	Drive Shaft		22	31.95	52	91	554		
	1996.04-	2001.03	MT		F	Estate Engine 176A3.000	GC017020	Outer Joint	44T	22	22	52	91	60.5	O	
	1996.04-	2001.03	MT		F	Estate Engine 176A3.000	GC017019	Outer Joint		22	22	52	91	60.5	O	
1.9 D (46 kW)	2001.03-				F	Estate Engine 223A6.000	GC017016	Outer Joint		22	22	47	89	61	O	
<b>PANDA (141A_)</b>																
1.1 (40 kW)	1995.02-	2003.09				F	Hatchback Engine 176B2.000/187A1.000	GC084001	Outer Joint		20	20	43.1	90.5	60.5	O
1.1 4x4 (40 kW)	1995.02-	2004.07				F	Hatchback Engine 176B2.000	GC084001	Outer Joint		20	20	43.1	90.5	60.5	O
1.1 Trekking 4x4 (37 kW)	1991.10-	2004.07				F	Hatchback Engine 156C.046	GC084001	Outer Joint		20	20	43.1	90.5	60.5	O
650 (22 kW)	1982.01-	2004.07				F	Hatchback Engine 141A.000	GC084001	Outer Joint		20	20	43.1	90.5	60.5	O
<b>PANDA (169)</b>																
1.1 (40 kW)	2004.01-	2006.01				F	Hatchback Engine 187A1.000	GC017043	Outer Joint		22	20	47	75.5	54.5	M
	2004.01-	2006.01	MT		R	F	Hatchback Engine 187A1.000	GDS17137	Drive Shaft		22	22	47	75.5	827	
1.2 (44 kW)	2004.01-	2007.12				F	Hatchback Engine 188A4.000	GC017043	Outer Joint		22	20	47	75.5	54.5	M
	2004.01-	2007.12			R	F	Hatchback Engine 188A4.000	GDS17137	Drive Shaft		22	22	47	75.5	827	
1.2 4x4 (44 kW)	2005.01-					F	Hatchback Engine 188A4.000	GC017026	Outer Joint		25	22	51	84	57	M
1.2 Bi-Power/Natural Power (44 kW)	2007.01-		MT		R	F	Hatchback Engine 188A4.000	GDS17137	Drive Shaft		22	22	47	75.5	827	
1.2 LPG (44 kW)	2009.04-		MT		R	F	Hatchback Engine 188A4.000	GDS17137	Drive Shaft		22	22	47	75.5	827	
	2009.04-						Box Body / Estate Engine 188A4.000	GCI17027	Inner Joint		22	22	36	61.5	93.5	
1.3 D Multijet (51 kW)	2004.01-	2006.12				F	Hatchback Engine 188A9.000	GC017026	Outer Joint		25	22	51	84	57	M
	2004.01-	2006.12	MT		L	F	Hatchback Engine 188A9.000	GDS17141	Drive Shaft		25	22	51	84	593	
	2004.01-	2006.12	MT		R	F	Hatchback Engine 188A9.000	GDS17149	Drive Shaft		25	22	51	84	828	
1.3 D Multijet (55 kW)	2006.06-					F	Hatchback Engine 169A1.000	GC017026	Outer Joint		25	22	51	84	57	M
	2006.06-		MT		L	F	Hatchback Engine 169A1.000	GDS17141	Drive Shaft		25	22	51	84	593	
	2006.06-		MT		R	F	Hatchback Engine 169A1.000	GDS17149	Drive Shaft		25	22	51	84	828	
1.3 D Multijet 4x4 (51 kW)	2004.10-					Hatchback Engine 188A9.000/188A8.000	GC017026	Outer Joint		25	22	51	84	57	M	
1.4 (74 kW)	2006.10-					F	Hatchback Engine 169A3.000	GC017026	Outer Joint		25	22	51	84	57	M
<b>PANDA (312, 319)</b>																
0.9 (48 kW)	2012.02-						Hatchback Engine 312A4.000	GCI17027	Inner Joint		22	22	36	61.5	93.5	
0.9 (63 kW)	2012.02-						Hatchback Engine 312A2.000	GCI17027	Inner Joint		22	22	36	61.5	93.5	
<b>PANDA II (169)</b>																
1.1 (40 kW)	2003.10-							GC017043	Outer Joint		22	20	47	75.5	54.5	M
1.2 (44 kW)	2003.09-							GC017043	Outer Joint		22	20	47	75.5	54.5	M
1.2 (51 kW)	2003.09-							GC017043	Outer Joint		22	20	47	75.5	54.5	M
1.2 4WD (44 kW)	2004.10-							GC017026	Outer Joint		25	22	51	84	57	M
1.2 Bi-Power (44 kW)	2007.01-							GC017043	Outer Joint		22	20	47	75.5	54.5	M
1.3 D Multijet (44 kW)	2003.09-							GC017026	Outer Joint		25	22	51	84	57	M
	2006.06-							GC017043	Outer Joint		22	20	47	75.5	54.5	M
1.3 D Multijet (55 kW)	2006.06-							GC017043	Outer Joint		22	20	47	75.5	54.5	M
1.3 D Multijet 4WD (51 kW)	2004.01-							GC017026	Outer Joint		25	22	51	84	57	M
<b>PANDA II (169) VAN</b>																
1.0 (40 kW)	2003.10-							GC017043	Outer Joint		22	20	47	75.5	54.5	M
1.1 (40 kW)	2003.09-							GCI17001	Inner Joint		22	19	36	61.5	88.5	
1.2 (38 kW)	2003.09-							GC017043	Outer Joint		22	20	47	75.5	54.5	M
1.2 (44 kW)	2003.09-	2010.03						GCI17001	Inner Joint		22	19	36	61.5	88.5	
1.2 (51 kW)	2003.09-	2010.03						GCI17001	Inner Joint		22	19	36	61.5	88.5	
1.2 4WD (44 kW)	2004.09-							GC017043	Outer Joint		22	20	47	75.5	54.5	M
1.2 4WD (51 kW)	2004.09-							GC017043	Outer Joint		22	20	47	75.5	54.5	M
1.2 Bi-Power/Natural Power (44 kW)	2007.01-							GCI17001	Inner Joint		22	19	36	61.5	88.5	
1.2 LPG (51 kW)	2010.11-							GCI17001	Inner Joint		22	19	36	61.5	88.5	
1.3 D Multijet (44 kW)	2003.09-	2006.09						GCI17027	Inner Joint		22	22	36	61.5	93.5	
1.3 D Multijet (51 kW)	2003.09-	2006.09						GCI17027	Inner Joint		22	22	36	61.5	93.5	
1.4 (74 kW)	2000.10-							GCI17027	Inner Joint		22	22	36	61.5	93.5	
1.4 8V Natural Power (51 kW)	2010.01-							GCI17027	Inner Joint		22	22	36	61.5	93.5	
1.4 Bi-Power-Natural Power (57 kW)	2010.09-							GCI17001	Inner Joint		22	19	36	61.5	88.5	
<b>PANDA III (312)</b>																
0.9 4x4 (63 kW)	2012.02-						Type NTN	GCI17027	Inner Joint		22	22	36	61.5	93.5	
0.9 T-ASP (57 kW)	2012.02-							GCI17001	Inner Joint		22	19	36	61.5	88.5	
1.2 4x2 (51 kW)	2012.02-							GCI17001	Inner Joint		22	19	36	61.5	88.5	
1.3 JTD 4x2 (55 kW)	2012.02-				L			GCI17011	Inner Joint		24	23	29.7	86.5	93	
1.3 JTD 4x4 (55 kW)	2013.02-				L			GCI99008	Inner Joint		24	24	29.7	86.5	93	



		YEAR	TRANSM	L/R	F/R		G-AP Ref.	PRODUCT	ABS	Technical Specifications								
										A	B	C	H	L	P			
<b>FIAT</b>																		
<b>PANDA VAN (141_)</b>																		
1.0 i.e (33 kW)	1992.08-	2004.02			F	Box Engine 156A2.246	GC084001	Outer Joint		20	20	43.1	90.5	60.5	O			
<b>PANDA VAN (169)</b>																		
1.1 (40 kW)	2004.09-		MT	R	F	Box Body / Estate Engine 187A1.000	GDS17137	Drive Shaft		22	22	47	75.5	827				
1.2 (44 kW)	2004.09-		MT	R	F	Box Body / Estate Engine 188A4.000	GDS17137	Drive Shaft		22	22	47	75.5	827				
1.3 JTD (51 kW)	2004.03-		MT	L	F	Box Body / Estate Engine 188A8.000/188A9.000	GDS17141	Drive Shaft		25	22	51	84	593				
	2004.03-		MT	R	F	Box Body / Estate Engine 188A8.000/188A9.000	GDS17149	Drive Shaft		25	22	51	84	828				
1.3 JTD (55 kW)	2006.01-				F	Box Body / Estate Engine 169A1.000	GC017026	Outer Joint		25	22	51	84	57	M			
	2006.01-		MT	L	F	Box Body / Estate Engine 169A1.000	GDS17141	Drive Shaft		25	22	51	84	593				
	2006.01-		MT	R	F	Box Body / Estate Engine 169A1.000	GDS17149	Drive Shaft		25	22	51	84	828				
<b>PUNTO (176)</b>																		
1.1 (40 kW)	1993.09-	1999.09	5MT	L	F	Hatchback Engine 176A6.000/176B2.000	GDS17018	Drive Shaft		22	22	46.8	75.5	581				
	1993.09-	1999.09	5MT	R	F	Hatchback Engine 176A6.000/176B2.000	GDS17022	Drive Shaft		22	22	46.8	75.5	874				
	1993.09-	1999.09	5MT	L	F	Hatchback Engine 176A6.000/176B2.000	GDS17037	Drive Shaft	44T	22	22	46.8	75.5	581				
	1993.09-	1999.09	5MT	R	F	Hatchback Engine 176A6.000/176B2.000	GDS17039	Drive Shaft	44T	22	22	46.8	75.5	874				
1.2 (43 kW)	1994.01-	1999.09	MT	L	F	Hatchback Engine 176A7.000	GDS17018	Drive Shaft		22	22	46.8	75.5	581				
	1994.01-	1999.09	MT	R	F	Hatchback Engine 176A7.000	GDS17022	Drive Shaft		22	22	46.8	75.5	874				
	1994.01-	1999.09	MT	L	F	Hatchback Engine 176A7.000	GDS17037	Drive Shaft	44T	22	22	46.8	75.5	581				
1.2 (44 kW)	1994.01-	1999.09	MT	R	F	Hatchback Engine 176A7.000	GDS17039	Drive Shaft	44T	22	22	46.8	75.5	874				
	1994.03-	1999.09	MT	L	F	Hatchback Engine 176B1.000/176B4.000	GDS17018	Drive Shaft		22	22	46.8	75.5	581				
	1994.03-	1999.09	MT	R	F	Hatchback Engine 176B1.000/176B4.000	GDS17022	Drive Shaft		22	22	46.8	75.5	874				
	1994.03-	1999.09	MT	L	F	Hatchback Engine 176B1.000/176B4.000	GDS17037	Drive Shaft	44T	22	22	46.8	75.5	581				
1.2 (54 kW)	1994.03-	1999.09	MT	R	F	Hatchback Engine 176B1.000/176B4.000	GDS17039	Drive Shaft	44T	22	22	46.8	75.5	874				
	1993.10-	1999.09	MT	L	F	Hatchback Engine 176A8.000	GDS17018	Drive Shaft		22	22	46.8	75.5	581				
	1993.10-	1999.09	MT	R	F	Hatchback Engine 176A8.000	GDS17022	Drive Shaft		22	22	46.8	75.5	874				
	1993.10-	1999.09	MT	L	F	Hatchback Engine 176A8.000	GDS17037	Drive Shaft	44T	22	22	46.8	75.5	581				
1.6 (65 kW)	1993.10-	1999.09	MT	R	F	Hatchback Engine 176A8.000	GDS17039	Drive Shaft	44T	22	22	46.8	75.5	874				
	1994.01-	1997.04	MT	L	F	Hatchback Engine 176A9.000	GDS17018	Drive Shaft		22	22	46.8	75.5	581				
	1994.01-	1997.04	MT	R	F	Hatchback Engine 176A9.000	GDS17022	Drive Shaft		22	22	46.8	75.5	874				
	1994.01-	1997.04	MT	L	F	Hatchback Engine 176A9.000	GDS17037	Drive Shaft	44T	22	22	46.8	75.5	581				
1.7 D (42 kW)	1994.01-	1997.04	MT	R	F	Hatchback Engine 176A9.000	GDS17039	Drive Shaft	44T	22	22	46.8	75.5	874				
	1994.04-	1997.09	MT	L	F	Hatchback Engine 176B3.000	GDS17018	Drive Shaft		22	22	46.8	75.5	581				
	1994.04-	1997.09	MT	R	F	Hatchback Engine 176B3.000	GDS17022	Drive Shaft		22	22	46.8	75.5	874				
	1994.04-	1997.09	MT	L	F	Hatchback Engine 176B3.000	GDS17037	Drive Shaft	44T	22	22	46.8	75.5	581				
1.7 D (42 kW)	1994.04-	1997.09	MT	R	F	Hatchback Engine 176B3.000	GDS17039	Drive Shaft	44T	22	22	46.8	75.5	874				
	<b>PUNTO (176C)</b>																	
	1.2 (43 kW)	1994.04-	2000.06	MT	L	F	Convertible Engine 176A7.000	GDS17018	Drive Shaft		22	22	46.8	75.5	581			
		1994.04-	2000.06	MT	R	F	Convertible Engine 176A7.000	GDS17022	Drive Shaft		22	22	46.8	75.5	874			
1994.04-		2000.06	MT	L	F	Convertible Engine 176A7.000	GDS17037	Drive Shaft	44T	22	22	46.8	75.5	581				
1994.04-		2000.06	MT	R	F	Convertible Engine 176A7.000	GDS17039	Drive Shaft	44T	22	22	46.8	75.5	874				
1.2 (44 kW)	1995.05-	2000.06	MT	L	F	Convertible Engine 176B1.000/176B4.000	GDS17018	Drive Shaft		22	22	46.8	75.5	581				
	1995.05-	2000.06	MT	R	F	Convertible Engine 176B1.000/176B4.000	GDS17022	Drive Shaft		22	22	46.8	75.5	874				
	1995.05-	2000.06	MT	L	F	Convertible Engine 176B1.000/176B4.000	GDS17037	Drive Shaft	44T	22	22	46.8	75.5	581				
	1995.05-	2000.06	MT	R	F	Convertible Engine 176B1.000/176B4.000	GDS17039	Drive Shaft	44T	22	22	46.8	75.5	874				
1.6 (65 kW)	1994.04-	1997.04	MT	L	F	Convertible Engine 176A9.000	GDS17018	Drive Shaft		22	22	46.8	75.5	581				
	1994.04-	1997.04	MT	R	F	Convertible Engine 176A9.000	GDS17022	Drive Shaft		22	22	46.8	75.5	874				
	1994.04-	1997.04	MT	L	F	Convertible Engine 176A9.000	GDS17037	Drive Shaft	44T	22	22	46.8	75.5	581				
	1994.04-	1997.04	MT	R	F	Convertible Engine 176A9.000	GDS17039	Drive Shaft	44T	22	22	46.8	75.5	874				
<b>PUNTO (188)</b>																		
1.2 Natural Power (44 kW)	2003.09-				F	Hatchback Engine 188A4.000	GC017014	Outer Joint		22	21	51	79.5	54	M			
	2003.09-		MT	L	F	Hatchback Engine 188A4.000	GDS17032	Drive Shaft		22	22	51	79.5	612				
	2003.09-		MT	R	F	Hatchback Engine 188A4.000	GDS17033	Drive Shaft		22	22	51	79.5	841				
	2003.09-		AT	L	F	Hatchback Engine 188A4.000	GDS17158	Drive Shaft		22	23	51	79.5	512				
	2003.09-		MT	R	F	Hatchback Engine 188A4.000	GDS17046	Drive Shaft		22	22	51	79.5	844				
	2003.09-					Hatchback Engine 188A4.000	GCI17027	Inner Joint		22	22	36	61.5	93.5				
1.3 JTD 16V (51 kW)	2003.06-				F	Hatchback Engine 188A9.000	GC017042	Outer Joint		25	25	51	85	58	O			
	2003.06-				F	Hatchback Engine 188A9.000	GCI82005	Inner Joint			25		32					
	2003.06-		MT	L	F	Hatchback Engine 188A9.000	GDS17192	Drive Shaft		25	33.9	51	84.5	452				
	2003.06-		MT	R	F	Hatchback Engine 188A9.000	GDS17193	Drive Shaft		25	33.9	51	84.5	469				
1.4 (70 kW)	2003.07-	2006.01			F	Hatchback Engine 843A1.000	GC017014	Outer Joint		22	21	51	79.5	54	M			
	2003.07-	2006.01		L	F	Hatchback Engine 843A1.000	GDS17032	Drive Shaft		22	22	51	79.5	612				
	2003.07-	2006.01		R	F	Hatchback Engine 843A1.000	GDS17046	Drive Shaft		22	22	51	79.5	844				
1.4 (71 kW)	2005.11-		MT	R	F	Hatchback Engine 199A6.000	GDS17046	Drive Shaft		22	22	51	79.5	844				





		YEAR	TRANSM	L/R	F/R		G-AP Ref.	PRODUCT	ABS	Technical Specifications						
										A	B	C	H	L	P	
<b>FIAT</b>																
<b>PUNTO (188)</b>																
1.9 JTD (63 kW)	2001.10-				F	Hatchback Engine 188A7.000	GC017042	Outer Joint			25	25	51	85	58	O
1.9 JTD (74 kW)	2003.07-	2006.01			F	Hatchback Engine 188B2.000	GC017028	Outer Joint			25	24	51	84.5	62	M
<b>PUNTO (199)</b>																
1.3 D Multijet (55 kW)	2012.03-			R	F	Hatchback Engine 199A2.000/199A9.000	GDS17066	Drive Shaft			25	33.9	51	84.5	497	
1.3 D Multijet (62 kW)	2012.03-			L/R	F	Hatchback Engine 198B4.000	GC017063	Outer Joint			25	25	51.1	84.5	61	M
1.3 D Multijet (70 kW)	2012.03-			L/R	F	Hatchback Engine 199B1.000	GC017063	Outer Joint			25	25	51.1	84.5	61	M
1.4 (55 kW)	2012.03-			R	F	Hatchback Engine 199A7.000	GDS17066	Drive Shaft			25	33.9	51	84.5	497	
1.4 Turbo Multi Air (99 kW)	2012.03-			L/R	F	Hatchback Engine 955A2.000	GC017063	Outer Joint			25	25	51.1	84.5	61	M
<b>PUNTO / GRANDE PUNTO (199)</b>																
1.2 (48 kW)	2006.01-				F	Hatchback Engine 199A4.000	GC017052	Outer Joint			22	21	51.2	79.5	54	M
	2006.01-				F	Hatchback Engine 199A4.000	GC099018	Outer Joint			22	27	51	79.5	54	O
	2006.01-				F	Hatchback Engine 199A4.000	GC017034	Outer Joint			22	21	51	79.5	54	M
	2006.01-		MT	L	F	Hatchback Engine 199A4.000	GDS17045	Drive Shaft			22	22	51	79.5	649	
	2006.01-		MT	L	F	Hatchback Engine 199A4.000	GCI17103	Inner Joint			22	27	36	61.5	93.5	
	2006.01-		MT	L	F	Hatchback Engine 199A4.000	GC099325	Outer Joint			22	27	51	79.5	54	O
	2006.01-				R	F	Hatchback Engine 199A4.000	GDS17111	Drive Shaft			22	22	51.2	79.5	887
1.3 D Multijet (51 kW)	2008.07-				R	F	Hatchback Engine 199B2.000	GDS17066	Drive Shaft			25	33.9	51	84.5	497
1.3 D Multijet (55 kW)	2006.01-	2007.03			F	Hatchback Engine 199A2.000	GC017053	Outer Joint			25	23	51	84.5	60	M
	2006.01-	2007.03			F	Hatchback Engine 199A2.000	GC050113	Outer Joint			27	35	56.5	91.5	71	I
	2006.01-	2007.03	5MT	L	F	Hatchback Engine 199A2.000	GDS17082	Drive Shaft			25	33.9	51	84.5	514	
	2006.01-	2007.03		R	F	Hatchback Engine 199A2.000	GDS17066	Drive Shaft			25	33.9	51	84.5	497	
	2006.01-	2007.03		R	F	Hatchback Engine 199A2.000	GDS17109	Drive Shaft			25	24	51	84.5	908	
	2006.01-	2007.03		R	F	Hatchback Engine 199A2.000	GCI17012	Inner Joint			24	23	29.7	379	100.5	
1.3 D Multijet (62 kW)	2010.04-			L/R	F	Hatchback Engine 199B4.000/233A9.000	GC017063	Outer Joint			25	25	51.1	84.5	61	M
1.3 D Multijet (66 kW)	2006.01-	2007.03			F	Hatchback Engine 199A3.000	GC017053	Outer Joint			25	23	51	84.5	60	M
	2006.01-	2007.03			F	Hatchback Engine 199A3.000	GC017028	Outer Joint			25	24	51	84.5	62	M
	2006.01-	2007.03			F	Hatchback Engine 199A3.000	GC050113	Outer Joint			27	35	56.5	91.5	71	I
	2006.01-	2007.03	6MT	L	F	Hatchback Engine 199A3.000	GDS17172	Drive Shaft			25	33.9	51	84.5	486	
	2006.01-	2007.03	6MT	L	F	Hatchback Engine 199A3.000	GC017053	Outer Joint			25	23	51	84.5	60	M
	2006.01-	2007.03	6MT	R	F	Hatchback Engine 199A3.000	GDS17146	Drive Shaft			25		51	84.5	522	
1.4 (55 kW)	2006.06-			MT	R	F	Hatchback Engine 199A7.000	GDS17111	Drive Shaft			22	22	51.2	79.5	887
1.4 (57 kW)	2006.01-	2007.03			F	Hatchback Engine 350A1.000	GC017052	Outer Joint			22	21	51.2	79.5	54	M
	2006.01-	2007.03	MT	R	F	Hatchback Engine 350A1.000	GDS17111	Drive Shaft			22	22	51.2	79.5	887	
1.4 16V (70 kW)	2005.10-				F	Hatchback Engine 199A6.000	GC017052	Outer Joint			22	21	51.2	79.5	54	M
	2005.10-				L	F	Hatchback Engine 199A6.000	GDS17032	Drive Shaft			22	22	51	79.5	612
1.4 Abarth (114 kW)	2007.12-				F	Hatchback Engine 199A8.000	GC017065	Outer Joint			25	33	51.1	84.5	61	I
1.4 LPG (57 kW)	2008.12-		MT	R	F	Hatchback Engine 350A1.000	GDS17111	Drive Shaft			22	22	51.2	79.5	887	
1.4 Natural Power (57 kW)	2008.07-		MT	R	F	Hatchback Engine 350A1.000	GDS17111	Drive Shaft			22	22	51.2	79.5	887	
1.4 T-Jet (88 kW)	2007.08-			L/R	F	Hatchback Engine 198A4.000	GC017063	Outer Joint			25	25	51.1	84.5	61	M
1.9 D Multijet (88 kW)	2006.01-	2007.03			F	Hatchback Engine 939A1.000	GC017065	Outer Joint			25	33	51.1	84.5	61	I
	2006.01-	2007.03	MT	L	F	Hatchback Engine 939A1.000	GDS17142	Drive Shaft			25	25	51.1	84.5	588	
	2006.01-	2007.03	MT	R	F	Hatchback Engine 939A1.000	GDS17143	Drive Shaft			25	25	51.1	84.5	953	
1.9 D Multijet (96 kW)	2006.01-				F	Hatchback Engine 199A5.000	GC017065	Outer Joint			25	33	51.1	84.5	61	I
	2006.01-		MT	L	F	Hatchback Engine 199A5.000	GDS17142	Drive Shaft			25	25	51.1	84.5	588	
	2006.01-		MT	R	F	Hatchback Engine 199A5.000	GDS17143	Drive Shaft			25	25	51.1	84.5	953	
<b>PUNTO EVO</b>																
1.3 D Multijet (51 kW)	2008.07-	2012.02		L			GCI17011	Inner Joint			24	23	29.7	86.5	93	
	2008.07-	2012.02		R			GCI17012	Inner Joint			24	23	29.7	379	100.5	
1.3 D Multijet (55 kW)	2008.07-	2012.02		L			GCI17011	Inner Joint			24	23	29.7	86.5	93	
	2008.07-	2012.02		R			GCI17012	Inner Joint			24	23	29.7	379	100.5	
1.3 D Multijet (61 kW)	2009.10-	2012.02		R			GCI17026	Inner Joint			24	24	29.7	379	100.5	
1.3 D Multijet (66 kW)	2009.10-	2012.02		L			GCI199008	Inner Joint			24	24	29.7	86.5	93	
1.3 D Multijet (70 kW)	2009.10-	2012.02		R			GCI17026	Inner Joint			24	24	29.7	379	100.5	
<b>PUNTO EVO (199)</b>																
1.2 (48 kW)	2009.10-	2012.02			F	Hatchback Engine 199A4.000	GC017052	Outer Joint			22	21	51.2	79.5	54	M
	2009.10-	2012.02		R	F	Hatchback Engine 199A4.000	GDS17111	Drive Shaft			22	22	51.2	79.5	887	
	2009.10-	2012.02				Hatchback Engine 199A4.000	GCI17027	Inner Joint			22	22	36	61.5	93.5	
1.2 (51 kW)	2009.10-	2012.02		R	F	Hatchback Engine 169A4.000	GDS17111	Drive Shaft			22	22	51.2	79.5	887	
	2009.10-	2012.02				Hatchback Engine 169A4.000	GCI17027	Inner Joint			22	22	36	61.5	93.5	
1.3 D Multijet (51 kW)	2008.07-	2012.02		R	F	Hatchback Engine 199B2.000	GDS17066	Drive Shaft			25	33.9	51	84.5	497	
1.3 D Multijet (55 kW)	2009.10-	2012.02		R	F	Hatchback Engine 199A2.000/199A9.000	GDS17066	Drive Shaft			25	33.9	51	84.5	497	
1.3 D Multijet (62 kW)	2009.10-	2012.02		L/R	F	Hatchback Engine 199B4.000/223A9.000	GC017063	Outer Joint			25	25	51.1	84.5	61	M









		TRANSM	L/R	F/R		G-AP Ref.	PRODUCT	ABS	Technical Specifications							
									YEAR	A	B	C	H	L	P	
<b>FIAT</b>																
<b>PUNTO EVO (199)</b>																
1.3 D Multijet (70 kW)	2009.10-	2012.02		L	F	Hatchback Engine 199B1.000	GDS17172	Drive Shaft	25	33.9	51	84.5	486			
	2009.10-	2012.02		L	F	Hatchback Engine 199B1.000	GC017053	Outer Joint	25	23	51	84.5	60	M		
	2009.10-	2012.02		R	F	Hatchback Engine 199B1.000	GDS17146	Drive Shaft	25		51	84.5	522			
1.4 (57 kW)	2009.10-	2012.02			F	Hatchback Engine 350A1.000	GC017052	Outer Joint	22	21	51.2	79.5	54	M		
	2009.10-	2012.02		R	F	Hatchback Engine 350A1.000	GDS17111	Drive Shaft	22	22	51.2	79.5	887			
1.4 16V (77 kW)	2009.10-	2012.02		L/R	F	Hatchback Engine 955A6.000	GC017070	Outer Joint	22	22	51	79	57.5	M		
1.4 16V (99 kW)	2009.10-	2012.02		L/R	F	Hatchback Engine 955A2.000	GC017063	Outer Joint	25	25	51.1	84.5	61	M		
1.4 Abarth (120 kW)	2009.10-	2012.02		L/R	F	Hatchback Engine 955A8.000	GC017063	Outer Joint	25	25	51.1	84.5	61	M		
1.6 D Multijet (88 kW)	2009.10-	2012.02			F	Hatchback Engine 955A3.000	GC017065	Outer Joint	25	33	51.1	84.5	61	I		
	2009.10-	2012.02	MT	L	F	Hatchback Engine 955A3.000	GDS17142	Drive Shaft	25	25	51.1	84.5	588			
	2009.10-	2012.02		L/R	F	Hatchback Engine 955A3.000	GC017063	Outer Joint	25	25	51.1	84.5	61	M		
	2009.10-	2012.02	MT	R	F	Hatchback Engine 955A3.000	GDS17143	Drive Shaft	25	25	51.1	84.5	953			
<b>PUNTO EVO, VAN</b>																
1.3 D Multijet (66 kW)	2009.10-	2012.02		L			GCI44014	Inner Joint	25	23	34.9	57.5	102			
	2009.10-	2012.02		R			GCI17056	Inner Joint	25	23	34.9	400	97			
	2009.10-	2012.02		R			GCI17015	Inner Joint	24	24	29.7	379	100.5			
1.3 D Multijet (70 kW)	2009.10-	2012.02		L			GCI44014	Inner Joint	25	23	34.9	57.5	102			
	2009.10-	2012.02		R			GCI17056	Inner Joint	25	23	34.9	400	97			
1.3 Multijet (61 kW)	2009.10-	2012.02		L			GCI17025	Inner Joint	24	24	29.7	86.5	93			
1.3 Multijet (70 kW)	2009.10-	2012.02		L			GCI17025	Inner Joint	24	24	29.7	86.5	93			
1.4 16V (77 kW)	2009.10-	2012.02		L			GCI17025	Inner Joint	24	24	29.7	86.5	93			
1.4 16V (99 kW)	2009.10-	2012.02		L			GCI17025	Inner Joint	24	24	29.7	86.5	93			
1.4 Natural Power (55 kW)	2009.07-	2012.02					GCI17027	Inner Joint	22	22	36	61.5	93.5			
1.4 Natural Power (57 kW)	2009.07-	2012.02					GCI17027	Inner Joint	22	22	36	61.5	93.5			
1.4 TB (99 kW)	2009.10-	2012.02		L			GCI17031	Inner Joint	25	26	32	59	110.5			
<b>PUNTO II (188)</b>																
1.9 JTD (74 kW)	2003.06-			R			GCI17062	Inner Joint	34	24	34.9	300	102.5			
<b>PUNTO III (199)</b>																
0.9 Bifuel (63 kW)	2012.03-						GCI17027	Inner Joint	22	22	36	61.5	93.5			
1.2 (51 kW)	2012.03-						GCI17027	Inner Joint	22	22	36	61.5	93.5			
1.3 D Multijet (55 kW)	2012.03-			R			GCI17012	Inner Joint	24	23	29.7	379	100.5			
1.3 D Multijet (62 kW)	2012.03-			R			GCI17026	Inner Joint	24	24	29.7	379	100.5			
1.3 D Multijet (70 kW)	2012.03-			R			GCI17026	Inner Joint	24	24	29.7	379	100.5			
1.3 Multijet (55 kW)	2012.03-			L			GCI17011	Inner Joint	24	23	29.7	86.5	93			
1.3 Multijet (62 kW)	2012.03-			L			GCI17025	Inner Joint	24	24	29.7	86.5	93			
	2005.10-	2010.06		L			GCI44014	Inner Joint	25	23	34.9	57.5	102			
2005.10-	2010.06		R			GCI17056	Inner Joint	25	23	34.9	400	97				
1.3 Multijet (70 kW)	2012.03-			L			GCI17025	Inner Joint	24	24	29.7	86.5	93			
1.4 (55 kW)	2012.03-						GCI17027	Inner Joint	22	22	36	61.5	93.5			
1.4 (57 kW)	2012.03-						GCI17027	Inner Joint	22	22	36	61.5	93.5			
1.4 Multi Air (77 kW)	2012.03-						GCI17027	Inner Joint	22	22	36	61.5	93.5			
1.4 Multi Air Turbo (99 kW)	2012.03-			L			GCI17031	Inner Joint	25	26	32	59	110.5			
1.4 Natural Power (57 kW)	2012.03-						GCI17027	Inner Joint	22	22	36	61.5	93.5			
<b>PUNTO ILI (199) EVO, VAN</b>																
0.9 Bifuel (63 kW)	2012.03-						GC017070	Outer Joint	22	22	51	79	57.5	M		
1.3 D Multijet (66 kW)	2009.10-						GC017028	Outer Joint	25	24	51	84.5	62	M		
1.3 Multijet (62 kW)	2009.10-	2012.03					GC017063	Outer Joint	25	25	51.1	84.5	61	M		
1.3 Multijet (70 kW)	2009.10-	2012.03					GC017063	Outer Joint	25	25	51.1	84.5	61	M		
1.4 (55 kW)	2009.10-	2012.03					GC017070	Outer Joint	22	22	51	79	57.5	M		
1.4 (57 kW)	2009.10-	2012.03					GC017070	Outer Joint	22	22	51	79	57.5	M		
1.4 (77 kW)	2009.10-	2012.03					GC017070	Outer Joint	22	22	51	79	57.5	M		
1.4 Multi Air Turbo (99 kW)	2012.03-						GC017063	Outer Joint	25	25	51.1	84.5	61	M		
1.6 D Multijet (88 kW)	2009.10-						GC017065	Outer Joint	25	33	51.1	84.5	61	I		
<b>PUNTO VAN</b>																
1.3 D Multijet (51 kW)	2008.07-	2012.02		L			GCI17011	Inner Joint	24	23	29.7	86.5	93			
	2008.07-	2012.02		R			GCI17012	Inner Joint	24	23	29.7	379	100.5			
1.3 D Multijet (55 kW)	2008.07-	2012.02		L			GCI17011	Inner Joint	24	23	29.7	86.5	93			
	2008.07-	2012.02		R			GCI17012	Inner Joint	24	23	29.7	379	100.5			
1.3 D Multijet (61 kW)	2009.10-	2012.02		R			GCI17026	Inner Joint	24	24	29.7	379	100.5			
1.3 D Multijet (66 kW)	2009.10-	2012.02		L			GCI99008	Inner Joint	24	24	29.7	86.5	93			
1.3 D Multijet (70 kW)	2009.10-	2012.02		R			GCI17026	Inner Joint	24	24	29.7	379	100.5			



		TRANSM	L/R	F/R		G-AP Ref.	PRODUCT	ABS	Technical Specifications						
									YEAR	A	B	C	H	L	P
<b>FIAT</b>															
<b>PUNTO VAN (188AX)</b>															
1.2 (44 kW)	2000.02-	2009.10			F	Box Engine 188A4.000	GCO17014	Outer Joint	22	21	51	79.5	54	M	
	2000.02-	2009.10	MT	L	F	Box Engine 188A4.000	GDS17032	Drive Shaft	22	22	51	79.5	612		
	2000.02-	2009.10	MT	R	F	Box Engine 188A4.000	GDS17046	Drive Shaft	22	22	51	79.5	844		
	2000.02-	2009.10	MT	R	F	Box Engine 188A4.000	GDS17033	Drive Shaft	22	22	51	79.5	841		
	2000.02-	2009.10				Box Engine 188A4.000	GCI17027	Inner Joint	22	22	36	61.5	93.5		
1.9 D (44 kW)	2000.02-	2009.10			F	Box Engine 188A3.000	GCO17014	Outer Joint	22	21	51	79.5	54	M	
	2000.02-	2009.10	MT	R	F	Box Engine 188A3.000	GDS17046	Drive Shaft	22	22	51	79.5	844		
	2000.02-	2009.10				Box Engine 188A3.000	GCI17027	Inner Joint	22	22	36	61.5	93.5		
1.9 JTD (63 kW)	2000.02-	2009.10			F	Box Engine 188A7.000	GCO17042	Outer Joint	25	25	51	85	58	O	
	2000.02-	2009.10			F	Box Engine 188A7.000	GCI82005	Inner Joint		25		32			
<b>PUNTO VAN (199)</b>															
1.3 D Multijet (55 kW)	2008.04-				R	F	Box Engine 199A2.000/199A9.000	GDS17066	Drive Shaft	25	33.9	51	84.5	497	
	2008.04-				R	F	Box Engine 199A2.000/199A9.000	GDS17109	Drive Shaft	25	24	51	84.5	908	
	2008.04-				R	F	Box Engine 199A2.000/199A9.000	GCI17012	Inner Joint	24	23	29.7	379	100.5	
1.3 D Multijet (62 kW)	2012.03-			L/R	F	Box Engine 199B4.000	GCO17063	Outer Joint	25	25	51.1	84.5	61	M	
1.3 D Multijet (70 kW)	2009.03-			L/R	F	Box Engine 199B1.000	GCO17063	Outer Joint	25	25	51.1	84.5	61	M	
1.4 (57 kW)	2008.04-				R	F	Box Engine 350A1.000	GDS17111	Drive Shaft	22	22	51.2	79.5	887	
1.4 LPG (57 kW)	2009.03-				R	F	Box Engine 350A1.000	GDS17111	Drive Shaft	22	22	51.2	79.5	887	
1.4 Natural Power (57 kW)	2009.03-				R	F	Box Engine 350A1.000	GDS17111	Drive Shaft	22	22	51.2	79.5	887	
<b>QUBO (225)</b>															
1.3 D Multijet (55 kW)	2008.02-		5MT		F	MPV Engine 199A2.000	GCO17028	Outer Joint	25	24	51	84.5	62	M	
	2008.02-		MT	L	F	MPV Engine 199A2.000	GDS17147	Drive Shaft	25		51	84.5	480		
	2008.02-			R	F	MPV Engine 199A2.000	GDS17146	Drive Shaft	25		51	84.5	522		
	2008.02-		MT	R	F	MPV Engine 199A2.000	GDS17157	Drive Shaft	25	24	51	84.5	919		
	2008.02-		MT	R	F	MPV Engine 199A2.000	GCI17059	Inner Joint	24	24	29.8	394	100		
1.3 D Multijet (70 kW)	2010.07-		MT	R	F	MPV Engine 199B1.000	GDS17157	Drive Shaft	25	24	51	84.5	919		
	2010.07-		MT	R	F	MPV Engine 199B1.000	GCI17059	Inner Joint	24	24	29.8	394	100		
1.4 (54 kW)	2008.02-			L/R	F	MPV Engine KFT/KFV	GCO17070	Outer Joint	22	22	51	79	57.5	M	
1.4 Natural Power (57 kW)	2009.10-			L/R	F	MPV Engine 350A1.000	GCO17070	Outer Joint	22	22	51	79	57.5	M	
<b>REGATA (138)</b>															
1.3 (48 kW)	1983.09-	1989.07	MT		F	Saloon Engine 149A3.000/149A7.000	GCO17005	Outer Joint	22	20	48.1	90.5	59.5	O	
1.3 (50 kW)	1983.09-	1986.07	MT		F	Saloon Engine 138B2.000	GCO17005	Outer Joint	22	20	48.1	90.5	59.5	O	
1.5 (55 kW)	1983.12-	1987.12	MT/AT		F	Saloon Engine 138B3.048/138C3.048	GCO17006	Outer Joint	22	25	48.1	93.5	60.5	I	
1.5 (58 kW)	1985.05-	1987.12	MT/AT		F	Saloon Engine 149A5.000	GCO17006	Outer Joint	22	25	48.1	93.5	60.5	I	
1.5 i.e. (55 kW)	1985.07-	1989.07	MT/AT		F	Saloon Engine 138C2.048/149C1.000	GCO17006	Outer Joint	22	25	48.1	93.5	60.5	I	
1.5 Super (60 kW)	1983.09-	1985.04	MT/AT		F	Saloon Engine 138B3.000	GCO17006	Outer Joint	22	25	48.1	93.5	60.5	I	
1.6 (60 kW)	1983.10-	1990.06	MT/AT		F	Saloon Engine 149A.000	GCO17006	Outer Joint	22	25	48.1	93.5	60.5	I	
1.6 i.e. (66 kW)	1987.01-	1989.07	MT		F	Saloon Engine 149C2.000	GCO17006	Outer Joint	22	25	48.1	93.5	60.5	I	
	1987.01-	1989.07			F	Saloon Engine 149C2.000	GCI18070	Inner Joint		25		32			
	1987.01-	1989.07	MT		F	Saloon Engine 149C2.000	GCI48004	Inner Joint		25		32			
1.6 Super (70 kW)	1983.10-	1989.07	MT		F	Saloon Engine 149C3.000	GCO17006	Outer Joint	22	25	48.1	93.5	60.5	I	
	1983.10-	1989.07			F	Saloon Engine 149C3.000	GCI18070	Inner Joint		25		32			
	1983.10-	1989.07	MT		F	Saloon Engine 149C3.000	GCI48004	Inner Joint		25		32			
1.6 Super (74 kW)	1983.10-	1990.12	MT		F	Saloon Engine 149A2.000/149A4.000	GCO17006	Outer Joint	22	25	48.1	93.5	60.5	I	
	1983.10-	1990.12			F	Saloon Engine 149A2.000/149A4.000	GCI18070	Inner Joint		25		32			
	1983.10-	1990.12	MT		F	Saloon Engine 149A2.000/149A4.000	GCI48004	Inner Joint		25		32			
1.7 Diesel (43 kW)	1983.09-	1986.12	MT		F	Saloon Engine 138B6.000	GCO17005	Outer Joint	22	20	48.1	90.5	59.5	O	
1.7 Diesel (44 kW)	1985.05-	1989.03	MT		F	Saloon Engine 149B3.000	GCO17005	Outer Joint	22	20	48.1	90.5	59.5	O	
1.9 Diesel (48 kW)	1984.04-	1989.07	MT		F	Saloon Engine 149A1.000	GCO17005	Outer Joint	22	20	48.1	90.5	59.5	O	
1.9 Turbo Diesel (59 kW)	1986.05-	1989.07	MT		F	Saloon Engine 831D1.000	GCO17006	Outer Joint	22	25	48.1	93.5	60.5	I	
	1986.05-	1989.07			F	Saloon Engine 831D1.000	GCI18070	Inner Joint		25		32			
	1986.05-	1989.07	MT		F	Saloon Engine 831D1.000	GCI48004	Inner Joint		25		32			
<b>REGATA WEEKEND</b>															
1.5 (55 kW)	1984.09-	1989.07	MT/AT		F	Estate Engine 138B3.048/138C3.048	GCO17006	Outer Joint	22	25	48.1	93.5	60.5	I	
1.5 (60 kW)	1984.01-	1989.04	MT/AT		F	Estate Engine 138B3.000	GCO17006	Outer Joint	22	25	48.1	93.5	60.5	I	
1.5 i.e. CAT (55 kW)	1986.12-	1989.07	MT/AT		F	Estate Engine 138C2.048	GCO17006	Outer Joint	22	25	48.1	93.5	60.5	I	
1.6 (74 kW)	1984.09-	1986.12	MT		F	Estate Engine 149A4.000	GCO17006	Outer Joint	22	25	48.1	93.5	60.5	I	
	1984.09-	1986.12	MT		F	Estate Engine 149A4.000	GCI48004	Inner Joint		25		32			
1.6 i.e. (66 kW)	1987.01-	1989.07	MT		F	Estate Engine 149C2.000	GCO17006	Outer Joint	22	25	48.1	93.5	60.5	I	
	1987.01-	1989.07	MT		F	Estate Engine 149C2.000	GCI48004	Inner Joint		25		32			
1.6 i.e. (74 kW)	1987.01-	1990.12	MT		F	Estate Engine 149C3.000	GCO17006	Outer Joint	22	25	48.1	93.5	60.5	I	
	1987.01-	1990.12	MT		F	Estate Engine 149C3.000	GCI48004	Inner Joint		25		32			

		YEAR	TRANSM	L/R	F/R		G-AP Ref.	PRODUCT	ABS	Technical Specifications						
										A	B	C	H	L	P	
<b>FIAT</b>																
<b>REGATA WEEKEND</b>																
1.7 Diesel (44 kW)	1984.01-	1989.12	MT		F	Estate Engine 149B3.000	GCO17005	Outer Joint		22	20	48.1	90.5	59.5	O	
1.9 Diesel (48 kW)	1984.04-	1989.07	MT		F	Estate Engine 149A1.000	GCO17005	Outer Joint		22	20	48.1	90.5	59.5	O	
1.9 Turbo Diesel (59 kW)	1986.05-	1989.07	MT		F	Estate Engine 831D1.000	GCO17006	Outer Joint		22	25	48.1	93.5	60.5	I	
	1986.05-	1989.07	MT		F	Estate Engine 831D1.000	GCI48004	Inner Joint			25		32			
<b>SCUDO</b>																
1.6 MJT	2006-			L	F		GDS10238	Drive Shaft		28	24	58.5	92	669		
	2006-			L	F		GCI99158	Inner Joint		24	34	40	62	89		
	2006-			L	F		GCO10095	Outer Joint		28	34	58.5	92	55	I	
	2006-			R	F		GCI99159	Inner Joint		24	34	29.8	350	87.5		
	2006-						GDS10239	Drive Shaft		28	24	58.5	92	958		
	2006-						GCO10095	Outer Joint		28	34	58.5	92	55	I	
<b>SCUDO (220L)</b>																
1.6 (58 kW)	1996.02-	2006.12			F	Box Engine 220A2.000	GCO10016	Outer Joint		27	34	59	82	55	I	
	1996.02-	2006.12			F	Box Engine 220A2.000	GCO10018	Outer Joint	48T	27	34	61	82	55	I	
	1996.02-	2006.12	MT	L	F	Box Engine 220A2.000	GDS10052	Drive Shaft		27	24	61	82	648		
	1996.02-	2006.12	MT	L	F	Box Engine 220A2.000	GDS10082	Drive Shaft	48T	27	24	59	82	648		
	1996.02-	2006.12	MT	R	F	Box Engine 220A2.000	GDS10120	Drive Shaft		27	24	59	82	928		
	1996.02-	2006.12	MT	R	F	Box Engine 220A2.000	GDS10012	Drive Shaft	48T	27	24	64	80.5	928		
1.9 D (51 kW)	1996.02-	2006.12			F	Box Engine D9B	GCO10016	Outer Joint		27	34	59	82	55	I	
	1996.02-	2006.12			F	Box Engine D9B	GCO10018	Outer Joint	48T	27	34	61	82	55	I	
	1996.02-	2006.12	MT	L	F	Box Engine D9B	GDS10052	Drive Shaft		27	24	61	82	648		
	1996.02-	2006.12	MT	L	F	Box Engine D9B	GDS10082	Drive Shaft	48T	27	24	59	82	648		
	1996.02-	2006.12	MT	R	F	Box Engine D9B	GDS10120	Drive Shaft		27	24	59	82	928		
	1996.02-	2006.12	MT	R	F	Box Engine D9B	GDS10012	Drive Shaft	48T	27	24	64	80.5	928		
	1998.04-	2006.12			F	Box Engine WJZ(DW8)	GCO10018	Outer Joint	48T	27	34	61	82	55	I	
	1998.04-	2006.12	MT	L	F	Box Engine WJZ(DW8)	GDS10052	Drive Shaft		27	24	61	82	648		
	1998.04-	2006.12	MT	L	F	Box Engine WJZ(DW8)	GDS10082	Drive Shaft	48T	27	24	59	82	648		
	1998.04-	2006.12	MT	R	F	Box Engine WJZ(DW8)	GDS10120	Drive Shaft		27	24	59	82	928		
1.9 TD (66 kW)	1996.02-	2006.12			F	Box Engine DHX(XUD9TF/L)	GCO10015	Outer Joint	48T	27	39	59	82	63	I	
	1996.02-	2006.12	MT	L	F	Box Engine DHX(XUD9TF/L)	GDS10016	Drive Shaft	48T	27	37	59	82	641		
	1996.02-	2006.12	MT	L	F	Box Engine DHX(XUD9TF/L)	GDS10072	Drive Shaft		27	37	59	82	641		
	1996.02-	2006.12	MT	R	F	Box Engine DHX(XUD9TF/L)	GDS10155	Drive Shaft		27	37	59	82	947		
	1996.02-	2006.12	MT	R	F	Box Engine DHX(XUD9TF/L)	GDS10014	Drive Shaft	48T	27	37	59	82	947		
1.9 TD (68 kW)	1998.02-	2006.12			F	Box Engine D8B	GCO10014	Outer Joint		27	39	59	82	63	I	
	1998.02-	2006.12			F	Box Engine D8B	GCO10015	Outer Joint	48T	27	39	59	82	63	I	
	1998.02-	2006.12	MT	L	F	Box Engine D8B	GDS10016	Drive Shaft	48T	27	37	59	82	641		
	1998.02-	2006.12	MT	L	F	Box Engine D8B	GDS10072	Drive Shaft		27	37	59	82	641		
	1998.02-	2006.12	MT	R	F	Box Engine D8B	GDS10155	Drive Shaft		27	37	59	82	947		
	1998.02-	2006.12	MT	R	F	Box Engine D8B	GDS10014	Drive Shaft	48T	27	37	59	82	947		
2.0 (100 kW)	2000.05-	2006.12			F	Box Engine RFN	GCO10018	Outer Joint	48T	27	34	61	82	55	I	
2.0 JTD (69 kW)	1999.12-	2006.12			F	Box Engine RHX	GCO10015	Outer Joint	48T	27	39	59	82	63	I	
	1999.12-	2006.12	MT	L	F	Box Engine RHX	GDS10264	Drive Shaft	48T	27	37	59	82	630		
	1999.12-	2006.12	MT	R	F	Box Engine RHX	GDS10057	Drive Shaft		27	37	59	82	960		
	1999.12-	2006.12	MT	R	F	Box Engine RHX	GDS45120	Drive Shaft	48T	27	37	59	82	960		
	1999.12-	2006.12			R	Box Engine RHX	GDS10237	Drive Shaft	48T	27	37	59	82	953		
2.0 JTD (80 kW)	2002.12-	2006.12			F	Box Engine RHZ	GCO10015	Outer Joint	48T	27	39	59	82	63	I	
	2002.12-	2006.12	MT	L	F	Box Engine RHZ	GDS10264	Drive Shaft	48T	27	37	59	82	630		
	2002.12-	2006.12	MT	R	F	Box Engine RHZ	GDS10057	Drive Shaft		27	37	59	82	960		
	2002.12-	2006.12	MT	R	F	Box Engine RHZ	GDS45120	Drive Shaft	48T	27	37	59	82	960		
<b>SCUDO (270_)</b>																
1.6 D Multijet (66 kW)	2007.01-		MT	R	F	Box Engine 9HU	GDS10239	Drive Shaft		28	24	58.5	92	958		
	2007.01-		MT	R	F	MPV Engine 9HU	GDS10239	Drive Shaft		28	24	58.5	92	958		
	2007.01-		MT	R	F	Platform/Chassis Engine 9HU	GDS10239	Drive Shaft		28	24	58.5	92	958		
	2007.01-					Box Engine 9HU	GCO10124	Outer Joint		28	34	58.5	92	55	I	
	2007.01-					MPV Engine 9HU	GCO10124	Outer Joint		28	34	58.5	92	55	I	
	2007.01-					Platform/Chassis Engine 9HU	GCO10124	Outer Joint		28	34	58.5	92	55	I	
2.0 D Multijet (100 kW)	2007.01-				F	Box Engine RHR	GCO10098	Outer Joint		28	39	58.6	93	63	I	
	2007.01-				F	MPV Engine RHR	GCO10098	Outer Joint		28	39	58.6	93	63	I	
	2007.01-				F	Platform/Chassis Engine DW10BTED4/RHR	GCO10098	Outer Joint		28	39	58.6	93	63	I	
	2007.01-		MT	L	F	Box Engine RHR	GDS10234	Drive Shaft		28	37	58.6	93	648		
	2007.01-		MT	L	F	MPV Engine RHR	GDS45133	Drive Shaft		28	37	58.6	94	653		









	 YEAR	TRANSM	L/R	F/R		G-AP Ref.	PRODUCT	ABS	Technical Specifications						
									A	B	C	H	L	P	
<b>FIAT SCUDO (270_)</b>	2.0 D Multijet (100 kW)	2007.01-	MT	L	F	Platform/Chassis Engine DW10BTED4/RHR	GDS10234	Drive Shaft		28	37	58.6	93	648	
		2007.01-		L	F	Box Engine RHR	GDS45133	Drive Shaft		28	37	58.6	94	653	
		2007.01-		L	F	Platform/Chassis Engine DW10BTED4/RHR	GDS45133	Drive Shaft		28	37	58.6	94	653	
		2007.01-		R	F	Box Engine RHR	GDS99214	Drive Shaft		28	37	58.6	94	978	
		2007.01-		R	F	Box Engine RHR	GCI10041	Inner Joint		37	39	32	399	95.5	
		2007.01-		R	F	Box Engine RHR	GC010159	Outer Joint		28	39	58.6	94	63	I
		2007.01-		R	F	MPV Engine RHR	GDS99214	Drive Shaft		28	37	58.6	94	978	
		2007.01-		R	F	MPV Engine RHR	GCI10041	Inner Joint		37	39	32	399	95.5	
		2007.01-		R	F	MPV Engine RHR	GC010159	Outer Joint		28	39	58.6	94	63	I
		2007.01-		R	F	Platform/Chassis Engine DW10BTED4/RHR	GDS99214	Drive Shaft		28	37	58.6	94	978	
		2007.01-		R	F	Platform/Chassis Engine DW10BTED4/RHR	GCI10041	Inner Joint		37	39	32	399	95.5	
		2007.01-		R	F	Platform/Chassis Engine DW10BTED4/RHR	GC010159	Outer Joint		28	39	58.6	94	63	I
		2007.01-		R		Box Engine RHR	GDS10244	Drive Shaft		28	37	58.6	93	979	
		2007.01-		R		MPV Engine RHR	GDS10244	Drive Shaft		28	37	58.6	93	979	
		2007.01-		R		Platform/Chassis Engine DW10BTED4/RHR	GDS10244	Drive Shaft		28	37	58.6	93	979	
2.0 D Multijet (120 kW)	2010.07-	MT	L	F	Box Engine RHH	GDS10234	Drive Shaft		28	37	58.6	93	648		
	2010.07-	MT	L	F	MPV Engine RHH	GDS45133	Drive Shaft		28	37	58.6	94	653		
	2010.07-		L	F	Box Engine RHH	GDS45133	Drive Shaft		28	37	58.6	94	653		
	2010.07-	MT	R	F	Box Engine RHH	GDS99214	Drive Shaft		28	37	58.6	94	978		
	2010.07-	MT	R	F	Box Engine RHH	GCI10041	Inner Joint		37	39	32	399	95.5		
	2010.07-	MT	R	F	Box Engine RHH	GC010159	Outer Joint		28	39	58.6	94	63	I	
	2010.07-	MT	R	F	MPV Engine RHH	GDS99214	Drive Shaft		28	37	58.6	94	978		
	2010.07-	MT	R	F	MPV Engine RHH	GCI10041	Inner Joint		37	39	32	399	95.5		
	2010.07-	MT	R	F	MPV Engine RHH	GC010159	Outer Joint		28	39	58.6	94	63	I	
2.0 D Multijet (88 kW)	2007.01-			F	Box Engine RHK	GC010098	Outer Joint		28	39	58.6	93	63	I	
	2007.01-			F	MPV Engine RHK	GC010098	Outer Joint		28	39	58.6	93	63	I	
	2007.01-			F	Platform/Chassis Engine RHK	GC010098	Outer Joint		28	39	58.6	93	63	I	
	2007.01-	MT	L	F	Box Engine RHK	GDS10234	Drive Shaft		28	37	58.6	93	648		
	2007.01-	MT	L	F	MPV Engine RHK	GDS45133	Drive Shaft		28	37	58.6	94	653		
	2007.01-	MT	L	F	Platform/Chassis Engine RHK	GDS10234	Drive Shaft		28	37	58.6	93	648		
	2007.01-		L	F	Box Engine RHK	GDS45133	Drive Shaft		28	37	58.6	94	653		
	2007.01-		L	F	Platform/Chassis Engine RHK	GDS45133	Drive Shaft		28	37	58.6	94	653		
	2007.01-		R	F	Box Engine RHK	GDS99214	Drive Shaft		28	37	58.6	94	978		
	2007.01-		R	F	Box Engine RHK	GCI10041	Inner Joint		37	39	32	399	95.5		
	2007.01-		R	F	Box Engine RHK	GC010159	Outer Joint		28	39	58.6	94	63	I	
	2007.01-		R	F	MPV Engine RHK	GDS99214	Drive Shaft		28	37	58.6	94	978		
	2007.01-		R	F	MPV Engine RHK	GCI10041	Inner Joint		37	39	32	399	95.5		
	2007.01-		R	F	MPV Engine RHK	GC010159	Outer Joint		28	39	58.6	94	63	I	
	2007.01-		R	F	Platform/Chassis Engine RHK	GDS99214	Drive Shaft		28	37	58.6	94	978		
	2007.01-		R	F	Platform/Chassis Engine RHK	GCI10041	Inner Joint		37	39	32	399	95.5		
	2007.01-		R	F	Platform/Chassis Engine RHK	GC010159	Outer Joint		28	39	58.6	94	63	I	
	2007.01-		R		Box Engine RHK	GDS10244	Drive Shaft		28	37	58.6	93	979		
2007.01-		R		MPV Engine RHK	GDS10244	Drive Shaft		28	37	58.6	93	979			
2007.01-		R		Platform/Chassis Engine RHK	GDS10244	Drive Shaft		28	37	58.6	93	979			
2.0 D Multijet (94 kW)	2011.04-	MT	L	F	MPV Engine RH02	GDS10234	Drive Shaft		28	37	58.6	93	648		
	2011.05-	MT	L	F	Box Engine RH02	GDS10234	Drive Shaft		28	37	58.6	93	648		
	2011.05-		L	F	Box Engine RH02	GDS45133	Drive Shaft		28	37	58.6	94	653		
	2011.05-		L	F	Platform/Chassis Engine RH02	GDS45133	Drive Shaft		28	37	58.6	94	653		
	2011.05-		R	F	Box Engine RH02	GDS99214	Drive Shaft		28	37	58.6	94	978		
	2011.05-		R	F	Box Engine RH02	GCI10041	Inner Joint		37	39	32	399	95.5		
	2011.05-		R	F	Box Engine RH02	GC010159	Outer Joint		28	39	58.6	94	63	I	
	2011.05-		R	F	Platform/Chassis Engine RH02	GDS99214	Drive Shaft		28	37	58.6	94	978		
	2011.05-		R	F	Platform/Chassis Engine RH02	GCI10041	Inner Joint		37	39	32	399	95.5		
2011.05-		R	F	Platform/Chassis Engine RH02	GC010159	Outer Joint		28	39	58.6	94	63	I		
<b>SCUDO COMBINATO (220P)</b> 1.6 (58 kW)	1996.02-	2006.12			F	Estate Engine 220A2.000	GC010059	Outer Joint	48T	27	34	59	82	55	I
	1996.02-	2006.12			F	Estate Engine 220A2.000	GC010016	Outer Joint		27	34	59	82	55	I
	1996.02-	2006.12			F	Estate Engine 220A2.000	GC010018	Outer Joint	48T	27	34	61	82	55	I
	1996.02-	2006.12	MT	L	F	Estate Engine 220A2.000	GDS10052	Drive Shaft		27	24	61	82	648	
	1996.02-	2006.12	MT	L	F	Estate Engine 220A2.000	GDS10082	Drive Shaft	48T	27	24	59	82	648	
	1996.02-	2006.12	MT	R	F	Estate Engine 220A2.000	GDS10120	Drive Shaft		27	24	59	82	928	
	1996.02-	2006.12	MT	R	F	Estate Engine 220A2.000	GDS10012	Drive Shaft	48T	27	24	64	80.5	928	

		YEAR	TRANSM	L/R	F/R		G-AP Ref.	PRODUCT	ABS	Technical Specifications					
										A	B	C	H	L	P
<b>FIAT</b>															
<b>SCUDO COMBINATO (220P)</b>															
1.9 D (51 kW)	1998.04-	2006.12			F	Estate Engine WJZ(DW8)	GC010018	Outer Joint	48T	27	34	61	82	55	I
	1998.04-	2006.12	MT	L	F	Estate Engine WJZ(DW8)	GDS10052	Drive Shaft		27	24	61	82	648	
	1998.04-	2006.12	MT	L	F	Estate Engine WJZ(DW8)	GDS10082	Drive Shaft	48T	27	24	59	82	648	
	1998.04-	2006.12	MT	R	F	Estate Engine WJZ(DW8)	GDS10120	Drive Shaft		27	24	59	82	928	
	1998.04-	2006.12	MT	R	F	Estate Engine WJZ(DW8)	GDS10012	Drive Shaft	48T	27	24	64	80.5	928	
1.9 TD (68 kW)	1996.02-	2006.12			F	Estate Engine D8B	GC010014	Outer Joint		27	39	59	82	63	I
	1996.02-	2006.12			F	Estate Engine D8B	GC010015	Outer Joint	48T	27	39	59	82	63	I
	1996.02-	2006.12	MT	L	F	Estate Engine D8B	GDS10016	Drive Shaft	48T	27	37	59	82	641	
	1996.02-	2006.12	MT	L	F	Estate Engine D8B	GDS10072	Drive Shaft		27	37	59	82	641	
	1996.02-	2006.12	MT	R	F	Estate Engine D8B	GDS10155	Drive Shaft		27	37	59	82	947	
	1996.02-	2006.12	MT	R	F	Estate Engine D8B	GDS10014	Drive Shaft	48T	27	37	59	82	947	
1.9 TD Eco (66 kW)	1996.02-	2006.12			F	Estate Engine DHX(XUD9TF/L)	GC010015	Outer Joint	48T	27	39	59	82	63	I
	1996.02-	2006.12	MT	L	F	Estate Engine DHX(XUD9TF/L)	GDS10016	Drive Shaft	48T	27	37	59	82	641	
	1996.02-	2006.12	MT	L	F	Estate Engine DHX(XUD9TF/L)	GDS10072	Drive Shaft		27	37	59	82	641	
	1996.02-	2006.12	MT	R	F	Estate Engine DHX(XUD9TF/L)	GDS10155	Drive Shaft		27	37	59	82	947	
	1996.02-	2006.12	MT	R	F	Estate Engine DHX(XUD9TF/L)	GDS10014	Drive Shaft	48T	27	37	59	82	947	
2.0 16V (100 kW)	2000.06-	2006.12			F	Estate Engine RFN	GC010018	Outer Joint	48T	27	34	61	82	55	I
2.0 JTD (69 kW)	2004.01-	2006.12			F	Estate Engine RHX	GC010015	Outer Joint	48T	27	39	59	82	63	I
	2004.01-	2006.12	MT	L	F	Estate Engine RHX	GDS10264	Drive Shaft	48T	27	37	59	82	630	
	2004.01-	2006.12	MT	R	F	Estate Engine RHX	GDS10057	Drive Shaft		27	37	59	82	960	
	2004.01-	2006.12	MT	R	F	Estate Engine RHX	GDS45120	Drive Shaft	48T	27	37	59	82	960	
2.0 JTD (80 kW)	1999.12-	2006.12			F	Estate Engine RHZ	GC010015	Outer Joint	48T	27	39	59	82	63	I
	1999.12-	2006.12	MT	L	F	Estate Engine RHZ	GDS10264	Drive Shaft	48T	27	37	59	82	630	
	1999.12-	2006.12	MT	R	F	Estate Engine RHZ	GDS10057	Drive Shaft		27	37	59	82	960	
	1999.12-	2006.12	MT	R	F	Estate Engine RHZ	GDS45120	Drive Shaft	48T	27	37	59	82	960	
	1999.12-	2006.12			R	Estate Engine RHZ	GDS10237	Drive Shaft	48T	27	37	59	82	953	
<b>SEDICI</b>															
1.6 16V (79 kW)	2006.06-					Closed Off-Road Vehicle Engine M16A	GC057078	Outer Joint		28	29	58	85	62	I
1.6 16V (88 kW)	2006.06-					Closed Off-Road Vehicle Engine M16A	GC057078	Outer Joint		28	29	58	85	62	I
1.6 16V 4x2 (79 kW)	2006.06-						GC099310	Outer Joint		28	35	58	85	65	I
1.6 16V 4x4 (79 kW)	2006.06-					Closed Off-Road Vehicle Engine M16A	GC057078	Outer Joint		28	29	58	85	62	I
	2006.06-						GC099310	Outer Joint		28	35	58	85	65	I
1.6 16V 4x4 (88 kW)	2006.06-					Closed Off-Road Vehicle Engine M16A	GC057078	Outer Joint		28	29	58	85	62	I
1.9 D Multijet (88 kW)	2006.06-					Closed Off-Road Vehicle Engine D19AA	GC057078	Outer Joint		28	29	58	85	62	I
	2006.06-						GC099310	Outer Joint		28	35	58	85	65	I
1.9 D Multijet 4x4 (88 kW)	2006.06-					Closed Off-Road Vehicle Engine D19AA	GC057078	Outer Joint		28	29	58	85	62	I
2.0 D Multijet (99 kW)	2006.06-					Closed Off-Road Vehicle Engine D20AA	GC057078	Outer Joint		28	29	58	85	62	I
<b>SEICENTO (187)</b>															
0.9 (29 kW)	1998.01-	2010.01			F	Hatchback Engine 1170A1.046	GC017024	Outer Joint		22	20	47	75.5	51.5	O
	1998.01-	2010.01	MT		F	Hatchback Engine 1170A1.046	GC017010	Outer Joint		22	20	46.8	75.5	48	O
	1998.01-	2010.01	MT	L	F	Hatchback Engine 1170A1.046	GDS17187	Drive Shaft		22	29.2	46.8	75.5	534	
1.1 (40 kW)	1998.01-	2010.01	5MT		F	Hatchback Engine 176B2.000/187A1.000	GC017024	Outer Joint		22	20	47	75.5	51.5	O
	1998.01-	2010.01	MT		F	Hatchback Engine 176B2.000/187A1.000	GC017010	Outer Joint		22	20	46.8	75.5	48	O
	1998.01-	2010.01	MT	L	F	Hatchback Engine 176B2.000/187A1.000	GDS17190	Drive Shaft		22	22	47	75.5	553	
	1998.01-	2010.01	MT	R	F	Hatchback Engine 176B2.000/187A1.000	GDS17191	Drive Shaft		22	22	47	75.5	776	
<b>SIENA</b>															
-	2002-					VN-VS / VS II	GDS17031	Drive Shaft						336	
	2002-					VN-VS / VS II	GCI17018	Inner Joint			25		32		
1.0	2008-	2012					GC017093	Outer Joint		22	28	47	89	57	O
1.2/1.4	1997-	2002		L	F		GDS16002	Drive Shaft		22	31.95	47	89	571.5	
	1997-	2002		R	F		GDS16001	Drive Shaft		22	31.95	47	89	918.5	
1.4 8V	2008-	2012					GC017093	Outer Joint		22	28	47	89	57	O
<b>SIENA (178_)</b>															
1.0 (45 kW)	1998.09-		MT		F	Saloon	GC017017	Outer Joint		22	20	52	91	60.5	O
1.2 (44 kW)	2001.09-				F	Saloon Engine 178C4.066/188A4.000	GC017029	Outer Joint		22	20	47	89	61	O
1.2 (54 kW)	1998.09-		MT		F	Saloon Engine 178B5.000	GC017020	Outer Joint	44T	22	22	52	91	60.5	O
	1998.09-		MT		F	Saloon Engine 178B5.000	GC017019	Outer Joint		22	22	52	91	60.5	O
1.4 (51 kW)	1996.04-		MT		F	Saloon Engine 178B2.000	GC017020	Outer Joint	44T	22	22	52	91	60.5	O
	1996.04-		MT		F	Saloon Engine 178B2.000	GC017019	Outer Joint		22	22	52	91	60.5	O
1.4 CAT (51 kW)	1996.04-		MT		F	Saloon Engine 178B2.016	GC017020	Outer Joint	44T	22	22	52	91	60.5	O
	1996.04-		MT		F	Saloon Engine 178B2.016	GC017019	Outer Joint		22	22	52	91	60.5	O



	 YEAR	TRANSM	L/R	F/R		G-AP Ref.	PRODUCT	ABS	Technical Specifications							
									A	B	C	H	L	P		
<b>FIAT</b>																
<b>SIENA (178_)</b>																
1.6 16V (78 kW)	1998.09-		MT		F	Saloon Engine 178B3.000	GC017020	Outer Joint	44T	22	22	52	91	60.5	O	
	1998.09-		MT		F	Saloon Engine 178B3.000	GC017019	Outer Joint		22	22	52	91	60.5	O	
<b>STILO</b>																
1.8	2002.09-	2006.12	MT				GCI82011	Inner Joint			25		32			
<b>STILO (192)</b>																
1.2 16V (59 kW)	2002.02-	2006.11			F	Hatchback Engine 188A5.000	GC017014	Outer Joint		22	21	51	79.5	54	M	
1.4 16V (66 kW)	2005.03-	2006.11	MT	R	F	Hatchback Engine 192B2.000	GDS17080	Drive Shaft		25	22	51	84	938		
	2005.03-	2006.11	MT	R	F	Hatchback Engine 192B2.000	GCI17004	Inner Joint		22	21	36	61	93.5		
	2005.03-	2006.11	MT	R	F	Hatchback Engine 192B2.000	GC017026	Outer Joint		25	22	51	84	57	M	
	2005.03-	2006.11			F	Hatchback Engine 192B2.000	GC017026	Outer Joint		25	22	51	84	57	M	
	2005.03-	2006.11	MT	L	F	Hatchback Engine 192B2.000	GDS17099	Drive Shaft		25	22	51	84	638		
1.4 16V (70 kW)	2004.01-	2006.11			F	Hatchback Engine 843A1.000	GC017026	Outer Joint		25	22	51	84	57	M	
1.6 16V (76 kW)	2001.10-	2006.11			F	Hatchback Engine 182B6.000	GC017026	Outer Joint		25	22	51	84	57	M	
	2001.10-	2006.11	MT	L	F	Hatchback Engine 182B6.000	GDS17099	Drive Shaft		25	22	51	84	638		
	2001.10-	2006.11	MT	R	F	Hatchback Engine 182B6.000	GDS17080	Drive Shaft		25	22	51	84	938		
	2001.10-	2006.11	MT	R	F	Hatchback Engine 182B6.000	GCI17004	Inner Joint		22	21	36	61	93.5		
	2001.10-	2006.11	MT	R	F	Hatchback Engine 182B6.000	GC017026	Outer Joint		25	22	51	84	57	M	
1.6 16V (77 kW)	2005.05-	2006.11			F	Hatchback Engine 192B30	GC017026	Outer Joint		25	22	51	84	57	M	
1.8 16V (98 kW)	2001.10-	2006.11			F	Hatchback Engine 192A4.000	GC017028	Outer Joint		25	24	51	84.5	62	M	
	2001.10-	2006.11			F	Hatchback Engine 192A4.000	GCI82005	Inner Joint			25		32			
1.9 D Multijet (74 kW)	2005.09-	2006.11			F	Hatchback Engine 192A9.000	GC017028	Outer Joint		25	24	51	84.5	62	M	
	2005.09-	2006.11			F	Hatchback Engine 192A9.000	GCI82005	Inner Joint			25		32			
1.9 D Multijet (88 kW)	2006.01-	2007.06			F	Hatchback Engine 192A8.000	GC017028	Outer Joint		25	24	51	84.5	62	M	
	2006.01-	2007.06	MT	L	F	Hatchback Engine 192A8.000	GDS17108	Drive Shaft		25	34	51	84.5	631		
	2006.01-	2007.06	MT	L	F	Hatchback Engine 192A8.000	GCI17013	Inner Joint		34	24	35	56.5	115		
	2006.01-	2007.06	MT	L/R	F	Hatchback Engine 192A8.000	GC017057	Outer Joint		25	24	51	84.5	62	M	
	2006.01-	2007.06		L/R	F	Hatchback Engine 192A8.000	GDS17194	Drive Shaft		25	39.2	51	84.5	523		
	2006.01-	2007.06	MT	R	F	Hatchback Engine 192A8.000	GDS17077	Drive Shaft		25	34	51	84.5	928		
	2006.01-	2007.06	MT	R	F	Hatchback Engine 192A8.000	GCI17014	Inner Joint		34	24	34.9	411	102.5		
1.9 JTD (59 kW)	2002.02-	2006.11			F	Hatchback Engine 192A3.000	GCI82005	Inner Joint			25		32			
1.9 JTD (85 kW)	2001.10-	2004.03					GC017030	Outer Joint		25	26	51	84.5	64.5	M	
	2001.10-	2006.11			F	Hatchback Engine 192A1.000/937A7.000	GC017030	Outer Joint		25	26	51	84.5	64.5	M	
	2001.10-	2006.11			F	Hatchback Engine 192A1.000/937A7.000	GC017028	Outer Joint		25	24	51	84.5	62	M	
	2001.10-	2006.11	MT	L	F	Hatchback Engine 192A1.000/937A7.000	GDS17108	Drive Shaft		25	34	51	84.5	631		
	2001.10-	2006.11	MT	L	F	Hatchback Engine 192A1.000/937A7.000	GCI17013	Inner Joint		34	24	35	56.5	115		
	2001.10-	2006.11	MT	L/R	F	Hatchback Engine 192A1.000/937A7.000	GC017057	Outer Joint		25	24	51	84.5	62	M	
	2001.10-	2006.11	MT	R	F	Hatchback Engine 192A1.000/937A7.000	GDS17077	Drive Shaft		25	34	51	84.5	928		
	2001.10-	2006.11	MT	R	F	Hatchback Engine 192A1.000/937A7.000	GCI17014	Inner Joint		34	24	34.9	411	102.5		
2.4 20V (125 kW)	2001.10-	2006.11			F	Hatchback Engine 192A2.000	GC017009	Outer Joint		25	26	59	84	63	M	
	2001.10-	2006.11			R	Hatchback Engine 192A2.000	GDS17118	Drive Shaft		25	25	59	84	985		
<b>STILO (192),MULTI WAGON</b>																
1.2 16V(59 kW)	2002.02-						GCI17027	Inner Joint		22	22	36	61.5	93.5		
1.4 16V (66 kW)	2005.03-						GC017026	Outer Joint		25	22	51	84	57	M	
1.4 16V (70 kW)	2004.01-						GC017026	Outer Joint		25	22	51	84	57	M	
1.4 16V (76 kW)	2005.05-	2010.01					GCI17027	Inner Joint		22	22	36	61.5	93.5		
1.4 16V (77 kW)	2005.05-	2010.01					GCI17027	Inner Joint		22	22	36	61.5	93.5		
1.6 16V (76 kW)	2001.10-						GC017026	Outer Joint		25	22	51	84	57	M	
1.6 16V (77 kW)	2001.10-						GC017026	Outer Joint		25	22	51	84	57	M	
1.6 16V(76 kW)	2001.10-	2005.05					GCI17027	Inner Joint		22	22	36	61.5	93.5		
1.6 16V(77 kW)	2001.10-	2005.05					GCI17027	Inner Joint		22	22	36	61.5	93.5		
1.8 16V (98 kW)	2001.10-					Ch-0276610	GC082008	Outer Joint		25	25	59	85	58	O	
1.9 D Multijet (110 kW)	2005.09-				L		GCI17005	Inner Joint		25	26	32	91	95		
	2005.09-				R		GCI17006	Inner Joint		25	26	29.8	377	108		
	2005.09-						GC017009	Outer Joint		25	26	59	84	63	M	
1.9 JTD (100 kW)	2004.04-						GC017009	Outer Joint		25	26	59	84	63	M	
1.9 JTD (103 kW)	2004.04-						GC017009	Outer Joint		25	26	59	84	63	M	
1.9 JTD (110 kW)	2003-	2007			L		GCI17005	Inner Joint		25	26	32	91	95		
	2003-	2007			R		GCI17006	Inner Joint		25	26	29.8	377	108		
1.9 JTD (59 kW)	2002.02-					Ch-6276610	GC082008	Outer Joint		25	25	59	85	58	O	
1.9 JTD (88 kW)	2003-	2007			L		GCI17005	Inner Joint		25	26	32	91	95		
	2003-	2007			R		GCI17006	Inner Joint		25	26	29.8	377	108		
1.9 JTD (93 kW)	2003.09-						GC017009	Outer Joint		25	26	59	84	63	M	





		TRANSM	L/R	F/R		G-AP Ref.	PRODUCT	ABS	Technical Specifications					
									YEAR	A	B	C	H	L
<b>FIAT</b>														
<b>STILO (192),MULTI WAGON</b>														
2.4 20V (125 kW)	2001.10-			L		GCI17005	Inner Joint		25	26	32	91	95	
	2001.10-			R		GCI199130	Inner Joint		25	26	29.8	469	108	
	2001.10-					GC017009	Outer Joint		25	26	59	84	63	M
<b>STILO MULTI WAGON (192)</b>														
1.4 16V (66 kW)	2005.03-2008.08			F	Estate Engine 192B2.000	GC017026	Outer Joint		25	22	51	84	57	M
	2005.03-2008.08	MT	L	F	Estate Engine 192B2.000	GDS17099	Drive Shaft		25	22	51	84	638	
	2005.03-2008.08	MT	R	F	Estate Engine 192B2.000	GDS17080	Drive Shaft		25	22	51	84	938	
	2005.03-2008.08	MT	R	F	Estate Engine 192B2.000	GCI17004	Inner Joint		22	21	36	61	93.5	
	2005.03-2008.08	MT	R	F	Estate Engine 192B2.000	GC017026	Outer Joint		25	22	51	84	57	M
1.4 16V (70 kW)	2004.01-2008.08			F	Estate Engine 843A1.000	GC017026	Outer Joint		25	22	51	84	57	M
	2004.01-2008.08	MT	L	F	Estate Engine 843A1.000	GDS17099	Drive Shaft		25	22	51	84	638	
	2004.01-2008.08	MT	R	F	Estate Engine 843A1.000	GDS17080	Drive Shaft		25	22	51	84	938	
	2004.01-2008.08	MT	R	F	Estate Engine 843A1.000	GCI17004	Inner Joint		22	21	36	61	93.5	
	2004.01-2008.08	MT	R	F	Estate Engine 843A1.000	GC017026	Outer Joint		25	22	51	84	57	M
1.6 16V (76 kW)	2003.01-2008.08			F	Estate Engine 182B6.000	GC017026	Outer Joint		25	22	51	84	57	M
1.8 16V (98 kW)	2003.01-2008.08			F	Estate Engine 192A4.000	GC017028	Outer Joint		25	24	51	84.5	62	M
	2003.01-2008.08			F	Estate Engine 192A4.000	GCI82005	Inner Joint			25		32		
1.9 D Multijet (74 kW)	2005.09-2008.08			F	Estate Engine 192A9.000	GC017028	Outer Joint		25	24	51	84.5	62	M
	2005.09-2008.08			F	Estate Engine 192A9.000	GCI82005	Inner Joint			25		32		
1.9 D Multijet (88 kW)	2005.09-2008.08			F	Estate Engine 192A8.000	GC017028	Outer Joint		25	24	51	84.5	62	M
	2005.09-2008.08	MT	L	F	Estate Engine 192A8.000	GDS17108	Drive Shaft		25	34	51	84.5	631	
	2005.09-2008.08	MT	L	F	Estate Engine 192A8.000	GCI17013	Inner Joint		34	24	35	56.5	115	
	2005.09-2008.08	MT	L/R	F	Estate Engine 192A8.000	GC017057	Outer Joint		25	24	51	84.5	62	M
	2005.09-2008.08		L/R	F	Estate Engine 192A8.000	GDS17194	Drive Shaft		25	39.2	51	84.5	523	
	2005.09-2008.08	MT	R	F	Estate Engine 192A8.000	GDS17077	Drive Shaft		25	34	51	84.5	928	
	2005.09-2008.08	MT	R	F	Estate Engine 192A8.000	GCI17014	Inner Joint		34	24	34.9	411	102.5	
1.9 JTD (59 kW)	2003.01-2008.08			F	Estate Engine 192A3.000	GCI82005	Inner Joint			25		32		
1.9 JTD (85 kW)	2003.01-2008.08			F	Estate Engine 192A1.000/937A7.000	GC017030	Outer Joint		25	26	51	84.5	64.5	M
	2003.01-2008.08			F	Estate Engine 192A1.000/937A7.000	GC017028	Outer Joint		25	24	51	84.5	62	M
	2003.01-2008.08	MT	L	F	Estate Engine 192A1.000/937A7.000	GDS17108	Drive Shaft		25	34	51	84.5	631	
	2003.01-2008.08	MT	L	F	Estate Engine 192A1.000/937A7.000	GCI17013	Inner Joint		34	24	35	56.5	115	
	2003.01-2008.08	MT	L/R	F	Estate Engine 192A1.000/937A7.000	GC017057	Outer Joint		25	24	51	84.5	62	M
	2003.01-2008.08	MT	R	F	Estate Engine 192A1.000/937A7.000	GDS17077	Drive Shaft		25	34	51	84.5	928	
	2003.01-2008.08	MT	R	F	Estate Engine 192A1.000/937A7.000	GCI17014	Inner Joint		34	24	34.9	411	102.5	
<b>STRADA</b>														
-	2002-					GDS17031	Drive Shaft							336
	2002-					GCI17018	Inner Joint			25		32		
1.3 (50 kW)	1985.10-1987.12	MT		F	Convertible Engine 138B2.000	GC017005	Outer Joint		22	20	48.1	90.5	59.5	O
1.3 16V	2011-2012					GC017093	Outer Joint		22	28	47	89	57	O
1.4 8V	2009-					GC017093	Outer Joint		22	28	47	89	57	O
1.5 (60 kW)	1983.03-1986.12	MT		F	Convertible Engine 138B3.000	GC017006	Outer Joint		22	25	48.1	93.5	60.5	I
1.5 (63 kW)	1980.01-1989.07	MT		F	Convertible Engine 138A4.000	GC017006	Outer Joint		22	25	48.1	93.5	60.5	I
1.6 (74 kW)	1985.10-1987.12	MT		F	Convertible Engine 138AR.048	GC017006	Outer Joint		22	25	48.1	93.5	60.5	I
	1985.10-1987.12	MT		F	Convertible Engine 138AR.048	GCI48004	Inner Joint			25		32		
1.6 (77 kW)	1985.10-1987.12	MT		F	Convertible Engine 138AR.000	GC017006	Outer Joint		22	25	48.1	93.5	60.5	I
	1985.10-1987.12	MT		F	Convertible Engine 138AR.000	GCI48004	Inner Joint			25		32		
<b>STRADA (138A)</b>														
1.0 (44 kW)	1978.09-1982.09	MT		F	Hatchback Engine 127A6.000	GC017005	Outer Joint		22	20	48.1	90.5	59.5	O
1.3 (48 kW)	1978.01-1982.09	MT		F	Hatchback Engine 138A1.000	GC017005	Outer Joint		22	20	48.1	90.5	59.5	O
	1983.11-1985.08	MT		F	Hatchback Engine 149A3.000/149A7.000	GC017005	Outer Joint		22	20	48.1	90.5	59.5	O
1.3 (55 kW)	1981.01-1982.09	MT		F	Hatchback Engine 138A3.000	GC017005	Outer Joint		22	20	48.1	90.5	59.5	O
1.5 (63 kW)	1981.01-1987.05	MT		F	Hatchback Engine 138A4.000	GC017006	Outer Joint		22	25	48.1	93.5	60.5	I
	1981.01-1987.05	AT		F	Hatchback Engine 138A4.000	GC017005	Outer Joint		22	20	48.1	90.5	59.5	O
1.5 i.e. (55 kW)	1985.10-1987.05	MT		F	Hatchback Engine 138C2.048/149C1.000	GC017006	Outer Joint		22	25	48.1	93.5	60.5	I
	1985.10-1987.05	AT		F	Hatchback Engine 138C2.048/149C1.000	GC017005	Outer Joint		22	20	48.1	90.5	59.5	O
1.6 i.e. (66 kW)	1985.09-1987.12	MT		F	Hatchback Engine 149C2.000	GC017006	Outer Joint		22	25	48.1	93.5	60.5	I
	1985.09-1987.12	MT		F	Hatchback Engine 149C2.000	GCI48004	Inner Joint			25		32		
1.6 Sport (77 kW)	1981.05-1982.12	MT		F	Hatchback Engine 138AR.000	GC017006	Outer Joint		22	25	48.1	93.5	60.5	I
	1981.05-1982.12	MT		F	Hatchback Engine 138AR.000	GCI48004	Inner Joint			25		32		
1.7 Diesel (40 kW)	1979.10-1982.09	MT		F	Hatchback Engine 138A5.000	GC017005	Outer Joint		22	20	48.1	90.5	59.5	O
1.7 Diesel (43 kW)	1979.10-1982.09	MT		F	Hatchback Engine 138A5.000	GC017005	Outer Joint		22	20	48.1	90.5	59.5	O
2.0 TC Abarth (92 kW)	1981.11-1982.09	MT		F	Hatchback Engine 138AR1.000	GCI48004	Inner Joint			25		32		



		TRANSM	L/R	F/R		G-AP Ref.	PRODUCT	ABS	Technical Specifications						
									YEAR	A	B	C	H	L	P
<b>FIAT</b>															
<b>STRADA (178E)</b>															
1.2 (44 kW)	2003.04-			F	Pickup Engine 188A4.000	GCO17037	Outer Joint		22	22	51	89	61	O	
1.9 JTD (59 kW)	2003.04-			F	Pickup Engine 188A2.000	GCO17031	Outer Joint		25	24	51	90	62	M	
<b>STRADA II (138A)</b>															
1.1 (40 kW)	1982.10-	1987.12	MT	F	Hatchback Engine 138B.000/138B1.000/138C1.000	GCO17005	Outer Joint		22	20	48.1	90.5	59.5	O	
1.1 (43 kW)	1985.04-	1987.12	MT	F	Hatchback Engine 146A4.048	GCO17005	Outer Joint		22	20	48.1	90.5	59.5	O	
1.3 (50 kW)	1983.01-	1985.04	MT	F	Hatchback Engine 138B2.000	GCO17005	Outer Joint		22	20	48.1	90.5	59.5	O	
1.5 (55 kW)	1985.09-	1988.12	MT	F	Hatchback Engine 138A2.000	GCO17006	Outer Joint		22	25	48.1	93.5	60.5	I	
	1985.09-	1988.12	AT	F	Hatchback Engine 138A2.000	GCO17005	Outer Joint		22	20	48.1	90.5	59.5	O	
1.5 (58 kW)	1985.08-	1987.05	MT	F	Hatchback Engine 149A5.000	GCO17006	Outer Joint		22	25	48.1	93.5	60.5	I	
	1985.08-	1987.05	AT	F	Hatchback Engine 149A5.000	GCO17005	Outer Joint		22	20	48.1	90.5	59.5	O	
1.5 (60 kW)	1983.01-	1987.12	MT	F	Hatchback Engine 138B3.000	GCO17006	Outer Joint		22	25	48.1	93.5	60.5	I	
	1983.01-	1987.12	AT	F	Hatchback Engine 138B3.000	GCO17005	Outer Joint		22	20	48.1	90.5	59.5	O	
1.5 CAT (55 kW)	1985.09-	1988.12	MT	F	Hatchback Engine 138C2.048/149C1.000	GCO17006	Outer Joint		22	25	48.1	93.5	60.5	I	
	1985.09-	1988.12	AT	F	Hatchback Engine 138C2.048/149C1.000	GCO17005	Outer Joint		22	20	48.1	90.5	59.5	O	
1.6 (74 kW)	1983.01-	1987.12	MT	F	Hatchback Engine 149A4.000	GCO17006	Outer Joint		22	25	48.1	93.5	60.5	I	
	1983.01-	1987.12	MT	F	Hatchback Engine 149A4.000	GCI48004	Inner Joint			25		32			
1.6 (77 kW)	1983.01-	1987.12	MT	F	Hatchback Engine 138AR.000	GCO17006	Outer Joint		22	25	48.1	93.5	60.5	I	
	1983.01-	1987.12	MT	F	Hatchback Engine 138AR.000	GCI48004	Inner Joint			25		32			
1.6 i.e. (66 kW)	1985.12-	1987.12	MT	F	Hatchback Engine 138AR.000	GCO17006	Outer Joint		22	25	48.1	93.5	60.5	I	
	1985.12-	1987.12	MT	F	Hatchback Engine 138AR.000	GCI48004	Inner Joint			25		32			
1.7 Diesel (43 kW)	1982.10-	1985.10	MT	F	Hatchback Engine 138B6.000	GCO17005	Outer Joint		22	20	48.1	90.5	59.5	O	
1.7 Diesel (44 kW)	1985.05-	1987.12	MT	F	Hatchback Engine 138C.000/149B3.000	GCO17005	Outer Joint		22	20	48.1	90.5	59.5	O	
1.9 Turbo Diesel (59 kW)	1985.12-	1987.12	MT	F	Hatchback Engine 831D1.000	GCO17006	Outer Joint		22	25	48.1	93.5	60.5	I	
	1985.12-	1987.12	MT	F	Hatchback Engine 831D1.000	GCI48004	Inner Joint			25		32			
2.0 TC Abarth (96 kW)	1983.04-	1987.12		F	Hatchback Engine 138AR2.000	GCI18070	Inner Joint			25		32			
	1983.04-	1987.12	MT	F	Hatchback Engine 138AR2.000	GCI48004	Inner Joint			25		32			
<b>TALENTO</b>															
2.1						GCO10104	Outer Joint	54T	28	27	63	112.5	63	I	
<b>TALENTO (290)</b>															
1.9 D (52 kW)	1989.03-	1994.03		R	F	Box Engine 149B1.000	GDS10013	Drive Shaft	28	25	63	112.5	1072		
	1989.03-	1994.03		R	F	Bus Engine 149B1.000	GDS10013	Drive Shaft	28	25	63	112.5	1072		
	1989.03-	1994.03		R	F	Platform/Chassis Engine 149B1.000	GDS10013	Drive Shaft	28	25	63	112.5	1072		
	1989.03-	1994.03			F	Box Engine 149B1.000	GCO10010	Outer Joint	28	27	63	112.5	63	I	
	1989.03-	1994.03			F	Bus Engine 149B1.000	GCO10010	Outer Joint	28	27	63	112.5	63	I	
	1989.03-	1994.03			F	Platform/Chassis Engine 149B1.000	GCO10010	Outer Joint	28	27	63	112.5	63	I	
	1989.03-	1994.03	MT	L	F	Box Engine 149B1.000	GDS10034	Drive Shaft	28	25	63	112.5	701		
	1989.03-	1994.03	MT	L	F	Bus Engine 149B1.000	GDS10034	Drive Shaft	28	25	63	112.5	701		
	1989.03-	1994.03	MT	L	F	Platform/Chassis Engine 149B1.000	GDS10034	Drive Shaft	28	25	63	112.5	701		
2.0 (55 kW)	1989.03-	1994.03	MT	R	F	Box Engine 170B	GDS10068	Drive Shaft	28	25	63	112.5	1068		
	1989.03-	1994.03	MT	R	F	Bus Engine 170B	GDS10068	Drive Shaft	28	25	63	112.5	1068		
	1989.03-	1994.03	MT	R	F	Platform/Chassis Engine 170B	GDS10068	Drive Shaft	28	25	63	112.5	1068		
	1989.03-	1994.03		R	F	Box Engine 170B	GDS10013	Drive Shaft	28	25	63	112.5	1072		
	1989.03-	1994.03		R	F	Bus Engine 170B	GDS10013	Drive Shaft	28	25	63	112.5	1072		
	1989.03-	1994.03		R	F	Platform/Chassis Engine 170B	GDS10013	Drive Shaft	28	25	63	112.5	1072		
	1989.03-	1994.03	MT	L	F	Box Engine 170B	GDS10034	Drive Shaft	28	25	63	112.5	701		
	1989.03-	1994.03	MT	L	F	Bus Engine 170B	GDS10034	Drive Shaft	28	25	63	112.5	701		
	1989.03-	1994.03	MT	L	F	Platform/Chassis Engine 170B	GDS10034	Drive Shaft	28	25	63	112.5	701		
<b>TEMPRA (159)</b>															
1.4 i.e. (51 kW)	1992.03-	1996.08			F	Saloon Engine 160A1.046/836A4.000	GCI82006	Inner Joint			25		32		
	1992.03-	1996.08			F	Saloon Engine 160A1.046/836A4.000	GCO17018	Outer Joint	90T	25	25	52	85	58	I
	1992.03-	1996.08	AT		F	Saloon Engine 160A1.046/836A4.000	GCI48004	Inner Joint			25		32		
1.6 (63 kW)	1990.03-	1993.04			F	Saloon Engine 159A3.000	GCI82006	Inner Joint			25		32		
	1990.03-	1993.04	AT		F	Saloon Engine 159A3.000	GCI48004	Inner Joint			25		32		
1.6 i.e. (55 kW)	1992.06-	1996.08			F	Saloon Engine 159A3.048/835C1.000	GCI82006	Inner Joint			25		32		
	1992.06-	1996.08			F	Saloon Engine 159A3.048/835C1.000	GCO17018	Outer Joint	90T	25	25	52	85	58	I
	1992.06-	1996.08	AT		F	Saloon Engine 159A3.048/835C1.000	GCI48004	Inner Joint			25		32		
1.6 i.e. (57 kW)	1990.06-	1992.07	AT		F	Saloon Engine 159A3.046	GCI48004	Inner Joint			25		32		
1.6 i.e. (66 kW)	1994.06-	1996.08	AT		F	Saloon Engine 159B9.000	GCI48004	Inner Joint			25		32		
1.8 i.e. (66 kW)	1993.09-	1996.08			F	Saloon Engine 835C4.000	GCI18070	Inner Joint			25		32		
	1993.09-	1996.08	MT		F	Saloon Engine 835C4.000	GCO17012	Outer Joint		25	25	52	84.5	56	I
	1993.09-	1996.08			F	Saloon Engine 835C4.000	GCO17018	Outer Joint	90T	25	25	52	85	58	I
	1993.09-	1996.08	MT		F	Saloon Engine 835C4.000	GCI48004	Inner Joint			25		32		





		TRANSM	L/R	F/R		G-AP Ref.	PRODUCT	ABS	Technical Specifications						
									YEAR	A	B	C	H	L	P
<b>FIAT</b>															
<b>TEMPRA (159)</b>															
1.8 i.e. (74 kW)	1994.10-	1996.08	MT		F	Saloon Engine 836A5.000	GCO17012	Outer Joint		25	25	52	84.5	56	I
	1994.10-	1996.08	MT		F	Saloon Engine 836A5.000	GCI48004	Inner Joint			25		32		
1.8 i.e. (76 kW)	1993.09-	1996.08	MT		F	Saloon Engine 835C2.000	GCO17012	Outer Joint		25	25	52	84.5	56	I
	1993.09-	1996.08	MT		F	Saloon Engine 835C2.000	GCI48004	Inner Joint			25		32		
1.8 i.e. (77 kW)	1992.03-	1996.08			F	Saloon Engine 159A4.046	GCI18070	Inner Joint			25		32		
	1992.03-	1996.08	MT		F	Saloon Engine 159A4.046	GCO17012	Outer Joint		25	25	52	84.5	56	I
	1992.03-	1996.08			F	Saloon Engine 159A4.046	GCO17018	Outer Joint	90T	25	25	52	85	58	I
	1992.03-	1996.08	MT		F	Saloon Engine 159A4.046	GCI48004	Inner Joint			25		32		
1.9 TD (59 kW)	1992.07-	1996.08			F	Saloon Engine 160B6.046	GCI18070	Inner Joint			25		32		
	1992.07-	1996.08	MT		F	Saloon Engine 160B6.046	GCO17012	Outer Joint		25	25	52	84.5	56	I
	1992.07-	1996.08			F	Saloon Engine 160B6.046	GCO17018	Outer Joint	90T	25	25	52	85	58	I
	1992.07-	1996.08	MT		F	Saloon Engine 160B6.046	GCI48004	Inner Joint			25		32		
1.9 TD (66 kW)	1990.05-	1996.08			F	Saloon Engine 160A6.000/160D1.000	GCI18070	Inner Joint			25		32		
	1990.05-	1996.08	MT		F	Saloon Engine 160A6.000/160D1.000	GCO17012	Outer Joint		25	25	52	84.5	56	I
	1990.05-	1996.08			F	Saloon Engine 160A6.000/160D1.000	GCO17018	Outer Joint	90T	25	25	52	85	58	I
	1990.05-	1996.08	MT		F	Saloon Engine 160A6.000/160D1.000	GCI48004	Inner Joint			25		32		
2.0 i.e. (83 kW)	1990.10-	1996.08			F	Saloon Engine 159A6.046	GCI18070	Inner Joint			25		32		
	1990.10-	1996.08			F	Saloon Engine 159A6.046	GCO17018	Outer Joint	90T	25	25	52	85	58	I
	1990.10-	1996.08	MT		F	Saloon Engine 159A6.046	GCI48004	Inner Joint			25		32		
<b>TEMPRA S.W. (159)</b>															
1.4 i.e. (51 kW)	1992.10-	1996.08			F	Estate Engine 160A1.046/836A4.000	GCO17018	Outer Joint	90T	25	25	52	85	58	I
	1992.10-	1996.08	AT		F	Estate Engine 160A1.046/836A4.000	GCI48004	Inner Joint			25		32		
1.6 (63 kW)	1990.12-	1993.04	AT		F	Estate Engine 159A3.000	GCI48004	Inner Joint			25		32		
1.6 i.e. (55 kW)	1992.10-	1996.08			F	Estate Engine 159A3.048/835C1.000	GCO17018	Outer Joint	90T	25	25	52	85	58	I
	1992.10-	1996.08	AT		F	Estate Engine 159A3.048/835C1.000	GCI48004	Inner Joint			25		32		
1.6 i.e. (57 kW)	1990.10-	1996.08	AT		F	Estate Engine 159A3.046/835C1.000	GCI48004	Inner Joint			25		32		
1.6 i.e. (66 kW)	1994.06-	1996.08	AT		F	Estate Engine 159B9.000	GCI48004	Inner Joint			25		32		
1.8 i.e. (66 kW)	1993.09-	1996.08			F	Estate Engine 835C4.000	GCI18070	Inner Joint			25		32		
	1993.09-	1996.08	MT		F	Estate Engine 835C4.000	GCO17012	Outer Joint		25	25	52	84.5	56	I
	1993.09-	1996.08			F	Estate Engine 835C4.000	GCO17018	Outer Joint	90T	25	25	52	85	58	I
	1993.09-	1996.08	MT		F	Estate Engine 835C4.000	GCI48004	Inner Joint			25		32		
1.8 i.e. (74 kW)	1994.10-	1996.08	MT		F	Estate Engine 836A5.000	GCO17012	Outer Joint		25	25	52	84.5	56	I
	1994.10-	1996.08	MT		F	Estate Engine 836A5.000	GCI48004	Inner Joint			25		32		
1.8 i.e. (76 kW)	1993.09-	1996.08	MT		F	Estate Engine 835C2.000	GCO17012	Outer Joint		25	25	52	84.5	56	I
	1993.09-	1996.08	MT		F	Estate Engine 835C2.000	GCI48004	Inner Joint			25		32		
1.8 i.e. (77 kW)	1992.03-	1993.12			F	Estate Engine 159A4.046	GCI18070	Inner Joint			25		32		
	1992.03-	1993.12	MT		F	Estate Engine 159A4.046	GCO17012	Outer Joint		25	25	52	84.5	56	I
	1992.03-	1993.12			F	Estate Engine 159A4.046	GCO17018	Outer Joint	90T	25	25	52	85	58	I
	1992.03-	1993.12	MT		F	Estate Engine 159A4.046	GCI48004	Inner Joint			25		32		
1.9 TD (59 kW)	1992.03-	1993.06			F	Estate Engine 160B6.046	GCI18070	Inner Joint			25		32		
	1992.03-	1993.06	MT		F	Estate Engine 160B6.046	GCO17012	Outer Joint		25	25	52	84.5	56	I
	1992.03-	1993.06			F	Estate Engine 160B6.046	GCO17018	Outer Joint	90T	25	25	52	85	58	I
	1992.03-	1993.06	MT		F	Estate Engine 160B6.046	GCI48004	Inner Joint			25		32		
1.9 TD (66 kW)	1991.07-	1995.02			F	Estate Engine 160A6.000/160D1.000	GCI18070	Inner Joint			25		32		
	1991.07-	1995.02	MT		F	Estate Engine 160A6.000/160D1.000	GCO17012	Outer Joint		25	25	52	84.5	56	I
	1991.07-	1995.02			F	Estate Engine 160A6.000/160D1.000	GCO17018	Outer Joint	90T	25	25	52	85	58	I
	1991.07-	1995.02	MT		F	Estate Engine 160A6.000/160D1.000	GCI48004	Inner Joint			25		32		
2.0 i.e. (83 kW)	1991.01-	1995.03			F	Estate Engine 159A6.046	GCI18070	Inner Joint			25		32		
	1991.01-	1995.03			F	Estate Engine 159A6.046	GCO17018	Outer Joint	90T	25	25	52	85	58	I
	1991.01-	1995.03	MT		F	Estate Engine 159A6.046	GCI48004	Inner Joint			25		32		
2.0 i.e. 4x4 (83 kW)	1992.03-	1995.03				Estate Engine 159A6.046	GCI18070	Inner Joint			25		32		
	1992.03-	1995.03				Estate Engine 159A6.046	GCO17018	Outer Joint	90T	25	25	52	85	58	I
	1992.03-	1995.03	MT		F	Estate Engine 159A6.046	GCI48004	Inner Joint			25		32		
<b>TIPO</b>															
1.6	1994.01-	1997.12	MT				GCO17046	Outer Joint		22	20	46	79.5	51	O
<b>TIPO (160)</b>															
1.1 (41 kW)	1988.01-	1991.10			F	Hatchback Engine 160A3.000	GCI82006	Inner Joint			25		32		
	1988.01-	1991.10	AT		F	Hatchback Engine 160A3.000	GCI48004	Inner Joint			25		32		
1.4 (52 kW)	1987.07-	1989.12	AT		F	Hatchback Engine 160A1.000/160A1.048	GCI48004	Inner Joint			25		32		
1.4 i.e. (51 kW)	1989.05-	1995.04			F	Hatchback Engine 160A1.046/836A4.000	GCI82006	Inner Joint			25		32		
	1989.05-	1995.04	AT		F	Hatchback Engine 160A1.046/836A4.000	GCI48004	Inner Joint			25		32		
1.4 i.e. (57 kW)	1989.05-	1995.04	AT		F	Hatchback Engine 159A2.000	GCI48004	Inner Joint			25		32		









		TRANSM	L/R	F/R		G-AP Ref.	PRODUCT	ABS	Technical Specifications							
									YEAR	A	B	C	H	L	P	
<b>FIAT</b>																
<b>TIPO (160)</b>																
1.6 (61 kW)	1988.01-	1991.10	AT		F	Hatchback Engine 160A2.000	GCI48004	Inner Joint			25		32			
1.6 i.e. (55 kW)	1992.10-	1995.04			F	Hatchback Engine 159A3.048/835C1.000	GCI82006	Inner Joint			25		32			
	1992.10-	1995.04	AT		F	Hatchback Engine 159A3.048/835C1.000	GCI48004	Inner Joint			25		32			
1.6 i.e. (57 kW)	1990.07-	1993.01			F	Hatchback Engine 159A3.046	GCI82006	Inner Joint			25		32			
	1990.07-	1993.01	AT		F	Hatchback Engine 159A3.046	GCI48004	Inner Joint			25		32			
1.6 i.e. (66 kW)	1988.02-	1991.05	AT		F	Hatchback Engine 149C2.046	GCI18070	Inner Joint			25		32			
	1988.02-	1991.05	MT		F	Hatchback Engine 149C2.046	GC017012	Outer Joint	25	25	52	84.5	56	I		
	1988.02-	1991.05	MT		F	Hatchback Engine 149C2.046	GCI48004	Inner Joint			25		32			
1.7 D (43 kW)	1988.01-	1994.10			F	Hatchback Engine 149B4.000	GCI18070	Inner Joint			25		32			
	1988.01-	1994.10			F	Hatchback Engine 149B4.000	GC017018	Outer Joint	90T	25	25	52	85	58	I	
1.8 i.e. (66 kW)	1993.09-	1995.04			F	Hatchback Engine 835C4.000	GCI18070	Inner Joint			25		32			
	1993.09-	1995.04	MT		F	Hatchback Engine 835C4.000	GC017012	Outer Joint		25	25	52	84.5	56	I	
	1993.09-	1995.04			F	Hatchback Engine 835C4.000	GC017018	Outer Joint	90T	25	25	52	85	58	I	
	1993.09-	1995.04	MT		F	Hatchback Engine 835C4.000	GCI48004	Inner Joint			25		32			
1.8 i.e. (74 kW)	1994.10-	1995.04	MT		F	Hatchback Engine 159A4.000	GC017012	Outer Joint		25	25	52	84.5	56	I	
	1994.10-	1995.04	MT		F	Hatchback Engine 159A4.000	GCI48004	Inner Joint			25		32			
1.8 i.e. (76 kW)	1993.04-	1995.04			F	Hatchback Engine 835C2.000	GCI18070	Inner Joint			25		32			
	1993.04-	1995.04	MT		F	Hatchback Engine 835C2.000	GC017012	Outer Joint	25	25	52	84.5	56	I		
	1993.04-	1995.04			F	Hatchback Engine 835C2.000	GC017018	Outer Joint	90T	25	25	52	85	58	I	
	1993.04-	1995.04	MT		F	Hatchback Engine 835C2.000	GCI48004	Inner Joint			25		32			
1.8 i.e. (77 kW)	1990.10-	1993.06			F	Hatchback Engine 159A4.046	GCI18070	Inner Joint			25		32			
	1990.10-	1993.06	MT		F	Hatchback Engine 159A4.046	GC017012	Outer Joint		25	25	52	84.5	56	I	
	1990.10-	1993.06			F	Hatchback Engine 159A4.046	GC017018	Outer Joint	90T	25	25	52	85	58	I	
	1990.10-	1993.06	MT		F	Hatchback Engine 159A4.046	GCI48004	Inner Joint			25		32			
1.8 i.e. (81 kW)	1990.10-	1993.06	MT		F	Hatchback Engine 159A4.000	GC017012	Outer Joint		25	25	52	84.5	56	I	
	1990.10-	1993.06	MT		F	Hatchback Engine 159A4.000	GCI48004	Inner Joint			25		32			
1.9 TD (59 kW)	1992.03-	1993.06			F	Hatchback Engine 160B6.046	GCI18070	Inner Joint			25		32			
	1992.03-	1993.06	MT		F	Hatchback Engine 160B6.046	GC017012	Outer Joint		25	25	52	84.5	56	I	
	1992.03-	1993.06			F	Hatchback Engine 160B6.046	GC017018	Outer Joint	90T	25	25	52	85	58	I	
	1992.03-	1993.06	MT		F	Hatchback Engine 160B6.046	GCI48004	Inner Joint			25		32			
1.9 TD (66 kW)	1990.09-	1995.04			F	Hatchback Engine 160A6.000/160A6.046/160D1.000	GCI18070	Inner Joint			25		32			
	1990.09-	1995.04	MT		F	Hatchback Engine 160A6.000/160A6.046/160D1.000	GC017012	Outer Joint		25	25	52	84.5	56	I	
	1990.09-	1995.04			F	Hatchback Engine 160A6.000/160A6.046/160D1.000	GC017018	Outer Joint	90T	25	25	52	85	58	I	
	1990.09-	1995.04	MT		F	Hatchback Engine 160A6.000/160A6.046/160D1.000	GCI48004	Inner Joint			25		32			
2.0 i.e. (80 kW)	1990.06-	1992.03			F	Hatchback Engine 159A5.046	GCI18070	Inner Joint			25		32			
	1990.06-	1992.03			F	Hatchback Engine 159A5.046	GC017018	Outer Joint	90T	25	25	52	85	58	I	
	1990.06-	1992.03	MT		F	Hatchback Engine 159A5.046	GCI48004	Inner Joint			25		32			
2.0 i.e. (83 kW)	1990.03-	1995.04			F	Hatchback Engine 159A6.046	GCI18070	Inner Joint			25		32			
	1990.03-	1995.04			F	Hatchback Engine 159A6.046	GC017018	Outer Joint	90T	25	25	52	85	58	I	
	1990.03-	1995.04	MT		F	Hatchback Engine 159A6.046	GCI48004	Inner Joint			25		32			
<b>ULYSSE (179AX)</b>																
2.0 (100 kW)	2002.08-	2011.06	MT	L	F	MPV Engine RFN(EW10J4)	GDS10422	Drive Shaft		27	24	58	81.5	659		
2.0 D Multijet (100 kW)	2006.05-	2011.06	MT	R	F	MPV Engine RHR	GDS18291	Drive Shaft		27	37	58	81	977		
2.0 JTD (79 kW)	2003.07-	2005.01	MT	R	F	MPV Engine RHM(DW10ATED4)	GDS18291	Drive Shaft		27	37	58	81	977		
2.0 JTD (80 kW)	2002.08-	2006.08			F	MPV Engine RHW(DW10ATED4)	GC017044	Outer Joint		27	28	58	81.5	62	M	
	2002.08-	2006.08	MT	R	F	MPV Engine RHW(DW10ATED4)	GDS18291	Drive Shaft		27	37	58	81	977		
2.2 JTD (94 kW)	2002.08-	2006.08			F	MPV Engine 4HW(DW12ATED4)	GC017044	Outer Joint		27	28	58	81.5	62	M	
	2002.08-	2006.08			F	MPV Engine 4HW(DW12ATED4)	GC018098	Outer Joint		27	29	58	81	71	M	
<b>ULYSSE (220)</b>																
1.8 (73 kW)	1997.05-	2002.08			F	MPV Engine LFW	GC010059	Outer Joint	48T	27	34	59	82	55	I	
	1997.05-	2002.08			F	MPV Engine LFW	GC010016	Outer Joint		27	34	59	82	55	I	
	1997.05-	2002.08			F	MPV Engine LFW	GC010018	Outer Joint	48T	27	34	61	82	55	I	
	1997.05-	2002.08	MT	L	F	MPV Engine LFW	GDS10052	Drive Shaft		27	24	61	82	648		
	1997.05-	2002.08	MT	L	F	MPV Engine LFW	GDS10082	Drive Shaft	48T	27	24	59	82	648		
	1997.05-	2002.08	MT	R	F	MPV Engine LFW	GDS10120	Drive Shaft		27	24	59	82	928		
	1997.05-	2002.08	MT	R	F	MPV Engine LFW	GDS10012	Drive Shaft	48T	27	24	64	80.5	928		
1.9 TD (66 kW)	1995.02-	2002.08			F	MPV Engine DHX(XUD9TF/L)	GC010014	Outer Joint		27	39	59	82	63	I	
	1995.02-	2002.08			F	MPV Engine DHX(XUD9TF/L)	GC010015	Outer Joint	48T	27	39	59	82	63	I	
	1995.02-	2002.08	MT	L	F	MPV Engine DHX(XUD9TF/L)	GDS10016	Drive Shaft	48T	27	37	59	82	641		
	1995.02-	2002.08	MT	L	F	MPV Engine DHX(XUD9TF/L)	GDS10072	Drive Shaft		27	37	59	82	641		
	1995.02-	2002.08	MT	R	F	MPV Engine DHX(XUD9TF/L)	GDS10155	Drive Shaft		27	37	59	82	947		
1995.02-	2002.08	MT	R	F	MPV Engine DHX(XUD9TF/L)	GDS10014	Drive Shaft	48T	27	37	59	82	947			



	 YEAR	TRANSM	L/R	F/R		G-AP Ref.	PRODUCT	ABS	Technical Specifications					
									A	B	C	H	L	P
<b>FIAT</b>														
<b>ULYSSE (220)</b>														
2.0 (89 kW)	1994.06-2002.08			F	MPV Engine RFU(XU10J2C)	GCO10059	Outer Joint	48T	27	34	59	82	55	I
	1994.06-2002.08			F	MPV Engine RFU(XU10J2C)	GCO10016	Outer Joint		27	34	59	82	55	I
	1994.06-2002.08			F	MPV Engine RFU(XU10J2C)	GCO10018	Outer Joint	48T	27	34	61	82	55	I
	1994.06-2002.08	MT	L	F	MPV Engine RFU(XU10J2C)	GDS10052	Drive Shaft		27	24	61	82	648	
	1994.06-2002.08	MT	L	F	MPV Engine RFU(XU10J2C)	GDS10082	Drive Shaft	48T	27	24	59	82	648	
	1994.06-2002.08	MT	R	F	MPV Engine RFU(XU10J2C)	GDS10120	Drive Shaft		27	24	59	82	928	
	1994.06-2002.08	MT	R	F	MPV Engine RFU(XU10J2C)	GDS10012	Drive Shaft	48T	27	24	64	80.5	928	
2.0 16V (100 kW)	2000.09-2002.08			F	MPV Engine RFN(EW10J4)	GCO10018	Outer Joint	48T	27	34	61	82	55	I
2.0 JTD (80 kW)	1999.10-2002.08			F	MPV Engine RHZ	GCO10015	Outer Joint	48T	27	39	59	82	63	I
	1999.10-2002.08	MT	L	F	MPV Engine RHZ	GDS10264	Drive Shaft	48T	27	37	59	82	630	
	1999.10-2002.08	MT	R	F	MPV Engine RHZ	GDS10057	Drive Shaft		27	37	59	82	960	
	1999.10-2002.08	MT	R	F	MPV Engine RHZ	GDS45120	Drive Shaft	48T	27	37	59	82	960	
	1999.10-2002.08			R	MPV Engine RHZ	GDS10237	Drive Shaft	48T	27	37	59	82	953	
2.0 Turbo (108 kW)	1994.06-2002.08			F	MPV Engine RGX(XU10J2CTE)	GCO10015	Outer Joint	48T	27	39	59	82	63	I
	1994.06-2002.08	MT	L	F	MPV Engine RGX(XU10J2CTE)	GDS10016	Drive Shaft	48T	27	37	59	82	641	
	1994.06-2002.08	MT	L	F	MPV Engine RGX(XU10J2CTE)	GDS10072	Drive Shaft		27	37	59	82	641	
	1994.06-2002.08	MT	R	F	MPV Engine RGX(XU10J2CTE)	GDS10155	Drive Shaft		27	37	59	82	947	
	1994.06-2002.08	MT	R	F	MPV Engine RGX(XU10J2CTE)	GDS10014	Drive Shaft	48T	27	37	59	82	947	
<b>UNO (146A / E) 55</b>														
1.0 (41 kW)	1994.04-		MT	L	India	GDS17015	Drive Shaft		20	31.95	43.1	90.5	552	
	1994.04-		MT	R	India	GDS17016	Drive Shaft		20	31.95	43.1	90.5	861.5	
<b>UNO (146A/E)</b>														
1.3 Turbo i.e. (73 kW)	1987.01-1987.12	MT		F	Hatchback Engine 146A2.146	GCO17006	Outer Joint		22	25	48.1	93.5	60.5	I
1.3 Turbo i.e. (74 kW)	1989.09-1991.03	MT		F	Hatchback Engine 146A2.246	GCO17006	Outer Joint		22	25	48.1	93.5	60.5	I
1.3 Turbo i.e. (77 kW)	1985.04-1989.08	MT		F	Hatchback Engine 146A2.000	GCO17006	Outer Joint		22	25	48.1	93.5	60.5	I
1.4 TD (52 kW)	1986.10-1990.10	MT		F	Hatchback Engine 146B.000/146B3.000	GCO17005	Outer Joint		22	20	48.1	90.5	59.5	O
	1986.10-1990.10	MT	L	F	Hatchback Engine 146B.000/146B3.000	GDS17020	Drive Shaft		22	31.95	48	92	539.5	
	1986.10-1990.10	MT	R	F	Hatchback Engine 146B.000/146B3.000	GDS17021	Drive Shaft		22	31.95	48	92	877	
1.4 Turbo i.e. (82 kW)	1989.09-1993.09	MT		F	Hatchback Engine 146A8.046	GCO17006	Outer Joint		22	25	48.1	93.5	60.5	I
1.4 Turbo i.e. (87 kW)	1989.12-1996.12	MT		F	Hatchback Engine 146A8.000	GCO17006	Outer Joint		22	25	48.1	93.5	60.5	I
1.7 Diesel (42 kW)	1989.09-1993.12	MT		F	Hatchback Engine 146B2.000	GCO17005	Outer Joint		22	20	48.1	90.5	59.5	O
	1989.09-1993.12	MT	L	F	Hatchback Engine 146B2.000	GDS17020	Drive Shaft		22	31.95	48	92	539.5	
	1989.09-1993.12	MT	R	F	Hatchback Engine 146B2.000	GDS17021	Drive Shaft		22	31.95	48	92	877	
	1989.09-1993.12	MT		F	Hatchback Engine 146B2.000	GCI48004	Inner Joint			25		32		
1.7 Diesel (44 kW)	1986.07-1989.08	MT		F	Hatchback Engine 149B3.000	GCO17005	Outer Joint		22	20	48.1	90.5	59.5	O
	1986.07-1989.08	MT	L	F	Hatchback Engine 149B3.000	GDS17020	Drive Shaft		22	31.95	48	92	539.5	
	1986.07-1989.08	MT	R	F	Hatchback Engine 149B3.000	GDS17021	Drive Shaft		22	31.95	48	92	877	
	1986.07-1989.08	MT		F	Hatchback Engine 149B3.000	GCI48004	Inner Joint			25		32		
<b>WEEKEND</b>														
-	2003-					GDS17031	Drive Shaft							336
	2003-					GCI17018	Inner Joint			25		32		
<b>X 1 / 9 (128 AS)</b>														
1.5 (56 kW)	1985.06-1989.12			R	Convertible Engine 138BS.031	GCI82006	Inner Joint			25		32		
	1985.06-1989.12	MT		R	Convertible Engine 138BS.031	GCI48004	Inner Joint			25		32		
1.5 (63 kW)	1978.11-1989.12			R	Convertible Engine 138AS.000	GCI82006	Inner Joint			25		32		
	1978.11-1989.12	MT		R	Convertible Engine 138AS.000	GCI48004	Inner Joint			25		32		
<b>FIAT LCV</b>														
<b>DOBLO CARGO (223)</b>														
1.3 D Multijet (55 kW)	2005.10-			L		GCI99008	Inner Joint		24	24	29.7	86.5	93	
1.3 JTD 16V (51 kW)	2004.05-			L		GCI99008	Inner Joint		24	24	29.7	86.5	93	
1.9 JTD (74 kW)	2001.09-2004.01			L		GCI99008	Inner Joint		24	24	29.7	86.5	93	
1.9 JTD (77 kW)	2001.09-2006.12			L		GCI99008	Inner Joint		24	24	29.7	86.5	93	
1.9 JTD (88 kW)	2005.11-2006.12			L		GCI99008	Inner Joint		24	24	29.7	86.5	93	
<b>DOBLO CARGO I (223)</b>														
1.3 D Multijet (55 kW)	2005.10-			R		GCI17015	Inner Joint		24	24	29.7	379	100.5	
1.3 JTD 16V (51 kW)	2004.05-			R		GCI17015	Inner Joint		24	24	29.7	379	100.5	
1.9 JTD (74 kW)	2001.09-2006.12			R		GCI17015	Inner Joint		24	24	29.7	379	100.5	
1.9 JTD (77 kW)	2001.09-2006.12			R		GCI17015	Inner Joint		24	24	29.7	379	100.5	
1.9 JTD (88 kW)	2005.11-2006.12			R		GCI17015	Inner Joint		24	24	29.7	379	100.5	
<b>DOBLO CARGO II (223)</b>														
1.3 D Multijet (55 kW)	2005.10-			R		GCI17015	Inner Joint		24	24	29.7	379	100.5	

		TRANSM	L/R	F/R		G-AP Ref.	PRODUCT	ABS	Technical Specifications						
									A	B	C	H	L	P	
YEAR															
<b>FIAT LCV</b>															
<b>DOBLO CARGO II (223)</b>															
1.3 JTD 16V (51 kW)	2004.05-			R		GCI17015	Inner Joint		24	24	29.7	379	100.5		
1.4 (57 kW)	2005.10-					GCI17027	Inner Joint		22	22	36	61.5	93.5		
1.9 JTD (74 kW)	2001.09-	2006.12		R		GCI17015	Inner Joint		24	24	29.7	379	100.5		
1.9 JTD (77 kW)	2001.09-	2006.12		R		GCI17015	Inner Joint		24	24	29.7	379	100.5		
1.9 JTD (88 kW)	2005.11-	2006.12		R		GCI17015	Inner Joint		24	24	29.7	379	100.5		
<b>DOBLO CARGO III (263)</b>															
1.3 D Multijet (66 kW)	2010.02-			L		GCI17025	Inner Joint		24	24	29.7	86.5	93		
	2010.02-			R		GCI17026	Inner Joint		24	24	29.7	379	100.5		
1.4 (88 kW)	2011.10-			L		GCI17031	Inner Joint		25	26	32	59	110.5		
1.4 Natural Power (88 kW)	2010.06-			L		GCI17031	Inner Joint		25	26	32	59	110.5		
1.6 D Multijet (66 kW)	2010.02-			L		GCI17031	Inner Joint		25	26	32	59	110.5		
1.6 D Multijet (74 kW)	2010.02-			L		GCI17031	Inner Joint		25	26	32	59	110.5		
1.6 D Multijet (77 kW)	2010.02-			L		GCI17031	Inner Joint		25	26	32	59	110.5		
<b>DUCATO</b>															
2.0 D Multijet (85 kW)	2011.06-					GC017054	Outer Joint		35	29	71.5	127	71	M	
2.2 D Multijet (74 kW)	2006.07-			L		GCI17042	Inner Joint		41	27	43	70	102		
	2006.07-			R		GCI10038	Inner Joint		41	27	34.85	403	102		
	2006.07-					GC017055	Outer Joint		35	27	71.5	127	66.5	I	
2.2 JTD (88 kW)	2006.07-			L		GCI17028	Inner Joint		41	29	43	69.5	109.5		
	2006.07-					GC017054	Outer Joint		35	29	71.5	127	71	M	
2.3 D Multijet (109 kW)	2011.06-					GC017054	Outer Joint		35	29	71.5	127	71	M	
2.3 D Multijet (88 kW)	2006.07-			L		GCI17028	Inner Joint		41	29	43	69.5	109.5		
	2006.07-			L		GCI17042	Inner Joint		41	27	43	70	102		
	2006.07-			R		GCI10038	Inner Joint		41	27	34.85	403	102		
	2006.07-					GC017055	Outer Joint		35	27	71.5	127	66.5	I	
	2006.07-					GC017054	Outer Joint		35	29	71.5	127	71	M	
2.3 D Multijet (93 kW)	2006.07-			L		GCI17028	Inner Joint		41	29	43	69.5	109.5		
	2006.07-					GC017054	Outer Joint		35	29	71.5	127	71	M	
2.3 D Multijet (96 kW)	2007.01-			L		GCI17028	Inner Joint		41	29	43	69.5	109.5		
	2011.06-					GC017054	Outer Joint		35	29	71.5	127	71	M	
3.0 BI-Power 145 (107 kW)	2006.07-			R		GCI17021	Inner Joint		31	29	34.85	530	109		
3.0 BI-Power 155 (107 kW)	2006.07-			R		GCI17021	Inner Joint		31	29	34.85	530	109		
3.0 D Multijet (107 kW)	2010.04-			R		GCI17021	Inner Joint		31	29	34.85	530	109		
	2010.04-					GC017060	Outer Joint		35	29	71.5	127	71	I	
	2010.04-					GC017061	Outer Joint	54T	35	29	71.5	127	71	I	
3.0 D Multijet (116 kW)	2006.07-			R		GCI17021	Inner Joint		31	29	34.85	530	109		
	2006.07-					GC017060	Outer Joint		35	29	71.5	127	71	I	
	2006.07-					GC017061	Outer Joint	54T	35	29	71.5	127	71	I	
3.0 D Multijet (130 kW)	2011.06-			R		GCI17021	Inner Joint		31	29	34.85	530	109		
3.0 Natural Power (100 kW)	2009.04-			R		GCI17021	Inner Joint		31	29	34.85	530	109		
	2009.07-					GC017060	Outer Joint		35	29	71.5	127	71	I	
	2009.07-					GC017061	Outer Joint	54T	35	29	71.5	127	71	I	
<b>FIORINO IV (225)</b>															
1.3 D Multijet (55 kW)	2008.02-	2009.07		L		GCI99008	Inner Joint		24	24	29.7	86.5	93		
	2008.02-	2009.07		R	w/o Seiespeed	GCI17015	Inner Joint		24	24	29.7	379	100.5		
	2008.02-	2009.07		R		GCI17059	Inner Joint		24	24	29.8	394	100		
	2008.02-	2009.07				GC017028	Outer Joint		25	24	51	84.5	62	M	
	2009.07-			L		GCI44014	Inner Joint		25	23	34.9	57.5	102		
	2009.07-			R		GCI17056	Inner Joint		25	23	34.9	400	97		
1.3 D Multijet (70 kW)	2008.02-	2009.07		L		GCI99008	Inner Joint		24	24	29.7	86.5	93		
	2008.02-	2009.07		R	w/o Seiespeed	GCI17015	Inner Joint		24	24	29.7	379	100.5		
	2008.02-	2009.07		R		GCI17059	Inner Joint		24	24	29.8	394	100		
	2008.02-	2009.07				GC017028	Outer Joint		25	24	51	84.5	62	M	
1.4 (51 kW)	2008.02-			L		GC017070	Outer Joint		22	22	51	79	57.5	M	
	2008.02-					GCI17027	Inner Joint		22	22	36	61.5	93.5		
1.6 16V (76 kW)	2010.01-					GCI17027	Inner Joint		22	22	36	61.5	93.5		
1.6 Natural Power (76 kW)	2009.02-					GCI17027	Inner Joint		22	22	36	61.5	93.5		
1.9 D (46 kW)	2003.01-					GCI17027	Inner Joint		22	22	36	61.5	93.5		
<b>FIORINO QUBO (225)</b>															
1.3 D Multijet (55 kW)	2008.09-					GC017028	Outer Joint		25	24	51	84.5	62	M	
1.3 D Multijet (70 kW)	2008.09-					GC017028	Outer Joint		25	24	51	84.5	62	M	
1.4 (51 kW)	2008.02-			L		GC017070	Outer Joint		22	22	51	79	57.5	M	









	 YEAR	TRANSM	L/R	F/R		G-AP Ref.	PRODUCT	ABS	Technical Specifications									
									A	B	C	H	L	P				
<b>FIAT LCV</b>																		
<b>PANDA II (169) VAN</b>																		
1.3 JTD (51 kW)	2004.09-					GCO17026	Outer Joint		25	22	51	84	57	M				
1.3 JTD (55 kW)	2004.09-					GCO17026	Outer Joint		25	22	51	84	57	M				
1.4 Natural Power (57 kW)	2006.01-					GCO17026	Outer Joint		25	22	51	84	57	M				
<b>PUNTO VAN II</b>																		
1.2	2001.01-		MT	L	F	GCI17001	Inner Joint		22	19	36	61.5	88.5					
	2001.01-		MT	L	F	GDS17023	Drive Shaft		22	22	46.8	75.5	606					
1.9 D	2001.01-		MT	L	F	GCI17001	Inner Joint		22	19	36	61.5	88.5					
	2001.01-		MT	L	F	GDS17023	Drive Shaft		22	22	46.8	75.5	606					
<b>PUNTO VAN II (188AX)</b>																		
1.3 JTD (51 kW)	2003.06-	2005.10				R	GCI17012	Inner Joint	24	23	29.7	379	100.5					
	2003.06-	2015.10				L	GCI17011	Inner Joint	24	23	29.7	86.5	93					
<b>QUBO (225)</b>																		
1.3 D Multijet (55 kW)	2008.09-			L			GCI199008	Inner Joint	24	24	29.7	86.5	93					
	2008.09-			R	w/o Selespeed		GCI17015	Inner Joint	24	24	29.7	379	100.5					
	2009.09-			R			GCI17059	Inner Joint	24	24	29.8	394	100					
	2010.07-			L			GCI44014	Inner Joint	25	23	34.9	57.5	102					
	2010.07-			R			GCI17056	Inner Joint	25	23	34.9	400	97					
1.3 D Multijet (70 kW)	2008.09-			R	w/o Selespeed		GCI17015	Inner Joint	24	24	29.7	379	100.5					
	2009.09-			L			GCI199008	Inner Joint	24	24	29.7	86.5	93					
	2009.09-			R			GCI17059	Inner Joint	24	24	29.8	394	100					
1.4 (51 kW)	2008.09-						GCI17027	Inner Joint	22	22	36	61.5	93.5					
<b>FORD</b>																		
<b>323</b>																		
-	1990-	1994		L			GDS18087	Drive Shaft	26	24	56	93	626.5					
	1990-	1994					GCI18039	Inner Joint	24	28	35	64.1	91.5					
<b>AEROSTAR</b>																		
-	1990-	1997				4WD	GCO18050	Outer Joint	26	30	58	119	71	I				
<b>B-MAX</b>																		
1.4 (66 kW)	2012.10-		MT	L	F	MPV Engine SPJD	GDS18322	Drive Shaft	27	23	62.8	95.5	657					
	2012.10-		MT	R	F	MPV Engine SPJD	GDS18323	Drive Shaft	27	23	62.8	95.5	961					
1.5 TDCi (55 kW)	2012.10-		MT	L	F	MPV Engine UGJC	GDS18405	Drive Shaft	25	23	53.2	88.5	622					
1.6 TDCi (70 kW)	2012.10-		MT	L	F	MPV Engine T3JB	GDS18405	Drive Shaft	25	23	53.2	88.5	622					
1.6 TI (77 kW)	2012.10-		AT	R	F	MPV Engine IQJA	GDS18406	Drive Shaft	25	34	53.3	87	974					
	2012.10-					MPV Engine IQJA	GCO18222	Outer Joint	25	23	53.3	87	56	M				
<b>BELINA I</b>																		
1.4	1975.01-	1977.08	MT				GCO18020	Outer Joint	24	30	46	109	62.5	O				
<b>BELINA II</b>																		
1.4	1977.09-	1982.09	MT				GCO18020	Outer Joint	24	30	46	109	62.5	O				
1.6	1981.05-	1986.12	MT				GCO18020	Outer Joint	24	30	46	109	62.5	O				
	1983.06-	1986.12	MT				GCO18020	Outer Joint	24	30	46	109	62.5	O				
1.8	1981.01-	1988.08	MT				GCO18020	Outer Joint	24	30	46	109	62.5	O				
	1982.10-	1988.05	AT				GCO18020	Outer Joint	24	30	46	109	62.5	O				
	1989.08-	1991.04	MT				GCO18103	Outer Joint	24	30	46	109	62	I				
<b>C-MAX</b>																		
1.6 (74 kW)	2007.03-	2008.03	MT	L	F	MPV Engine HWDA/HWDB/SHDA/SHDB/SHDC	GDS18189	Drive Shaft	36	23	56	48	601					
	2007.03-	2008.03	MT	L	F	MPV Engine HWDA/HWDB/SHDA/SHDB/SHDC	GCI18168	Inner Joint	23	22	40	61	90					
	2007.03-	2008.03	MT	L	F	MPV Engine HWDA/HWDB/SHDA/SHDB/SHDC	GCO18264	Outer Joint	36	25	51.6	48	58	O				
	2007.03-	2008.03	MT	R	F	MPV Engine HWDA/HWDB/SHDA/SHDB/SHDC	GDS18206	Drive Shaft	36	23	56	48	906					
	2007.03-	2008.03		R	F	MPV Engine HWDA/HWDB/SHDA/SHDB/SHDC	GDS18337	Drive Shaft	36	23	51.6	48	908					
1.6 TDCi (66 kW)	2007.03-	2008.03			F	MPV Engine GPDA/HHDA/HHDB	GC099288	Outer Joint	36	26	56.3	48	61	M				
	2007.03-	2008.03		L	F	MPV Engine GPDA/HHDA/HHDB	GDS18218	Drive Shaft	36	26	56	48	582					
	2007.03-	2008.03		R	F	MPV Engine GPDA/HHDA/HHDB	GCO18230	Outer Joint	36	26	56.3	48	61	M				
	2007.03-	2008.03		R	F	MPV Engine GPDA/HHDA/HHDB	GDS18219	Drive Shaft	36	26	56.3	48	921					
1.6 TDCi (74 kW)	2007.02-			L	F	MPV Engine G8DC/MTDA	GDS18218	Drive Shaft	36	26	56	48	582					
	2007.02-			R	F	MPV Engine G8DC/MTDA	GDS18219	Drive Shaft	36	26	56.3	48	921					
1.6 TDCi (80 kW)	2007.03-	2008.03			F	MPV Engine G8DA/G8DB/G8DD	GC099288	Outer Joint	36	26	56.3	48	61	M				
	2007.03-	2008.03		L	F	MPV Engine G8DA/G8DB/G8DD	GDS18218	Drive Shaft	36	26	56	48	582					
	2007.03-	2008.03		R	F	MPV Engine G8DA/G8DB/G8DD	GDS18219	Drive Shaft	36	26	56.3	48	921					
1.8 (90 kW)	2007.02-			L	F	MPV Engine QQDC	GDS18359	Drive Shaft	36	23	56	48	594					
	2007.02-			R	F	MPV Engine QQDC	GDS18358	Drive Shaft	36	23	56	48	899					
	2007.02-		MT	L	F	MPV Engine QQDC	GDS18189	Drive Shaft	36	23	56	48	601					



		TRANSM	L/R	F/R		G-AP Ref.	PRODUCT	ABS	Technical Specifications									
									YEAR	A	B	C	H	L	P			
<b>FORD C-MAX</b>																		
1.8 (90 kW)	2007.02-		MT	R	F	MPV Engine QQDC	GDS18206	Drive Shaft		36	23	56	48	906				
1.8 (92 kW)	2007.03-2008.03		5MT	L	F	MPV Engine QQDA/QQDB	GDS18359	Drive Shaft		36	23	56	48	594				
	2007.03-2008.03		MT	L	F	MPV Engine QQDA/QQDB	GDS18189	Drive Shaft		36	23	56	48	601				
	2007.03-2008.03		5MT	R	F	MPV Engine QQDA/QQDB	GDS18358	Drive Shaft		36	23	56	48	899				
	2007.03-2008.03		MT	R	F	MPV Engine QQDA/QQDB	GDS18206	Drive Shaft		36	23	56	48	906				
1.8 FlexFuel (92 kW)	2007.02-		5MT	L	F	MPV Engine Q7DA	GDS18359	Drive Shaft		36	23	56	48	594				
	2007.02-		5MT	R	F	MPV Engine Q7DA	GDS18358	Drive Shaft		36	23	56	48	899				
	2007.02-		MT	L	F	MPV Engine Q7DA	GDS18189	Drive Shaft		36	23	56	48	601				
	2007.02-		MT	R	F	MPV Engine Q7DA	GDS18206	Drive Shaft		36	23	56	48	906				
1.8 TDCi (85 kW)	2007.02-				F	MPV Engine KKDA	GC099288	Outer Joint		36	26	56.3	48	61	M			
	2007.02-				R	F	MPV Engine KKDA	GC018230	Outer Joint		36	26	56.3	48	61	M		
	2007.02-				L	F	MPV Engine KKDA	GDS18218	Drive Shaft		36	26	56	48	582			
	2007.02-				R	F	MPV Engine KKDA	GDS18219	Drive Shaft		36	26	56.3	48	921			
2.0 (107 kW)	2007.03-2008.03		5AT	L	F	MPV Engine AODA/AODB/AODE/SYDA	GDS18327	Drive Shaft		36	26	55.3	48	585				
	2007.03-2008.03		5MT	L	F	MPV Engine AODA/AODB/AODE/SYDA	GDS18328	Drive Shaft		36	26	55.3	48	580				
	2007.03-2008.03		5AT	R	F	MPV Engine AODA/AODB/AODE/SYDA	GDS34163	Drive Shaft		36	26	56	48	926				
	2007.03-2008.03		5MT	R	F	MPV Engine AODA/AODB/AODE/SYDA	GDS18329	Drive Shaft		36	26	55.3	48	920				
	2007.03-2008.03		AT	R	F	MPV Engine AODA/AODB/AODE/SYDA	GDS18190	Drive Shaft		36	26	56.3	48	919				
2.0 CNG (107 kW)	2009.04-		5AT	L	F	MPV Engine SYDA	GDS18327	Drive Shaft		36	26	55.3	48	585				
	2009.04-		5MT	L	F	MPV Engine SYDA	GDS18328	Drive Shaft		36	26	55.3	48	580				
	2009.04-		5AT	R	F	MPV Engine SYDA	GDS34163	Drive Shaft		36	26	56	48	926				
	2009.04-		5MT	R	F	MPV Engine SYDA	GDS18329	Drive Shaft		36	26	55.3	48	920				
	2009.04-		AT	R	F	MPV Engine SYDA	GDS18190	Drive Shaft		36	26	56.3	48	919				
2.0 LPG (107 kW)	2008.06-		AT	R	F	MPV Engine SYDA	GDS18190	Drive Shaft		36	26	56.3	48	919				
2.0 TDCi (100 kW)	2007.03-2008.03		MT	L	F	MPV Engine G6DA/G6DB/G6DD/G6DG	GDS18194	Drive Shaft		36	26	56	48	568				
2.0 TDCi (81 kW)	2008.02-		MT	L	F	MPV Engine IXDA	GDS18194	Drive Shaft		36	26	56	48	568				
2.0 TDCi (98 kW)	2007.02-		MT	L	F	MPV Engine G6DF/G6DE/G6DC	GDS18194	Drive Shaft		36	26	56	48	568				
<b>C-MAX II</b>																		
1.6 EcoBoost (110 kW)	2010.12-		MT	L	F	MPV Engine IQDA/IQDB	GDS18295	Drive Shaft		27	26	63	96	637				
	2010.12-		MT	R	F	MPV Engine IQDA/IQDB	GDS18294	Drive Shaft		27	26	63	96	972				
1.6 EcoBoost (134 kW)	2010.12-		MT	L	F	MPV Engine JTDA/JTDB	GDS18295	Drive Shaft		27	26	63	96	637				
	2010.12-		MT	R	F	MPV Engine JTDA/JTDB	GDS18294	Drive Shaft		27	26	63	96	972				
1.6 FlexFuel (88 kW)	2011.02-		MT	L	F	MPV Engine MUDA	GDS18322	Drive Shaft		27	23	62.8	95.5	657				
	2011.02-		MT	R	F	MPV Engine MUDA	GDS18323	Drive Shaft		27	23	62.8	95.5	961				
	2011.02-					MPV Engine MUDA	GC018244	Outer Joint		27	24	62.8	95.5	59	M			
1.6 LPG (86 kW)	2012.02-		MT	L	F	MPV Engine MUDA	GDS18322	Drive Shaft		27	23	62.8	95.5	657				
	2012.02-		MT	R	F	MPV Engine MUDA	GDS18323	Drive Shaft		27	23	62.8	95.5	961				
	2012.02-				F	MPV Engine MUDA	GC018244	Outer Joint		27	24	62.8	95.5	59	M			
1.6 LPG (88 kW)	2012.02-		MT	L	F	MPV Engine MUDA	GDS18322	Drive Shaft		27	23	62.8	95.5	657				
	2012.02-		MT	R	F	MPV Engine MUDA	GDS18323	Drive Shaft		27	23	62.8	95.5	961				
	2012.02-				F	MPV Engine MUDA	GC018244	Outer Joint		27	24	62.8	95.5	59	M			
1.6 TDCi (66 kW)	2007.02-			L		GC099288	Outer Joint		36	26	56.3	48	61	M				
1.6 TDCi (70 kW)	2010.12-				MPV Engine T3DAT3DB	GC018240	Outer Joint		27	26	63	96	62.5	M				
1.6 TDCi (74 kW)	2007.02-			L		GC099288	Outer Joint		36	26	56.3	48	61	M				
1.6 TDCi (80 kW)	2007.02-			L		GC099288	Outer Joint		36	26	56.3	48	61	M				
1.6 TDCi (85 kW)	2010.12-				MPV Engine T1DA/T1DB	GC018240	Outer Joint		27	26	63	96	62.5	M				
1.6 TI (63 kW)	2010.12-		MT	L	F	MPV Engine XTDA	GDS18322	Drive Shaft		27	23	62.8	95.5	657				
	2010.12-		MT	R	F	MPV Engine XTDA	GDS18323	Drive Shaft		27	23	62.8	95.5	961				
	2010.12-				F	MPV Engine XTDA	GC018244	Outer Joint		27	24	62.8	95.5	59	M			
1.6 TI (77 kW)	2010.12-		MT	L	F	MPV Engine IQDA/IQDB	GDS18322	Drive Shaft		27	23	62.8	95.5	657				
	2010.12-		MT	R	F	MPV Engine IQDA/IQDB	GDS18323	Drive Shaft		27	23	62.8	95.5	961				
	2010.12-					MPV Engine IQDA/IQDB	GC018244	Outer Joint		27	24	62.8	95.5	59	M			
1.6 TI (92 kW)	2010.12-		MT	L	F	MPV Engine PNDA	GDS18322	Drive Shaft		27	23	62.8	95.5	657				
	2010.12-		MT	R	F	MPV Engine PNDA	GDS18323	Drive Shaft		27	23	62.8	95.5	961				
	2010.12-					MPV Engine PNDA	GC018244	Outer Joint		27	24	62.8	95.5	59	M			
1.8 TDCi (85 kW)	2007.02-					GC099288	Outer Joint		36	26	56.3	48	61	M				
2.0 TDCi (100 kW)	2011.02-				MPV Engine UKDB	GC018270	Outer Joint		27	26	62.8	91	64	M				
2.0 TDCi (103 kW)	2011.02-				MPV Engine UFDB	GC018270	Outer Joint		27	26	62.8	91	64	M				
2.0 TDCi (120 kW)	2010.12-		AT	R	F	MPV Engine TXDB	GDS18343	Drive Shaft		27	28	63.1	96	967				
	2010.12-		MT/AT			MPV Engine TXDB	GC018270	Outer Joint		27	26	62.8	91	64	M			
2.0 TDCi (85 kW)	2011.02-		AT	R	F	MPV Engine TYDA	GDS18343	Drive Shaft		27	28	63.1	96	967				
	2011.02-					MPV Engine TYDA	GC018270	Outer Joint		27	26	62.8	91	64	M			

	 YEAR	TRANSM	L/R	F/R		G-AP Ref.	PRODUCT	ABS	Technical Specifications										
									A	B	C	H	L	P					
<b>FORD</b>																			
<b>CAPRI</b>																			
-	1989.01-	1994.12	MT/AT	L	F		GDS34076	Drive Shaft			24	26	52	86	595				
-	1989.01-	1994.12	MT/AT	R	F		GDS34077	Drive Shaft			24	26	52	86	541				
<b>CONSUL (GGCL)</b>																			
1.7 (55 kW)	1972.01-	1975.12			R	Coupe Engine TV17HC	GCI18001	Inner Joint				25		32					
2.0 (73 kW)	1972.01-	1975.12			R	Coupe	GCI18001	Inner Joint				25		32					
2.3 (79 kW)	1972.01-	1975.12			R	Coupe	GCI18001	Inner Joint				25		32					
<b>CONSUL (GGFL)</b>																			
1.7 (55 kW)	1972.01-	1975.12			R	Saloon Engine TV17HC	GCI18001	Inner Joint				25		32					
2.0 (66 kW)	1974.09-	1975.12			R	Saloon	GCI18001	Inner Joint				25		32					
2.0 (73 kW)	1972.01-	1975.12			R	Saloon	GCI18001	Inner Joint				25		32					
2.3 (79 kW)	1972.01-	1975.12			R	Saloon	GCI18001	Inner Joint				25		32					
<b>CONSUL TURNIER (GGNL)</b>																			
1.7 (55 kW)	1972.01-	1975.12			R	Estate Engine TV17HC	GCI18001	Inner Joint				25		32					
2.0 (73 kW)	1972.01-	1975.12			R	Estate	GCI18001	Inner Joint				25		32					
2.3 (79 kW)	1972.01-	1975.12			R	Estate	GCI18001	Inner Joint				25		32					
<b>CONTOUR</b>																			
2.5	1995-	2000					GC018056	Outer Joint			27	32	54.3	91	62				
	1995-	2000					GC018081	Outer Joint	44W		27	32	54.3	91	62				
<b>CORCEL I</b>																			
1.4	1971.01-	1977.08	MT				GC018020	Outer Joint			24	30	46	109	62.5				O
<b>CORCEL II</b>																			
1.4	1977.09-	1982.09	MT				GC018020	Outer Joint			24	30	46	109	62.5				O
1.6	1981.05-	1986.12	MT				GC018020	Outer Joint			24	30	46	109	62.5				O
<b>COUGAR (EC)</b>																			
2.5 ST (151 kW)	2000.06-	2001.12					GC018225	Outer Joint	44W		27	32	57.2	91.5	62				I
2.5 V6 24V (125 kW)	2000.06-	2001.12					GC018225	Outer Joint	44W		27	32	57.2	91.5	62				I
<b>COUGAR (EC_)</b>																			
2.0 16V (96 kW)	1998.08-	2001.12	MT	R	F	Coupe Engine EDDBA/EDBB/EDBC/EDBD	GDS18012	Drive Shaft	44T		27	35	54.3	91	568				
2.5 ST (151 kW)	2000.01-	2001.12	MT	R	F	Coupe Engine SGA	GDS18012	Drive Shaft	44T		27	35	54.3	91	568				
2.5 V6 24V (125 kW)	1998.08-	2001.12	MT	R	F	Coupe Engine LCBA	GDS18012	Drive Shaft	44T		27	35	54.3	91	568				
	2000.06-	2001.12	MT	R	F	Coupe Engine LCBB/LCBC/LCBE	GDS18012	Drive Shaft	44T		27	35	54.3	91	568				
<b>COURIER</b>																			
-	1987.01-	1996.12			R		GDS34019	Drive Shaft			26	26	65	143.5	606				
1.3	1997.01-	1999.12	MT				GC099015	Outer Joint			25	20	56.5	88	49				O
<b>COURIER (F3L, F5L)</b>																			
1.3 (44 kW)	1991.09-	1996.02	MT		F	Box Engine J6B	GC018015	Outer Joint			23	22	48	80	52.5				O
1.8 D (44 kW)	1991.09-	1996.02	MT	L	F	Box Engine RTC/RTD/RTG	GDS18118	Drive Shaft			23	23	48	80	583.5				
	1991.09-	1996.02	MT	R	F	Box Engine RTC/RTD/RTG	GDS18289	Drive Shaft			23	23	48	80	857				
	1991.09-	1996.02	MT		F	Box Engine RTC/RTD/RTG	GC018015	Outer Joint			23	22	48	80	52.5				O
<b>COURIER (J5_, J3_)</b>																			
1.3 (44 kW)	1996.02-		MT		F	Box Engine J4C	GC018012	Outer Joint			25	20	56.5	88.5	49				O
1.8 Di (55 kW)	2000.09-				L	F	Box Engine RTN/RTP	GDS99047	Drive Shaft		25	23	56.5	88.5	601.5				
<b>COURIER (JV_)</b>																			
1.8 TD (55 kW)	2000.03-		MT	R	F	Box Engine RTN/RTP/RTQ	GCI18087	Inner Joint			23	22	40	371	78.5				
	2000.03-		MT	R	F	Box Engine RTN/RTP/RTQ	GC018004	Outer Joint			25	22	56.5	88.5	53.5				O
	2000.03-		MT	R	F	Box Engine RTN/RTP/RTQ	GDS18175	Drive Shaft			25	23	56.5	88.5	898				
<b>DEL REY</b>																			
1.6	1981.01-	1988.08	MT				GC018020	Outer Joint			24	30	46	109	62.5				O
	1982.10-	1988.05	AT				GC018020	Outer Joint			24	30	46	109	62.5				O
	1989.08-	1991.04	MT				GC018103	Outer Joint			24	30	46	109	62				I
1.8	1981.01-	1988.08	MT				GC018020	Outer Joint			24	30	46	109	62.5				O
	1982.10-	1988.05	AT				GC018020	Outer Joint			24	30	46	109	62.5				O
	1989.08-	1991.04	MT				GC018103	Outer Joint			24	30	46	109	62				I
<b>ESCAPE</b>																			
-	2001-	2004				Truck/VAN	GC034039	Outer Joint			28	24	56	94	62				M
	2001-	2004				Truck/VAN	GC034064	Outer Joint	44T		28	24	56	94	62				M
2.3	2004-						GC034107	Outer Joint			28	33	56.5	94	59				I
<b>ESCORT</b>																			
-	1991-	2001					GC018048	Outer Joint			26	28	56	93	61				I
	1991-	2001					GC018079	Outer Joint	44T		26	28	56	93	61				I
	1997-	2003	MT				GCI34008	Inner Joint			26	22	35	66.7	92				
1.6	1992.01-	1996.12	MT				GC099154	Outer Joint			25	30	56.5	89	52				I









	 YEAR	TRANSM	L/R	F/R		G-AP Ref.	PRODUCT	ABS	Technical Specifications								
									A	B	C	H	L	P			
<b>FORD ESCORT</b>																	
1.8	1989.05-1992.11	MT				GC018044	Outer Joint		23	30	55	91.5	54.5	I			
	1992.12-1996.12	MT				GC018100	Outer Joint		25	30	56.5	89	56.5	I			
2.0	1992.12-1996.12	MT				GC018100	Outer Joint		25	30	56.5	89	56.5	I			
<b>ESCORT '81 EXPRESS (AVA)</b>																	
1.1 (37 kW)	1981.03-1986.02	MT		F	Box Engine GLB	GCI18002	Inner Joint		23	20	40	61.5	62.5				
1.3 (51 kW)	1981.03-1986.02	MT		F	Box Engine JPA	GC018019	Outer Joint		23	22	55	91.5	54.5	O			
	1981.03-1986.02	MT		F	Box Engine JPA	GCI99075	Inner Joint		23	22	40	61	93	O			
1.6 (61 kW)	1981.03-1986.02	MT		F	Box	GC018019	Outer Joint		23	22	55	91.5	54.5	O			
	1981.03-1986.02	MT		F	Box	GCI99075	Inner Joint		23	22	40	61	93	O			
1.6 D (40 kW)	1984.02-1986.02	MT		F	Box Engine LTA	GC018019	Outer Joint		23	22	55	91.5	54.5	O			
<b>ESCORT '86 EXPRESS (AVF)</b>																	
1.1 (37 kW)	1986.05-1990.07	MT		F	Box Engine GSG	GC018019	Outer Joint		23	22	55	91.5	54.5	O			
	1986.05-1990.07	MT		F	Box Engine GSG	GCI18002	Inner Joint		23	20	40	61.5	62.5				
1.3 (46 kW)	1988.07-1990.07	MT		F	Box Engine JBA	GC018019	Outer Joint		23	22	55	91.5	54.5	O			
1.8 D (44 kW)	1988.07-1990.07	MT		F	Box Engine RTA/RTB	GC018019	Outer Joint		23	22	55	91.5	54.5	O			
<b>ESCORT '91 EXPRESS (AVL)</b>																	
1.3 (46 kW)	1990.07-1994.12	MT		F	Box Engine JBD	GC018017	Outer Joint		23	20	48	80.5	49	O			
1.8 D (44 kW)	1990.07-1994.12	MT	R	F	Box Engine RTH	GDS18039	Drive Shaft		25	23	56.5	88.5	903				
	1990.07-1994.12	MT	L	F	Box Engine RTH	GDS18040	Drive Shaft		25	23	56.5	88.5	608				
<b>ESCORT CLASSIC (AAL, ABL)</b>																	
1.8 TD (66 kW)	1998.10-2000.07		R	F	Hatchback Engine RFD/RFK	GDS18015	Drive Shaft		25	26	56.5	89	906				
	1998.10-2000.07		L	F	Hatchback Engine RFD/RFK	GDS18019	Drive Shaft		25	26	56.5	89	591.5				
	1998.10-2000.07			F	Hatchback Engine RFD/RFK	GC018016	Outer Joint		25	30	56.5	89	56.5	I			
<b>ESCORT CLASSIC TURNIER (ANL)</b>																	
1.8 TD (66 kW)	1999.02-2000.07			F	Estate Engine RFD/RFK	GC018016	Outer Joint		25	30	56.5	89	56.5	I			
<b>ESCORT EXPRESS</b>																	
-	1983-1990			R		GDS18081	Drive Shaft		26	23	51	88.5	892				
	1983.06-1990	MT	L			GDS18153	Drive Shaft		26	23	51	88.5	560				
	1983.06-1990	AT	L			GDS18148	Drive Shaft		26	23	51	88.5	562				
	1991-1996	AT	L			GDS18087	Drive Shaft		26	24	56	93	626.5				
	1991-1996	AT				GCI18039	Inner Joint		24	28	35	64.1	91.5				
1.8	1991-1996	AT				GCI18068	Inner Joint		24	28	35	63.9	89.5				
1.9	1986.01-1990.12					GC018042	Outer Joint		26	23	51	88.5	60	I			
	1991-1996					GCI18068	Inner Joint		24	28	35	63.9	89.5				
2.0	1997-2001	AT				GCI18068	Inner Joint		24	28	35	63.9	89.5				
2.0 D	1986.01-1987.12	MT				GC018042	Outer Joint		26	23	51	88.5	60	I			
All Models	1983.04-1983.12	MT				GC018042	Outer Joint		26	23	51	88.5	60	I			
	1984.01-1985.12					GC018042	Outer Joint		26	23	51	88.5	60	I			
	1985.01-1985.12					GC018042	Outer Joint		26	23	51	88.5	60	I			
<b>ESCORT HOBBY</b>																	
1.0	1993.08-1996.05	MT				GC018044	Outer Joint		23	30	55	91.5	54.5	I			
1.6	1993.08-1996.05	MT				GC018044	Outer Joint		23	30	55	91.5	54.5	I			
<b>ESCORT III (ALD)</b>																	
1.3 (51 kW)	1983.09-1985.12	MT		F	Convertible Engine JPA	GC018019	Outer Joint		23	22	55	91.5	54.5	O			
	1983.09-1985.12	MT		F	Convertible Engine JPA	GCI99075	Inner Joint		23	22	40	61	93	O			
1.6 (58 kW)	1983.09-1985.12	MT		F	Convertible Engine LP1/LPA	GC018019	Outer Joint		23	22	55	91.5	54.5	O			
1.6 i (77 kW)	1983.09-1985.12	MT		F	Convertible Engine LR1/LRA	GC018019	Outer Joint		23	22	55	91.5	54.5	O			
<b>ESCORT III (AWA)</b>																	
1.1 (37 kW)	1983.08-1985.12	MT		F	Estate Engine GSE	GC018019	Outer Joint		23	22	55	91.5	54.5	O			
1.1 (40 kW)	1980.09-1983.08	MT		F	Estate Engine GLB/GMA	GC018019	Outer Joint		23	22	55	91.5	54.5	O			
1.3 (51 kW)	1981.03-1985.12	MT		F	Estate Engine JPA	GC018019	Outer Joint		23	22	55	91.5	54.5	O			
1.6 (58 kW)	1980.09-1985.12	MT		F	Estate Engine LP1/LPA	GC018019	Outer Joint		23	22	55	91.5	54.5	O			
	1980.09-1985.12	MT		F	Estate Engine LP1/LPA	GCI99075	Inner Joint		23	22	40	61	93	O			
1.6 D (40 kW)	1984.02-1985.12	MT		F	Estate Engine LTA	GC018019	Outer Joint		23	22	55	91.5	54.5	O			
<b>ESCORT III (GAA)</b>																	
1.1 (37 kW)	1983.08-1985.12			F	Hatchback Engine GSE	GC018018	Outer Joint		23	20	50	91.5	52	O			
	1983.08-1985.12	MT		F	Hatchback Engine GSE	GCI18002	Inner Joint		23	20	40	61.5	62.5				
1.1 (40 kW)	1980.09-1983.08	MT		F	Hatchback Engine GLB/GMA	GCI18002	Inner Joint		23	20	40	61.5	62.5				
1.1 (43 kW)	1980.09-1983.08			F	Hatchback Engine GPA	GC018018	Outer Joint		23	20	50	91.5	52	O			
	1980.09-1983.08	MT		F	Hatchback Engine GPA	GCI18002	Inner Joint		23	20	40	61.5	62.5				
1.3 (51 kW)	1980.09-1985.12	MT		F	Hatchback Engine JPA	GC018019	Outer Joint		23	22	55	91.5	54.5	O			
	1980.09-1985.12	MT		F	Hatchback Engine JPA	GCI99075	Inner Joint		23	22	40	61	93	O			



		YEAR	TRANSM	L/R	F/R		G-AP Ref.	PRODUCT	ABS	Technical Specifications						
										A	B	C	H	L	P	
<b>FORD</b>																
<b>ESCORT III (GAA)</b>																
1.6 (58 kW)	1980.09-	1985.12	MT		F	Hatchback Engine LP1/LPA	GC018019	Outer Joint		23	22	55	91.5	54.5	O	
	1980.09-	1985.12	MT		F	Hatchback Engine LP1/LPA	GCI99075	Inner Joint		23	22	40	61	93	O	
1.6 (71 kW)	1980.09-	1982.10	MT		F	Hatchback Engine LUA	GC018019	Outer Joint		23	22	55	91.5	54.5	O	
	1980.09-	1982.10	MT		F	Hatchback Engine LUA	GCI99075	Inner Joint		23	22	40	61	93	O	
1.6 D (40 kW)	1984.02-	1985.12	MT		F	Hatchback Engine LTA	GC018019	Outer Joint		23	22	55	91.5	54.5	O	
1.6 i (66 kW)	1985.07-	1985.12	MT		F	Hatchback Engine L4B	GC018019	Outer Joint		23	22	55	91.5	54.5	O	
1.6 XR3i (77 kW)	1982.10-	1985.12	MT		F	Hatchback Engine LR1/LRA	GC018019	Outer Joint		23	22	55	91.5	54.5	O	
<b>ESCORT IV (ALF)</b>																
1.4 (54 kW)	1987.02-	1990.07	MT		F	Convertible Engine F6B/F6D/FUC	GC018019	Outer Joint		23	22	55	91.5	54.5	O	
	1987.02-	1990.07	MT		F	Convertible Engine F6B/F6D/FUC	GCI99075	Inner Joint		23	22	40	61	93	O	
1.4 (55 kW)	1986.01-	1990.07	MT		F	Convertible Engine FUA	GC018019	Outer Joint		23	22	55	91.5	54.5	O	
	1986.01-	1990.07	MT		F	Convertible Engine FUA	GCI99075	Inner Joint		23	22	40	61	93	O	
1.6 i (66 kW)	1986.01-	1990.07	MT/AT		F	Convertible Engine L4B	GC018019	Outer Joint		23	22	55	91.5	54.5	O	
1.6 i (75 kW)	1989.08-	1990.07	MT/AT		F	Convertible Engine LJB	GC018019	Outer Joint		23	22	55	91.5	54.5	O	
1.6 XR3i (77 kW)	1986.01-	1990.07	MT		F	Convertible Engine LR2/LRB	GC018019	Outer Joint		23	22	55	91.5	54.5	O	
<b>ESCORT IV (AWF, AVF)</b>																
1.1 (37 kW)	1985.10-	1990.09	MT		F	Estate Engine GSG	GCI18002	Inner Joint		23	20	40	61.5	62.5		
1.3 (44 kW)	1986.01-	1990.07	MT		F	Estate Engine JBB/JLA/JLB	GC018019	Outer Joint		23	22	55	91.5	54.5	O	
1.4 (54 kW)	1986.01-	1990.07	MT		F	Estate Engine F6B/F6D/FUC	GC018019	Outer Joint		23	22	55	91.5	54.5	O	
	1986.01-	1990.07	MT		F	Estate Engine F6B/F6D/FUC	GCI99075	Inner Joint		23	22	40	61	93	O	
1.4 (55 kW)	1986.01-	1990.07	MT		F	Estate Engine FUA	GC018019	Outer Joint		23	22	55	91.5	54.5	O	
	1986.01-	1990.07	MT		F	Estate Engine FUA	GCI99075	Inner Joint		23	22	40	61	93	O	
1.6 D (40 kW)	1986.01-	1989.01	MT		F	Estate Engine LTC	GC018019	Outer Joint		23	22	55	91.5	54.5	O	
1.6 i (66 kW)	1986.01-	1990.07	MT		F	Estate Engine L4B	GC018019	Outer Joint		23	22	55	91.5	54.5	O	
1.8 D (44 kW)	1989.01-	1990.07	MT		F	Estate Engine RTA/RTB	GC018019	Outer Joint		23	22	55	91.5	54.5	O	
<b>ESCORT IV (GAF, AWF, ABFT)</b>																
1.1 (37 kW)	1985.12-	1990.07	MT		F	Hatchback Engine GSG	GC018019	Outer Joint		23	22	55	91.5	54.5	O	
	1985.12-	1990.07			F	Hatchback Engine GSG	GC018018	Outer Joint		23	20	50	91.5	52	O	
	1985.12-	1990.07	MT		F	Hatchback Engine GSG	GCI18002	Inner Joint		23	20	40	61.5	62.5		
1.3 (44 kW)	1986.01-	1990.07	MT		F	Hatchback Engine JBB/JLA/JLB	GC018019	Outer Joint		23	22	55	91.5	54.5	O	
	1986.01-	1990.07			F	Hatchback Engine JBB/JLA/JLB	GC018018	Outer Joint		23	20	50	91.5	52	O	
	1986.01-	1990.07	MT		F	Hatchback Engine JBB/JLA/JLB	GCI18002	Inner Joint		23	20	40	61.5	62.5		
1.3 (46 kW)	1988.07-	1990.10	MT		F	Hatchback Engine JBA	GC018019	Outer Joint		23	22	55	91.5	54.5	O	
	1988.07-	1990.10			F	Hatchback Engine JBA	GC018018	Outer Joint		23	20	50	91.5	52	O	
	1988.07-	1990.10	MT		F	Hatchback Engine JBA	GCI18002	Inner Joint		23	20	40	61.5	62.5		
1.4 (54 kW)	1986.01-	1990.07	MT/AT		F	Hatchback Engine F6B/F6D/FUC	GC018019	Outer Joint		23	22	55	91.5	54.5	O	
	1986.01-	1990.07	MT		F	Hatchback Engine F6B/F6D/FUC	GCI99075	Inner Joint		23	22	40	61	93	O	
1.4 (55 kW)	1986.01-	1990.07	MT/AT		F	Hatchback Engine FUA	GC018019	Outer Joint		23	22	55	91.5	54.5	O	
	1986.01-	1990.07	MT		F	Hatchback Engine FUA	GCI99075	Inner Joint		23	22	40	61	93	O	
1.6 (65 kW)	1989.04-	1990.07	MT/AT		F	Hatchback Engine LUG	GC018019	Outer Joint		23	22	55	91.5	54.5	O	
1.6 D (40 kW)	1986.01-	1989.01	MT		F	Hatchback Engine LTC	GC018019	Outer Joint		23	22	55	91.5	54.5	O	
1.6 i (66 kW)	1986.01-	1990.05	MT/AT		F	Hatchback Engine L4B	GC018019	Outer Joint		23	22	55	91.5	54.5	O	
1.6 i (75 kW)	1989.08-	1990.07	MT		F	Hatchback Engine LJB	GC018019	Outer Joint		23	22	55	91.5	54.5	O	
1.6 XR3i (77 kW)	1986.01-	1989.08	MT		F	Hatchback Engine LR2/LRB	GC018019	Outer Joint		23	22	55	91.5	54.5	O	
1.8 D (44 kW)	1989.01-	1990.07	MT		F	Hatchback Engine RTA/RTB	GC018019	Outer Joint		23	22	55	91.5	54.5	O	
<b>ESCORT V (ALL)</b>																
1.4 (52 kW)	1990.07-	1992.12			F	Convertible Engine F6F/F6G	GC018015	Outer Joint		23	22	48	80	52.5	O	
1.8 16V XR3i (77 kW)	1992.02-	1992.12	MT		F	Convertible Engine RDA	GC018021	Outer Joint		25	25	56.5	89	56.5	O	
	1992.02-	1992.12	MT	L	F	Convertible Engine RDA	GDS18044	Drive Shaft		25	26	56.5	89	594		
1.8 16V XR3i (96 kW)	1992.02-	1992.12	MT		F	Convertible Engine RQB	GC018021	Outer Joint		25	25	56.5	89	56.5	O	
	1992.02-	1992.12	MT	L	F	Convertible Engine RQB	GDS18044	Drive Shaft		25	26	56.5	89	594		
<b>ESCORT V (GAL)</b>																
1.3 (44 kW)	1990.07-	1992.09	MT		F	Hatchback Engine J4B/J6A	GC018017	Outer Joint		23	20	48	80.5	49	O	
	1990.07-	1992.09	MT		F	Hatchback Engine J4B/J6A	GC018015	Outer Joint		23	22	48	80	52.5	O	
1.4 (52 kW)	1990.07-	1992.09			F	Hatchback Engine F6F/F6G	GC018015	Outer Joint		23	22	48	80	52.5	O	
1.8 16V XR3i (77 kW)	1992.02-	1992.12	MT		F	Hatchback Engine RDA	GC018021	Outer Joint		25	25	56.5	89	56.5	O	
	1992.02-	1992.12	MT	L	F	Hatchback Engine RDA	GDS18044	Drive Shaft		25	26	56.5	89	594		
1.8 16V XR3i (96 kW)	1992.02-	1992.12	MT		F	Hatchback Engine RQB	GC018021	Outer Joint		25	25	56.5	89	56.5	O	
	1992.02-	1992.12	MT	L	F	Hatchback Engine RQB	GDS18044	Drive Shaft		25	26	56.5	89	594		
1.8 D (44 kW)	1990.07-	1992.12	MT	R	F	Hatchback Engine RTE/RTF/RTH	GDS18039	Drive Shaft		25	23	56.5	88.5	903		
	1990.07-	1992.12	MT	L	F	Hatchback Engine RTE/RTF/RTH	GDS18040	Drive Shaft		25	23	56.5	88.5	608		

		YEAR	TRANSM	L/R	F/R		G-AP Ref.	PRODUCT	ABS	Technical Specifications						
										A	B	C	H	L	P	
<b>FORD</b>																
<b>ESCORT V (GAL)</b>																
2.0 RS (110 kW)	1991.05-	1992.12	MT		F	Hatchback Engine N7A	GC018021	Outer Joint			25	25	56.5	89	56.5	O
	1991.05-	1992.12	MT	L	F	Hatchback Engine N7A	GDS18044	Drive Shaft			25	26	56.5	89	594	
<b>ESCORT V (GAL, AVL)</b>																
1.8 16V (77 kW)	1992.02-	1992.12	MT		F	Estate Engine RDA	GC018021	Outer Joint			25	25	56.5	89	56.5	O
	1992.02-	1992.12	MT	L	F	Estate Engine RDA	GDS18044	Drive Shaft			25	26	56.5	89	594	
1.8 D (44 kW)	1990.07-	1992.12	MT	R	F	Estate Engine RTE/RTF/RTH	GDS18039	Drive Shaft			25	23	56.5	88.5	903	
	1990.07-	1992.12	MT	L	F	Estate Engine RTE/RTF/RTH	GDS18040	Drive Shaft			25	23	56.5	88.5	608	
<b>ESCORT VI (GAL)</b>																
1.3 (44 kW)	1992.09-	1995.01	MT		F	Estate Engine J4B/J6A	GC018017	Outer Joint			23	20	48	80.5	49	O
	1992.09-	1995.01	MT		F	Hatchback Engine J4B/J6A	GC018017	Outer Joint			23	20	48	80.5	49	O
	1993.08-	1995.01	MT		F	Saloon Engine J4B/J6A	GC018017	Outer Joint			23	20	48	80.5	49	O
1.8 D (44 kW)	1992.09-	1995.01	MT	R	F	Estate Engine RTH	GDS18039	Drive Shaft			25	23	56.5	88.5	903	
	1992.09-	1995.01	MT	R	F	Hatchback Engine RTE/RTF/RTH	GDS18039	Drive Shaft			25	23	56.5	88.5	903	
	1992.09-	1995.01	MT	L	F	Estate Engine RTH	GDS18040	Drive Shaft			25	23	56.5	88.5	608	
	1992.09-	1995.01	MT	L	F	Hatchback Engine RTE/RTF/RTH	GDS18040	Drive Shaft			25	23	56.5	88.5	608	
	1993.08-	1995.01	MT	R	F	Saloon Engine RTE/RTF/RTH	GDS18039	Drive Shaft			25	23	56.5	88.5	903	
	1993.08-	1995.01	MT	L	F	Saloon Engine RTE/RTF/RTH	GDS18040	Drive Shaft			25	23	56.5	88.5	608	
1.8 i 16V (96 kW)	1993.02-	1995.01	MT		F	Estate Engine RQB	GC018021	Outer Joint			25	25	56.5	89	56.5	O
	1993.02-	1995.01	MT	L	F	Estate Engine RQB	GDS18044	Drive Shaft			25	26	56.5	89	594	
1.8 TD (66 kW)	1993.02-	1995.01	MT		F	Estate Engine RFD/RFK	GC018021	Outer Joint			25	25	56.5	89	56.5	O
	1993.02-	1995.01	MT		F	Hatchback Engine RFD/RFK/RFS	GC018021	Outer Joint			25	25	56.5	89	56.5	O
	1993.02-	1995.01	MT	L	F	Estate Engine RFD/RFK	GDS18044	Drive Shaft			25	26	56.5	89	594	
	1993.02-	1995.01	MT	L	F	Hatchback Engine RFD/RFK/RFS	GDS18044	Drive Shaft			25	26	56.5	89	594	
	1993.08-	1995.01	MT		F	Saloon Engine RFD/RFK	GC018021	Outer Joint			25	25	56.5	89	56.5	O
	1993.08-	1995.01	MT	L	F	Saloon Engine RFD/RFK	GDS18044	Drive Shaft			25	26	56.5	89	594	
2.0 RS Cosworth 4x4 (162 kW)	1992.09-	1995.01			F	Hatchback Engine N5F	GC018077	Outer Joint	94T		23	22	55	91	64	O
<b>ESCORT VII (ALL)</b>																
1.6 16V XR3i (66 kW)	1995.02-	1999.09	MT		F	Convertible Engine L1E	GC018021	Outer Joint			25	25	56.5	89	56.5	O
1.8 16V XR3i (77 kW)	1995.02-	1998.08		R	F	Convertible Engine RDA	GDS18015	Drive Shaft			25	26	56.5	89	906	
1.8 16V XR3i (85 kW)	1995.10-	1998.08		R	F	Convertible Engine RKC	GDS18015	Drive Shaft			25	26	56.5	89	906	
1.8 16V XR3i (96 kW)	1995.02-	2000.08		R	F	Convertible Engine RQB	GDS18015	Drive Shaft			25	26	56.5	89	906	
1.8 TD (66 kW)	1995.09-	1998.08	MT		F	Convertible Engine RFD/RFK	GC018021	Outer Joint			25	25	56.5	89	56.5	O
	1995.09-	1998.08		R	F	Convertible Engine RFD/RFK	GDS18015	Drive Shaft			25	26	56.5	89	906	
	1995.09-	1998.08	MT	R	F	Convertible Engine RFD/RFK	GDS18103	Drive Shaft			25	25	56.5	89	816.5	
1.8 Turbo D (51 kW)	1996.10-	1999.08	MT		F	Convertible Engine RVA	GC018021	Outer Joint			25	25	56.5	89	56.5	O
	1996.10-	1999.08		R	F	Convertible Engine RVA	GDS18015	Drive Shaft			25	26	56.5	89	906	
<b>ESCORT VII (GAL, AAL, ABL)</b>																
1.3 (44 kW)	1995.01-	1998.10	MT		F	Hatchback Engine J4B/J6A	GC018017	Outer Joint			23	20	48	80.5	49	O
1.8 16V (85 kW)	1995.01-	1998.10		R	F	Hatchback Engine RKC	GDS18015	Drive Shaft			25	26	56.5	89	906	
1.8 TD (66 kW)	1995.01-	1998.10	MT		F	Hatchback Engine RFD/RFK	GC018021	Outer Joint			25	25	56.5	89	56.5	O
	1995.01-	1998.10		R	F	Hatchback Engine RFD/RFK	GDS18015	Drive Shaft			25	26	56.5	89	906	
1.8 Turbo D (51 kW)	1995.12-	1998.10	MT		F	Hatchback Engine RVA	GC018021	Outer Joint			25	25	56.5	89	56.5	O
2.0 RS (110 kW)	1995.02-	1998.02		R	F	Hatchback Engine N7A	GDS18015	Drive Shaft			25	26	56.5	89	906	
2.0 RS 4x4 (110 kW)	1995.02-	1998.10		R	F	Hatchback Engine N7A	GDS18015	Drive Shaft			25	26	56.5	89	906	
<b>ESCORT VII (GAL, AFL)</b>																
1.3 (44 kW)	1995.01-	1999.02	MT		F	Saloon Engine J4B/J6A	GC018017	Outer Joint			23	20	48	80.5	49	O
	1995.01-	1999.01	MT		F	Estate Engine J4B/J6A	GC018017	Outer Joint			23	20	48	80.5	49	O
1.8 16V (85 kW)	1995.01-	1999.02		R	F	Saloon Engine RKC	GDS18015	Drive Shaft			25	26	56.5	89	906	
	1995.01-	1999.02		R	F	Estate Engine RKC	GDS18015	Drive Shaft			25	26	56.5	89	906	
1.8 TD (66 kW)	1995.01-	1999.02	MT		F	Saloon Engine RFD/RFK	GC018021	Outer Joint			25	25	56.5	89	56.5	O
	1995.01-	1999.02	MT		F	Estate Engine RFD/RFK	GC018021	Outer Joint			25	25	56.5	89	56.5	O
	1995.01-	1999.02		R	F	Saloon Engine RFD/RFK	GDS18015	Drive Shaft			25	26	56.5	89	906	
	1995.01-	1999.02		R	F	Estate Engine RFD/RFK	GDS18015	Drive Shaft			25	26	56.5	89	906	
1.8 Turbo D (51 kW)	1995.12-	1999.02	MT		F	Saloon Engine RVA	GC018021	Outer Joint			25	25	56.5	89	56.5	O
	1995.12-	1999.02	MT		F	Estate Engine RVA	GC018021	Outer Joint			25	25	56.5	89	56.5	O
	1995.12-	1999.02		R	F	Saloon Engine RVA	GDS18015	Drive Shaft			25	26	56.5	89	906	
	1995.12-	1999.02		R	F	Estate Engine RVA	GDS18015	Drive Shaft			25	26	56.5	89	906	
<b>ESCORT VIII</b>																
1.8 TD	1998-	2000					GCII18041	Inner Joint			26	25	40	389	92	
<b>ESCORT ZX2</b>																
-	1998-	2001	AT				GCII18068	Inner Joint			24	28	35	63.9	89.5	









	 YEAR	TRANSM	L/R	F/R		G-AP Ref.	PRODUCT	ABS	Technical Specifications								
									A	B	C	H	L	P			
<b>FORD EXPEDITION / F150</b>																	
-	1997-2002				4WD	GC018057	Outer Joint		33	28	75.6	113.2	76	I			
<b>EXPLORER SPORT / SPORT TRAC</b>																	
-	2002-2005				Truck	GCI18037	Inner Joint		27	34	35.55	117.3	76				
-	2002-2005		L		Truck 4WD	GDS18093	Drive Shaft		27	27	59.7	112	597.4				
<b>FALCON</b>																	
-	1998.09-2002.08		L		6 Cyl	GDS18138	Drive Shaft	50T	28	28	60	110.5	771				
-	1998.09-2002.08		R		6 Cyl	GDS18137	Drive Shaft	50T	28	28	60	110.5	868				
<b>FESTIVA</b>																	
-						GCI18007	Inner Joint		22	20	35	59	82				
-						GCI18008	Inner Joint		22	19	35	59	82				
1.3	1996-					GC018074	Outer Joint		24	21	52	86.5	53	I			
1.3 (DAJ)	1986.01-		MT		Engine BJ DOHC	GC018033	Outer Joint		24	20	52	86	50.5	M			
1.5	1997-2001		MT	L/R	WF	GCI27008	Inner Joint		26	22	35	66.5	95				
-	1997-2001		MT	L	WF	GDS27024	Drive Shaft		24	26	52	86	605				
-	1997-2001		MT	R	WF	GDS27026	Drive Shaft		24	26	52	86	888				
<b>FIESTA</b>																	
-	1999-					GCI18072	Inner Joint		23	22	40	61	86				
<b>FIESTA (FVD)</b>																	
1.0 (33 kW)	1983.08-1989.11		MT		F Box Engine TKB	GC018017	Outer Joint		23	20	48	80.5	49	O			
-	1983.08-1989.11		MT		F Box Engine TKB	GCI18002	Inner Joint		23	20	40	61.5	62.5				
1.8 D (43 kW)	1989.03-1995.12		MT		F Box Engine RTC/RTD/RTG	GC018015	Outer Joint		23	22	48	80	52.5	O			
<b>FIESTA (GFBT)</b>																	
0.9 (29 kW)	1976.05-1983.08		MT		F Hatchback Engine TKA/TKW	GCI18002	Inner Joint		23	20	40	61.5	62.5				
-	1976.05-1983.08		MT		F Hatchback Engine TKA/TKW	GC018018	Outer Joint		23	20	50	91.5	52	O			
0.9 (33 kW)	1976.05-1983.08		MT		F Hatchback Engine TLA	GCI18002	Inner Joint		23	20	40	61.5	62.5				
-	1976.05-1983.08		MT		F Hatchback Engine TLA	GC018018	Outer Joint		23	20	50	91.5	52	O			
1.1 (39 kW)	1976.05-1983.08		MT		F Hatchback Engine GLA	GCI18002	Inner Joint		23	20	40	61.5	62.5				
-	1976.05-1983.08		MT		F Hatchback Engine GLA	GC018018	Outer Joint		23	20	50	91.5	52	O			
1.1 (40 kW)	1981.02-1983.08		MT		F Hatchback Engine GLW	GCI18002	Inner Joint		23	20	40	61.5	62.5				
-	1981.02-1983.08		MT		F Hatchback Engine GLW	GC018018	Outer Joint		23	20	50	91.5	52	O			
<b>FIESTA (WFVT)</b>																	
1.0 (29 kW)	1977.10-1986.11		MT		F Box Engine TKA	GC018018	Outer Joint		23	20	50	91.5	52	O			
-	1977.10-1986.11		MT		F Box Engine TKA	GCI18002	Inner Joint		23	20	40	61.5	62.5				
1.1 (39 kW)	1977.10-1986.11		MT		F Box	GCI18002	Inner Joint		23	20	40	61.5	62.5				
-	1977.10-1986.11		MT		F Box	GC018018	Outer Joint		23	20	50	91.5	52	O			
<b>FIESTA GII</b>																	
1.0	1996.01-1998.12		MT			GC099015	Outer Joint		25	20	56.5	88	49	O			
1.0 Zetec Rocan	1999.01-2006.12		MT			GC018099	Outer Joint		25	20	55	88	52	M			
1.3	1996.01-1998.12		MT			GC099015	Outer Joint		25	20	56.5	88	49	O			
<b>FIESTA II (FBD)</b>																	
1.0 (33 kW)	1983.09-1989.02		MT		F Hatchback Engine TKB	GCI18002	Inner Joint		23	20	40	61.5	62.5				
-	1983.09-1989.02		MT		F Hatchback Engine TKB	GC018018	Outer Joint		23	20	50	91.5	52	O			
1.1 (36 kW)	1986.05-1989.02		MT		F Hatchback Engine GSH	GCI18002	Inner Joint		23	20	40	61.5	62.5				
-	1986.05-1989.02		MT		F Hatchback Engine GSH	GC018018	Outer Joint		23	20	50	91.5	52	O			
1.1 (37 kW)	1983.09-1989.02		MT		F Hatchback Engine GLC/GSF	GCI18002	Inner Joint		23	20	40	61.5	62.5				
-	1983.09-1989.02		MT		F Hatchback Engine GLC/GSF	GC018018	Outer Joint		23	20	50	91.5	52	O			
1.4 (52 kW)	1986.10-1989.02		MT		F Hatchback Engine F6A/F6C	GC018019	Outer Joint		23	22	55	91.5	54.5	O			
1.4 (54 kW)	1987.02-1989.02		MT		F Hatchback Engine FUD	GC018019	Outer Joint		23	22	55	91.5	54.5	O			
1.4 (55 kW)	1985.10-1989.11		MT		F Hatchback Engine FUB	GC018019	Outer Joint		23	22	55	91.5	54.5	O			
1.6 D (40 kW)	1984.04-1989.02		MT		F Hatchback Engine LTB	GCI18002	Inner Joint		23	20	40	61.5	62.5				
-	1984.04-1989.02		MT		F Hatchback Engine LTB	GC018018	Outer Joint		23	20	50	91.5	52	O			
1.6 XR2 (70 kW)	1984.03-1989.02		MT		F Hatchback Engine LUD	GC018019	Outer Joint		23	22	55	91.5	54.5	O			
1.6 XR2 (71 kW)	1984.04-1989.02		MT		F Hatchback Engine LUB	GC018019	Outer Joint		23	22	55	91.5	54.5	O			
<b>FIESTA III (GFJ)</b>																	
1.1 (37 kW)	1989.03-1995.12		MT		F Hatchback Engine G6A	GCI18002	Inner Joint		23	20	40	61.5	62.5				
-	1989.03-1995.12		MT		F Hatchback Engine G6A	GC018017	Outer Joint		23	20	48	80.5	49	O			
1.1 (40 kW)	1989.03-1995.12		MT		F Hatchback Engine GUD/GUE	GCI18002	Inner Joint		23	20	40	61.5	62.5				
-	1989.03-1995.12		MT		F Hatchback Engine GUD/GUE	GC018017	Outer Joint		23	20	48	80.5	49	O			
1.3 (44 kW)	1989.03-1992.12		MT		F Hatchback Engine JBC	GC018015	Outer Joint		23	22	48	80	52.5	O			
1.3 CAT (44 kW)	1991.05-1997.01		MT		F Hatchback Engine J6B	GC018015	Outer Joint		23	22	48	80	52.5	O			
1.4 (52 kW)	1989.03-1995.12		MT		F Hatchback Engine F6E	GC018015	Outer Joint		23	22	48	80	52.5	O			
1.4 (54 kW)	1989.03-1995.12		MT		F Hatchback Engine FUG/FUJ	GC018015	Outer Joint		23	22	48	80	52.5	O			

		TRANSM	L/R	F/R		G-AP Ref.	PRODUCT	ABS	Technical Specifications							
									YEAR	A	B	C	H	L	P	
<b>FORD</b>																
<b>FIESTA III (GFJ)</b>																
1.4 CAT (54 kW)	1989.03-	1995.12	MT		F	Hatchback Engine F4A	GCO18015	Outer Joint		23	22	48	80	52.5	O	
1.6 (65 kW)	1989.01-	1994.01	MT		F	Hatchback Engine LUH	GCO18015	Outer Joint		23	22	48	80	52.5	O	
1.6 XR2i (76 kW)	1989.03-	1993.03	MT		F	Hatchback Engine LJD	GCO18015	Outer Joint		23	22	48	80	52.5	O	
1.8 16V (77 kW)	1992.02-	1995.12	MT		F	Hatchback Engine RDB	GCO18015	Outer Joint		23	22	48	80	52.5	O	
1.8 D (44 kW)	1989.03-	1995.12	MT	L	F	Hatchback Engine RTC/RTD/RTG	GDS18118	Drive Shaft		23	23	48	80	583.5		
	1989.03-	1995.12	MT	R	F	Hatchback Engine RTC/RTD/RTG	GDS18289	Drive Shaft		23	23	48	80	857		
	1989.03-	1995.12	MT		F	Hatchback Engine RTC/RTD/RTG	GCO18015	Outer Joint		23	22	48	80	52.5	O	
1.8 XR2i 16V (96 kW)	1992.02-	1995.12	MT		F	Hatchback Engine RQC	GCO18015	Outer Joint		23	22	48	80	52.5	O	
<b>FIESTA IV</b>																
1.3	1995.10-	1997.01	MT	R	F		GDS99043	Drive Shaft		25	25	56.5	88.5	813		
	1997.01-	2000.03	MT	R	F		GDS18032	Drive Shaft		25	23	56.5	88.5	900		
1.4	1996.02-	1997.01	MT	R	F		GDS99043	Drive Shaft		25	25	56.5	88.5	813		
	1997.01-	2000.10	MT	R	F		GDS18032	Drive Shaft		25	23	56.5	88.5	900		
1.8 D	1995.10-	1997.01	MT	R	F		GDS99043	Drive Shaft		25	25	56.5	88.5	813		
	1997.01-	2000.03	MT	R	F		GDS18032	Drive Shaft		25	23	56.5	88.5	900		
<b>FIESTA IV (JA_, JB_)</b>																
1.0 i (48 kW)	1999.09-	2002.01	MT	L	F	Hatchback	GDS18141	Drive Shaft		25	23	55.5	88.5	606		
1.25 i 16V (55 kW)	1995.08-	2002.01	MT		F	Hatchback Engine DHA/DHB/DHC/DHD/DHE/DHF/DHG	GCO18004	Outer Joint		25	22	56.5	88.5	53.5	O	
	1995.08-	2002.01	MT	L	F	Hatchback Engine DHA/DHB/DHC/DHD/DHE/DHF/DHG	GDS18141	Drive Shaft		25	23	55.5	88.5	606		
1.3 i (37 kW)	1995.08-	2002.01	MT	L	F	Hatchback Engine JJA/JJC/JJE/JJJ/JJK/JJM	GDS18141	Drive Shaft		25	23	55.5	88.5	606		
	1995.08-	2002.01		R	F	Hatchback Engine JJA/JJC/JJE/JJJ/JJK/JJM	GDS18011	Drive Shaft		25	25	55.5	88.5	813.5		
	1995.08-	2002.01		R	F	Hatchback Engine JJA/JJC/JJE/JJJ/JJK/JJM	GCI18047	Inner Joint		25	22	30	283	81		
	1995.08-	2002.01		R	F	Hatchback Engine JJA/JJC/JJE/JJJ/JJK/JJM	GCO18006	Outer Joint		25	22	55.5	88.5	53	O	
	1995.08-	2002.01	MT		F	Hatchback Engine JJA/JJC/JJE/JJJ/JJK/JJM	GCO18012	Outer Joint		25	20	56.5	88.5	49	O	
1.3 i (44 kW)	1995.08-	2002.01	MT	L	F	Hatchback Engine J4C/J4J/J4L/J4Q/J4R/J4T/JBC	GDS18141	Drive Shaft		25	23	55.5	88.5	606		
	1995.08-	2002.01	MT		F	Hatchback Engine J4C/J4J/J4L/J4Q/J4R/J4T/JBC	GCO18012	Outer Joint		25	20	56.5	88.5	49	O	
1.4 i 16V (66 kW)	1996.04-	2002.01	MT		F	Hatchback Engine FHA/FHE	GCO18004	Outer Joint		25	22	56.5	88.5	53.5	O	
	1996.04-	2002.01	MT	L	F	Hatchback Engine FHA/FHE	GDS18141	Drive Shaft		25	23	55.5	88.5	606		
	1996.04-	2002.01		R	F	Hatchback Engine FHA/FHE	GDS18011	Drive Shaft		25	25	55.5	88.5	813.5		
	1996.04-	2002.01		R	F	Hatchback Engine FHA/FHE	GCI18047	Inner Joint		25	22	30	283	81		
	1996.04-	2002.01		R	F	Hatchback Engine FHA/FHE	GCO18006	Outer Joint		25	22	55.5	88.5	53	O	
1.6 (65 kW)	2000.02-	2002.01	MT	R	F	Hatchback	GDS18175	Drive Shaft		25	23	56.5	88.5	898		
	2000.02-	2002.01	MT	R	F	Hatchback	GCI18087	Inner Joint		23	22	40	371	78.5		
	2000.02-	2002.01	MT	R	F	Hatchback	GCO18004	Outer Joint		25	22	56.5	88.5	53.5	O	
1.6 16V Sport (76 kW)	2000.02-	2002.01	MT	L	F	Hatchback Engine L1T/L1V	GDS18141	Drive Shaft		25	23	55.5	88.5	606		
	2000.02-	2002.01	MT	R	F	Hatchback Engine L1T/L1V	GDS18175	Drive Shaft		25	23	56.5	88.5	898		
	2000.02-	2002.01	MT	R	F	Hatchback Engine L1T/L1V	GCI18087	Inner Joint		23	22	40	371	78.5		
	2000.02-	2002.01	MT	R	F	Hatchback Engine L1T/L1V	GCO18004	Outer Joint		25	22	56.5	88.5	53.5	O	
1.8 Di (55 kW)	2000.04-	2002.01	MT	L	F	Hatchback Engine RTN/RTP/RTQ	GDS18141	Drive Shaft		25	23	55.5	88.5	606		
	2000.04-	2002.01	MT	R	F	Hatchback Engine RTN/RTP/RTQ	GDS18175	Drive Shaft		25	23	56.5	88.5	898		
	2000.04-	2002.01	MT	R	F	Hatchback Engine RTN/RTP/RTQ	GCI18087	Inner Joint		23	22	40	371	78.5		
	2000.04-	2002.01	MT	R	F	Hatchback Engine RTN/RTP/RTQ	GCO18004	Outer Joint		25	22	56.5	88.5	53.5	O	
<b>FIESTA V (JH, JD)</b>																
1.4 TDCi (50 kW)	2001.11-						GCO18001	Outer Joint		25	20	52.9	89	52	M	
1.6 16V (74 kW)	2001.11-						GCO18003	Outer Joint		25	21	53.3	89	53	M	
<b>FIESTA V (JH_, JD_)</b>																
1.25 16V (51 kW)	2003.02-	2005.09			F	Hatchback Engine M7JA/M7JB	GCO18009	Outer Joint		25	22	53.3	90	51	M	
	2003.02-	2005.09	MT	L	F	Hatchback Engine M7JA/M7JB	GDS18202	Drive Shaft		25	23	53	88	620		
	2003.02-	2005.09	MT	R	F	Hatchback Engine M7JA/M7JB	GDS18201	Drive Shaft		25	23	53.3	90	919		
1.25 16V (55 kW)	2002.05-	2008.03		L	F	Hatchback Engine FUJA/FUJB	GDS18202	Drive Shaft		25	23	53	88	620		
	2002.05-	2008.03		R	F	Hatchback Engine FUJA/FUJB	GDS18201	Drive Shaft		25	23	53.3	90	919		
1.3 (44 kW)	2001.11-	2008.06			F	Hatchback Engine BAJA	GCO18009	Outer Joint		25	22	53.3	90	51	M	
	2001.11-	2008.06	MT	L	F	Hatchback Engine BAJA	GDS18202	Drive Shaft		25	23	53	88	620		
	2001.11-	2008.06	MT	R	F	Hatchback Engine BAJA	GDS18201	Drive Shaft		25	23	53.3	90	919		
1.3 (51 kW)	2001.11-	2008.06			F	Hatchback Engine A9JA/A9JB	GCO18009	Outer Joint		25	22	53.3	90	51	M	
	2001.11-	2008.06	MT	L	F	Hatchback Engine A9JA/A9JB	GDS18202	Drive Shaft		25	23	53	88	620		
	2001.11-	2008.06	MT	R	F	Hatchback Engine A9JA/A9JB	GDS18201	Drive Shaft		25	23	53.3	90	919		
1.4 16V (59 kW)	2001.11-	2008.06			F	Hatchback Engine FXJA/FXJB	GCO18009	Outer Joint		25	22	53.3	90	51	M	
	2001.11-	2008.06		L	F	Hatchback Engine FXJA/FXJB	GDS18202	Drive Shaft		25	23	53	88	620		
	2001.11-	2008.06		R	F	Hatchback Engine FXJA/FXJB	GDS18201	Drive Shaft		25	23	53.3	90	919		
1.4 TDCi (50 kW)	2001.11-	2008.06			F	Hatchback Engine F6JA/F6JB	GCO18001	Outer Joint		25	20	52.9	89	52	M	
	2001.11-	2008.06	MT	L	F	Hatchback Engine F6JA/F6JB	GDS18216	Drive Shaft		25	23	53.3	90	621		



		TRANSM	L/R	F/R		G-AP Ref.	PRODUCT	ABS	Technical Specifications									
									YEAR	A	B	C	H	L	P			
<b>FORD</b>																		
<b>FIESTA V (JH_, JD_)</b>																		
1.4 TDCi (50 kW)	2001.11-	2008.06		L	F	Hatchback Engine F6JA/F6JB	GDS18202	Drive Shaft	25	23	53	88	620					
	2001.11-	2008.06	MT	R	F	Hatchback Engine F6JA/F6JB	GDS18217	Drive Shaft	25	23	52.9	89	916					
	2001.11-	2008.06		R	F	Hatchback Engine F6JA/F6JB	GDS18201	Drive Shaft	25	23	53.3	90	919					
1.6 16V (74 kW)	2001.11-	2008.06			F	Hatchback Engine FYJA/FYJB	GC018014	Outer Joint	25	21	53.2	89	54	M				
	2001.11-	2008.06	AT	L	F	Hatchback Engine FYJA/FYJB	GDS18351	Drive Shaft	25	22	53.3	89	606					
	2001.11-	2008.06	MT	L	F	Hatchback Engine FYJA/FYJB	GDS18202	Drive Shaft	25	23	53	88	620					
	2001.11-	2008.06	AT	R	F	Hatchback Engine FYJA/FYJB	GDS18333	Drive Shaft	25	22	53.3	89	930					
	2001.11-	2008.06	MT	R	F	Hatchback Engine FYJA/FYJB	GDS18201	Drive Shaft	25	23	53.3	90	919					
	2001.11-	2008.06				Hatchback Engine FYJA/FYJB	GC018222	Outer Joint	25	23	53.3	87	56	M				
	2001.11-	2008.06				Hatchback Engine FYJA/FYJB	GC018222	Outer Joint	25	23	53.3	87	56	M				
1.6 TDCi (66 kW)	2004.11-	2007.03	MT	L	F	Hatchback Engine HHJA/HHJB	GDS18202	Drive Shaft	25	23	53	88	620					
	2004.11-	2007.03	MT	L	F	Hatchback Engine HHJA/HHJB	GDS18309	Drive Shaft	25	23	52.9	89	615					
	2004.11-	2007.03	MT	R	F	Hatchback Engine HHJA/HHJB	GDS18201	Drive Shaft	25	23	53.3	90	919					
	2004.11-	2007.03	MT	R	F	Hatchback Engine HHJA/HHJB	GDS18326	Drive Shaft	25	23	53.38	88.5	915					
	2004.11-	2007.03				Hatchback Engine HHJA/HHJB	GC018222	Outer Joint	25	23	53.3	87	56	M				
2.0 ST150 (110 kW)	2004.11-	2007.03	MT	L	F	Hatchback Engine N4JB	GDS18309	Drive Shaft	25	23	52.9	89	615					
	2004.11-	2007.03	MT	R	F	Hatchback Engine N4JB	GDS18018	Drive Shaft	25	23	53.2	89	930					
	2004.11-	2007.03	MT	R	F	Hatchback Engine N4JB	GDS18326	Drive Shaft	25	23	53.38	88.5	915					
<b>FIESTA VAN</b>																		
1.25 (60 kW)	2009.01-		MT	L	F	Box Engine SNJA/SNJB	GDS18202	Drive Shaft	25	23	53	88	620					
	2009.01-		MT	R	F	Box Engine SNJA/SNJB	GDS18201	Drive Shaft	25	23	53.3	90	919					
1.3 (51 kW)	2003.10-			L	F	Box Engine A9JA/A9JB	GDS18202	Drive Shaft	25	23	53	88	620					
	2003.10-			R	F	Box Engine A9JA/A9JB	GDS18201	Drive Shaft	25	23	53.3	90	919					
1.4 TDCi (50 kW)	2003.10-				F	Box Engine F6JA/F6JB	GC018001	Outer Joint	25	20	52.9	89	52	M				
	2003.10-			L	F	Box Engine F6JA/F6JB	GDS18202	Drive Shaft	25	23	53	88	620					
	2003.10-			R	F	Box Engine F6JA/F6JB	GDS18201	Drive Shaft	25	23	53.3	90	919					
	2009.01-		MT	L	F	Box Engine F6JB	GDS18202	Drive Shaft	25	23	53	88	620					
	2009.01-		MT	R	F	Box Engine F6JB	GDS18201	Drive Shaft	25	23	53.3	90	919					
1.4 TDCi (51 kW)	2010.07-		MT	L	F	Box Engine F6JD/KVJA	GDS18202	Drive Shaft	25	23	53	88	620					
	2010.07-		MT	R	F	Box Engine F6JD/KVJA	GDS18201	Drive Shaft	25	23	53.3	90	919					
1.6 TDCi (66 kW)	2009.01-		MT	L	F	Box Engine HHJC/HHJD/HHJE	GDS18202	Drive Shaft	25	23	53	88	620					
	2009.01-		MT	R	F	Box Engine HHJC/HHJD/HHJE	GDS18201	Drive Shaft	25	23	53.3	90	919					
	2009.01-					Box Engine HHJC/HHJD/HHJE	GC018222	Outer Joint	25	23	53.3	87	56	M				
1.6 TDCi (70 kW)	2010.02-		MT	L	F	Box Engine TZJA/TZJB	GDS18202	Drive Shaft	25	23	53	88	620					
	2010.02-		MT	R	F	Box Engine TZJA/TZJB	GDS18201	Drive Shaft	25	23	53.3	90	919					
	2010.02-					Box Engine TZJA/TZJB	GC018222	Outer Joint	25	23	53.3	87	56	M				
<b>FIESTA VI</b>																		
1.0 (48 kW)	2013.01-			L	F	Hatchback Engine XMJA/XMJB	GDS18202	Drive Shaft	25	23	53	88	620					
	2013.01-		MT	R	F	Hatchback Engine XMJA/XMJB	GDS18201	Drive Shaft	25	23	53.3	90	919					
	2013.01-					Hatchback Engine XMJA/XMJB	GC018222	Outer Joint	25	23	53.3	87	56	M				
1.0 (59 kW)	2012.10-			L	F	Hatchback Engine P4JA/P4JB	GDS18202	Drive Shaft	25	23	53	88	620					
	2012.10-		MT	R	F	Hatchback Engine P4JA/P4JB	GDS18201	Drive Shaft	25	23	53.3	90	919					
	2012.10-					Hatchback Engine P4JA/P4JB	GC018222	Outer Joint	25	23	53.3	87	56	M				
1.0 EcoBoost (74 kW)	2013.01-		MT	L	F	Hatchback Engine SFJA/SFJB	GDS18202	Drive Shaft	25	23	53	88	620					
	2013.01-		AT	R	F	Hatchback Engine SFJA/SFJB	GDS18406	Drive Shaft	25	34	53.3	87	974					
	2013.01-		MT	R	F	Hatchback Engine SFJA/SFJB	GDS18201	Drive Shaft	25	23	53.3	90	919					
1.0 EcoBoost (92 kW)	2012.09-		MT	L	F	Hatchback Engine M1JE	GDS18202	Drive Shaft	25	23	53	88	620					
	2012.09-		MT	R	F	Hatchback Engine M1JE	GDS18201	Drive Shaft	25	23	53.3	90	919					
1.0 Sport (103 kW)	2014.05-		MT	L	F	Hatchback Engine YYJA/YYJB	GDS18202	Drive Shaft	25	23	53	88	620					
	2014.05-		MT	R	F	Hatchback Engine YYJA/YYJB	GDS18201	Drive Shaft	25	23	53.3	90	919					
1.25 (44 kW)	2008.06-		MT	L	F	Hatchback Engine STJA/STJB	GDS18202	Drive Shaft	25	23	53	88	620					
	2008.06-		MT	R	F	Hatchback Engine STJA/STJB	GDS18201	Drive Shaft	25	23	53.3	90	919					
1.25 (60 kW)	2008.06-		MT	L	F	Hatchback Engine SNJA/SNJB	GDS18202	Drive Shaft	25	23	53	88	620					
	2008.06-		MT	R	F	Hatchback Engine SNJA/SNJB	GDS18201	Drive Shaft	25	23	53.3	90	919					
	2008.06-					Hatchback Engine SNJA/SNJB	GC018222	Outer Joint	25	23	53.3	87	56	M				
1.4	2008-	2012		R	F		GDS18201	Drive Shaft	25	23	53.3	90	919					
1.4 (71 kW)	2008.06-		MT	L	F	Hatchback Engine SPJA/SPJC	GDS18202	Drive Shaft	25	23	53	88	620					
	2008.06-		MT	R	F	Hatchback Engine SPJA/SPJC	GDS18201	Drive Shaft	25	23	53.3	90	919					
	2008.06-					Hatchback Engine SPJA/SPJC	GC018222	Outer Joint	25	23	53.3	87	56	M				
1.4 LPG (68 kW)	2009.01-		MT	L	F	Hatchback Engine RTJA/RTJB	GDS18202	Drive Shaft	25	23	53	88	620					
	2009.01-		MT	R	F	Hatchback Engine RTJA/RTJB	GDS18201	Drive Shaft	25	23	53.3	90	919					
	2009.01-					Hatchback Engine RTJA/RTJB	GC018222	Outer Joint	25	23	53.3	87	56	M				





	 YEAR	TRANSM	L/R	F/R		G-AP Ref.	PRODUCT	ABS	Technical Specifications									
									A	B	C	H	L	P				
<b>FORD FIESTA VI</b>																		
1.4 LPG (71 kW)	2009.01-		MT	L	F	Hatchback Engine RTJA/RTJB	GDS18202	Drive Shaft		25	23	53	88	620				
	2009.01-		MT	R	F	Hatchback Engine RTJA/RTJB	GDS18201	Drive Shaft		25	23	53.3	90	919				
	2009.01-					Hatchback Engine RTJA/RTJB	GC018222	Outer Joint		25	23	53.3	87	56	M			
1.4 TDCi	2008-2012			R	F		GDS18201	Drive Shaft		25	23	53.3	90	919				
1.4 TDCi (50 kW)	2009.01-		MT	L	F	Hatchback Engine F6JB	GDS18202	Drive Shaft		25	23	53	88	620				
	2009.01-		MT	R	F	Hatchback Engine F6JB	GDS18201	Drive Shaft		25	23	53.3	90	919				
1.4 TDCi (51 kW)	2010.07-		MT	L	F	Hatchback Engine F6JD/KVJA	GDS18202	Drive Shaft		25	23	53	88	620				
	2010.07-		MT	R	F	Hatchback Engine F6JD/KVJA	GDS18201	Drive Shaft		25	23	53.3	90	919				
1.5 TDCi (55 kW)	2012.09-		MT	R	F	Hatchback Engine UGJC	GDS18407	Drive Shaft		25	23	53.3	87	922				
	2012.09-					Hatchback Engine UGJC	GC018222	Outer Joint		25	23	53.3	87	56	M			
1.6 (70 kW)	2008.06-		MT	R	F	Hatchback	GDS18201	Drive Shaft		25	23	53.3	90	919				
1.6 TDCi (66 kW)	2008.06-		MT	L	F	Hatchback Engine HHJC/HHJD/HHJE	GDS18202	Drive Shaft		25	23	53	88	620				
	2008.06-		MT	R	F	Hatchback Engine HHJC/HHJD/HHJE	GDS18201	Drive Shaft		25	23	53.3	90	919				
	2008.06-					Hatchback Engine HHJC/HHJD/HHJE	GC018222	Outer Joint		25	23	53.3	87	56	M			
1.6 TDCi (70 kW)	2010.02-		MT	L	F	Hatchback Engine TZJA/TZJB/T3JA	GDS18202	Drive Shaft		25	23	53	88	620				
	2010.02-		MT	R	F	Hatchback Engine TZJA/TZJB/T3JA	GDS18201	Drive Shaft		25	23	53.3	90	919				
	2010.02-					Hatchback Engine TZJA/TZJB/T3JA	GC018222	Outer Joint		25	23	53.3	87	56	M			
1.6 TI (77 kW)	2012.09-		AT	R	F	Hatchback Engine IQJA	GDS18406	Drive Shaft		25	34	53.3	87	974				
	2012.09-					Hatchback Engine IQJA	GC018222	Outer Joint		25	23	53.3	87	56	M			
1.6 TI (88 kW)	2008.06-		MT	L	F	Hatchback Engine HXJA/HXJB	GDS18202	Drive Shaft		25	23	53	88	620				
	2008.06-		MT	R	F	Hatchback Engine HXJA/HXJB	GDS18201	Drive Shaft		25	23	53.3	90	919				
	2008.06-					Hatchback Engine HXJA/HXJB	GC018222	Outer Joint		25	23	53.3	87	56	M			
1.6 TI (99 kW)	2010.12-		MT	L	F	Hatchback Engine U5JA	GDS18202	Drive Shaft		25	23	53	88	620				
	2010.12-		MT	R	F	Hatchback Engine U5JA	GDS18201	Drive Shaft		25	23	53.3	90	919				
	2010.12-					Hatchback Engine U5JA	GC018222	Outer Joint		25	23	53.3	87	56	M			
<b>FOCUS</b>																		
-	2000-2005		MT				GCI18044	Inner Joint		26	23	40	68.5	99.5				
	2000-2005		MT				GCI18045	Inner Joint		26	23	40	389	92				
2.0	2002.02-2004.12		AT	L			GDS18138	Drive Shaft	50T	28	28	60	110.5	771				
	2002.02-2004.12		AT	R			GDS18137	Drive Shaft	50T	28	28	60	110.5	868				
<b>FOCUS (DAW, DBW)</b>																		
1.4 16V (55 kW)	1998.10-2004.11		MT/AT		F	Hatchback Engine FXDA/FXDB/FXDC/FXDD	GC018013	Outer Joint		25	23	53.38	88.5	57	M			
	1998.10-2004.11		5MT	L	F	Hatchback Engine FXDA/FXDB/FXDC/FXDD	GDS18042	Drive Shaft		25	23	53.38	88.5	633				
	1998.10-2004.11		5MT	R	F	Hatchback Engine FXDA/FXDB/FXDC/FXDD	GDS18046	Drive Shaft		25	23	53.38	88.5	934				
	1998.10-2004.11		MT	R	F	Hatchback Engine FXDA/FXDB/FXDC/FXDD	GDS18018	Drive Shaft		25	23	53.2	89	930				
1.6 16V (74 kW)	1998.10-2004.11		MT/AT		F	Hatchback Engine FYDA/FYDB/FYDC/FYDD/FYDH	GC018013	Outer Joint		25	23	53.38	88.5	57	M			
	1998.10-2004.11		5MT	L	F	Hatchback Engine FYDA/FYDB/FYDC/FYDD/FYDH	GDS18042	Drive Shaft		25	23	53.38	88.5	633				
	1998.10-2004.11		5MT	R	F	Hatchback Engine FYDA/FYDB/FYDC/FYDD/FYDH	GDS18046	Drive Shaft		25	23	53.38	88.5	934				
	1998.10-2004.11		MT	R	F	Hatchback Engine FYDA/FYDB/FYDC/FYDD/FYDH	GDS18018	Drive Shaft		25	23	53.2	89	930				
1.8 16V (85 kW)	1998.10-2004.11		MT/AT		F	Hatchback Engine EYDB/EYDC/EYDD/EYDE/EYDF/EYDG/EYDI/EYDJ/EYDL	GC018013	Outer Joint		25	23	53.38	88.5	57	M			
	1998.10-2004.11		5MT	L	F	Hatchback Engine EYDB/EYDC/EYDD/EYDE/EYDF/EYDG/EYDI/EYDJ/EYDL	GDS18042	Drive Shaft		25	23	53.38	88.5	633				
	1998.10-2004.11		5MT	R	F	Hatchback Engine EYDB/EYDC/EYDD/EYDE/EYDF/EYDG/EYDI/EYDJ/EYDL	GDS18046	Drive Shaft		25	23	53.38	88.5	934				
	1998.10-2004.11		MT	R	F	Hatchback Engine EYDB/EYDC/EYDD/EYDE/EYDF/EYDG/EYDI/EYDJ/EYDL	GDS18018	Drive Shaft		25	23	53.2	89	930				
1.8 Di/TDDi (55 kW)	1999.08-2004.11		MT/AT		F	Hatchback Engine BHDA/BHDB	GC018013	Outer Joint		25	23	53.38	88.5	57	M			
	1999.08-2004.11		MT/AT	L	F	Hatchback Engine BHDA/BHDB	GDS18101	Drive Shaft		25	26	53.38	88.5	613				
	1999.08-2004.11		MT/AT	R	F	Hatchback Engine BHDA/BHDB	GDS18102	Drive Shaft		25	26	53.38	88.5	944.5				
1.8 TDCi (74 kW)	2002.08-2004.11				F	Hatchback Engine FFDA	GC018069	Outer Joint		25	24	52.6	88	59	M			
1.8 TDCi (85 kW)	2001.03-2004.11				F	Hatchback Engine F9DA/F9DB	GC018069	Outer Joint		25	24	52.6	88	59	M			
1.8 Turbo Di/TDDi (66 kW)	1998.10-2004.11		MT/AT		F	Hatchback Engine C9DA/C9DB/C9DC	GC018013	Outer Joint		25	23	53.38	88.5	57	M			
	1998.10-2004.11		MT/AT	L	F	Hatchback Engine C9DA/C9DB/C9DC	GDS18101	Drive Shaft		25	26	53.38	88.5	613				
	1998.10-2004.11		MT/AT	R	F	Hatchback Engine C9DA/C9DB/C9DC	GDS18102	Drive Shaft		25	26	53.38	88.5	944.5				
2.0 16V (96 kW)	1998.10-2004.11		5MT	L	F	Hatchback Engine EDDB/EDDC/EDDD/EDDF	GDS18101	Drive Shaft		25	26	53.38	88.5	613				
	1998.10-2004.11		5MT	R	F	Hatchback Engine EDDB/EDDC/EDDD/EDDF	GDS18102	Drive Shaft		25	26	53.38	88.5	944.5				
2.0 RS (158 kW)	2002.10-2004.11		MT	L	F	Hatchback Engine HMDA	GDS18027	Drive Shaft		27	26	57	91	627.5				
	2002.10-2004.11		MT	R	F	Hatchback Engine HMDA	GDS18028	Drive Shaft		27	35	57	91	576.5				
2.0 ST170 (127 kW)	2002.03-2004.11		MT	L	F	Hatchback Engine ALDA	GDS18195	Drive Shaft		25	34	52.6	88	603				
	2002.03-2004.11		MT	L	F	Hatchback Engine ALDA	GCI18126	Inner Joint		34	24	40	54	97				
	2002.03-2004.11		MT	R	F	Hatchback Engine ALDA	GDS99175	Drive Shaft		25	34	52.6	88	948				
	2002.03-2004.11		MT	R	F	Hatchback Engine ALDA	GCI18182	Inner Joint		34	24	36	390	91.5				
	2002.03-2004.11		MT	R	F	Hatchback Engine ALDA	GC018069	Outer Joint		25	24	52.6	88	59	M			
<b>FOCUS (DFW)</b>																		
1.4 16V (55 kW)	1999.02-2004.11		MT/AT		F	Saloon Engine FXDA/FXDB/FXDC/FXDD	GC018013	Outer Joint		25	23	53.38	88.5	57	M			



	 YEAR	TRANSM	L/R	F/R		G-AP Ref.	PRODUCT	ABS	Technical Specifications									
									A	B	C	H	L	P				
<b>FORD</b>																		
<b>FOCUS (DFW)</b>																		
1.4 16V (55 kW)	1999.02-2004.11	5MT	L	F	Saloon Engine FXDA/FXDB/FXDC/FXDD	GDS18042	Drive Shaft		25	23	53.38	88.5	633					
	1999.02-2004.11	5MT	R	F	Saloon Engine FXDA/FXDB/FXDC/FXDD	GDS18046	Drive Shaft		25	23	53.38	88.5	934					
1.6 16V (74 kW)	1999.02-2004.11	MT/AT		F	Saloon Engine FYDA/FYDB/FYDC/FYDD/FYDH	GC018013	Outer Joint		25	23	53.38	88.5	57	M				
	1999.02-2004.11	5MT	L	F	Saloon Engine FYDA/FYDB/FYDC/FYDD/FYDH	GDS18042	Drive Shaft		25	23	53.38	88.5	633					
	1999.02-2004.11	5MT	R	F	Saloon Engine FYDA/FYDB/FYDC/FYDD/FYDH	GDS18046	Drive Shaft		25	23	53.38	88.5	934					
	1999.02-2004.11	MT	R	F	Saloon Engine FYDA/FYDB/FYDC/FYDD/FYDH	GDS18018	Drive Shaft		25	23	53.2	89	930					
1.8 16V (85 kW)	1999.02-2004.11	MT/AT		F	Saloon Engine EYDB/EYDC/EYDD/EYDE/EYDF/EYDG/EYDI/EYDJ/EYDL	GC018013	Outer Joint		25	23	53.38	88.5	57	M				
	1999.02-2004.11	5MT	L	F	Saloon Engine EYDB/EYDC/EYDD/EYDE/EYDF/EYDG/EYDI/EYDJ/EYDL	GDS18042	Drive Shaft		25	23	53.38	88.5	633					
	1999.02-2004.11	5MT	R	F	Saloon Engine EYDB/EYDC/EYDD/EYDE/EYDF/EYDG/EYDI/EYDJ/EYDL	GDS18046	Drive Shaft		25	23	53.38	88.5	934					
	1999.02-2004.11	MT	R	F	Saloon Engine EYDB/EYDC/EYDD/EYDE/EYDF/EYDG/EYDI/EYDJ/EYDL	GDS18018	Drive Shaft		25	23	53.2	89	930					
1.8 TDCi (74 kW)	2002.08-2004.11			F	Saloon Engine FFDA	GC018069	Outer Joint		25	24	52.6	88	59	M				
1.8 TDCi (85 kW)	2001.10-2005.04			F	Saloon Engine F9DA/F9DB	GC018069	Outer Joint		25	24	52.6	88	59	M				
1.8 Turbo Di/TDDi (66 kW)	1999.02-2004.11	MT/AT	L	F	Saloon Engine C9DA/C9DB/C9DC	GDS18101	Drive Shaft		25	26	53.38	88.5	613					
	1999.02-2004.11	MT/AT	R	F	Saloon Engine C9DA/C9DB/C9DC	GDS18102	Drive Shaft		25	26	53.38	88.5	944.5					
2.0 16V (96 kW)	1999.02-2004.11	MT/AT	L	F	Saloon Engine EDDB/EDDC/EDDD/EDDF	GDS18101	Drive Shaft		25	26	53.38	88.5	613					
	1999.02-2004.11	MT/AT	R	F	Saloon Engine EDDB/EDDC/EDDD/EDDF	GDS18102	Drive Shaft		25	26	53.38	88.5	944.5					
<b>FOCUS (DNW)</b>																		
1.4 16V (55 kW)	1999.02-2004.11	MT/AT		F	Estate Engine FXDA/FXDB/FXDC/FXDD	GC018013	Outer Joint		25	23	53.38	88.5	57	M				
	1999.02-2004.11	5MT	L	F	Estate Engine FXDA/FXDB/FXDC/FXDD	GDS18042	Drive Shaft		25	23	53.38	88.5	633					
	1999.02-2004.11	5MT	R	F	Estate Engine FXDA/FXDB/FXDC/FXDD	GDS18046	Drive Shaft		25	23	53.38	88.5	934					
1.6 16V (74 kW)	1999.02-2004.11	MT/AT		F	Estate Engine FYDA/FYDB/FYDC/FYDD/FYDH	GC018013	Outer Joint		25	23	53.38	88.5	57	M				
	1999.02-2004.11	5MT	L	F	Estate Engine FYDA/FYDB/FYDC/FYDD/FYDH	GDS18042	Drive Shaft		25	23	53.38	88.5	633					
	1999.02-2004.11	5MT	R	F	Estate Engine FYDA/FYDB/FYDC/FYDD/FYDH	GDS18046	Drive Shaft		25	23	53.38	88.5	934					
	1999.02-2004.11	MT	R	F	Estate Engine FYDA/FYDB/FYDC/FYDD/FYDH	GDS18018	Drive Shaft		25	23	53.2	89	930					
1.8 16V (85 kW)	1999.02-2004.11	MT/AT		F	Estate Engine EYDB/EYDC/EYDD/EYDE/EYDF/EYDG/EYDI/EYDJ/EYDL	GC018013	Outer Joint		25	23	53.38	88.5	57	M				
	1999.02-2004.11	5MT	L	F	Estate Engine EYDB/EYDC/EYDD/EYDE/EYDF/EYDG/EYDI/EYDJ/EYDL	GDS18042	Drive Shaft		25	23	53.38	88.5	633					
	1999.02-2004.11	5MT	R	F	Estate Engine EYDB/EYDC/EYDD/EYDE/EYDF/EYDG/EYDI/EYDJ/EYDL	GDS18046	Drive Shaft		25	23	53.38	88.5	934					
	1999.02-2004.11	MT	R	F	Estate Engine EYDB/EYDC/EYDD/EYDE/EYDF/EYDG/EYDI/EYDJ/EYDL	GDS18018	Drive Shaft		25	23	53.2	89	930					
1.8 BiFuel (82 kW)	2003.02-2005.01	MT	R	F	Estate	GDS18018	Drive Shaft		25	23	53.2	89	930					
1.8 Di/TDDi (55 kW)	1999.08-2004.11	MT/AT		F	Estate Engine BHDA/BHDB	GC018013	Outer Joint		25	23	53.38	88.5	57	M				
	1999.08-2004.11	MT/AT	L	F	Estate Engine BHDA/BHDB	GDS18101	Drive Shaft		25	26	53.38	88.5	613					
	1999.08-2004.11	MT/AT	R	F	Estate Engine BHDA/BHDB	GDS18102	Drive Shaft		25	26	53.38	88.5	944.5					
1.8 TDCi (74 kW)	2002.08-2004.11			F	Estate Engine FFDA	GC018069	Outer Joint		25	24	52.6	88	59	M				
1.8 TDCi (85 kW)	2001.03-2004.11			F	Estate Engine F9DA/F9DB	GC018069	Outer Joint		25	24	52.6	88	59	M				
1.8 Turbo Di/TDDi (66 kW)	1999.02-2004.11	MT/AT		F	Estate Engine C9DA/C9DB/C9DC	GC018013	Outer Joint		25	23	53.38	88.5	57	M				
	1999.02-2004.11	MT/AT	L	F	Estate Engine C9DA/C9DB/C9DC	GDS18101	Drive Shaft		25	26	53.38	88.5	613					
	1999.02-2004.11	MT/AT	R	F	Estate Engine C9DA/C9DB/C9DC	GDS18102	Drive Shaft		25	26	53.38	88.5	944.5					
2.0 16V (96 kW)	1999.02-2004.11	MT/AT	L	F	Estate Engine EDDB/EDDC/EDDD/EDDF	GDS18101	Drive Shaft		25	26	53.38	88.5	613					
	1999.02-2004.11	MT/AT	R	F	Estate Engine EDDB/EDDC/EDDD/EDDF	GDS18102	Drive Shaft		25	26	53.38	88.5	944.5					
2.0 ST170 (127 kW)	2002.08-2004.11	MT	L	F	Estate Engine ALDA	GDS18195	Drive Shaft		25	34	52.6	88	603					
	2002.08-2004.11	MT	L	F	Estate Engine ALDA	GCI18126	Inner Joint		34	24	40	54	97					
	2002.08-2004.11	MT	R	F	Estate Engine ALDA	GDS99175	Drive Shaft		25	34	52.6	88	948					
	2002.08-2004.11	MT	R	F	Estate Engine ALDA	GCI18182	Inner Joint		34	24	36	390	91.5					
	2002.08-2004.11	MT	R	F	Estate Engine ALDA	GC018069	Outer Joint		25	24	52.6	88	59	M				
<b>FOCUS C-MAX</b>																		
1.6 (74 kW)	2003.10-2007.02			F	MPV Engine HWDA/HWDB	GC099129	Outer Joint		36	24	56	48	57	M				
	2003.10-2007.02	MT	L	F	MPV Engine HWDA/HWDB	GDS18189	Drive Shaft		36	23	56	48	601					
	2003.10-2007.02	MT	L	F	MPV Engine HWDA/HWDB	GCI18168	Inner Joint		23	22	40	61	90					
	2003.10-2007.02	MT	L	F	MPV Engine HWDA/HWDB	GC018264	Outer Joint		36	25	51.6	48	58	O				
	2003.10-2007.02	MT	R	F	MPV Engine HWDA/HWDB	GDS18206	Drive Shaft		36	23	56	48	906					
	2003.10-2007.02		R	F	MPV Engine HWDA/HWDB	GDS18337	Drive Shaft		36	23	51.6	48	908					
1.6 TDCi (66 kW)	2005.02-2007.03			F	MPV Engine HHDA/HHDB	GC099288	Outer Joint		36	26	56.3	48	61	M				
	2005.02-2007.03		L	F	MPV Engine HHDA/HHDB	GDS18218	Drive Shaft		36	26	56	48	582					
	2005.02-2007.03		L	F	MPV Engine HHDA/HHDB	GCI18172	Inner Joint		34	24	39	61	89.5					
	2005.02-2007.03		L/R	F	MPV Engine HHDA/HHDB	GC099132	Outer Joint		36	24	56	48	57	I				
	2005.02-2007.03		R	F	MPV Engine HHDA/HHDB	GC018230	Outer Joint		36	26	56.3	48	61	M				
	2005.02-2007.03		R	F	MPV Engine HHDA/HHDB	GDS18219	Drive Shaft		36	26	56.3	48	921					
	2005.02-2007.03		R	F	MPV Engine HHDA/HHDB	GCI18124	Inner Joint		34	24	40	353	91					
	2005.02-2007.03					GC099288	Outer Joint		36	26	56.3	48	61	M				
1.6 TDCi (80 kW)	2003.10-2007.02			F	MPV Engine G8DA/G8DB	GC099288	Outer Joint		36	26	56.3	48	61	M				
	2003.10-2007.02	AT	L	F	MPV Engine G8DA/G8DB	GDS18193	Drive Shaft		36	34	56	48	568					
	2003.10-2007.02	AT	L	F	MPV Engine G8DA/G8DB	GCI18172	Inner Joint		34	24	39	61	89.5					





		YEAR	TRANSM	L/R	F/R		G-AP Ref.	PRODUCT	ABS	Technical Specifications						
										A	B	C	H	L	P	
<b>FORD</b>																
<b>FOCUS C-MAX</b>																
1.6 TDCi (80 kW)	2003.10-	2007.02				MPV Engine G8DA/G8DB	GDS18218	Drive Shaft		36	26	56	48	582		
	2003.10-	2007.02	AT	L/R	F	MPV Engine G8DA/G8DB	GC099132	Outer Joint		36	24	56	48	57	I	
	2003.10-	2007.02		R	F	MPV Engine G8DA/G8DB	GC018230	Outer Joint		36	26	56.3	48	61	M	
	2003.10-	2007.02	AT	R	F	MPV Engine G8DA/G8DB	GDS18191	Drive Shaft		36	34	56	48	890		
	2003.10-	2007.02	AT	R	F	MPV Engine G8DA/G8DB	GCI18124	Inner Joint		34	24	40	353	91		
	2003.10-	2007.02		R	F	MPV Engine G8DA/G8DB	GDS18219	Drive Shaft		36	26	56.3	48	921		
	2005.02-	2007.03					GC099288	Outer Joint		36	26	56.3	48	61	M	
1.6 Ti (85 kW)	2005.01-	2007.03			F	MPV Engine HXDA/SIDA	GC099129	Outer Joint		36	24	56	48	57	M	
	2005.01-	2007.03	MT	L	F	MPV Engine HXDA/SIDA	GDS18189	Drive Shaft		36	23	56	48	601		
	2005.01-	2007.03	MT	L	F	MPV Engine HXDA/SIDA	GCI18168	Inner Joint		23	22	40	61	90		
	2005.01-	2007.03	MT	L	F	MPV Engine HXDA/SIDA	GC018264	Outer Joint		36	25	51.6	48	58	O	
	2005.01-	2007.03	MT	R	F	MPV Engine HXDA/SIDA	GDS18206	Drive Shaft		36	23	56	48	906		
	2005.01-	2007.03		R	F	MPV Engine HXDA/SIDA	GDS18337	Drive Shaft		36	23	51.6	48	908		
1.8 (88 kW)	2003.10-	2007.02			F	MPV Engine CSDA/CSDB	GC099129	Outer Joint		36	24	56	48	57	M	
	2003.10-	2007.02		L	F	MPV Engine CSDA/CSDB	GDS18328	Drive Shaft		36	26	55.3	48	580		
	2003.10-	2007.02	MT	L	F	MPV Engine CSDA/CSDB	GDS18189	Drive Shaft		36	23	56	48	601		
	2003.10-	2007.02		R	F	MPV Engine CSDA/CSDB	GDS18329	Drive Shaft		36	26	55.3	48	920		
1.8 (90 kW)	2005.09-	2007.03	MT	L	F	MPV Engine QQDC	GDS18189	Drive Shaft		36	23	56	48	601		
	2005.09-	2007.03	MT	R	F	MPV Engine QQDC	GDS18206	Drive Shaft		36	23	56	48	906		
1.8 (92 kW)	2004.04-	2007.03			F	MPV Engine Q7DA/QQDA/QQDB	GC018203	Outer Joint		36	23	56	48	57	I	
	2004.04-	2007.03	5MT	L	F	MPV Engine Q7DA/QQDA/QQDB	GDS18359	Drive Shaft		36	23	56	48	594		
	2004.04-	2007.03	MT	L	F	MPV Engine Q7DA/QQDA/QQDB	GDS18189	Drive Shaft		36	23	56	48	601		
	2004.04-	2007.03	5MT	R	F	MPV Engine Q7DA/QQDA/QQDB	GDS18358	Drive Shaft		36	23	56	48	899		
	2004.04-	2007.03	MT	R	F	MPV Engine Q7DA/QQDA/QQDB	GDS18206	Drive Shaft		36	23	56	48	906		
1.8 FlexFuel (92 kW)	2006.03-	2007.03			F	MPV Engine Q7DA	GC018203	Outer Joint		36	23	56	48	57	I	
	2006.03-	2007.03	5MT	L	F	MPV Engine Q7DA	GDS18359	Drive Shaft		36	23	56	48	594		
	2006.03-	2007.03	MT	L	F	MPV Engine Q7DA	GDS18189	Drive Shaft		36	23	56	48	601		
	2006.03-	2007.03	5MT	R	F	MPV Engine Q7DA	GDS18358	Drive Shaft		36	23	56	48	899		
	2006.03-	2007.03	MT	R	F	MPV Engine Q7DA	GDS18206	Drive Shaft		36	23	56	48	906		
1.8 Flexifuel (92 kW)	2004.04-	2007.03				GC018203	Outer Joint		36	23	56	48	57	I		
1.8 TDCi (85 kW)	2005.10-	2007.03		L	F	MPV Engine KKDA	GDS18218	Drive Shaft		36	26	56	48	582		
	2005.10-	2007.03		R	F	MPV Engine KKDA	GDS18219	Drive Shaft		36	26	56.3	48	921		
2.0 (107 kW)	2004.03-	2007.02	5AT	L	F	MPV Engine AODA/AODB/SYDA	GDS18327	Drive Shaft		36	26	55.3	48	585		
	2004.03-	2007.02	5MT	L	F	MPV Engine AODA/AODB/SYDA	GDS18328	Drive Shaft		36	26	55.3	48	580		
	2004.03-	2007.02	5AT	R	F	MPV Engine AODA/AODB/SYDA	GDS34163	Drive Shaft		36	26	56	48	926		
	2004.03-	2007.02	AT	R	F	MPV Engine AODA/AODB/SYDA	GDS18190	Drive Shaft		36	26	56.3	48	919		
	2004.03-	2007.02	MT	R	F	MPV Engine AODA/AODB/SYDA	GDS18329	Drive Shaft		36	26	55.3	48	920		
2.0 TDCi (100 kW)	2003.10-	2007.02			F	MPV Engine G6DA/G6DB/G6DD/G6DG	GC099155	Outer Joint		36	26	56	48	64	I	
	2003.10-	2007.02	MT	L	F	MPV Engine G6DA/G6DB/G6DD/G6DG	GDS18194	Drive Shaft		36	26	56	48	568		
2.0 TDCi (98 kW)	2003.10-	2007.03		L	F	MPV Engine G6DF/G6DE/G6DC	GDS18194	Drive Shaft		36	26	56	48	568		
<b>FOCUS I (DAW, DBW), SW</b>																
1.8 TDCi (74 kW)	2002.09-	2004.11					GC018069	Outer Joint		25	24	52.6	88	59	M	
1.8 TDCi (85 kW)	2002.09-	2004.11					GC018069	Outer Joint		25	24	52.6	88	59	M	
<b>FOCUS II</b>																
1.6	2004-	2011		L	F		GDS18261	Drive Shaft		36	23	55.8	48	600		
	2004-	2011		L	F		GCI18086	Inner Joint		23	22	40	61	90		
	2004-	2011		L/R	F		GC062039	Outer Joint		36	24	55.8	48	57	M	
	2004-	2011		R	F		GDS18262	Drive Shaft		36	23	55.8	48	905		
	2004-	2011		R	F		GCI18087	Inner Joint		23	22	40	371	78.5		
1.6 (74 kW)	2006.10-		MT	L	F	Convertible Engine HWDA/HWDB/SHDA/SHDB/SHDC	GDS18189	Drive Shaft		36	23	56	48	601		
	2006.10-		MT	L	F	Convertible Engine HWDA/HWDB/SHDA/SHDB/SHDC	GCI18168	Inner Joint		23	22	40	61	90		
	2006.10-		MT	L	F	Convertible Engine HWDA/HWDB/SHDA/SHDB/SHDC	GC018264	Outer Joint		36	25	51.6	48	58	O	
	2006.10-		AT	R	F	Convertible Engine HWDA/HWDB/SHDA/SHDB/SHDC	GDS18190	Drive Shaft		36	26	56.3	48	919		
	2006.10-		MT	R	F	Convertible Engine HWDA/HWDB/SHDA/SHDB/SHDC	GDS18206	Drive Shaft		36	23	56	48	906		
	2006.10-			R	F	Convertible Engine HWDA/HWDB/SHDA/SHDB/SHDC	GDS18337	Drive Shaft		36	23	51.6	48	908		
2.0 (107 kW)	2006.10-		5MT	L	F	Convertible Engine AODA/AODB	GDS18328	Drive Shaft		36	26	55.3	48	580		
	2006.10-			R	F	Convertible Engine AODA/AODB	GDS18329	Drive Shaft		36	26	55.3	48	920		
	2006.10-		AT	R	F	Convertible Engine AODA/AODB	GDS18190	Drive Shaft		36	26	56.3	48	919		
2.0 TDCi (100 kW)	2006.10-		MT	L	F	Convertible Engine G6DA/G6DB/G6DD	GDS18194	Drive Shaft		36	26	56	48	568		
	2006.10-		MT	R	F	Convertible Engine G6DA/G6DB/G6DD	GDS18280	Drive Shaft		36	26	56	48	918		









		TRANSM	L/R	F/R		G-AP Ref.	PRODUCT	ABS	Technical Specifications									
									YEAR	A	B	C	H	L	P			
<b>FORD</b>																		
<b>FOCUS II (DA)</b>																		
1.4 (59 kW)	2004.11-	2008				GC018203	Outer Joint		36	23	56	48	57	I				
	2004.11-	2008				GC099288	Outer Joint		36	26	56.3	48	61	M				
1.6 (74 kW)	2004.11-	2008				GC018203	Outer Joint		36	23	56	48	57	I				
	2004.11-	2008				GC099288	Outer Joint		36	26	56.3	48	61	M				
1.6 TDCi (66 kW)	2004.11-	2008				GC099288	Outer Joint		36	26	56.3	48	61	M				
	2005.01-	2008				GC018203	Outer Joint		36	23	56	48	57	I				
1.6 TDCi (80 kW)	2004.11-	2008				GC099288	Outer Joint		36	26	56.3	48	61	M				
	2005.01-	2008				GC018203	Outer Joint		36	23	56	48	57	I				
1.6 TI (85 kW)	2004.11-	2008				GC018203	Outer Joint		36	23	56	48	57	I				
	2004.11-	2008				GC099288	Outer Joint		36	26	56.3	48	61	M				
1.8 (92 kW)	2006.03-	2008				GC018203	Outer Joint		36	23	56	48	57	I				
1.8 TDCi (85 kW)	2004-	2008				GC099288	Outer Joint		36	26	56.3	48	61	M				
	2005.01-	2008				GC018203	Outer Joint		36	23	56	48	57	I				
2.0 (107 kW)	2004.11-	2008				GC018203	Outer Joint		36	23	56	48	57	I				
2.0 TDCi (100 kW)	2004.11-	2008				GC099288	Outer Joint		36	26	56.3	48	61	M				
	2004.11-	2008				GC018203	Outer Joint		36	23	56	48	57	I				
2.5 RS (166 kW)	2005.10-	2008				GC018203	Outer Joint		36	23	56	48	57	I				
<b>FOCUS II (DA_)</b>																		
1.4 (59 kW)	2005.01-	2010.06			F	Hatchback Engine ASDA/ASDB	GC099288	Outer Joint	36	26	56.3	48	61	M				
	2005.01-	2010.06			F	Hatchback Engine ASDA/ASDB	GC018203	Outer Joint	36	23	56	48	57	I				
	2005.01-	2010.06	MT	L	F	Hatchback Engine ASDA/ASDB	GDS18189	Drive Shaft	36	23	56	48	601					
	2005.01-	2010.06	MT	L	F	Hatchback Engine ASDA/ASDB	GCI18168	Inner Joint	23	22	40	61	90					
	2005.01-	2010.06	MT	L	F	Hatchback Engine ASDA/ASDB	GC018264	Outer Joint	36	25	51.6	48	58	O				
	2005.01-	2010.06	MT	R	F	Hatchback Engine ASDA/ASDB	GDS18206	Drive Shaft	36	23	56	48	906					
	2005.01-	2010.06			R	F	Hatchback Engine ASDA/ASDB	GDS18337	Drive Shaft	36	23	51.6	48	908				
	2005.04-				F	Saloon Engine ASDA/ASDB	GC099288	Outer Joint	36	26	56.3	48	61	M				
	2005.04-				F	Saloon Engine ASDA/ASDB	GC018203	Outer Joint	36	23	56	48	57	I				
	2005.04-		MT	L	F	Saloon Engine ASDA/ASDB	GDS18189	Drive Shaft	36	23	56	48	601					
	2005.04-		MT	L	F	Saloon Engine ASDA/ASDB	GCI18168	Inner Joint	23	22	40	61	90					
	2005.04-		MT	L	F	Saloon Engine ASDA/ASDB	GC018264	Outer Joint	36	25	51.6	48	58	O				
	2005.04-		MT	R	F	Saloon Engine ASDA/ASDB	GDS18206	Drive Shaft	36	23	56	48	906					
	2005.04-				R	F	Saloon Engine ASDA/ASDB	GDS18337	Drive Shaft	36	23	51.6	48	908				
	1.6 (74 kW)	2005.01-				F	Hatchback Engine HWDA/HWDB/SHDA/SHDB/SHDC	GC099288	Outer Joint	36	26	56.3	48	61	M			
2005.01-					F	Hatchback Engine HWDA/HWDB/SHDA/SHDB/SHDC	GC018203	Outer Joint	36	23	56	48	57	I				
2005.01-			MT	L	F	Hatchback Engine HWDA/HWDB/SHDA/SHDB/SHDC	GDS18189	Drive Shaft	36	23	56	48	601					
2005.01-			MT	L	F	Hatchback Engine HWDA/HWDB/SHDA/SHDB/SHDC	GCI18168	Inner Joint	23	22	40	61	90					
2005.01-			MT	L	F	Hatchback Engine HWDA/HWDB/SHDA/SHDB/SHDC	GC018264	Outer Joint	36	25	51.6	48	58	O				
2005.01-			AT	R	F	Hatchback Engine HWDA/HWDB/SHDA/SHDB/SHDC	GDS18190	Drive Shaft	36	26	56.3	48	919					
2005.01-			MT	R	F	Hatchback Engine HWDA/HWDB/SHDA/SHDB/SHDC	GDS18206	Drive Shaft	36	23	56	48	906					
2005.01-					R	F	Hatchback Engine HWDA/HWDB/SHDA/SHDB/SHDC	GDS18337	Drive Shaft	36	23	51.6	48	908				
2005.04-		2009.12			F	Saloon Engine HWDA/HWDB/SHDA/SHDB/SHDC	GC099288	Outer Joint	36	26	56.3	48	61	M				
2005.04-		2009.12			F	Saloon Engine HWDA/HWDB/SHDA/SHDB/SHDC	GC018203	Outer Joint	36	23	56	48	57	I				
2005.04-		2009.12	MT	L	F	Saloon Engine HWDA/HWDB/SHDA/SHDB/SHDC	GDS18336	Drive Shaft	36	23	51.6	48	600					
2005.04-		2009.12	MT	L	F	Saloon Engine HWDA/HWDB/SHDA/SHDB/SHDC	GCI18168	Inner Joint	23	22	40	61	90					
2005.04-		2009.12	MT	L	F	Saloon Engine HWDA/HWDB/SHDA/SHDB/SHDC	GC018264	Outer Joint	36	25	51.6	48	58	O				
2005.04-		2009.12			R	F	Saloon Engine HWDA/HWDB/SHDA/SHDB/SHDC	GDS18337	Drive Shaft	36	23	51.6	48	908				
1.6 LPG (85 kW)		2009.10-				F	Hatchback Engine SIDA	GC099288	Outer Joint	36	26	56.3	48	61	M			
	2009.10-				F	Hatchback Engine SIDA	GC099129	Outer Joint	36	24	56	48	57	M				
	2009.10-		MT	L	F	Hatchback Engine SIDA	GDS18336	Drive Shaft	36	23	51.6	48	600					
	2009.10-		MT	L	F	Hatchback Engine SIDA	GCI18168	Inner Joint	23	22	40	61	90					
	2009.10-		MT	L	F	Hatchback Engine SIDA	GC018264	Outer Joint	36	25	51.6	48	58	O				
1.6 TDCi (66 kW)	2005.04-				F	Saloon Engine HHDA/HHDB	GC099288	Outer Joint	36	26	56.3	48	61	M				
	2005.04-				F	Saloon Engine HHDA/HHDB	GC018203	Outer Joint	36	23	56	48	57	I				
	2005.04-			R	F	Saloon Engine HHDA/HHDB	GC018230	Outer Joint	36	26	56.3	48	61	M				
	2005.04-			L	F	Saloon Engine HHDA/HHDB	GDS18218	Drive Shaft	36	26	56	48	582					
	2005.04-			R	F	Saloon Engine HHDA/HHDB	GDS18219	Drive Shaft	36	26	56.3	48	921					
	2005.05-				F	Hatchback Engine GPDA/GPDC/HHDA/HHDB	GC099288	Outer Joint	36	26	56.3	48	61	M				
	2005.05-				F	Hatchback Engine GPDA/GPDC/HHDA/HHDB	GC018203	Outer Joint	36	23	56	48	57	I				
	2005.05-			R	F	Hatchback Engine GPDA/GPDC/HHDA/HHDB	GC018230	Outer Joint	36	26	56.3	48	61	M				
	2005.05-			L	F	Hatchback Engine GPDA/GPDC/HHDA/HHDB	GDS18218	Drive Shaft	36	26	56	48	582					
2005.05-				R	F	Hatchback Engine GPDA/GPDC/HHDA/HHDB	GDS18219	Drive Shaft	36	26	56.3	48	921					



		TRANSM	L/R	F/R		G-AP Ref.	PRODUCT	ABS	Technical Specifications										
									YEAR	A	B	C	H	L	P				
<b>FORD</b>																			
<b>FOCUS II (DA_)</b>																			
1.6 TDCi (74 kW)	2004.11-			L	F	Hatchback Engine MTD A/G8DC	GDS18359	Drive Shaft	36	23	56	48	594						
	2004.11-			R	F	Hatchback Engine MTD A/G8DC	GDS18358	Drive Shaft	36	23	56	48	899						
	2004.11-			L	F	Estate Engine MTD A/G8DC	GDS18218	Drive Shaft	36	26	56	48	582						
	2004.11-			R	F	Estate Engine MTD A/G8DC	GDS18219	Drive Shaft	36	26	56.3	48	921						
	2005.04-			L	F	Saloon Engine G8DC/MTDA	GDS18218	Drive Shaft	36	26	56	48	582						
	2005.04-			R	F	Saloon Engine G8DC/MTDA	GDS18219	Drive Shaft	36	26	56.3	48	921						
1.6 TDCi (80 kW)	2004.11-				F	Hatchback Engine G8DA/G8DB/G8DD/G8DE/G8DF	GC099288	Outer Joint	36	26	56.3	48	61	M					
	2004.11-				F	Hatchback Engine G8DA/G8DB/G8DD/G8DE/G8DF	GC018203	Outer Joint	36	23	56	48	57	I					
	2004.11-			R	F	Hatchback Engine G8DA/G8DB/G8DD/G8DE/G8DF	GC018230	Outer Joint	36	26	56.3	48	61	M					
	2004.11-			L	F	Hatchback Engine G8DA/G8DB/G8DD/G8DE/G8DF	GDS18218	Drive Shaft	36	26	56	48	582						
	2004.11-			R	F	Hatchback Engine G8DA/G8DB/G8DD/G8DE/G8DF	GDS18219	Drive Shaft	36	26	56.3	48	921						
	2005.04-	2009.12				F	Saloon Engine G8DA/G8DB/G8DD/G8DE/G8DF	GC099288	Outer Joint	36	26	56.3	48	61	M				
	2005.04-	2009.12				F	Saloon Engine G8DA/G8DB/G8DD/G8DE/G8DF	GC018203	Outer Joint	36	23	56	48	57	I				
	2005.04-	2009.12		L	F	Saloon Engine G8DA/G8DB/G8DD/G8DE/G8DF	GDS18218	Drive Shaft	36	26	56	48	582						
	2005.04-	2009.12		R	F	Saloon Engine G8DA/G8DB/G8DD/G8DE/G8DF	GC018230	Outer Joint	36	26	56.3	48	61	M					
	2005.04-	2009.12		R	F	Saloon Engine G8DA/G8DB/G8DD/G8DE/G8DF	GDS18219	Drive Shaft	36	26	56.3	48	921						
	2005.05-	2008.03				F	Estate Engine G8DA/G8DB/G8DD/G8DE/G8DF	GC099288	Outer Joint	36	26	56.3	48	61	M				
	2005.05-	2008.03				F	Estate Engine G8DA/G8DB/G8DD/G8DE/G8DF	GC018203	Outer Joint	36	23	56	48	57	I				
	2005.05-	2008.03		L	F	Estate Engine G8DA/G8DB/G8DD/G8DE/G8DF	GDS18218	Drive Shaft	36	26	56	48	582						
	2005.05-	2008.03		R	F	Estate Engine G8DA/G8DB/G8DD/G8DE/G8DF	GC018230	Outer Joint	36	26	56.3	48	61	M					
	2005.05-	2008.03		R	F	Estate Engine G8DA/G8DB/G8DD/G8DE/G8DF	GDS18219	Drive Shaft	36	26	56.3	48	921						
1.6 TDCi (81 kW)	2007.12-		MT	L	F	Estate Engine G8DA	GDS18218	Drive Shaft	36	26	56	48	582						
	2007.12-		MT	R	F	Estate Engine G8DA	GDS18219	Drive Shaft	36	26	56.3	48	921						
1.6 TI (85 kW)	2005.01-	2008.05			F	Estate Engine HXDA/HXDB	GC018203	Outer Joint	36	23	56	48	57	I					
	2005.01-	2008.05			F	Hatchback Engine HXDA/HXDB	GC099288	Outer Joint	36	26	56.3	48	61	M					
	2005.01-	2008.05			F	Hatchback Engine HXDA/HXDB	GC018203	Outer Joint	36	23	56	48	57	I					
	2005.01-	2008.05	MT	L	F	Estate Engine HXDA/HXDB	GDS18189	Drive Shaft	36	23	56	48	601						
	2005.01-	2008.05	MT	L	F	Estate Engine HXDA/HXDB	GCI18168	Inner Joint	23	22	40	61	90						
	2005.01-	2008.05	MT	L	F	Estate Engine HXDA/HXDB	GC018264	Outer Joint	36	25	51.6	48	58	O					
	2005.01-	2008.05	MT	L	F	Hatchback Engine HXDA/HXDB	GDS18189	Drive Shaft	36	23	56	48	601						
	2005.01-	2008.05	MT	L	F	Hatchback Engine HXDA/HXDB	GCI18168	Inner Joint	23	22	40	61	90						
	2005.01-	2008.05	MT	L	F	Hatchback Engine HXDA/HXDB	GC018264	Outer Joint	36	25	51.6	48	58	O					
	2005.01-	2008.05	AT	R	F	Estate Engine HXDA/HXDB	GDS18190	Drive Shaft	36	26	56.3	48	919						
	2005.01-	2008.05	AT	R	F	Hatchback Engine HXDA/HXDB	GDS18190	Drive Shaft	36	26	56.3	48	919						
	2005.01-	2008.05	MT	R	F	Estate Engine HXDA/HXDB	GDS18206	Drive Shaft	36	23	56	48	906						
	2005.01-	2008.05	MT	R	F	Hatchback Engine HXDA/HXDB	GDS18206	Drive Shaft	36	23	56	48	906						
	2005.01-	2008.05		R	F	Estate Engine HXDA/HXDB	GDS18337	Drive Shaft	36	23	51.6	48	908						
	2005.01-	2008.05		R	F	Hatchback Engine HXDA/HXDB	GDS18337	Drive Shaft	36	23	51.6	48	908						
1.8 (92 kW)	2006.03-		5MT	L	F	Hatchback Engine QQDB	GDS18328	Drive Shaft	36	26	55.3	48	580						
	2006.03-		5MT	L	F	Hatchback Engine QQDB	GDS18359	Drive Shaft	36	23	56	48	594						
	2006.03-		5MT	L	F	Saloon Engine QQDB	GDS18328	Drive Shaft	36	26	55.3	48	580						
	2006.03-		5MT	L	F	Saloon Engine QQDB	GDS18359	Drive Shaft	36	23	56	48	594						
	2006.03-		5MT	R	F	Hatchback Engine QQDB	GDS18329	Drive Shaft	36	26	55.3	48	920						
	2006.03-		5MT	R	F	Hatchback Engine QQDB	GDS18358	Drive Shaft	36	23	56	48	899						
	2006.03-		5MT	R	F	Saloon Engine QQDB	GDS18329	Drive Shaft	36	26	55.3	48	920						
	2006.03-		5MT	R	F	Saloon Engine QQDB	GDS18358	Drive Shaft	36	23	56	48	899						
	2006.03-		MT	L	F	Hatchback Engine QQDB	GDS18189	Drive Shaft	36	23	56	48	601						
	2006.03-		MT	L	F	Saloon Engine QQDB	GDS18189	Drive Shaft	36	23	56	48	601						
	2006.03-		MT	R	F	Hatchback Engine QQDB	GDS18206	Drive Shaft	36	23	56	48	906						
	2006.03-		MT	R	F	Saloon Engine QQDB	GDS18206	Drive Shaft	36	23	56	48	906						
1.8 FlexFuel (92 kW)	2005.10-			L	F	Hatchback Engine Q7DA	GDS18359	Drive Shaft	36	23	56	48	594						
	2005.10-			R	F	Hatchback Engine Q7DA	GDS18358	Drive Shaft	36	23	56	48	899						
	2005.10-		MT	L	F	Hatchback Engine Q7DA	GDS18189	Drive Shaft	36	23	56	48	601						
	2005.10-		MT	R	F	Hatchback Engine Q7DA	GDS18206	Drive Shaft	36	23	56	48	906						
	2006.06-			L	F	Saloon Engine Q7DA	GDS18359	Drive Shaft	36	23	56	48	594						
	2006.06-			R	F	Saloon Engine Q7DA	GDS18358	Drive Shaft	36	23	56	48	899						
	2006.06-		MT	L	F	Saloon Engine Q7DA	GDS18189	Drive Shaft	36	23	56	48	601						
	2006.06-		MT	R	F	Saloon Engine Q7DA	GDS18206	Drive Shaft	36	23	56	48	906						
1.8 TDCi (85 kW)	2005.10-	2009.12			F	Saloon Engine KKDA/KKDB	GC099288	Outer Joint	36	26	56.3	48	61	M					
	2005.10-	2009.12			F	Saloon Engine KKDA/KKDB	GC099129	Outer Joint	36	24	56	48	57	M					
	2005.10-	2009.12		L	F	Saloon Engine KKDA/KKDB	GDS18218	Drive Shaft	36	26	56	48	582						
	2005.10-	2009.12		R	F	Saloon Engine KKDA/KKDB	GC018230	Outer Joint	36	26	56.3	48	61	M					
	2005.10-	2009.12		R	F	Saloon Engine KKDA/KKDB	GDS18219	Drive Shaft	36	26	56.3	48	921						

		TRANSM	L/R	F/R		G-AP Ref.	PRODUCT	ABS	Technical Specifications						
									YEAR	A	B	C	H	L	P
<b>FORD</b>															
<b>FOCUS II (DA_)</b>															
1.8 TDCi (85 kW)	2005.10-	2010.06			F	Hatchback Engine KKDA/KKDB	GC099288	Outer Joint	36	26	56.3	48	61	M	
	2005.10-	2010.06		L	F	Hatchback Engine KKDA/KKDB	GDS18218	Drive Shaft	36	26	56	48	582		
	2005.10-	2010.06		R	F	Hatchback Engine KKDA/KKDB	GC018230	Outer Joint	36	26	56.3	48	61	M	
	2005.10-	2010.06		R	F	Hatchback Engine KKDA/KKDB	GDS18219	Drive Shaft	36	26	56.3	48	921		
2.0 (104 kW)	2005.06-	2008.09	AT	R	F	Hatchback	GDS18190	Drive Shaft	36	26	56.3	48	919		
	2008.02-		AT	R	F	Saloon	GDS18190	Drive Shaft	36	26	56.3	48	919		
2.0 (105 kW)	2010.04-		AT	R	F	Hatchback	GDS18190	Drive Shaft	36	26	56.3	48	919		
2.0 (107 kW)	2005.01-				F	Hatchback Engine AODA/AODB	GC099288	Outer Joint	36	26	56.3	48	61	M	
	2005.01-		5AT	L	F	Hatchback Engine AODA/AODB	GDS18327	Drive Shaft	36	26	55.3	48	585		
	2005.01-		5MT	L	F	Hatchback Engine AODA/AODB	GDS18328	Drive Shaft	36	26	55.3	48	580		
	2005.01-		5AT	R	F	Hatchback Engine AODA/AODB	GDS34163	Drive Shaft	36	26	56	48	926		
	2005.01-		5MT	R	F	Hatchback Engine AODA/AODB	GDS18329	Drive Shaft	36	26	55.3	48	920		
	2005.01-		AT	R	F	Hatchback Engine AODA/AODB	GDS18190	Drive Shaft	36	26	56.3	48	919		
	2005.04-	2009.12			F	Saloon Engine AODA/AODB	GC099288	Outer Joint	36	26	56.3	48	61	M	
	2005.04-	2009.12	5AT	L	F	Saloon Engine AODA/AODB	GDS18327	Drive Shaft	36	26	55.3	48	585		
	2005.04-	2009.12	5MT	L	F	Saloon Engine AODA/AODB	GDS18328	Drive Shaft	36	26	55.3	48	580		
	2005.04-	2009.12	5AT	R	F	Saloon Engine AODA/AODB	GDS34163	Drive Shaft	36	26	56	48	926		
	2005.04-	2009.12	5MT	R	F	Saloon Engine AODA/AODB	GDS18329	Drive Shaft	36	26	55.3	48	920		
	2005.04-	2009.12	AT	R	F	Saloon Engine AODA/AODB	GDS18190	Drive Shaft	36	26	56.3	48	919		
2.0 CNG (107 kW)	2009.04-		AT	L	F	Hatchback Engine SYDA	GDS18327	Drive Shaft	36	26	55.3	48	585		
	2009.04-		MT	L	F	Hatchback Engine SYDA	GDS18328	Drive Shaft	36	26	55.3	48	580		
	2009.04-		AT	R	F	Hatchback Engine SYDA	GDS34163	Drive Shaft	36	26	56	48	926		
	2009.04-		MT	R	F	Hatchback Engine SYDA	GDS18329	Drive Shaft	36	26	55.3	48	920		
2.0 LPG (107 kW)	2008.06-		5AT	L	F	Estate Engine SYDA	GDS18327	Drive Shaft	36	26	55.3	48	585		
	2008.06-		5AT	L	F	Hatchback Engine SYDA	GDS18327	Drive Shaft	36	26	55.3	48	585		
	2008.06-		5MT	L	F	Estate Engine SYDA	GDS18328	Drive Shaft	36	26	55.3	48	580		
	2008.06-		5MT	L	F	Hatchback Engine SYDA	GDS18328	Drive Shaft	36	26	55.3	48	580		
	2008.06-		5AT	R	F	Estate Engine SYDA	GDS34163	Drive Shaft	36	26	56	48	926		
	2008.06-		5AT	R	F	Hatchback Engine SYDA	GDS34163	Drive Shaft	36	26	56	48	926		
	2008.06-		5MT	R	F	Estate Engine SYDA	GDS18329	Drive Shaft	36	26	55.3	48	920		
	2008.06-		5MT	R	F	Hatchback Engine SYDA	GDS18329	Drive Shaft	36	26	55.3	48	920		
	2008.06-		AT	R	F	Estate Engine SYDA	GDS18190	Drive Shaft	36	26	56.3	48	919		
	2008.06-		AT	R	F	Hatchback Engine SYDA	GDS18190	Drive Shaft	36	26	56.3	48	919		
2.0 TDCi (100 kW)	2005.04-	2009.12			F	Saloon Engine G6DA/G6DB/G6DD	GC099288	Outer Joint	36	26	56.3	48	61	M	
	2005.04-	2009.12			F	Saloon Engine G6DA/G6DB/G6DD	GC018203	Outer Joint	36	23	56	48	57	I	
	2005.04-	2009.12	MT	L	F	Saloon Engine G6DA/G6DB/G6DD	GDS18194	Drive Shaft	36	26	56	48	568		
2.0 TDCi (81 kW)	2008.07-	2009.12			F	Hatchback Engine IXDA	GC099288	Outer Joint	36	26	56.3	48	61	M	
	2008.07-	2009.12			F	Saloon Engine IXDA	GC099288	Outer Joint	36	26	56.3	48	61	M	
	2008.07-	2009.12	MT	L	F	Hatchback Engine IXDA	GDS18194	Drive Shaft	36	26	56	48	568		
	2008.07-	2009.12	MT	L	F	Saloon Engine IXDA	GDS18198	Drive Shaft	36	26	56	48	580		
	2008.07-	2009.12			L	F	Saloon Engine IXDA	GDS18194	Drive Shaft	36	26	56	48	568	
2.0 TDCi (98 kW)	2004.11-		MT	L	F	Hatchback Engine G6DF/G6DE	GDS18198	Drive Shaft	36	26	56	48	580		
	2004.11-			L	F	Hatchback Engine G6DF/G6DE	GDS18194	Drive Shaft	36	26	56	48	568		
	2004.11-		MT	R	F	Hatchback Engine G6DF/G6DE	GDS18280	Drive Shaft	36	26	56	48	918		
2.5 RS (224 kW)	2009.04-	2011.05				Hatchback Engine JZDA	GC059285	Outer Joint	40	27	57.4	52	63.5	M	
2.5 ST (166 kW)	2005.09-		MT	L	F	Hatchback Engine HYDA	GDS18290	Drive Shaft	36	26	56	48	530		
	2005.09-		MT	R	F	Hatchback Engine HYDA	GDS18251	Drive Shaft	36	26	56	48	960		
<b>FOCUS II CC</b>															
2.0 TDCi (107 kW)	2006-						GC018203	Outer Joint	36	23	56	48	57	I	
<b>FOCUS II STATION WAGON (DA_)</b>															
1.4 (59 kW)	2004.11-		MT	L	F	Estate Engine ASDA/ASDB	GDS18189	Drive Shaft	36	23	56	48	601		
	2004.11-		MT	L	F	Estate Engine ASDA/ASDB	GCI18168	Inner Joint	23	22	40	61	90		
	2004.11-		MT	L	F	Estate Engine ASDA/ASDB	GC018264	Outer Joint	36	25	51.6	48	58	O	
	2004.11-		MT	R	F	Estate Engine ASDA/ASDB	GDS18206	Drive Shaft	36	23	56	48	906		
	2004.11-			R	F	Estate Engine ASDA/ASDB	GDS18337	Drive Shaft	36	23	51.6	48	908		
	2004.11-				F	Estate Engine ASDA/ASDB	GC018203	Outer Joint	36	23	56	48	57	I	
1.6 (74 kW)	2005.01-				F	Estate Engine HWDA/HWDB/SHDA/SHDB/SHDC	GC018203	Outer Joint	36	23	56	48	57	I	
	2005.01-		MT	L	F	Estate Engine HWDA/HWDB/SHDA/SHDB/SHDC	GDS18189	Drive Shaft	36	23	56	48	601		
	2005.01-		MT	L	F	Estate Engine HWDA/HWDB/SHDA/SHDB/SHDC	GCI18168	Inner Joint	23	22	40	61	90		
	2005.01-		MT	L	F	Estate Engine HWDA/HWDB/SHDA/SHDB/SHDC	GC018264	Outer Joint	36	25	51.6	48	58	O	
	2005.01-		AT	R	F	Estate Engine HWDA/HWDB/SHDA/SHDB/SHDC	GDS18190	Drive Shaft	36	26	56.3	48	919		
	2005.01-		MT	R	F	Estate Engine HWDA/HWDB/SHDA/SHDB/SHDC	GDS18206	Drive Shaft	36	23	56	48	906		









		TRANSM	L/R	F/R		G-AP Ref.	PRODUCT	ABS	Technical Specifications													
									YEAR	A	B	C	H	L	P							
<b>FORD</b>																						
<b>FOCUS II STATION WAGON (DA_)</b>																						
1.6 (74 kW)	2005.01-			R	F	Estate Engine HWDA/HWDB/SHDA/SHDB/SHDC	GDS18337	Drive Shaft		36	23	51.6	48	908								
1.6 LPG (85 kW)	2009.10-				F	Estate Engine SIDA	GC099288	Outer Joint		36	26	56.3	48	61	M							
	2009.10-				F	Estate Engine SIDA	GC099129	Outer Joint		36	24	56	48	57	M							
1.6 TDCi (66 kW)	2005.10-	2010.06			F	Estate Engine GPDA/GPDC/HHDA/HHDB	GC099288	Outer Joint		36	26	56.3	48	61	M							
	2005.10-	2010.06			F	Estate Engine GPDA/GPDC/HHDA/HHDB	GC018203	Outer Joint		36	23	56	48	57	I							
	2005.10-	2010.06		L	F	Estate Engine GPDA/GPDC/HHDA/HHDB	GDS18218	Drive Shaft		36	26	56	48	582								
	2005.10-	2010.06		R	F	Estate Engine GPDA/GPDC/HHDA/HHDB	GC018230	Outer Joint		36	26	56.3	48	61	M							
	2005.10-	2010.06		R	F	Estate Engine GPDA/GPDC/HHDA/HHDB	GDS18219	Drive Shaft		36	26	56.3	48	921								
1.6 TI (85 kW)	2005.04-	2008.05			F	Saloon Engine HXDA/HXDB	GC099288	Outer Joint		36	26	56.3	48	61	M							
	2005.04-	2008.05			F	Saloon Engine HXDA/HXDB	GC018203	Outer Joint		36	23	56	48	57	I							
	2005.04-	2008.05	MT	L	F	Saloon Engine HXDA/HXDB	GDS18336	Drive Shaft		36	23	51.6	48	600								
	2005.04-	2008.05	MT	L	F	Saloon Engine HXDA/HXDB	GCI18168	Inner Joint		23	22	40	61	90								
	2005.04-	2008.05	MT	L	F	Saloon Engine HXDA/HXDB	GC018264	Outer Joint		36	25	51.6	48	58	O							
	2005.04-	2008.05		R	F	Saloon Engine HXDA/HXDB	GDS18337	Drive Shaft		36	23	51.6	48	908								
1.8 (92 kW)	2006.03-		5MT	L	F	Estate Engine Q7DA/QQDB	GDS18328	Drive Shaft		36	26	55.3	48	580								
	2006.03-		5MT	L	F	Estate Engine Q7DA/QQDB	GDS18359	Drive Shaft		36	23	56	48	594								
	2006.03-		5MT	R	F	Estate Engine Q7DA/QQDB	GDS18329	Drive Shaft		36	26	55.3	48	920								
	2006.03-		5MT	R	F	Estate Engine Q7DA/QQDB	GDS18358	Drive Shaft		36	23	56	48	899								
	2006.03-		MT	L	F	Estate Engine Q7DA/QQDB	GDS18189	Drive Shaft		36	23	56	48	601								
	2006.03-		MT	R	F	Estate Engine Q7DA/QQDB	GDS18206	Drive Shaft		36	23	56	48	906								
	2006.03-																					
1.8 FlexFuel (92 kW)	2005.10-	2008.03		L	F	Estate Engine Q7DA	GDS18359	Drive Shaft		36	23	56	48	594								
	2005.10-	2008.03	MT	L	F	Estate Engine Q7DA	GDS18189	Drive Shaft		36	23	56	48	601								
	2005.10-	2008.03		R	F	Estate Engine Q7DA	GDS18358	Drive Shaft		36	23	56	48	899								
	2005.10-	2008.03	MT	R	F	Estate Engine Q7DA	GDS18206	Drive Shaft		36	23	56	48	906								
1.8 TDCi (85 kW)	2005.10-	2010.06		L	F	Estate Engine KKDA/KKDB	GDS18218	Drive Shaft		36	26	56	48	582								
	2005.10-	2010.06		R	F	Estate Engine KKDA/KKDB	GC018230	Outer Joint		36	26	56.3	48	61	M							
	2005.10-	2010.06		R	F	Estate Engine KKDA/KKDB	GDS18219	Drive Shaft		36	26	56.3	48	921								
2.0 (107 kW)	2005.01-		5AT	L	F	Estate Engine AODA/AODB	GDS18327	Drive Shaft		36	26	55.3	48	585								
	2005.01-		5MT	L	F	Estate Engine AODA/AODB	GDS18328	Drive Shaft		36	26	55.3	48	580								
	2005.01-		5AT	R	F	Estate Engine AODA/AODB	GDS34163	Drive Shaft		36	26	56	48	926								
	2005.01-		5MT	R	F	Estate Engine AODA/AODB	GDS18329	Drive Shaft		36	26	55.3	48	920								
	2005.01-		AT	R	F	Estate Engine AODA/AODB	GDS18190	Drive Shaft		36	26	56.3	48	919								
2.0 TDCi (100 kW)	2005.01-				F	Estate Engine G6DA/G6DB/G6DD	GC018203	Outer Joint		36	23	56	48	57	I							
	2005.01-				F	Hatchback Engine G6DA/G6DB/G6DD	GC099288	Outer Joint		36	26	56.3	48	61	M							
	2005.01-				F	Hatchback Engine G6DA/G6DB/G6DD	GC018203	Outer Joint		36	23	56	48	57	I							
	2005.01-		MT	L	F	Estate Engine G6DA/G6DB/G6DD	GDS18198	Drive Shaft		36	26	56	48	580								
	2005.01-		MT	L	F	Hatchback Engine G6DA/G6DB/G6DD	GDS18194	Drive Shaft		36	26	56	48	568								
	2005.01-			L	F	Estate Engine G6DA/G6DB/G6DD	GDS18194	Drive Shaft		36	26	56	48	568								
2.0 TDCi (81 kW)	2008.07-	2009.12			F	Estate Engine IXDA	GC099288	Outer Joint		36	26	56.3	48	61	M							
	2008.07-	2009.12	MT	L	F	Estate Engine IXDA	GDS18198	Drive Shaft		36	26	56	48	580								
	2008.07-	2009.12		L	F	Estate Engine IXDA	GDS18194	Drive Shaft		36	26	56	48	568								
2.0 TDCi (98 kW)	2004.11-		MT	L	F	Estate Engine G6DF/G6DE	GDS18198	Drive Shaft		36	26	56	48	580								
	2004.11-			L	F	Estate Engine G6DF/G6DE	GDS18194	Drive Shaft		36	26	56	48	568								
	2004.11-		MT	R	F	Estate Engine G6DF/G6DE	GDS18280	Drive Shaft		36	26	56	48	918								
<b>FOCUS II SW</b>																						
1.4 (59 kW)	2005-	2008					GC018203	Outer Joint		36	23	56	48	57	I							
1.6 (74 kW)	2005-	2008					GC018203	Outer Joint		36	23	56	48	57	I							
1.6 TDCi (66 kW)	2005-	2008					GC018203	Outer Joint		36	23	56	48	57	I							
	2005-	2008					GC099288	Outer Joint		36	26	56.3	48	61	M							
1.6 TDCi (80 kW)	2005-	2008					GC018203	Outer Joint		36	23	56	48	57	I							
	2005-	2008					GC099288	Outer Joint		36	26	56.3	48	61	M							
1.6 TI (85 kW)	2005-	2008					GC018203	Outer Joint		36	23	56	48	57	I							
1.8 (92 kW)	2006.03-						GC018203	Outer Joint		36	23	56	48	57	I							
1.8 TDCi (85 kW)	2006.03-						GC018203	Outer Joint		36	23	56	48	57	I							
2.0 TDCi (100 kW)	2005-	2008					GC018203	Outer Joint		36	23	56	48	57	I							
<b>FOCUS III</b>																						
1.6 EcoBoost (110 kW)	2011.04-		MT	L	F	Hatchback Engine JQDA/JQDB	GDS18295	Drive Shaft		27	26	63	96	637								
	2011.04-		MT	L	F	Saloon Engine JQDA/JQDB	GDS18295	Drive Shaft		27	26	63	96	637								
	2011.04-		MT	R	F	Hatchback Engine JQDA/JQDB	GDS18294	Drive Shaft		27	26	63	96	972								
	2011.04-		MT	R	F	Saloon Engine JQDA/JQDB	GDS18294	Drive Shaft		27	26	63	96	972								
	2011.04-					Hatchback Engine JQDA/JQDB	GC018244	Outer Joint		27	24	62.8	95.5	59	M							
	2011.04-					Saloon Engine JQDA/JQDB	GC018244	Outer Joint		27	24	62.8	95.5	59	M							



	 YEAR	TRANSM	L/R	F/R		G-AP Ref.	PRODUCT	ABS	Technical Specifications										
									A	B	C	H	L	P					
<b>FORD FOCUS III</b>																			
1.6 EcoBoost (134 kW)	2011.04-		MT	L	F	Saloon Engine JTDA/JTDB	GDS18295	Drive Shaft		27	26	63	96	637					
	2011.04-			L	F	Hatchback Engine JTDA/JTDB	GDS18295	Drive Shaft		27	26	63	96	637					
	2011.04-		MT	R	F	Hatchback Engine JTDA/JTDB	GDS18294	Drive Shaft		27	26	63	96	972					
	2011.04-		MT	R	F	Saloon Engine JTDA/JTDB	GDS18294	Drive Shaft		27	26	63	96	972					
1.6 FlexFuel (88 kW)	2011.04-		AT	L	F	Hatchback Engine MUDA	GDS18296	Drive Shaft		27	34	63	96	606					
	2011.04-		AT	L	F	Saloon Engine MUDA	GDS18296	Drive Shaft		27	34	63	96	606					
	2011.04-		MT	L	F	Hatchback Engine MUDA	GDS18322	Drive Shaft		27	23	62.8	95.5	657					
	2011.04-		MT	L	F	Saloon Engine MUDA	GDS18322	Drive Shaft		27	23	62.8	95.5	657					
	2011.04-		MT	R	F	Hatchback Engine MUDA	GDS18323	Drive Shaft		27	23	62.8	95.5	961					
	2011.04-		MT	R	F	Saloon Engine MUDA	GDS18323	Drive Shaft		27	23	62.8	95.5	961					
	2011.04-					Hatchback Engine MUDA	GC018244	Outer Joint		27	24	62.8	95.5	59	M				
	2011.04-					Saloon Engine MUDA	GC018244	Outer Joint		27	24	62.8	95.5	59	M				
1.6 Flexifuel (110 kW)	2013.07-		MT	L	F	Saloon Engine YUDA	GDS18295	Drive Shaft		27	26	63	96	637					
	2013.07-		MT	R	F	Saloon Engine YUDA	GDS18294	Drive Shaft		27	26	63	96	972					
	2013.07-					Saloon Engine YUDA	GC018244	Outer Joint		27	24	62.8	95.5	59	M				
1.6 LPG (86 kW)	2012.02-		AT	L	F	Hatchback Engine MUDA	GDS18296	Drive Shaft		27	34	63	96	606					
	2012.02-		MT	L	F	Hatchback Engine MUDA	GDS18322	Drive Shaft		27	23	62.8	95.5	657					
	2012.02-		MT	R	F	Hatchback Engine MUDA	GDS18323	Drive Shaft		27	23	62.8	95.5	961					
	2012.02-					Hatchback Engine MUDA	GC018244	Outer Joint		27	24	62.8	95.5	59	M				
1.6 LPG (88 kW)	2012.02-		AT	L	F	Hatchback Engine MUDA	GDS18296	Drive Shaft		27	34	63	96	606					
	2012.02-		MT	L	F	Hatchback Engine MUDA	GDS18322	Drive Shaft		27	23	62.8	95.5	657					
	2012.02-		MT	R	F	Hatchback Engine MUDA	GDS18323	Drive Shaft		27	23	62.8	95.5	961					
	2012.02-					Hatchback Engine MUDA	GC018244	Outer Joint		27	24	62.8	95.5	59	M				
1.6 TDCi (70 kW)	2011.04-				F	Saloon Engine T3DA/T3DB	GC018240	Outer Joint		27	26	63	96	62.5	M				
	2011.04-					Hatchback Engine T3DA/T3DB	GC018240	Outer Joint		27	26	63	96	62.5	M				
1.6 TDCi (85 kW)	2011.04-					Hatchback Engine T1DA/T1DB	GC018240	Outer Joint		27	26	63	96	62.5	M				
	2011.04-					Saloon Engine T1DA/T1DB	GC018240	Outer Joint		27	26	63	96	62.5	M				
1.6 TDCi ECONetic (77 kW)	2012.05-					Hatchback Engine NGDA	GC018240	Outer Joint		27	26	63	96	62.5	M				
1.6 TI (63 kW)	2011.08-		MT	L	F	Hatchback Engine XTDA	GDS18322	Drive Shaft		27	23	62.8	95.5	657					
	2011.08-		MT	L	F	Saloon Engine XTDA	GDS18322	Drive Shaft		27	23	62.8	95.5	657					
	2011.08-		MT	R	F	Hatchback Engine XTDA	GDS18323	Drive Shaft		27	23	62.8	95.5	961					
	2011.08-		MT	R	F	Saloon Engine XTDA	GDS18323	Drive Shaft		27	23	62.8	95.5	961					
	2011.08-					Hatchback Engine XTDA	GC018244	Outer Joint		27	24	62.8	95.5	59	M				
	2011.08-					Saloon Engine XTDA	GC018244	Outer Joint		27	24	62.8	95.5	59	M				
1.6 TI (77 kW)	2011.04-		AT	L	F	Hatchback Engine IQDB	GDS18296	Drive Shaft		27	34	63	96	606					
	2011.04-		AT	L	F	Saloon Engine IQDB	GDS18296	Drive Shaft		27	34	63	96	606					
	2011.04-		MT	L	F	Hatchback Engine IQDB	GDS18322	Drive Shaft		27	23	62.8	95.5	657					
	2011.04-		MT	L	F	Saloon Engine IQDB	GDS18322	Drive Shaft		27	23	62.8	95.5	657					
	2011.04-		MT	R	F	Hatchback Engine IQDB	GDS18323	Drive Shaft		27	23	62.8	95.5	961					
	2011.04-		MT	R	F	Saloon Engine IQDB	GDS18323	Drive Shaft		27	23	62.8	95.5	961					
	2011.04-		MT			Hatchback Engine IQDB	GC018244	Outer Joint		27	24	62.8	95.5	59	M				
	2011.04-					Saloon Engine IQDB	GC018244	Outer Joint		27	24	62.8	95.5	59	M				
1.6 TI (92 kW)	2011.04-		AT	L	F	Hatchback Engine PNDA	GDS18296	Drive Shaft		27	34	63	96	606					
	2011.04-		AT	L	F	Saloon Engine PNDA	GDS18296	Drive Shaft		27	34	63	96	606					
	2011.04-		MT	L	F	Hatchback Engine PNDA	GDS18322	Drive Shaft		27	23	62.8	95.5	657					
	2011.04-		MT	L	F	Saloon Engine PNDA	GDS18322	Drive Shaft		27	23	62.8	95.5	657					
	2011.04-		MT	R	F	Hatchback Engine PNDA	GDS18323	Drive Shaft		27	23	62.8	95.5	961					
	2011.04-		MT	R	F	Saloon Engine PNDA	GDS18323	Drive Shaft		27	23	62.8	95.5	961					
	2011.04-					Hatchback Engine PNDA	GC018222	Outer Joint		25	23	53.3	87	56	M				
	2011.04-					Hatchback Engine PNDA	GC018244	Outer Joint		27	24	62.8	95.5	59	M				
	2011.04-					Saloon Engine PNDA	GC018222	Outer Joint		25	23	53.3	87	56	M				
	2011.04-					Saloon Engine PNDA	GC018244	Outer Joint		27	24	62.8	95.5	59	M				
2.0 ST (184 kW)	2012.07-		MT	L	F	Hatchback Engine R9DA	GDS18382	Drive Shaft		27	26	63.1	96	638					
	2012.07-		MT	R	F	Hatchback Engine R9DA	GDS18381	Drive Shaft		27	26	63.1	96	977					
2.0 TDCi (103 kW)	2011.04-		AT	R	F	Hatchback Engine UFDB	GDS18343	Drive Shaft		27	28	63.1	96	967					
	2011.04-		AT	R	F	Saloon Engine UFDB	GDS18343	Drive Shaft		27	28	63.1	96	967					
2.0 TDCi (120 kW)	2011.04-		AT	R	F	Hatchback Engine TXDB	GDS18343	Drive Shaft		27	28	63.1	96	967					
	2011.04-		AT	R	F	Saloon Engine TXDB	GDS18343	Drive Shaft		27	28	63.1	96	967					
	2011.04-					Hatchback Engine TXDB	GC018270	Outer Joint		27	26	62.8	91	64	M				
	2011.04-					Saloon Engine TXDB	GC018270	Outer Joint		27	26	62.8	91	64	M				
2.0 TDCi (85 kW)	2011.04-		AT	R	F	Hatchback Engine TYDA	GDS18343	Drive Shaft		27	28	63.1	96	967					
	2011.04-		AT	R	F	Saloon Engine TYDA	GDS18343	Drive Shaft		27	28	63.1	96	967					
	2011.04-					Hatchback Engine TYDA	GC018270	Outer Joint		27	26	62.8	91	64	M				

		TRANSM	L/R	F/R		G-AP Ref.	PRODUCT	ABS	Technical Specifications									
									YEAR	A	B	C	H	L	P			
<b>FORD</b>																		
<b>FOCUS III</b>																		
2.0 TDCi (85 kW)	2011.04-				Saloon Engine TYDA	GC018270	Outer Joint		27	26	62.8	91	64	M				
<b>FOCUS III TURNIER</b>																		
1.6 EcoBoost (110 kW)	2011.05-	MT	L	F	Estate Engine JQDA/JQDB	GDS18295	Drive Shaft		27	26	63	96	637					
	2011.05-	MT	R	F	Estate Engine JQDA/JQDB	GDS18294	Drive Shaft		27	26	63	96	972					
	2011.05-				Estate Engine JQDA/JQDB	GC018244	Outer Joint		27	24	62.8	95.5	59	M				
1.6 EcoBoost (134 kW)	2011.05-	MT	L	F	Estate Engine JTDA/JTDB	GDS18295	Drive Shaft		27	26	63	96	637					
	2011.05-	MT	R	F	Estate Engine JTDA/JTDB	GDS18294	Drive Shaft		27	26	63	96	972					
1.6 FlexFuel (88 kW)	2011.05-	AT	L	F	Estate Engine MUDA	GDS18296	Drive Shaft		27	34	63	96	606					
	2011.05-	MT	L	F	Estate Engine MUDA	GDS18322	Drive Shaft		27	23	62.8	95.5	657					
	2011.05-	MT	R	F	Estate Engine MUDA	GDS18323	Drive Shaft		27	23	62.8	95.5	961					
	2011.05-				Estate Engine MUDA	GC018244	Outer Joint		27	24	62.8	95.5	59	M				
1.6 Flexifuel (110 kW)	2013.07-	MT	L	F	Estate Engine YUDA	GDS18295	Drive Shaft		27	26	63	96	637					
	2013.07-	MT	R	F	Estate Engine YUDA	GDS18294	Drive Shaft		27	26	63	96	972					
	2013.07-				Estate Engine YUDA	GC018244	Outer Joint		27	24	62.8	95.5	59	M				
1.6 LPG (86 kW)	2012.02-	AT	L	F	Estate Engine MUDA	GDS18296	Drive Shaft		27	34	63	96	606					
	2012.02-	MT	L	F	Estate Engine MUDA	GDS18322	Drive Shaft		27	23	62.8	95.5	657					
	2012.02-	MT	R	F	Estate Engine MUDA	GDS18323	Drive Shaft		27	23	62.8	95.5	961					
	2012.02-				Estate Engine MUDA	GC018244	Outer Joint		27	24	62.8	95.5	59	M				
1.6 LPG (88 kW)	2012.02-	AT	L	F	Estate Engine MUDA	GDS18296	Drive Shaft		27	34	63	96	606					
	2012.02-	MT	L	F	Estate Engine MUDA	GDS18322	Drive Shaft		27	23	62.8	95.5	657					
	2012.02-	MT	R	F	Estate Engine MUDA	GDS18323	Drive Shaft		27	23	62.8	95.5	961					
	2012.02-				Estate Engine MUDA	GC018244	Outer Joint		27	24	62.8	95.5	59	M				
1.6 TDCi (70 kW)	2011.05-				Estate Engine T3DA/T3DB	GC018240	Outer Joint		27	26	63	96	62.5	M				
1.6 TDCi (85 kW)	2011.05-			F	Estate Engine T1DA/T1DB	GC018240	Outer Joint		27	26	63	96	62.5	M				
1.6 TDCi ECOnetic (77 kW)	2012.05-				Estate Engine NGDA	GC018240	Outer Joint		27	26	63	96	62.5	M				
1.6 Ti (63 kW)	2011.08-	MT	L	F	Estate Engine XTDA	GDS18322	Drive Shaft		27	23	62.8	95.5	657					
	2011.08-	MT	R	F	Estate Engine XTDA	GDS18323	Drive Shaft		27	23	62.8	95.5	961					
	2011.08-				Estate Engine XTDA	GC018244	Outer Joint		27	24	62.8	95.5	59	M				
1.6 Ti (77 kW)	2011.05-	AT	L	F	Estate Engine IQDB	GDS18296	Drive Shaft		27	34	63	96	606					
	2011.05-	MT	L	F	Estate Engine IQDB	GDS18322	Drive Shaft		27	23	62.8	95.5	657					
	2011.05-	MT	R	F	Estate Engine IQDB	GDS18323	Drive Shaft		27	23	62.8	95.5	961					
	2011.05-				Estate Engine IQDB	GC018244	Outer Joint		27	24	62.8	95.5	59	M				
1.6 Ti (92 kW)	2011.05-	AT	L	F	Estate Engine PNDA	GDS18296	Drive Shaft		27	34	63	96	606					
	2011.05-	MT	L	F	Estate Engine PNDA	GDS18322	Drive Shaft		27	23	62.8	95.5	657					
	2011.05-	MT	R	F	Estate Engine PNDA	GDS18323	Drive Shaft		27	23	62.8	95.5	961					
	2011.05-				Estate Engine PNDA	GC018222	Outer Joint		25	23	53.3	87	56	M				
	2011.05-				Estate Engine PNDA	GC018244	Outer Joint		27	24	62.8	95.5	59	M				
2.0 ST (184 kW)	2012.07-	MT	L	F	Estate Engine R9DA	GDS18382	Drive Shaft		27	26	63.1	96	638					
	2012.07-	MT	R	F	Estate Engine R9DA	GDS18381	Drive Shaft		27	26	63.1	96	977					
2.0 TDCi (103 kW)	2011.05-	AT	R	F	Estate Engine UFDB	GDS18343	Drive Shaft		27	28	63.1	96	967					
2.0 TDCi (120 kW)	2011.05-	AT	R	F	Estate Engine TXDB	GDS18343	Drive Shaft		27	28	63.1	96	967					
	2011.05-				Estate Engine TXDB	GC018270	Outer Joint		27	26	62.8	91	64	M				
2.0 TDCi (85 kW)	2011.05-	AT	R	F	Estate Engine TYDA	GDS18343	Drive Shaft		27	28	63.1	96	967					
	2011.05-				Estate Engine TYDA	GC018270	Outer Joint		27	26	62.8	91	64	M				
<b>FOCUS III, SW</b>																		
1.6 TDCi (66 kW)	2008-		L			GC099288	Outer Joint		36	26	56.3	48	61	M				
1.6 TDCi (80 kW)	2008-		L			GC099288	Outer Joint		36	26	56.3	48	61	M				
1.6 TI LPG (85 kW)	2008-	MT				GC099288	Outer Joint		36	26	56.3	48	61	M				
1.8 (92 kW)	2008-					GC099288	Outer Joint		36	26	56.3	48	61	M				
1.8 TDCi (85 kW)	2008-		L			GC099288	Outer Joint		36	26	56.3	48	61	M				
2.0 TDCi (100 kW)	2008-	MT				GC099288	Outer Joint		36	26	56.3	48	61	M				
2.0 TDCi (81 kW)	2008-	MT				GC099288	Outer Joint		36	26	56.3	48	61	M				
<b>FUSION (JU)</b>																		
1.4 TDCi (50 kW)	2002.08-					GC018001	Outer Joint		25	20	52.9	89	52	M				
1.6 (74 kW)	2002.08-					GC018003	Outer Joint		25	21	53.3	89	53	M				
<b>FUSION (JU_)</b>																		
1.4 (59 kW)	2002.08-			F	Estate Engine FXJA/FXJB/FXJC	GC018009	Outer Joint		25	22	53.3	90	51	M				
	2002.08-		L	F	Estate Engine FXJA/FXJB/FXJC	GDS18202	Drive Shaft		25	23	53	88	620					
	2002.08-		R	F	Estate Engine FXJA/FXJB/FXJC	GDS18201	Drive Shaft		25	23	53.3	90	919					
1.4 TDCi (50 kW)	2002.08-			F	Estate Engine F6JA/F6JB	GC018001	Outer Joint		25	20	52.9	89	52	M				
	2002.08-	MT	L	F	Estate Engine F6JA/F6JB	GDS18216	Drive Shaft		25	23	53.3	90	621					
	2002.08-	MT	R	F	Estate Engine F6JA/F6JB	GDS18217	Drive Shaft		25	23	52.9	89	916					









		TRANSM	L/R	F/R		G-AP Ref.	PRODUCT	ABS	Technical Specifications								
									YEAR	A	B	C	H	L	P		
<b>FORD</b>																	
<b>FUSION (JU_)</b>																	
1.4 TDCi (50 kW)	2002.08-			L	F	Estate Engine F6JA/F6JB	GDS18202	Drive Shaft		25	23	53	88	620			
	2002.08-			R	F	Estate Engine F6JA/F6JB	GDS18201	Drive Shaft		25	23	53.3	90	919			
1.6 (74 kW)	2002.08-				F	Estate Engine FYJA/FYJB	GC018014	Outer Joint		25	21	53.2	89	54	M		
	2002.08-		AT	L	F	Estate Engine FYJA/FYJB	GDS18351	Drive Shaft		25	22	53.3	89	606			
	2002.08-		AT	R	F	Estate Engine FYJA/FYJB	GDS18333	Drive Shaft		25	22	53.3	89	930			
	2002.08-		MT	L	F	Estate Engine FYJA/FYJB	GDS18202	Drive Shaft		25	23	53	88	620			
	2002.08-			R	F	Estate Engine FYJA/FYJB	GDS18201	Drive Shaft		25	23	53.3	90	919			
1.6 TDCi (66 kW)	2004.11-	2007.03	MT	L	F	Estate Engine HHJA/HHJB	GDS18309	Drive Shaft		25	23	52.9	89	615			
	2004.11-	2007.03		L	F	Estate Engine HHJA/HHJB	GDS18202	Drive Shaft		25	23	53	88	620			
	2004.11-	2007.03	MT	R	F	Estate Engine HHJA/HHJB	GDS18326	Drive Shaft		25	23	53.38	88.5	915			
	2004.11-	2007.03		R	F	Estate Engine HHJA/HHJB	GDS18201	Drive Shaft		25	23	53.3	90	919			
	2004.11-	2007.03				Estate Engine HHJA/HHJB	GC018222	Outer Joint		25	23	53.3	87	56	M		
<b>GALAXY</b>																	
-	2000.04-	2006.05					GDS61193	Stub Shaft		37		60		322			
	2000.04-	2006.05					GDS61192	Stub Shaft		26	37	60		129.5			
1.6 TDCi (85 kW)	2011.02-		MT	L	F	MPV Engine T1WA/T1WB	GDS99211	Drive Shaft		40	26	57.4	51	603			
	2011.02-		MT	L	F	MPV Engine T1WA/T1WB	GCI18128	Inner Joint		26	28	40	68.5	111			
	2011.02-		MT	L/R	F	MPV Engine T1WA/T1WB	GC099271	Outer Joint		40	28	57.4	51	63	M		
	2011.02-		MT	R	F	MPV Engine T1WA/T1WB	GDS99212	Drive Shaft		40	26	57.4	51	945			
	2011.02-		MT	R	F	MPV Engine T1WA/T1WB	GCI18129	Inner Joint		26	28	40	389	96.5			
1.8 TDCi (74 kW)	2006.05-		MT	L	F	MPV Engine FFWA	GDS99211	Drive Shaft		40	26	57.4	51	603			
	2006.05-		MT	L	F	MPV Engine FFWA	GCI18128	Inner Joint		26	28	40	68.5	111			
	2006.05-		MT	L/R	F	MPV Engine FFWA	GC099271	Outer Joint		40	28	57.4	51	63	M		
	2006.05-		MT	R	F	MPV Engine FFWA	GDS99212	Drive Shaft		40	26	57.4	51	945			
	2006.05-		MT	R	F	MPV Engine FFWA	GCI18129	Inner Joint		26	28	40	389	96.5			
1.8 TDCi (92 kW)	2006.05-		MT	L	F	MPV Engine QYWA	GDS99211	Drive Shaft		40	26	57.4	51	603			
	2006.05-		MT	L	F	MPV Engine QYWA	GCI18128	Inner Joint		26	28	40	68.5	111			
	2006.05-		MT	L/R	F	MPV Engine QYWA	GC099271	Outer Joint		40	28	57.4	51	63	M		
	2006.05-		MT	R	F	MPV Engine QYWA	GDS99212	Drive Shaft		40	26	57.4	51	945			
	2006.05-		MT	R	F	MPV Engine QYWA	GCI18129	Inner Joint		26	28	40	389	96.5			
1.9 TD	1995.06-	2000.08	MT	L			GDS83024	Drive Shaft	48W	38	26	60	34.5	617			
	1995.06-	2000.08	MT	R			GDS83027	Drive Shaft	48W	38	35	60	34.5	561			
	1995.06-	2000.08	MT	L			GDS83064	Drive Shaft		38	26	60	34.5	617			
1.9 TDi	1995.06-	2000.08	MT				GC018040	Outer Joint		38	27	60	34.5	65	I		
	1997.11-	2000.08	AT				GC018040	Outer Joint		38	27	60	34.5	65	I		
2.0	1995.06-	1999.02					GC018040	Outer Joint		38	27	60	34.5	65	I		
	1995.06-	1999.02	MT	L			GDS83024	Drive Shaft	48W	38	26	60	34.5	617			
	1995.06-	1999.02	MT	R			GDS83027	Drive Shaft	48W	38	35	60	34.5	561			
	1995.06-	1999.02	MT	L			GDS83064	Drive Shaft		38	26	60	34.5	617			
2.0 (107 kW)	2006.05-		MT	L	F	MPV Engine AOWA/AOWB	GDS99211	Drive Shaft		40	26	57.4	51	603			
	2006.05-		MT	L	F	MPV Engine AOWA/AOWB	GCI18128	Inner Joint		26	28	40	68.5	111			
	2006.05-		MT	L	F	MPV Engine AOWA/AOWB	GC099271	Outer Joint		40	28	57.4	51	63	M		
2.0 EcoBoost (149 kW)	2010.03-		AT	L	F	MPV Engine TNWA	GDS18340	Drive Shaft		40	28	57.4	52	592			
	2010.03-		AT	R	F	MPV Engine TNWA	GDS18341	Drive Shaft		40	28	57.4	52	952			
	2010.03-		AT			MPV Engine TNWA	GC059344	Outer Joint		40	26	57.4	52	63.5	M		
2.0 TDCi (100 kW)	2006.05-		AT	L	F	MPV Engine AZWC/UKWA	GDS83288	Drive Shaft		40	31	57.4	51	582			
	2006.05-		MT	L	F	MPV Engine AZWC/UKWA	GDS99211	Drive Shaft		40	26	57.4	51	603			
	2006.05-		MT	L	F	MPV Engine AZWC/UKWA	GCI18128	Inner Joint		26	28	40	68.5	111			
	2006.05-		MT	L/R	F	MPV Engine AZWC/UKWA	GC099271	Outer Joint		40	28	57.4	51	63	M		
	2006.05-		AT	R	F	MPV Engine AZWC/UKWA	GDS83289	Drive Shaft		40	28	57.4	51	932			
	2006.05-		MT	R	F	MPV Engine AZWC/UKWA	GDS99212	Drive Shaft		40	26	57.4	51	945			
	2006.05-		MT	R	F	MPV Engine AZWC/UKWA	GCI18129	Inner Joint		26	28	40	389	96.5			
	2006.05-		AT			MPV Engine AZWC/UKWA	GC059344	Outer Joint		40	26	57.4	52	63.5	M		
2.0 TDCi (103 kW)	2006.05-		AT	L	F	MPV Engine QXWA/QXWB/QXWC/UFWA	GDS83288	Drive Shaft		40	31	57.4	51	582			
	2006.05-		MT	L	F	MPV Engine QXWA/QXWB/QXWC/UFWA	GDS99211	Drive Shaft		40	26	57.4	51	603			
	2006.05-		MT	L	F	MPV Engine QXWA/QXWB/QXWC/UFWA	GCI18128	Inner Joint		26	28	40	68.5	111			
	2006.05-		MT	L/R	F	MPV Engine QXWA/QXWB/QXWC/UFWA	GC099271	Outer Joint		40	28	57.4	51	63	M		
	2006.05-		AT	R	F	MPV Engine QXWA/QXWB/QXWC/UFWA	GDS83289	Drive Shaft		40	28	57.4	51	932			
	2006.05-		MT	R	F	MPV Engine QXWA/QXWB/QXWC/UFWA	GDS99212	Drive Shaft		40	26	57.4	51	945			
	2006.05-		MT	R	F	MPV Engine QXWA/QXWB/QXWC/UFWA	GCI18129	Inner Joint		26	28	40	389	96.5			
	2006.05-		AT			MPV Engine QXWA/QXWB/QXWC/UFWA	GC059344	Outer Joint		40	26	57.4	52	63.5	M		
2.0 TDCi (120 kW)	2010.03-		AT	L	F	MPV Engine TXWA	GDS83288	Drive Shaft		40	31	57.4	51	582			



		TRANSM	L/R	F/R		G-AP Ref.	PRODUCT	ABS	Technical Specifications									
									YEAR	A	B	C	H	L	P			
<b>FORD GALAXY</b>																		
2.0 TDCi (120 kW)	2010.03-		MT	L	F	MPV Engine TXWA	GDS99211	Drive Shaft		40	26	57.4	51	603				
	2010.03-		MT	L	F	MPV Engine TXWA	GCI18128	Inner Joint		26	28	40	68.5	111				
	2010.03-		MT	L/R	F	MPV Engine TXWA	GC099271	Outer Joint		40	28	57.4	51	63	M			
	2010.03-		AT	R	F	MPV Engine TXWA	GDS83289	Drive Shaft		40	28	57.4	51	932				
	2010.03-		MT	R	F	MPV Engine TXWA	GDS99212	Drive Shaft		40	26	57.4	51	945				
	2010.03-		MT	R	F	MPV Engine TXWA	GCI18129	Inner Joint		26	28	40	389	96.5				
	2010.03-		AT			MPV Engine TXWA	GC059344	Outer Joint		40	26	57.4	52	63.5	M			
2.0 TDCi (85 kW)	2007.11-		MT	L	F	MPV Engine KLWA/TYWA	GDS99211	Drive Shaft		40	26	57.4	51	603				
	2007.11-		MT	L	F	MPV Engine KLWA/TYWA	GCI18128	Inner Joint		26	28	40	68.5	111				
	2007.11-		MT	L/R	F	MPV Engine KLWA/TYWA	GC099271	Outer Joint		40	28	57.4	51	63	M			
	2007.11-		MT	R	F	MPV Engine KLWA/TYWA	GDS99212	Drive Shaft		40	26	57.4	51	945				
	2007.11-		MT	R	F	MPV Engine KLWA/TYWA	GCI18129	Inner Joint		26	28	40	389	96.5				
2.0 TDCi (96 kW)	2007.05-2008.03		MT	L/R	F	MPV Engine AZWA	GC099271	Outer Joint		40	28	57.4	51	63	M			
	2007.05-2008.03		AT	R	F	MPV Engine AZWA	GDS83289	Drive Shaft		40	28	57.4	51	932				
	2007.05-2008.03		MT	R	F	MPV Engine AZWA	GDS99212	Drive Shaft		40	26	57.4	51	945				
	2007.05-2008.03		MT	R	F	MPV Engine AZWA	GCI18129	Inner Joint		26	28	40	389	96.5				
	2007.05-2008.03		AT			MPV Engine AZWA	GC059344	Outer Joint		40	26	57.4	52	63.5	M			
	2007.05-2008.03		AT	L	F	MPV Engine AZWA	GDS83288	Drive Shaft		40	31	57.4	51	582				
	2007.05-2008.03		MT	L	F	MPV Engine AZWA	GDS99211	Drive Shaft		40	26	57.4	51	603				
	2007.05-2008.03		MT	L	F	MPV Engine AZWA	GCI18128	Inner Joint		26	28	40	68.5	111				
2.2 TDCi (129 kW)	2008.03-		MT	L	F	MPV Engine Q4BA/Q4WA	GDS18363	Drive Shaft		40	31	57.4	52	588.5				
	2008.03-		MT	R	F	MPV Engine Q4BA/Q4WA	GDS18350	Drive Shaft		40	28	57.4	52	963				
2.2 TDCi (147 kW)	2010.07-		MT	L	F	MPV Engine KNWA	GDS18363	Drive Shaft		40	31	57.4	52	588.5				
	2010.07-		MT	R	F	MPV Engine KNWA	GDS18350	Drive Shaft		40	28	57.4	52	963				
2.3	1997.01-2000.08					GC018040	Outer Joint		38	27	60	34.5	65	I				
2.3 (118 kW)	2007.08-2008.03		AT	R	F	MPV Engine SEWA	GDS61106	Drive Shaft		40	31	57.4	51	945				
2.8 V6	1995.06-2000.08					GC018040	Outer Joint		38	27	60	34.5	65	I				
<b>GALAXY (WGR)</b>																		
1.9 TDi (110 kW)	2005.01-2006.03				F	MPV Engine BTB	GC018025	Outer Joint	48W	38	36	60	34	72.5	I			
	2005.01-2006.03			L/R	F	MPV Engine BTB	GDS83023	Drive Shaft	48W	38		60	34	507				
	2005.01-2006.03		6MT			MPV Engine BTB	GDS61192	Stub Shaft		26	37	60		129.5				
	2005.01-2006.03		6MT			MPV Engine BTB	GDS61193	Stub Shaft		37		60		322				
1.9 TDi (66 kW)	1995.03-2006.05				F	MPV Engine 1Z/AHU/ANU	GC018025	Outer Joint	48W	38	36	60	34	72.5	I			
	1995.03-2006.05		MT/6MT		F	MPV Engine 1Z/AHU/ANU	GCI61044	Inner Joint			34		85					
	1995.03-2006.05		MT/AT		F	MPV Engine 1Z/AHU/ANU	GC018026	Outer Joint	48W	38	27	60	34.5	65	I			
	1995.03-2006.05		MT	L	F	MPV Engine 1Z/AHU/ANU	GCI99053	Inner Joint		26	28	40	77.5	82.5				
	1995.03-2006.05		MT	L	F	MPV Engine 1Z/AHU/ANU	GDS18009	Drive Shaft	48W	38	26	60	34.5	620				
	1995.03-2006.05		MT	L/R	F	MPV Engine 1Z/AHU/ANU	GDS83023	Drive Shaft	48W	38		60	34	507				
	1995.03-2006.05			L/R	F	MPV Engine 1Z/AHU/ANU	GDS61087	Drive Shaft	48W	38		60	34.5	506				
	1995.03-2006.05			L/R	F	MPV Engine 1Z/AHU/ANU	GCI61032	Inner Joint			27		34					
	1995.03-2006.05			L/R	F	MPV Engine 1Z/AHU/ANU	GC061022	Outer Joint		38	27	60	34.5	65	M			
	1995.03-2006.05		MT	R	F	MPV Engine 1Z/AHU/ANU	GDS83065	Drive Shaft		38	35	60	34.5	561				
	1995.03-2006.05		MT	R	F	MPV Engine 1Z/AHU/ANU	GCI61028	Inner Joint		35	28	42	48	52				
	1995.03-2006.05		MT	R	F	MPV Engine 1Z/AHU/ANU	GDS18008	Drive Shaft	48W	38	35	60	34.5	559				
	1995.03-2006.05		6MT			MPV Engine 1Z/AHU/ANU	GDS61192	Stub Shaft		26	37	60		129.5				
1995.03-2006.05		6MT			MPV Engine 1Z/AHU/ANU	GDS61193	Stub Shaft		37		60		322					
1.9 TDi (81 kW)	1997.08-2000.04		6MT			MPV Engine AFN/AVG	GDS61192	Stub Shaft		26	37	60		129.5				
	1997.08-2000.04		6MT			MPV Engine AFN/AVG	GDS61193	Stub Shaft		37		60		322				
1.9 TDi (85 kW)	2000.04-2006.05				F	MPV Engine AUY	GC018025	Outer Joint	48W	38	36	60	34	72.5	I			
	2000.04-2006.05		MT/AT		F	MPV Engine AUY	GCI61044	Inner Joint			34		85					
	2000.04-2006.05		5AT	L/R	F	MPV Engine AUY	GC018039	Outer Joint		38	36	60	34	72.5	I			
	2000.04-2006.05		5AT	L/R	F	MPV Engine AUY	GDS83022	Drive Shaft	48W	38		60	34	486				
	2000.04-2006.05		MT	L/R	F	MPV Engine AUY	GDS83023	Drive Shaft	48W	38		60	34	507				
	2000.04-2006.05		6MT			MPV Engine AUY	GDS61192	Stub Shaft		26	37	60		129.5				
	2000.04-2006.05		6MT			MPV Engine AUY	GDS61193	Stub Shaft		37		60		322				
1.9 TDi (96 kW)	2002.12-2006.03				F	MPV Engine ASZ	GC018025	Outer Joint	48W	38	36	60	34	72.5	I			
	2002.12-2006.03		MT/AT		F	MPV Engine ASZ	GCI61044	Inner Joint			34		85					
	2002.12-2006.03		MT	L/R	F	MPV Engine ASZ	GDS83023	Drive Shaft	48W	38		60	34	507				
	2002.12-2006.03		6MT			MPV Engine ASZ	GDS61192	Stub Shaft		26	37	60		129.5				
	2002.12-2006.03		6MT			MPV Engine ASZ	GDS61193	Stub Shaft		37		60		322				
2.0 i (85 kW)	1995.11-2006.05		AT		F	MPV Engine NSE/ZVSA	GCI61044	Inner Joint			34		85					
	1995.11-2006.05		MT/AT		F	MPV Engine NSE/ZVSA	GC018026	Outer Joint	48W	38	27	60	34.5	65	I			

	 YEAR	TRANSM	L/R	F/R		G-AP Ref.	PRODUCT	ABS	Technical Specifications						
									A	B	C	H	L	P	
<b>FORD GALAXY (WGR)</b>															
2.0 i (85 kW)	1995.11-2006.05		AT	L	F	MPV Engine NSE/ZVSA	GDS61085	Drive Shaft	48W	38		60	34.5	513	
	1995.11-2006.05		MT	L	F	MPV Engine NSE/ZVSA	GCI99053	Inner Joint		26	28	40	77.5	82.5	
	1995.11-2006.05		MT	L	F	MPV Engine NSE/ZVSA	GDS18009	Drive Shaft	48W	38	26	60	34.5	620	
	1995.11-2006.05		AT	R	F	MPV Engine NSE/ZVSA	GDS61104	Drive Shaft	48W	38		60	34	544	
	1995.11-2006.05		AT	R	F	MPV Engine NSE/ZVSA	GCI50019	Inner Joint			34		59.5		
	1995.11-2006.05		AT	R	F	MPV Engine NSE/ZVSA	GC018025	Outer Joint	48W	38	36	60	34	72.5	I
	1995.11-2006.05		AT	R	F	MPV Engine NSE/ZVSA	GDS61065	Drive Shaft	48W	38		60	34.5	544	
	1995.11-2006.05		MT	R	F	MPV Engine NSE/ZVSA	GCI61028	Inner Joint		35	28	42	48	52	
	1995.11-2006.05		MT	R	F	MPV Engine NSE/ZVSA	GDS18008	Drive Shaft	48W	38	35	60	34.5	559	
	1995.11-2006.05		6MT			MPV Engine NSE/ZVSA	GDS61192	Stub Shaft		26	37	60		129.5	
1995.11-2006.05		6MT			MPV Engine NSE/ZVSA	GDS61193	Stub Shaft		37		60		322		
2.3 16V (103 kW)	2001.09-2006.03				F	MPV Engine E5SB	GC018025	Outer Joint	48W	38	36	60	34	72.5	I
	2001.09-2006.03		AT	R	F	MPV Engine E5SB	GDS61104	Drive Shaft	48W	38		60	34	544	
	2001.09-2006.03		AT	R	F	MPV Engine E5SB	GCI50019	Inner Joint			34		59.5		
	2001.09-2006.03		AT	R	F	MPV Engine E5SB	GC018025	Outer Joint	48W	38	36	60	34	72.5	I
	2001.09-2006.03		6MT			MPV Engine E5SB	GDS61192	Stub Shaft		26	37	60		129.5	
	2001.09-2006.03		6MT			MPV Engine E5SB	GDS61193	Stub Shaft		37		60		322	
2.3 16V (107 kW)	1997.01-2006.05	MT/AT			F	MPV Engine E5SA/Y5B	GC018026	Outer Joint	48W	38	27	60	34.5	65	I
	1997.01-2006.05			L	F	MPV Engine E5SA/Y5B	GDS18009	Drive Shaft	48W	38	26	60	34.5	620	
	1997.01-2006.05			L	F	MPV Engine E5SA/Y5B	GDS61085	Drive Shaft	48W	38		60	34.5	513	
	1997.01-2006.05			L	F	MPV Engine E5SA/Y5B	GCI99053	Inner Joint		26	28	40	77.5	82.5	
	1997.01-2006.05			R	F	MPV Engine E5SA/Y5B	GDS18008	Drive Shaft	48W	38	35	60	34.5	559	
	1997.01-2006.05			R	F	MPV Engine E5SA/Y5B	GDS61065	Drive Shaft	48W	38		60	34.5	544	
	1997.01-2006.05	MT	R	F		MPV Engine E5SA/Y5B	GDS83065	Drive Shaft		38	35	60	34.5	561	
	1997.01-2006.05		R	F		MPV Engine E5SA/Y5B	GCI61028	Inner Joint		35	28	42	48	52	
	1997.01-2006.05	6MT				MPV Engine E5SA/Y5B	GDS61192	Stub Shaft		26	37	60		129.5	
	1997.01-2006.05	6MT				MPV Engine E5SA/Y5B	GDS61193	Stub Shaft		37		60		322	
2.8 i V6 (128 kW)	1995.11-2000.04	6MT				MPV Engine AAA/AMY	GDS61192	Stub Shaft		26	37	60		129.5	
	1995.11-2000.04	6MT				MPV Engine AAA/AMY	GDS61193	Stub Shaft		37		60		322	
	1995.11-2000.04	AT	L/R	F		MPV Engine AAA/AMY	GDS18010	Drive Shaft	48W	38		60	34.5	550	
2.8 i V6 4x4 (128 kW)	1996.04-2000.04	AT	L/R	F		MPV Engine AAA/AMY	GDS18010	Drive Shaft	48W	38		60	34.5	550	
2.8 V6 (150 kW)	2000.04-2006.05				F	MPV Engine AYL	GC018025	Outer Joint	48W	38	36	60	34	72.5	I
	2000.04-2006.05	MT/AT			F	MPV Engine AYL	GCI61044	Inner Joint			34		85		
	2000.04-2006.05	5AT	L	F		MPV Engine AYL	GC018039	Outer Joint		38	36	60	34	72.5	I
	2000.04-2006.05	5AT	L	F		MPV Engine AYL	GDS83022	Drive Shaft	48W	38		60	34	486	
	2000.04-2006.05	MT	L/R	F		MPV Engine AYL	GDS83023	Drive Shaft	48W	38		60	34	507	
	2000.04-2006.05	5AT	R	F		MPV Engine AYL	GDS99120	Drive Shaft	48W	38	30	60	34	561	
	2000.04-2006.05	6MT				MPV Engine AYL	GDS61192	Stub Shaft		26	37	60		129.5	
	2000.04-2006.05	6MT				MPV Engine AYL	GDS61193	Stub Shaft		37		60		322	
<b>GALAXY I (VX, WGR, VY)</b>															
1.9 TDi (66 kW)	1995.02-2000.04				L	Europe	GCI99053	Inner Joint		26	28	40	77.5	82.5	
	1995.02-2000.04				R		GCI61028	Inner Joint		35	28	42	48	52	
1.9 TDi (81 kW)	1995.02-2000.04				L	Europe	GCI99053	Inner Joint		26	28	40	77.5	82.5	
	1995.02-2000.04				R		GCI61028	Inner Joint		35	28	42	48	52	
2.0 (85 kW)	1995.02-2000.04				L	Europe	GCI99053	Inner Joint		26	28	40	77.5	82.5	
	1995.02-2000.04				R		GCI61028	Inner Joint		35	28	42	48	52	
2.3 16V (107 kW)	1996.09-2000.04				L	Europe	GCI99053	Inner Joint		26	28	40	77.5	82.5	
	1996.09-2000.04				R		GCI61028	Inner Joint		35	28	42	48	52	
<b>GALAXY II</b>															
1.8 TDCi (74 kW)	2006.04-2010.03				L		GCI18128	Inner Joint		26	28	40	68.5	111	
	2006.04-2010.03				R		GCI18129	Inner Joint		26	28	40	389	96.5	
1.8 TDCi (92 kW)	2006.04-2010.03				L		GCI18128	Inner Joint		26	28	40	68.5	111	
	2006.04-2010.03				R		GCI18129	Inner Joint		26	28	40	389	96.5	
2.0 16V (107 kW)	2006.04-2010.03				L		GCI18128	Inner Joint		26	28	40	68.5	111	
	2006.04-2010.03				R		GCI18129	Inner Joint		26	28	40	389	96.5	
2.0 TDCi (103 kW)	2006.04-2010.03				L		GCI18128	Inner Joint		26	28	40	68.5	111	
	2006.04-2010.03				R		GCI18129	Inner Joint		26	28	40	389	96.5	
2.0 TDCi (96 kW)	2006.04-2010.03				L		GCI18128	Inner Joint		26	28	40	68.5	111	
	2006.04-2010.03				R		GCI18129	Inner Joint		26	28	40	389	96.5	
<b>GALAXY III</b>															
1.6 TDCi (85 kW)	2011.02-				L		GCI18128	Inner Joint		26	28	40	68.5	111	
	2011.02-				R		GCI18129	Inner Joint		26	28	40	389	96.5	









		TRANSM	L/R	F/R		G-AP Ref.	PRODUCT	ABS	Technical Specifications					
									YEAR	A	B	C	H	L
<b>FORD</b>														
<b>GALAXY III</b>														
2.0 BIFUEL 16V (107 kW)	2010.03-			L		GCI18128	Inner Joint		26	28	40	68.5	111	
	2010.03-			R		GCI18129	Inner Joint		26	28	40	389	96.5	
2.0 TDCi (120 kW)	2010.03-		MT	L		GCI18128	Inner Joint		26	28	40	68.5	111	
	2010.03-		MT	R		GCI18129	Inner Joint		26	28	40	389	96.5	
2.0 TDCi (85 kW)	2010.03-		MT	L		GCI18128	Inner Joint		26	28	40	68.5	111	
	2010.03-		MT	R		GCI18129	Inner Joint		26	28	40	389	96.5	
<b>GHIA</b>														
-	1994-	1996	AT			GC018063	Outer Joint		26	32	51	105	64.5	I
<b>GRANADA (GGCL)</b>														
2.3 (79 kW)	1972.01-	1976.02			R Coupe	GCI18001	Inner Joint			25		32		
<b>GRANADA (GGNL)</b>														
1.7 (51 kW)	1974.12-	1977.08			R Estate Engine MWB	GCI18001	Inner Joint			25		32		
2.3 (79 kW)	1972.01-	1976.02			R Estate	GCI18001	Inner Joint			25		32		
<b>GRANADA (GGTL, GGFL)</b>														
1.7 (51 kW)	1974.12-	1977.08			R Saloon Engine MWB	GCI18001	Inner Joint			25		32		
2.3 (79 kW)	1972.01-	1976.02			R Saloon	GCI18001	Inner Joint			25		32		
<b>GRANADA (GNU)</b>														
1.7 (54 kW)	1977.08-	1981.07	MT		R Estate Engine MYE	GCI18001	Inner Joint			25		32		
2.0 (66 kW)	1977.08-	1985.06	MT		R Estate Engine NYP	GCI18001	Inner Joint			25		32		
2.0 (74 kW)	1979.08-	1985.08	MT		R Estate Engine NEP	GCI18001	Inner Joint			25		32		
2.0 (77 kW)	1981.08-	1985.08	MT		R Estate Engine NEK	GCI18001	Inner Joint			25		32		
2.3 (82 kW)	1981.06-	1985.06	MT		R Estate Engine YYU	GCI18001	Inner Joint			25		32		
2.3 (84 kW)	1979.06-	1985.08	MT		R Estate Engine YYP	GCI18001	Inner Joint			25		32		
2.5 D (51 kW)	1982.08-	1985.08	MT		R Estate Engine STP	GCI18001	Inner Joint			25		32		
2.8 (97 kW)	1981.06-	1985.08	MT		R Estate Engine PYU	GCI18001	Inner Joint			25		32		
2.8 (99 kW)	1977.08-	1985.08	MT		R Estate Engine PYA	GCI18001	Inner Joint			25		32		
2.8 i (108 kW)	1977.08-	1985.08	MT		R Estate Engine PRD	GCI18001	Inner Joint			25		32		
2.8 i (110 kW)	1982.10-	1985.08	MT		R Estate Engine PRC	GCI18001	Inner Joint			25		32		
2.8 i (118 kW)	1977.08-	1981.08	MT		R Estate Engine PRB	GCI18001	Inner Joint			25		32		
<b>GRANADA (GU)</b>														
1.6 (55 kW)	1981.07-	1985.08	MT		R Saloon Engine LCK	GCI18001	Inner Joint			25		32		
	1981.07-	1985.08			R Saloon Engine LCK	GCI82006	Inner Joint			25		32		
1.7 (51 kW)	1977.08-	1982.05	MT		R Saloon Engine TV17LC	GCI18001	Inner Joint			25		32		
	1977.08-	1982.05			R Saloon Engine TV17LC	GCI82006	Inner Joint			25		32		
1.7 (54 kW)	1977.08-	1981.07	MT		R Saloon Engine MY	GCI18001	Inner Joint			25		32		
	1977.08-	1981.07			R Saloon Engine MY	GCI82006	Inner Joint			25		32		
2.0 (66 kW)	1977.08-	1985.08	MT		R Saloon Engine NYP	GCI18001	Inner Joint			25		32		
	1977.08-	1985.08			R Saloon Engine NYP	GCI82006	Inner Joint			25		32		
2.0 (74 kW)	1979.08-	1985.08	MT		R Saloon Engine NEP	GCI18001	Inner Joint			25		32		
	1979.08-	1985.08			R Saloon Engine NEP	GCI82006	Inner Joint			25		32		
2.0 (77 kW)	1981.08-	1985.08	MT		R Saloon Engine NEK	GCI18001	Inner Joint			25		32		
	1981.08-	1985.08			R Saloon Engine NEK	GC053006	Outer Joint		22	30	50	78.5	52	I
2.1 D (46 kW)	1977.08-	1982.08	MT		R Saloon Engine WTA	GCI18001	Inner Joint			25		32		
	1977.08-	1982.08			R Saloon Engine WTA	GCI82006	Inner Joint			25		32		
2.3 (82 kW)	1981.06-	1985.08	MT		R Saloon Engine YYU	GCI18001	Inner Joint			25		32		
	1981.06-	1985.08			R Saloon Engine YYU	GCI82006	Inner Joint			25		32		
2.3 (84 kW)	1979.06-	1985.08	MT		R Saloon Engine YYP	GCI18001	Inner Joint			25		32		
2.5 D (51 kW)	1982.08-	1985.08	MT		R Saloon Engine STP	GCI18001	Inner Joint			25		32		
	1982.08-	1985.08			R Saloon Engine STP	GCI82006	Inner Joint			25		32		
2.8 (97 kW)	1981.06-	1985.08	MT		R Saloon Engine PYU	GCI18001	Inner Joint			25		32		
2.8 (99 kW)	1977.08-	1985.08	MT		R Saloon Engine PYA	GCI18001	Inner Joint			25		32		
2.8 i (108 kW)	1977.08-	1985.08	MT		R Saloon Engine PRD	GCI18001	Inner Joint			25		32		
2.8 i (110 kW)	1982.10-	1985.08	MT		R Saloon Engine PRC	GCI18001	Inner Joint			25		32		
	1982.10-	1985.08			R Saloon Engine PRC	GCI82006	Inner Joint			25		32		
2.8 i (118 kW)	1977.08-	1981.08	MT		R Saloon Engine PRB	GCI18001	Inner Joint			25		32		
	1977.08-	1981.08			R Saloon Engine PRB	GCI82006	Inner Joint			25		32		
<b>GRANADA III (GAE, GGE)</b>														
1.8 (66 kW)	1985.04-	1992.02	MT	R	R Hatchback Engine REC	GDS18128	Drive Shaft					32	519	
	1985.04-	1992.02	MT		R Hatchback Engine REC	GCI18001	Inner Joint			25		32		
	1985.04-	1992.02	MT	L	R Hatchback Engine REC	GDS18129	Drive Shaft					32	478	
	1985.04-	1992.02			R Hatchback Engine REC	GCI82006	Inner Joint			25		32		



		TRANSM	L/R	F/R		G-AP Ref.	PRODUCT	ABS	Technical Specifications								
									YEAR	A	B	C	H	L	P		
<b>FORD</b>																	
<b>GRANADA III (GAE, GGE)</b>																	
2.0 (77 kW)	1985.04-	1989.08	MT/AT	R	R	Hatchback Engine N8D/NEL	GDS18128	Drive Shaft					32	519			
	1985.04-	1989.08	MT/AT		R	Hatchback Engine N8D/NEL	GCI18001	Inner Joint		25			32				
	1985.04-	1989.08	MT/AT	L	R	Hatchback Engine N8D/NEL	GDS18129	Drive Shaft					32	478			
2.0 i (74 kW)	1985.10-	1990.12	MT/AT	R	R	Hatchback Engine NRC	GDS18128	Drive Shaft					32	519			
	1985.10-	1990.12	MT/AT		R	Hatchback Engine NRC	GCI18001	Inner Joint		25			32				
	1985.10-	1990.12	MT/AT	L	R	Hatchback Engine NRC	GDS18129	Drive Shaft					32	478			
	1985.10-	1990.12			R	Hatchback Engine NRC	GCI82006	Inner Joint		25			32				
2.0 i (85 kW)	1985.04-	1992.02	MT/AT	R	R	Hatchback Engine NRA/NRI	GDS18128	Drive Shaft					32	519			
	1985.04-	1992.02	MT/AT		R	Hatchback Engine NRA/NRI	GCI18001	Inner Joint		25			32				
	1985.04-	1992.02	MT/AT	L	R	Hatchback Engine NRA/NRI	GDS18129	Drive Shaft					32	478			
	1992.02-	1994.09	MT/AT	R	R	Hatchback Engine NRA/NRI	GDS18128	Drive Shaft					32	519			
	1992.02-	1994.09	MT/AT		R	Hatchback Engine NRA/NRI	GCI18001	Inner Joint		25			32				
	1992.02-	1994.09	MT/AT	L	R	Hatchback Engine NRA/NRI	GDS18129	Drive Shaft					32	478			
	1992.02-	1994.09	MT/AT		R	Hatchback Engine NRA/NRI	GCI82006	Inner Joint		25			32				
2.0 i (88 kW)	1989.05-	1994.09	MT/AT	R	R	Hatchback Engine N9D	GDS18128	Drive Shaft					32	519			
	1989.05-	1994.09	MT/AT		R	Hatchback Engine N9D	GCI18001	Inner Joint		25			32				
	1989.05-	1994.09	MT/AT	L	R	Hatchback Engine N9D	GDS18129	Drive Shaft					32	478			
2.4 i (92 kW)	1988.10-	1992.02	MT/AT	R	R	Hatchback Engine ARD	GDS18128	Drive Shaft					32	519			
	1988.10-	1992.02	MT/AT		R	Hatchback Engine ARD	GCI18001	Inner Joint		25			32				
	1988.10-	1992.02	MT/AT	L	R	Hatchback Engine ARD	GDS18129	Drive Shaft					32	478			
	1988.10-	1992.02			R	Hatchback Engine ARD	GCI82006	Inner Joint		25			32				
2.4 i (96 kW)	1986.09-	1988.09	MT/AT	R	R	Hatchback Engine ARC	GDS18128	Drive Shaft					32	519			
	1986.09-	1988.09	MT/AT		R	Hatchback Engine ARC	GCI18001	Inner Joint		25			32				
	1986.09-	1988.09	MT/AT	L	R	Hatchback Engine ARC	GDS18129	Drive Shaft					32	478			
	1986.09-	1988.09			R	Hatchback Engine ARC	GCI82006	Inner Joint		25			32				
2.4 i CAT (92 kW)	1988.10-	1994.09	MT/AT	R	R	Hatchback Engine ARD	GDS18128	Drive Shaft					32	519			
	1988.10-	1994.09	MT/AT		R	Hatchback Engine ARD	GCI18001	Inner Joint		25			32				
	1988.10-	1994.09	MT/AT	L	R	Hatchback Engine ARD	GDS18129	Drive Shaft					32	478			
	1988.10-	1994.09			R	Hatchback Engine ARD	GCI82006	Inner Joint		25			32				
2.5 D (51 kW)	1985.12-	1992.02	MT	R	R	Hatchback Engine STR	GDS18128	Drive Shaft					32	519			
	1985.12-	1992.02	MT		R	Hatchback Engine STR	GCI18001	Inner Joint		25			32				
	1985.12-	1992.02	MT	L	R	Hatchback Engine STR	GDS18129	Drive Shaft					32	478			
	1985.12-	1992.02			R	Hatchback Engine STR	GCI82006	Inner Joint		25			32				
2.5 TD (68 kW)	1988.06-	1993.07	MT	R	R	Hatchback Engine SFA/SFB	GDS18128	Drive Shaft					32	519			
	1988.06-	1993.07	MT		R	Hatchback Engine SFA/SFB	GCI18001	Inner Joint		25			32				
	1988.06-	1993.07	MT	L	R	Hatchback Engine SFA/SFB	GDS18129	Drive Shaft					32	478			
	1988.06-	1993.07			R	Hatchback Engine SFA/SFB	GCI82006	Inner Joint		25			32				
2.5 TD (85 kW)	1993.08-	1994.09	MT	R	R	Hatchback Engine SCB	GDS18128	Drive Shaft					32	519			
	1993.08-	1994.09	MT		R	Hatchback Engine SCB	GCI18001	Inner Joint		25			32				
	1993.08-	1994.09	MT	L	R	Hatchback Engine SCB	GDS18129	Drive Shaft					32	478			
	1993.08-	1994.09			R	Hatchback Engine SCB	GCI82006	Inner Joint		25			32				
2.8 i (110 kW)	1985.04-	1986.11	MT/AT	R	R	Hatchback Engine PRE	GDS18128	Drive Shaft					32	519			
	1985.04-	1986.11	MT/AT		R	Hatchback Engine PRE	GCI18001	Inner Joint		25			32				
	1985.04-	1986.11	MT/AT	L	R	Hatchback Engine PRE	GDS18129	Drive Shaft					32	478			
	1985.04-	1986.11			R	Hatchback Engine PRE	GCI82006	Inner Joint		25			32				
2.8 i 4x4 (110 kW)	1985.10-	1986.11	MT/AT	R	R	Hatchback Engine PRE	GDS18128	Drive Shaft					32	519			
	1985.10-	1986.11	MT/AT		R	Hatchback Engine PRE	GCI18001	Inner Joint		25			32				
	1985.10-	1986.11	MT/AT	L	R	Hatchback Engine PRE	GDS18129	Drive Shaft					32	478			
	1985.10-	1986.11				Hatchback Engine PRE	GCI82006	Inner Joint		25			32				
2.9 i (107 kW)	1986.09-	1994.09	MT/AT	R	R	Hatchback Engine BRD/BRE/BRF	GDS18128	Drive Shaft					32	519			
	1986.09-	1994.09	MT/AT		R	Hatchback Engine BRD/BRE/BRF	GCI18001	Inner Joint		25			32				
	1986.09-	1994.09	MT/AT	L	R	Hatchback Engine BRD/BRE/BRF	GDS18129	Drive Shaft					32	478			
	1986.09-	1994.09			R	Hatchback Engine BRD/BRE/BRF	GCI82006	Inner Joint		25			32				
2.9 i (110 kW)	1986.09-	1994.09	MT/AT	R	R	Hatchback Engine BRC	GDS18128	Drive Shaft					32	519			
	1986.09-	1994.09	MT/AT		R	Hatchback Engine BRC	GCI18001	Inner Joint		25			32				
	1986.09-	1994.09	MT/AT	L	R	Hatchback Engine BRC	GDS18129	Drive Shaft					32	478			
2.9 i 24V (143 kW)	1991.04-	1994.09	MT/AT	R	R	Hatchback Engine BOA	GDS18128	Drive Shaft					32	519			
	1991.04-	1994.09	MT/AT		R	Hatchback Engine BOA	GCI18001	Inner Joint		25			32				
	1991.04-	1994.09	MT/AT	L	R	Hatchback Engine BOA	GDS18129	Drive Shaft					32	478			
	1991.04-	1994.09			R	Hatchback Engine BOA	GCI82006	Inner Joint		25			32				
2.9 i 4x4 (107 kW)	1988.05-	1993.02	MT/AT	R	R	Hatchback Engine BRD/BRE/BRF	GDS18128	Drive Shaft					32	519			
	1988.05-	1993.02	MT/AT		R	Hatchback Engine BRD/BRE/BRF	GCI18001	Inner Joint		25			32				
	1988.05-	1993.02	MT/AT	L	R	Hatchback Engine BRD/BRE/BRF	GDS18129	Drive Shaft					32	478			

		TRANSM	L/R	F/R		G-AP Ref.	PRODUCT	ABS	Technical Specifications						
									YEAR	A	B	C	H	L	P
<b>FORD</b>															
<b>GRANADA III (GAE, GGE)</b>															
2.9 i 4x4 (110 kW)	1986.09-	1994.09	MT/AT	R	R	Hatchback Engine BRC	GDS18128	Drive Shaft				32	519		
	1986.09-	1994.09	MT/AT		R	Hatchback Engine BRC	GCI18001	Inner Joint		25		32			
	1986.09-	1994.09	MT/AT	L	R	Hatchback Engine BRC	GDS18129	Drive Shaft				32	478		
2.9 i CAT (107 kW)	1987.10-	1994.09	MT/AT	R	R	Hatchback Engine BRE	GDS18128	Drive Shaft				32	519		
	1987.10-	1994.09	MT/AT		R	Hatchback Engine BRE	GCI18001	Inner Joint		25		32			
	1987.10-	1994.09	MT/AT	L	R	Hatchback Engine BRE	GDS18129	Drive Shaft				32	478		
	1987.10-	1994.09			R	Hatchback Engine BRE	GCI82006	Inner Joint		25		32			
<b>GRANADA III (GGE)</b>															
2.0 i (85 kW)	1991.09-	1994.09	MT/AT	R	R	Estate Engine N9F	GDS18128	Drive Shaft				32	519		
	1991.09-	1994.09	MT/AT		R	Estate Engine N9F	GCI18001	Inner Joint		25		32			
	1991.09-	1994.09	MT/AT	L	R	Estate Engine N9F	GDS18129	Drive Shaft				32	478		
	1992.02-	1994.09	MT/AT	R	R	Saloon Engine N9F	GDS18128	Drive Shaft				32	519		
	1992.02-	1994.09	MT/AT		R	Saloon Engine N9F	GCI18001	Inner Joint		25		32			
	1992.02-	1994.09	MT/AT	L	R	Saloon Engine N9F	GDS18129	Drive Shaft				32	478		
2.0 i (88 kW)	1989.05-	1994.09	MT/AT	R	R	Saloon Engine N9D	GDS18128	Drive Shaft				32	519		
	1989.05-	1994.09	MT/AT		R	Saloon Engine N9D	GCI18001	Inner Joint		25		32			
	1989.05-	1994.09	MT/AT	L	R	Saloon Engine N9D	GDS18129	Drive Shaft				32	478		
	1991.09-	1994.09	MT/AT	R	R	Estate Engine N9D	GDS18128	Drive Shaft				32	519		
	1991.09-	1994.09	MT/AT		R	Estate Engine N9D	GCI18001	Inner Joint		25		32			
	1991.09-	1994.09	MT/AT	L	R	Estate Engine N9D	GDS18129	Drive Shaft				32	478		
2.4 i (92 kW)	1988.10-	1994.10	MT	R	R	Saloon Engine ARD	GDS18128	Drive Shaft				32	519		
	1988.10-	1994.10	MT		R	Saloon Engine ARD	GCI18001	Inner Joint		25		32			
	1988.10-	1994.10	MT	L	R	Saloon Engine ARD	GDS18129	Drive Shaft				32	478		
	1991.09-	1994.09	MT	R	R	Estate Engine ARD	GDS18128	Drive Shaft				32	519		
	1991.09-	1994.09	MT		R	Estate Engine ARD	GCI18001	Inner Joint		25		32			
	1991.09-	1994.09	MT	L	R	Estate Engine ARD	GDS18129	Drive Shaft				32	478		
2.5 TD (68 kW)	1988.06-	1993.07	MT	R	R	Saloon Engine SFA/SFB	GDS18128	Drive Shaft				32	519		
	1988.06-	1993.07	MT		R	Saloon Engine SFA/SFB	GCI18001	Inner Joint		25		32			
	1988.06-	1993.07	MT	L	R	Saloon Engine SFA/SFB	GDS18129	Drive Shaft				32	478		
	1991.09-	1993.07	MT	R	R	Estate Engine SFA/SFB	GDS18128	Drive Shaft				32	519		
	1991.09-	1993.07	MT		R	Estate Engine SFA/SFB	GCI18001	Inner Joint		25		32			
	1991.09-	1993.07	MT	L	R	Estate Engine SFA/SFB	GDS18129	Drive Shaft				32	478		
2.5 TD (85 kW)	1993.08-	1994.09	MT	R	R	Estate Engine SCB	GDS18128	Drive Shaft				32	519		
	1993.08-	1994.09	MT	R	R	Saloon Engine SCB	GDS18128	Drive Shaft				32	519		
	1993.08-	1994.09	MT		R	Estate Engine SCB	GCI18001	Inner Joint		25		32			
	1993.08-	1994.09	MT		R	Saloon Engine SCB	GCI18001	Inner Joint		25		32			
	1993.08-	1994.09	MT	L	R	Estate Engine SCB	GDS18129	Drive Shaft				32	478		
	1993.08-	1994.09	MT	L	R	Saloon Engine SCB	GDS18129	Drive Shaft				32	478		
2.9 24V (143 kW)	1993.08-	1994.09	MT/AT	R	R	Estate Engine BOA	GDS18128	Drive Shaft				32	519		
	1993.08-	1994.09	MT/AT		R	Estate Engine BOA	GCI18001	Inner Joint		25		32			
	1993.08-	1994.09	MT/AT	L	R	Estate Engine BOA	GDS18129	Drive Shaft				32	478		
2.9 i (107 kW)	1986.09-	1994.12	MT/AT	R	R	Saloon Engine BRD/BRE/BRF	GDS18128	Drive Shaft				32	519		
	1986.09-	1994.12	MT/AT		R	Saloon Engine BRD/BRE/BRF	GCI18001	Inner Joint		25		32			
	1986.09-	1994.12	MT/AT	L	R	Saloon Engine BRD/BRE/BRF	GDS18129	Drive Shaft				32	478		
	1991.09-	1994.09	MT/AT	R	R	Estate Engine BRD/BRE/BRF	GDS18128	Drive Shaft				32	519		
	1991.09-	1994.09	MT/AT		R	Estate Engine BRD/BRE/BRF	GCI18001	Inner Joint		25		32			
	1991.09-	1994.09	MT/AT	L	R	Estate Engine BRD/BRE/BRF	GDS18129	Drive Shaft				32	478		
2.9 i 24V (143 kW)	1991.04-	1994.09	MT/AT	R	R	Saloon Engine BOA	GDS18128	Drive Shaft				32	519		
	1991.04-	1994.09	MT/AT		R	Saloon Engine BOA	GCI18001	Inner Joint		25		32			
	1991.04-	1994.09	MT/AT	L	R	Saloon Engine BOA	GDS18129	Drive Shaft				32	478		
2.9 i 4x4 (107 kW)	1988.05-	1993.02	MT/AT	R	R	Estate Engine BRD/BRE/BRF	GDS18128	Drive Shaft				32	519		
	1988.05-	1993.02	MT/AT		R	Estate Engine BRD/BRE/BRF	GCI18001	Inner Joint		25		32			
	1988.05-	1993.02	MT/AT	L	R	Estate Engine BRD/BRE/BRF	GDS18129	Drive Shaft				32	478		
	1989.12-	1994.10	MT/AT	R	R	Saloon Engine BRD/BRE/BRF	GDS18128	Drive Shaft				32	519		
	1989.12-	1994.10	MT/AT		R	Saloon Engine BRD/BRE/BRF	GCI18001	Inner Joint		25		32			
	1989.12-	1994.10	MT/AT	L	R	Saloon Engine BRD/BRE/BRF	GDS18129	Drive Shaft				32	478		
<b>GRAND C-MAX</b>															
1.6 EcoBoost (110 kW)	2010.12-		MT	L	F	MPV Engine JQDA/JQDB	GDS18295	Drive Shaft		27	26	63	96	637	
	2010.12-		MT	R	F	MPV Engine JQDA/JQDB	GDS18294	Drive Shaft		27	26	63	96	972	
1.6 EcoBoost (134 kW)	2010.12-		MT	L	F	MPV Engine JTDA/JTDB	GDS18295	Drive Shaft		27	26	63	96	637	
	2010.12-		MT	R	F	MPV Engine JTDA/JTDB	GDS18294	Drive Shaft		27	26	63	96	972	
1.6 TDCi (70 kW)	2010.12-					MPV Engine T3DA/T3DB	GC018240	Outer Joint		27	26	63	96	62.5	M









		TRANSM	L/R	F/R		G-AP Ref.	PRODUCT	ABS	Technical Specifications								
									YEAR	A	B	C	H	L	P		
<b>FORD</b>																	
<b>GRAND C-MAX</b>																	
1.6 TDCi (85 kW)	2010.12-				MPV Engine T1DA/T1DB	GC018240	Outer Joint		27	26	63	96	62.5	M			
1.6 Ti (77 kW)	2010.12-		MT	L	F	MPV Engine IQDA/IQDB	GDS18322	Drive Shaft	27	23	62.8	95.5	657				
	2010.12-		MT	R	F	MPV Engine IQDA/IQDB	GDS18323	Drive Shaft	27	23	62.8	95.5	961				
	2010.12-					MPV Engine IQDA/IQDB	GC018244	Outer Joint	27	24	62.8	95.5	59	M			
1.6 Ti (92 kW)	2010.12-		MT	L	F	MPV Engine PNDA	GDS18322	Drive Shaft	27	23	62.8	95.5	657				
	2010.12-		MT	R	F	MPV Engine PNDA	GDS18323	Drive Shaft	27	23	62.8	95.5	961				
	2010.12-					MPV Engine PNDA	GC018244	Outer Joint	27	24	62.8	95.5	59	M			
2.0 TDCi (100 kW)	2011.02-		AT	R	F	MPV Engine UKDB	GDS18343	Drive Shaft	27	28	63.1	96	967				
	2011.02-					MPV Engine UKDB	GC018270	Outer Joint	27	26	62.8	91	64	M			
2.0 TDCi (103 kW)	2011.02-		AT	R	F	MPV Engine UFDB	GDS18343	Drive Shaft	27	28	63.1	96	967				
	2011.02-					MPV Engine UFDB	GC018270	Outer Joint	27	26	62.8	91	64	M			
2.0 TDCi (120 kW)	2010.12-		MT/AT			MPV Engine TXDB	GC018270	Outer Joint	27	26	62.8	91	64	M			
2.0 TDCi (85 kW)	2011.02-		AT	R	F	MPV Engine TYDA	GDS18343	Drive Shaft	27	28	63.1	96	967				
	2011.02-					MPV Engine TYDA	GC018270	Outer Joint	27	26	62.8	91	64	M			
<b>IKON / FIESTA</b>																	
-	2001-2005		MT				GCI18022	Inner Joint	23	21	40	61	88				
	2001-2005		MT				GCI99072	Inner Joint	23	21	40	370.5	75.5				
<b>KA</b>																	
-	1999-						GCI18072	Inner Joint	23	22	40	61	86				
1.0	1997.01-1999.12		MT				GC099015	Outer Joint	25	20	56.5	88	49	O			
1.0 Zetec Rocan	2000.01-2006.12		MT				GC018099	Outer Joint	25	20	55	88	52	M			
1.2 (51 kW)	2008.10-				F	Hatchback Engine FP4	GC017043	Outer Joint	22	20	47	75.5	54.5	M			
	2008.10-			L	F	Hatchback Engine FP4	GDS17170	Drive Shaft	22	29.2	47	75.5	524				
	2008.10-			L	F	Hatchback Engine FP4	GC017043	Outer Joint	22	20	47	75.5	54.5	M			
	2008.10-			R	F	Hatchback Engine FP4	GDS17171	Drive Shaft	22	29.2	47	75.5	758				
1.3	1997.01-1999.12		MT				GC099015	Outer Joint	25	20	56.5	88	49	O			
1.3 TDCi (55 kW)	2008.10-				F	Hatchback Engine FD4	GC017026	Outer Joint	25	22	51	84	57	M			
	2008.10-		MT	L	F	Hatchback Engine FD4	GDS17119	Drive Shaft	25	22	51	84	615				
	2008.10-		MT	R	F	Hatchback Engine FD4	GDS17120	Drive Shaft	25	22	51	84	846				
<b>KA (RB_)</b>																	
1.3 i (36 kW)	1998.06-2008.11		MT	L	F	Hatchback Engine JJD/JJF/JJG/JJH/JJL	GDS18007	Drive Shaft	25	23	56.5	88.5	590				
	1998.06-2008.11		MT	R	F	Hatchback Engine JJD/JJF/JJG/JJH/JJL	GDS18140	Drive Shaft	25	23	56.5	88.5	868				
	1998.06-2008.11		MT		F	Hatchback Engine JJD/JJF/JJG/JJH/JJL	GC018012	Outer Joint	25	20	56.5	88.5	49	O			
1.3 i (37 kW)	1996.09-2002.10		MT	L	F	Hatchback Engine JJB	GDS18007	Drive Shaft	25	23	56.5	88.5	590				
	1996.09-2002.10		MT	R	F	Hatchback Engine JJB	GDS99044	Drive Shaft	25	23	56.5	88.5	866				
	1996.09-2002.10		MT	R	F	Hatchback Engine JJB	GDS18140	Drive Shaft	25	23	56.5	88.5	868				
	1996.09-2002.10		MT		F	Hatchback Engine JJB	GC018012	Outer Joint	25	20	56.5	88.5	49	O			
1.3 i (44 kW)	1996.09-2008.11		MT	L	F	Hatchback Engine BAA/J4D/J4K/J4M/J4N/J4P/J4S	GDS18007	Drive Shaft	25	23	56.5	88.5	590				
	1996.09-2008.11		MT	R	F	Hatchback Engine BAA/J4D/J4K/J4M/J4N/J4P/J4S	GDS18140	Drive Shaft	25	23	56.5	88.5	868				
	1996.09-2008.11		MT		F	Hatchback Engine BAA/J4D/J4K/J4M/J4N/J4P/J4S	GC018012	Outer Joint	25	20	56.5	88.5	49	O			
1.3 i (51 kW)	2002.08-2008.11		MT	R	F	Hatchback Engine A9A/A9B	GDS99044	Drive Shaft	25	23	56.5	88.5	866				
1.6 (68 kW)	2006.10-2007.12		MT	R	F	Hatchback	GDS99044	Drive Shaft	25	23	56.5	88.5	866				
	2006.10-2007.12					Hatchback	GC018222	Outer Joint	25	23	53.3	87	56	M			
1.6 i (70 kW)	2003.07-2008.11		MT	R	F	Hatchback Engine CDB/CDC/CCA	GDS99044	Drive Shaft	25	23	56.5	88.5	866				
	2003.07-2008.11					Hatchback Engine CDB/CDC/CCA	GC018222	Outer Joint	25	23	53.3	87	56	M			
1.6 i (71 kW)	2005.11-2008.09		MT	R	F	Hatchback	GDS99044	Drive Shaft	25	23	56.5	88.5	866				
	2005.11-2008.09					Hatchback	GC018222	Outer Joint	25	23	53.3	87	56	M			
<b>KA VAN (RB)</b>																	
1.3 i (44 kW)	2002.05-2005.05		MT	R	F	Box Engine BAA/J4D/J4K/J4M/J4N/J4P/J4S	GDS99044	Drive Shaft	25	23	56.5	88.5	866				
<b>KUGA I</b>																	
2.0 TDCi (100 kW)	2008.03-			L/R	F	Closed Off-Road Vehicle Engine G6DG/UKDA	GC099318	Outer Joint	27	36	63	91	68	I			
2.0 TDCi (103 kW)	2010.03-			L/R	F	Closed Off-Road Vehicle Engine UFDA	GC099318	Outer Joint	27	36	63	91	68	I			
	2010.03-			R	F	Closed Off-Road Vehicle Engine UFDA	GDS50465	Drive Shaft	27	26	63	91	994				
	2010.03-			R	F	Closed Off-Road Vehicle Engine UFDA	GCI50083	Inner Joint	26	27	30	388.5	96				
2.0 TDCi 4x4 (100 kW)	2008.03-		MT	L	F	Closed Off-Road Vehicle Engine G6DG/UKDA	GDS50466	Drive Shaft	27	26	63	91	657				
	2008.03-		MT	L	F	Closed Off-Road Vehicle Engine G6DG/UKDA	GCI50061	Inner Joint	26	27	40	69	111				
	2008.03-			L/R	F	Closed Off-Road Vehicle Engine G6DG/UKDA	GC099318	Outer Joint	27	36	63	91	68	I			
2.0 TDCi 4x4 (103 kW)	2010.03-		MT	L	F	Closed Off-Road Vehicle Engine UFDA	GDS50466	Drive Shaft	27	26	63	91	657				
	2010.03-		MT	L	F	Closed Off-Road Vehicle Engine UFDA	GCI50061	Inner Joint	26	27	40	69	111				
	2010.03-			L/R	F	Closed Off-Road Vehicle Engine UFDA	GC099318	Outer Joint	27	36	63	91	68	I			
	2010.03-			R	F	Closed Off-Road Vehicle Engine UFDA	GDS50465	Drive Shaft	27	26	63	91	994				
	2010.03-			R	F	Closed Off-Road Vehicle Engine UFDA	GCI50083	Inner Joint	26	27	30	388.5	96				

	 YEAR	TRANSM	L/R	F/R		G-AP Ref.	PRODUCT	ABS	Technical Specifications							
									A	B	C	H	L	P		
<b>FORD KUGA I</b>																
2.0 TDCi 4x4 (120 kW)	2010.03-		MT	L	F	Closed Off-Road Vehicle Engine TXDA	GDS50466	Drive Shaft		27	26	63	91	657		
	2010.03-		MT	L	F	Closed Off-Road Vehicle Engine TXDA	GCI50061	Inner Joint		26	27	40	69	111		
	2010.03-			L/R	F	Closed Off-Road Vehicle Engine TXDA	GC099318	Outer Joint		27	36	63	91	68	I	
	2010.03-			R	F	Closed Off-Road Vehicle Engine TXDA	GDS50465	Drive Shaft		27	26	63	91	994		
	2010.03-			R	F	Closed Off-Road Vehicle Engine TXDA	GCI50083	Inner Joint		26	27	30	388.5	96		
2.5 (147 kW)	2009.03-			L/R	F	Closed Off-Road Vehicle Engine HYDB	GC099318	Outer Joint		27	36	63	91	68	I	
2.5 4x4 (147 kW)	2009.03-			L/R	F	Closed Off-Road Vehicle Engine HYDB	GC099318	Outer Joint		27	36	63	91	68	I	
<b>KUGA II (DM2)</b>																
1.6 EcoBoost (110 kW)	2013.03-		MT/AT			Closed Off-Road Vehicle Engine JQMB/JQMA	GC018270	Outer Joint		27	26	62.8	91	64	M	
1.6 EcoBoost 4x4 (134 kW)	2013.03-		MT/AT			Closed Off-Road Vehicle Engine JTMA	GC018270	Outer Joint		27	26	62.8	91	64	M	
<b>LASER</b>																
1.6 SOHC KF KH	1990.01-1994.09						GCI18009	Inner Joint		24	23	35	64	98.5		
	1990.01-1994.09		MT/AT	L			GDS18056	Drive Shaft		26	24	56	93	625		
	1990.01-1994.09		MT/AT	R			GDS18057	Drive Shaft		26	24	56	93	905		
<b>LASER (METEOR)</b>																
-	1985.01-1990.03		MT/AT	L		KC (GC) KE TX 3 2WD	GDS34076	Drive Shaft		24	26	52	86	595		
	1985.01-1990.03		MT/AT	R		KC (GC) KE TX 3 2WD	GDS34077	Drive Shaft		24	26	52	86	541		
<b>LYNX</b>																
-			AT				GCI88014	Inner Joint		28	30	43	47	72		
			AT				GCI34010	Inner Joint		24	30	35	64	99		
			AT	L			GDS34011	Drive Shaft		26	24	56	93	627		
			AT	L			GDS34080	Drive Shaft	44T	26	24	56	93	627		
			MT	L			GDS27049	Drive Shaft		26	28	56	92	615.5		
		AT	R			GDS59001	Drive Shaft	44T	26	28	56	93	625			
<b>MAVERICK</b>																
2.0 16V (91 kW)	2001.02-		MT/AT		F	Closed Off-Road Vehicle Engine YF	GC034090	Outer Joint	44T	28	24	56	89.1	59.5	M	
	2001.02-		MT	L	F	Closed Off-Road Vehicle Engine YF	GDS34096	Drive Shaft	44T	28	28	56	94	635		
	2001.02-		MT	L	F	Closed Off-Road Vehicle Engine YF	GCI34071	Inner Joint		28	32	35	66.5	112		
	2001.02-		MT	L	F	Closed Off-Road Vehicle Engine YF	GC034039	Outer Joint		28	24	56	94	62	M	
	2001.02-		MT	L	F	Closed Off-Road Vehicle Engine YF	GC034064	Outer Joint	44T	28	24	56	94	62	M	
	2001.02-		MT	R	F	Closed Off-Road Vehicle Engine YF	GDS34196	Drive Shaft	44T	28	35	56	94	570		
2001.02-				R	Closed Off-Road Vehicle Engine YF	GC018204	Outer Joint	44T	26	30	56	114	58	I		
2.3 16V (110 kW)	2004.03-		MT/AT		F	Closed Off-Road Vehicle Engine GZ	GC034090	Outer Joint	44T	28	24	56	89.1	59.5	M	
3.0 V6 24V (145 kW)	2001.02-		MT/AT		F	Closed Off-Road Vehicle Engine AJ	GC034090	Outer Joint	44T	28	24	56	89.1	59.5	M	
	2001.02-		AT	L	F	Closed Off-Road Vehicle Engine AJ	GDS18083	Drive Shaft	44T	28	35	56	91.5	670		
	2001.02-		AT	R	F	Closed Off-Road Vehicle Engine AJ	GDS34087	Drive Shaft	44T	28	35	56	94	545		
	2001.02-				F	Closed Off-Road Vehicle Engine AJ	GC034064	Outer Joint	44T	28	24	56	94	62	M	
2001.02-				R	Closed Off-Road Vehicle Engine AJ	GC018204	Outer Joint	44T	26	30	56	114	58	I		
3.0 V6 24V (149 kW)	2004.03-		MT/AT		F	Closed Off-Road Vehicle Engine AJ	GC034090	Outer Joint	44T	28	24	56	89.1	59.5	M	
	2004.03-		AT	L	F	Closed Off-Road Vehicle Engine AJ	GDS18083	Drive Shaft	44T	28	35	56	91.5	670		
	2004.03-		AT	R	F	Closed Off-Road Vehicle Engine AJ	GDS34087	Drive Shaft	44T	28	35	56	94	545		
	2004.03-				F	Closed Off-Road Vehicle Engine AJ	GC034064	Outer Joint	44T	28	24	56	94	62	M	
	2004.03-				R	Closed Off-Road Vehicle Engine AJ	GC018204	Outer Joint	44T	26	30	56	114	58	I	
<b>MONDEO</b>																
-	1995-1998		AT				GC018051	Outer Joint		27	30	54.3	91	56	I	
2.0							GDS18178	Drive Shaft		27	35	56.5	92	573		
				L			GDS18186	Drive Shaft		27	26	56.1	91.5	626		
<b>MONDEO (BNP)</b>																
1.6 i 16V (65 kW)	1994.07-1996.08		MT	R	F	Estate Engine L1J	GDS18005	Drive Shaft		27	35	57	91	566		
	1994.07-1996.08		MT	L	F	Estate Engine L1J	GDS18016	Drive Shaft		27	26	57	91	618.5		
	1994.07-1996.08		MT	R	F	Estate Engine L1J	GDS18006	Drive Shaft	44T	27	35	57	91	566		
	1994.07-1996.08				F	Estate Engine L1J	GC018052	Outer Joint		27	30	57	91	56	I	
	1994.07-1996.08		MT	L	F	Estate Engine L1J	GDS18002	Drive Shaft	44T	27	26	54.3	91	615		
	1994.07-1996.08		MT		F	Estate Engine L1J	GC018024	Outer Joint	44T	27	30	57	91	56	M	
1.6 i 16V (66 kW)	1993.04-1996.08		MT	R	F	Estate Engine L1F	GDS18005	Drive Shaft		27	35	57	91	566		
	1993.04-1996.08		MT	L	F	Estate Engine L1F	GDS18016	Drive Shaft		27	26	57	91	618.5		
	1993.04-1996.08		MT	R	F	Estate Engine L1F	GDS18006	Drive Shaft	44T	27	35	57	91	566		
	1993.04-1996.08				F	Estate Engine L1F	GC018052	Outer Joint		27	30	57	91	56	I	
	1993.04-1996.08		MT	L	F	Estate Engine L1F	GDS18002	Drive Shaft	44T	27	26	54.3	91	615		
	1993.04-1996.08		MT		F	Estate Engine L1F	GC018024	Outer Joint	44T	27	30	57	91	56	M	
1.8 i 16V (82 kW)	1994.07-1996.08		MT&AT	R	F	Estate Engine RKB	GDS18005	Drive Shaft		27	35	57	91	566		
	1994.07-1996.08		MT	L	F	Estate Engine RKB	GDS18016	Drive Shaft		27	26	57	91	618.5		



		TRANSM	L/R	F/R		G-AP Ref.	PRODUCT	ABS	Technical Specifications								
									YEAR	A	B	C	H	L	P		
<b>FORD MONDEO (BNP)</b>																	
1.8 i 16V (82 kW)	1994.07-1996.08	MT&AT	R	F	Estate Engine RKB	GDS18006	Drive Shaft	44T	27	35	57	91	566				
	1994.07-1996.08			F	Estate Engine RKB	GC018052	Outer Joint		27	30	57	91	56	I			
	1994.07-1996.08	MT	L	F	Estate Engine RKB	GDS18002	Drive Shaft	44T	27	26	54.3	91	615				
	1994.07-1996.08	AT	R	F	Estate Engine RKB	GDS18003	Drive Shaft		27	35	54.3	91	566				
	1994.07-1996.08	MT&AT		F	Estate Engine RKB	GC018024	Outer Joint	44T	27	30	57	91	56	M			
	1994.07-1996.08	AT	R	F	Estate Engine RKB	GDS18004	Drive Shaft	44T	27	35	54.3	91	566				
1.8 i 16V (85 kW)	1993.04-1996.08	MT&AT	R	F	Estate Engine RKA	GDS18005	Drive Shaft		27	35	57	91	566				
	1993.04-1996.08	MT	L	F	Estate Engine RKA	GDS18016	Drive Shaft		27	26	57	91	618.5				
	1993.04-1996.08	MT&AT	R	F	Estate Engine RKA	GDS18006	Drive Shaft	44T	27	35	57	91	566				
	1993.04-1996.08			F	Estate Engine RKA	GC018052	Outer Joint		27	30	57	91	56	I			
	1993.04-1996.08	MT	L	F	Estate Engine RKA	GDS18002	Drive Shaft	44T	27	26	54.3	91	615				
	1993.04-1996.08	AT	R	F	Estate Engine RKA	GDS18003	Drive Shaft		27	35	54.3	91	566				
	1993.04-1996.08	MT&AT		F	Estate Engine RKA	GC018024	Outer Joint	44T	27	30	57	91	56	M			
1.8 i 16V 4x4 (85 kW)	1993.04-1996.08	MT&AT	R	F	Estate Engine RKA	GDS18005	Drive Shaft		27	35	57	91	566				
	1993.04-1996.08	MT	L	F	Estate Engine RKA	GDS18016	Drive Shaft		27	26	57	91	618.5				
	1993.04-1996.08	MT&AT	R	F	Estate Engine RKA	GDS18006	Drive Shaft	44T	27	35	57	91	566				
	1993.04-1996.08				Estate Engine RKA	GC018052	Outer Joint		27	30	57	91	56	I			
	1993.04-1996.08	MT	L	F	Estate Engine RKA	GDS18002	Drive Shaft	44T	27	26	54.3	91	615				
	1993.04-1996.08	AT	R	F	Estate Engine RKA	GDS18003	Drive Shaft		27	35	54.3	91	566				
	1993.04-1996.08	MT&AT		F	Estate Engine RKA	GC018024	Outer Joint	44T	27	30	57	91	56	M			
1.8 TD (65 kW)	1993.04-1996.08	AT	R	F	Estate Engine RKA	GDS18004	Drive Shaft	44T	27	35	54.3	91	566				
	1993.06-1996.08	MT	L	F	Estate Engine RFM/RFN	GDS18001	Drive Shaft		27	26	54.3	91	615				
	1993.06-1996.08	MT	R	F	Estate Engine RFM/RFN	GDS18003	Drive Shaft		27	35	54.3	91	566				
	1993.06-1996.08	MT	L	F	Estate Engine RFM/RFN	GDS18002	Drive Shaft	44T	27	26	54.3	91	615				
1.8 TD (66 kW)	1993.06-1996.08	MT	R	F	Estate Engine RFM/RFN	GDS18004	Drive Shaft	44T	27	35	54.3	91	566				
	1995.11-1996.08	MT	R	F	Estate Engine RFM/RFN	GDS18004	Drive Shaft	44T	27	35	54.3	91	566				
	1995.11-1996.08	MT	L	F	Estate Engine RFM/RFN	GDS18001	Drive Shaft		27	26	54.3	91	615				
	1995.11-1996.08	MT	R	F	Estate Engine RFM/RFN	GDS18003	Drive Shaft		27	35	54.3	91	566				
2.0 i 16V (100 kW)	1995.11-1996.08	MT	L	F	Estate Engine RFM/RFN	GDS18002	Drive Shaft	44T	27	26	54.3	91	615				
	1993.04-1996.08	AT	R	F	Estate Engine NGA	GDS18004	Drive Shaft	44T	27	35	54.3	91	566				
	1993.04-1996.08	MT&AT	R	F	Estate Engine NGA	GDS18005	Drive Shaft		27	35	57	91	566				
	1993.04-1996.08	MT	L	F	Estate Engine NGA	GDS18016	Drive Shaft		27	26	57	91	618.5				
	1993.04-1996.08	MT&AT	R	F	Estate Engine NGA	GDS18006	Drive Shaft	44T	27	35	57	91	566				
	1993.04-1996.08			F	Estate Engine NGA	GC018052	Outer Joint		27	30	57	91	56	I			
	1993.04-1996.08	MT	L	F	Estate Engine NGA	GDS18002	Drive Shaft	44T	27	26	54.3	91	615				
2.0 i 16V 4x4 (100 kW)	1993.04-1996.08	AT	R	F	Estate Engine NGA	GDS18003	Drive Shaft		27	35	54.3	91	566				
	1993.04-1996.08	MT&AT	R	F	Estate Engine NGA	GDS18004	Drive Shaft	44T	27	35	54.3	91	566				
	1993.04-1996.08	MT	L	F	Estate Engine NGA	GDS18016	Drive Shaft		27	26	57	91	618.5				
	1993.04-1996.08	MT&AT	R	F	Estate Engine NGA	GDS18006	Drive Shaft	44T	27	35	57	91	566				
	1993.04-1996.08				Estate Engine NGA	GC018052	Outer Joint		27	30	57	91	56	I			
	1993.04-1996.08	MT	L	F	Estate Engine NGA	GDS18002	Drive Shaft	44T	27	26	54.3	91	615				
	1993.04-1996.08	AT	R	F	Estate Engine NGA	GDS18003	Drive Shaft		27	35	54.3	91	566				
2.0 i 16V 4x4 (97 kW)	1993.04-1996.08	MT&AT		F	Estate Engine NGA	GC018024	Outer Joint	44T	27	30	57	91	56	M			
	1993.04-1996.08	AT	R	F	Estate Engine NGA	GDS18004	Drive Shaft	44T	27	35	54.3	91	566				
	1993.04-1996.08	MT&AT	R	F	Estate Engine NGA	GDS18005	Drive Shaft		27	35	57	91	566				
	1993.04-1996.08	MT	L	F	Estate Engine NGA	GDS18016	Drive Shaft		27	26	57	91	618.5				
	1993.04-1996.08	MT&AT	R	F	Estate Engine NGA	GDS18006	Drive Shaft	44T	27	35	57	91	566				
	1993.04-1996.08				Estate Engine NGA	GC018052	Outer Joint		27	30	57	91	56	I			
2.5 i 24V (125 kW)	1993.04-1996.08	MT	L	F	Estate Engine NGA	GDS18002	Drive Shaft	44T	27	26	54.3	91	615				
	1994.12-1996.08	MT		F	Estate Engine NGA	GC018024	Outer Joint	44T	27	30	57	91	56	M			
	1994.12-1996.08	MT	L	F	Estate Engine NGA	GDS18002	Drive Shaft	44T	27	26	54.3	91	615				
	1994.12-1996.08	MT		F	Estate Engine NGA	GC018024	Outer Joint	44T	27	30	57	91	56	M			
MONDEO (CA2)	1994.07-1996.08	MT/AT	R	F	Estate Engine SEA	GDS18004	Drive Shaft	44T	27	35	54.3	91	566				
	1994.07-1996.08	MT/AT		F	Estate Engine SEA	GC018011	Outer Joint	44T	27	25	57	91	61	I			
	1994.07-1996.08	MT/AT		F	Estate Engine SEA	GC018010	Outer Joint		27	25	57	91	61	I			
	1994.07-1996.08	MT	L	F	Estate Engine SEA	GDS18001	Drive Shaft		27	26	54.3	91	615				
	1994.07-1996.08	MT/AT	R	F	Estate Engine SEA	GDS18003	Drive Shaft		27	35	54.3	91	566				
	1994.07-1996.08	MT	L	F	Estate Engine SEA	GDS18002	Drive Shaft	44T	27	26	54.3	91	615				
-	2007-					GCI18128	Inner Joint		26	28	40	68.5	111				
<b>MONDEO (GBP)</b>																	
1.6 i 16V (65 kW)	1994.07-1996.08			F	Saloon Engine L1J	GC018052	Outer Joint		27	30	57	91	56	I			
	1994.07-1996.08	MT	L	F	Hatchback Engine L1J	GDS18002	Drive Shaft	44T	27	26	54.3	91	615				
	1994.07-1996.08	MT	L	F	Saloon Engine L1J	GDS18002	Drive Shaft	44T	27	26	54.3	91	615				





		TRANSM	L/R	F/R		G-AP Ref.	PRODUCT	ABS	Technical Specifications							
									YEAR	A	B	C	H	L	P	
<b>FORD MONDEO (GBP)</b>																
1.6 i 16V (65 kW)	1994.07-1996.08	MT		F	Hatchback Engine L1J	GC018024	Outer Joint	44T	27	30	57	91	56	M		
	1994.07-1996.08	MT		F	Saloon Engine L1J	GC018024	Outer Joint	44T	27	30	57	91	56	M		
	1994.07-1996.08	MT	R	F	Hatchback Engine L1J	GDS18005	Drive Shaft		27	35	57	91	566			
	1994.07-1996.08	MT	R	F	Saloon Engine L1J	GDS18005	Drive Shaft		27	35	57	91	566			
	1994.07-1996.08	MT	L	F	Hatchback Engine L1J	GDS18016	Drive Shaft		27	26	57	91	618.5			
	1994.07-1996.08	MT	L	F	Saloon Engine L1J	GDS18016	Drive Shaft		27	26	57	91	618.5			
	1994.07-1996.08	MT	R	F	Hatchback Engine L1J	GDS18006	Drive Shaft	44T	27	35	57	91	566			
	1994.07-1996.08	MT	R	F	Saloon Engine L1J	GDS18006	Drive Shaft	44T	27	35	57	91	566			
	1994.07-1996.08	MT		F	Hatchback Engine L1J	GC018023	Outer Joint	44T	27	30	57	91	56	I		
	1994.07-1996.08	MT		F	Saloon Engine L1J	GC018023	Outer Joint	44T	27	30	57	91	56	I		
1994.07-1996.08				F	Hatchback Engine L1J	GC018052	Outer Joint		27	30	57	91	56	I		
1.6 i 16V (66 kW)	1993.02-1996.08	MT	R	F	Hatchback Engine L1F	GDS18005	Drive Shaft		27	35	57	91	566			
	1993.02-1996.08	MT	R	F	Saloon Engine L1F	GDS18005	Drive Shaft		27	35	57	91	566			
	1993.02-1996.08	MT	L	F	Hatchback Engine L1F	GDS18016	Drive Shaft		27	26	57	91	618.5			
	1993.02-1996.08	MT	L	F	Saloon Engine L1F	GDS18016	Drive Shaft		27	26	57	91	618.5			
	1993.02-1996.08	MT	R	F	Hatchback Engine L1F	GDS18006	Drive Shaft	44T	27	35	57	91	566			
	1993.02-1996.08	MT	R	F	Saloon Engine L1F	GDS18006	Drive Shaft	44T	27	35	57	91	566			
	1993.02-1996.08	MT		F	Hatchback Engine L1F	GC018023	Outer Joint	44T	27	30	57	91	56	I		
	1993.02-1996.08	MT		F	Saloon Engine L1F	GC018023	Outer Joint	44T	27	30	57	91	56	I		
	1993.02-1996.08				F	Hatchback Engine L1F	GC018052	Outer Joint		27	30	57	91	56	I	
	1993.02-1996.08				F	Saloon Engine L1F	GC018052	Outer Joint		27	30	57	91	56	I	
	1993.02-1996.08	MT	L	F	Hatchback Engine L1F	GDS18002	Drive Shaft	44T	27	26	54.3	91	615			
	1993.02-1996.08	MT	L	F	Saloon Engine L1F	GDS18002	Drive Shaft	44T	27	26	54.3	91	615			
	1993.02-1996.08	MT		F	Hatchback Engine L1F	GC018024	Outer Joint	44T	27	30	57	91	56	M		
1993.02-1996.08	MT		F	Saloon Engine L1F	GC018024	Outer Joint	44T	27	30	57	91	56	M			
1.8 i 16V (82 kW)	1994.01-1996.08	AT	R	F	Saloon Engine RKB	GDS18004	Drive Shaft	44T	27	35	54.3	91	566			
	1994.01-1996.08	MT&AT	R	F	Saloon Engine RKB	GDS18005	Drive Shaft		27	35	57	91	566			
	1994.01-1996.08	MT	L	F	Saloon Engine RKB	GDS18016	Drive Shaft		27	26	57	91	618.5			
	1994.01-1996.08	AT		F	Saloon Engine RKB	GC018011	Outer Joint	44T	27	25	57	91	61	I		
	1994.01-1996.08	MT&AT	R	F	Saloon Engine RKB	GDS18006	Drive Shaft	44T	27	35	57	91	566			
	1994.01-1996.08	MT&AT		F	Saloon Engine RKB	GC018023	Outer Joint	44T	27	30	57	91	56	I		
	1994.01-1996.08				F	Saloon Engine RKB	GC018052	Outer Joint		27	30	57	91	56	I	
	1994.01-1996.08	AT		F	Saloon Engine RKB	GC018010	Outer Joint		27	25	57	91	61	I		
	1994.01-1996.08	MT	L	F	Saloon Engine RKB	GDS18002	Drive Shaft	44T	27	26	54.3	91	615			
	1994.01-1996.08	AT	R	F	Saloon Engine RKB	GDS18003	Drive Shaft		27	35	54.3	91	566			
	1994.01-1996.08	MT&AT		F	Saloon Engine RKB	GC018024	Outer Joint	44T	27	30	57	91	56	M		
	1994.07-1996.08	AT	R	F	Hatchback Engine RKB	GDS18004	Drive Shaft	44T	27	35	54.3	91	566			
	1994.07-1996.08	MT&AT	R	F	Hatchback Engine RKB	GDS18005	Drive Shaft		27	35	57	91	566			
	1994.07-1996.08	MT	L	F	Hatchback Engine RKB	GDS18016	Drive Shaft		27	26	57	91	618.5			
	1994.07-1996.08	AT		F	Hatchback Engine RKB	GC018011	Outer Joint	44T	27	25	57	91	61	I		
	1994.07-1996.08	MT&AT	R	F	Hatchback Engine RKB	GDS18006	Drive Shaft	44T	27	35	57	91	566			
	1994.07-1996.08	MT		F	Hatchback Engine RKB	GC018023	Outer Joint	44T	27	30	57	91	56	I		
	1994.07-1996.08				F	Hatchback Engine RKB	GC018052	Outer Joint		27	30	57	91	56	I	
	1994.07-1996.08	AT		F	Hatchback Engine RKB	GC018010	Outer Joint		27	25	57	91	61	I		
	1994.07-1996.08	MT	L	F	Hatchback Engine RKB	GDS18002	Drive Shaft	44T	27	26	54.3	91	615			
1994.07-1996.08	AT	R	F	Hatchback Engine RKB	GDS18003	Drive Shaft		27	35	54.3	91	566				
1994.07-1996.08	MT&AT		F	Hatchback Engine RKB	GC018024	Outer Joint	44T	27	30	57	91	56	M			
1.8 i 16V (85 kW)	1993.02-1996.08	AT	R	F	Hatchback Engine RKA	GDS18004	Drive Shaft	44T	27	35	54.3	91	566			
	1993.02-1996.08	AT	R	F	Saloon Engine RKA	GDS18004	Drive Shaft	44T	27	35	54.3	91	566			
	1993.02-1996.08	MT&AT	R	F	Hatchback Engine RKA	GDS18005	Drive Shaft		27	35	57	91	566			
	1993.02-1996.08	MT&AT	R	F	Saloon Engine RKA	GDS18005	Drive Shaft		27	35	57	91	566			
	1993.02-1996.08	MT	L	F	Hatchback Engine RKA	GDS18016	Drive Shaft		27	26	57	91	618.5			
	1993.02-1996.08	MT	L	F	Saloon Engine RKA	GDS18016	Drive Shaft		27	26	57	91	618.5			
	1993.02-1996.08	AT		F	Hatchback Engine RKA	GC018011	Outer Joint	44T	27	25	57	91	61	I		
	1993.02-1996.08	AT		F	Saloon Engine RKA	GC018011	Outer Joint	44T	27	25	57	91	61	I		
	1993.02-1996.08	MT&AT	R	F	Hatchback Engine RKA	GDS18006	Drive Shaft	44T	27	35	57	91	566			
	1993.02-1996.08	MT&AT	R	F	Saloon Engine RKA	GDS18006	Drive Shaft	44T	27	35	57	91	566			
	1993.02-1996.08	MT		F	Saloon Engine RKA	GC018023	Outer Joint	44T	27	30	57	91	56	I		
	1993.02-1996.08				F	Hatchback Engine RKA	GC018023	Outer Joint	44T	27	30	57	91	56	I	
	1993.02-1996.08				F	Hatchback Engine RKA	GC018052	Outer Joint		27	30	57	91	56	I	
	1993.02-1996.08				F	Saloon Engine RKA	GC018052	Outer Joint		27	30	57	91	56	I	
	1993.02-1996.08	AT		F	Hatchback Engine RKA	GC018010	Outer Joint		27	25	57	91	61	I		
	1993.02-1996.08	AT		F	Saloon Engine RKA	GC018010	Outer Joint		27	25	57	91	61	I		



		TRANSM	L/R	F/R		G-AP Ref.	PRODUCT	ABS	Technical Specifications					
									YEAR	A	B	C	H	L
<b>FORD MONDEO (GBP)</b>	1993.02-1996.08	MT	L	F	Hatchback Engine RKA	GDS18002	Drive Shaft	44T	27	26	54.3	91	615	
	1993.02-1996.08	MT	L	F	Saloon Engine RKA	GDS18002	Drive Shaft	44T	27	26	54.3	91	615	
	1993.02-1996.08	AT	R	F	Hatchback Engine RKA	GDS18003	Drive Shaft		27	35	54.3	91	566	
	1993.02-1996.08	AT	R	F	Saloon Engine RKA	GDS18003	Drive Shaft		27	35	54.3	91	566	
	1993.02-1996.08	MT&AT		F	Hatchback Engine RKA	GC018024	Outer Joint	44T	27	30	57	91	56	M
	1993.02-1996.08	MT&AT		F	Saloon Engine RKA	GC018024	Outer Joint	44T	27	30	57	91	56	M
1.8 i 16V 4x4 (85 kW)	1993.02-1996.08	AT	R	F	Hatchback Engine RKA	GDS18004	Drive Shaft	44T	27	35	54.3	91	566	
	1993.02-1996.08	MT&AT	R	F	Hatchback Engine RKA	GDS18005	Drive Shaft		27	35	57	91	566	
	1993.02-1996.08	MT	L	F	Hatchback Engine RKA	GDS18016	Drive Shaft		27	26	57	91	618.5	
	1993.02-1996.08	AT			Hatchback Engine RKA	GC018011	Outer Joint	44T	27	25	57	91	61	I
	1993.02-1996.08	MT&AT	R	F	Hatchback Engine RKA	GDS18006	Drive Shaft	44T	27	35	57	91	566	
	1993.02-1996.08	MT/AT			Hatchback Engine RKA	GC018023	Outer Joint	44T	27	30	57	91	56	I
	1993.02-1996.08				Hatchback Engine RKA	GC018052	Outer Joint		27	30	57	91	56	I
	1993.02-1996.08	AT			Hatchback Engine RKA	GC018010	Outer Joint		27	25	57	91	61	I
	1993.02-1996.08	MT	L	F	Hatchback Engine RKA	GDS18002	Drive Shaft	44T	27	26	54.3	91	615	
	1993.02-1996.08	AT	R	F	Hatchback Engine RKA	GDS18003	Drive Shaft		27	35	54.3	91	566	
	1993.02-1996.08	MT&AT		F	Hatchback Engine RKA	GC018024	Outer Joint	44T	27	30	57	91	56	M
	1.8 TD (65 kW)	1993.06-1996.08	MT	R	F	Hatchback Engine RFM/RFN	GDS18004	Drive Shaft	44T	27	35	54.3	91	566
1993.06-1996.08		MT	R	F	Saloon Engine RFM/RFN	GDS18004	Drive Shaft	44T	27	35	54.3	91	566	
1993.06-1996.08		MT		F	Hatchback Engine RFM/RFN	GC018011	Outer Joint	44T	27	25	57	91	61	I
1993.06-1996.08		MT		F	Saloon Engine RFM/RFN	GC018011	Outer Joint	44T	27	25	57	91	61	I
1993.06-1996.08		MT		F	Hatchback Engine RFM/RFN	GC018010	Outer Joint		27	25	57	91	61	I
1993.06-1996.08		MT		F	Saloon Engine RFM/RFN	GC018010	Outer Joint		27	25	57	91	61	I
1993.06-1996.08		MT	L	F	Hatchback Engine RFM/RFN	GDS18001	Drive Shaft		27	26	54.3	91	615	
1993.06-1996.08		MT	L	F	Saloon Engine RFM/RFN	GDS18001	Drive Shaft		27	26	54.3	91	615	
1993.06-1996.08		MT	R	F	Hatchback Engine RFM/RFN	GDS18003	Drive Shaft		27	35	54.3	91	566	
1993.06-1996.08		MT	R	F	Saloon Engine RFM/RFN	GDS18003	Drive Shaft		27	35	54.3	91	566	
1993.06-1996.08		MT	L	F	Hatchback Engine RFM/RFN	GDS18002	Drive Shaft	44T	27	26	54.3	91	615	
1993.06-1996.08		MT	L	F	Saloon Engine RFM/RFN	GDS18002	Drive Shaft	44T	27	26	54.3	91	615	
1.8 TD (66 kW)	1995.10-1996.08	MT	R	F	Hatchback Engine RFM/RFN	GDS18004	Drive Shaft	44T	27	35	54.3	91	566	
	1995.10-1996.08	MT	R	F	Saloon Engine RFM/RFN	GDS18004	Drive Shaft	44T	27	35	54.3	91	566	
	1995.10-1996.08	MT		F	Hatchback Engine RFM/RFN	GC018011	Outer Joint	44T	27	25	57	91	61	I
	1995.10-1996.08	MT		F	Saloon Engine RFM/RFN	GC018011	Outer Joint	44T	27	25	57	91	61	I
	1995.10-1996.08	MT		F	Hatchback Engine RFM/RFN	GC018010	Outer Joint		27	25	57	91	61	I
	1995.10-1996.08	MT		F	Saloon Engine RFM/RFN	GC018010	Outer Joint		27	25	57	91	61	I
	1995.10-1996.08	MT	L	F	Hatchback Engine RFM/RFN	GDS18001	Drive Shaft		27	26	54.3	91	615	
	1995.10-1996.08	MT	L	F	Saloon Engine RFM/RFN	GDS18001	Drive Shaft		27	26	54.3	91	615	
	1995.10-1996.08	MT	R	F	Hatchback Engine RFM/RFN	GDS18003	Drive Shaft		27	35	54.3	91	566	
	1995.10-1996.08	MT	R	F	Saloon Engine RFM/RFN	GDS18003	Drive Shaft		27	35	54.3	91	566	
	1995.10-1996.08	MT	L	F	Hatchback Engine RFM/RFN	GDS18002	Drive Shaft	44T	27	26	54.3	91	615	
	1995.10-1996.08	MT	L	F	Saloon Engine RFM/RFN	GDS18002	Drive Shaft	44T	27	26	54.3	91	615	
2.0 i 16V (100 kW)	1993.02-1996.08	AT	R	F	Hatchback Engine NGA	GDS18004	Drive Shaft	44T	27	35	54.3	91	566	
	1993.02-1996.08	AT	R	F	Saloon Engine NGA	GDS18004	Drive Shaft	44T	27	35	54.3	91	566	
	1993.02-1996.08	MT&AT	R	F	Hatchback Engine NGA	GDS18005	Drive Shaft		27	35	57	91	566	
	1993.02-1996.08	MT&AT	R	F	Saloon Engine NGA	GDS18005	Drive Shaft		27	35	57	91	566	
	1993.02-1996.08	MT	L	F	Hatchback Engine NGA	GDS18016	Drive Shaft		27	26	57	91	618.5	
	1993.02-1996.08	MT	L	F	Saloon Engine NGA	GDS18016	Drive Shaft		27	26	57	91	618.5	
	1993.02-1996.08	AT		F	Hatchback Engine NGA	GC018011	Outer Joint	44T	27	25	57	91	61	I
	1993.02-1996.08	AT		F	Saloon Engine NGA	GC018011	Outer Joint	44T	27	25	57	91	61	I
	1993.02-1996.08	MT&AT	R	F	Hatchback Engine NGA	GDS18006	Drive Shaft	44T	27	35	57	91	566	
	1993.02-1996.08	MT&AT	R	F	Saloon Engine NGA	GDS18006	Drive Shaft	44T	27	35	57	91	566	
	1993.02-1996.08	MT		F	Hatchback Engine NGA	GC018023	Outer Joint	44T	27	30	57	91	56	I
	1993.02-1996.08	MT&AT		F	Saloon Engine NGA	GC018023	Outer Joint	44T	27	30	57	91	56	I
	1993.02-1996.08			F	Hatchback Engine NGA	GC018052	Outer Joint		27	30	57	91	56	I
	1993.02-1996.08			F	Saloon Engine NGA	GC018052	Outer Joint		27	30	57	91	56	I
	1993.02-1996.08	AT		F	Hatchback Engine NGA	GC018010	Outer Joint		27	25	57	91	61	I
	1993.02-1996.08	AT		F	Saloon Engine NGA	GC018010	Outer Joint		27	25	57	91	61	I
	1993.02-1996.08	MT	L	F	Hatchback Engine NGA	GDS18002	Drive Shaft	44T	27	26	54.3	91	615	
	1993.02-1996.08	MT	L	F	Saloon Engine NGA	GDS18002	Drive Shaft	44T	27	26	54.3	91	615	
	1993.02-1996.08	AT	R	F	Hatchback Engine NGA	GDS18003	Drive Shaft		27	35	54.3	91	566	
	1993.02-1996.08	AT	R	F	Saloon Engine NGA	GDS18003	Drive Shaft		27	35	54.3	91	566	
	1993.02-1996.08	MT&AT		F	Hatchback Engine NGA	GC018024	Outer Joint	44T	27	30	57	91	56	M
	1993.02-1996.08	MT&AT		F	Saloon Engine NGA	GC018024	Outer Joint	44T	27	30	57	91	56	M





		TRANSM	L/R	F/R		G-AP Ref.	PRODUCT	ABS	Technical Specifications								
									YEAR	A	B	C	H	L	P		
<b>FORD MONDEO (GBP)</b>																	
2.0 i 16V 4x4 (97 kW)	1994.12-1996.08	AT		F	Saloon Engine NGA	GC018011	Outer Joint	44T	27	25	57	91	61	I			
	1994.12-1996.08	MT		F	Hatchback Engine NGA	GC018011	Outer Joint	44T	27	25	57	91	61	I			
	1994.12-1996.08	MT	R	F	Hatchback Engine NGA	GDS18006	Drive Shaft	44T	27	35	57	91	566				
	1994.12-1996.08	MT	R	F	Saloon Engine NGA	GDS18006	Drive Shaft	44T	27	35	57	91	566				
	1994.12-1996.08	MT			Hatchback Engine NGA	GC018023	Outer Joint	44T	27	30	57	91	56	I			
	1994.12-1996.08	MT/AT		F	Saloon Engine NGA	GC018023	Outer Joint	44T	27	30	57	91	56	I			
	1994.12-1996.08				Hatchback Engine NGA	GC018052	Outer Joint		27	30	57	91	56	I			
	1994.12-1996.08				Saloon Engine NGA	GC018052	Outer Joint		27	30	57	91	56	I			
	1994.12-1996.08	AT		F	Hatchback Engine NGA	GC018010	Outer Joint		27	25	57	91	61	I			
	1994.12-1996.08	AT		F	Saloon Engine NGA	GC018010	Outer Joint		27	25	57	91	61	I			
	1994.12-1996.08	MT	L	F	Hatchback Engine NGA	GDS18002	Drive Shaft	44T	27	26	54.3	91	615				
	1994.12-1996.08	MT	L	F	Saloon Engine NGA	GDS18002	Drive Shaft	44T	27	26	54.3	91	615				
	1994.12-1996.08	MT		F	Hatchback Engine NGA	GC018024	Outer Joint	44T	27	30	57	91	56	M			
	1994.12-1996.08	MT		F	Saloon Engine NGA	GC018024	Outer Joint	44T	27	30	57	91	56	M			
2.5 i 24V (125 kW)	1994.07-1996.08	MT/AT	R	F	Hatchback Engine SEA	GDS18004	Drive Shaft	44T	27	35	54.3	91	566				
	1994.07-1996.08	MT/AT	R	F	Saloon Engine SEA	GDS18004	Drive Shaft	44T	27	35	54.3	91	566				
	1994.07-1996.08	MT/AT		F	Hatchback Engine SEA	GC018011	Outer Joint	44T	27	25	57	91	61	I			
	1994.07-1996.08	MT/AT		F	Saloon Engine SEA	GC018011	Outer Joint	44T	27	25	57	91	61	I			
	1994.07-1996.08	MT/AT		F	Hatchback Engine SEA	GC018010	Outer Joint		27	25	57	91	61	I			
	1994.07-1996.08	MT/AT		F	Saloon Engine SEA	GC018010	Outer Joint		27	25	57	91	61	I			
	1994.07-1996.08	MT	L	F	Hatchback Engine SEA	GDS18001	Drive Shaft		27	26	54.3	91	615				
	1994.07-1996.08	MT	L	F	Saloon Engine SEA	GDS18001	Drive Shaft		27	26	54.3	91	615				
	1994.07-1996.08	MT/AT	R	F	Hatchback Engine SEA	GDS18003	Drive Shaft		27	35	54.3	91	566				
	1994.07-1996.08	MT/AT	R	F	Saloon Engine SEA	GDS18003	Drive Shaft		27	35	54.3	91	566				
	1994.07-1996.08	MT	L	F	Hatchback Engine SEA	GDS18002	Drive Shaft	44T	27	26	54.3	91	615				
	1994.07-1996.08	MT	L	F	Saloon Engine SEA	GDS18002	Drive Shaft	44T	27	26	54.3	91	615				
	<b>MONDEO II (BAP)</b>																
	1.6 i (66 kW)	1996.09-2000.11	MT	R	F	Hatchback Engine L1J	GDS18005	Drive Shaft		27	35	57	91	566			
1996.09-2000.11		MT	L	F	Hatchback Engine L1J	GDS18016	Drive Shaft		27	26	57	91	618.5				
1996.09-2000.11		MT	R	F	Hatchback Engine L1J	GDS18006	Drive Shaft	44T	27	35	57	91	566				
1996.09-2000.11				F	Hatchback Engine L1J	GC018023	Outer Joint	44T	27	30	57	91	56	I			
1996.09-2000.11				F	Hatchback Engine L1J	GC018052	Outer Joint		27	30	57	91	56	I			
1996.09-2000.11		MT	L	F	Hatchback Engine L1J	GDS18002	Drive Shaft	44T	27	26	54.3	91	615				
1.6 i 16V (70 kW)	1998.05-2000.11	MT	R	F	Hatchback Engine L1L/L1N/L1Q	GDS18005	Drive Shaft		27	35	57	91	566				
	1998.05-2000.11	MT	L	F	Hatchback Engine L1L/L1N/L1Q	GDS18016	Drive Shaft		27	26	57	91	618.5				
	1998.05-2000.11	MT	R	F	Hatchback Engine L1L/L1N/L1Q	GDS18006	Drive Shaft	44T	27	35	57	91	566				
	1998.05-2000.11			F	Hatchback Engine L1L/L1N/L1Q	GC018023	Outer Joint	44T	27	30	57	91	56	I			
	1998.05-2000.11			F	Hatchback Engine L1L/L1N/L1Q	GC018052	Outer Joint		27	30	57	91	56	I			
	1998.05-2000.11	MT	L	F	Hatchback Engine L1L/L1N/L1Q	GDS18002	Drive Shaft	44T	27	26	54.3	91	615				
1.8 i (85 kW)	1996.09-2000.11	MT	R	F	Hatchback Engine RKB/RKF/RKH/RKJ/RKK	GDS18005	Drive Shaft		27	35	57	91	566				
	1996.09-2000.11	MT	L	F	Hatchback Engine RKB/RKF/RKH/RKJ/RKK	GDS18016	Drive Shaft		27	26	57	91	618.5				
	1996.09-2000.11	MT	R	F	Hatchback Engine RKB/RKF/RKH/RKJ/RKK	GDS18006	Drive Shaft	44T	27	35	57	91	566				
	1996.09-2000.11			F	Hatchback Engine RKB/RKF/RKH/RKJ/RKK	GC018023	Outer Joint	44T	27	30	57	91	56	I			
	1996.09-2000.11			F	Hatchback Engine RKB/RKF/RKH/RKJ/RKK	GC018052	Outer Joint		27	30	57	91	56	I			
	1996.09-2000.11	MT	L	F	Hatchback Engine RKB/RKF/RKH/RKJ/RKK	GDS18002	Drive Shaft	44T	27	26	54.3	91	615				
1.8 TD (66 kW)	1996.09-2000.11	MT/AT		F	Hatchback Engine RKB/RKF/RKH/RKJ/RKK	GC018024	Outer Joint	44T	27	30	57	91	56	M			
	1996.09-2000.11	MT	R	F	Hatchback Engine RFN	GDS18004	Drive Shaft	44T	27	35	54.3	91	566				
	1996.09-2000.11	MT		F	Hatchback Engine RFN	GC018011	Outer Joint	44T	27	25	57	91	61	I			
	1996.09-2000.11	MT	L	F	Hatchback Engine RFN	GDS18001	Drive Shaft		27	26	54.3	91	615				
	1996.09-2000.11	MT	R	F	Hatchback Engine RFN	GDS18003	Drive Shaft		27	35	54.3	91	566				
	1996.09-2000.11	MT	L	F	Hatchback Engine RFN	GDS18002	Drive Shaft	44T	27	26	54.3	91	615				
2.0 i (96 kW)	1996.09-2000.11	MT	R	F	Hatchback Engine NGA/NGB/NGC/NGD	GDS18005	Drive Shaft		27	35	57	91	566				
	1996.09-2000.11	MT	L	F	Hatchback Engine NGA/NGB/NGC/NGD	GDS18016	Drive Shaft		27	26	57	91	618.5				
	1996.09-2000.11	MT	R	F	Hatchback Engine NGA/NGB/NGC/NGD	GDS18006	Drive Shaft	44T	27	35	57	91	566				
	1996.09-2000.11			F	Hatchback Engine NGA/NGB/NGC/NGD	GC018023	Outer Joint	44T	27	30	57	91	56	I			
	1996.09-2000.11			F	Hatchback Engine NGA/NGB/NGC/NGD	GC018052	Outer Joint		27	30	57	91	56	I			
	1996.09-2000.11	MT	L	F	Hatchback Engine NGA/NGB/NGC/NGD	GDS18002	Drive Shaft	44T	27	26	54.3	91	615				
2.5 24V (125 kW)	1996.09-2000.11	MT/AT		F	Hatchback Engine NGA/NGB/NGC/NGD	GC018024	Outer Joint	44T	27	30	57	91	56	M			
	1996.09-2000.11	MT	R	F	Hatchback Engine SEA	GDS18004	Drive Shaft	44T	27	35	54.3	91	566				
1996.09-2000.11	MT		F	Hatchback Engine SEA	GC018011	Outer Joint	44T	27	25	57	91	61	I				





		YEAR	TRANSM	L/R	F/R		G-AP Ref.	PRODUCT	ABS	Technical Specifications											
										A	B	C	H	L	P						
<b>FORD MONDEO II (BAP)</b>																					
2.5 24V (125 kW)	1996.09-2000.11	2000.11	MT	L	F	Hatchback Engine SEA	GDS18001	Drive Shaft		27	26	54.3	91	615							
	1996.09-2000.11	2000.11	MT	R	F	Hatchback Engine SEA	GDS18003	Drive Shaft		27	35	54.3	91	566							
	1996.09-2000.11	2000.11	MT	L	F	Hatchback Engine SEA	GDS18002	Drive Shaft	44T	27	26	54.3	91	615							
	2000.06-2000.11	2000.11	MT	L	F	Hatchback Engine SEB/SEC	GDS18002	Drive Shaft	44T	27	26	54.3	91	615							
<b>MONDEO II (BFP)</b>																					
1.6 i (66 kW)	1996.09-2000.11	2000.11	MT	R	F	Saloon Engine L1J	GDS18005	Drive Shaft		27	35	57	91	566							
	1996.09-2000.11	2000.11	MT	L	F	Saloon Engine L1J	GDS18016	Drive Shaft		27	26	57	91	618.5							
	1996.09-2000.11	2000.11	MT	R	F	Saloon Engine L1J	GDS18006	Drive Shaft	44T	27	35	57	91	566							
	1996.09-2000.11	2000.11			F	Saloon Engine L1J	GC018023	Outer Joint	44T	27	30	57	91	56	I						
	1996.09-2000.11	2000.11			F	Saloon Engine L1J	GC018052	Outer Joint		27	30	57	91	56	I						
	1996.09-2000.11	2000.11	MT	L	F	Saloon Engine L1J	GDS18002	Drive Shaft	44T	27	26	54.3	91	615							
1.6 i 16V (70 kW)	1996.09-2000.11	2000.11	MT		F	Saloon Engine L1J	GC018024	Outer Joint	44T	27	30	57	91	56	M						
	1998.05-2000.11	2000.11	MT	R	F	Saloon Engine L1L/L1N/L1Q	GDS18005	Drive Shaft		27	35	57	91	566							
	1998.05-2000.11	2000.11	MT	L	F	Saloon Engine L1L/L1N/L1Q	GDS18016	Drive Shaft		27	26	57	91	618.5							
	1998.05-2000.11	2000.11	MT	R	F	Saloon Engine L1L/L1N/L1Q	GDS18006	Drive Shaft	44T	27	35	57	91	566							
	1998.05-2000.11	2000.11			F	Saloon Engine L1L/L1N/L1Q	GC018023	Outer Joint	44T	27	30	57	91	56	I						
	1998.05-2000.11	2000.11			F	Saloon Engine L1L/L1N/L1Q	GC018052	Outer Joint		27	30	57	91	56	I						
1.8 i (85 kW)	1998.05-2000.11	2000.11	MT	L	F	Saloon Engine L1L/L1N/L1Q	GDS18002	Drive Shaft	44T	27	26	54.3	91	615							
	1998.05-2000.11	2000.11	MT		F	Saloon Engine L1L/L1N/L1Q	GC018024	Outer Joint	44T	27	30	57	91	56	M						
	1996.09-2000.11	2000.11	MT	R	F	Saloon Engine RKB/RKF/RKH/RKJ/RKK	GDS18005	Drive Shaft		27	35	57	91	566							
	1996.09-2000.11	2000.11	MT	L	F	Saloon Engine RKB/RKF/RKH/RKJ/RKK	GDS18016	Drive Shaft		27	26	57	91	618.5							
	1996.09-2000.11	2000.11	MT	R	F	Saloon Engine RKB/RKF/RKH/RKJ/RKK	GDS18006	Drive Shaft	44T	27	35	57	91	566							
	1996.09-2000.11	2000.11			F	Saloon Engine RKB/RKF/RKH/RKJ/RKK	GC018023	Outer Joint	44T	27	30	57	91	56	I						
1.8 TD (66 kW)	1996.09-2000.11	2000.11			F	Saloon Engine RKB/RKF/RKH/RKJ/RKK	GC018052	Outer Joint		27	30	57	91	56	I						
	1996.09-2000.11	2000.11	MT	L	F	Saloon Engine RKB/RKF/RKH/RKJ/RKK	GDS18002	Drive Shaft	44T	27	26	54.3	91	615							
	1996.09-2000.11	2000.11	MT&AT		F	Saloon Engine RKB/RKF/RKH/RKJ/RKK	GC018024	Outer Joint	44T	27	30	57	91	56	M						
	1996.09-2000.11	2000.11	MT	R	F	Saloon Engine RFN	GDS18004	Drive Shaft	44T	27	35	54.3	91	566							
	1996.09-2000.11	2000.11			F	Saloon Engine RFN	GC018011	Outer Joint	44T	27	25	57	91	61	I						
	1996.09-2000.11	2000.11	MT	L	F	Saloon Engine RFN	GDS18001	Drive Shaft		27	26	54.3	91	615							
2.0 i (96 kW)	1996.09-2000.11	2000.11	MT	R	F	Saloon Engine RFN	GDS18003	Drive Shaft		27	35	54.3	91	566							
	1996.09-2000.11	2000.11	MT	L	F	Saloon Engine RFN	GDS18002	Drive Shaft	44T	27	26	54.3	91	615							
	1996.09-2000.11	2000.11	MT	R	F	Saloon Engine NGA/NGB/NGC/NGD	GDS18005	Drive Shaft		27	35	57	91	566							
	1996.09-2000.11	2000.11	MT	L	F	Saloon Engine NGA/NGB/NGC/NGD	GDS18016	Drive Shaft		27	26	57	91	618.5							
	1996.09-2000.11	2000.11	MT	R	F	Saloon Engine NGA/NGB/NGC/NGD	GDS18006	Drive Shaft	44T	27	35	57	91	566							
	1996.09-2000.11	2000.11			F	Saloon Engine NGA/NGB/NGC/NGD	GC018023	Outer Joint	44T	27	30	57	91	56	I						
2.5 24V (125 kW)	1996.09-2000.11	2000.11			F	Saloon Engine NGA/NGB/NGC/NGD	GC018052	Outer Joint		27	30	57	91	56	I						
	1996.09-2000.11	2000.11	MT	L	F	Saloon Engine NGA/NGB/NGC/NGD	GDS18002	Drive Shaft	44T	27	26	54.3	91	615							
	1996.09-2000.11	2000.11	MT/AT		F	Saloon Engine NGA/NGB/NGC/NGD	GC018024	Outer Joint	44T	27	30	57	91	56	M						
	1996.09-2000.11	2000.11	MT	R	F	Saloon Engine SEA	GDS18004	Drive Shaft	44T	27	35	54.3	91	566							
	1996.09-2000.11	2000.11	MT		F	Saloon Engine SEA	GC018011	Outer Joint	44T	27	25	57	91	61	I						
	1996.09-2000.11	2000.11	MT	L	F	Saloon Engine SEA	GDS18001	Drive Shaft		27	26	54.3	91	615							
2.5 ST (151 kW)	1996.09-2000.11	2000.11	MT	R	F	Saloon Engine SEA	GDS18003	Drive Shaft		27	35	54.3	91	566							
	1996.09-2000.11	2000.11	MT	L	F	Saloon Engine SEA	GDS18002	Drive Shaft	44T	27	26	54.3	91	615							
	2000.06-2000.11	2000.11			F	Saloon Engine SEB/SEC	GDS18002	Drive Shaft	44T	27	26	54.3	91	615							
	1999.05-2000.11	2000.11	5MT	L	F	Saloon Engine SGA	GDS18002	Drive Shaft	44T	27	26	54.3	91	615							
	<b>MONDEO II (BNP)</b>																				
	1.6 i (66 kW)	1996.09-2000.11	2000.11	MT	R	F	Estate Engine L1J	GDS18005	Drive Shaft		27	35	57	91	566						
1996.09-2000.11		2000.11	MT	L	F	Estate Engine L1J	GDS18016	Drive Shaft		27	26	57	91	618.5							
1996.09-2000.11		2000.11	MT	R	F	Estate Engine L1J	GDS18006	Drive Shaft	44T	27	35	57	91	566							
1996.09-2000.11		2000.11			F	Estate Engine L1J	GC018052	Outer Joint		27	30	57	91	56	I						
1996.09-2000.11		2000.11	MT	L	F	Estate Engine L1J	GDS18002	Drive Shaft	44T	27	26	54.3	91	615							
1996.09-2000.11		2000.11	MT		F	Estate Engine L1J	GC018024	Outer Joint	44T	27	30	57	91	56	M						
1.6 i 16V (70 kW)	1998.05-2000.11	2000.11	MT	R	F	Estate Engine L1L/L1N/L1Q	GDS18005	Drive Shaft		27	35	57	91	566							
	1998.05-2000.11	2000.11	MT	L	F	Estate Engine L1L/L1N/L1Q	GDS18016	Drive Shaft		27	26	57	91	618.5							
	1998.05-2000.11	2000.11	MT	R	F	Estate Engine L1L/L1N/L1Q	GDS18006	Drive Shaft	44T	27	35	57	91	566							
	1998.05-2000.11	2000.11			F	Estate Engine L1L/L1N/L1Q	GC018052	Outer Joint		27	30	57	91	56	I						
	1998.05-2000.11	2000.11	MT	L	F	Estate Engine L1L/L1N/L1Q	GDS18002	Drive Shaft	44T	27	26	54.3	91	615							
	1998.05-2000.11	2000.11	MT		F	Estate Engine L1L/L1N/L1Q	GC018024	Outer Joint	44T	27	30	57	91	56	M						
1.8 i (85 kW)	1996.09-2000.11	2000.11	MT	R	F	Estate Engine RKB/RKF/RKH/RKJ/RKK	GDS18005	Drive Shaft		27	35	57	91	566							
	1996.09-2000.11	2000.11	MT	L	F	Estate Engine RKB/RKF/RKH/RKJ/RKK	GDS18016	Drive Shaft		27	26	57	91	618.5							
	1996.09-2000.11	2000.11	MT	R	F	Estate Engine RKB/RKF/RKH/RKJ/RKK	GDS18006	Drive Shaft	44T	27	35	57	91	566							
	1996.09-2000.11	2000.11			F	Estate Engine RKB/RKF/RKH/RKJ/RKK	GC018052	Outer Joint		27	30	57	91	56	I						



		YEAR	TRANSM	L/R	F/R		G-AP Ref.	PRODUCT	ABS	Technical Specifications										
										A	B	C	H	L	P					
<b>FORD MONDEO II (BNP)</b>																				
1.8 i (85 kW)	1996.09-	2000.11	MT	L	F	Estate Engine RKB/RKF/RKH/RKJ/RKK	GDS18002	Drive Shaft	44T	27	26	54.3	91	615						
	1996.09-	2000.11	MT/AT		F	Estate Engine RKB/RKF/RKH/RKJ/RKK	GC018024	Outer Joint	44T	27	30	57	91	56	M					
1.8 TD (66 kW)	1996.09-	2000.11	MT	R	F	Estate Engine RFN	GDS18004	Drive Shaft	44T	27	35	54.3	91	566						
	1996.09-	2000.11	MT	L	F	Estate Engine RFN	GDS18001	Drive Shaft		27	26	54.3	91	615						
	1996.09-	2000.11	MT	R	F	Estate Engine RFN	GDS18003	Drive Shaft		27	35	54.3	91	566						
	1996.09-	2000.11	MT	L	F	Estate Engine RFN	GDS18002	Drive Shaft	44T	27	26	54.3	91	615						
2.0 i (96 kW)	1996.09-	2000.11	MT	R	F	Estate Engine NGA/NGB/NGC/NGD	GDS18005	Drive Shaft		27	35	57	91	566						
	1996.09-	2000.11	MT	L	F	Estate Engine NGA/NGB/NGC/NGD	GDS18016	Drive Shaft		27	26	57	91	618.5						
	1996.09-	2000.11	MT	R	F	Estate Engine NGA/NGB/NGC/NGD	GDS18006	Drive Shaft	44T	27	35	57	91	566						
	1996.09-	2000.11			F	Estate Engine NGA/NGB/NGC/NGD	GC018052	Outer Joint		27	30	57	91	56	I					
	1996.09-	2000.11	MT	L	F	Estate Engine NGA/NGB/NGC/NGD	GDS18002	Drive Shaft	44T	27	26	54.3	91	615						
2.5 24V (125 kW)	1996.09-	2000.11	MT/AT		F	Estate Engine NGA/NGB/NGC/NGD	GC018024	Outer Joint	44T	27	30	57	91	56	M					
	1996.09-	2000.11	MT	L	F	Estate Engine SEA	GDS18002	Drive Shaft	44T	27	26	54.3	91	615						
	1996.09-	2000.11	MT	R	F	Estate Engine SEA	GDS18004	Drive Shaft	44T	27	35	54.3	91	566						
	1996.09-	2000.11	MT	L	F	Estate Engine SEA	GDS18001	Drive Shaft		27	26	54.3	91	615						
	1996.09-	2000.11	MT	R	F	Estate Engine SEA	GDS18003	Drive Shaft		27	35	54.3	91	566						
2.5 ST (151 kW)	1999.10-	2000.11	MT	L	F	Estate Engine SEB/SEC	GDS18002	Drive Shaft	44T	27	26	54.3	91	615						
	1999.05-	2000.11	5MT	L	F	Estate Engine SGA	GDS18002	Drive Shaft	44T	27	26	54.3	91	615						
<b>MONDEO III</b>																				
1.8	2000.10-		MT	L	F		GDS18143	Drive Shaft		27	26	57	91	626						
2.0	2000.10-		MT	L	F		GDS18143	Drive Shaft		27	26	57	91	626						
2.0 Di/TDCi	2000.10-		MT	R	F		GDS18043	Drive Shaft		27	35	56.5	92	579						
<b>MONDEO III (B4Y)</b>																				
1.8 16V (81 kW)	2000.11-	2007.08			F	Saloon Engine CGBA/CGBB	GC018007	Outer Joint		27	23	56.1	91.5	58.5	M					
	2000.11-	2007.08	MT	L	F	Saloon Engine CGBA/CGBB	GDS18027	Drive Shaft		27	26	57	91	627.5						
1.8 16V (92 kW)	2000.11-	2007.08			F	Saloon Engine CHBA/CHBB	GC018007	Outer Joint		27	23	56.1	91.5	58.5	M					
	2000.11-	2007.08		L	F	Saloon Engine CHBA/CHBB	GDS18027	Drive Shaft		27	26	57	91	627.5						
1.8 SCi (96 kW)	2003.06-	2007.08			F	Saloon Engine CFBA	GC018007	Outer Joint		27	23	56.1	91.5	58.5	M					
	2003.06-	2007.08	MT	L	F	Saloon Engine CFBA	GDS18027	Drive Shaft		27	26	57	91	627.5						
2.0 16V (107 kW)	2000.11-	2007.08			F	Saloon Engine CJBA/CJBB	GC018007	Outer Joint		27	23	56.1	91.5	58.5	M					
	2000.11-	2007.08		L	F	Saloon Engine CJBA/CJBB	GDS18027	Drive Shaft		27	26	57	91	627.5						
2.0 16V Di/TDDi/TDCi (66 kW)	2000.11-	2007.08			F	Saloon Engine D5BA/SDBA	GC018002	Outer Joint		27	26	56	91	64	M					
	2000.11-	2007.08	MT	L	F	Saloon Engine D5BA/SDBA	GDS18027	Drive Shaft		27	26	57	91	627.5						
2.0 16V TDDi/TDCi (85 kW)	2000.11-	2007.08			F	Saloon Engine D6BA/HJBA/HJBB/HJBC	GC018002	Outer Joint		27	26	56	91	64	M					
	2000.11-	2007.08	AT	L	F	Saloon Engine D6BA/HJBA/HJBB/HJBC	GDS18252	Drive Shaft		27	30	62.8	91	617						
	2000.11-	2007.08	MT	L	F	Saloon Engine D6BA/HJBA/HJBB/HJBC	GDS18027	Drive Shaft		27	26	57	91	627.5						
2.0 TDCi (96 kW)	2001.10-	2007.08			F	Saloon Engine FMBA/N7BA	GC018002	Outer Joint		27	26	56	91	64	M					
	2001.10-	2007.08	AT	L	F	Saloon Engine FMBA/N7BA	GDS18252	Drive Shaft		27	30	62.8	91	617						
	2001.10-	2007.08	MT	L	F	Saloon Engine FMBA/N7BA	GDS18027	Drive Shaft		27	26	57	91	627.5						
2.2 TDCi (110 kW)	2004.09-	2007.08		L	F	Saloon Engine QJBD/QJBC	GDS18027	Drive Shaft		27	26	57	91	627.5						
2.2 TDCi (114 kW)	2004.07-	2007.08	MT	L	F	Saloon Engine QJBA/QJBB	GDS18027	Drive Shaft		27	26	57	91	627.5						
2.5 V6 24V (125 kW)	2000.11-	2007.08			F	Saloon Engine LCB D	GC018002	Outer Joint		27	26	56	91	64	M					
	2000.11-	2007.08	AT	L	F	Saloon Engine LCB D	GDS18252	Drive Shaft		27	30	62.8	91	617						
	2000.11-	2007.08	MT	L	F	Saloon Engine LCB D	GDS18027	Drive Shaft		27	26	57	91	627.5						
	2000.11-	2007.08		R	F	Saloon Engine LCB D	GDS18028	Drive Shaft		27	35	57	91	576.5						
3.0 ST220 (166 kW)	2002.04-	2007.08			F	Saloon Engine MEBA	GC018002	Outer Joint		27	26	56	91	64	M					
	2002.04-	2007.08		L	F	Saloon Engine MEBA	GDS18027	Drive Shaft		27	26	57	91	627.5						
3.0 V6 24V (150 kW)	2005.05-	2007.08	MT	L	F	Saloon Engine REBA	GDS18027	Drive Shaft		27	26	57	91	627.5						
<b>MONDEO III (B5Y)</b>																				
1.8 16V (81 kW)	2000.11-	2007.08			F	Hatchback Engine CGBA/CGBB	GC018007	Outer Joint		27	23	56.1	91.5	58.5	M					
	2000.11-	2007.08	MT	L	F	Hatchback Engine CGBA/CGBB	GDS18027	Drive Shaft		27	26	57	91	627.5						
	2000.11-	2007.08		R	F	Hatchback Engine CGBA/CGBB	GDS18028	Drive Shaft		27	35	57	91	576.5						
1.8 16V (92 kW)	2000.11-	2007.08			F	Hatchback Engine CHBA/CHBB	GC018007	Outer Joint		27	23	56.1	91.5	58.5	M					
	2000.11-	2007.08	MT	L	F	Hatchback Engine CHBA/CHBB	GDS18027	Drive Shaft		27	26	57	91	627.5						
	2000.11-	2007.08	MT	R	F	Hatchback Engine CHBA/CHBB	GDS18028	Drive Shaft		27	35	57	91	576.5						
1.8 SCi (96 kW)	2005.05-	2007.08			F	Hatchback Engine CFBA	GC018007	Outer Joint		27	23	56.1	91.5	58.5	M					
	2005.05-	2007.08		R	F	Hatchback Engine CFBA	GDS18028	Drive Shaft		27	35	57	91	576.5						
2.0 16V (107 kW)	2000.11-	2007.08			F	Hatchback Engine CJBA/CJBB	GC018007	Outer Joint		27	23	56.1	91.5	58.5	M					
	2000.11-	2007.08	MT	L	F	Hatchback Engine CJBA/CJBB	GDS18027	Drive Shaft		27	26	57	91	627.5						
	2000.11-	2007.08	MT	R	F	Hatchback Engine CJBA/CJBB	GDS18028	Drive Shaft		27	35	57	91	576.5						
2.0 16V Di/TDDi/TDCi (66 kW)	2000.11-	2007.08			F	Hatchback Engine D5BA/SDBA	GC018002	Outer Joint		27	26	56	91	64	M					
	2000.11-	2007.08	AT	L	F	Hatchback Engine D5BA/SDBA	GDS18252	Drive Shaft		27	30	62.8	91	617						





		TRANSM	L/R	F/R		G-AP Ref.	PRODUCT	ABS	Technical Specifications					
									YEAR	A	B	C	H	L
<b>FORD</b>														
<b>MONDEO III (B5Y)</b>														
2.0 16V Di/TDDi/TDCi (66 kW)	2000.11-	2007.08	MT	L	F	Hatchback Engine D5BA/SDBA	GDS18027	Drive Shaft	27	26	57	91	627.5	
	2000.11-	2007.08	MT	R	F	Hatchback Engine D5BA/SDBA	GDS18028	Drive Shaft	27	35	57	91	576.5	
2.0 16V TDDi/TDCi (85 kW)	2000.11-	2007.08			F	Hatchback Engine D6BA/HJBA/HJBB/HJBC	GC018002	Outer Joint	27	26	56	91	64	M
	2000.11-	2007.08	AT	L	F	Hatchback Engine D6BA/HJBA/HJBB/HJBC	GDS18252	Drive Shaft	27	30	62.8	91	617	
	2000.11-	2007.08	MT	L	F	Hatchback Engine D6BA/HJBA/HJBB/HJBC	GDS18027	Drive Shaft	27	26	57	91	627.5	
	2000.11-	2007.08			R	F	Hatchback Engine D6BA/HJBA/HJBB/HJBC	GDS18028	Drive Shaft	27	35	57	91	576.5
	2000.11-	2007.08			F	Hatchback Engine D6BA/HJBA/HJBB/HJBC	GC018002	Outer Joint	27	26	56	91	64	M
2.0 TDCi (96 kW)	2001.10-	2007.08			F	Hatchback Engine FMBA/N7BA	GC018002	Outer Joint	27	26	56	91	64	M
	2001.10-	2007.08	AT	L	F	Hatchback Engine FMBA/N7BA	GDS18252	Drive Shaft	27	30	62.8	91	617	
	2001.10-	2007.08			L	F	Hatchback Engine FMBA/N7BA	GDS18027	Drive Shaft	27	26	57	91	627.5
	2001.10-	2007.08			R	F	Hatchback Engine FMBA/N7BA	GDS18028	Drive Shaft	27	35	57	91	576.5
2.2 TDCi (110 kW)	2004.09-	2007.08	MT	L	F	Hatchback Engine QJBD/QJBC	GDS18027	Drive Shaft	27	26	57	91	627.5	
	2004.09-	2007.08	MT	R	F	Hatchback Engine QJBD/QJBC	GDS18028	Drive Shaft	27	35	57	91	576.5	
2.2 TDCi (114 kW)	2005.08-	2007.08	MT	L	F	Hatchback Engine QJBA/QJBB	GDS18027	Drive Shaft	27	26	57	91	627.5	
	2005.08-	2007.08			R	F	Hatchback Engine QJBA/QJBB	GDS18028	Drive Shaft	27	35	57	91	576.5
2.5 V6 24V (125 kW)	2000.11-	2007.08			F	Hatchback Engine LCBD	GC018002	Outer Joint	27	26	56	91	64	M
	2000.11-	2007.08	AT	L	F	Hatchback Engine LCBD	GDS18252	Drive Shaft	27	30	62.8	91	617	
	2000.11-	2007.08	MT	L	F	Hatchback Engine LCBD	GDS18027	Drive Shaft	27	26	57	91	627.5	
	2000.11-	2007.08	MT	R	F	Hatchback Engine LCBD	GDS18028	Drive Shaft	27	35	57	91	576.5	
3.0 ST220 (166 kW)	2002.04-	2007.08			F	Hatchback Engine MEBA	GC018002	Outer Joint	27	26	56	91	64	M
	2002.04-	2007.08	MT	L	F	Hatchback Engine MEBA	GDS18027	Drive Shaft	27	26	57	91	627.5	
	2002.04-	2007.08	MT	R	F	Hatchback Engine MEBA	GDS18028	Drive Shaft	27	35	57	91	576.5	
3.0 V6 24V (150 kW)	2004.09-	2007.08			L	F	Hatchback Engine REBA	GDS18027	Drive Shaft	27	26	57	91	627.5
	2004.09-	2007.08			R	F	Hatchback Engine REBA	GDS18028	Drive Shaft	27	35	57	91	576.5
<b>MONDEO III (BWY)</b>														
1.8 16V (81 kW)	2000.11-	2007.08			F	Estate Engine CGBA/CGBB	GC018007	Outer Joint	27	23	56.1	91.5	58.5	M
	2000.11-	2007.08	MT	L	F	Estate Engine CGBA/CGBB	GDS18027	Drive Shaft	27	26	57	91	627.5	
1.8 16V (92 kW)	2000.11-	2007.08			F	Estate Engine CHBA/CHBB	GC018007	Outer Joint	27	23	56.1	91.5	58.5	M
	2000.11-	2007.08			L	F	Estate Engine CHBA/CHBB	GDS18027	Drive Shaft	27	26	57	91	627.5
1.8 SCi (96 kW)	2003.06-	2007.08			F	Estate Engine CFBA	GC018007	Outer Joint	27	23	56.1	91.5	58.5	M
	2003.06-	2007.08			L	F	Estate Engine CFBA	GDS18027	Drive Shaft	27	26	57	91	627.5
2.0 16V (107 kW)	2000.11-	2007.08			F	Estate Engine CJBA/CJBB	GC018007	Outer Joint	27	23	56.1	91.5	58.5	M
	2000.11-	2007.08	MT	L	F	Estate Engine CJBA/CJBB	GDS18027	Drive Shaft	27	26	57	91	627.5	
	2000.11-	2007.08			R	F	Estate Engine CJBA/CJBB	GDS18028	Drive Shaft	27	35	57	91	576.5
2.0 16V Di/TDDi/TDCi (66 kW)	2000.11-	2007.08			F	Estate Engine D5BA/SDBA	GC018002	Outer Joint	27	26	56	91	64	M
	2000.11-	2007.08	AT	L	F	Estate Engine D5BA/SDBA	GDS18252	Drive Shaft	27	30	62.8	91	617	
	2000.11-	2007.08			L	F	Estate Engine D5BA/SDBA	GDS18027	Drive Shaft	27	26	57	91	627.5
	2000.11-	2007.08			L	F	Estate Engine D5BA/SDBA	GDS61312	Drive Shaft	36		53	78	546
	2000.11-	2007.08			R	F	Estate Engine D5BA/SDBA	GDS18028	Drive Shaft	27	35	57	91	576.5
2.0 16V TDDi/TDCi (85 kW)	2000.11-	2007.08	MT	L	F	Estate Engine D6BA/HJBA/HJBB/HJBC	GDS18027	Drive Shaft	27	26	57	91	627.5	
	2000.11-	2007.08			R	F	Estate Engine D6BA/HJBA/HJBB/HJBC	GDS18028	Drive Shaft	27	35	57	91	576.5
	2000.11-	2007.08			F	Estate Engine D6BA/HJBA/HJBB/HJBC	GC018002	Outer Joint	27	26	56	91	64	M
	2000.11-	2007.08	AT	L	F	Estate Engine D6BA/HJBA/HJBB/HJBC	GDS18252	Drive Shaft	27	30	62.8	91	617	
	2000.11-	2007.08			L	F	Estate Engine D6BA/HJBA/HJBB/HJBC	GDS18027	Drive Shaft	27	26	57	91	627.5
2.0 TDCi (96 kW)	2001.10-	2007.08			F	Estate Engine FMBA/N7BA	GC018002	Outer Joint	27	26	56	91	64	M
	2001.10-	2007.08	AT	L	F	Estate Engine FMBA/N7BA	GDS18252	Drive Shaft	27	30	62.8	91	617	
	2001.10-	2007.08	MT	L	F	Estate Engine FMBA/N7BA	GDS18027	Drive Shaft	27	26	57	91	627.5	
	2001.10-	2007.08			R	F	Estate Engine FMBA/N7BA	GDS18028	Drive Shaft	27	35	57	91	576.5
2.2 TDCi (110 kW)	2004.09-	2007.08			L	F	Estate Engine QJBC/QJBD	GDS18027	Drive Shaft	27	26	57	91	627.5
	2004.09-	2007.08			R	F	Estate Engine QJBC/QJBD	GDS18028	Drive Shaft	27	35	57	91	576.5
2.2 TDCi (114 kW)	2004.07-	2007.08	MT	L	F	Estate Engine QJBA/QJBB	GDS18027	Drive Shaft	27	26	57	91	627.5	
	2004.07-	2007.08			R	F	Estate Engine QJBA/QJBB	GDS18028	Drive Shaft	27	35	57	91	576.5
2.5 V6 24V (125 kW)	2000.11-	2007.08			F	Estate Engine LCBD	GC018002	Outer Joint	27	26	56	91	64	M
	2000.11-	2007.08	AT	L	F	Estate Engine LCBD	GDS18252	Drive Shaft	27	30	62.8	91	617	
	2000.11-	2007.08			L	F	Estate Engine LCBD	GDS18027	Drive Shaft	27	26	57	91	627.5
	2000.11-	2007.08			R	F	Estate Engine LCBD	GDS18028	Drive Shaft	27	35	57	91	576.5
3.0 ST220 (166 kW)	2002.04-	2007.08			F	Estate Engine MEBA	GC018002	Outer Joint	27	26	56	91	64	M
	2002.04-	2007.08			L	F	Estate Engine MEBA	GDS18027	Drive Shaft	27	26	57	91	627.5
	2002.04-	2007.08			R	F	Estate Engine MEBA	GDS18028	Drive Shaft	27	35	57	91	576.5
3.0 V6 24V (150 kW)	2005.05-	2007.08	MT	L	F	Estate Engine REBA	GDS18027	Drive Shaft	27	26	57	91	627.5	
	2005.05-	2007.08	MT	R	F	Estate Engine REBA	GDS18028	Drive Shaft	27	35	57	91	576.5	
<b>MONDEO IV</b>														
1.6 TDCi (85 kW)	2011.02-		MT	L	F	Hatchback Engine T1BB/T1BA/T1BC	GDS99211	Drive Shaft	40	26	57.4	51	603	
	2011.02-		MT	L	F	Hatchback Engine T1BB/T1BA/T1BC	GCI18128	Inner Joint	26	28	40	68.5	111	









	 YEAR	TRANSM	L/R	F/R		G-AP Ref.	PRODUCT	ABS	Technical Specifications							
									A	B	C	H	L	P		
<b>FORD MONDEO IV</b>																
1.6 TDCi (85 kW)	2011.02-	MT	L/R	F	Hatchback Engine T1BB/T1BA/T1BC	GC099271	Outer Joint		40	28	57.4	51	63	M		
	2011.02-	MT	R	F	Hatchback Engine T1BB/T1BA/T1BC	GDS99212	Drive Shaft		40	26	57.4	51	945			
	2011.02-	MT	R	F	Hatchback Engine T1BB/T1BA/T1BC	GCI18129	Inner Joint		26	28	40	389	96.5			
1.8 TDCi (74 kW)	2007.03-	MT	L	F	Hatchback Engine FFBA	GDS99211	Drive Shaft		40	26	57.4	51	603			
	2007.03-	MT	L	F	Hatchback Engine FFBA	GCI18128	Inner Joint		26	28	40	68.5	111			
	2007.03-	MT	L	F	Saloon Engine FFBA	GDS99211	Drive Shaft		40	26	57.4	51	603			
	2007.03-	MT	L	F	Saloon Engine FFBA	GCI18128	Inner Joint		26	28	40	68.5	111			
	2007.03-	MT	L/R	F	Hatchback Engine FFBA	GC099271	Outer Joint		40	28	57.4	51	63	M		
	2007.03-	MT	L/R	F	Saloon Engine FFBA	GC099271	Outer Joint		40	28	57.4	51	63	M		
	2007.03-	MT	R	F	Hatchback Engine FFBA	GDS99212	Drive Shaft		40	26	57.4	51	945			
	2007.03-	MT	R	F	Hatchback Engine FFBA	GCI18129	Inner Joint		26	28	40	389	96.5			
	2007.03-	MT	R	F	Saloon Engine FFBA	GDS99212	Drive Shaft		40	26	57.4	51	945			
1.8 TDCi (92 kW)	2007.06-	MT	L	F	Hatchback Engine KHBA/QYBA	GDS99211	Drive Shaft		40	26	57.4	51	603			
	2007.06-	MT	L	F	Hatchback Engine KHBA/QYBA	GCI18128	Inner Joint		26	28	40	68.5	111			
	2007.06-	MT	L	F	Saloon Engine KHBA/QYBA	GDS99211	Drive Shaft		40	26	57.4	51	603			
	2007.06-	MT	L	F	Saloon Engine KHBA/QYBA	GCI18128	Inner Joint		26	28	40	68.5	111			
	2007.06-	MT	L/R	F	Hatchback Engine KHBA/QYBA	GC099271	Outer Joint		40	28	57.4	51	63	M		
	2007.06-	MT	L/R	F	Saloon Engine KHBA/QYBA	GC099271	Outer Joint		40	28	57.4	51	63	M		
	2007.06-	MT	R	F	Hatchback Engine KHBA/QYBA	GDS99212	Drive Shaft		40	26	57.4	51	945			
	2007.06-	MT	R	F	Hatchback Engine KHBA/QYBA	GCI18129	Inner Joint		26	28	40	389	96.5			
	2007.06-	MT	R	F	Saloon Engine KHBA/QYBA	GDS99212	Drive Shaft		40	26	57.4	51	945			
2.0 (107 kW)	2007.03-	MT	L	F	Hatchback Engine AOBA/AOBC/TBBA	GDS99211	Drive Shaft		40	26	57.4	51	603			
	2007.03-	MT	L	F	Hatchback Engine AOBA/AOBC/TBBA	GCI18128	Inner Joint		26	28	40	68.5	111			
	2007.03-	MT	L	F	Hatchback Engine AOBA/AOBC/TBBA	GC099271	Outer Joint		40	28	57.4	51	63	M		
	2007.03-	MT	L	F	Saloon Engine AOBA/AOBC/TBBA	GDS99211	Drive Shaft		40	26	57.4	51	603			
	2007.03-	MT	L	F	Saloon Engine AOBA/AOBC/TBBA	GCI18128	Inner Joint		26	28	40	68.5	111			
2.0 EcoBoost (176 kW)	2010.07-	AT	L	F	Hatchback Engine TPBA	GDS18340	Drive Shaft		40	28	57.4	52	592			
	2010.07-	AT	R	F	Hatchback Engine TPBA	GDS18341	Drive Shaft		40	28	57.4	52	952			
	2010.07-	AT			Hatchback Engine TPBA	GC059344	Outer Joint		40	26	57.4	52	63.5	M		
2.0 FlexFuel (107 kW)	2009.03-	MT	L	F	Hatchback Engine TBBA/TBBB	GDS99211	Drive Shaft		40	26	57.4	51	603			
	2009.03-	MT	L	F	Hatchback Engine TBBA/TBBB	GCI18128	Inner Joint		26	28	40	68.5	111			
	2009.03-	MT	L	F	Hatchback Engine TBBA/TBBB	GC099271	Outer Joint		40	28	57.4	51	63	M		
	2009.03-	MT	L	F	Saloon Engine TBBB/TBBA	GDS99211	Drive Shaft		40	26	57.4	51	603			
	2009.03-	MT	L	F	Saloon Engine TBBB/TBBA	GCI18128	Inner Joint		26	28	40	68.5	111			
2.0 LPG (107 kW)	2009.07-	MT	L	F	Hatchback Engine TBBA	GDS99211	Drive Shaft		40	26	57.4	51	603			
	2009.07-	MT	L	F	Hatchback Engine TBBA	GCI18128	Inner Joint		26	28	40	68.5	111			
	2009.07-	MT	L	F	Hatchback Engine TBBA	GC099271	Outer Joint		40	28	57.4	51	63	M		
	2009.07-	MT	L	F	Saloon Engine TBBA	GDS99211	Drive Shaft		40	26	57.4	51	603			
	2009.07-	MT	L	F	Saloon Engine TBBA	GCI18128	Inner Joint		26	28	40	68.5	111			
	2009.07-	MT	L	F	Saloon Engine TBBA	GC099271	Outer Joint		40	28	57.4	51	63	M		
2.0 SCTi (149 kW)	2010.03-	AT	L	F	Hatchback Engine TNBA	GDS18340	Drive Shaft		40	28	57.4	52	592			
	2010.03-	AT	R	F	Hatchback Engine TNBA	GDS18341	Drive Shaft		40	28	57.4	52	952			
	2010.03-	AT			Hatchback Engine TNBA	GC059344	Outer Joint		40	26	57.4	52	63.5	M		
2.0 TDCi (100 kW)	2007.03-	AT	L	F	Hatchback Engine AZBC/UKBA	GDS83288	Drive Shaft		40	31	57.4	51	582			
	2007.03-	AT	R	F	Hatchback Engine AZBC/UKBA	GDS83289	Drive Shaft		40	28	57.4	51	932			
	2007.03-	AT			Hatchback Engine AZBC/UKBA	GC059344	Outer Joint		40	26	57.4	52	63.5	M		
2.0 TDCi (103 kW)	2007.03-	AT	L	F	Hatchback Engine QXBB/UFBA/QXBA	GDS83288	Drive Shaft		40	31	57.4	51	582			
	2007.03-	AT	L	F	Saloon Engine QXBB/UFBA/QXBA	GDS83288	Drive Shaft		40	31	57.4	51	582			
	2007.03-	MT	L	F	Saloon Engine QXBB/UFBA/QXBA	GDS99211	Drive Shaft		40	26	57.4	51	603			
	2007.03-	MT	L	F	Saloon Engine QXBB/UFBA/QXBA	GCI18128	Inner Joint		26	28	40	68.5	111			
	2007.03-	MT	L/R	F	Saloon Engine QXBB/UFBA/QXBA	GC099271	Outer Joint		40	28	57.4	51	63	M		
	2007.03-	AT	R	F	Hatchback Engine QXBB/UFBA/QXBA	GDS83289	Drive Shaft		40	28	57.4	51	932			
	2007.03-	AT	R	F	Saloon Engine QXBB/UFBA/QXBA	GDS83289	Drive Shaft		40	28	57.4	51	932			
	2007.03-	MT	R	F	Saloon Engine QXBB/UFBA/QXBA	GDS99212	Drive Shaft		40	26	57.4	51	945			
	2007.03-	MT	R	F	Saloon Engine QXBB/UFBA/QXBA	GCI18129	Inner Joint		26	28	40	389	96.5			
	2007.03-	AT			Hatchback Engine QXBB/UFBA/QXBA	GC059344	Outer Joint		40	26	57.4	52	63.5	M		
2.0 TDCi (120 kW)	2010.03-	AT	L	F	Hatchback Engine TXBA	GDS83288	Drive Shaft		40	31	57.4	51	582			
	2010.03-	AT	L	F	Saloon Engine TXBA	GDS83288	Drive Shaft		40	31	57.4	51	582			



	 YEAR	TRANSM	L/R	F/R		G-AP Ref.	PRODUCT	ABS	Technical Specifications								
									A	B	C	H	L	P			
<b>FORD MONDEO IV</b>																	
2.0 TDCi (120 kW)	2010.03-	AT	R	F	Hatchback Engine TXBA	GDS83289	Drive Shaft		40	28	57.4	51	932				
	2010.03-	AT	R	F	Saloon Engine TXBA	GDS83289	Drive Shaft		40	28	57.4	51	932				
	2010.03-	AT			Hatchback Engine TXBA	GC059344	Outer Joint		40	26	57.4	52	63.5	M			
	2010.03-	AT			Saloon Engine TXBA	GC059344	Outer Joint		40	26	57.4	52	63.5	M			
2.0 TDCi (85 kW)	2007.11-	MT	L	F	Hatchback Engine KLBA/LPBA/TYBA	GDS99211	Drive Shaft		40	26	57.4	51	603				
	2007.11-	MT	L	F	Hatchback Engine KLBA/LPBA/TYBA	GCI18128	Inner Joint		26	28	40	68.5	111				
	2007.11-	MT	L	F	Saloon Engine KLBA/LPBA/TYBA	GDS99211	Drive Shaft		40	26	57.4	51	603				
	2007.11-	MT	L	F	Saloon Engine KLBA/LPBA/TYBA	GCI18128	Inner Joint		26	28	40	68.5	111				
	2007.11-	MT	L/R	F	Hatchback Engine KLBA/LPBA/TYBA	GC099271	Outer Joint		40	28	57.4	51	63	M			
	2007.11-	MT	L/R	F	Saloon Engine KLBA/LPBA/TYBA	GC099271	Outer Joint		40	28	57.4	51	63	M			
	2007.11-	MT	R	F	Hatchback Engine KLBA/LPBA/TYBA	GDS99212	Drive Shaft		40	26	57.4	51	945				
	2007.11-	MT	R	F	Hatchback Engine KLBA/LPBA/TYBA	GCI18129	Inner Joint		26	28	40	389	96.5				
	2007.11-	MT	R	F	Saloon Engine KLBA/LPBA/TYBA	GDS99212	Drive Shaft		40	26	57.4	51	945				
2.0 TDCi (96 kW)	2007.03-	AT	L	F	Hatchback Engine AZBA	GDS83288	Drive Shaft		40	31	57.4	51	582				
	2007.03-	AT	L	F	Saloon Engine AZBA	GDS83288	Drive Shaft		40	31	57.4	51	582				
	2007.03-	MT	L	F	Hatchback Engine AZBA	GDS99211	Drive Shaft		40	26	57.4	51	603				
	2007.03-	MT	L	F	Hatchback Engine AZBA	GCI18128	Inner Joint		26	28	40	68.5	111				
	2007.03-	MT	L	F	Saloon Engine AZBA	GDS99211	Drive Shaft		40	26	57.4	51	603				
	2007.03-	MT	L	F	Saloon Engine AZBA	GCI18128	Inner Joint		26	28	40	68.5	111				
	2007.03-	MT	L/R	F	Hatchback Engine AZBA	GC099271	Outer Joint		40	28	57.4	51	63	M			
	2007.03-	MT	L/R	F	Saloon Engine AZBA	GC099271	Outer Joint		40	28	57.4	51	63	M			
	2007.03-	AT	R	F	Hatchback Engine AZBA	GDS83289	Drive Shaft		40	28	57.4	51	932				
	2007.03-	AT	R	F	Saloon Engine AZBA	GDS83289	Drive Shaft		40	28	57.4	51	932				
	2007.03-	MT	R	F	Hatchback Engine AZBA	GDS99212	Drive Shaft		40	26	57.4	51	945				
	2007.03-	MT	R	F	Hatchback Engine AZBA	GCI18129	Inner Joint		26	28	40	389	96.5				
	2007.03-	MT	R	F	Saloon Engine AZBA	GDS99212	Drive Shaft		40	26	57.4	51	945				
	2007.03-	MT	R	F	Saloon Engine AZBA	GCI18129	Inner Joint		26	28	40	389	96.5				
	2007.03-	AT			Hatchback Engine AZBA	GC059344	Outer Joint		40	26	57.4	52	63.5	M			
	2.2 TDCi (129 kW)	2008.03-	MT	L	F	Hatchback Engine Q4BA	GDS18363	Drive Shaft		40	31	57.4	52	588.5			
2008.03-		MT	L	F	Saloon Engine Q4BA	GDS18363	Drive Shaft		40	31	57.4	52	588.5				
2008.03-		MT	R	F	Hatchback Engine Q4BA	GDS18350	Drive Shaft		40	28	57.4	52	963				
2008.03-		MT	R	F	Saloon Engine Q4BA	GDS18350	Drive Shaft		40	28	57.4	52	963				
2.2 TDCi (147 kW)	2010.07-	MT	L	F	Hatchback Engine KNBA	GDS18363	Drive Shaft		40	31	57.4	52	588.5				
	2010.07-	MT	R	F	Hatchback Engine KNBA	GDS18350	Drive Shaft		40	28	57.4	52	963				
2.3 (118 kW)	2007.07-	AT	R	F	Hatchback Engine SEBA	GDS61106	Drive Shaft		40	31	57.4	51	945				
	2007.07-	AT	R	F	Saloon Engine SEBA	GDS61106	Drive Shaft		40	31	57.4	51	945				
2.5 (162 kW)	2007.03-	MT	L	F	Hatchback Engine HUBA	GDS21070	Drive Shaft		40	26	57.4	52	556				
	2007.03-	MT	L	F	Saloon Engine HUBA	GDS21070	Drive Shaft		40	26	57.4	52	556				
	2007.03-				Hatchback Engine HUBA	GC059285	Outer Joint		40	27	57.4	52	63.5	M			
	2007.03-				Saloon Engine HUBA	GC059285	Outer Joint		40	27	57.4	52	63.5	M			
<b>MONDEO IV TURNIER</b>																	
1.6 TDCi (85 kW)	2011.02-	MT	L	F	Estate Engine T1BB	GDS99211	Drive Shaft		40	26	57.4	51	603				
	2011.02-	MT	L	F	Estate Engine T1BB	GCI18128	Inner Joint		26	28	40	68.5	111				
	2011.02-	MT	L/R	F	Estate Engine T1BB	GC099271	Outer Joint		40	28	57.4	51	63	M			
	2011.02-	MT	R	F	Estate Engine T1BB	GDS99212	Drive Shaft		40	26	57.4	51	945				
	2011.02-	MT	R	F	Estate Engine T1BB	GCI18129	Inner Joint		26	28	40	389	96.5				
1.8 TDCi (74 kW)	2007.03-	MT	L	F	Estate Engine FFBA	GDS99211	Drive Shaft		40	26	57.4	51	603				
	2007.03-	MT	L	F	Estate Engine FFBA	GCI18128	Inner Joint		26	28	40	68.5	111				
	2007.03-	MT	L/R	F	Estate Engine FFBA	GC099271	Outer Joint		40	28	57.4	51	63	M			
	2007.03-	MT	R	F	Estate Engine FFBA	GDS99212	Drive Shaft		40	26	57.4	51	945				
	2007.03-	MT	R	F	Estate Engine FFBA	GCI18129	Inner Joint		26	28	40	389	96.5				
1.8 TDCi (92 kW)	2007.06-	MT	L	F	Estate Engine KHBA/QYBA	GDS99211	Drive Shaft		40	26	57.4	51	603				
	2007.06-	MT	L	F	Estate Engine KHBA/QYBA	GCI18128	Inner Joint		26	28	40	68.5	111				
	2007.06-	MT	L	F	Estate Engine KHBA/QYBA	GC099271	Outer Joint		40	28	57.4	51	63	M			
2.0 (107 kW)	2007.03-	MT	L	F	Estate Engine AOB/AOBC/TBBA	GDS99211	Drive Shaft		40	26	57.4	51	603				
	2007.03-	MT	L	F	Estate Engine AOB/AOBC/TBBA	GCI18128	Inner Joint		26	28	40	68.5	111				
	2007.03-	MT	L	F	Estate Engine AOB/AOBC/TBBA	GC099271	Outer Joint		40	28	57.4	51	63	M			
2.0 EcoBoost (176 kW)	2010.07-	AT	L	F	Estate Engine TPBA	GDS18340	Drive Shaft		40	28	57.4	52	592				
	2010.07-	AT	R	F	Estate Engine TPBA	GDS18341	Drive Shaft		40	28	57.4	52	952				
	2010.07-	AT			Estate Engine TPBA	GC059344	Outer Joint		40	26	57.4	52	63.5	M			

		TRANSM	L/R	F/R		G-AP Ref.	PRODUCT	ABS	Technical Specifications								
									YEAR	A	B	C	H	L	P		
<b>FORD MONDEO IV TURNIER</b>																	
2.0 FlexFuel (107 kW)	2009.03-		MT	L	F	Estate Engine TBBA/TBBB	GDS99211	Drive Shaft	40	26	57.4	51	603				
	2009.03-		MT	L	F	Estate Engine TBBA/TBBB	GCI18128	Inner Joint	26	28	40	68.5	111				
	2009.03-		MT	L	F	Estate Engine TBBA/TBBB	GC099271	Outer Joint	40	28	57.4	51	63	M			
2.0 LPG (107 kW)	2009.07-		MT	L	F	Estate Engine TBBA	GDS99211	Drive Shaft	40	26	57.4	51	603				
	2009.07-		MT	L	F	Estate Engine TBBA	GCI18128	Inner Joint	26	28	40	68.5	111				
	2009.07-		MT	L	F	Estate Engine TBBA	GC099271	Outer Joint	40	28	57.4	51	63	M			
2.0 SCTi (149 kW)	2010.03-		AT	L	F	Estate Engine TNBA	GDS18340	Drive Shaft	40	28	57.4	52	592				
	2010.03-		AT	R	F	Estate Engine TNBA	GDS18341	Drive Shaft	40	28	57.4	52	952				
	2010.03-		AT			Estate Engine TNBA	GC059344	Outer Joint	40	26	57.4	52	63.5	M			
2.0 TDCi (100 kW)	2007.03-			L	F	Estate Engine AZBC/UKBA	GDS99211	Drive Shaft	40	26	57.4	51	603				
	2007.03-			L	F	Estate Engine AZBC/UKBA	GCI18128	Inner Joint	26	28	40	68.5	111				
	2007.03-			L	F	Estate Engine AZBC/UKBA	GC099271	Outer Joint	40	28	57.4	51	63	M			
	2007.03-		AT			Estate Engine AZBC/UKBA	GC059344	Outer Joint	40	26	57.4	52	63.5	M			
2.0 TDCi (103 kW)	2007.03-		MT	L	F	Estate Engine QXBB/QXBB/UFBA	GDS99211	Drive Shaft	40	26	57.4	51	603				
	2007.03-		MT	L	F	Estate Engine QXBB/QXBB/UFBA	GCI18128	Inner Joint	26	28	40	68.5	111				
	2007.03-		MT	L	F	Estate Engine QXBB/QXBB/UFBA	GC099271	Outer Joint	40	28	57.4	51	63	M			
	2007.03-		AT			Estate Engine QXBB/QXBB/UFBA	GC059344	Outer Joint	40	26	57.4	52	63.5	M			
2.0 TDCi (120 kW)	2010.03-		MT	L	F	Estate Engine TXBA	GDS99211	Drive Shaft	40	26	57.4	51	603				
	2010.03-		MT	L	F	Estate Engine TXBA	GCI18128	Inner Joint	26	28	40	68.5	111				
	2010.03-		MT	L/R	F	Estate Engine TXBA	GC099271	Outer Joint	40	28	57.4	51	63	M			
	2010.03-		MT	R	F	Estate Engine TXBA	GDS99212	Drive Shaft	40	26	57.4	51	945				
	2010.03-		MT	R	F	Estate Engine TXBA	GCI18129	Inner Joint	26	28	40	389	96.5				
	2010.03-		AT			Estate Engine TXBA	GC059344	Outer Joint	40	26	57.4	52	63.5	M			
2.0 TDCi (85 kW)	2007.11-		MT	L	F	Estate Engine KLBA/LPBA/TYBA	GDS99211	Drive Shaft	40	26	57.4	51	603				
	2007.11-		MT	L	F	Estate Engine KLBA/LPBA/TYBA	GCI18128	Inner Joint	26	28	40	68.5	111				
	2007.11-		MT	L	F	Estate Engine KLBA/LPBA/TYBA	GC099271	Outer Joint	40	28	57.4	51	63	M			
2.0 TDCi (96 kW)	2007.03-		MT	L	F	Estate Engine AZBA	GDS99211	Drive Shaft	40	26	57.4	51	603				
	2007.03-		MT	L	F	Estate Engine AZBA	GCI18128	Inner Joint	26	28	40	68.5	111				
	2007.03-		MT	L/R	F	Estate Engine AZBA	GC099271	Outer Joint	40	28	57.4	51	63	M			
	2007.03-		MT	R	F	Estate Engine AZBA	GDS99212	Drive Shaft	40	26	57.4	51	945				
	2007.03-		MT	R	F	Estate Engine AZBA	GCI18129	Inner Joint	26	28	40	389	96.5				
	2007.03-		AT			Estate Engine AZBA	GC059344	Outer Joint	40	26	57.4	52	63.5	M			
2.2 TDCi (129 kW)	2008.03-		MT	L	F	Estate Engine Q4BA	GDS18363	Drive Shaft	40	31	57.4	52	588.5				
	2008.03-		MT	R	F	Estate Engine Q4BA	GDS18350	Drive Shaft	40	28	57.4	52	963				
2.2 TDCi (147 kW)	2010.07-		MT	L	F	Estate Engine KNBA	GDS18363	Drive Shaft	40	31	57.4	52	588.5				
	2010.07-		MT	R	F	Estate Engine KNBA	GDS18350	Drive Shaft	40	28	57.4	52	963				
2.3 (118 kW)	2007.07-		AT	R	F	Estate Engine SEBA	GDS61106	Drive Shaft	40	31	57.4	51	945				
2.5 (162 kW)	2007.03-		MT	L	F	Estate Engine HUBA	GDS21070	Drive Shaft	40	26	57.4	52	556				
	2007.03-					Estate Engine HUBA	GC059285	Outer Joint	40	27	57.4	52	63.5	M			
<b>MONDEO IV, SW</b>																	
1.6 TDCi (85 kW)	2010.11-			L			GCI18128	Inner Joint	26	28	40	68.5	111				
	2010.11-			R			GCI18129	Inner Joint	26	28	40	389	96.5				
2.0 LPG 16V (107 kW)	2009.07-	2010.10		L			GCI18128	Inner Joint	26	28	40	68.5	111				
	2009.07-	2010.10		R			GCI18129	Inner Joint	26	28	40	389	96.5				
2.0 TDCi (103 kW)	2007.07-	2010.10	AT	L			GCI18128	Inner Joint	26	28	40	68.5	111				
	2007.07-	2010.10	AT	R			GCI18129	Inner Joint	26	28	40	389	96.5				
2.0 TDCi (85 kW)	2007.07-	2010.10	AT	L			GCI18128	Inner Joint	26	28	40	68.5	111				
	2007.07-	2010.10	AT	R			GCI18129	Inner Joint	26	28	40	389	96.5				
2.0 TDCi (96 kW)	2007.07-	2010.10	AT	L			GCI18128	Inner Joint	26	28	40	68.5	111				
	2007.07-	2010.10	AT	R			GCI18129	Inner Joint	26	28	40	389	96.5				
<b>ORION (AFD)</b>																	
1.3 (51 kW)	1983.07-	1986.03	MT		F	Saloon Engine JPA	GC018019	Outer Joint	23	22	55	91.5	54.5	O			
	1983.07-	1986.03	MT		F	Saloon Engine JPA	GCI99075	Inner Joint	23	22	40	61	93	O			
1.6 (58 kW)	1983.07-	1986.03	MT		F	Saloon Engine LP1/LPA	GC018019	Outer Joint	23	22	55	91.5	54.5	O			
1.6 D (40 kW)	1984.02-	1986.03	MT		F	Saloon Engine LTA	GC018019	Outer Joint	23	22	55	91.5	54.5	O			
1.6 i (77 kW)	1983.07-	1986.03	MT		F	Saloon Engine LP1/LPA	GC018019	Outer Joint	23	22	55	91.5	54.5	O			
<b>ORION II (AFF)</b>																	
1.3 (44 kW)	1985.12-	1990.07	MT		F	Saloon Engine JBB/JLA/JLB	GCI18002	Inner Joint	23	20	40	61.5	62.5				
	1985.12-	1990.07	MT		F	Saloon Engine JBB/JLA/JLB	GC018019	Outer Joint	23	22	55	91.5	54.5	O			
	1985.12-	1990.07			F	Saloon Engine JBB/JLA/JLB	GC018018	Outer Joint	23	20	50	91.5	52	O			
1.4 (52 kW)	1986.03-	1990.07	MT		F	Saloon Engine FUAA	GC018019	Outer Joint	23	22	55	91.5	54.5	O			
	1986.03-	1990.07	MT		F	Saloon Engine FUAA	GCI99075	Inner Joint	23	22	40	61	93	O			









		TRANSM	L/R	F/R		G-AP Ref.	PRODUCT	ABS	Technical Specifications							
									YEAR	A	B	C	H	L	P	
<b>FORD</b>																
<b>ORION II (AFF)</b>																
1.4 (54 kW)	1986.01-	1990.07	MT/AT		F	Saloon Engine FUC	GC018019	Outer Joint		23	22	55	91.5	54.5	O	
	1986.01-	1990.07	MT		F	Saloon Engine FUC	GCI199075	Inner Joint		23	22	40	61	93	O	
1.4 (55 kW)	1985.12-	1990.07	MT		F	Saloon Engine FUA	GC018019	Outer Joint		23	22	55	91.5	54.5	O	
	1985.12-	1990.07	MT		F	Saloon Engine FUA	GCI99075	Inner Joint		23	22	40	61	93	O	
1.4 CAT (54 kW)	1987.02-	1990.07	MT/AT		F	Saloon Engine F6B/F6D	GC018019	Outer Joint		23	22	55	91.5	54.5	O	
	1987.02-	1990.07	MT		F	Saloon Engine F6B/F6D	GCI99075	Inner Joint		23	22	40	61	93	O	
1.6 (66 kW)	1985.12-	1990.07	MT/AT		F	Saloon Engine LUC	GC018019	Outer Joint		23	22	55	91.5	54.5	O	
1.6 D (40 kW)	1985.12-	1989.01	MT		F	Saloon Engine LTC	GC018019	Outer Joint		23	22	55	91.5	54.5	O	
1.6 i (75 kW)	1989.08-	1990.07	MT		F	Saloon Engine LJB	GC018019	Outer Joint		23	22	55	91.5	54.5	O	
1.6 i (77 kW)	1986.03-	1990.07	MT		F	Saloon Engine LRB	GC018019	Outer Joint		23	22	55	91.5	54.5	O	
1.6 i CAT (66 kW)	1986.03-	1990.07	MT/AT		F	Saloon Engine L4B	GC018019	Outer Joint		23	22	55	91.5	54.5	O	
1.8 D (44 kW)	1989.01-	1990.07	MT		F	Saloon Engine RTA/RTB	GC018019	Outer Joint		23	22	55	91.5	54.5	O	
<b>ORION III (GAL)</b>																
1.3 (44 kW)	1990.07-	1993.12	MT		F	Saloon Engine J4B/J6A	GC018017	Outer Joint		23	20	48	80.5	49	O	
	1990.07-	1993.12	MT		F	Saloon Engine J4B/J6A	GC018015	Outer Joint		23	22	48	80	52.5	O	
1.4 (52 kW)	1990.07-	1993.12	MT		F	Saloon Engine F6F/F6G	GC018015	Outer Joint		23	22	48	80	52.5	O	
1.8 D (44 kW)	1990.11-	1993.12	MT	R	F	Saloon Engine RTE/RTF/RTH	GDS18039	Drive Shaft		25	23	56.5	88.5	903		
	1990.11-	1993.12	MT	L	F	Saloon Engine RTE/RTF/RTH	GDS18040	Drive Shaft		25	23	56.5	88.5	608		
1.8 i 16V (77 kW)	1992.02-	1993.12	MT		F	Saloon Engine RDA	GC018021	Outer Joint		25	25	56.5	89	56.5	O	
	1992.02-	1993.12	MT	L	F	Saloon Engine RDA	GDS18044	Drive Shaft		25	26	56.5	89	594		
1.8 i 16V (96 kW)	1992.01-	1993.12	MT		F	Saloon Engine RQB	GC018021	Outer Joint		25	25	56.5	89	56.5	O	
	1992.01-	1993.12	MT	L	F	Saloon Engine RQB	GDS18044	Drive Shaft		25	26	56.5	89	594		
1.8 TD (66 kW)	1992.03-	1993.12	MT		F	Saloon Engine RFD/RFK	GC018021	Outer Joint		25	25	56.5	89	56.5	O	
	1992.03-	1993.12	MT	L	F	Saloon Engine RFD/RFK	GDS18044	Drive Shaft		25	26	56.5	89	594		
<b>PAMPA</b>																
1.6	1981.01-	1989.07	MT				GC018020	Outer Joint		24	30	46	109	62.5	O	
	1989.08-	1997.12	MT				GC018103	Outer Joint		24	30	46	109	62	I	
1.8	1989.08-	1997.12	MT				GC018103	Outer Joint		24	30	46	109	62	I	
<b>PROBE</b>																
2.0	1993-	1996	AT				GC018078	Outer Joint	44T	28	32	56	91.5	65	I	
	1993-	1997	MT				GC034036	Outer Joint		28	32	56	90	59	I	
	1993-	1997	MT				GC034063	Outer Joint	44T	28	32	56	90	59	I	
	1993-	1996	AT				GC018045	Outer Joint		28	32	56	91.5	65	I	
2.5	1993-	1996	AT				GC018078	Outer Joint	44T	28	32	56	91.5	65	I	
	1993-	1997	MT				GC034036	Outer Joint		28	32	56	90	59	I	
	1993-	1997	MT				GC034063	Outer Joint	44T	28	32	56	90	59	I	
	1993-	1996	AT				GC018045	Outer Joint		28	32	56	91.5	65	I	
<b>PROBE ALL</b>																
2.5 V6	1994.03-	1997.09	MT		F		GC034071	Outer Joint	44T	28	26	56	89	65	M	
<b>PUMA</b>																
1.4 16V	1998.02-	2000.10	MT	R	F		GDS18032	Drive Shaft		25	23	56.5	88.5	900		
<b>PUMA (EC_)</b>																
1.6 16V (76 kW)	2000.08-	2002.06		L	F	Coupe Engine L1W	GDS99047	Drive Shaft		25	23	56.5	88.5	601.5		
	2000.08-	2002.06		R	F	Coupe Engine L1W	GDS18175	Drive Shaft		25	23	56.5	88.5	898		
	2000.08-	2002.06		R	F	Coupe Engine L1W	GCI18087	Inner Joint		23	22	40	371	78.5		
	2000.08-	2002.06		R	F	Coupe Engine L1W	GC018004	Outer Joint		25	22	56.5	88.5	53.5	O	
1.7 16V (92 kW)	1997.03-	2002.06		R	F	Coupe Engine MHA/MHB	GDS18175	Drive Shaft		25	23	56.5	88.5	898		
	1997.03-	2002.06	MT		F	Coupe Engine MHA/MHB	GC018006	Outer Joint		25	22	55.5	88.5	53	O	
	1997.03-	2002.06		L	F	Coupe Engine MHA/MHB	GDS99047	Drive Shaft		25	23	56.5	88.5	601.5		
	1997.03-	2002.06		R	F	Coupe Engine MHA/MHB	GCI18087	Inner Joint		23	22	40	371	78.5		
	1997.03-	2002.06		R	F	Coupe Engine MHA/MHB	GC018004	Outer Joint		25	22	56.5	88.5	53.5	O	
<b>RAIDER</b>																
-	1987.01-	1996.12		R			GDS34019	Drive Shaft		26	26	65	143.5	606		
<b>RANGER</b>																
-	1998-	1999				SUV/Truck/VAN 4WD	GC018037	Outer Joint		27	34	66.8	115	66	I	
	2000-	2005				Truck	GCI18037	Inner Joint		27	34	35.55	117.3	76		
	2000-	2005		L		Truck 4WD	GDS18093	Drive Shaft		27	27	59.7	112	597.4		
2.5 D 4WD	2002-	2006		L	F		GDS34132	Drive Shaft	44W	26	26	61	103.5	510		
	2002-	2006		R	F		GDS34133	Drive Shaft	44W	26	26	61	103.5	579		
2.5 TDCi 4x4 (105 kW)	2006.05-					Saloon Engine WLAA	GC018206	Outer Joint	44W	28	36	61	104.5	78.5	I	
3.0 TDCi 4x4 (115 kW)	2006.05-					Pickup Engine WEAT	GC018206	Outer Joint	44W	28	36	61	104.5	78.5	I	



		TRANSM	L/R	F/R		G-AP Ref.	PRODUCT	ABS	Technical Specifications									
									YEAR	A	B	C	H	L	P			
<b>FORD RANGER (TU_)</b>																		
2.5 D (57 kW)	1999.10-2002.04	MT	L	F	Pickup Engine WL	GDS39001	Drive Shaft		26	26	65	143.5	527					
	1999.10-2002.04	MT	L	F	Pickup Engine WL	GCI34011	Inner Joint		26	25	40	39	81					
	1999.10-2002.04	MT	L	F	Pickup Engine WL	GC034056	Outer Joint		26	25	65	143.5	60.5	M				
	1999.10-2002.04		L	F	Pickup Engine WL	GDS27063	Drive Shaft	44W	26	26	61	103.5	509					
	1999.10-2002.04		L	F	Pickup Engine WL	GCI34018	Inner Joint		26	25	40	39	68					
	1999.10-2002.04		L/R	F	Pickup Engine WL	GC034067	Outer Joint	44W	26	25	61	103.5	75.5	M				
	1999.10-2002.04	MT	R	F	Pickup Engine WL	GDS34012	Drive Shaft		26	26	65	143.5	606					
	1999.10-2002.04		R	F	Pickup Engine WL	GDS27062	Drive Shaft	44W	26	26	61	103.5	579.5					
2.5 D 4x4 (57 kW)	1999.10-2002.04	MT	L	F	Pickup Engine WL	GDS39001	Drive Shaft		26	26	65	143.5	527					
	1999.10-2002.04	MT	L	F	Pickup Engine WL	GCI34011	Inner Joint		26	25	40	39	81					
	1999.10-2002.04	MT	L	F	Pickup Engine WL	GC034056	Outer Joint		26	25	65	143.5	60.5	M				
	1999.10-2002.04		L	F	Pickup Engine WL	GDS27063	Drive Shaft	44W	26	26	61	103.5	509					
	1999.10-2002.04		L	F	Pickup Engine WL	GCI34018	Inner Joint		26	25	40	39	68					
	1999.10-2002.04		L/R	F	Pickup Engine WL	GC034067	Outer Joint	44W	26	25	61	103.5	75.5	M				
	1999.10-2002.04	MT	R	F	Pickup Engine WL	GDS34012	Drive Shaft		26	26	65	143.5	606					
	1999.10-2002.04		R	F	Pickup Engine WL	GDS27062	Drive Shaft	44W	26	26	61	103.5	579.5					
2.5 TD (62 kW)	2002.04-2006.06		L	F	Pickup Engine eWL-T	GDS27063	Drive Shaft	44W	26	26	61	103.5	509					
	2002.04-2006.06		L	F	Pickup Engine eWL-T	GCI34018	Inner Joint		26	25	40	39	68					
	2002.04-2006.06		L/R	F	Pickup Engine eWL-T	GC034067	Outer Joint	44W	26	25	61	103.5	75.5	M				
	2002.04-2006.06		R	F	Pickup Engine eWL-T	GDS27062	Drive Shaft	44W	26	26	61	103.5	579.5					
	2002.04-2006.06		R	F	Pickup Engine eWL-T	GCI34019	Inner Joint		26	25	35	82.5	95.5					
	2002.04-2006.06		R		Pickup Engine eWL-T	GC027017	Outer Joint		26	25	61	103.5	75.5	M				
2.5 TD 4x4 (62 kW)	2002.04-2006.06				Pickup Engine WL-T	GC027017	Outer Joint		26	25	61	103.5	75.5	M				
	2002.04-2006.06		L	F	Pickup Engine WL-T	GDS27063	Drive Shaft	44W	26	26	61	103.5	509					
	2002.04-2006.06		L	F	Pickup Engine WL-T	GCI34018	Inner Joint		26	25	40	39	68					
	2002.04-2006.06		L/R	F	Pickup Engine WL-T	GC034067	Outer Joint	44W	26	25	61	103.5	75.5	M				
	2002.04-2006.06		R	F	Pickup Engine WL-T	GDS27062	Drive Shaft	44W	26	26	61	103.5	579.5					
	2002.04-2006.06		R	F	Pickup Engine WL-T	GCI34019	Inner Joint		26	25	35	82.5	95.5					
2.5 TD 4x4 (80 kW)	1999.10-2006.06	MT	L	F	Pickup Engine WL-T	GDS39001	Drive Shaft		26	26	65	143.5	527					
	1999.10-2006.06	MT	L	F	Pickup Engine WL-T	GCI34011	Inner Joint		26	25	40	39	81					
	1999.10-2006.06	MT	L	F	Pickup Engine WL-T	GC034056	Outer Joint		26	25	65	143.5	60.5	M				
	1999.10-2006.06		L	F	Pickup Engine WL-T	GDS27063	Drive Shaft	44W	26	26	61	103.5	509					
	1999.10-2006.06		L	F	Pickup Engine WL-T	GCI34018	Inner Joint		26	25	40	39	68					
	1999.10-2006.06		L/R	F	Pickup Engine WL-T	GC034067	Outer Joint	44W	26	25	61	103.5	75.5	M				
	1999.10-2006.06	MT	R	F	Pickup Engine WL-T	GDS34012	Drive Shaft		26	26	65	143.5	606					
	1999.10-2006.06		R	F	Pickup Engine WL-T	GDS27062	Drive Shaft	44W	26	26	61	103.5	579.5					
	1999.10-2006.06		R	F	Pickup Engine WL-T	GCI34019	Inner Joint		26	25	35	82.5	95.5					
2.5 TDDi (86 kW)	2002.04-2005.09			R	Pickup	GC027017	Outer Joint		26	25	61	103.5	75.5	M				
2.5 TDDi 4x4 (86 kW)	2002.04-2005.09				Pickup	GC027017	Outer Joint		26	25	61	103.5	75.5	M				
<b>S-MAX</b>																		
1.6 TDCi (85 kW)	2011.02-	MT	L	F	MPV Engine T1WA/T1WB	GDS99211	Drive Shaft		40	26	57.4	51	603					
	2011.02-	MT	L	F	MPV Engine T1WA/T1WB	GCI18128	Inner Joint		26	28	40	68.5	111					
	2011.02-	MT	L/R	F	MPV Engine T1WA/T1WB	GC099271	Outer Joint		40	28	57.4	51	63	M				
	2011.02-	MT	R	F	MPV Engine T1WA/T1WB	GDS99212	Drive Shaft		40	26	57.4	51	945					
	2011.02-	MT	R	F	MPV Engine T1WA/T1WB	GCI18129	Inner Joint		26	28	40	389	96.5					
1.8 TDCi (92 kW)	2006.05-	MT	R	F	MPV Engine QYWA	GDS99212	Drive Shaft		40	26	57.4	51	945					
	2006.05-	MT	R	F	MPV Engine QYWA	GCI18129	Inner Joint		26	28	40	389	96.5					
	2006.05-	MT	R	F	MPV Engine QYWA	GC099271	Outer Joint		40	28	57.4	51	63	M				
	2006.05-	AT	L	F	MPV Engine QYWA	GDS83288	Drive Shaft		40	31	57.4	51	582					
	2006.05-	AT	R	F	MPV Engine QYWA	GDS83289	Drive Shaft		40	28	57.4	51	932					
2.0 (107 kW)	2006.05-	MT	L	F	MPV Engine AOWA/AOWB	GDS99211	Drive Shaft		40	26	57.4	51	603					
	2006.05-	MT	L	F	MPV Engine AOWA/AOWB	GCI18128	Inner Joint		26	28	40	68.5	111					
	2006.05-	MT	L	F	MPV Engine AOWA/AOWB	GC099271	Outer Joint		40	28	57.4	51	63	M				
2.0 EcoBoost (149 kW)	2010.03-	AT	L	F	MPV Engine TNWA	GDS18340	Drive Shaft		40	28	57.4	52	592					
	2010.03-	AT	R	F	MPV Engine TNWA	GDS18341	Drive Shaft		40	28	57.4	52	952					
	2010.03-	AT			MPV Engine TNWA	GC059344	Outer Joint		40	26	57.4	52	63.5	M				
2.0 EcoBoost (176 kW)	2010.07-	AT	L	F	MPV Engine TPWA	GDS18340	Drive Shaft		40	28	57.4	52	592					
	2010.07-	AT	R	F	MPV Engine TPWA	GDS18341	Drive Shaft		40	28	57.4	52	952					
	2010.07-	AT			MPV Engine TPWA	GC059344	Outer Joint		40	26	57.4	52	63.5	M				

		TRANSM	L/R	F/R		G-AP Ref.	PRODUCT	ABS	Technical Specifications									
									YEAR	A	B	C	H	L	P			
<b>FORD</b>																		
<b>S-MAX</b>																		
2.0 FlexFuel (107 kW)	2006.05-		MT	L	F	MPV Engine TBWA/TBWB	GDS99211	Drive Shaft		40	26	57.4	51	603				
	2006.05-		MT	L	F	MPV Engine TBWA/TBWB	GCI18128	Inner Joint		26	28	40	68.5	111				
	2006.05-		MT	L	F	MPV Engine TBWA/TBWB	GC099271	Outer Joint		40	28	57.4	51	63	M			
2.0 TDCi (100 kW)	2006.05-		AT	L	F	MPV Engine AZWC/UKWA	GDS83288	Drive Shaft		40	31	57.4	51	582				
	2006.05-		MT	L	F	MPV Engine AZWC/UKWA	GDS99211	Drive Shaft		40	26	57.4	51	603				
	2006.05-		MT	L	F	MPV Engine AZWC/UKWA	GCI18128	Inner Joint		26	28	40	68.5	111				
	2006.05-		MT	L/R	F	MPV Engine AZWC/UKWA	GC099271	Outer Joint		40	28	57.4	51	63	M			
	2006.05-		AT	R	F	MPV Engine AZWC/UKWA	GDS83289	Drive Shaft		40	28	57.4	51	932				
	2006.05-		MT	R	F	MPV Engine AZWC/UKWA	GDS99212	Drive Shaft		40	26	57.4	51	945				
	2006.05-		MT	R	F	MPV Engine AZWC/UKWA	GCI18129	Inner Joint		26	28	40	389	96.5				
	2006.05-		AT			MPV Engine AZWC/UKWA	GC059344	Outer Joint		40	26	57.4	52	63.5	M			
2.0 TDCi (103 kW)	2006.05-		AT	L	F	MPV Engine QXWA/QXWB/QXWC/UFWA	GDS83288	Drive Shaft		40	31	57.4	51	582				
	2006.05-		MT	L	F	MPV Engine QXWA/QXWB/QXWC/UFWA	GDS99211	Drive Shaft		40	26	57.4	51	603				
	2006.05-		MT	L	F	MPV Engine QXWA/QXWB/QXWC/UFWA	GCI18128	Inner Joint		26	28	40	68.5	111				
	2006.05-		MT	L/R	F	MPV Engine QXWA/QXWB/QXWC/UFWA	GC099271	Outer Joint		40	28	57.4	51	63	M			
	2006.05-		AT	R	F	MPV Engine QXWA/QXWB/QXWC/UFWA	GDS83289	Drive Shaft		40	28	57.4	51	932				
	2006.05-		MT	R	F	MPV Engine QXWA/QXWB/QXWC/UFWA	GDS99212	Drive Shaft		40	26	57.4	51	945				
	2006.05-		MT	R	F	MPV Engine QXWA/QXWB/QXWC/UFWA	GCI18129	Inner Joint		26	28	40	389	96.5				
	2006.05-		AT			MPV Engine QXWA/QXWB/QXWC/UFWA	GC059344	Outer Joint		40	26	57.4	52	63.5	M			
2.0 TDCi (120 kW)	2010.03-		AT	L	F	MPV Engine TXWA	GDS83288	Drive Shaft		40	31	57.4	51	582				
	2010.03-		MT	L	F	MPV Engine TXWA	GDS99211	Drive Shaft		40	26	57.4	51	603				
	2010.03-		MT	L	F	MPV Engine TXWA	GCI18128	Inner Joint		26	28	40	68.5	111				
	2010.03-		MT	L/R	F	MPV Engine TXWA	GC099271	Outer Joint		40	28	57.4	51	63	M			
	2010.03-		AT	R	F	MPV Engine TXWA	GDS83289	Drive Shaft		40	28	57.4	51	932				
	2010.03-		MT	R	F	MPV Engine TXWA	GDS99212	Drive Shaft		40	26	57.4	51	945				
	2010.03-		MT	R	F	MPV Engine TXWA	GCI18129	Inner Joint		26	28	40	389	96.5				
	2010.03-		AT			MPV Engine TXWA	GC059344	Outer Joint		40	26	57.4	52	63.5	M			
2.0 TDCi (85 kW)	2007.11-		AT	L	F	MPV Engine KLWA/TYWA	GDS83288	Drive Shaft		40	31	57.4	51	582				
	2007.11-		MT	L	F	MPV Engine KLWA/TYWA	GDS99211	Drive Shaft		40	26	57.4	51	603				
	2007.11-		MT	L	F	MPV Engine KLWA/TYWA	GCI18128	Inner Joint		26	28	40	68.5	111				
	2007.11-		MT	L/R	F	MPV Engine KLWA/TYWA	GC099271	Outer Joint		40	28	57.4	51	63	M			
	2007.11-		AT	R	F	MPV Engine KLWA/TYWA	GDS83289	Drive Shaft		40	28	57.4	51	932				
	2007.11-		MT	R	F	MPV Engine KLWA/TYWA	GDS99212	Drive Shaft		40	26	57.4	51	945				
	2007.11-		MT	R	F	MPV Engine KLWA/TYWA	GCI18129	Inner Joint		26	28	40	389	96.5				
	2007.11-		AT			MPV Engine KLWA/TYWA	GC059344	Outer Joint		40	26	57.4	52	63.5	M			
2.0 TDCi (96 kW)	2007.05-	2008.03	AT	L	F	MPV Engine AZWA	GDS83288	Drive Shaft		40	31	57.4	51	582				
	2007.05-	2008.03	MT	L	F	MPV Engine AZWA	GDS99211	Drive Shaft		40	26	57.4	51	603				
	2007.05-	2008.03	MT	L	F	MPV Engine AZWA	GCI18128	Inner Joint		26	28	40	68.5	111				
	2007.05-	2008.03	MT	L/R	F	MPV Engine AZWA	GC099271	Outer Joint		40	28	57.4	51	63	M			
	2007.05-	2008.03	AT	R	F	MPV Engine AZWA	GDS83289	Drive Shaft		40	28	57.4	51	932				
	2007.05-	2008.03	MT	R	F	MPV Engine AZWA	GDS99212	Drive Shaft		40	26	57.4	51	945				
	2007.05-	2008.03	MT	R	F	MPV Engine AZWA	GCI18129	Inner Joint		26	28	40	389	96.5				
	2007.05-	2008.03	AT			MPV Engine AZWA	GC059344	Outer Joint		40	26	57.4	52	63.5	M			
2.2 TDCi (129 kW)	2008.03-		MT	L	F	MPV Engine Q4WA	GDS18363	Drive Shaft		40	31	57.4	52	588.5				
	2008.03-		MT	R	F	MPV Engine Q4WA	GDS18350	Drive Shaft		40	28	57.4	52	963				
2.2 TDCi (147 kW)	2010.07-		MT	L	F	MPV Engine KNWA	GDS18363	Drive Shaft		40	31	57.4	52	588.5				
	2010.07-		MT	R	F	MPV Engine KNWA	GDS18350	Drive Shaft		40	28	57.4	52	963				
2.3 (118 kW)	2007.08-	2008.03	AT	R	F	MPV Engine SEWA	GDS61106	Drive Shaft		40	31	57.4	51	945				
2.5 ST (162 kW)	2006.05-		MT	L	F	MPV Engine HUWA	GDS21070	Drive Shaft		40	26	57.4	52	556				
	2006.05-					MPV Engine HUWA	GC059285	Outer Joint		40	27	57.4	52	63.5	M			
<b>S-MAX / GALAXY (CA1)</b>																		
-	2006-						GCI18128	Inner Joint		26	28	40	68.5	111				
<b>S-MAX I</b>																		
1.8 TDCi (92 kW)	2006.06-	2010.04		L			GCI18128	Inner Joint		26	28	40	68.5	111				
	2006.06-	2010.04		R			GCI18129	Inner Joint		26	28	40	389	96.5				
2.0 16V (107 kW)	2006.03-	2010.04		L			GCI18128	Inner Joint		26	28	40	68.5	111				
	2006.03-	2010.04		R			GCI18129	Inner Joint		26	28	40	389	96.5				
2.0 Flexifuel (107 kW)	2008.12-	2010.04		R			GCI18129	Inner Joint		26	28	40	389	96.5				
2.0 Flexifuel (107 kW)	2008.12-	2010.04		L			GCI18128	Inner Joint		26	28	40	68.5	111				
2.0 TDCi (103 kW)	2006.03-	2010.04		L			GCI18128	Inner Joint		26	28	40	68.5	111				
	2006.03-	2010.04		R			GCI18129	Inner Joint		26	28	40	389	96.5				









	 YEAR	TRANSM L/R F/R		G-AP Ref.	PRODUCT	ABS	Technical Specifications								
							A	B	C	H	L	P			
<b>FORD</b>															
<b>S-MAX I</b>															
2.0 TDCi (96 kW)	2006.03-2010.04		L		GCI18128	Inner Joint		26	28	40	68.5	111			
	2006.03-2010.04		R		GCI18129	Inner Joint		26	28	40	389	96.5			
<b>S-MAX II</b>															
1.6 TDCi (85 kW)	2011.02-2011.02-		L		GCI18128	Inner Joint		26	28	40	68.5	111			
			R		GCI18129	Inner Joint		26	28	40	389	96.5			
2.0 16V (107 kW)	2010.07-2010.07-		L		GCI18128	Inner Joint		26	28	40	68.5	111			
			R		GCI18129	Inner Joint		26	28	40	389	96.5			
2.0 TDCi (120 kW)	2010.03-2010.03-	MT	L		GCI18128	Inner Joint		26	28	40	68.5	111			
		MT	R		GCI18129	Inner Joint		26	28	40	389	96.5			
2.0 TDCi (85 kW)	2010.03-2010.03-	MT	L		GCI18128	Inner Joint		26	28	40	68.5	111			
		MT	R		GCI18129	Inner Joint		26	28	40	389	96.5			
<b>SCALA</b>															
1.6	1981.01-1989.07	MT			GC018020	Outer Joint		24	30	46	109	62.5	O		
	1982.10-1988.05	AT			GC018020	Outer Joint		24	30	46	109	62.5	O		
1.8	1989.08-1991.04	MT			GC018103	Outer Joint		24	30	46	109	62	I		
<b>SCORPIO II (GFR, GGR)</b>															
2.0 i (85 kW)	1994.10-1998.08	MT/AT	R	R	Saloon Engine NSD	Drive Shaft					32	519			
	1994.10-1998.08	MT/AT	R	R	Estate Engine NSD	Drive Shaft					32	519			
	1994.10-1998.08	MT/AT		R	Saloon Engine NSD	Inner Joint			25		32				
	1994.10-1998.08	MT/AT		R	Estate Engine NSD	Inner Joint			25		32				
	1994.10-1998.08	MT/AT	L	R	Saloon Engine NSD	Drive Shaft					32	478			
	1994.10-1998.08	MT/AT	L	R	Estate Engine NSD	Drive Shaft					32	478			
<b>SIERRA (BNG)</b>															
2.8 4x4 (110 kW)	1987.01-1988.08			F	Estate Engine PRG	Outer Joint	94T	23	22	55	91	64	O		
2.9 4x4 (107 kW)	1988.08-1993.02			F	Estate Engine B4B/B4C	Outer Joint	94T	23	22	55	91	64	O		
2.9 4x4 (110 kW)	1988.08-1993.02			F	Estate Engine B4B/B4C	Outer Joint	94T	23	22	55	91	64	O		
<b>SIERRA (GBC, GBG)</b>															
2.0 16V Cosworth 4x4 (162 kW)	1990.01-1993.02			F	Hatchback Engine N5D	Outer Joint	94T	23	22	55	91	64	O		
2.0 16V Cosworth 4x4 CAT (162 kW)	1990.01-1993.02			F	Hatchback Engine N5C	Outer Joint	94T	23	22	55	91	64	O		
2.0 RS Cosworth (150 kW)	1987.11-1990.01			R	Hatchback Engine N5B	Inner Joint			25		32				
2.8 i XR 4x4 (110 kW)	1987.01-1988.08			F	Hatchback Engine PRG	Outer Joint	94T	23	22	55	91	64	O		
2.9 i XR 4x4 (107 kW)	1988.08-1993.02			F	Hatchback Engine B4B/B4C	Outer Joint	94T	23	22	55	91	64	O		
2.9 i XR 4x4 (110 kW)	1988.08-1993.02			F	Hatchback Engine B4A	Outer Joint	94T	23	22	55	91	64	O		
<b>SIERRA (GBG, GB4)</b>															
2.9 4x4 (107 kW)	1988.08-1993.02			F	Saloon Engine B4B/B4C	Outer Joint	94T	23	22	55	91	64	O		
2.9 4x4 (110 kW)	1988.08-1993.02			F	Saloon Engine B4B/B4C	Outer Joint	94T	23	22	55	91	64	O		
<b>STREET KA</b>															
1.6 (70 kW)	2003.03-2005.07	MT	R	F	Convertible Engine CDRA/CDRB	Drive Shaft		25	23	56.5	88.5	866			
	2003.03-2005.07				Convertible Engine CDRA/CDRB	Outer Joint		25	23	53.3	87	56	M		
<b>TAURUS</b>															
-	1986-1993				W/O SHO PKG 6 Cyl	Outer Joint		26	30	56	106	61	I		
	1994-1999				W/O SHO PKG	Outer Joint		26	30	56	106	61	I		
3.0 SHO	1986-1989				6 Cyl	Outer Joint		26	32	55.9	105.5	64.5	I		
	1986-1989					Outer Joint	50T	26	32	55.9	105.5	64.5	I		
	1990-1995	MT			6 Cyl	Outer Joint		26	32	55.9	105.5	64.5	I		
	1990-1995	MT				Outer Joint	50T	26	32	55.9	105.5	64.5	I		
3.8	1986-1995				6 Cyl	Outer Joint		26	32	55.9	105.5	64.5	I		
	1986-1995				6 Cyl	Outer Joint	50T	26	32	55.9	105.5	64.5	I		
<b>TELSTAR</b>															
1.8 (GE8P)	1991.09-	MT/AT			Engine K8	Inner Joint		28	23	35	66	105			
2.0						Inner Joint		28	23	35	66.5	104			
2.0 (GEEP)	1991.09-	MT/AT			Engine KF	Inner Joint		28	23	35	66	105			
<b>TELSTAR (GD / GE)</b>															
1.8 (GE8P)	1991.09-	MT/AT			USA Engine K8	Inner Joint		28	23	35	66	105			
2.0 (GEEP)	1991.08-	MT/AT			USA Engine KF	Inner Joint		28	23	35	66	105			
<b>TEMPO</b>															
-	1984-1991	MT	L			Drive Shaft		26	23	51	88.5	560			
	1984-1991	AT	L			Drive Shaft		26	23	51	88.5	562			
	1986-1991		R			Drive Shaft		26	23	51	88.5	892			
2.3	1992-1994					Outer Joint		26	28	51	107.5	58	I		
All Models	1984.01-1991.12	AT				Outer Joint		26	23	51	88.5	60	I		
	1984.01-1984.12	MT				Outer Joint		26	23	51	88.5	60	I		



	 YEAR	TRANSM	L/R	F/R		G-AP Ref.	PRODUCT	ABS	Technical Specifications								
									A	B	C	H	L	P			
<b>FORD</b>																	
<b>TEMPO</b>																	
All Models	1985.01-	1986.12				GCO18042	Outer Joint		26	23	51	88.5	60	I			
	1985.01-	1991.12	MT			GCO18042	Outer Joint		26	23	51	88.5	60	I			
<b>THUNDERBIRD</b>																	
-						GCI18010	Inner Joint		24	21	35	64	95				
				R		GDS18058	Drive Shaft		24	24	52	86.5	900				
	1989-	1997				GCO99146	Outer Joint		28	32	55.9	95.5	64	I			
<b>TOPAZ</b>																	
-	1987-	1991	AT			GCI18054	Inner Joint		23	24	42	90	108				
	1988-	1991	MT			GCI18021	Inner Joint		23	24	42	67	113				
	1992-	1994	AT			GCO18063	Outer Joint		26	32	51	105	64.5	I			
All Models	1984.01-	1985.12				GCO18060	Outer Joint		26	23	51	88	62	I			
<b>TOURNEO CONNECT</b>																	
1.8 Di (55 kW)	2002.06-			F	MPV Engine BHPA/P7PA/P7PB/R2PA	GCO18207	Outer Joint		25	24	53.5	94.5	62	M			
1.8 Turbo Di (66 kW)	2002.06-			F	MPV Engine HCPA/HCPB/P9PA/P9PB/P9PC/P9PD/R3PA/RWPE/RWPF	GCO18067	Outer Joint		25	26	53.3	94.5	64.5	M			
<b>TOURNEO CUSTOM</b>																	
2.2 TDCi (74 kW)	2012.12-		MT	L	F Estate	GDS18413	Drive Shaft		31	41	57.7	121	753				
	2012.12-		MT	R	F Estate	GDS18335	Drive Shaft		31	41	57.7	121	1092				
2.2 TDCi (92 kW)	2012.12-		MT	L	F Estate	GDS18413	Drive Shaft		31	41	57.7	121	753				
	2012.12-		MT	R	F Estate	GDS18335	Drive Shaft		31	41	57.7	121	1092				
<b>TRANSIT</b>																	
-	1986.01-	2000.03	AT		Propshaft	GCI99050	Inner Joint			24		32					
2.2 TDCi (103 kW)	2007.10-		5MT	L	F Bus Engine PGFA/PGFB/UHFA/UHFB/UHFC	GDS99179	Drive Shaft	48T	28	36	59	128	796				
	2007.10-		5MT	L	F Platform/Chassis Engine PGFA/PGFB	GDS99179	Drive Shaft	48T	28	36	59	128	796				
	2007.10-		6MT	L	F Bus Engine PGFA/PGFB/UHFA/UHFB/UHFC	GDS18293	Drive Shaft	48T	28	41	65	124	754				
	2007.10-		6MT	L	F Platform/Chassis Engine PGFA/PGFB	GDS18293	Drive Shaft	48T	28	41	65	124	754				
	2007.10-		6MT	R	F Box Engine PGFA/PGFB/UHFA/UHFB/UHFC	GDS18292	Drive Shaft	48T	28	41	65	124	1093				
	2007.10-		6MT	R	F Bus Engine PGFA/PGFB/UHFA/UHFB/UHFC	GDS18292	Drive Shaft	48T	28	41	65	124	1093				
	2007.10-		6MT	R	F Platform/Chassis Engine PGFA/PGFB	GDS18292	Drive Shaft	48T	28	41	65	124	1093				
2.2 TDCi (63 kW)	2006.04-			F	Box Engine P8FA/P8FB	GCO99270	Outer Joint	48T	28	28	59	128	61.5	M			
	2006.04-			F	Bus Engine P8FA/P8FB	GCO99270	Outer Joint	48T	28	28	59	128	61.5	M			
	2006.04-			F	Platform/Chassis Engine P8FA/P8FB	GCO99270	Outer Joint	48T	28	28	59	128	61.5	M			
	2006.04-	2011.10	6MT			GCO18237	Outer Joint	48T	28	31	65	124	78	M			
	2006.04-		5MT	L	F Box Engine P8FA/P8FB	GDS99179	Drive Shaft	48T	28	36	59	128	796				
	2006.04-		5MT	L	F Bus Engine P8FA/P8FB	GDS99179	Drive Shaft	48T	28	36	59	128	796				
	2006.04-		5MT	L	F Platform/Chassis Engine P8FA/P8FB	GDS99179	Drive Shaft	48T	28	36	59	128	796				
	2006.04-		MT/6MT	L	F Box Engine P8FA/P8FB	GDS18293	Drive Shaft	48T	28	41	65	124	754				
	2006.04-		MT/6MT	R	F Box Engine P8FA/P8FB	GDS18292	Drive Shaft	48T	28	41	65	124	1093				
	2006.04-				Bus Engine P8FA/P8FB	GCO99284	Outer Joint	48T	28	29	60	126.5	72	M			
	2006.04-				Platform/Chassis Engine P8FA/P8FB	GCO99284	Outer Joint	48T	28	29	60	126.5	72	M			
2.2 TDCi (81 kW)	2006.04-			F	Box Engine QVFA	GCO99270	Outer Joint	48T	28	28	59	128	61.5	M			
	2006.04-			F	Bus Engine QVFA	GCO99270	Outer Joint	48T	28	28	59	128	61.5	M			
	2006.04-			F	Platform/Chassis Engine QVFA	GCO99270	Outer Joint	48T	28	28	59	128	61.5	M			
	2006.04-	2011.10	6MT			GCO18237	Outer Joint	48T	28	31	65	124	78	M			
	2006.04-		5MT	L	F Box Engine QVFA	GDS99179	Drive Shaft	48T	28	36	59	128	796				
	2006.04-		5MT	L	F Bus Engine QVFA	GDS99179	Drive Shaft	48T	28	36	59	128	796				
	2006.04-		5MT	L	F Platform/Chassis Engine QVFA	GDS99179	Drive Shaft	48T	28	36	59	128	796				
	2006.04-				Box Engine QVFA	GCO99284	Outer Joint	48T	28	29	60	126.5	72	M			
	2006.04-				Bus Engine QVFA	GCO99284	Outer Joint	48T	28	29	60	126.5	72	M			
	2006.04-				Platform/Chassis Engine QVFA	GCO99284	Outer Joint	48T	28	29	60	126.5	72	M			
2.2 TDCi (85 kW)	2008.10-		5MT	L	F Box Engine SRFA/SRFB/SRFC/SRFD/SRFE	GDS99179	Drive Shaft	48T	28	36	59	128	796				
	2008.10-		5MT	L	F Platform/Chassis Engine SRFA/SRFB/SRFC/SRFD/SRFE	GDS99179	Drive Shaft	48T	28	36	59	128	796				
	2008.10-		6MT	L	F Platform/Chassis Engine SRFA/SRFB/SRFC/SRFD/SRFE	GDS18293	Drive Shaft	48T	28	41	65	124	754				
	2008.10-		6MT	R	F Box Engine SRFA/SRFB/SRFC/SRFD/SRFE	GDS18292	Drive Shaft	48T	28	41	65	124	1093				
	2008.10-		6MT	R	F Bus Engine SRFA/SRFB/SRFC/SRFE/SRFD	GDS18292	Drive Shaft	48T	28	41	65	124	1093				
	2008.10-		6MT	R	F Platform/Chassis Engine SRFA/SRFB/SRFC/SRFD/SRFE	GDS18292	Drive Shaft	48T	28	41	65	124	1093				
	2008.10-		5MT		Box Engine SRFA/SRFB/SRFC/SRFD/SRFE	GCO99284	Outer Joint	48T	28	29	60	126.5	72	M			
	2008.10-		5MT		Bus Engine SRFA/SRFB/SRFC/SRFE/SRFD	GCO99284	Outer Joint	48T	28	29	60	126.5	72	M			
	2008.10-		MT		Platform/Chassis Engine SRFA/SRFB/SRFC/SRFD/SRFE	GCO99284	Outer Joint	48T	28	29	60	126.5	72	M			
2.2 TDCi (96 kW)	2006.04-			F	Box Engine QWFA	GCO99270	Outer Joint	48T	28	28	59	128	61.5	M			
	2006.04-			F	Bus Engine QWFA	GCO99270	Outer Joint	48T	28	28	59	128	61.5	M			
	2006.04-			F	Platform/Chassis Engine QWFA	GCO99270	Outer Joint	48T	28	28	59	128	61.5	M			
	2006.04-	2011.10	6MT			GCO18237	Outer Joint	48T	28	31	65	124	78	M			

	 YEAR	TRANSM	L/R	F/R		G-AP Ref.	PRODUCT	ABS	Technical Specifications							
									A	B	C	H	L	P		
<b>FORD TRANSIT</b>																
2.2 TDCi (96 kW)	2006.04-		5MT	L	F	Box Engine QWFA	GDS99179	Drive Shaft	48T	28	36	59	128	796		
	2006.04-		5MT	L	F	Bus Engine QWFA	GDS99179	Drive Shaft	48T	28	36	59	128	796		
	2006.04-		5MT	L	F	Platform/Chassis Engine QWFA	GDS99179	Drive Shaft	48T	28	36	59	128	796		
	2006.04-					Box Engine QWFA	GC099284	Outer Joint	48T	28	29	60	126.5	72	M	
	2006.04-					Bus Engine QWFA	GC099284	Outer Joint	48T	28	29	60	126.5	72	M	
	2006.04-					Platform/Chassis Engine QWFA	GC099284	Outer Joint	48T	28	29	60	126.5	72	M	
2.4 TDCi (103 kW)	2006.04-		6MT	L	F	Bus Engine H9FD	GDS18293	Drive Shaft	48T	28	41	65	124	754		
	2006.04-		6MT	L	F	Platform/Chassis Engine H9FD	GDS18293	Drive Shaft	48T	28	41	65	124	754		
	2006.04-		6MT	R	F	Box Engine H9FD	GDS18292	Drive Shaft	48T	28	41	65	124	1093		
	2006.04-		6MT	R	F	Bus Engine H9FD	GDS18292	Drive Shaft	48T	28	41	65	124	1093		
	2006.04-		6MT	R	F	Platform/Chassis Engine H9FD	GDS18292	Drive Shaft	48T	28	41	65	124	1093		
2.4 TDCi (74 kW)	2006.04-		MT	L	F	Box Engine PHFA/PHFC	GDS18209	Drive Shaft	48T	28	36	57	120.5	794.5		
	2006.04-		MT	L	F	Box Engine PHFA/PHFC	GCI18173	Inner Joint		36	28	40	77	111.5		
	2006.04-		MT	L	F	Platform/Chassis Engine PHFA/PHFC	GDS18209	Drive Shaft	48T	28	36	57	120.5	794.5		
	2006.04-		MT	L	F	Platform/Chassis Engine PHFA/PHFC	GCI18173	Inner Joint		36	28	40	77	111.5		
	2006.04-		MT	L/R	F	Box Engine PHFA/PHFC	GC018061	Outer Joint		28	26	57	120.5	64	M	
	2006.04-		MT	L/R	F	Platform/Chassis Engine PHFA/PHFC	GC018061	Outer Joint		28	26	57	120.5	64	M	
	2006.04-		MT	R	F	Box Engine PHFA/PHFC	GDS18213	Drive Shaft	48T	28	36	57	120.5	1056		
	2006.04-		MT	R	F	Box Engine PHFA/PHFC	GCI18120	Inner Joint		36	28	40	330	120		
	2006.04-		MT	R	F	Platform/Chassis Engine PHFA/PHFC	GDS18213	Drive Shaft	48T	28	36	57	120.5	1056		
	2006.04-		MT	R	F	Platform/Chassis Engine PHFA/PHFC	GCI18120	Inner Joint		36	28	40	330	120		
2.4 TDCi (85 kW)	2006.04-		6MT	L	F	Box Engine JXFA/JXFC	GDS18293	Drive Shaft	48T	28	41	65	124	754		
	2006.04-		6MT	L	F	Platform/Chassis Engine JXFA/JXFC	GDS18293	Drive Shaft	48T	28	41	65	124	754		
	2006.04-		6MT	R	F	Box Engine JXFA/JXFC	GDS18292	Drive Shaft	48T	28	41	65	124	1093		
	2006.04-		6MT	R	F	Bus Engine JXFA/JXFC	GDS18292	Drive Shaft	48T	28	41	65	124	1093		
	2006.04-		6MT	R	F	Platform/Chassis Engine JXFA/JXFC	GDS18292	Drive Shaft	48T	28	41	65	124	1093		
	2006.04-		6MT	R	F	Platform/Chassis Engine JXFA/JXFC	GDS18292	Drive Shaft	48T	28	41	65	124	1093		
2.4 TDCi 4x4 (103 kW)	2006.11-			L	F	Box Engine H9FB	GDS18209	Drive Shaft	48T	28	36	57	120.5	794.5		
	2006.11-			L	F	Box Engine H9FB	GCI18173	Inner Joint		36	28	40	77	111.5		
	2006.11-			L	F	Bus Engine H9FB	GDS18209	Drive Shaft	48T	28	36	57	120.5	794.5		
	2006.11-			L	F	Bus Engine H9FB	GCI18173	Inner Joint		36	28	40	77	111.5		
	2006.11-			L/R	F	Box Engine H9FB	GC018061	Outer Joint		28	26	57	120.5	64	M	
	2006.11-			L/R	F	Bus Engine H9FB	GC018061	Outer Joint		28	26	57	120.5	64	M	
	2006.11-			R	F	Box Engine H9FB	GDS18213	Drive Shaft	48T	28	36	57	120.5	1056		
	2006.11-			R	F	Box Engine H9FB	GCI18120	Inner Joint		36	28	40	330	120		
	2006.11-			R	F	Bus Engine H9FB	GDS18213	Drive Shaft	48T	28	36	57	120.5	1056		
	2006.11-			R	F	Bus Engine H9FB	GCI18120	Inner Joint		36	28	40	330	120		
3.2 TDCi (147 kW)	2007.09-		MT	L	F	Box Engine SAFA/SAFB	GDS18293	Drive Shaft	48T	28	41	65	124	754		
	2007.09-		6MT	R	F	Box Engine SAFA/SAFB	GDS18292	Drive Shaft	48T	28	41	65	124	1093		
	2008.02-		6MT	L	F	Bus Engine SAFA/SAFB	GDS18293	Drive Shaft	48T	28	41	65	124	754		
	2008.02-		6MT	R	F	Bus Engine SAFA/SAFB	GDS18292	Drive Shaft	48T	28	41	65	124	1093		
<b>TRANSIT (FD __, FB __, FS __, FZ __, FC __)</b>																
2.0 Di (55 kW)	2000.08-	2006.05			F	Bus Engine D3FA	GC018005	Outer Joint	48T	28	26	57	120.5	64	M	
	2000.08-	2006.05			F	Bus Engine D3FA	GC018061	Outer Joint		28	26	57	120.5	64	M	
	2000.08-	2006.05	MT	L	F	Bus Engine D3FA	GDS18035	Drive Shaft		28	26	57	120.5	797		
	2000.08-	2006.05	MT	L	F	Bus Engine D3FA	GDS18036	Drive Shaft	48T	28	26	57	120.5	797		
	2000.08-	2006.05		L	F	Bus Engine D3FA	GDS18209	Drive Shaft	48T	28	36	57	120.5	794.5		
	2000.08-	2006.05		L	F	Bus Engine D3FA	GCI18173	Inner Joint		36	28	40	77	111.5		
	2000.08-	2006.05		L/R	F	Bus Engine D3FA	GC018061	Outer Joint		28	26	57	120.5	64	M	
	2000.08-	2006.05	MT	R	F	Bus Engine D3FA	GDS18142	Drive Shaft		28	26	57	120.5	1056		
	2000.08-	2006.05	MT	R	F	Bus Engine D3FA	GDS18242	Drive Shaft	48T	28	26	57	120.5	1056		
	2000.08-	2006.05		R	F	Bus Engine D3FA	GCI18120	Inner Joint		36	28	40	330	120		
2.0 Di (63 kW)	2000.08-	2006.05			F	Bus Engine F3FA	GC018005	Outer Joint	48T	28	26	57	120.5	64	M	
	2000.08-	2006.05			F	Bus Engine F3FA	GC018061	Outer Joint		28	26	57	120.5	64	M	
	2000.08-	2006.05	MT	L	F	Bus Engine F3FA	GDS18035	Drive Shaft		28	26	57	120.5	797		
	2000.08-	2006.05	MT	L	F	Bus Engine F3FA	GDS18036	Drive Shaft	48T	28	26	57	120.5	797		
	2000.08-	2006.05		L	F	Bus Engine F3FA	GDS18209	Drive Shaft	48T	28	36	57	120.5	794.5		
	2000.08-	2006.05		L	F	Bus Engine F3FA	GCI18173	Inner Joint		36	28	40	77	111.5		







		TRANSM	L/R	F/R		G-AP Ref.	PRODUCT	ABS	Technical Specifications								
									YEAR	A	B	C	H	L	P		
<b>FORD</b>																	
<b>TRANSIT (FD_ , FB_ , FS_ , FZ_ , FC_ )</b>																	
2.0 Di (63 kW)	2000.08-2006.05		L/R	F	Bus Engine F3FA	GC018061	Outer Joint		28	26	57	120.5	64	M			
	2000.08-2006.05	MT	R	F	Bus Engine F3FA	GDS18142	Drive Shaft		28	26	57	120.5	1056				
	2000.08-2006.05	MT	R	F	Bus Engine F3FA	GDS18242	Drive Shaft	48T	28	26	57	120.5	1056				
	2000.08-2006.05		R	F	Bus Engine F3FA	GCI18120	Inner Joint		36	28	40	330	120				
	2000.08-2006.05				Bus Engine F3FA	GC099284	Outer Joint	48T	28	29	60	126.5	72	M			
2.0 Di (74 kW)	2000.08-2006.05			F	Bus Engine ABFA	GC018005	Outer Joint	48T	28	26	57	120.5	64	M			
	2000.08-2006.05			F	Bus Engine ABFA	GC018061	Outer Joint		28	26	57	120.5	64	M			
	2000.08-2006.05	MT	L	F	Bus Engine ABFA	GDS18035	Drive Shaft		28	26	57	120.5	797				
	2000.08-2006.05	MT	L	F	Bus Engine ABFA	GDS18036	Drive Shaft	48T	28	26	57	120.5	797				
	2000.08-2006.05		L	F	Bus Engine ABFA	GDS18209	Drive Shaft	48T	28	36	57	120.5	794.5				
	2000.08-2006.05		L	F	Bus Engine ABFA	GCI18173	Inner Joint		36	28	40	77	111.5				
	2000.08-2006.05		L/R	F	Bus Engine ABFA	GC018061	Outer Joint		28	26	57	120.5	64	M			
	2000.08-2006.05	MT	R	F	Bus Engine ABFA	GDS18142	Drive Shaft		28	26	57	120.5	1056				
	2000.08-2006.05	MT	R	F	Bus Engine ABFA	GDS18242	Drive Shaft	48T	28	26	57	120.5	1056				
	2000.08-2006.05		R	F	Bus Engine ABFA	GCI18120	Inner Joint		36	28	40	330	120				
	2000.08-2006.05				Bus Engine ABFA	GC099284	Outer Joint	48T	28	29	60	126.5	72	M			
2.0 TDCi (92 kW)	2002.08-2006.05			F	Bus Engine FIFA	GC018005	Outer Joint	48T	28	26	57	120.5	64	M			
	2002.08-2006.05	MT	L	F	Bus Engine FIFA	GDS18035	Drive Shaft		28	26	57	120.5	797				
	2002.08-2006.05	MT	L	F	Bus Engine FIFA	GDS18036	Drive Shaft	48T	28	26	57	120.5	797				
	2002.08-2006.05		L	F	Bus Engine FIFA	GDS18209	Drive Shaft	48T	28	36	57	120.5	794.5				
	2002.08-2006.05		L	F	Bus Engine FIFA	GCI18173	Inner Joint		36	28	40	77	111.5				
	2002.08-2006.05		L/R	F	Bus Engine FIFA	GC018061	Outer Joint		28	26	57	120.5	64	M			
	2002.08-2006.05	MT	R	F	Bus Engine FIFA	GDS18142	Drive Shaft		28	26	57	120.5	1056				
	2002.08-2006.05	MT	R	F	Bus Engine FIFA	GDS18242	Drive Shaft	48T	28	26	57	120.5	1056				
	2002.08-2006.05		R	F	Bus Engine FIFA	GCI18120	Inner Joint		36	28	40	330	120				
	2002.08-2006.05				Bus Engine FIFA	GC099284	Outer Joint	48T	28	29	60	126.5	72	M			
2.3 16V (107 kW)	2000.08-2006.05			R	Bus Engine E5FA/E5FC	GC018005	Outer Joint	48T	28	26	57	120.5	64	M			
2.4 Di (55 kW)	2000.01-2006.05	MT	L	F	Bus Engine F4FA	GDS18035	Drive Shaft		28	26	57	120.5	797				
	2000.01-2006.05	MT	L	F	Bus Engine F4FA	GDS18036	Drive Shaft	48T	28	26	57	120.5	797				
	2000.01-2006.05	MT	R	F	Bus Engine F4FA	GDS18142	Drive Shaft		28	26	57	120.5	1056				
	2000.01-2006.05	MT	R	F	Bus Engine F4FA	GDS18242	Drive Shaft	48T	28	26	57	120.5	1056				
	2000.01-2006.05			R	Bus Engine F4FA	GC018005	Outer Joint	48T	28	26	57	120.5	64	M			
2.4 Di (66 kW)	2000.01-2006.05			R	Bus Engine D2FA/D2FB/D2FE	GC018005	Outer Joint	48T	28	26	57	120.5	64	M			
2.4 Di (88 kW)	2000.01-2006.05			R	Bus Engine D4FA	GC018005	Outer Joint	48T	28	26	57	120.5	64	M			
2.4 TDCi (101 kW)	2004.03-2006.05	MT	L	F	Bus Engine H9FA	GDS18209	Drive Shaft	48T	28	36	57	120.5	794.5				
	2004.03-2006.05	MT	L	F	Bus Engine H9FA	GCI18173	Inner Joint		36	28	40	77	111.5				
	2004.03-2006.05	MT	L/R	F	Bus Engine H9FA	GC018061	Outer Joint		28	26	57	120.5	64	M			
	2004.03-2006.05	MT	R	F	Bus Engine H9FA	GDS18213	Drive Shaft	48T	28	36	57	120.5	1056				
	2004.03-2006.05	MT	R	F	Bus Engine H9FA	GCI18120	Inner Joint		36	28	40	330	120				
	2004.03-2006.05			R	Bus Engine H9FA	GC018005	Outer Joint	48T	28	26	57	120.5	64	M			
	2004.03-2006.05	MT			Bus Engine H9FA	GC099284	Outer Joint	48T	28	29	60	126.5	72	M			
2.4 TDDi (66 kW)	2001.10-2006.03			F	Bus Engine D2FE	GC018005	Outer Joint	48T	28	26	57	120.5	64	M			
2.4 TDE (85 kW)	2004.03-2006.05	MT	L	F	Bus Engine FXFA	GDS18209	Drive Shaft	48T	28	36	57	120.5	794.5				
	2004.03-2006.05	MT	L	F	Bus Engine FXFA	GCI18173	Inner Joint		36	28	40	77	111.5				
	2004.03-2006.05	MT	L/R	F	Bus Engine FXFA	GC018061	Outer Joint		28	26	57	120.5	64	M			
	2004.03-2006.05	MT	R	F	Bus Engine FXFA	GDS18213	Drive Shaft	48T	28	36	57	120.5	1056				
	2004.03-2006.05	MT	R	F	Bus Engine FXFA	GCI18120	Inner Joint		36	28	40	330	120				
	2004.03-2006.05			R	Bus Engine FXFA	GC018005	Outer Joint	48T	28	26	57	120.5	64	M			
	2004.03-2006.05	MT			Bus Engine FXFA	GC099284	Outer Joint	48T	28	29	60	126.5	72	M			
2.4 TDE (92 kW)	2001.07-2006.05			R	Bus Engine DOFA	GC018005	Outer Joint	48T	28	26	57	120.5	64	M			
<b>TRANSIT (FM_ , FN_ )</b>																	
2.0 Di (55 kW)	2000.08-2006.05			F	Platform/Chassis Engine D3FA	GC018005	Outer Joint	48T	28	26	57	120.5	64	M			
	2000.08-2006.05			F	Platform/Chassis Engine D3FA	GC018061	Outer Joint		28	26	57	120.5	64	M			
	2000.08-2006.05		L	F	Platform/Chassis Engine D3FA	GDS18209	Drive Shaft	48T	28	36	57	120.5	794.5				
	2000.08-2006.05		L	F	Platform/Chassis Engine D3FA	GCI18173	Inner Joint		36	28	40	77	111.5				
	2000.08-2006.05		L/R	F	Platform/Chassis Engine D3FA	GC018061	Outer Joint		28	26	57	120.5	64	M			
	2000.08-2006.05		R	F	Platform/Chassis Engine D3FA	GCI18120	Inner Joint		36	28	40	330	120				
	2000.08-2006.05				Platform/Chassis Engine D3FA	GC099284	Outer Joint	48T	28	29	60	126.5	72	M			
2.0 Di (63 kW)	2000.08-2006.05		R	F	Platform/Chassis Engine F3FA	GCI18120	Inner Joint		36	28	40	330	120				
	2000.08-2006.05				Platform/Chassis Engine F3FA	GC099284	Outer Joint	48T	28	29	60	126.5	72	M			
	2000.08-2006.05			F	Platform/Chassis Engine F3FA	GC018005	Outer Joint	48T	28	26	57	120.5	64	M			
	2000.08-2006.05			F	Platform/Chassis Engine F3FA	GC018061	Outer Joint		28	26	57	120.5	64	M			











		TRANSM	L/R	F/R		G-AP Ref.	PRODUCT	ABS	Technical Specifications									
									YEAR	A	B	C	H	L	P			
<b>FORD</b>																		
<b>TRANSIT (FM_, FN_)</b>																		
2.0 Di (63 kW)	2000.08-	2006.05			L F	Platform/Chassis Engine F3FA	GDS18209	Drive Shaft	48T	28	36	57	120.5	794.5				
	2000.08-	2006.05			L F	Platform/Chassis Engine F3FA	GCI18173	Inner Joint		36	28	40	77	111.5				
	2000.08-	2006.05			L/R F	Platform/Chassis Engine F3FA	GC018061	Outer Joint		28	26	57	120.5	64	M			
2.0 Di (74 kW)	2000.08-	2006.05			F	Platform/Chassis Engine ABFA	GC018005	Outer Joint	48T	28	26	57	120.5	64	M			
	2000.08-	2006.05			F	Platform/Chassis Engine ABFA	GC018061	Outer Joint		28	26	57	120.5	64	M			
	2000.08-	2006.05			L F	Platform/Chassis Engine ABFA	GDS18259	Drive Shaft	48T	28	36	57	120.5	798.5				
	2000.08-	2006.05			L F	Platform/Chassis Engine ABFA	GDS18434	Drive Shaft		28	36	57	120.5	798.5				
	2000.08-	2006.05			L F	Platform/Chassis Engine ABFA	GCI18173	Inner Joint		36	28	40	77	111.5				
	2000.08-	2006.05			L F	Platform/Chassis Engine ABFA	GCI18180	Inner Joint		36	27	40	77.5	111				
	2000.08-	2006.05			L F	Platform/Chassis Engine ABFA	GC099349	Outer Joint	48T	28	36	57	120.5	72	I			
	2000.08-	2006.05			L/R F	Platform/Chassis Engine ABFA	GC018061	Outer Joint		28	26	57	120.5	64	M			
	2000.08-	2006.05			R F	Platform/Chassis Engine ABFA	GDS18260	Drive Shaft	48T	28	36	57	120.5	1059.5				
	2000.08-	2006.05			R F	Platform/Chassis Engine ABFA	GDS18435	Drive Shaft		28	36	57	120.5	1059.5				
	2000.08-	2006.05			R F	Platform/Chassis Engine ABFA	GCI18120	Inner Joint		36	28	40	330	120				
	2000.08-	2006.05			R F	Platform/Chassis Engine ABFA	GCI18181	Inner Joint		36	27	40	330	120				
	2000.08-	2006.05				Platform/Chassis Engine ABFA	GC099284	Outer Joint	48T	28	29	60	126.5	72	M			
2.0 TDCi (92 kW)	2002.08-	2006.05			F	Platform/Chassis Engine FIFA	GC018005	Outer Joint	48T	28	26	57	120.5	64	M			
	2002.08-	2006.05			L F	Platform/Chassis Engine FIFA	GDS18434	Drive Shaft		28	36	57	120.5	798.5				
	2002.08-	2006.05			L F	Platform/Chassis Engine FIFA	GCI18173	Inner Joint		36	28	40	77	111.5				
	2002.08-	2006.05			L/R F	Platform/Chassis Engine FIFA	GC018061	Outer Joint		28	26	57	120.5	64	M			
	2002.08-	2006.05			R F	Platform/Chassis Engine FIFA	GDS18435	Drive Shaft		28	36	57	120.5	1059.5				
	2002.08-	2006.05			R F	Platform/Chassis Engine FIFA	GCI18120	Inner Joint		36	28	40	330	120				
	2002.08-	2006.05				Platform/Chassis Engine FIFA	GC099284	Outer Joint	48T	28	29	60	126.5	72	M			
2.3 16V (107 kW)	2001.04-	2006.05			R	Platform/Chassis Engine E5FA/E5FC	GC018005	Outer Joint	48T	28	26	57	120.5	64	M			
2.4 Di (55 kW)	2000.01-	2006.05			R	Platform/Chassis Engine F4FA	GC018005	Outer Joint	48T	28	26	57	120.5	64	M			
2.4 Di (66 kW)	2000.01-	2006.05			R	Platform/Chassis Engine D2FA/D2FB/D2FE	GC018005	Outer Joint	48T	28	26	57	120.5	64	M			
2.4 Di (88 kW)	2000.01-	2006.05			R	Platform/Chassis Engine D4FA	GC018005	Outer Joint	48T	28	26	57	120.5	64	M			
2.4 TDCi (101 kW)	2004.03-	2006.05	6MT	L	F	Platform/Chassis Engine H9FA	GDS18293	Drive Shaft	48T	28	41	65	124	754				
	2004.03-	2006.05	6MT	R	F	Platform/Chassis Engine H9FA	GDS18292	Drive Shaft	48T	28	41	65	124	1093				
	2004.03-	2006.05			R	Platform/Chassis Engine H9FA	GC018005	Outer Joint	48T	28	26	57	120.5	64	M			
2.4 TDE (85 kW)	2004.03-	2006.05	MT	L	F	Platform/Chassis Engine FXFA	GDS18209	Drive Shaft	48T	28	36	57	120.5	794.5				
	2004.03-	2006.05	MT	L	F	Platform/Chassis Engine FXFA	GCI18173	Inner Joint		36	28	40	77	111.5				
	2004.03-	2006.05	MT	L/R	F	Platform/Chassis Engine FXFA	GC018061	Outer Joint		28	26	57	120.5	64	M			
	2004.03-	2006.05	MT	R	F	Platform/Chassis Engine FXFA	GDS18213	Drive Shaft	48T	28	36	57	120.5	1056				
	2004.03-	2006.05	MT	R	F	Platform/Chassis Engine FXFA	GCI18120	Inner Joint		36	28	40	330	120				
	2004.03-	2006.05			R	Platform/Chassis Engine FXFA	GC018005	Outer Joint	48T	28	26	57	120.5	64	M			
	2004.03-	2006.05	MT			Platform/Chassis Engine FXFA	GC099284	Outer Joint	48T	28	29	60	126.5	72	M			
2.4 TDE (92 kW)	2001.07-	2006.05			R	Platform/Chassis Engine DOFA	GC018005	Outer Joint	48T	28	26	57	120.5	64	M			
<b>TRANSIT CONNECT (P65_, P70_, P80_)</b>																		
1.8 16V (85 kW)	2002.06-				F	Box Engine EYPA/EYPC/EYPD	GC018067	Outer Joint		25	26	53.3	94.5	64.5	M			
1.8 Di (55 kW)	2002.06-				F	Box Engine BHPA/P7PA/P7PB/R2PA	GC018207	Outer Joint		25	24	53.5	94.5	62	M			
	2002.06-		MT	L	F	Box Engine BHPA/P7PA/P7PB/R2PA	GDS18263	Drive Shaft		25	26	53.5	94.5	628				
	2002.06-		MT	R	F	Box Engine BHPA/P7PA/P7PB/R2PA	GDS18264	Drive Shaft		25	26	53.5	94.5	962				
1.8 TDCi (66 kW)	2002.06-				F	Box Engine HCPA/HCPB/P9PA/P9PB/P9PC/P9PD/R3PA/RWPE/RWPF	GC018067	Outer Joint		25	26	53.3	94.5	64.5	M			
	2002.06-		MT	L	F	Box Engine HCPA/HCPB/P9PA/P9PB/P9PC/P9PD/R3PA/RWPE/RWPF	GDS18041	Drive Shaft		25	26	53.3	94.5	632				
	2002.06-		MT	R	F	Box Engine HCPA/HCPB/P9PA/P9PB/P9PC/P9PD/R3PA/RWPE/RWPF	GDS99042	Drive Shaft		25	26	53.3	94.5	963				
<b>TRANSIT CUSTOM</b>																		
2.2 TDCi (114 kW)	2012.04-		MT	L	F	Bus Engine CVFF	GDS18413	Drive Shaft		31	41	57.7	121	753				
	2012.04-		MT	R	F	Bus Engine CVFF	GDS18335	Drive Shaft		31	41	57.7	121	1092				
	2012.12-		MT	L	F	Box	GDS18413	Drive Shaft		31	41	57.7	121	753				
	2012.12-		MT	R	F	Box	GDS18335	Drive Shaft		31	41	57.7	121	1092				
2.2 TDCi (74 kW)	2012.12-		MT	L	F	Box	GDS18413	Drive Shaft		31	41	57.7	121	753				
	2012.12-		MT	R	F	Box	GDS18335	Drive Shaft		31	41	57.7	121	1092				
2.2 TDCi (92 kW)	2012.12-		MT	L	F	Box	GDS18413	Drive Shaft		31	41	57.7	121	753				
	2012.12-		MT	R	F	Box	GDS18335	Drive Shaft		31	41	57.7	121	1092				
<b>TRANSIT TOURNEO</b>																		
2.2 TDCi (103 kW)	2007.10-		5MT	L	F	Bus Engine PGFA/PGFB	GDS99179	Drive Shaft	48T	28	36	59	128	796				
	2007.10-		6MT	L	F	Bus Engine PGFA/PGFB	GDS18293	Drive Shaft	48T	28	41	65	124	754				
	2007.10-		6MT	R	F	Bus Engine PGFA/PGFB	GDS18292	Drive Shaft	48T	28	41	65	124	1093				
2.2 TDCi (81 kW)	2006.07-		5MT	L	F	Bus Engine QVFA	GDS99179	Drive Shaft	48T	28	36	59	128	796				
	2006.07-					Bus Engine QVFA	GC099284	Outer Joint	48T	28	29	60	126.5	72	M			

		YEAR	TRANSM	L/R	F/R		G-AP Ref.	PRODUCT	ABS	Technical Specifications								
										A	B	C	H	L	P			
<b>FORD</b>																		
<b>TRANSIT TOURNEO</b>																		
2.2 TDCi (85 kW)	2008.10-		5MT	L	F	Bus Engine SRFA/SRFB/SRFC/SRFE/SRFD	GDS99179	Drive Shaft	48T	28	36	59	128	796				
	2008.10-		6MT	L	F	Bus Engine SRFA/SRFB/SRFC/SRFE/SRFD	GDS18293	Drive Shaft	48T	28	41	65	124	754				
	2008.10-		6MT	R	F	Bus Engine SRFA/SRFB/SRFC/SRFE/SRFD	GDS18292	Drive Shaft	48T	28	41	65	124	1093				
2.2 TDCi (96 kW)	2006.07-		5MT	L	F	Bus Engine QWFA	GDS99179	Drive Shaft	48T	28	36	59	128	796				
	2006.07-					Bus Engine QWFA	GC099284	Outer Joint	48T	28	29	60	126.5	72	M			
<b>TRANSIT V347</b>																		
2.2 TDCi	2006-			L	F		GDS99179	Drive Shaft	48T	28	36	59	128	796				
	2006-			R	F		GDS99244	Drive Shaft	48T	28	36	59	128	1060				
<b>TRANSIT VAN (FA_ _)</b>																		
2.0 Di (55 kW)	2000.08-	2006.05			F	Box Engine D3FA	GC018005	Outer Joint	48T	28	26	57	120.5	64	M			
	2000.08-	2006.05			F	Box Engine D3FA	GC018061	Outer Joint		28	26	57	120.5	64	M			
	2000.08-	2006.05	MT	L	F	Box Engine D3FA	GDS18035	Drive Shaft		28	26	57	120.5	797				
	2000.08-	2006.05	MT	L	F	Box Engine D3FA	GDS18036	Drive Shaft	48T	28	26	57	120.5	797				
	2000.08-	2006.05		L	F	Box Engine D3FA	GDS18209	Drive Shaft	48T	28	36	57	120.5	794.5				
	2000.08-	2006.05		L	F	Box Engine D3FA	GCI18173	Inner Joint		36	28	40	77	111.5				
	2000.08-	2006.05		L/R	F	Box Engine D3FA	GC018061	Outer Joint		28	26	57	120.5	64	M			
	2000.08-	2006.05	MT	R	F	Box Engine D3FA	GDS18142	Drive Shaft		28	26	57	120.5	1056				
	2000.08-	2006.05	MT	R	F	Box Engine D3FA	GDS18242	Drive Shaft	48T	28	26	57	120.5	1056				
	2000.08-	2006.05		R	F	Box Engine D3FA	GCI18120	Inner Joint		36	28	40	330	120				
2.0 Di (63 kW)	2000.08-	2006.05			F	Box Engine F3FA	GC018005	Outer Joint	48T	28	26	57	120.5	64	M			
	2000.08-	2006.05			F	Box Engine F3FA	GC018061	Outer Joint		28	26	57	120.5	64	M			
	2000.08-	2006.05	MT	L	F	Box Engine F3FA	GDS18035	Drive Shaft		28	26	57	120.5	797				
	2000.08-	2006.05	MT	L	F	Box Engine F3FA	GDS18036	Drive Shaft	48T	28	26	57	120.5	797				
	2000.08-	2006.05		L	F	Box Engine F3FA	GDS18209	Drive Shaft	48T	28	36	57	120.5	794.5				
	2000.08-	2006.05		L	F	Box Engine F3FA	GCI18173	Inner Joint		36	28	40	77	111.5				
	2000.08-	2006.05		L/R	F	Box Engine F3FA	GC018061	Outer Joint		28	26	57	120.5	64	M			
	2000.08-	2006.05	MT	R	F	Box Engine F3FA	GDS18142	Drive Shaft		28	26	57	120.5	1056				
	2000.08-	2006.05	MT	R	F	Box Engine F3FA	GDS18242	Drive Shaft	48T	28	26	57	120.5	1056				
	2000.08-	2006.05		R	F	Box Engine F3FA	GCI18120	Inner Joint		36	28	40	330	120				
2.0 Di (74 kW)	2000.08-	2006.05			F	Box Engine ABFA	GC018005	Outer Joint	48T	28	26	57	120.5	64	M			
	2000.08-	2006.05			F	Box Engine ABFA	GC018061	Outer Joint		28	26	57	120.5	64	M			
	2000.08-	2006.05	MT	L	F	Box Engine ABFA	GDS18035	Drive Shaft		28	26	57	120.5	797				
	2000.08-	2006.05	MT	L	F	Box Engine ABFA	GDS18036	Drive Shaft	48T	28	26	57	120.5	797				
	2000.08-	2006.05		L	F	Box Engine ABFA	GDS18259	Drive Shaft	48T	28	36	57	120.5	798.5				
	2000.08-	2006.05		L	F	Box Engine ABFA	GDS18434	Drive Shaft		28	36	57	120.5	798.5				
	2000.08-	2006.05		L	F	Box Engine ABFA	GCI18173	Inner Joint		36	28	40	77	111.5				
	2000.08-	2006.05		L	F	Box Engine ABFA	GCI18180	Inner Joint		36	27	40	77.5	111				
	2000.08-	2006.05		L	F	Box Engine ABFA	GC099349	Outer Joint	48T	28	36	57	120.5	72	I			
	2000.08-	2006.05		L/R	F	Box Engine ABFA	GC018061	Outer Joint		28	26	57	120.5	64	M			
2.0 TDCi (92 kW)	2002.08-	2006.05			F	Box Engine F1FA	GC018005	Outer Joint	48T	28	26	57	120.5	64	M			
	2002.08-	2006.05	MT	L	F	Box Engine F1FA	GDS18035	Drive Shaft		28	26	57	120.5	797				
	2002.08-	2006.05	MT	L	F	Box Engine F1FA	GDS18036	Drive Shaft	48T	28	26	57	120.5	797				
	2002.08-	2006.05		L	F	Box Engine F1FA	GDS18434	Drive Shaft		28	36	57	120.5	798.5				
	2002.08-	2006.05		L	F	Box Engine F1FA	GCI18173	Inner Joint		36	28	40	77	111.5				
	2002.08-	2006.05		L/R	F	Box Engine F1FA	GC018061	Outer Joint		28	26	57	120.5	64	M			
	2002.08-	2006.05	MT	R	F	Box Engine F1FA	GDS18142	Drive Shaft		28	26	57	120.5	1056				
	2002.08-	2006.05	MT	R	F	Box Engine F1FA	GDS18242	Drive Shaft	48T	28	26	57	120.5	1056				
	2002.08-	2006.05		R	F	Box Engine F1FA	GDS18260	Drive Shaft	48T	28	36	57	120.5	1059.5				
	2002.08-	2006.05		R	F	Box Engine F1FA	GCI18120	Inner Joint		36	28	40	330	120				
2.3 16V (107 kW)	2001.04-	2006.05			R	Box Engine E5FA/E5FC	GC018005	Outer Joint	48T	28	26	57	120.5	64	M			
	2000.01-	2006.05			R	Box Engine F4FA	GC018005	Outer Joint	48T	28	26	57	120.5	64	M			





		YEAR	TRANSM	L/R	F/R		G-AP Ref.	PRODUCT	ABS	Technical Specifications						
										A	B	C	H	L	P	
<b>FORD</b>																
<b>TRANSIT VAN (FA_ _)</b>																
2.4 Di (66 kW)	2000.01-	2006.05		L	F	Box Engine D2FA/D2FB/D2FE	GDS18209	Drive Shaft	48T	28	36	57	120.5	794.5		
	2000.01-	2006.05		L	F	Box Engine D2FA/D2FB/D2FE	GCI18173	Inner Joint		36	28	40	77	111.5		
	2000.01-	2006.05		L/R	F	Box Engine D2FA/D2FB/D2FE	GC018061	Outer Joint		28	26	57	120.5	64	M	
	2000.01-	2006.05		R	F	Box Engine D2FA/D2FB/D2FE	GDS18213	Drive Shaft	48T	28	36	57	120.5	1056		
	2000.01-	2006.05		R	F	Box Engine D2FA/D2FB/D2FE	GCI18120	Inner Joint		36	28	40	330	120		
	2000.01-	2006.05		R	F	Box Engine D2FA/D2FB/D2FE	GC018005	Outer Joint	48T	28	26	57	120.5	64	M	
2.4 Di (88 kW)	2000.01-	2006.05		R	F	Box Engine D4FA	GC018005	Outer Joint	48T	28	26	57	120.5	64	M	
2.4 TDCi (101 kW)	2004.03-	2006.05	6MT	L	F	Box Engine H9FA	GDS18293	Drive Shaft	48T	28	41	65	124	754		
	2004.03-	2006.05	6MT	R	F	Box Engine H9FA	GDS18292	Drive Shaft	48T	28	41	65	124	1093		
	2004.03-	2006.05		R	F	Box Engine H9FA	GC018005	Outer Joint	48T	28	26	57	120.5	64	M	
2.4 TDDi (88 kW)	2000.08-	2003.08		L	F	Box Engine D4FA	GDS18209	Drive Shaft	48T	28	36	57	120.5	794.5		
	2000.08-	2003.08		L	F	Box Engine D4FA	GCI18173	Inner Joint		36	28	40	77	111.5		
	2000.08-	2003.08		L/R	F	Box Engine D4FA	GC018061	Outer Joint		28	26	57	120.5	64	M	
	2000.08-	2003.08		R	F	Box Engine D4FA	GDS18213	Drive Shaft	48T	28	36	57	120.5	1056		
	2000.08-	2003.08		R	F	Box Engine D4FA	GCI18120	Inner Joint		36	28	40	330	120		
	2000.08-	2003.08				Box Engine D4FA	GC099284	Outer Joint	48T	28	29	60	126.5	72	M	
2.4 TDE (85 kW)	2004.03-	2006.05		L	F	Box Engine FXFA	GDS18209	Drive Shaft	48T	28	36	57	120.5	794.5		
	2004.03-	2006.05		L	F	Box Engine FXFA	GCI18173	Inner Joint		36	28	40	77	111.5		
	2004.03-	2006.05		L/R	F	Box Engine FXFA	GC018061	Outer Joint		28	26	57	120.5	64	M	
	2004.03-	2006.05		R	F	Box Engine FXFA	GDS18213	Drive Shaft	48T	28	36	57	120.5	1056		
	2004.03-	2006.05		R	F	Box Engine FXFA	GCI18120	Inner Joint		36	28	40	330	120		
	2004.03-	2006.05		R	F	Box Engine FXFA	GC018005	Outer Joint	48T	28	26	57	120.5	64	M	
	2004.03-	2006.05				Box Engine FXFA	GC099284	Outer Joint	48T	28	29	60	126.5	72	M	
2.4 TDE (92 kW)	2001.07-	2006.05		R	F	Box Engine DOFA	GC018005	Outer Joint	48T	28	26	57	120.5	64	M	
<b>VERONA</b>																
1.8	1990.01-	1993.09	MT				GC018044	Outer Joint		23	30	55	91.5	54.5	I	
	1993.10-	1997.12	MT				GC018100	Outer Joint		25	30	56.5	89	56.5	I	
2.0	1993.10-	1997.12	MT				GC018100	Outer Joint		25	30	56.5	89	56.5	I	
<b>FORD LCV</b>																
<b>COURIER II</b>																
1.3	1995.10-	1997.01	MT	R	F		GDS99043	Drive Shaft		25	25	56.5	88.5	813		
1.8 D	1995.10-	1997.01	MT	R	F		GDS99043	Drive Shaft		25	25	56.5	88.5	813		
	1997.01-	2000.03	MT	R	F		GDS18032	Drive Shaft		25	23	56.5	88.5	900		
<b>FIESTA IV VAN</b>																
1.8 D	1996.09-	2000.03	MT	R	F		GDS18032	Drive Shaft		25	23	56.5	88.5	900		
<b>TRANSIT VII (FA, FD, FM)</b>																
2.4 Di (55 kW)	2000.01-						GC018220	Outer Joint		28	36	57	120.5	72	I	
2.4 Di (66 kW)	2000.01-						GC018220	Outer Joint		28	36	57	120.5	72	I	
2.4 Di (88 kW)	2000.01-						GC018220	Outer Joint		28	36	57	120.5	72	I	
<b>FORD USA</b>																
<b>PROBE</b>																
2.2 (82 kW)	1988.08-	1993.07	MT/AT		F	Coupe	GC018031	Outer Joint		26	25	56	93	61	M	
<b>GEO</b>																
<b>PRIZM</b>																
-	1993-	2000					GC059163	Outer Joint	48T	26	29	56	99.5	62.5	O	
All Models	1989.01-	1992.12					GC021001	Outer Joint		26	29	56	96	62	O	
<b>S10 / S10 BLAZER</b>																
-	1997-	2005				SUV/Truck/VAN 4WD	GC088011	Outer Joint		27	34	55.8	127.5	64	O	
<b>STORM</b>																
1.6 i (67 kW)	1991.04-	1993.12			F	Coupe	GC021002	Outer Joint		22	21	50	94.5	54	M	
1.6 i (71 kW)	1989.01-	1991.03			F	Coupe	GC021002	Outer Joint		22	21	50	94.5	54	M	
<b>GM</b>																
<b>-</b>																
4.5	1992-	1996				C/H/E Body	GC086003	Outer Joint		33	32	50	105	62.5	O	
	1992-					E Body	GC086003	Outer Joint		33	32	50	105	62.5	O	
	1994-	1996				A Body	GC086003	Outer Joint		33	32	50	105	62.5	O	
<b>ASTRA</b>																
1.8 8V	1999.01-	2006.12	MT				GCI99026	Inner Joint		22	25	35	57	82.5		
	1999.01-	2006.12	MT				GC044032	Outer Joint		33	25	52	103.5	61	O	



		TRANSM	L/R	F/R		G-AP Ref.	PRODUCT	ABS	Technical Specifications										
									YEAR	A	B	C	H	L	P				
<b>GM</b>																			
<b>ASTRA</b>																			
2.0 16V	1999.01-	2006.12	MT			GC044032	Outer Joint		33	25	52	103.5	61	O					
2.0 8V	1999.01-	2006.12	MT			GCI99026	Inner Joint		22	25	35	57	82.5						
	1999.01-	2006.12	MT			GC044032	Outer Joint		33	25	52	103.5	61	O					
<b>CAVALIER</b>																			
-	1990-	1993	MT			GC021006	Outer Joint		33	32	47.7	109	66	I					
	1990-	1993	MT			GCI21007	Inner Joint		34	25	35	55.5	118						
	1991-	1993	AT			GC021006	Outer Joint		33	32	47.7	109	66	I					
	1994-		AT			GCI21007	Inner Joint		34	25	35	55.5	118						
	1994-					GC021017	Outer Joint	48T	33	32	47.7	109	66	I					
	1995-	1998	MT			GCI21007	Inner Joint		34	25	35	55.5	118						
	1995-	1998	AT			GC021017	Outer Joint	48T	33	32	47.7	109	66	I					
	1995-	1998	MT			GC021017	Outer Joint	48T	33	32	47.7	109	66	I					
<b>CAVALIER / CAVALIER Z-24</b>																			
-	1994-		MT			GC021017	Outer Joint	48T	33	32	47.7	109	66	I					
<b>CAVALIER Z-24</b>																			
-	1995-	1998	MT			GCI21007	Inner Joint		34	25	35	55.5	118						
	1995-	1998	MT			GC021017	Outer Joint	48T	33	32	47.7	109	66	I					
<b>CELEBRITY</b>																			
-	1982-	1984	MT			GC021011	Outer Joint		33	23	47.7	109	66	I					
	1982-	1985	AT			GC021011	Outer Joint		33	23	47.7	109	66	I					
<b>CELEBRITY / CENTURY / CENTURY SS</b>																			
-	1986-	1988	AT			GCI21009	Inner Joint		34	24	35	52	78						
	1986-	1988	AT			GC021003	Outer Joint		33	24	47.7	109	66	I					
<b>CELEBRITY / CENTURY SS</b>																			
-	1983-	1985	AT			GCI21009	Inner Joint		34	24	35	52	78						
	1983-	1985	AT			GC021003	Outer Joint		33	24	47.7	109	66	I					
<b>CELTA</b>																			
1.0	2000.06-	2006.12	MT			GCI99023	Inner Joint		22	28	34.95	57.5	72.5						
	2000.06-	2006.12	MT			GC021025	Outer Joint		22	28	52	90	54	O					
1.0 VHC	2000.06-	2006.12	MT			GCI99023	Inner Joint		22	28	34.95	57.5	72.5						
	2000.06-	2006.12	MT			GC021025	Outer Joint		22	28	52	90	54	O					
1.4	2000.06-	2006.12	MT			GCI99023	Inner Joint		22	28	34.95	57.5	72.5						
	2000.06-	2006.12	MT			GC021025	Outer Joint		22	28	52	90	54	O					
<b>CENTURY</b>																			
-	1994-	1997	AT			GC021010	Outer Joint		33	32	50	105	61	I					
<b>CENTURY / CUTLASS</b>																			
-	1990-		AT			GC021006	Outer Joint		33	32	47.7	109	66	I					
	1990-		MT			GC021006	Outer Joint		33	32	47.7	109	66	I					
	1990-		AT			GCI21007	Inner Joint		34	25	35	55.5	118						
	1990-		MT			GCI21007	Inner Joint		34	25	35	55.5	118						
<b>CENTURY / CUTLASS / CUTLASS EUROSPORT</b>																			
-	1994-	1997	AT			GCI21007	Inner Joint		34	25	35	55.5	118						
<b>CENTURY / CUTLASS EUROSPORT</b>																			
-	1991-	1993	AT			GCI21007	Inner Joint		34	25	35	55.5	118						
<b>CENTURY SS</b>																			
-	1983-	1985	AT			GC021011	Outer Joint		33	23	47.7	109	66	I					
<b>CHEVY / MONZA</b>																			
-	1996-	2003	MT/AT			GCI99027	Inner Joint		22	28	35	57.5	93						
	1996-	2003	MT/AT			GC044031	Outer Joint		22	28	52	95.5	57.5	I					
<b>CITATION</b>																			
-	1982-	1984	MT			GC021011	Outer Joint		33	23	47.7	109	66	I					
	1982-	1985	AT			GC021011	Outer Joint		33	23	47.7	109	66	I					
<b>CITATION / CELEBRITY</b>																			
-	1982-	1985	AT			GCI21009	Inner Joint		34	24	35	52	78						
	1982-	1983	MT			GCI99108	Inner Joint		23	24	35.4	171	109						
	1982-	1983	MT			GC021003	Outer Joint		33	24	47.7	109	66	I					
	1982-	1985	AT			GC021003	Outer Joint		33	24	47.7	109	66	I					
<b>CITATION / CELEBRITY / X-11</b>																			
-	1986-	1988	MT			GCI99108	Inner Joint		23	24	35.4	171	109						
	1986-	1988	MT			GC021003	Outer Joint		33	24	47.7	109	66	I					

																			
									YEAR	A	B	C	H	L	P				
<b>GM CORSA</b>																			
-																			
1.0					India	GDS44009	Drive Shaft		22	22	52	90	549						
	1994-		MT			GC021026	Outer Joint		22	22	52	97.5	55	O					
	1994.01-	2003.12	MT			GCI99023	Inner Joint		22	28	34.95	57.5	72.5						
	1994.01-	2003.12	MT			GCI21014	Inner Joint		22	22	35	57.5	75						
	1994.01-	2003.12	MT			GC021025	Outer Joint		22	28	52	90	54	O					
	1994.01-	2003.12	MT			GC021032	Outer Joint		22	22	52	97	50	O					
	1994.01-	2003.12	MT	L		GDS21040	Drive Shaft		22	22	52.1	97	568						
	1994.01-	2003.12	MT	R		GDS44041	Drive Shaft		22	22	52.1	97	917						
1.4																			
	1994-		MT			GC021026	Outer Joint		22	22	52	97.5	55	O					
	1994.01-	2003.12	MT			GCI99023	Inner Joint		22	28	34.95	57.5	72.5						
	1994.01-	2003.12	MT			GCI21014	Inner Joint		22	22	35	57.5	75						
	1994.01-	2003.12	MT			GC021025	Outer Joint		22	28	52	90	54	O					
	1994.01-	2003.12	MT			GC021032	Outer Joint		22	22	52	97	50	O					
	1994.01-	2003.12	MT	L		GDS21040	Drive Shaft		22	22	52.1	97	568						
	1994.01-	2003.12	MT	R		GDS44041	Drive Shaft		22	22	52.1	97	917						
1.6																			
	1994-		MT			GC021026	Outer Joint		22	22	52	97.5	55	O					
	1994.01-	2003.12	MT			GCI99023	Inner Joint		22	28	34.95	57.5	72.5						
	1994.01-	2003.12	MT			GCI21014	Inner Joint		22	22	35	57.5	75						
	1994.01-	2003.12	MT			GC021025	Outer Joint		22	28	52	90	54	O					
	1994.01-	2003.12	MT			GC021032	Outer Joint		22	22	52	97	50	O					
	1994.01-	2003.12	MT	L		GDS21040	Drive Shaft		22	22	52.1	97	568						
	1994.01-	2003.12	MT	R		GDS44041	Drive Shaft		22	22	52.1	97	917						
1.8 8V																			
	2002-			L		GDS44034	Drive Shaft		22	22	52	97.5	580						
	2002-			R		GDS44035	Drive Shaft		22	22	52	97.5	929						
	2002-			L/R		GC044066	Outer Joint		22	23	52	97.5	61	M					
	2002-			L/R		GCI44015	Inner Joint		22	23	35	57.5	82						
<b>CORSA CLASSIC</b>																			
1.0 VHC																			
	2004.01-	2006.12	MT			GCI99023	Inner Joint		22	28	34.95	57.5	72.5						
	2004.01-	2006.12	MT			GCI21014	Inner Joint		22	22	35	57.5	75						
	2004.01-	2006.12	MT			GC021025	Outer Joint		22	28	52	90	54	O					
	2004.01-	2006.12	MT	L		GDS21040	Drive Shaft		22	22	52.1	97	568						
	2004.01-	2006.12	MT	R		GDS44041	Drive Shaft		22	22	52.1	97	917						
1.6																			
	2004.01-	2006.12	MT			GCI99023	Inner Joint		22	28	34.95	57.5	72.5						
	2004.01-	2006.12	MT			GCI21014	Inner Joint		22	22	35	57.5	75						
	2004.01-	2006.12	MT			GC021025	Outer Joint		22	28	52	90	54	O					
	2004.01-	2006.12	MT	L		GDS21040	Drive Shaft		22	22	52.1	97	568						
	2004.01-	2006.12	MT	R		GDS44041	Drive Shaft		22	22	52.1	97	917						
<b>CORSA NOVO</b>																			
1.0																			
	2002.03-	2006.12	MT			GCI99023	Inner Joint		22	28	34.95	57.5	72.5						
	2002.03-	2006.12	MT			GC021025	Outer Joint		22	28	52	90	54	O					
1.0 8V VHC																			
	2002-	2007	MT			GC021032	Outer Joint		22	22	52	97	50	O					
1.0 VHC																			
	2002.03-	2006.12	MT			GCI99023	Inner Joint		22	28	34.95	57.5	72.5						
	2002.03-	2006.12	MT			GC021025	Outer Joint		22	28	52	90	54	O					
<b>CORSA PICK UP</b>																			
1.6																			
	1994.01-	2006.12	MT			GCI99023	Inner Joint		22	28	34.95	57.5	72.5						
	1994.01-	2006.12	MT			GCI21014	Inner Joint		22	22	35	57.5	75						
	1994.01-	2006.12	MT			GC021025	Outer Joint		22	28	52	90	54	O					
	1994.01-	2006.12	MT	L		GDS21040	Drive Shaft		22	22	52.1	97	568						
	1994.01-	2006.12	MT	R		GDS44041	Drive Shaft		22	22	52.1	97	917						
1.6 8V																			
	1995.01-	2003.12	MT			GC021032	Outer Joint		22	22	52	97	50	O					
<b>CORSA SEDAN</b>																			
1.0																			
	1994.01-	2003.12	MT			GCI99023	Inner Joint		22	28	34.95	57.5	72.5						
	1994.01-	2003.12	MT			GCI21014	Inner Joint		22	22	35	57.5	75						
	1994.01-	2003.12	MT			GC021025	Outer Joint		22	28	52	90	54	O					
	1994.01-	2003.12	MT			GC021032	Outer Joint		22	22	52	97	50	O					
	1994.01-	2003.12	MT	L		GDS21040	Drive Shaft		22	22	52.1	97	568						
	1994.01-	2003.12	MT	R		GDS44041	Drive Shaft		22	22	52.1	97	917						
1.6																			
	1994.01-	2003.12	MT			GCI99023	Inner Joint		22	28	34.95	57.5	72.5						
	1994.01-	2003.12	MT			GCI21014	Inner Joint		22	22	35	57.5	75						
	1994.01-	2003.12	MT			GC021025	Outer Joint		22	28	52	90	54	O					
	1994.01-	2003.12	MT			GC021032	Outer Joint		22	22	52	97	50	O					
	1994.01-	2003.12	MT	L		GDS21040	Drive Shaft		22	22	52.1	97	568						









	YEAR	TRANSM	L/R	F/R	G-AP Ref.	PRODUCT	ABS	Technical Specifications									
								A	B	C	H	L	P				
<b>GM</b>																	
<b>CORSA SEDAN</b>																	
1.6	1994.01-	2003.12	MT	R		GDS44041	Drive Shaft		22	22	52.1	97	917				
<b>CORSA WAGON</b>																	
1.0	1994.01-	2003.12	MT			GCI99023	Inner Joint		22	28	34.95	57.5	72.5				
	1994.01-	2003.12	MT			GCI21014	Inner Joint		22	22	35	57.5	75				
	1994.01-	2003.12	MT			GC021025	Outer Joint		22	28	52	90	54	O			
	1994.01-	2003.12	MT			GC021032	Outer Joint		22	22	52	97	50	O			
	1994.01-	2003.12	MT	L		GDS21040	Drive Shaft		22	22	52.1	97	568				
	1994.01-	2003.12	MT	R		GDS44041	Drive Shaft		22	22	52.1	97	917				
1.6	1994.01-	2003.12	MT			GCI99023	Inner Joint		22	28	34.95	57.5	72.5				
	1994.01-	2003.12	MT			GCI21014	Inner Joint		22	22	35	57.5	75				
	1994.01-	2003.12	MT			GC021025	Outer Joint		22	28	52	90	54	O			
	1994.01-	2003.12	MT			GC021032	Outer Joint		22	22	52	97	50	O			
	1994.01-	2003.12	MT	L		GDS21040	Drive Shaft		22	22	52.1	97	568				
	1994.01-	2003.12	MT	R		GDS44041	Drive Shaft		22	22	52.1	97	917				
<b>CUTLASS</b>																	
-	1994-	1997	AT			GC021010	Outer Joint		33	32	50	105	61	I			
<b>CUTLASS EUROSPORT</b>																	
-	1991-	1997	MT			GCI21007	Inner Joint		34	25	35	55.5	118				
	1994-	1997	MT			GC021010	Outer Joint		33	32	50	105	61	I			
<b>MERIVA</b>																	
1.8 16V	2002.01-	2006.12	MT			GCI44015	Inner Joint		22	23	35	57.5	82				
	2002.01-	2006.12	MT			GC044002	Outer Joint	29T	22	23	52	97.5	61	M			
	2002.09-	2006.12	MT			GC044066	Outer Joint		22	23	52	97.5	61	M			
1.8 8V	2002.01-	2006.12	MT			GCI44015	Inner Joint		22	23	35	57.5	82				
	2002.01-	2006.12	MT			GC044066	Outer Joint		22	23	52	97.5	61	M			
	2002.09-	2006.12	MT			GC044002	Outer Joint	29T	22	23	52	97.5	61	M			
<b>OMEGA</b>																	
2.0	1993.01-	1999.12	MT			GCI99127	Inner Joint			25		26					
2.2	1994.10-	1999.12	MT			GCI99127	Inner Joint			25		26					
<b>PICK UP</b>																	
1.6	1994-		MT			GC021026	Outer Joint		22	22	52	97.5	55	O			
<b>SPACE VAN</b>																	
2.2	1991.01-	1999.12	MT			GC099076	Outer Joint		25	27	56.3	110.5	62	I			
<b>SUPREMA</b>																	
2.0	1993.01-	1999.12	MT			GCI99127	Inner Joint			25		26					
2.2	1994.10-	1999.12	MT			GCI99127	Inner Joint			25		26					
<b>VECTRA</b>																	
1.8	1994.01-	1996.12	MT			GC044069	Outer Joint	29T	33	25	52	109	61	O			
2.0	1994.01-	1996.12	MT			GC044069	Outer Joint	29T	33	25	52	109	61	O			
	1997.01-	2006.12	MT			GC021031	Outer Joint		33	25	52	103.5	61	O			
2.2	1997.01-	2006.12	MT			GC021031	Outer Joint		33	25	52	103.5	61	O			
<b>ZAFIRA</b>																	
2.0 16V	2002.01-	2006.12	MT			GC044032	Outer Joint		33	25	52	103.5	61	O			
2.0 8V	2002.01-	2006.12	MT			GCI99026	Inner Joint		22	25	35	57	82.5				
	2002.01-	2006.12	MT			GC044032	Outer Joint		33	25	52	103.5	61	O			
<b>GMC</b>																	
<b>ENVOY / ENVOY XL</b>																	
-	1998-	2004				GCI88008	Inner Joint		26	34	40	92	98				
	1998-	2005			SUV/Truck/VAN 4WD	GC088011	Outer Joint		27	34	55.8	127.5	64	O			
<b>JIMMY / K1500 / K2500 / K3500</b>																	
-	1988-	1997				GC088009	Outer Joint		33	29	80	112	88.5	O			
	1992-	1994			4WD Suv/Truck/Van	GC021022	Outer Joint	55T	33	29	80	112	88.5	O			
<b>S15 / JIMMY / SONOMA / PICK UP</b>																	
All Models	1985.01-	1990.12				GC088005	Outer Joint		27	34	56	109	63	O			
<b>S15 / JIMMY / SONOMA / SYCLONE / TYPHOON</b>																	
-	1997-	2004				GCI88008	Inner Joint		26	34	40	92	98				
	1997-	2004			4WD	GCI88009	Inner Joint		26	34	40	55	85				
	1997-	2005			SUV/Truck/VAN 4WD	GC088011	Outer Joint		27	34	55.8	127.5	64	O			
<b>SAFARI</b>																	
-	1990-	1996			VAN M-Body 4WD	GC088006	Outer Joint		33	35	77	112.5	73.5	O			



		TRANSM	L/R	F/R		G-AP Ref.	PRODUCT	ABS	Technical Specifications									
									YEAR	A	B	C	H	L	P			
<b>GMC SAFARI</b>																		
-	1997-2000				VAN M-Body 4WD	GC088006	Outer Joint		33	35	77	112.5	73.5	O				
-	1997-2000				VAN M-Body 4WD	GC021019	Outer Joint	55T	33	35	77	112.5	73.5	O				
<b>SIERRA PICK UP</b>																		
-	2001-2005				4WD SUV/Truck/VAN	GC039029	Outer Joint		33	41	80	112	88.5	O				
<b>SUBURBAN / YUKON XL</b>																		
-	1988-1997					GC088009	Outer Joint		33	29	80	112	88.5	O				
-	1992-1994				4WD Suv/Truck/Van	GC021022	Outer Joint	55T	33	29	80	112	88.5	O				
-	1998-2005				4WD SUV/Truck/VAN	GC039029	Outer Joint		33	41	80	112	88.5	O				
<b>HAWTAI E70</b>																		
2.0 (100 kW)	2013.02-		MT		Saloon Engine 4G63S4N	GC083100	Outer Joint		36	33	59.5	38	55	I				
<b>HOLDEN APOLLO</b>																		
-	1990.01-	1993.04	MT/AT	R	JK	GDS59032	Drive Shaft		26	20	56	95.5	913.5					
<b>ASTRA</b>																		
1.8/2.6	1998.01-	2002.11	MT/AT			GC022004	Outer Joint		33	25	52	109	61	M				
<b>ASTRA TS</b>																		
-	2003-					GC022005	Outer Joint		33	24	52	104	64	M				
<b>BARINA</b>																		
-	1985.01-	1986.12				GCI57009	Inner Joint		22	19	40	57.5	70					
1.3	1986.01-	1988.12	MT			GCI57009	Inner Joint		22	19	40	57.5	70					
	1989.01-	1994.03	AT	L		GDS57009	Drive Shaft		23	22	49	92	565					
	1989.01-	1994.03	AT	R		GDS57010	Drive Shaft		23	22	49	92	555					
MB ML	1985.01-	1986.12	MT/AT	L		GDS57007	Drive Shaft		23	22	44	89.5	585					
	1985.01-	1986.12	MT/AT	R		GDS57008	Drive Shaft		23	22	44	89.5	567					
ML	1986.01-	1988.12	MT	L		GDS57007	Drive Shaft		23	22	44	89.5	585					
	1986.01-	1988.12	MT	R		GDS57008	Drive Shaft		23	22	44	89.5	567					
<b>COMMODORE</b>																		
-	1997.09-			L/R		GDS99155	Drive Shaft						32	468				
<b>JACKAROO</b>																		
-	1998.01-	2002.11	MT/AT			GCI26003	Inner Joint		17	33	30	517	90.5					
2.6 Petrol/2.8/Diesel Turbo	1988.01-	1992.04	MT/AT			GCI26001	Inner Joint		17	26	30	517	97.5					
	1988.01-	1992.04	MT/AT			GCI26002	Inner Joint		17	26	30	98	98.5					
	1988.01-	1992.04	MT/AT	L		GDS26004	Drive Shaft		17	17	53	144	966					
	1988.01-	1992.04	MT/AT	R		GDS23004	Drive Shaft		17	17	53	144	547					
<b>NOVA</b>																		
-	1989.01-		MT/AT			GCI88015	Inner Joint		23	23	34	61	116					
	1989.01-			L		GDS59035	Drive Shaft		26	23	56	96.5	605					
	1989.01-		MT/AT	R		GDS88017	Drive Shaft		26	23	56	96.5	910					
<b>RODEO</b>																		
2.6 Petrol/2.8 Diesel Turbo	1988.01-	1995.05	MT/AT	R		GDS23004	Drive Shaft		17	17	53	144	547					
	1988.01-	1995.05	MT/AT			GCI26001	Inner Joint		17	26	30	517	97.5					
	1988.01-	1995.05	MT/AT			GCI26002	Inner Joint		17	26	30	98	98.5					
	1988.01-	1995.05	MT/AT	L		GDS26004	Drive Shaft		17	17	53	144	966					
2.8 DT	1995.01-	1997.12	MT/AT	R	TFG6 TFG7 JAFS17HP7	GDS23004	Drive Shaft		17	17	53	144	547					
	1995.01-	1997.12	MT/AT			GCI26001	Inner Joint		17	26	30	517	97.5					
	1995.01-	1997.12	MT/AT			GCI26002	Inner Joint		17	26	30	98	98.5					
	1995.01-	1997.12	MT/AT	L		GDS26004	Drive Shaft		17	17	53	144	966					
<b>HONDA ACCORD</b>																		
-				R		GDS81027	Drive Shaft		26	27	63	79	961					
	1980-1983					GCI23002	Inner Joint		25	22	35	54.5	90					
	1984-1989	MT/AT				GC023043	Outer Joint		26	32	49	79	56	M				
	1986-1989	AT		B/S		GCI81002	Inner Joint		27	32	40	54	87					
	1994-1997		L	4 Cyl		GDS81015	Drive Shaft	50T	28	27	60	88	977					

		TRANSM	L/R	F/R		G-AP Ref.	PRODUCT	ABS	Technical Specifications									
									YEAR	A	B	C	H	L	P			
<b>HONDA ACCORD</b>																		
-	1997-		AT	L	4 Cyl	GDS23031	Drive Shaft		28	27	60	88	1005.5					
	1998-2000		MT	L	4 Cyl	GDS81028	Drive Shaft		28	27	60	88	651.5					
	1998-2002		MT/AT	R	F 4 Cyl	GDS23061	Drive Shaft		28	27	60	88	631					
	1998-2000		MT	L	4 Cyl	GCI81003	Inner Joint		27	32	40	55	97.5					
	1998.02-		AT	L	4 Cyl	GDS23032	Drive Shaft	50T	28	27	60	88	1005.5					
	2003-2007		AT			GCI23017	Inner Joint		27	30	40	58.5	97					
	2003-2007		AT	L		GDS81026	Drive Shaft		26	27	63	79	661					
	2008-					GC023103	Outer Joint		30	30	68	89	59	M				
2.2	1989.01-1994.12		AT	L		GDS81003	Drive Shaft		28	27	60	88	958					
	1989.01-1994.12		MT/AT	R		GDS23084	Drive Shaft		28	27	60	88	600					
	1989.11-1992.10		MT	L		GDS23008	Drive Shaft		28	27	60	88	597					
2.2 CD	1993.01-1997.12			L		GDS81006	Drive Shaft		28	27	60	88	982					
	1993.01-1997.12			R		GDS81004	Drive Shaft		28	27	60	88	618					
3.5	2009.01-		AT			GC023153	Outer Joint		30	32	68	88.5	59.5	M				
<b>ACCORD (CB1)</b>																		
1.8	1989.01-	1993.09	MT&AT		Engine F18A	GC023015	Outer Joint		28	32	60	89	60	M				
<b>ACCORD (CB2)</b>																		
1.8 4WS	1989.01-	1993.09	MT&AT		Engine F18A	GC023015	Outer Joint		28	32	60	89	60	M				
<b>ACCORD (CB3)</b>																		
2.0	1989.01-	1993.09	MT&AT		Engine F20A	GC023015	Outer Joint		28	32	60	89	60	M				
<b>ACCORD (CB4)</b>																		
2.0 4WS	1989.01-	1993.09	MT&AT		Engine F20A	GC023015	Outer Joint		28	32	60	89	60	M				
<b>ACCORD (CD3)</b>																		
1.8	1993.09-	1997.09	MT&AT		Engine F18B	GC023015	Outer Joint		28	32	60	89	60	M				
<b>ACCORD (CD4)</b>																		
2.0	1993.09-	1997.09	AT		Engine F20B	GC023015	Outer Joint		28	32	60	89	60	M				
<b>ACCORD (CD5)</b>																		
2.2	1993.09-	1997.09	AT		Engine F22B	GC023015	Outer Joint		28	32	60	89	60	M				
<b>ACCORD (CD6)</b>																		
2.2	1993.09-	1997.09	MT&AT		Engine H22A	GC023015	Outer Joint		28	32	60	89	60	M				
<b>ACCORD (CD7)</b>																		
2.2	1994.03-	1994.11	AT		Engine F22B	GC023015	Outer Joint		28	32	60	89	60	M				
<b>ACCORD (CD8)</b>																		
2.2	1994.03-	1994.11	AT		Engine H22A	GC023015	Outer Joint		28	32	60	89	60	M				
<b>ACCORD (CE1)</b>																		
2.2	1994.03-	1994.11	AT		Engine F22B	GC023015	Outer Joint		28	32	60	89	60	M				
<b>ACCORD (CL)</b>																		
-	2002-	2008				GCI23046	Inner Joint		23	25	55	78	85					
<b>ACCORD (CL1)</b>																		
2.2	2000.06-	2002.10	5MT/F		Engine H22A DOHC	GC023029	Outer Joint	50T	28	32	64	89	60	M				
<b>ACCORD (CN1)</b>																		
2.2	2003-		MT		Engine N22A1	GC023146	Outer Joint		28	34	63	88.5	59.5	M				
<b>ACCORD (CU2)</b>																		
2.4	2008.12-		5AT		Engine K24A	GC023168	Outer Joint		30	30	68	88.5	59.5	M				
<b>ACCORD (SDA)</b>																		
2.0	2003.01-		MT/AT		Engine K20A7	GC023056	Outer Joint		26	30	63	79	59	M				
2.4	2003.01-		MT/AT		Engine K24A4	GC023056	Outer Joint		26	30	63	79	59	M				
<b>ACCORD (SJ, SY)</b>																		
1.6 L/EX (59 kW)	1978.01-	1983.09			F Saloon Engine EG/EL	GC081002	Outer Joint		24	22	45	78	57	M				
	1979.01-	1983.09	MT/AT		F Hatchback Engine EL	GC023003	Outer Joint		23	22	45	78	55	M				
	1979.01-	1983.09			F Hatchback Engine EL	GC081002	Outer Joint		24	22	45	78	57	M				
<b>ACCORD I (SC,SJ,SM,SV,SY)</b>																		
1.6 (SM/SV)	1980.01-	1981.12	MT/AT		Engine EP	GC023004	Outer Joint		24	30	45	79	55	M				
1.6 L/EX (SY) (59 kW)	1981.09-	1983.09	MT		Engine EL	GC023004	Outer Joint		24	30	45	79	55	M				
1.8 (SM/SC)	1982.01-	1983.10	MT/AT		Engine EK	GC023004	Outer Joint		24	30	45	79	55	M				
<b>ACCORD II</b>																		
-	1985.01-	1985.12		R	F USA	GCI81002	Inner Joint		27	32	40	54	87					
<b>ACCORD II (AC, AD)</b>																		
1.6 EX (65 kW)	1983.09-	1985.10	MT/AT		F Hatchback Engine EZ	GC023005	Outer Joint		24	30	47	79	56.5	M				
	1983.09-	1985.10	MT/AT		F Saloon Engine EZ	GC023005	Outer Joint		24	30	47	79	56.5	M				









		TRANSM	L/R	F/R		G-AP Ref.	PRODUCT	ABS	Technical Specifications						
									YEAR	A	B	C	H	L	P
<b>HONDA</b>															
<b>ACCORD II (AC, AD)</b>															
1.8 EX (74 kW)	1983.09-	1985.10	MT/AT		F	Hatchback Engine ET1	GC081001	Outer Joint		26	32	49	78.5	54.5	M
	1983.09-	1985.10	MT/AT		F	Saloon Engine ET1	GC081001	Outer Joint		26	32	49	78.5	54.5	M
<b>ACCORD III (CA4, CA5)</b>															
1.6 (65 kW)	1985.11-	1989.12	MT/AT		F	Saloon Engine A16A1	GC023011	Outer Joint		26	30	49	79	53	M
	1985.11-	1989.12			F	Saloon Engine A16A1	GC023012	Outer Joint	100T	26	30	49	78.5	55.5	M
2.0 EX (75 kW)	1985.11-	1989.12	MT/AT		F	Saloon Engine A20A1	GC023021	Outer Joint		26	32	49	78.5	56.5	M
	1985.11-	1989.12	MT/AT		F	Saloon Engine A20A1	GC023026	Outer Joint	100T	26	32	49	78.5	54.5	M
	1985.11-	1989.12	MT/AT		F	Saloon Engine A20A1	GC023071	Outer Joint	50T	26	32	49	78.5	56.5	M
2.0 EX (76 kW)	1985.11-	1989.12	MT/AT		F	Saloon Engine A20A1	GC023021	Outer Joint		26	32	49	78.5	56.5	M
	1985.11-	1989.12	MT/AT		F	Saloon Engine A20A1	GC023026	Outer Joint	100T	26	32	49	78.5	54.5	M
	1985.11-	1989.12	MT/AT		F	Saloon Engine A20A1	GC023071	Outer Joint	50T	26	32	49	78.5	56.5	M
2.0 EX (78 kW)	1985.11-	1989.05	MT/AT		F	Saloon Engine A20A2	GC023021	Outer Joint		26	32	49	78.5	56.5	M
	1985.11-	1989.05	MT/AT		F	Saloon Engine A20A2	GC023026	Outer Joint	100T	26	32	49	78.5	54.5	M
	1985.11-	1989.05	MT/AT		F	Saloon Engine A20A2	GC023071	Outer Joint	50T	26	32	49	78.5	56.5	M
2.0 EXi (85 kW)	1986.01-	1989.12	MT/AT		F	Saloon Engine A20A3	GC023021	Outer Joint		26	32	49	78.5	56.5	M
	1986.01-	1989.12	MT/AT		F	Saloon Engine A20A3	GC023026	Outer Joint	100T	26	32	49	78.5	54.5	M
	1986.01-	1989.12	MT/AT		F	Saloon Engine A20A3	GC023071	Outer Joint	50T	26	32	49	78.5	56.5	M
2.0 EXi (90 kW)	1985.11-	1987.12	MT/AT		F	Saloon Engine A20A4	GC023021	Outer Joint		26	32	49	78.5	56.5	M
2.0 i 16V (101 kW)	1987.01-	1987.12	MT/AT		F	Saloon Engine B20A2	GC023016	Outer Joint		26	32	55	78.5	56.5	M
2.0 i 16V (98 kW)	1987.10-	1989.12	MT/AT		F	Saloon Engine B20A8	GC023016	Outer Joint		26	32	55	78.5	56.5	M
<b>ACCORD III (CA5)</b>															
1.6 (65 kW)	1985.11-	1989.12	MT/AT		F	Estate Engine A16A1	GC023011	Outer Joint		26	30	49	79	53	M
2.0 EX (75 kW)	1987.10-	1989.12	MT/AT		F	Estate Engine A20A1	GC023021	Outer Joint		26	32	49	78.5	56.5	M
	1987.10-	1989.12	MT/AT		F	Estate Engine A20A1	GC023026	Outer Joint	100T	26	32	49	78.5	54.5	M
	1987.10-	1989.12	MT/AT		F	Estate Engine A20A1	GC023071	Outer Joint	50T	26	32	49	78.5	56.5	M
2.0 EX (76 kW)	1987.10-	1989.12	MT/AT		F	Estate Engine A20A1	GC023021	Outer Joint		26	32	49	78.5	56.5	M
	1987.10-	1989.12	MT/AT		F	Estate Engine A20A1	GC023026	Outer Joint	100T	26	32	49	78.5	54.5	M
	1987.10-	1989.12	MT/AT		F	Estate Engine A20A1	GC023071	Outer Joint	50T	26	32	49	78.5	56.5	M
2.0 EX (78 kW)	1985.11-	1989.05	MT/AT		F	Estate Engine A20A2	GC023021	Outer Joint		26	32	49	78.5	56.5	M
	1985.11-	1989.05	MT/AT		F	Estate Engine A20A2	GC023026	Outer Joint	100T	26	32	49	78.5	54.5	M
	1985.11-	1989.05	MT/AT		F	Estate Engine A20A2	GC023071	Outer Joint	50T	26	32	49	78.5	56.5	M
2.0 EXi (85 kW)	1987.10-	1989.12	MT/AT		F	Estate Engine A20A3	GC023071	Outer Joint	50T	26	32	49	78.5	56.5	M
	1987.10-	1989.12	MT/AT		F	Estate Engine A20A3	GC023021	Outer Joint		26	32	49	78.5	56.5	M
	1987.10-	1989.12	MT/AT		F	Estate Engine A20A3	GC023026	Outer Joint	100T	26	32	49	78.5	54.5	M
2.0 EXi (90 kW)	1985.11-	1987.12	MT/AT		F	Estate Engine A20A4	GC023021	Outer Joint		26	32	49	78.5	56.5	M
<b>ACCORD IV</b>															
2.0 i	1992-	1996			L/R	F	GC123004	Inner Joint		25	30	35	62	97.5	
<b>ACCORD IV (CB)</b>															
2.0 16V (66 kW)	1990.01-	1993.03	MT/AT		F	Saloon Engine F20A6	GC023013	Outer Joint		28	32	60	88	59	M
	1990.01-	1993.03	MT/AT		F	Saloon Engine F20A6	GC023014	Outer Joint	50T	28	32	60	88	59	M
2.0 16V (81 kW)	1990.01-	1993.03	MT/AT		F	Saloon Engine F20A2/F20A3	GC023013	Outer Joint		28	32	60	88	59	M
	1990.01-	1993.03	MT/AT		F	Saloon Engine F20A2/F20A3	GC023014	Outer Joint	50T	28	32	60	88	59	M
2.0 i 16V (98 kW)	1990.01-	1993.03	MT/AT		F	Saloon Engine F20A4/F20A8	GC023013	Outer Joint		28	32	60	88	59	M
	1990.01-	1993.03	MT/AT		F	Saloon Engine F20A4/F20A8	GC023014	Outer Joint	50T	28	32	60	88	59	M
	1993.03-	1993.12	MT/AT		F	Estate Engine F20Z3	GC023013	Outer Joint		28	32	60	88	59	M
	1993.03-	1993.12	MT/AT		F	Estate Engine F20Z3	GC023014	Outer Joint	50T	28	32	60	88	59	M
	1993.03-	1993.12			F	Estate Engine F20Z3	GC023081	Outer Joint	50T	28	34	60	83.5	59	M
2.2 i 16V (108 kW)	1991.01-	1993.12	MT/AT		F	Estate Engine F22A8	GC023013	Outer Joint		28	32	60	88	59	M
	1991.01-	1993.12	MT/AT		F	Estate Engine F22A8	GC023014	Outer Joint	50T	28	32	60	88	59	M
2.2 i 16V (110 kW)	1990.01-	1993.03	MT/AT		F	Saloon Engine F22A3	GC023013	Outer Joint		28	32	60	88	59	M
	1990.01-	1993.03	MT/AT		F	Saloon Engine F22A3	GC023014	Outer Joint	50T	28	32	60	88	59	M
	1991.01-	1993.12	MT/AT		F	Estate Engine F22A7	GC023013	Outer Joint		28	32	60	88	59	M
	1991.01-	1993.12	MT/AT		F	Estate Engine F22A7	GC023014	Outer Joint	50T	28	32	60	88	59	M
2.2 i 16V Automatik (108 kW)	1990.01-	1993.03	AT		F	Saloon Engine F22A3	GC023013	Outer Joint		28	32	60	88	59	M
	1990.01-	1993.03	AT		F	Saloon Engine F22A3	GC023014	Outer Joint	50T	28	32	60	88	59	M
<b>ACCORD IV (CB,CB3,CB7,CB8,CC,CC1,SM4)</b>															
2.5 (CC2)	1992.01-	1995.02	AT			Engine G25A	GC023028	Outer Joint		28	34	60	89	60	M
<b>ACCORD IV (CC1)</b>															
2.0 i 16V (98 kW)	1992.01-	1993.09	MT/AT		F	Coupe Engine F20A7	GC023013	Outer Joint		28	32	60	88	59	M
	1992.01-	1993.09	MT/AT		F	Coupe Engine F20A7	GC023014	Outer Joint	50T	28	32	60	88	59	M
<b>ACCORD V (CC7, CD)</b>															
2.0 i (85 kW)	1993.03-	1996.01	MT/AT		F	Saloon Engine F20Z2	GC023013	Outer Joint		28	32	60	88	59	M



		TRANSM	L/R	F/R		G-AP Ref.	PRODUCT	ABS	Technical Specifications									
									YEAR	A	B	C	H	L	P			
<b>HONDA</b>																		
<b>ACCORD V (CC7, CD)</b>																		
2.0 i (85 kW)	1993.03-	1996.01	MT/AT		F	Saloon Engine F20Z2	GC023014	Outer Joint	50T	28	32	60	88	59	M			
2.0 i S (96 kW)	1993.03-	1996.01	MT/AT		F	Saloon Engine F20Z1	GC023013	Outer Joint		28	32	60	88	59	M			
	1993.03-	1996.01	MT/AT		F	Saloon Engine F20Z1	GC023014	Outer Joint	50T	28	32	60	88	59	M			
<b>ACCORD V (CD7, CD9)</b>																		
2.2 i ES (110 kW)	1993.09-	1998.02	MT/AT		F	Coupe Engine F22B5	GC023013	Outer Joint		28	32	60	88	59	M			
	1993.09-	1998.02	MT/AT		F	Coupe Engine F22B5	GC023014	Outer Joint	50T	28	32	60	88	59	M			
<b>ACCORD V (CE)</b>																		
2.0 i LS 16V (100 kW)	1993.09-	1998.02	MT/AT		F	Estate Engine F20B3	GC023013	Outer Joint		28	32	60	88	59	M			
	1993.09-	1998.02	MT/AT		F	Estate Engine F20B3	GC023014	Outer Joint	50T	28	32	60	88	59	M			
2.2 i ES (110 kW)	1993.09-	1998.02	MT/AT		F	Estate Engine F22B5	GC023013	Outer Joint		28	32	60	88	59	M			
	1993.09-	1998.02	MT/AT		F	Estate Engine F22B5	GC023014	Outer Joint	50T	28	32	60	88	59	M			
<b>ACCORD VI (CE, CF)</b>																		
1.9 i (85 kW)	1996.02-	1998.10	MT/AT		F	Saloon Engine F18A3	GC051001	Outer Joint	50T	28	32	60	89	61	I			
2.0 i LS (96 kW)	1996.02-	1998.10	MT/AT		F	Saloon Engine F20Z1	GC051001	Outer Joint	50T	28	32	60	89	61	I			
2.0 TDi (77 kW)	1996.04-	1998.10	MT/AT		F	Saloon Engine 20T2N	GC051001	Outer Joint	50T	28	32	60	89	61	I			
2.2 i VTEC (110 kW)	1996.02-	1998.10	MT/AT		F	Saloon Engine F22Z2	GC051001	Outer Joint	50T	28	32	60	89	61	I			
<b>ACCORD VII (CG)</b>																		
1.6 i (85 kW)	1998.10-	2002.12					GC023036	Outer Joint	50T	28	32	64	88.5	60.5	I			
1.8 i (100 kW)	1998.10-	2002.12					GC023036	Outer Joint	50T	28	32	64	88.5	60.5	I			
2.0 i (108 kW)	1998.10-	2001.01					GC023036	Outer Joint	50T	28	32	64	88.5	60.5	I			
2.0 i 16V (108 kW)	1998.02-	2003.06			F	Coupe Engine F20B5/F20B7	GC023118	Outer Joint	50T	28	32	64	88.5	62	M			
	1998.02-	2003.06			F	Coupe Engine F20B5/F20B7	GC023031	Outer Joint	50T	28	32	60	88	59	M			
2.0 TDi (77 kW)	1999.02-	2002.12					GC023036	Outer Joint	50T	28	32	64	88.5	60.5	I			
3.0 V6 24V (147 kW)	1998.02-	2003.06	4AT		F	Coupe Engine J30A1	GC023031	Outer Joint	50T	28	32	60	88	59	M			
<b>ACCORD VII (CG, CK)</b>																		
1.8 i (100 kW)	1998.10-	2002.12			F	Saloon Engine F18B2	GC023036	Outer Joint	50T	28	32	64	88.5	60.5	I			
2.2 Type-R (156 kW)	1999.02-	2002.12			F	Saloon Engine H22A7	GC023118	Outer Joint	50T	28	32	64	88.5	62	M			
2.3 (113 kW)	2001.01-	2003.06			F	Saloon Engine F23A1/F23Z5	GC023118	Outer Joint	50T	28	32	64	88.5	62	M			
<b>ACCORD VII (CH)</b>																		
1.8 i (100 kW)	1999.12-	2002.12			F	Hatchback Engine F18B2	GC023036	Outer Joint	50T	28	32	64	88.5	60.5	I			
2.0 (108 kW)	1999.12-	2002.12			F	Hatchback	GC023118	Outer Joint	50T	28	32	64	88.5	62	M			
2.3 (113 kW)	2000.11-	2002.12			F	Hatchback Engine F23Z5	GC023118	Outer Joint	50T	28	32	64	88.5	62	M			
<b>ACCORD VII (CL)</b>																		
2.0 (114 kW)	2003.02-		MT/AT		F	Saloon Engine K20A6	GC023034	Outer Joint		28	32	63	88.5	59.5	M			
	2003.02-		MT	R	F	Saloon Engine K20A6	GDS23250	Drive Shaft		28	27	63	88.5	550				
2.2 i-CTDi (103 kW)	2003.09-	2007.09			F	Saloon Engine N22A1	GC023146	Outer Joint		28	34	63	88.5	59.5	M			
	2003.09-	2007.09			L	Saloon Engine N22A1	GDS23026	Drive Shaft		28	29	63	88.5	620				
	2003.09-	2007.09			R	Saloon Engine N22A1	GDS23027	Drive Shaft		28	29	63	88.5	557				
2.4 (140 kW)	2003.02-		MT/AT		F	Saloon Engine K24A/K24A3	GC023034	Outer Joint		28	32	63	88.5	59.5	M			
	2003.02-		MT	L	F	Saloon Engine K24A/K24A3	GDS81047	Drive Shaft		28	27	63	88.5	655				
	2003.02-		MT	R	F	Saloon Engine K24A/K24A3	GDS22019	Drive Shaft		28	27	63	88.5	548				
	2003.02-				R	Saloon Engine K24A/K24A3	GCI23069	Inner Joint		23	25	35	60	94.5				
<b>ACCORD VII TOURER (CM)</b>																		
2.0 (114 kW)	2003.04-		MT	R	F	Estate Engine K20A6	GDS23250	Drive Shaft		28	27	63	88.5	550				
2.2 i-CTDi (103 kW)	2003.09-	2007.09			F	Estate Engine N22A1	GC023146	Outer Joint		28	34	63	88.5	59.5	M			
	2003.09-	2007.09			L	Estate Engine N22A1	GDS23026	Drive Shaft		28	29	63	88.5	620				
	2003.09-	2007.09			R	Estate Engine N22A1	GDS23027	Drive Shaft		28	29	63	88.5	557				
2.4 (140 kW)	2003.04-		MT	L	F	Estate Engine K24A	GDS81047	Drive Shaft		28	27	63	88.5	655				
	2003.04-		MT	R	F	Estate Engine K24A	GDS22019	Drive Shaft		28	27	63	88.5	548				
<b>ACCORD VIII</b>																		
2.0 i (115 kW)	2008.07-		AT		F	Estate Engine R20A3	GC023135	Outer Joint		30	30	68	89	59	M			
	2008.07-		MT		F	Estate Engine R20A3	GC023145	Outer Joint		30	34	68	88	59.5	M			
2.2 i-DTEC (110 kW)	2008.07-				F	Estate Engine N22B1	GC023145	Outer Joint		30	34	68	88	59.5	M			
2.2 i-DTEC (132 kW)	2008.07-				F	Estate Engine N22B2	GC023145	Outer Joint		30	34	68	88	59.5	M			
2.4 i (148 kW)	2008.07-		MT		F	Estate Engine K24Z3	GC023145	Outer Joint		30	34	68	88	59.5	M			
<b>ACCORD VIII (CU)</b>																		
2.0 i (115 kW)	2008.07-		AT		F	Saloon Engine R20A3	GC023135	Outer Joint		30	30	68	89	59	M			
	2008.07-		MT		F	Saloon Engine R20A3	GC023145	Outer Joint		30	34	68	88	59.5	M			
2.2 i-DTEC (110 kW)	2008.07-				F	Saloon Engine N22B1	GC023145	Outer Joint		30	34	68	88	59.5	M			
	2008.07-		AT	L	F	Saloon Engine N22B1	GDS23270	Drive Shaft		30	29	68	88	651				
2.2 i-DTEC (132 kW)	2008.07-				F	Saloon Engine N22B2	GC023145	Outer Joint		30	34	68	88	59.5	M			
2.4 i (148 kW)	2008.07-		MT		F	Saloon Engine K24Z3	GC023145	Outer Joint		30	34	68	88	59.5	M			

	 YEAR	TRANSM	L/R	F/R		G-AP Ref.	PRODUCT	ABS	Technical Specifications								
									A	B	C	H	L	P			
<b>HONDA</b>																	
<b>ACCORD WAGON (CH9)</b>																	
2.3	1998.12-	2002.11	4AT		Engine H23A	GC023029	Outer Joint	50T	28	32	64	89	60	M			
<b>ACCORD WAGON (CL2)</b>																	
2.3 4WD	1997.10-	2002.11	4AT		Engine H23A	GC023029	Outer Joint	50T	28	32	64	89	60	M			
<b>ACCORDL (SJ, SY, SM, SV, SZ)</b>																	
-	1978-	1980				GC024002	Outer Joint	29T	25	22	50	95	58	M			
1.6 L/EX (59 kW)	1979.01-	1981.08	MT/AT		Engine EG EL	GC024002	Outer Joint	29T	25	22	50	95	58	M			
1.8 (66 kW)	1978-	1979				GC024002	Outer Joint	29T	25	22	50	95	58	M			
<b>ASCOT (CB1)</b>																	
1.8	1989.09-	1992.04	MT		Engine F18A	GC023015	Outer Joint		28	32	60	89	60	M			
	1989.09-	1993.10	AT		Engine F18A	GC023015	Outer Joint		28	32	60	89	60	M			
<b>ASCOT (CB2)</b>																	
1.8 4WD	1989.09-	1991.07	MT&AT		Engine F18A	GC023015	Outer Joint		28	32	60	89	60	M			
<b>ASCOT (CB3)</b>																	
2.0	1989.09-	1992.04	MT		Engine F20A	GC023015	Outer Joint		28	32	60	89	60	M			
	1989.09-	1993.10	AT		Engine F20A	GC023015	Outer Joint		28	32	60	89	60	M			
<b>ASCOT (CB4)</b>																	
2.0 4WS	1989.09-	1991.07	MT		Engine F20A	GC023015	Outer Joint		28	32	60	89	60	M			
	1989.09-	1993.10	AT		Engine F20A	GC023015	Outer Joint		28	32	60	89	60	M			
<b>ASCOT (CE4)</b>																	
2.0	1993.10-	1997.09	MT/AT		Engine G20A	GC023015	Outer Joint		28	32	60	89	60	M			
<b>ASCOT (CE5)</b>																	
2.5	1993.10-	1997.09	AT		Engine G25A	GC023015	Outer Joint		28	32	60	89	60	M			
<b>AVANCIER</b>																	
2.3 4x4 (110 kW)	1999.09-	2003.09	AT	R	Estate Engine F23A	GCI23069	Inner Joint		23	25	35	60	94.5				
3.0 4x4 (158 kW)	1999.09-	2003.09	AT	R	Estate Engine J30A	GCI23069	Inner Joint		23	25	35	60	94.5				
<b>BALLADE</b>																	
1.5	1984.01-	1986.12	MT/AT		Engine EW	GC023041	Outer Joint		23	30	45	79	56	M			
<b>CITY</b>																	
-						GCI23018	Inner Joint		25	28	35	58	95.5				
				L		GC023051	Outer Joint		26	22	55	77.5	53	I			
				L		GDS23015	Drive Shaft		26	25	55	77.5	600				
				R		GC023061	Outer Joint		26	22	52	79	56	M			
				R		GDS23014	Drive Shaft		26	25	52	79	899				
1.2 16V (55 kW)	1986.11-		MT			GC023018	Outer Joint		23	27	45	79	56	M			
1.5				L		GDS23070	Drive Shaft		26	25	52	79	612.5				
				R		GDS23071	Drive Shaft		26	25	52	79	899				
<b>CIVIC</b>																	
-	1988-	1994				GCI23004	Inner Joint		25	30	35	62	97.5				
	1992-	1995		R		GDS23119	Drive Shaft		26	25	55	78.5	622				
	1992-	1995		L		GDS23120	Drive Shaft		26	25	55	78.5	904.5				
	2001-	2005				GC023053	Outer Joint		26	23	60	78	61	M			
	2001-	2005				GC023087	Outer Joint	50T	26	23	60	78	61	M			
	2001-	2005	AT	L		GDS23128	Drive Shaft	50T	26	25	60	78	903				
	2001-	2005	AT	L		GDS23087	Drive Shaft	50T	26	25	60	78	905				
	2001-	2005	AT	R		GDS23127	Drive Shaft	50T	26	25	60	78	606				
	2001.04-		AT	L		GDS23069	Drive Shaft		26	25	60	78	903				
	2001.04-		AT	R		GDS81035	Drive Shaft		26	25	60	78	606				
	2001.04-	2005	AT	R		GCI23008	Inner Joint		25	30	35	54.5	92				
1.3	1980-	1983				GC023041	Outer Joint		23	30	45	79	56	M			
1.3/1.5	1995-		MT/AT			GCI23020	Inner Joint		25	28	35	54.5	96.5				
	1995-		MT/AT			GCI23021	Inner Joint		25	28	35	61.5	97.5				
1.5	1980-	1983				GC023041	Outer Joint		23	30	45	79	56	M			
1.6	1995-	2000		R		GDS81025	Drive Shaft	50T	26	25	55	77.5	619.5				
	1995-	2000		L		GDS23051	Drive Shaft	50T	26	25	55	77.5	901.5				
1.6 16V	1997.01-	2000.12	MT/AT			GC023109	Outer Joint		26	32	55	78	58.5	I			
	1997.01-	2000.12	MT/AT			GC023108	Outer Joint	50T	26	32	55	78	58.5	I			
1.7				L		GDS23068	Drive Shaft		26	25	60	78	895.5				
				R		GDS23066	Drive Shaft		26	25	60	78	611				
	2000.01-	2002.12	MT/AT		Engine D17	GC023105	Outer Joint	50T	26	23	60	78.5	59.5	M			
1.8	2002-	2010	AT			GC023110	Outer Joint		26	22	58	78.5	56	M			
	2002-	2010	MT			GC023107	Outer Joint		26	24	58	79.5	60.5	M			
	2006-			L		GDS23022	Drive Shaft		26	25	58	78.5	623				









		TRANSM	L/R	F/R		G-AP Ref.	PRODUCT	ABS	Technical Specifications									
									YEAR	A	B	C	H	L	P			
<b>HONDA</b>																		
<b>CIVIC</b>																		
1.8	2006-			R		GDS23023	Drive Shaft		26	25	58	78.5	912					
2.0	2006-			L		GCI23017	Inner Joint		27	30	40	58.5	97					
	2006-			L		GDS23025	Drive Shaft		26	27	63	79	620					
	2006-			R		GCI23023	Inner Joint		27	30	40	45.5	75					
	2006-			R		GDS23024	Drive Shaft		26	27	63	79	585					
<b>CIVIC (AN, AR)</b>																		
1.5 (63 kW)	1983.10-	1987.10	MT/AT		F Estate Engine EW2	GC023006	Outer Joint		23	30	49	79.5	56	M				
1.5 4WD (63 kW)	1985.01-	1987.10	MT/AT		F Estate Engine EW2	GC023021	Outer Joint		26	32	49	78.5	56.5	M				
<b>CIVIC (EG1)</b>																		
1.5	1992.02-	1995.09	MT/AT		Engine D15B	GC023019	Outer Joint		26	30	55	78.5	56	M				
<b>CIVIC (EG3)</b>																		
1.3	1991.09-	1995.09	MT/AT		Engine D13B	GC023019	Outer Joint		26	30	55	78.5	56	M				
<b>CIVIC (EG4)</b>																		
1.5	1991.09-	1995.09	MT/AT		Engine D15B	GC023019	Outer Joint		26	30	55	78.5	56	M				
<b>CIVIC (EG7)</b>																		
1.3	1991.09-	1995.09	MT/AT		Engine D13B	GC023019	Outer Joint		26	30	55	78.5	56	M				
<b>CIVIC (EG8)</b>																		
1.5	1991.09-	1995.09	MT/AT		Engine D15B	GC023019	Outer Joint		26	30	55	78.5	56	M				
<b>CIVIC (EG9)</b>																		
1.6	1992.01-	1995.09	MT/AT		Engine B16A	GC023019	Outer Joint		26	30	55	78.5	56	M				
<b>CIVIC (EJ1)</b>																		
1.6	1993.02-	1996.01	MT/AT		Engine ZC	GC023019	Outer Joint		26	30	55	78.5	56	M				
<b>CIVIC (EJ3)</b>																		
1.6	1993.09-	1995.09	AT		Engine ZC	GC023019	Outer Joint		26	30	55	78.5	56	M				
<b>CIVIC (EJ4)</b>																		
1.6	1995.09-	1997.08	MT/AT		Engine D16A	GC023038	Outer Joint		26	28	55	78	55	M				
<b>CIVIC (EK2)</b>																		
1.3	1995.09-	1996.09	MT/AT		Engine D13B	GC023038	Outer Joint		26	28	55	78	55	M				
<b>CIVIC (EK3)</b>																		
1.5	1995.09-	1996.09	MT/HMM		Engine D15B	GC023038	Outer Joint		26	28	55	78	55	M				
<b>CIVIC (EK4)</b>																		
1.6	1995.09-	2000.09	MT/AT		Engine B16A	GC023019	Outer Joint		26	30	55	78.5	56	M				
<b>CIVIC (FD1)</b>																		
1.8	2005.09-		5AT		Engine R18A	GC023155	Outer Joint		26	28	58	78	51.5	M				
	2005.09-		5AT/F		Engine R18A	GC023155	Outer Joint		26	28	58	78	51.5	M				
	2005.09-		5MT		Engine R18A	GC023155	Outer Joint		26	28	58	78	51.5	M				
	2005.09-		5MT/F		Engine R18A	GC023155	Outer Joint		26	28	58	78	51.5	M				
<b>CIVIC (FD2)</b>																		
2.0	2007.03-		6MT		Engine K20A	GC023153	Outer Joint		30	32	68	88.5	59.5	M				
<b>CIVIC (SB)</b>																		
1.2 (40 kW)	1972.07-	1977.02			F Hatchback Engine EB1	GC023003	Outer Joint		23	22	45	78	55	M				
<b>CIVIC (SF)</b>																		
1.3 (33 kW)	1980.09-	1983.09	MT/AT		F Saloon Engine EN2	GC023003	Outer Joint		23	22	45	78	55	M				
1.3 (44 kW)	1980.09-	1983.09	MT/AT		F Saloon Engine EN1	GC023003	Outer Joint		23	22	45	78	55	M				
1.3 S (52 kW)	1979.10-	1984.12	MT/AT		F Saloon Engine EN4	GC023003	Outer Joint		23	22	45	78	55	M				
<b>CIVIC CRX</b>																		
-	1988-	1991				GCI23010	Inner Joint		25	27	35	54.5	90					
	1988-	1991		L		GDS23045	Drive Shaft		23	25	49	79.5	905					
<b>CIVIC CVCC</b>																		
-	1983-					GC023041	Outer Joint		23	30	45	79	56	M				
<b>CIVIC DEL SOL</b>																		
1.5	1993-			L		GDS23120	Drive Shaft		26	25	55	78.5	904.5					
	1993-			R		GDS23119	Drive Shaft		26	25	55	78.5	622					
	1994-	1996		L		GDS23120	Drive Shaft		26	25	55	78.5	904.5					
	1994-	1996		R		GDS23119	Drive Shaft		26	25	55	78.5	622					
1.6	1993-			L		GDS23120	Drive Shaft		26	25	55	78.5	904.5					
	1994-	1996		L		GDS23120	Drive Shaft		26	25	55	78.5	904.5					
<b>CIVIC FERIO (EG7)</b>																		
1.3	1991.01-	1995.09	MT/AT		Engine D13B	GC023019	Outer Joint		26	30	55	78.5	56	M				
<b>CIVIC FERIO (EG8)</b>																		
1.3	1993.09-	1995.09	MT/AT		Engine D15B	GC023019	Outer Joint		26	30	55	78.5	56	M				

		YEAR	TRANSM	L/R	F/R		G-AP Ref.	PRODUCT	ABS	Technical Specifications										
										A	B	C	H	L	P					
<b>HONDA</b>																				
<b>CIVIC FERIO (EG8)</b>																				
1.5	1991.01-	1995.09	MT/AT			Engine D15B	GC023019	Outer Joint			26	30	55	78.5	56	M				
<b>CIVIC FERIO (EJ3)</b>																				
1.6	1993.09-	1995.09	MT/AT			Engine ZC	GC023019	Outer Joint			26	30	55	78.5	56	M				
<b>CIVIC FERIO (EK2)</b>																				
1.3	1995.09-	2000.09	MT/AT			Engine D13B	GC023038	Outer Joint			26	28	55	78	55	M				
<b>CIVIC FERIO (EK3)</b>																				
1.5	1995.09-	2000.09	MT/HMM			Engine D15B	GC023038	Outer Joint			26	28	55	78	55	M				
<b>CIVIC FERIO (EK4)</b>																				
1.6	1995.09-	2000.09	MT/AT			Engine B16A	GC023019	Outer Joint			26	30	55	78.5	56	M				
<b>CIVIC I</b>																				
1.2 (40 kW)	1972-	1980	MT/AT				GC024002	Outer Joint	29T		25	22	50	95	58	M				
1.2 (44 kW)	1978-	1980	MT/AT				GC024002	Outer Joint	29T		25	22	50	95	58	M				
1.3 L (33 kW)	1980-	1983					GC024002	Outer Joint	29T		25	22	50	95	58	M				
1.3 L SW (44 kW)	1980-	1983					GC024002	Outer Joint	29T		25	22	50	95	58	M				
1.3 S (52 kW)	1979-	1984	MT/AT				GC024002	Outer Joint	29T		25	22	50	95	58	M				
1.5 (66 kW)	1975-	1983					GC024002	Outer Joint	29T		25	22	50	95	58	M				
<b>CIVIC II</b>																				
1.4 i	1988-	1995		L/R	F		GCI23004	Inner Joint			25	30	35	62	97.5					
<b>CIVIC II (EE)</b>																				
1.4 i 16V (66 kW)	1988.01-	1992.12			F	Estate Engine D14A1	GC023012	Outer Joint	100T		26	30	49	78.5	55.5	M				
	1988.01-	1992.12		L	F	Estate Engine D14A1	GDS81013	Drive Shaft			26	25	49	79	903					
	1988.01-	1992.12		R	F	Estate Engine D14A1	GDS23030	Drive Shaft			26	25	49	79	599					
1.5 i 16V (69 kW)	1988.01-	1991.11			F	Estate Engine D15B2	GC023012	Outer Joint	100T		26	30	49	78.5	55.5	M				
	1988.01-	1991.11		L	F	Estate Engine D15B2	GDS81013	Drive Shaft			26	25	49	79	903					
	1988.01-	1991.11		R	F	Estate Engine D15B2	GDS23030	Drive Shaft			26	25	49	79	599					
1.6 i 16V 4WD (80 kW)	1988.01-	1989.12	MT/AT		F	Estate Engine D16A6	GC023021	Outer Joint			26	32	49	78.5	56.5	M				
1.6 i 16V 4WD (81 kW)	1988.01-	1995.02	MT/AT		F	Estate Engine D16A6	GC023021	Outer Joint			26	32	49	78.5	56.5	M				
<b>CIVIC II (SS, SL)</b>																				
1.3 (44 kW)	1979.09-	1983.09	MT/AT		F	Hatchback Engine EN1	GC023003	Outer Joint			23	22	45	78	55	M				
<b>CIVIC II (WC)</b>																				
1.3 (44 kW)	1979.09-	1983.09	MT/AT		F	Estate Engine EN1	GC023003	Outer Joint			23	22	45	78	55	M				
<b>CIVIC III (AL, AJ, AG, AH)</b>																				
1.2 (40 kW)	1984.01-	1987.10	MT		F	Hatchback Engine D12B1/ZA2	GC023042	Outer Joint			23	27	49	79.5	56	M				
	1984.01-	1987.10	MT/AT		F	Hatchback Engine D12B1/ZA2	GC023006	Outer Joint			23	30	49	79.5	56	M				
1.3 (52 kW)	1983.10-	1987.10	MT		F	Hatchback Engine EV2	GC023042	Outer Joint			23	27	49	79.5	56	M				
	1983.10-	1987.10	MT/AT		F	Hatchback Engine EV2	GC023006	Outer Joint			23	30	49	79.5	56	M				
1.5 GL (63 kW)	1983.10-	1987.10	MT		F	Hatchback Engine EW2	GC023042	Outer Joint			23	27	49	79.5	56	M				
	1983.10-	1987.10	MT/AT		F	Hatchback Engine EW2	GC023006	Outer Joint			23	30	49	79.5	56	M				
1.5 GT (74 kW)	1985.01-	1987.10	MT/AT		F	Hatchback Engine EW3	GC023006	Outer Joint			23	30	49	79.5	56	M				
1.5 GTi (66 kW)	1986.03-	1987.10	MT/AT		F	Hatchback Engine EW4	GC023006	Outer Joint			23	30	49	79.5	56	M				
<b>CIVIC III (AM, AK, AU)</b>																				
1.2 (40 kW)	1985.01-	1987.10	MT/AT		F	Saloon Engine D12B1/ZA2	GC023006	Outer Joint			23	30	49	79.5	56	M				
1.3 (52 kW)	1983.10-	1987.10	MT		F	Saloon Engine EV2	GC023042	Outer Joint			23	27	49	79.5	56	M				
	1983.10-	1987.10	MT/AT		F	Saloon Engine EV2	GC023006	Outer Joint			23	30	49	79.5	56	M				
1.5 GL (63 kW)	1983.10-	1987.10	MT		F	Saloon Engine EW2	GC023042	Outer Joint			23	27	49	79.5	56	M				
	1983.10-	1987.10	MT/AT		F	Saloon Engine EW2	GC023006	Outer Joint			23	30	49	79.5	56	M				
1.5 GT (74 kW)	1985.01-	1987.10	MT/AT		F	Saloon Engine EW3	GC023006	Outer Joint			23	30	49	79.5	56	M				
1.5 GTi (66 kW)	1986.03-	1987.10	MT/AT		F	Saloon Engine EW4	GC023006	Outer Joint			23	30	49	79.5	56	M				
<b>CIVIC III (EC, ED, EE)</b>																				
1.3 (55 kW)	1987.10-	1989.12	MT/AT		F	Hatchback Engine D13B1	GC023011	Outer Joint			26	30	49	79	53	M				
	1987.10-	1989.12			F	Hatchback Engine D13B1	GC023012	Outer Joint	100T		26	30	49	78.5	55.5	M				
	1987.10-	1989.12		L	F	Hatchback Engine D13B1	GDS81013	Drive Shaft			26	25	49	79	903					
	1987.10-	1989.12		R	F	Hatchback Engine D13B1	GDS23030	Drive Shaft			26	25	49	79	599					
1.3 16V CAT (55 kW)	1989.09-	1991.09	MT/AT		F	Hatchback Engine D13B2	GC023011	Outer Joint			26	30	49	79	53	M				
	1989.09-	1991.09			F	Hatchback Engine D13B2	GC023086	Outer Joint	50T		26	30	55	78.5	56.5	M				
	1989.09-	1991.09			F	Hatchback Engine D13B2	GC023012	Outer Joint	100T		26	30	49	78.5	55.5	M				
	1989.09-	1991.09		L	F	Hatchback Engine D13B2	GDS81013	Drive Shaft			26	25	49	79	903					
	1989.09-	1991.09		R	F	Hatchback Engine D13B2	GDS23030	Drive Shaft			26	25	49	79	599					
1.4 (66 kW)	1987.10-	1989.12	MT/AT		F	Hatchback Engine D14A1	GC023011	Outer Joint			26	30	49	79	53	M				
	1987.10-	1989.12			F	Hatchback Engine D14A1	GC023012	Outer Joint	100T		26	30	49	78.5	55.5	M				
	1987.10-	1989.12		L	F	Hatchback Engine D14A1	GDS81013	Drive Shaft			26	25	49	79	903					
	1987.10-	1989.12		R	F	Hatchback Engine D14A1	GDS23030	Drive Shaft			26	25	49	79	599					



		TRANSM	L/R	F/R		G-AP Ref.	PRODUCT	ABS	Technical Specifications						
									YEAR	A	B	C	H	L	P
<b>HONDA</b>															
<b>CIVIC III (EC, ED, EE)</b>															
1.5 (60 kW)	1988.01-	1989.12		L	F	Hatchback Engine D15B1	GDS81013	Drive Shaft		26	25	49	79	903	
	1988.01-	1989.12		R	F	Hatchback Engine D15B1	GDS23030	Drive Shaft		26	25	49	79	599	
1.5 i 16V (66 kW)	1988.10-	1991.09			R	Hatchback Engine D15B2	GC023020	Outer Joint		26	23	49	78.5	54.5	M
	1988.10-	1991.09	MT/AT		F	Hatchback Engine D15B2	GC023011	Outer Joint		26	30	49	79	53	M
	1988.10-	1991.09			F	Hatchback Engine D15B2	GC023012	Outer Joint	100T	26	30	49	78.5	55.5	M
	1988.10-	1991.09		L	F	Hatchback Engine D15B2	GDS81013	Drive Shaft		26	25	49	79	903	
	1988.10-	1991.09		R	F	Hatchback Engine D15B2	GDS23030	Drive Shaft		26	25	49	79	599	
	1988.10-	1991.09			F	Hatchback Engine D15B2	GC023020	Outer Joint		26	23	49	78.5	54.5	M
1.5 i 16V (69 kW)	1988.10-	1991.09			F	Hatchback Engine D15B2	GC023020	Outer Joint		26	23	49	78.5	54.5	M
	1988.10-	1991.09	MT/AT		F	Hatchback Engine D15B2	GC023011	Outer Joint		26	30	49	79	53	M
	1988.10-	1991.09			F	Hatchback Engine D15B2	GC023012	Outer Joint	100T	26	30	49	78.5	55.5	M
	1988.10-	1991.09		L	F	Hatchback Engine D15B2	GDS81013	Drive Shaft		26	25	49	79	903	
	1988.10-	1991.09		R	F	Hatchback Engine D15B2	GDS23030	Drive Shaft		26	25	49	79	599	
	1988.10-	1991.09			F	Hatchback Engine D15B2	GC023020	Outer Joint		26	23	49	78.5	54.5	M
1.6 i 16V (80 kW)	1987.10-	1991.09	MT/AT		F	Hatchback Engine D16A6	GC023011	Outer Joint		26	30	49	79	53	M
	1987.10-	1991.09			F	Hatchback Engine D16A6	GC023012	Outer Joint	100T	26	30	49	78.5	55.5	M
	1987.10-	1991.09		L	F	Hatchback Engine D16A6	GDS81013	Drive Shaft		26	25	49	79	903	
	1987.10-	1991.09		R	F	Hatchback Engine D16A6	GDS23030	Drive Shaft		26	25	49	79	599	
	1987.10-	1991.09			F	Hatchback Engine D16A6	GC023011	Outer Joint		26	30	49	79	53	M
	1987.10-	1991.09			F	Hatchback Engine D16A6	GC023012	Outer Joint	100T	26	30	49	78.5	55.5	M
1.6 i 16V (81 kW)	1987.10-	1991.09	MT/AT		F	Hatchback Engine D16Z2	GC023011	Outer Joint		26	30	49	79	53	M
	1987.10-	1991.09			F	Hatchback Engine D16Z2	GC023012	Outer Joint	100T	26	30	49	78.5	55.5	M
	1987.10-	1991.09		L	F	Hatchback Engine D16Z2	GDS81013	Drive Shaft		26	25	49	79	903	
	1987.10-	1991.09		R	F	Hatchback Engine D16Z2	GDS23030	Drive Shaft		26	25	49	79	599	
1.6 i 16V (96 kW)	1987.09-	1991.09	MT/AT		F	Hatchback Engine D16A7/D16A9	GC023021	Outer Joint		26	32	49	78.5	56.5	M
	1987.09-	1991.09			F	Hatchback Engine D16A7/D16A9	GC023012	Outer Joint	100T	26	30	49	78.5	55.5	M
1.6 i 16V VTEC (110 kW)	1989.10-	1991.09	MT/AT		F	Hatchback Engine B16A1	GC023021	Outer Joint		26	32	49	78.5	56.5	M
<b>CIVIC III (ED)</b>															
1.3 (55 kW)	1987.10-	1989.12		L	F	Saloon Engine D13B1	GDS81013	Drive Shaft		26	25	49	79	903	
	1987.10-	1989.12		R	F	Saloon Engine D13B1	GDS23030	Drive Shaft		26	25	49	79	599	
1.4 (66 kW)	1987.10-	1989.12	MT/AT		F	Saloon Engine D14A1	GC023011	Outer Joint		26	30	49	79	53	M
	1987.10-	1989.12			F	Saloon Engine D14A1	GC023012	Outer Joint	100T	26	30	49	78.5	55.5	M
	1987.10-	1989.12		L	F	Saloon Engine D14A1	GDS81013	Drive Shaft		26	25	49	79	903	
	1987.10-	1989.12		R	F	Saloon Engine D14A1	GDS23030	Drive Shaft		26	25	49	79	599	
1.5 (60 kW)	1988.01-	1989.12		L	F	Saloon Engine D15B1	GDS81013	Drive Shaft		26	25	49	79	903	
	1988.01-	1989.12		R	F	Saloon Engine D15B1	GDS23030	Drive Shaft		26	25	49	79	599	
1.5 i 16V (66 kW)	1987.10-	1991.09			R	Saloon Engine D15B2	GC023020	Outer Joint		26	23	49	78.5	54.5	M
	1987.10-	1991.09			F	Saloon Engine D15B2	GC023012	Outer Joint	100T	26	30	49	78.5	55.5	M
	1987.10-	1991.09		L	F	Saloon Engine D15B2	GDS81013	Drive Shaft		26	25	49	79	903	
	1987.10-	1991.09		R	F	Saloon Engine D15B2	GDS23030	Drive Shaft		26	25	49	79	599	
1.5 i 16V (69 kW)	1987.10-	1991.09			R	Saloon Engine D15B2	GC023020	Outer Joint		26	23	49	78.5	54.5	M
	1987.10-	1991.09	MT/AT		F	Saloon Engine D15B2	GC023011	Outer Joint		26	30	49	79	53	M
	1987.10-	1991.09		L	F	Saloon Engine D15B2	GDS81013	Drive Shaft		26	25	49	79	903	
	1987.10-	1991.09		R	F	Saloon Engine D15B2	GDS23030	Drive Shaft		26	25	49	79	599	
1.6 i 16V (80 kW)	1987.11-	1991.09	MT/AT		F	Saloon Engine D16A6	GC023021	Outer Joint		26	32	49	78.5	56.5	M
	1987.11-	1991.09			F	Saloon Engine D16A6	GC023012	Outer Joint	100T	26	30	49	78.5	55.5	M
	1987.11-	1991.09		L	F	Saloon Engine D16A6	GDS81013	Drive Shaft		26	25	49	79	903	
	1987.11-	1991.09		R	F	Saloon Engine D16A6	GDS23030	Drive Shaft		26	25	49	79	599	
1.6 i 16V (81 kW)	1987.10-	1991.09	MT/AT		F	Saloon Engine D16Z2	GC023021	Outer Joint		26	32	49	78.5	56.5	M
	1987.10-	1991.09			F	Saloon Engine D16Z2	GC023012	Outer Joint	100T	26	30	49	78.5	55.5	M
	1987.10-	1991.09		L	F	Saloon Engine D16Z2	GDS81013	Drive Shaft		26	25	49	79	903	
	1987.10-	1991.09		R	F	Saloon Engine D16Z2	GDS23030	Drive Shaft		26	25	49	79	599	
1.6 i 16V (96 kW)	1987.09-	1991.09	MT/AT		F	Saloon Engine D16A7	GC023021	Outer Joint		26	32	49	78.5	56.5	M
	1987.09-	1991.09			F	Saloon Engine D16A7	GC023012	Outer Joint	100T	26	30	49	78.5	55.5	M
	1987.09-	1991.09		L	F	Saloon Engine D16A7	GDS81013	Drive Shaft		26	25	49	79	903	
	1987.09-	1991.09		R	F	Saloon Engine D16A7	GDS23030	Drive Shaft		26	25	49	79	599	
1.6 i 16V 4x4 (80 kW)	1989.10-	1991.09	MT/AT		F	Saloon Engine D16A6	GC023021	Outer Joint		26	32	49	78.5	56.5	M
	1989.10-	1991.09	MT/AT		F	Saloon Engine D16A6	GC023020	Outer Joint		26	23	49	78.5	54.5	M
	1989.10-	1991.09		L	F	Saloon Engine D16A6	GDS81013	Drive Shaft		26	25	49	79	903	
	1989.10-	1991.09		R	F	Saloon Engine D16A6	GDS23030	Drive Shaft		26	25	49	79	599	
<b>CIVIC IV</b>															
1.4	1991.11-	1996.03	MT/AT	R	F		GDS23135	Drive Shaft		26	25	55	78.5	627	
1.5	1991.11-	1996.03	MT/AT	R	F		GDS23135	Drive Shaft		26	25	55	78.5	627	
1.6 SOHC	1991.11-	1996.03	MT/AT	R	F		GDS23135	Drive Shaft		26	25	55	78.5	627	





		TRANSM	L/R	F/R		G-AP Ref.	PRODUCT	ABS	Technical Specifications					
									YEAR	A	B	C	H	L
<b>HONDA</b>														
<b>CIVIC IV (EG)</b>														
1.3 16V (55 kW)	1991.10-	1995.11			F Hatchback Engine D13B2	GC023023	Outer Joint		26	30	55	78.5	56.5	M
	1991.10-	1995.11			F Hatchback Engine D13B2	GC023097	Outer Joint	50T	26	30	55	77.5	53	I
	1991.10-	1995.11			F Hatchback Engine D13B2	GC023086	Outer Joint	50T	26	30	55	78.5	56.5	M
	1991.10-	1995.11	MT/AT		F Hatchback Engine D13B2	GC023022	Outer Joint		26	30	55	79	56	M
	1991.10-	1995.11	MT/AT		F Hatchback Engine D13B2	GC023083	Outer Joint	50T	26	30	55	78.5	56	M
1.5 i 16V (66 kW)	1991.10-	1995.11			F Hatchback Engine D15B2/D15Z2	GC023093	Outer Joint		26	30	55	78	56	I
	1991.10-	1995.11			F Hatchback Engine D15B2/D15Z2	GC023023	Outer Joint		26	30	55	78.5	56.5	M
	1991.10-	1995.11			F Hatchback Engine D15B2/D15Z2	GC023097	Outer Joint	50T	26	30	55	77.5	53	I
	1991.10-	1995.11			F Hatchback Engine D15B2/D15Z2	GC023086	Outer Joint	50T	26	30	55	78.5	56.5	M
	1991.10-	1995.11	MT/AT		F Hatchback Engine D15B2/D15Z2	GC023022	Outer Joint		26	30	55	79	56	M
1.5 i 16V (69 kW)	1991.10-	1995.11			F Hatchback Engine D15B2/D15Z1	GC023023	Outer Joint		26	30	55	78.5	56.5	M
	1991.10-	1995.11			F Hatchback Engine D15B2/D15Z1	GC023086	Outer Joint	50T	26	30	55	78.5	56.5	M
	1991.10-	1995.11	MT/AT		F Hatchback Engine D15B2/D15Z1	GC023022	Outer Joint		26	30	55	79	56	M
	1991.10-	1995.11	MT/AT		F Hatchback Engine D15B2/D15Z1	GC023083	Outer Joint	50T	26	30	55	78.5	56	M
	1991.10-	1995.11			F Hatchback Engine D16Z6	GC023097	Outer Joint	50T	26	30	55	77.5	53	I
1.6 16V VTEC (92 kW)	1991.10-	1995.11			F Hatchback Engine D16Z6	GC023086	Outer Joint	50T	26	30	55	78.5	56.5	M
	1991.10-	1995.11			F Hatchback Engine D16Z6	GC051021	Outer Joint	50T	26	32	55	78.5	56.5	I
	1991.10-	1995.11	MT/AT		F Hatchback Engine D16Z6	GC023022	Outer Joint		26	30	55	79	56	M
	1991.10-	1995.11	MT/AT		F Hatchback Engine D16Z6	GC023083	Outer Joint	50T	26	30	55	78.5	56	M
1.6 VTi 16V (118 kW)	1991.10-	1995.11	MT/AT		F Hatchback Engine B16A2	GC023016	Outer Joint		26	32	55	78.5	56.5	M
<b>CIVIC IV (EG, EH)</b>														
1.5 i 16V (66 kW)	1991.10-	1995.11			K600 LS1	GC023093	Outer Joint		26	30	55	78	56	I
1.5 i 16V (69 kW)	1991.10-	1995.11			F Saloon Engine D15B2/D15Z1	GC023023	Outer Joint		26	30	55	78.5	56.5	M
	1991.10-	1995.11			F Saloon Engine D15B2/D15Z1	GC023086	Outer Joint	50T	26	30	55	78.5	56.5	M
	1991.10-	1995.11	MT/AT		F Saloon Engine D15B2/D15Z1	GC023022	Outer Joint		26	30	55	79	56	M
	1991.10-	1995.11	MT/AT		F Saloon Engine D15B2/D15Z1	GC023083	Outer Joint	50T	26	30	55	78.5	56	M
1.6 16V VTEC (92 kW)	1991.10-	1995.11			F Saloon Engine D16Z6/D16Z7	GC023097	Outer Joint	50T	26	30	55	77.5	53	I
	1991.10-	1995.11			F Saloon Engine D16Z6/D16Z7	GC023086	Outer Joint	50T	26	30	55	78.5	56.5	M
	1991.10-	1995.11	MT/AT		F Saloon Engine D16Z6/D16Z7	GC023022	Outer Joint		26	30	55	79	56	M
	1991.10-	1995.11	MT/AT		F Saloon Engine D16Z6/D16Z7	GC023083	Outer Joint	50T	26	30	55	78.5	56	M
1.6 VTi (118 kW)	1991.10-	1995.11	MT/AT		F Saloon Engine B16A2	GC023016	Outer Joint		26	32	55	78.5	56.5	M
<b>CIVIC IV (MA, MB)</b>														
1.4 i (55 kW)	1995.09-	2001.02		R	F Hatchback Engine D14A5/D14A7/D14Z3	GDS81010	Drive Shaft	50T	26	25	55	78.5	627	
	1995.09-	2001.02		R	F Hatchback Engine D14A5/D14A7/D14Z3	GCI23005	Inner Joint		25	30	35	54.5	97	
	1995.09-	2001.02		R	F Hatchback Engine D14A5/D14A7/D14Z3	GC023017	Outer Joint	50T	26	32	55	78.5	56.5	M
1.4 i (66 kW)	1994.09-	2001.02			Hatchback Engine D14A2	GC023179	Outer Joint	50T	26	32	55	78.5	56.5	I
	1994.09-	2001.02		F	Hatchback Engine D14A2	GC051021	Outer Joint	50T	26	32	55	78.5	56.5	I
1.5 16V (84 kW)	1997.01-	2001.02	MT/AT	L	F Hatchback Engine D15Z8	GDS23020	Drive Shaft	50T	26	25	49	78.8	909	
	1997.01-	2001.02	MT/AT	R	F Hatchback Engine D15Z8	GDS81010	Drive Shaft	50T	26	25	55	78.5	627	
	1997.01-	2001.02		R	F Hatchback Engine D15Z8	GCI23005	Inner Joint		25	30	35	54.5	97	
	1997.01-	2001.02		R	F Hatchback Engine D15Z8	GC023017	Outer Joint	50T	26	32	55	78.5	56.5	M
	1997.01-	2001.02			Hatchback Engine D15Z8	GC023073	Outer Joint	50T	26	28	55	78.5	56.5	M
	1997.01-	2001.02	MT/AT		F Hatchback Engine D15Z8	GC023047	Outer Joint		26	28	55	77.5	53	M
1.6 16V (85 kW)	1997.01-	2001.02	MT/AT		F Hatchback Engine D16B2	GC023047	Outer Joint		26	28	55	77.5	53	M
	1997.01-	2001.02		F	Hatchback Engine D16B2	GC051021	Outer Joint	50T	26	32	55	78.5	56.5	I
1.6 i (83 kW)	1994.09-	1997.01		F	Hatchback Engine D16Y3	GC051021	Outer Joint	50T	26	32	55	78.5	56.5	I
1.6 i VTEC (93 kW)	1994.09-	1997.01		F	Hatchback Engine D16Y2	GC051021	Outer Joint	50T	26	32	55	78.5	56.5	I
1.6 VTi (118 kW)	1997.01-	2001.02		F	Hatchback Engine B16A2	GC023086	Outer Joint	50T	26	30	55	78.5	56.5	M
<b>CIVIC NACIONAL</b>														
1.6	1997.01-	2000.12	MT/AT			GC023109	Outer Joint		26	32	55	78	58.5	I
	1997.01-	2000.12	MT/AT			GC023108	Outer Joint	50T	26	32	55	78	58.5	I
<b>CIVIC V</b>														
1.4	1995.03-	2000.12		R	F Hatchback Engine 5 DR	GDS23149	Drive Shaft	50T	26	25	55	78.5	627	
1.5	1995.03-	2000.12		R	F Hatchback Engine 5 DR	GDS23149	Drive Shaft	50T	26	25	55	78.5	627	
1.6	1995.03-	2000.12		R	F Hatchback Engine 5 DR	GDS23149	Drive Shaft	50T	26	25	55	78.5	627	
<b>CIVIC V (EJ, EK)</b>														
1.4 i (55 kW)	1995.11-	2001.02			Hatchback Engine D14A3/D14Z1	GC023073	Outer Joint	50T	26	28	55	78.5	56.5	M
	1995.11-	2001.02	MT/AT		F Hatchback Engine D14A3/D14Z1	GC023063	Outer Joint		26	32	55	78.5	56.5	I
	1995.11-	2001.02	MT/AT		F Hatchback Engine D14A3/D14Z1	GC099225	Outer Joint	50T	26	32	55	78.5	56.5	I
	1995.11-	2001.02	MT		F Hatchback Engine D14A3/D14Z1	GC023047	Outer Joint		26	28	55	77.5	53	M



		TRANSM	L/R	F/R		G-AP Ref.	PRODUCT	ABS	Technical Specifications						
									YEAR	A	B	C	H	L	P
<b>HONDA</b>															
<b>CIVIC V (EJ, EK)</b>															
1.4 i (55 kW)	1995.11-	2001.02	MT/AT		F	Hatchback Engine D14A3/D14Z1	GC023024	Outer Joint	50T	26	28	55	77.5	53	M
1.4 i (66 kW)	1995.11-	2001.02				Saloon Engine D14A4/D14Z2/D14Z4	GC023073	Outer Joint	50T	26	28	55	78.5	56.5	M
	1995.11-	2001.02	MT/AT		F	Saloon Engine D14A4/D14Z2/D14Z4	GC023063	Outer Joint		26	32	55	78.5	56.5	I
	1995.11-	2001.02	MT/AT		F	Saloon Engine D14A4/D14Z2/D14Z4	GC099225	Outer Joint	50T	26	32	55	78.5	56.5	I
	1995.11-	2001.02	MT/AT		F	Saloon Engine D14A4/D14Z2/D14Z4	GC023047	Outer Joint		26	28	55	77.5	53	M
	1995.11-	2001.02	MT/AT		F	Saloon Engine D14A4/D14Z2/D14Z4	GC023024	Outer Joint	50T	26	28	55	77.5	53	M
1.4 i S (66 kW)	1995.11-	2001.02				Hatchback Engine D14A4/D14Z2	GC023073	Outer Joint	50T	26	28	55	78.5	56.5	M
	1995.11-	2001.02	MT/AT		F	Hatchback Engine D14A4/D14Z2	GC023063	Outer Joint		26	32	55	78.5	56.5	I
	1995.11-	2001.02	MT/AT		F	Hatchback Engine D14A4/D14Z2	GC099225	Outer Joint	50T	26	32	55	78.5	56.5	I
	1995.11-	2001.02	MT		F	Hatchback Engine D14A4/D14Z2	GC023047	Outer Joint		26	28	55	77.5	53	M
	1995.11-	2001.02	MT/AT		F	Hatchback Engine D14A4/D14Z2	GC023024	Outer Joint	50T	26	28	55	77.5	53	M
1.4 LPG (66 kW)	1997.01-	2001.02				Hatchback Engine D14Z4	GC023073	Outer Joint	50T	26	28	55	78.5	56.5	M
1.5 i (84 kW)	1995.11-	2001.02	MT/AT	L	F	Hatchback Engine D15Z6	GDS23020	Drive Shaft	50T	26	25	49	78.8	909	
	1995.11-	2001.02	MT/AT	R	F	Hatchback Engine D15Z6	GDS81010	Drive Shaft	50T	26	25	55	78.5	627	
	1995.11-	2001.02		R	F	Hatchback Engine D15Z6	GCI23005	Inner Joint		25	30	35	54.5	97	
	1995.11-	2001.02		R	F	Hatchback Engine D15Z6	GC023017	Outer Joint	50T	26	32	55	78.5	56.5	M
	1995.11-	2001.02				Hatchback Engine D15Z6	GC023073	Outer Joint	50T	26	28	55	78.5	56.5	M
	1995.11-	2001.02				Saloon Engine D15Z6	GC023073	Outer Joint	50T	26	28	55	78.5	56.5	M
	1995.11-	2001.02	MT/AT		F	Hatchback Engine D15Z6	GC023063	Outer Joint		26	32	55	78.5	56.5	I
	1995.11-	2001.02	MT/AT		F	Saloon Engine D15Z6	GC023063	Outer Joint		26	32	55	78.5	56.5	I
	1995.11-	2001.02	MT/AT		F	Hatchback Engine D15Z6	GC099225	Outer Joint	50T	26	32	55	78.5	56.5	I
	1995.11-	2001.02	MT/AT		F	Saloon Engine D15Z6	GC099225	Outer Joint	50T	26	32	55	78.5	56.5	I
	1995.11-	2001.02	MT/AT		F	Hatchback Engine D15Z6	GC023047	Outer Joint		26	28	55	77.5	53	M
	1995.11-	2001.02	MT/AT		F	Saloon Engine D15Z6	GC023047	Outer Joint		26	28	55	77.5	53	M
	1995.11-	2001.02	MT/AT		F	Hatchback Engine D15Z6	GC023024	Outer Joint	50T	26	28	55	77.5	53	M
	1995.11-	2001.02	MT/AT		F	Saloon Engine D15Z6	GC023024	Outer Joint	50T	26	28	55	77.5	53	M
	1.6 i (84 kW)	1995.11-	2001.02	MT/AT	L	F	Hatchback Engine D16Y5	GDS23020	Drive Shaft	50T	26	25	49	78.8	909
1995.11-		2001.02		R	F	Hatchback Engine D16Y5	GDS81010	Drive Shaft	50T	26	25	55	78.5	627	
1995.11-		2001.02		R	F	Hatchback Engine D16Y5	GCI23005	Inner Joint		25	30	35	54.5	97	
1995.11-		2001.02		R	F	Hatchback Engine D16Y5	GC023017	Outer Joint	50T	26	32	55	78.5	56.5	M
1995.11-		2001.02	MT			Hatchback Engine D16Y5	GC023073	Outer Joint	50T	26	28	55	78.5	56.5	M
1.6 i VTEC (92 kW)	1995.11-	2001.02	MT			Saloon Engine D16Y6/D16Y8	GC023073	Outer Joint	50T	26	28	55	78.5	56.5	M
1.6 VTi (118 kW)	1995.11-	2001.02	MT/AT		F	Hatchback Engine B16A2	GC023023	Outer Joint		26	30	55	78.5	56.5	M
	1995.11-	2001.02	MT/AT		F	Saloon Engine B16A2	GC023023	Outer Joint		26	30	55	78.5	56.5	M
	1995.11-	2001.02			F	Hatchback Engine B16A2	GC023086	Outer Joint	50T	26	30	55	78.5	56.5	M
	1995.11-	2001.02			F	Saloon Engine B16A2	GC023086	Outer Joint	50T	26	30	55	78.5	56.5	M
<b>CIVIC V (MB, MC)</b>															
1.4 16V (55 kW)	1998.04-	2001.02				Estate Engine D14A7	GC023073	Outer Joint	50T	26	28	55	78.5	56.5	M
	1998.04-	2001.02	MT/AT		F	Estate Engine D14A7	GC023047	Outer Joint		26	28	55	77.5	53	M
	1998.04-	2001.02			F	Estate Engine D14A7	GC051021	Outer Joint	50T	26	32	55	78.5	56.5	I
	1998.04-	2001.02			F	Estate Engine D14A7	GC099210	Outer Joint		26	32	55	78.5	56.5	I
1.4 16V (66 kW)	1998.04-	2001.02	MT/AT		F	Estate Engine D14A8	GC023047	Outer Joint		26	28	55	77.5	53	M
	1998.04-	2001.02			F	Estate Engine D14A8	GC051021	Outer Joint	50T	26	32	55	78.5	56.5	I
	1998.04-	2001.02			F	Estate Engine D14A8	GC099210	Outer Joint		26	32	55	78.5	56.5	I
	1998.04-	2001.02				Estate Engine D14A8	GC023073	Outer Joint	50T	26	28	55	78.5	56.5	M
1.5 16V (84 kW)	1998.04-	2001.02	MT/AT		F	Estate Engine D15Z8	GC023063	Outer Joint		26	32	55	78.5	56.5	I
	1998.04-	2001.02	MT/AT		F	Estate Engine D15Z8	GC023047	Outer Joint		26	28	55	77.5	53	M
	1998.04-	2001.02			F	Estate Engine D15Z8	GC051021	Outer Joint	50T	26	32	55	78.5	56.5	I
1.6 16V (85 kW)	1998.04-	2001.02	MT/AT		F	Estate Engine D16B2	GC023047	Outer Joint		26	28	55	77.5	53	M
	1998.04-	2001.02			F	Estate Engine D16B2	GC051021	Outer Joint	50T	26	32	55	78.5	56.5	I
	1998.04-	2001.02				Estate Engine D16B2	GC023073	Outer Joint	50T	26	28	55	78.5	56.5	M
1.6 16V (92 kW)	1998.04-	2001.02				Estate Engine D16W4	GC023073	Outer Joint	50T	26	28	55	78.5	56.5	M
1.8 16V (124 kW)	1998.04-	2001.02	MT	L	F	Estate Engine B18C4	GCI23013	Inner Joint		27	32	40	45.5	75	
	1998.04-	2001.02	MT	L	F	Estate Engine B18C4	GDS23155	Drive Shaft	50T	26	27	55	78.5	557	
	1998.04-	2001.02	MT	R	F	Estate Engine B18C4	GDS81056	Drive Shaft	50T	26	27	55	78.5	591.5	
<b>CIVIC VI</b>															
1.6	1995-	2001		L/R	F		GCI23014	Inner Joint		25	28	35	61.5	97.5	
1.6 i	1995-	2001		L/R	F		GCI23011	Inner Joint		27	32	40	45.5	85	
<b>CIVIC VI (EU, EP)</b>															
1.4 IS (66 kW)	2001.02-	2005.09					GC023095	Outer Joint	50T	26	22	60	79	56	M
1.6 i (81 kW)	2001.02-	2005.09					GC023039	Outer Joint	50T	26	28	60	77.5	53	M
1.7 CTDi (74 kW)	2001.02-	2005.09					GC023001	Outer Joint	50T	26	32	60	79	62.5	I





		YEAR	TRANSM	L/R	F/R		G-AP Ref.	PRODUCT	ABS	Technical Specifications						
										A	B	C	H	L	P	
<b>HONDA</b>																
<b>CIVIC VI (EU, EP)</b>																
1.8 (103 kW)	2001.02-	2005.09					GC023039	Outer Joint	50T		26	28	60	77.5	53	M
2.0 i Sport (118 kW)	2004-	2005					GC023095	Outer Joint	50T		26	22	60	79	56	M
<b>CIVIC VII (EM2)</b>																
1.6 i (81 kW)	2001.02-	2005.12	MT/AT		F	Coupe Engine D16V1	GC023039	Outer Joint	50T		26	28	60	77.5	53	M
	2001.02-	2005.12	MT	L	F	Coupe Engine D16V1	GDS23089	Drive Shaft	50T		26	25	60	78	895	
	2001.02-	2005.12		L	F	Coupe Engine D16V1	GDS23192	Drive Shaft	50T		26	25	55	77.5	893	
	2001.02-	2005.12	MT	R	F	Coupe Engine D16V1	GDS23097	Drive Shaft	50T		26	25	60	78	610	
	2001.02-	2005.12		R	F	Coupe Engine D16V1	GDS23259	Drive Shaft	50T		26	25	60	77.5	622	
1.7 i (88 kW)	2001.05-	2005.12	MT	L	F	Coupe Engine D17A8	GDS23089	Drive Shaft	50T		26	25	60	78	895	
	2001.05-	2005.12	MT	R	F	Coupe Engine D17A8	GDS23097	Drive Shaft	50T		26	25	60	78	610	
1.7 i VTEC (92 kW)	2001.05-	2005.12	MT	L	F	Coupe Engine D17A5/D17A9	GDS23089	Drive Shaft	50T		26	25	60	78	895	
<b>CIVIC VII (ES)</b>																
1.4 (66 kW)	2000.12-	2005.09	MT	L	F	Saloon Engine D14Z5	GDS23192	Drive Shaft	50T		26	25	55	77.5	893	
	2000.12-	2005.09	MT	R	F	Saloon Engine D14Z5	GDS23259	Drive Shaft	50T		26	25	60	77.5	622	
1.6 (81 kW)	2001.02-	2005.09			F	Saloon Engine D16V1	GC023039	Outer Joint	50T		26	28	60	77.5	53	M
	2001.02-	2005.09		L	F	Saloon Engine D16V1	GDS23192	Drive Shaft	50T		26	25	55	77.5	893	
	2001.02-	2005.09		R	F	Saloon Engine D16V1	GDS23259	Drive Shaft	50T		26	25	60	77.5	622	
<b>CIVIC VII (EU, EP, EV)</b>																
1.4 i (55 kW)	2001.02-	2005.09	MT	L	F	Hatchback Engine D14Z6	GDS23192	Drive Shaft	50T		26	25	55	77.5	893	
	2001.02-	2005.09	MT	R	F	Hatchback Engine D14Z6	GDS23259	Drive Shaft	50T		26	25	60	77.5	622	
1.4 iS (66 kW)	2001.02-	2005.09	MT/AT		F	Hatchback Engine D14Z5/D14Z6	GC023095	Outer Joint	50T		26	22	60	79	56	M
	2001.02-	2005.09	MT	L	F	Hatchback Engine D14Z5/D14Z6	GDS23192	Drive Shaft	50T		26	25	55	77.5	893	
	2001.02-	2005.09	MT	R	F	Hatchback Engine D14Z5/D14Z6	GDS23259	Drive Shaft	50T		26	25	60	77.5	622	
1.6 i (81 kW)	2001.02-	2005.09	MT/AT		F	Hatchback Engine D16V1	GC023039	Outer Joint	50T		26	28	60	77.5	53	M
	2001.02-	2005.09		L	F	Hatchback Engine D16V1	GDS23192	Drive Shaft	50T		26	25	55	77.5	893	
	2001.02-	2005.09		R	F	Hatchback Engine D16V1	GDS23259	Drive Shaft	50T		26	25	60	77.5	622	
1.7 CTDi (74 kW)	2002.01-	2005.09			F	Hatchback Engine 4EE-2	GC023001	Outer Joint	50T		26	32	60	79	62.5	I
2.0 i Sport (118 kW)	2001.09-	2005.09			F	Hatchback Engine K20A3	GC023095	Outer Joint	50T		26	22	60	79	56	M
2.0 Type-R (147 kW)	2001.09-	2005.09		L	F	Hatchback Engine K20A2	GDS23266	Drive Shaft	50T		28	27	64	88	624	
	2001.09-	2005.09		L/R	F	Hatchback Engine K20A2	GC023139	Outer Joint	50T		28	32	64	88	58.5	M
<b>CIVIC VIII (FD, FA)</b>																
1.8 (103 kW)	2005.09-	2008.01	MT	L	F	Saloon Engine R18A1	GDS23164	Drive Shaft			26	27	58	79	633	
	2005.09-	2008.01	MT	L	F	Saloon Engine R18A1	GCI23017	Inner Joint			27	30	40	58.5	97	
	2005.09-	2008.01	MT	L/R	F	Saloon Engine R18A1	GC023125	Outer Joint			26	30	58	79	59	M
	2005.09-	2008.01	MT	R	F	Saloon Engine R18A1	GDS23165	Drive Shaft			26	27	58	79	590	
	2005.09-	2008.01	MT	R	F	Saloon Engine R18A1	GCI23023	Inner Joint			27	30	40	45.5	75	
<b>CIVIC VIII (FN, FK)</b>																
1.4 (61 kW)	2005.09-	2007.02			F	Hatchback Engine L13A7	GC023125	Outer Joint			26	30	58	79	59	M
1.4 (73 kW)	2008.10-				F	Hatchback Engine L13Z1	GC023125	Outer Joint			26	30	58	79	59	M
1.8 (103 kW)	2005.09-	2008.01			F	Hatchback Engine R18A2	GC023125	Outer Joint			26	30	58	79	59	M
	2005.09-	2008.01	MT	L	F	Hatchback Engine R18A2	GDS23164	Drive Shaft			26	27	58	79	633	
	2005.09-	2008.01	MT	L	F	Hatchback Engine R18A2	GCI23017	Inner Joint			27	30	40	58.5	97	
	2005.09-	2008.01	MT	L/R	F	Hatchback Engine R18A2	GC023125	Outer Joint			26	30	58	79	59	M
	2005.09-	2008.01	MT	R	F	Hatchback Engine R18A2	GDS23165	Drive Shaft			26	27	58	79	590	
	2005.09-	2008.01	MT	R	F	Hatchback Engine R18A2	GCI23023	Inner Joint			27	30	40	45.5	75	
2.0 Type-R (148 kW)	2006.09-		MT	R	F	Hatchback Engine K20Z4	GDS23287	Drive Shaft			28	27	63	88.5	602	
2.2 CTDi (103 kW)	2005.09-	2007.01	MT	R	F	Hatchback Engine N22A2	GDS23191	Drive Shaft			28	29	63	89	616	
	2005.09-	2007.01	MT			Hatchback Engine N22A2	GC023147	Outer Joint			28	35	63	89	60	I
<b>CIVICK IV (EJ)</b>																
1.5 i LSi (74 kW)	1993.08-	1995.11			F	Coupe Engine D15B7	GC023023	Outer Joint			26	30	55	78.5	56.5	M
	1993.08-	1995.11			F	Coupe Engine D15B7	GC023086	Outer Joint	50T		26	30	55	78.5	56.5	M
	1993.08-	1995.11	MT/AT		F	Coupe Engine D15B7	GC023022	Outer Joint			26	30	55	79	56	M
	1993.08-	1995.11	MT/AT		F	Coupe Engine D15B7	GC023083	Outer Joint	50T		26	30	55	78.5	56	M
1.6 i (77 kW)	1994.01-	1995.11	MT/AT		F	Coupe Engine D16Y7	GC023023	Outer Joint			26	30	55	78.5	56.5	M
1.6 i VTEC (118 kW)	1994.01-	1995.11			F	Coupe Engine B16A2	GC023023	Outer Joint			26	30	55	78.5	56.5	M
	1994.01-	1995.11	MT/AT		F	Coupe Engine B16A2	GC023016	Outer Joint			26	32	55	78.5	56.5	M
1.6 i VTEC (92 kW)	1994.01-	1996.03	MT/AT		F	Coupe Engine D16Y6/D16Z9	GC023022	Outer Joint			26	30	55	79	56	M
	1994.01-	1996.03	MT/AT		F	Coupe Engine D16Y6/D16Z9	GC023083	Outer Joint	50T		26	30	55	78.5	56	M
<b>CONCERTO (HW)</b>																
1.4 (66 kW)	1989.08-	1991.10	MT/AT	L	F	Hatchback Engine D14A1/D14A8	GDS51001	Drive Shaft			26	22	49	78.8	642	
	1989.08-	1991.10	MT/AT	R	F	Hatchback Engine D14A1/D14A8	GDS51010	Drive Shaft			26	22	49	78.8	877	
	1989.08-	1991.10	MT/AT	L	F	Hatchback Engine D14A1/D14A8	GDS51023	Drive Shaft	27T		26	22	49	78.8	642	









		YEAR	TRANSM	L/R	F/R		G-AP Ref.	PRODUCT	ABS	Technical Specifications						
										A	B	C	H	L	P	
<b>HONDA</b>																
<b>CONCERTO (HW)</b>																
1.6 i 16V (82 kW)	1989.08-	1995.03	MT/AT	L	F	Hatchback Engine D16Z2	GDS23122	Drive Shaft		26	27	49	78.8	608		
	1989.08-	1995.03	MT/AT	R	F	Hatchback Engine D16Z2	GDS23078	Drive Shaft		26	27	49	78.8	606		
	1989.08-	1995.03	MT/AT		F	Hatchback Engine D16Z2	GC023007	Outer Joint		26	23	49	78.8	55	I	
	1989.08-	1995.03	MT/AT		F	Hatchback Engine D16Z2	GC023008	Outer Joint	50T	26	23	49	78.8	55	I	
	1989.08-	1995.03	MT/AT	L	F	Hatchback Engine D16Z2	GDS81020	Drive Shaft	50T	26	27	49	78.8	608		
	1989.08-	1995.03	MT/AT	R	F	Hatchback Engine D16Z2	GDS23040	Drive Shaft	50T	26	27	49	78.8	606		
1.6 i 16V (90 kW)	1989.08-	1995.03	MT/AT	L	F	Hatchback Engine D16A8	GDS23122	Drive Shaft		26	27	49	78.8	608		
	1989.08-	1995.03	MT/AT	R	F	Hatchback Engine D16A8	GDS23078	Drive Shaft		26	27	49	78.8	606		
	1989.08-	1995.03	MT/AT		F	Hatchback Engine D16A8	GC023007	Outer Joint		26	23	49	78.8	55	I	
	1989.08-	1995.03	MT/AT		F	Hatchback Engine D16A8	GC023008	Outer Joint	50T	26	23	49	78.8	55	I	
	1989.08-	1995.03	MT/AT	L	F	Hatchback Engine D16A8	GDS81020	Drive Shaft	50T	26	27	49	78.8	608		
	1989.08-	1995.03	MT/AT	R	F	Hatchback Engine D16A8	GDS23040	Drive Shaft	50T	26	27	49	78.8	606		
<b>CONCERTO (HWW)</b>																
1.6 i 16V (82 kW)	1989.08-	1995.03	MT/AT	L	F	Saloon Engine D16Z2	GDS23122	Drive Shaft		26	27	49	78.8	608		
	1989.08-	1995.03	MT/AT	R	F	Saloon Engine D16Z2	GDS23078	Drive Shaft		26	27	49	78.8	606		
	1989.08-	1995.03	MT/AT		F	Saloon Engine D16Z2	GC023007	Outer Joint		26	23	49	78.8	55	I	
	1989.08-	1995.03	MT/AT		F	Saloon Engine D16Z2	GC023008	Outer Joint	50T	26	23	49	78.8	55	I	
	1989.08-	1995.03	MT/AT	L	F	Saloon Engine D16Z2	GDS81020	Drive Shaft	50T	26	27	49	78.8	608		
	1989.08-	1995.03	MT/AT	R	F	Saloon Engine D16Z2	GDS23040	Drive Shaft	50T	26	27	49	78.8	606		
1.6 i 16V (90 kW)	1989.08-	1995.03	MT/AT	L	F	Saloon Engine D16A8	GDS23122	Drive Shaft		26	27	49	78.8	608		
	1989.08-	1995.03	MT/AT	R	F	Saloon Engine D16A8	GDS23078	Drive Shaft		26	27	49	78.8	606		
	1989.08-	1995.03	MT/AT		F	Saloon Engine D16A8	GC023007	Outer Joint		26	23	49	78.8	55	I	
	1989.08-	1995.03	MT/AT		F	Saloon Engine D16A8	GC023008	Outer Joint	50T	26	23	49	78.8	55	I	
	1989.08-	1995.03	MT/AT	L	F	Saloon Engine D16A8	GDS81020	Drive Shaft	50T	26	27	49	78.8	608		
	1989.08-	1995.03	MT/AT	R	F	Saloon Engine D16A8	GDS23040	Drive Shaft	50T	26	27	49	78.8	606		
<b>CR-V</b>																
-	1997-	1998		L		Truck	GDS23124	Drive Shaft		28	27	64	88.5	601.7		
2.0	2007-						GC023124	Outer Joint		30	32	68	88	59.5	M	
<b>CR-V (RD1)</b>																
2.0 4WD	1998.12-	2001.09	4AT			Engine B20B	GC099248	Outer Joint	50T	26	32	60	78	56	M	
<b>CR-V (RD2)</b>																
2.0	2000.05-		4AT			Engine B20B	GC099248	Outer Joint	50T	26	32	60	78	56	M	
<b>CR-V (RD4)</b>																
2.0	2001.09-		4AT			Engine K20A	GC023034	Outer Joint		28	32	63	88.5	59.5	M	
<b>CR-V (RD4, RD5, RD6, RD7, RD9)</b>																
-	2001-	2006					GCI23046	Inner Joint		23	25	55	78	85		
<b>CR-V (RD5)</b>																
2.0	2001.09-		MT/AT	R		Engine K20A	GDS23074	Drive Shaft		28	27	63	88.5	618		
	2001.09-		MT/AT		F		GCI23013	Inner Joint		27	32	40	45.5	75		
	2001.09-		MT/AT		F		GCI23009	Inner Joint		27	32	40	58.5	97		
	2001.09-		MT/AT	L	F	Engine K20A	GDS23011	Drive Shaft		28	27	63	88.5	663		
2.0 4WD	2001.09-		MT/AT			Engine K20A	GC023034	Outer Joint		28	32	63	88.5	59.5	M	
<b>CR-V (RE3)</b>																
2.4	2006.10-		5AT/I			Engine K24A	GC023153	Outer Joint		30	32	68	88.5	59.5	M	
<b>CR-V (RE4)</b>																
2.4 4WD	2006.10-		5AT/I			Engine K24A	GC023153	Outer Joint		30	32	68	88.5	59.5	M	
<b>CR-V I (RD)</b>																
2.0 (98 kW)	1999.04-	2002.02				Closed Off-Road Vehicle Engine B20Z1	GC023080	Outer Joint	50T	28	32	64	88.5	62	M	
2.0 16V (108 kW)	1999.01-	2002.02				Closed Off-Road Vehicle Engine B20Z1	GC023080	Outer Joint	50T	28	32	64	88.5	62	M	
	1999.01-	2002.02				Closed Off-Road Vehicle Engine B20Z1	GC023096	Outer Joint		26	30	55	79.5	57	I	
	1999.01-	2002.02				Closed Off-Road Vehicle Engine B20Z1	GC081006	Outer Joint		28	32	64	88.5	62	M	
	1999.01-	2002.02		L	F	Closed Off-Road Vehicle Engine B20Z1	GDS23042	Drive Shaft	50T	28	27	64	88.5	601.7		
	1999.01-	2002.02		R	F	Closed Off-Road Vehicle Engine B20Z1	GDS99146	Drive Shaft	50T	28	27	64	88.5	640		
	1999.01-	2002.02		R	F	Closed Off-Road Vehicle Engine B20Z1	GCI81001	Inner Joint		27	32	40	55.5	97		
1999.01-	2002.02		R	F	Closed Off-Road Vehicle Engine B20Z1	GC023197	Outer Joint	50T	28	32	64	88.5	62	M		
<b>CR-V II (RD.)</b>																
2.0 (110 kW)	2002.07-	2006.09				Closed Off-Road Vehicle Engine K20A4	GC099159	Outer Joint		28	32	60	87	61	M	
	2002.07-	2006.09		L	F	Closed Off-Road Vehicle Engine K20A4	GDS23011	Drive Shaft		28	27	63	88.5	663		
	2002.07-	2006.09		R	F	Closed Off-Road Vehicle Engine K20A4	GDS23074	Drive Shaft		28	27	63	88.5	618		
2.2 CTDi (103 kW)	2005.02-	2006.09	MT	L	F	Closed Off-Road Vehicle Engine N22A2	GDS23188	Drive Shaft		28	29	63	88.5	640		
	2005.02-	2006.09	MT	R	F	Closed Off-Road Vehicle Engine N22A2	GDS23190	Drive Shaft		28	29	63	88.5	627		



		YEAR	TRANSM	L/R	F/R		G-AP Ref.	PRODUCT	ABS	Technical Specifications											
										A	B	C	H	L	P						
<b>HONDA</b>																					
<b>CR-V III (RE)</b>																					
2.0 i 4WD (110 kW)	2007.01-					Closed Off-Road Vehicle Engine R20A2	GC023124	Outer Joint		30	32	68	88	59.5	M						
	2007.01-			L	R	Closed Off-Road Vehicle Engine R20A2	GDS23199	Drive Shaft		28	23	55	91	770							
	2007.01-			R	R	Closed Off-Road Vehicle Engine R20A2	GDS23198	Drive Shaft		28	23	55	91	820							
2.2 i-CTDi 4WD (103 kW)	2007.01-			L	F	Closed Off-Road Vehicle Engine N22A2	GDS23216	Drive Shaft		30	29	68	88	640							
	2007.01-			R	F	Closed Off-Road Vehicle Engine N22A2	GDS23189	Drive Shaft		30	29	68	88	557							
	2007.01-			L	R	Closed Off-Road Vehicle Engine N22A2	GDS23199	Drive Shaft		28	23	55	91	770							
	2007.01-			R	R	Closed Off-Road Vehicle Engine N22A2	GDS23198	Drive Shaft		28	23	55	91	820							
2.2 i-DTEC 4WD (110 kW)	2007.01-					Closed Off-Road Vehicle Engine N22B3	GC023145	Outer Joint		30	34	68	88	59.5	M						
	2007.01-					Closed Off-Road Vehicle Engine N22B3	GC023160	Outer Joint		28	20	55	91	52.5	M						
	2007.01-			L	F	Closed Off-Road Vehicle Engine N22B3	GDS23216	Drive Shaft		30	29	68	88	640							
	2007.01-			R	F	Closed Off-Road Vehicle Engine N22B3	GDS23189	Drive Shaft		30	29	68	88	557							
	2007.01-			L	R	Closed Off-Road Vehicle Engine N22B3	GDS23199	Drive Shaft		28	23	55	91	770							
	2007.01-			R	R	Closed Off-Road Vehicle Engine N22B3	GDS23198	Drive Shaft		28	23	55	91	820							
2.4 i VTEC 4WD (122 kW)	2009.09-			L	R	Closed Off-Road Vehicle Engine K24Z1/K24Z4	GDS23199	Drive Shaft		28	23	55	91	770							
	2009.09-			R	R	Closed Off-Road Vehicle Engine K24Z1/K24Z4	GDS23198	Drive Shaft		28	23	55	91	820							
<b>CRX</b>																					
-	1988-	1991				DX SI	GCI23004	Inner Joint		25	30	35	62	97.5							
<b>CRX (AF, AS)</b>																					
1.6 i 16V (92 kW)	1986.03-	1987.10	MT/AT			F Coupe Engine ZC1	GC023021	Outer Joint		26	32	49	78.5	56.5	M						
<b>CRX II (ED, EE)</b>																					
1.6 i 16V (91 kW)	1987.10-	1992.02	MT/AT			F Coupe Engine D16Z5	GC023021	Outer Joint		26	32	49	78.5	56.5	M						
1.6 i 16V (96 kW)	1987.10-	1989.12	MT/AT			F Coupe Engine D16A8/D16A9	GC023021	Outer Joint		26	32	49	78.5	56.5	M						
1.6 i 16V VTEC (110 kW)	1989.10-	1992.02	MT			F Coupe Engine B16A1	GC023021	Outer Joint		26	32	49	78.5	56.5	M						
<b>CRX III (EH, EG)</b>																					
1.5 (66 kW)	1992-	1995				K600 LS1	GC023093	Outer Joint		26	30	55	78	56	I						
1.6 ESi (92 kW)	1992.03-	1998.12	MT/AT			F Targa Engine D16Y8/D16Z6	GC023016	Outer Joint		26	32	55	78.5	56.5	M						
	1992.03-	1998.12				F Targa Engine D16Y8/D16Z6	GC023086	Outer Joint	50T	26	30	55	78.5	56.5	M						
1.6 i VTi (118 kW)	1992.03-	1998.12	MT/AT			F Targa Engine B16A2	GC023016	Outer Joint		26	32	55	78.5	56.5	M						
<b>DOMANI (MA4)</b>																					
1.6	1992.10-	1997.01	MT/AT			Engine ZC	GC023019	Outer Joint		26	30	55	78.5	56	M						
<b>DOMANI (MA7)</b>																					
1.5	1994.02-	1995.09	MT/AT			Engine D15B	GC023019	Outer Joint		26	30	55	78.5	56	M						
	1995.09-	1996.11	MT/AT			Engine D15B	GC023038	Outer Joint		26	28	55	78	55	M						
<b>DOMANI (MB3)</b>																					
1.5	1997.01-		MT/AT			Engine D15B	GC023038	Outer Joint		26	28	55	78	55	M						
<b>DOMANI (MB4)</b>																					
1.6	1997.01-		HMM			Engine D16A	GC023038	Outer Joint		26	28	55	78	55	M						
	1997.01-		MT/AT			Engine D16A	GC023038	Outer Joint		26	28	55	78	55	M						
<b>EDIX (BE1, BE2, BE3, BE4)</b>																					
-	2004-	2009					GCI23046	Inner Joint		23	25	55	78	85							
<b>FIT / JAZZ / CITY (GD1)</b>																					
1.3	2001.06-		MT/AT			Engine L13A	GC023104	Outer Joint		23	25	52	79	50	M						
<b>FIT / JAZZ / CITY (GD2)</b>																					
1.3 4WD	2001.06-	2007.10	CVT/F			Engine L13A	GC023106	Outer Joint		26	28	52	79	54	M						
<b>FIT / JAZZ / CITY (GD4)</b>																					
1.5 4WD	2002.09-	2005.12	CVT/F			Engine L15A	GC023106	Outer Joint		26	28	52	79	54	M						
<b>FIT / JAZZ / CITY (GD6)</b>																					
1.5	2003.01-		MT/AT			Engine L15A1	GC023106	Outer Joint		26	28	52	79	54	M						
<b>FIT / JAZZ / CITY (GD8)</b>																					
1.5	2003.01-		MT/AT			Engine L15A2	GC023106	Outer Joint		26	28	52	79	54	M						
<b>FIT / JAZZ / CITY (GE6)</b>																					
1.3	2007.10-		CVT/F			Engine L13A	GC023165	Outer Joint		26	27	52	78.6	54.3	M						
<b>FIT / JAZZ / CITY (GE7) 4WD</b>																					
1.3	2007.10-		5AT/F			Engine L13A	GC023165	Outer Joint		26	27	52	78.6	54.3	M						
<b>FIT / JAZZ / CITY (GE8)</b>																					
1.5	2007.10-		5MT/F			Engine L15A	GC023165	Outer Joint		26	27	52	78.6	54.3	M						
	2007.10-		CVT/F			Engine L15A	GC023165	Outer Joint		26	27	52	78.6	54.3	M						
<b>FIT / JAZZ / CITY (GE9) 4WD</b>																					
1.5	2007.10-		5AT/F			Engine L15A	GC023165	Outer Joint		26	27	52	78.6	54.3	M						
<b>FREED (GB3)</b>																					
1.5	2008.05-		CVT			Engine L15A	GC023173	Outer Joint		26	27	58	78	51.5	M						

		TRANSM	L/R	F/R		G-AP Ref.	PRODUCT	ABS	Technical Specifications					
									YEAR	A	B	C	H	L
<b>HONDA</b>														
<b>HR-V (GH)</b>														
1.6 16V (77 kW)	1999.03-					GC023033	Outer Joint	50T	26	30	60	78.5	57	M
	1999.03-			F	Closed Off-Road Vehicle Engine D16W1	GC023033	Outer Joint	50T	26	30	60	78.5	57	M
1.6 16V 4WD (77 kW)	1999.03-					GC023033	Outer Joint	50T	26	30	60	78.5	57	M
	1999.03-				Closed Off-Road Vehicle Engine D16W1	GC023033	Outer Joint	50T	26	30	60	78.5	57	M
1.6 16V 4WD (91 kW)	1999.10-					GC023033	Outer Joint	50T	26	30	60	78.5	57	M
	1999.10-				Closed Off-Road Vehicle Engine D16W5	GC023033	Outer Joint	50T	26	30	60	78.5	57	M
<b>INSPIRE</b>														
2.5 (CC2)	1992.01-	1995.02	AT		Engine G25A	GC023028	Outer Joint		28	34	60	89	60	M
<b>INSPIRE (CB5)</b>														
2.0	1989.10-	1995.02	MT/AT		Engine G20A	GC023015	Outer Joint		28	32	60	89	60	M
<b>INSPIRE (CC3)</b>														
2.0	1992.01-	1995.02	AT		Engine G20A	GC023015	Outer Joint		28	32	60	89	60	M
<b>INTEGRA</b>														
-	1985-	1989				GC023043	Outer Joint		26	32	49	79	56	M
	1990-	1993		L		GDS81036	Drive Shaft		26	27	55	78.5	597	
<b>INTEGRA (DB6)</b>														
1.6	1993.07-	1995.08	MT/AT		Engine ZC	GC023019	Outer Joint		26	30	55	78.5	56	M
<b>INTEGRA (DC1)</b>														
1.6	1993.05-	1995.08	MT/AT		Engine ZC	GC023019	Outer Joint		26	30	55	78.5	56	M
<b>INTEGRA (DC2, DC4)</b>														
1.8 Type-R (140 kW)	1997.11-	2001.10	MT	F	Coupe Engine B18C6	GC023016	Outer Joint		26	32	55	78.5	56.5	M
<b>INTEGRA (EK3)</b>														
1.5	1996.02-	2001.02	MT/AT		Engine D15B	GC023038	Outer Joint		26	28	55	78	55	M
<b>JAZZ II (GD)</b>														
1.2 (57 kW)	2002.03-	2008.07		F	Hatchback Engine L12A1	GC023030	Outer Joint		26	28	52	79	56	M
	2002.03-	2008.07		L/R	F Hatchback Engine L12A1	GC023094	Outer Joint		26	28	52	78.5	56	M
1.3 (63 kW)	2003.05-			F	Saloon Engine L13A1	GC023030	Outer Joint		26	28	52	79	56	M
1.3 iDSi (63 kW)	2002.03-	2007.09		F	Hatchback Engine L13A1	GC023030	Outer Joint		26	28	52	79	56	M
1.4 (61 kW)	2002.03-	2008.07		F	Hatchback Engine L13A1	GC023030	Outer Joint		26	28	52	79	56	M
	2002.03-	2008.07		L/R	F Hatchback Engine L13A1	GC023094	Outer Joint		26	28	52	78.5	56	M
<b>JAZZ III (GD)</b>														
1.2 DSi (57 kW)	2002.03-					GC023094	Outer Joint		26	28	52	78.5	56	M
1.4 DSi (61 kW)	2002.03-					GC023094	Outer Joint		26	28	52	78.5	56	M
1.4 DSi (63 kW)	2002.03-					GC023094	Outer Joint		26	28	52	78.5	56	M
<b>JAZZ IV (GE)</b>														
1.2 i V-TEC (66 kW)	2008.07-					GC023094	Outer Joint		26	28	52	78.5	56	M
1.3 i V-TEC (73 kW)	2008.07-					GC023094	Outer Joint		26	28	52	78.5	56	M
<b>LEGEND</b>														
3.2 V6	1991.01-	1996.04		L		GDS81018	Drive Shaft	50T	30	31	64	89	671	
	1991.01-	1996.04		R		GDS81017	Drive Shaft	50T	30	31	64	89	639.5	
	1991.01-	1996.04				GC181006	Inner Joint		31	36	42	64.1	106.2	
<b>LEGEND (HS, KA)</b>														
2.5 i (110 kW)	1986.01-	1987.12		F	Saloon Engine C25A1	GC023044	Outer Joint		28	34	60	88	57.5	M
2.5 i (127 kW)	1987.02-	1988.06		F	Saloon Engine C25A2	GC023044	Outer Joint		28	34	60	88	57.5	M
	1987.02-	1988.06	MT/AT	F	Saloon Engine C25A2	GC023081	Outer Joint	50T	28	34	60	83.5	59	M
2.7 i 24V (124 kW)	1988.01-	1990.12		F	Saloon Engine C27A1	GC023044	Outer Joint		28	34	60	88	57.5	M
	1988.01-	1990.12	MT/AT	F	Saloon Engine C27A1	GC023081	Outer Joint	50T	28	34	60	83.5	59	M
<b>LEGEND (KA3)</b>														
2.7 i 24V (124 kW)	1987.10-	1990.12		F	Coupe Engine C27A1	GC023044	Outer Joint		28	34	60	88	57.5	M
	1987.10-	1990.12	MT/AT	F	Coupe Engine C27A1	GC023081	Outer Joint	50T	28	34	60	83.5	59	M
<b>LEGEND II (CC,KA7,KA8)</b>														
2.5 (CC2)	1992.01-	1995.02	AT		Engine G25A	GC023028	Outer Joint		28	34	60	89	60	M
<b>LEGEND II (KA7)</b>														
3.2 i 24V (151 kW)	1991.01-	1996.02	MT/AT	F	Saloon Engine C32A2	GC023081	Outer Joint	50T	28	34	60	83.5	59	M
	1991.01-	1996.02		F	Saloon Engine C32A2	GC023044	Outer Joint		28	34	60	88	57.5	M
	1991.01-	1996.02		F	Saloon Engine C32A2	GC081005	Outer Joint		30	36	64	89	65.5	M
	1991.01-	1996.02		F	Saloon Engine C32A2	GC023084	Outer Joint	50T	30	36	64	89	65.5	M
<b>LEGEND II (KA8)</b>														
3.2 i 24V (151 kW)	1991.01-	1996.02	MT/AT	F	Coupe Engine C32A2	GC023081	Outer Joint	50T	28	34	60	83.5	59	M
	1991.01-	1996.02		F	Coupe Engine C32A2	GC023044	Outer Joint		28	34	60	88	57.5	M
	1991.01-	1996.02		F	Coupe Engine C32A2	GC081005	Outer Joint		30	36	64	89	65.5	M









		YEAR	TRANSM	L/R	F/R		G-AP Ref.	PRODUCT	ABS	Technical Specifications							
										A	B	C	H	L	P		
<b>HONDA</b>																	
<b>LEGEND II (KA8)</b>																	
3.2 i 24V (151 kW)	1991.01-	1996.02			F	Coupe Engine C32A2	GC023084	Outer Joint	50T	30	36	64	89	65.5	M		
<b>LEGEND III (KA9)</b>																	
3.5 i 24V (151 kW)	1996.02-				F	Saloon Engine C35A2	GC023044	Outer Joint		28	34	60	88	57.5	M		
	1996.02-				F	Saloon Engine C35A2	GC023084	Outer Joint	50T	30	36	64	89	65.5	M		
<b>LIFE (JA4)</b>																	
660	1993.01-	1996.02	MT&AT			Engine E07A	GC023099	Outer Joint		23	21	49	72	49	I		
<b>LIFE (JB1)</b>																	
0.7	1998.10-	2003.09	3AT			Engine E07Z	GC023182	Outer Joint	50T	23	25	49	78	50.5	M		
	1998.10-	2003.09	5MT			Engine E07Z	GC023182	Outer Joint	50T	23	25	49	78	50.5	M		
<b>LIFE (JB2)</b>																	
0.7 4WD	1998.10-	2003.09	3AT			Engine E07Z	GC023182	Outer Joint	50T	23	25	49	78	50.5	M		
	1998.10-	2003.09	5MT			Engine E07Z	GC023182	Outer Joint	50T	23	25	49	78	50.5	M		
<b>LIFE (JB3)</b>																	
0.7	2000.12-		3AT			Engine E07Z TBO	GC023182	Outer Joint	50T	23	25	49	78	50.5	M		
<b>LIFE (JB4)</b>																	
0.7 4WD	2000.12-		3AT			Engine E07Z TBO	GC023182	Outer Joint	50T	23	25	49	78	50.5	M		
<b>LIFE (JD1)</b>																	
0.7	2002.02-		3AT			Engine E07Z TBO	GC023182	Outer Joint	50T	23	25	49	78	50.5	M		
<b>LIFE (JD2)</b>																	
0.7 4WD	2002.02-		3AT			Engine E07Z TBO	GC023182	Outer Joint	50T	23	25	49	78	50.5	M		
<b>LIFE DUNK (JB3)</b>																	
0.7	2000.12-	2003.09	3AT			Engine E07Z TBO	GC023182	Outer Joint	50T	23	25	49	78	50.5	M		
<b>LIFE DUNK (JB4)</b>																	
0.7 4WD	2000.12-	2003.09	3AT			Engine E07Z TBO	GC023182	Outer Joint	50T	23	25	49	78	50.5	M		
<b>LOGO (GA3)</b>																	
1.3	1990-	2001				Engine D13B	GC099162	Outer Joint		23	26	49	78	50.5	M		
1.3 (48 kW)	1999.03-	2002.03			F	Hatchback Engine D13B7	GC023126	Outer Joint	50T	23	26	49	78	50.5	M		
	1999.03-	2002.03		L/R	F	Hatchback Engine D13B7	GC023156	Outer Joint	50T	26	28	55	78	52	M		
<b>ODYSSEY</b>																	
-	1995-	1998			R	Truck	GDS23013	Drive Shaft	50T	28	27	64	88.5	613.5			
	1995-	1998			L	Truck	GDS23091	Drive Shaft	50T	28	27	64	88.5	569			
	1995-	1998				Truck	GCI81008	Inner Joint		27	32	40	43	78			
<b>ODYSSEY (RA6)</b>																	
2.3	1991.02-	2003.11	4AT			Engine F23A	GC023029	Outer Joint	50T	28	32	64	89	60	M		
<b>ODYSSEY (RA7)</b>																	
2.3 4WD	1991.02-	2003.10	4AT			Engine F23A	GC023029	Outer Joint	50T	28	32	64	89	60	M		
<b>ODYSSEY (RA8)</b>																	
3.0	1991.02-	2003.10	5AT			Engine J30A	GC023029	Outer Joint	50T	28	32	64	89	60	M		
<b>ODYSSEY (RA9)</b>																	
3.0 4WD	1999.12-	2003.10	5AT			Engine J30A	GC023029	Outer Joint	50T	28	32	64	89	60	M		
<b>ODYSSEY III (RB1, RB2)</b>																	
-	2003-	2008					GCI23046	Inner Joint		23	25	55	78	85			
<b>OLTIA (EL1)</b>																	
1.8	1996.02-		MT/AT			Engine B18B	GC023019	Outer Joint		26	30	55	78.5	56	M		
<b>OLTIA (EL2)</b>																	
2.0	1996.02-		AT			Engine B20B	GC023019	Outer Joint		26	30	55	78.5	56	M		
<b>OLTIA (EL3)</b>																	
2.0 4WD	1996.02-		AT			Engine B20B	GC023019	Outer Joint		26	30	55	78.5	56	M		
<b>PARTNER (EY6)</b>																	
1.3	1996.02-		MT/AT			Engine D13B	GC023038	Outer Joint		26	28	55	78	55	M		
<b>PARTNER (EY7)</b>																	
1.5	1996.02-		MT/AT			Engine D15B	GC023038	Outer Joint		26	28	55	78	55	M		
<b>PARTNER (EY8)</b>																	
1.6	1996.02-		MT/AT			Engine D16A	GC023019	Outer Joint		26	30	55	78.5	56	M		
<b>PASSPORT</b>																	
-	1994-	1995					GCI26001	Inner Joint		17	26	30	517	97.5			
	1994-	1995					GCI26002	Inner Joint		17	26	30	98	98.5			
	1998-	2002			L/R		GC023055	Outer Joint		17	33	53	136.5	69.5	I		
	1998-	2002			L/R		GDS23005	Drive Shaft		17	17	53	136.5	609			
<b>PRELUDE</b>																	
-	1980-	1981					GCI23002	Inner Joint		25	22	35	54.5	90			



		YEAR	TRANSM	L/R	F/R		G-AP Ref.	PRODUCT	ABS	Technical Specifications								
										A	B	C	H	L	P			
<b>HONDA PRELUDE</b>																		
-	1983-						GC023041	Outer Joint		23	30	45	79	56	M			
	1984-1987						GC023043	Outer Joint		26	32	49	79	56	M			
	1985-1997	AT/MT					GCI81002	Inner Joint		27	32	40	54	87				
	1992-2001						GCI23012	Inner Joint		27	32	40	58.3	107.3				
	1992-1996						GC023046	Outer Joint		28	32	60	93	59	M			
	1993.10-1996			R	BB		GCI23012	Inner Joint		27	32	40	58.3	107.3				
2.0	1995-2000						GC023075	Outer Joint	50T	26	23	55	78.5	56.5	M			
	1995-2000			R			GDS23080	Drive Shaft		26	27	55	78.5	618.5				
	1995-2000			R			GDS23049	Drive Shaft	50T	26	27	55	78.5	618.5				
	1995-2000			L			GDS23050	Drive Shaft	50T	26	27	55	78.5	594				
2.0 4WS BA	1987.10-1991.11			L			GDS23116	Drive Shaft		26	27	55	78.5	608				
<b>PRELUDE (BA4)</b>																		
2.0	1987.04-1991.09	MT/AT				Engine B20A	GC023015	Outer Joint		28	32	60	89	60	M			
<b>PRELUDE (BA5)</b>																		
2.0 4WS	1987.04-1991.09	MT/AT				Engine B20A	GC023015	Outer Joint		28	32	60	89	60	M			
<b>PRELUDE (BA7)</b>																		
2.1	1990.10-1991.09	AT				Engine B21A	GC023015	Outer Joint		28	32	60	89	60	M			
<b>PRELUDE (BA8)</b>																		
2.2	1991.09-1994.09	4AT				Engine F22B	GC023015	Outer Joint		28	32	60	89	60	M			
	1991.09-1996.11	5MT				Engine F22B	GC023015	Outer Joint		28	32	60	89	60	M			
	1991.09-1996.11	AT				Engine F22B	GC023015	Outer Joint		28	32	60	89	60	M			
<b>PRELUDE (BA9)</b>																		
2.2 4WS	1991.09-1994.09	MT&AT				Engine F22B	GC023015	Outer Joint		28	32	60	89	60	M			
	1991.09-1996.11	4AT				Engine F22B	GC023015	Outer Joint		28	32	60	89	60	M			
	1991.09-1996.11	5MT				Engine F22B	GC023015	Outer Joint		28	32	60	89	60	M			
<b>PRELUDE (BB1)</b>																		
2.2 4WS	1991.09-1994.09	4AT				Engine H22A	GC023015	Outer Joint		28	32	60	89	60	M			
	1991.09-1994.09	5MT				Engine H22A	GC023015	Outer Joint		28	32	60	89	60	M			
	1991.09-1996.11	AT				Engine H22A	GC023015	Outer Joint		28	32	60	89	60	M			
	1994.09-1996.11	MT				Engine H22A	GC023015	Outer Joint		28	32	60	89	60	M			
<b>PRELUDE (BB4)</b>																		
2.2	1991.09-1994.09	AT				Engine H22A	GC023015	Outer Joint		28	32	60	89	60	M			
	1991.09-1996.11	4AT				Engine H22A	GC023015	Outer Joint		28	32	60	89	60	M			
	1991.09-1996.11	5MT				Engine H22A	GC023015	Outer Joint		28	32	60	89	60	M			
<b>PRELUDE (SN)</b>																		
1.6 (59 kW)	1978.11-1982.10	MT			F	Coupe Engine EL/EL14	GC023003	Outer Joint		23	22	45	78	55	M			
	1978.11-1982.10				F	Coupe Engine EL/EL14	GC081002	Outer Joint		24	22	45	78	57	M			
<b>PRELUDE I, COUPE (SN)</b>																		
1.6 (59 kW)	1978.01-1982.12	MT					GC024002	Outer Joint	29T	25	22	50	95	58	M			
1.6 (66 kW)	1978.01-1982.12	MT					GC024002	Outer Joint	29T	25	22	50	95	58	M			
1.8 (66 kW)	1978-1980						GC024002	Outer Joint	29T	25	22	50	95	58	M			
1.8 (74 kW)	1978-1980						GC024002	Outer Joint	29T	25	22	50	95	58	M			
1.8 (77 kW)	1978-1980						GC024002	Outer Joint	29T	25	22	50	95	58	M			
<b>PRELUDE II</b>																		
-	1985.01-1987.12	AT	L/R	F	USA		GCI81002	Inner Joint		27	32	40	54	87				
	1985.01-1987.12	MT	R	F	USA		GCI81002	Inner Joint		27	32	40	54	87				
	1985.01-1987.12	AT	L	F	USA		GDS23142	Drive Shaft		26	27	49	78.5	922				
	1985.01-1987.12	AT	R	F	USA		GDS23146	Drive Shaft		26	27	49	78.5	619.5				
	1985.01-1987.12	MT	R	F	USA		GDS23146	Drive Shaft		26	27	49	78.5	619.5				
<b>PRELUDE II (AB)</b>																		
1.8 EX (74 kW)	1985.11-1987.04	MT/AT			F	Coupe Engine ET3/ET4	GC081001	Outer Joint		26	32	49	78.5	54.5	M			
1.8 EX (77 kW)	1983.11-1987.04	MT/AT			F	Coupe Engine ET2/ET3	GC081001	Outer Joint		26	32	49	78.5	54.5	M			
<b>PRELUDE III (BA)</b>																		
2.0 (84 kW)	1987.08-1992.01	MT/AT			F	Coupe Engine B20A4	GC023016	Outer Joint		26	32	55	78.5	56.5	M			
	1987.08-1992.01	MT/AT			F	Coupe Engine B20A4	GC023013	Outer Joint		28	32	60	88	59	M			
	1987.08-1992.01	MT/AT			F	Coupe Engine B20A4	GC023014	Outer Joint	50T	28	32	60	88	59	M			
2.0 EX (80 kW)	1987.04-1992.01	MT/AT			F	Coupe Engine B20A3	GC023016	Outer Joint		26	32	55	78.5	56.5	M			
	1987.04-1992.01	MT/AT			F	Coupe Engine B20A3	GC023013	Outer Joint		28	32	60	88	59	M			
	1987.04-1992.01	MT/AT			F	Coupe Engine B20A3	GC023014	Outer Joint	50T	28	32	60	88	59	M			
2.0 i EX 16V (103 kW)	1990.04-1992.01	MT/AT			F	Coupe Engine B20A9	GC023013	Outer Joint		28	32	60	88	59	M			
	1990.04-1992.01	MT/AT			F	Coupe Engine B20A9	GC023014	Outer Joint	50T	28	32	60	88	59	M			
2.0 i EX 16V (110 kW)	1987.10-1990.12	MT/AT			F	Coupe Engine B20A7	GC023016	Outer Joint		26	32	55	78.5	56.5	M			

		TRANSM	L/R	F/R		G-AP Ref.	PRODUCT	ABS	Technical Specifications							
									YEAR	A	B	C	H	L	P	
<b>HONDA</b>																
<b>PRELUDE III (BA)</b>																
2.0 i EX 16V CAT (101 kW)	1987.04-	1992.01	MT/AT		F Coupe Engine B20A5	GC023016	Outer Joint		26	32	55	78.5	56.5	M		
	1987.04-	1992.01	MT/AT		F Coupe Engine B20A5	GC023013	Outer Joint		28	32	60	88	59	M		
	1987.04-	1992.01	MT/AT		F Coupe Engine B20A5	GC023014	Outer Joint	50T	28	32	60	88	59	M		
<b>PRELUDE IV (BB)</b>																
2.0 i 16V (98 kW)	1992.02-	1996.09	MT/AT		F Coupe Engine F20A4	GC023013	Outer Joint		28	32	60	88	59	M		
	1992.02-	1996.09	MT/AT		F Coupe Engine F20A4	GC023014	Outer Joint	50T	28	32	60	88	59	M		
2.2 i 16V VTEC (136 kW)	1993.02-	1996.09	MT/AT		F Coupe Engine H22A2	GC023013	Outer Joint		28	32	60	88	59	M		
	1993.02-	1996.09	MT/AT		F Coupe Engine H22A2	GC023014	Outer Joint	50T	28	32	60	88	59	M		
<b>QUINTET (SU)</b>																
1.6 EX (59 kW)	1980.02-	1984.12	MT/AT		F Hatchback Engine EL	GC023003	Outer Joint		23	22	45	78	55	M		
	1980.02-	1984.12	MT/AT			GC024002	Outer Joint	29T	25	22	50	95	58	M		
<b>RAFAGA (CE4)</b>																
2.0	1993.10-	1997.09	MT/AT		Engine G20A	GC023015	Outer Joint		28	32	60	89	60	M		
<b>RAFAGA (CE5)</b>																
2.5	1993.10-	1997.09	AT		Engine G25A	GC023015	Outer Joint		28	32	60	89	60	M		
<b>S-MX (RH)</b>																
2.0	1996.11-	2002.01	4AT		Engine B20B	GC023035	Outer Joint		28	32	64	89	60	M		
	1996.11-	2002.01	4AT		Engine B20B	GC023029	Outer Joint	50T	28	32	64	89	60	M		
2.0 4WD	1996.11-	2002.01	4AT		Engine B20B	GC023035	Outer Joint		28	32	64	89	60	M		
	1996.11-	2002.01	4AT		Engine B20B	GC023029	Outer Joint	50T	28	32	64	89	60	M		
<b>SHUTTLE (RA)</b>																
2.2 16V (110 kW)	1994.10-	1998.02	MT/AT		F MPV Engine F22B8	GC023059	Outer Joint		28	32	64	88.5	62	M		
	1994.10-	1998.02	MT/AT		F MPV Engine F22B8	GC023032	Outer Joint	50T	28	32	64	88.5	62	M		
3.0 4x4 (154 kW)	1997.10	2002.06	AT		R MPV Engine J30A	GCI23069	Inner Joint		23	25	35	60	94.5			
<b>STREAM</b>																
1.7				L		GDS23072	Drive Shaft	50T	26	25	60	78.5	610			
				R		GDS23073	Drive Shaft	50T	26	25	60	78.5	906			
2.0				L		GCI23017	Inner Joint		27	30	40	58.5	97			
				L		GDS24035	Drive Shaft	50T	26	27	60	78.5	615			
				R		GCI23019	Inner Joint		27	30	28.5	398.5	124.5			
				R		GDS24036	Drive Shaft	50T	26	27	60	78.5	905			
<b>STREAM (RN)</b>																
1.7 16V (92 kW)	2001.05-				F MPV Engine D17A2	GC023118	Outer Joint	50T	28	32	64	88.5	62	M		
2.0 16V (115 kW)	2001.05-				F MPV Engine K20A1	GC023118	Outer Joint	50T	28	32	64	88.5	62	M		
<b>TODAY</b>																
-	1988.03-					GC023098	Outer Joint		23	19	49	73	47.5	I		
	1990.03-					GC023098	Outer Joint		23	19	49	73	47.5	I		
<b>TODAY (JA1)</b>																
550	1988.03-	1990.03	MT/AT		Engine E05A	GC023099	Outer Joint		23	21	49	72	49	I		
<b>TODAY (JA2)</b>																
660	1990.03-	1992.12	MT/AT		Engine E07A	GC023099	Outer Joint		23	21	49	72	49	I		
<b>TODAY (JA3)</b>																
660 4WD	1990.03-	1992.12	MT/AT		Engine E07A	GC023099	Outer Joint		23	21	49	72	49	I		
<b>TODAY (JA4)</b>																
660	1993.01-	1996.02	MT&AT		Engine E07A	GC023099	Outer Joint		23	21	49	72	49	I		
<b>TODAY (JA5)</b>																
660 4WD	1993.01-	1996.02	MT/AT		Engine E07A	GC023099	Outer Joint		23	21	49	72	49	I		
<b>TODAY (JW2)</b>																
550	1988.02-	1990.03	MT/AT		Engine E05A	GC023099	Outer Joint		23	21	49	72	49	I		
<b>TODAY (JW3)</b>																
660	1990.03-		MT/AT		Engine E07A	GC023099	Outer Joint		23	21	49	72	49	I		
<b>TODAY (JW4)</b>																
660 4WD	1990.03-		MT/AT		Engine E07A	GC023099	Outer Joint		23	21	49	72	49	I		
<b>TORNEO (CL1)</b>																
2.2	2000.06-	2002.10	5MT/F		Engine H22A DOHC	GC023029	Outer Joint	50T	28	32	64	89	60	M		
<b>U.S CIVIC (EJ1)</b>																
1.6	1993.02-	1996.01	4AT		Engine D16A	GC023019	Outer Joint		26	30	55	78.5	56	M		
<b>VIGOR</b>																
2.5 (CC2)	1992.01-	1995.02	AT		Engine G25A	GC023028	Outer Joint		28	34	60	89	60	M		
<b>VIGOR (CB5)</b>																
2.0	1989.10-	1995.02	MT/AT		Engine G20A	GC023015	Outer Joint		28	32	60	89	60	M		









		TRANSM	L/R	F/R		G-AP Ref.	PRODUCT	ABS	Technical Specifications									
									YEAR	A	B	C	H	L	P			
<b>HONDA</b> <b>VIGOR (CC3)</b>																		
2.0	1992.01-	1995.02	AT		Engine G20A	GC023015	Outer Joint		28	32	60	89	60	M				
<b>HUMMER</b> <b>H2</b>																		
-	2003-	2005				GC039029	Outer Joint		33	41	80	112	88.5	O				
<b>HYUNDAI</b> <b>ACCENT</b>																		
-						GCI24009	Inner Joint		25	22	35	54.5	87					
						GC099164	Outer Joint		25	30	49.9	94.5	56	O				
				L		GDS24028	Drive Shaft		25	25	50	95	617.5					
				R		GDS24029	Drive Shaft		25	25	50	95	902					
	1995-	1999		L		GDS24009	Drive Shaft		25	25	50	95	613					
	1999-	2002	MT			GC039105	Outer Joint	44T	25	22	52.5	95	58	M				
1.4 2WD	2010-	2013	4AT	L	GAMMA > DOHC - MPI	GDS24260	Drive Shaft		25	25	52.5	93.5	652					
	2010-	2013	5MT	L	GAMMA > DOHC - MPI	GDS24260	Drive Shaft		25	25	52.5	93.5	652					
	2010-	2013	5MT/4AT	L	GAMMA	GDS24246	Drive Shaft	48T	25	25	52.5	93.5	652					
	2010-	2013	5MT/4AT	L	GAMMA	GC024131	Outer Joint	48T	25	22	52.5	93.5	59.5	M				
	2010-	2013	4AT	R	GAMMA > DOHC - MPI	GDS24259	Drive Shaft		25	25	52.5	93.5	927					
	2010-	2013	4AT	R	GAMMA > DOHC - MPI	GC024136	Outer Joint		25	22	52.5	93.5	59.5	M				
	2010-	2013	5MT	R	GAMMA > DOHC - MPI	GDS24259	Drive Shaft		25	25	52.5	93.5	927					
	2010-	2013	5MT	R	GAMMA > DOHC - MPI	GC024136	Outer Joint		25	22	52.5	93.5	59.5	M				
	2010-	2013	5MT/4AT	R	GAMMA	GDS24247	Drive Shaft	48T	25	25	52.5	93.5	927					
	2011-	2013	6MT	L	U2 > DOHC - TCI	GDS24290	Drive Shaft	48T	25	27	52.5	94.5	647					
	2011-	2013	6MT	L	U2 > DOHC - TCI	GC024163	Outer Joint	48T	25	24	52.5	94.5	64	M				
	2011-	2013	6MT	L	U2 > DOHC - TCI	GCI27043	Inner Joint		27	24	41	61.5	91					
	2011-	2013	6MT	R	U2 > DOHC - TCI	GDS24291	Drive Shaft	48T	25	27	52.5	94.5	930					
1.4/1.6	2006-			L		GDS24043	Drive Shaft		25	25	52.5	95	640					
	2006-			R		GDS24044	Drive Shaft	48T	25	25	52.5	95	924					
1.5	1994-			L		GDS24018	Drive Shaft		25	25	50	95	614					
	1994-			R		GDS24019	Drive Shaft		25	25	50	95	909					
1.5 CRDi	2006-			L		GDS24045	Drive Shaft		25	27	50	94.5	633					
	2006-			R		GDS24046	Drive Shaft	48T	25	26	50	94.5	588					
	2006-			L/R		GC024026	Outer Joint		25	23	50	94.5	63.5	M				
1.5/1.6 2WD	1999-	2001	4AT	L	MPI-SOHC	GDS39213	Drive Shaft	44T	25	25	52.5	95	625					
	1999-	2001	4AT	L	MPI-SOHC	GCI24010	Inner Joint		25	22	35	63	87					
	1999-	2001	5MT	L	MPI-SOHC	GDS39211	Drive Shaft	44T	25	25	52.5	95	622					
	1999-	2001	5MT	L	MPI-SOHC	GC039105	Outer Joint	44T	25	22	52.5	95	58	M				
	1999-	2001	4AT	R	MPI-SOHC	GDS39212	Drive Shaft	44T	25	25	52.5	95	911					
	1999-	2001	5MT	R	MPI-SOHC	GDS39214	Drive Shaft	44T	25	25	52.5	95	912					
1.6 2WD	2010-	2014	5MT	L	GAMMA > DOHC - MPI	GDS24260	Drive Shaft		25	25	52.5	93.5	652					
	2010-	2013	4AT	L	GAMMA > DOHC - MPI	GDS24260	Drive Shaft		25	25	52.5	93.5	652					
	2010-	2013	5MT/4AT	L	GAMMA	GDS24246	Drive Shaft	48T	25	25	52.5	93.5	652					
	2010-	2013	5MT/4AT	L	GAMMA	GC024131	Outer Joint	48T	25	22	52.5	93.5	59.5	M				
	2010-	2013	4AT	R	GAMMA > DOHC - MPI	GDS24259	Drive Shaft		25	25	52.5	93.5	927					
	2010-	2013	4AT	R	GAMMA > DOHC - MPI	GC024136	Outer Joint		25	22	52.5	93.5	59.5	M				
	2010-	2013	5MT	R	GAMMA > DOHC - MPI	GDS24259	Drive Shaft		25	25	52.5	93.5	927					
	2010-	2013	5MT	R	GAMMA > DOHC - MPI	GC024136	Outer Joint		25	22	52.5	93.5	59.5	M				
	2010-	2013	5MT/4AT	R	GAMMA	GDS24247	Drive Shaft	48T	25	25	52.5	93.5	927					
	2011-	2012	4AT	L	U2 > DOHC - TCI	GDS24294	Drive Shaft	48T	25	27	52.5	94.5	646					
	2011-	2012	4AT	R	U2 > DOHC - TCI	GDS24293	Drive Shaft	48T	25	27	52.5	94.5	929					
	2011-	2013	6MT	L	U2 > DOHC - TCI	GDS24290	Drive Shaft	48T	25	27	52.5	94.5	647					
	2011-	2013	6MT	L	U2 > DOHC - TCI	GC024163	Outer Joint	48T	25	24	52.5	94.5	64	M				
	2011-	2013	6MT	L	U2 > DOHC - TCI	GCI27043	Inner Joint		27	24	41	61.5	91					
	2011-	2013	6MT	R	U2 > DOHC - TCI	GDS24291	Drive Shaft	48T	25	27	52.5	94.5	930					
<b>ACCENT (LC)</b>																		
1.3 (55 kW)	2000.01-	2005.11		L	F	Saloon Engine G4EA	GDS24147	Drive Shaft	44T	25	25	50	95	627				
	2000.01-	2005.11		R	F	Saloon Engine G4EA	GDS24129	Drive Shaft		25	25	52.5	95	908.5				
	2000.01-	2005.11		R	F	Saloon Engine G4EA	GDS24148	Drive Shaft	44T	25	25	50	95	908				
	2000.01-	2005.11		R	F	Saloon Engine G4EA	GCI24009	Inner Joint		25	22	35	54.5	87				
	2000.01-	2005.11		R	F	Saloon Engine G4EA	GC024033	Outer Joint	44T	25	22	50	95	58	M			
1.3 (63 kW)	2000.01-	2005.11		L	F	Saloon Engine G4EA	GDS24147	Drive Shaft	44T	25	25	50	95	627				
	2000.01-	2005.11		R	F	Saloon Engine G4EA	GDS24129	Drive Shaft		25	25	52.5	95	908.5				



		TRANSM	L/R	F/R		G-AP Ref.	PRODUCT	ABS	Technical Specifications								
									YEAR	A	B	C	H	L	P		
<b>HYUNDAI ACCENT (LC)</b>																	
1.3 (63 kW)	2000.01-	2005.11															
	2000.01-	2005.11		R	F	Saloon Engine G4EA	GDS24148	Drive Shaft	44T	25	25	50	95	908			
	2000.01-	2005.11		R	F	Saloon Engine G4EA	GCI24009	Inner Joint		25	22	35	54.5	87			
1.5 (66 kW)	2000.01-	2005.11		R	F	Saloon Engine G4EA	GC024033	Outer Joint	44T	25	22	50	95	58	M		
	2000.01-	2005.11		L	F	Saloon Engine G4EB	GDS24147	Drive Shaft	44T	25	25	50	95	627			
	2000.01-	2005.11		R	F	Saloon Engine G4EB	GDS24129	Drive Shaft		25	25	52.5	95	908.5			
	2000.01-	2005.11		R	F	Saloon Engine G4EB	GDS24148	Drive Shaft	44T	25	25	50	95	908			
	2000.01-	2005.11		R	F	Saloon Engine G4EB	GCI24009	Inner Joint		25	22	35	54.5	87			
	2000.01-	2005.11		R	F	Saloon Engine G4EB	GC024033	Outer Joint	44T	25	22	50	95	58	M		
	2000.01-	2005.11		R	F	Saloon Engine G4EB	GC024033	Outer Joint	44T	25	22	50	95	58	M		
1.5 CRDi (60 kW)	2002.01-	2005.11															
1.6 (77 kW)	2003.02-	2006.08															
	2003.02-	2006.08		F		Saloon Engine G4ED-G	GC027076	Outer Joint	44T	25	22	50	95	58	M		
1.6 (77 kW)	2003.02-	2006.08	MT														
	2003.02-	2006.08	MT		F	Saloon Engine G4ED-G	GC024065	Outer Joint	44T	25	22	52.5	95	58	M		
<b>ACCENT (MC)</b>																	
1.4 GL (71 kW)	2005.11-	2010.11															
1.5 CRDi GLS (81 kW)	2005.11-	2010.11															
1.6 GLS (82 kW)	2005.11-	2010.11															
<b>ACCENT (X-3)</b>																	
1.3 (44 kW)	1994.10-	2000.01															
	1994.10-	2000.01		R	F	Saloon Engine G4EH	GC024002	Outer Joint	29T	25	22	50	95	58	M		
	1994.10-	2000.01		R	F	Saloon Engine G4EH	GDS24023	Drive Shaft		25	25	50	95	904			
1.3 (55 kW)	1994.10-	2000.01		L	F	Saloon Engine G4EH	GDS24022	Drive Shaft		25	25	50	95	610			
	1994.10-	2000.01		F		Saloon Engine G4EH	GC024002	Outer Joint	29T	25	22	50	95	58	M		
	1994.10-	2000.01		R	F	Saloon Engine G4EH	GDS24023	Drive Shaft		25	25	50	95	904			
1.3 i 12V (62 kW)	1994.10-	2000.01		L	F	Saloon Engine G4EH	GDS24022	Drive Shaft		25	25	50	95	610			
	1994.10-	2000.01		F		Saloon Engine G4EH	GC024002	Outer Joint	29T	25	22	50	95	58	M		
	1994.10-	2000.01		R	F	Saloon Engine G4EH	GDS24023	Drive Shaft		25	25	50	95	904			
1.5 i 12V (65 kW)	1994.10-	2000.01		L	F	Saloon Engine G4EH	GDS24022	Drive Shaft		25	25	50	95	610			
	1994.10-	2000.01		R	F	Saloon Engine G4EK	GDS24023	Drive Shaft		25	25	50	95	904			
	1994.10-	2000.01		L	F	Saloon Engine G4EK	GDS24022	Drive Shaft		25	25	50	95	610			
1.5 i 16V (73 kW)	1994.10-	2000.01		F		Saloon Engine G4EK	GDS24022	Drive Shaft		25	25	50	95	610			
	1995.10-	2000.01		F		Saloon Engine G4ER	GC024002	Outer Joint	29T	25	22	50	95	58	M		
	1995.10-	2000.01		R	F	Saloon Engine G4ER	GDS24023	Drive Shaft		25	25	50	95	904			
1.5 i 16V (73 kW)	1995.10-	2000.01		L	F	Saloon Engine G4ER	GDS24022	Drive Shaft		25	25	50	95	610			
	1995.10-	2000.01		L	F	Saloon Engine G4ER	GDS24022	Drive Shaft		25	25	50	95	610			
<b>ACCENT ADMIRE</b>																	
1.3	2003-	2006															
1.5	2003-	2006															
1.5 CRDi	2003-	2006		R	F		GDS24002	Drive Shaft		25	25	50	95	908			
	2003-	2006		L	F		GDS39122	Drive Shaft	44T	25	25	50	94.5	618			
	2003-	2006		L/R	F		GC039063	Outer Joint	47T	25	23	50	94.5	63.5	M		
	2003-	2006		R	F		GDS39123	Drive Shaft	44T	25	26	50	94.5	572			
	2003-	2006		L	F		GC039128	Outer Joint	44T	25	23	50	94.5	63.5	M		
	2003-	2006		R	F		GCI24031	Inner Joint		26	23	42	40	68			
1.6	2003-	2006		R	F		GC039128	Outer Joint	44T	25	23	50	94.5	63.5	M		
1.6	2003-	2006		R	F		GDS24002	Drive Shaft		25	25	50	95	908			
<b>ACCENT ERA</b>																	
1.4	2006-																
	2006-			L	F		GDS24188	Drive Shaft	48T	25	25	52.5	95	640			
1.5 CRDi	2006-			L	F		GC024025	Outer Joint		25	22	52.5	95	58	M		
	2006-			L	F		GCI24013	Inner Joint		27	33	41	61.5	107			
	2006-			L/R	F		GC024026	Outer Joint		25	23	50	94.5	63.5	M		
	2006-			R	F		GCI24014	Inner Joint		26	33	42	42	82			
1.6	2006-			L	F		GDS24188	Drive Shaft	48T	25	25	52.5	95	640			
	2006-			L	F		GC024025	Outer Joint		25	22	52.5	95	58	M		
<b>ACCENT GETZ</b>																	
1.3	2002-	2005															
<b>ACCENT I (X-3)</b>																	
1.3 (44 kW)	1994.10-	2000.01															
	1994.10-	2000.01		F		Hatchback Engine G4EH	GC024002	Outer Joint	29T	25	22	50	95	58	M		
	1994.10-	2000.01		L	F	Hatchback Engine G4EH	GDS24022	Drive Shaft		25	25	50	95	610			
1.3 (55 kW)	1994.10-	2000.01		R	F	Hatchback Engine G4EH	GDS24023	Drive Shaft		25	25	50	95	904			
	1994.10-	2000.01		F		Hatchback Engine G4EH	GC024002	Outer Joint	29T	25	22	50	95	58	M		
	1994.10-	2000.01		L	F	Hatchback Engine G4EH	GDS24022	Drive Shaft		25	25	50	95	610			
1.3 i 12V (62 kW)	1994.10-	2000.01		R	F	Hatchback Engine G4EH	GDS24023	Drive Shaft		25	25	50	95	904			
	1994.10-	2000.01		F		Hatchback Engine G4EH	GC024002	Outer Joint	29T	25	22	50	95	58	M		
	1994.10-	2000.01		L	F	Hatchback Engine G4EH	GDS24022	Drive Shaft		25	25	50	95	610			
1.3 i 12V (62 kW)	1994.10-	2000.01		R	F	Hatchback Engine G4EH	GDS24023	Drive Shaft		25	25	50	95	904			
	1994.10-	2000.01		R	F	Hatchback Engine G4EH	GDS24023	Drive Shaft		25	25	50	95	904			

		TRANSM	L/R	F/R		G-AP Ref.	PRODUCT	ABS	Technical Specifications						
									YEAR	A	B	C	H	L	P
<b>HYUNDAI</b>															
<b>ACCENT I (X-3)</b>															
1.5 i 12V (65 kW)	1994.10-	2000.01			F	Hatchback Engine G4EK	GC024002	Outer Joint	29T	25	22	50	95	58	M
	1994.10-	2000.01		L	F	Hatchback Engine G4EK	GDS24022	Drive Shaft		25	25	50	95	610	
	1994.10-	2000.01		R	F	Hatchback Engine G4EK	GDS24023	Drive Shaft		25	25	50	95	904	
	1994.10-	2000.01			F	Hatchback Engine G4EK	GC089004	Outer Joint		25	22	50	95	58	M
1.5 i 16V (73 kW)	1995.12-	2000.01			F	Hatchback Engine G4ER	GC024002	Outer Joint	29T	25	22	50	95	58	M
	1995.12-	2000.01		L	F	Hatchback Engine G4ER	GDS24022	Drive Shaft		25	25	50	95	610	
	1995.12-	2000.01		R	F	Hatchback Engine G4ER	GDS24023	Drive Shaft		25	25	50	95	904	
	1995.12-	2000.01			F	Hatchback Engine G4ER	GC089004	Outer Joint		25	22	50	95	58	M
<b>ACCENT II</b>															
-	2011-						GCI39052	Inner Joint		25	22	41	63	86	
1.3	2000.01-			L			GC099172	Outer Joint		25	22	52.5	95	58	M
	2000.01-		MT		F		GC024016	Outer Joint		25	22	50	95	58	M
	2000.01-			L			GDS24038	Drive Shaft		25	25	52.5	95	622	
1.5	2000.01-			L			GC099172	Outer Joint		25	22	52.5	95	58	M
	2000.01-			L			GDS24038	Drive Shaft		25	25	52.5	95	622	
1.5 Sohc	2000.01-	2002.12	AT		F		GC024033	Outer Joint	44T	25	22	50	95	58	M
	2000.01-	2002.12	MT		F		GC024033	Outer Joint	44T	25	22	50	95	58	M
<b>ACCENT II (LC)</b>															
1.3 (55 kW)	2000.01-	2005.11		L	F	Hatchback Engine G4EA	GDS24147	Drive Shaft	44T	25	25	50	95	627	
	2000.01-	2005.11		R	F	Hatchback Engine G4EA	GDS24129	Drive Shaft		25	25	52.5	95	908.5	
	2000.01-	2005.11		R	F	Hatchback Engine G4EA	GDS24148	Drive Shaft	44T	25	25	50	95	908	
	2000.01-	2005.11		R	F	Hatchback Engine G4EA	GCI24009	Inner Joint		25	22	35	54.5	87	
	2000.01-	2005.11		R	F	Hatchback Engine G4EA	GC024033	Outer Joint	44T	25	22	50	95	58	M
1.3 (61 kW)	2000.01-	2005.11		L	F	Hatchback Engine G4EA	GDS24147	Drive Shaft	44T	25	25	50	95	627	
	2000.01-	2005.11		R	F	Hatchback Engine G4EA	GDS24129	Drive Shaft		25	25	52.5	95	908.5	
	2000.01-	2005.11		R	F	Hatchback Engine G4EA	GDS24148	Drive Shaft	44T	25	25	50	95	908	
	2000.01-	2005.11		R	F	Hatchback Engine G4EA	GCI24009	Inner Joint		25	22	35	54.5	87	
1.3 (62 kW)	2000.01-	2005.11		R	F	Hatchback Engine G4EA	GC024033	Outer Joint	44T	25	22	50	95	58	M
	2003.02-	2006.02		R	F	Hatchback Engine G4EH	GDS24129	Drive Shaft		25	25	52.5	95	908.5	
	2000.01-	2005.11		L	F	Hatchback Engine G4EA	GDS24147	Drive Shaft	44T	25	25	50	95	627	
	2000.01-	2005.11		R	F	Hatchback Engine G4EA	GDS24129	Drive Shaft		25	25	52.5	95	908.5	
1.3 (63 kW)	2000.01-	2005.11		R	F	Hatchback Engine G4EA	GDS24148	Drive Shaft	44T	25	25	50	95	908	
	2000.01-	2005.11		R	F	Hatchback Engine G4EA	GC024033	Outer Joint	44T	25	22	50	95	58	M
	2000.01-	2005.11		R	F	Hatchback Engine G4EA	GCI24009	Inner Joint		25	22	35	54.5	87	
	2000.01-	2005.11		R	F	Hatchback Engine G4EA	GC024033	Outer Joint	44T	25	22	50	95	58	M
	1999.09-	2002.10		L	F	Hatchback Engine G4EK	GDS24147	Drive Shaft	44T	25	25	50	95	627	
1.5 (65 kW)	1999.09-	2002.10		R	F	Hatchback Engine G4EK	GDS24148	Drive Shaft	44T	25	25	50	95	908	
	1999.09-	2002.10		R	F	Hatchback Engine G4EK	GCI24009	Inner Joint		25	22	35	54.5	87	
	1999.09-	2002.10		R	F	Hatchback Engine G4EK	GC024033	Outer Joint	44T	25	22	50	95	58	M
	1999.09-	2002.10		R	F	Hatchback Engine G4EK	GC024033	Outer Joint	44T	25	22	50	95	58	M
1.5 (66 kW)	2000.01-	2005.11			F	Hatchback Engine G4EB	GC027076	Outer Joint	44T	25	22	50	95	58	M
	2000.01-	2005.11	AT		F	Hatchback Engine G4EB	GC024065	Outer Joint	44T	25	22	52.5	95	58	M
	2000.01-	2005.11		L	F	Hatchback Engine G4EB	GDS24147	Drive Shaft	44T	25	25	50	95	627	
	2000.01-	2005.11		R	F	Hatchback Engine G4EB	GDS24129	Drive Shaft		25	25	52.5	95	908.5	
	2000.01-	2005.11		R	F	Hatchback Engine G4EB	GDS24148	Drive Shaft	44T	25	25	50	95	908	
	2000.01-	2005.11		R	F	Hatchback Engine G4EB	GCI24009	Inner Joint		25	22	35	54.5	87	
	2000.01-	2005.11		R	F	Hatchback Engine G4EB	GC024033	Outer Joint	44T	25	22	50	95	58	M
1.5 (75 kW)	2000.09-	2005.11			F	Hatchback Engine G4EC-G	GC027076	Outer Joint	44T	25	22	50	95	58	M
	2000.09-	2005.11	AT		F	Hatchback Engine G4EC-G	GC024065	Outer Joint	44T	25	22	52.5	95	58	M
	2000.09-	2005.11		L	F	Hatchback Engine G4EC-G	GDS24147	Drive Shaft	44T	25	25	50	95	627	
	2000.09-	2005.11		R	F	Hatchback Engine G4EC-G	GDS24129	Drive Shaft		25	25	52.5	95	908.5	
	2000.09-	2005.11		R	F	Hatchback Engine G4EC-G	GDS24148	Drive Shaft	44T	25	25	50	95	908	
	2000.09-	2005.11		R	F	Hatchback Engine G4EC-G	GCI24009	Inner Joint		25	22	35	54.5	87	
1.5 CRDi (60 kW)	2000.09-	2005.11		R	F	Hatchback Engine G4EC-G	GC024033	Outer Joint	44T	25	22	50	95	58	M
	2002.04-	2005.11			F	Hatchback Engine D3-EA	GC027076	Outer Joint	44T	25	22	50	95	58	M
1.6 (77 kW)	2002.12-	2005.11			F	Hatchback Engine G4ED-G	GC027076	Outer Joint	44T	25	22	50	95	58	M
	2002.12-	2005.11	MT		F	Hatchback Engine G4ED-G	GC024065	Outer Joint	44T	25	22	52.5	95	58	M
<b>ACCENT III (MC)</b>															
1.4 GL (71 kW)	2005.11-	2010.11			F	Hatchback Engine G4EE	GC027076	Outer Joint	44T	25	22	50	95	58	M
1.5 CRDi (81 kW)	2006-						GC024047	Outer Joint	48T	25	23	50	94.5	63.5	M
1.5 CRDi GLS (81 kW)	2005.11-	2010.11			F	Hatchback Engine D4FA	GC027076	Outer Joint	44T	25	22	50	95	58	M
1.6 GLS (82 kW)	2005.11-	2010.11			F	Hatchback Engine G4ED	GC027076	Outer Joint	44T	25	22	50	95	58	M
<b>ACCENT MILENIUM</b>															
1.3	2000-	2003		R	F		GDS24002	Drive Shaft		25	25	50	95	908	







		TRANSM	L/R	F/R		G-AP Ref.	PRODUCT	ABS	Technical Specifications								
									YEAR	A	B	C	H	L	P		
<b>HYUNDAI</b>																	
<b>ACCENT MILENIUM</b>																	
1.5	2000-2003			R F		GDS24002	Drive Shaft		25	25	50	95	908				
1.6	2000-2003			R F		GDS24002	Drive Shaft		25	25	50	95	908				
<b>AMICA (MX)</b>																	
1.0 i (43 kW)	2001.03-			F	Hatchback Engine G4HC-E	GC099025	Outer Joint		25	20	50	94.5	52.5	I			
	2001.03-		MT/AT	F	Hatchback Engine G4HC-E	GC024011	Outer Joint		25	19	50	94.5	52.5	M			
	2001.03-		MT/AT	F	Hatchback Engine G4HC-E	GC024004	Outer Joint	38T	25	19	50	94.5	52.5	M			
	2001.03-		AT	L F	Hatchback Engine G4HC-E	GDS27017	Drive Shaft	38T	25	22	50	94.5	570				
	2001.03-		AT	L F	Hatchback Engine G4HC-E	GCI24002	Inner Joint		22	19	35	52	86				
	2001.03-		AT	L F	Hatchback Engine G4HC-E	GC024004	Outer Joint	38T	25	19	50	94.5	52.5	M			
	2001.03-			L F	Hatchback Engine G4HC-E	GDS24034	Drive Shaft	38T	25	22	50	94.5	596				
	2001.03-		AT	R F	Hatchback Engine G4HC-E	GDS24033	Drive Shaft	38T	25	22	50	94.5	844				
<b>AMICA / ATOZ (MX)</b>																	
1.0 i (40 kW)	1998.02-	2002.03	MT/AT	F	Hatchback Engine G4HC	GC024011	Outer Joint		25	19	50	94.5	52.5	M			
	1998.02-	2002.03	MT/AT	F	Hatchback Engine G4HC	GC024004	Outer Joint	38T	25	19	50	94.5	52.5	M			
	1998.02-	2002.03	MT/AT	F	Hatchback Engine G4HC	GC099025	Outer Joint		25	20	50	94.5	52.5	I			
	1998.02-	2002.03	AT	L F	Hatchback Engine G4HC	GDS27017	Drive Shaft	38T	25	22	50	94.5	570				
	1998.02-	2002.03	AT	L F	Hatchback Engine G4HC	GCI24002	Inner Joint		22	19	35	52	86				
	1998.02-	2002.03	AT	L F	Hatchback Engine G4HC	GC024004	Outer Joint	38T	25	19	50	94.5	52.5	M			
	1998.02-	2002.03		L F	Hatchback Engine G4HC	GDS24034	Drive Shaft	38T	25	22	50	94.5	596				
	1998.02-	2002.03	AT	R F	Hatchback Engine G4HC	GDS24033	Drive Shaft	38T	25	22	50	94.5	844				
	1998.02-	2002.03	MT	R F	Hatchback Engine G4HC	GDS24104	Drive Shaft		25	22	50	94.5	809				
	1998.02-	2002.03	MT	R F	Hatchback Engine G4HC	GC024011	Outer Joint		25	19	50	94.5	52.5	M			
1.0 i (43 kW)	2001.03-			F	Hatchback Engine G4HC-E	GC099025	Outer Joint		25	20	50	94.5	52.5	I			
	2001.03-		MT/AT	F	Hatchback Engine G4HC-E	GC024011	Outer Joint		25	19	50	94.5	52.5	M			
	2001.03-		MT/AT	F	Hatchback Engine G4HC-E	GC024004	Outer Joint	38T	25	19	50	94.5	52.5	M			
	2001.03-		AT	L F	Hatchback Engine G4HC-E	GDS27017	Drive Shaft	38T	25	22	50	94.5	570				
	2001.03-		AT	L F	Hatchback Engine G4HC-E	GCI24002	Inner Joint		22	19	35	52	86				
	2001.03-		AT	L F	Hatchback Engine G4HC-E	GC024004	Outer Joint	38T	25	19	50	94.5	52.5	M			
	2001.03-			L F	Hatchback Engine G4HC-E	GDS24034	Drive Shaft	38T	25	22	50	94.5	596				
	2001.03-		AT	R F	Hatchback Engine G4HC-E	GDS24033	Drive Shaft	38T	25	22	50	94.5	844				
1.1 (43 kW)	2003.08-	2005.05			Hatchback Engine G4HD	GC024159	Outer Joint	38T	25	20	50	94.5	56	I			
1.1 (46 kW)	2004.03-				Hatchback Engine G4HC	GC024159	Outer Joint	38T	25	20	50	94.5	56	I			
<b>ATOS</b>																	
-						GC024018	Outer Joint		25	19	52.5	95	52	M			
1.0			MT/AT			GC024005	Outer Joint		25	19	50	96	52	M			
	2000-	2004	MT			GCI24002	Inner Joint		22	19	35	52	86				
<b>ATOS (MX)</b>																	
1.0 i (41 kW)	1998.02-	2002.03		L F	Hatchback Engine G4HC	GDS24034	Drive Shaft	38T	25	22	50	94.5	596				
1.1 (45 kW)	2006.03-				Hatchback Engine G4HG	GC024159	Outer Joint	38T	25	20	50	94.5	56	I			
<b>ATOS PRIME (MX)</b>																	
1.1 (43 kW)	2003.06-		MT/AT	F	Hatchback Engine G4HD	GC024011	Outer Joint		25	19	50	94.5	52.5	M			
	2003.06-		MT/AT	F	Hatchback Engine G4HD	GC024004	Outer Joint	38T	25	19	50	94.5	52.5	M			
	2003.06-				Hatchback Engine G4HD	GC024159	Outer Joint	38T	25	20	50	94.5	56	I			
1.1 (46 kW)	2005.09-				Hatchback Engine G4HG	GC024159	Outer Joint	38T	25	20	50	94.5	56	I			
<b>ATOS PRIME I (MX)</b>																	
1.1 12V (46 kW)	2004.03-					GC024014	Outer Joint		25	20	50	94.5	56	I			
	2004.03-					GC024099	Outer Joint	38T	25	20	50	94.5	56	I			
<b>AVEO</b>																	
1.5	2006.01-		MT/AT			GC012049	Outer Joint		22	22	52	95.5	53.5	O			
<b>AZERA</b>																	
-	2006-			L		GDS24127	Drive Shaft	47T	30	28	65	95	662				
	2006-			R		GDS24128	Drive Shaft	47T	30	28	65	95	981.5				
2.4 2WD	2010-	2014	6AT	L	THETA 2	GDS24262	Drive Shaft	48T	27	27	62	92.5	672				
	2010-	2014	6AT	L	THETA 2	GC024138	Outer Joint	48T	27	25	62	92.5	61	M			
	2010-	2014	6AT	L	THETA 2	GCI24056	Inner Joint		27	25	30	67	83.5				
	2010-	2014	6AT	R	THETA 2	GDS24261	Drive Shaft	48T	27	27	62	92.5	970				
2.7 2WD	2006-	2010	5AT	L	MU > DOHC - MPI	GDS24143	Drive Shaft	47T	27	27	62	94.5	666				
	2006-	2010	5AT	R	MU > DOHC - MPI	GDS24142	Drive Shaft	47T	27	28	62	94.5	974				
2.7 V6	2007-		AT	L		GDS24143	Drive Shaft	47T	27	27	62	94.5	666				
	2007-		AT	R		GDS24142	Drive Shaft	47T	27	28	62	94.5	974				
3.3	2005-	2010	5AT	L	LAMBDA	GDS24127	Drive Shaft	47T	30	28	65	95	662				
	2005-	2010	5AT	R	LAMBDA	GDS24128	Drive Shaft	47T	30	28	65	95	981.5				



	 YEAR	TRANSM	L/R	F/R		G-AP Ref.	PRODUCT	ABS	Technical Specifications							
									A	B	C	H	L	P		
<b>HYUNDAI CERATO</b>																
1.1	2004.01-					GC099294	Outer Joint	44T	25	22	50	90	60	M		
<b>COUPE</b>																
1.6	2003-2004			L		GDS24364	Drive Shaft	44T	25	25	50	95.5	655			
	2003-2004			L		GC039190	Outer Joint	44T	25	23	50	95.5	60.5	M		
	2003-2004			L		GCI24032	Inner Joint		25	23	35	63	88			
	2003-2004	5MT/4AT	R			GDS24363	Drive Shaft	44T	25	25	50	95.5	936			
<b>COUPE (RD)</b>																
1.6 16V (85 kW)	1998.03-2002.04	MT		F	Coupe Engine G4GR	GDS24113	Drive Shaft	44T	25		50	95.5	554			
	1998.03-2002.04	MT	L	F	Coupe Engine G4GR	GDS24162	Drive Shaft	44T	25	25	50	94.5	643			
	1998.03-2002.04	MT	L/R	F	Coupe Engine G4GR	GCI24049	Inner Joint		25	25	35	63	87.5			
	1998.03-2002.04	MT	L/R	F	Coupe Engine G4GR	GC024024	Outer Joint		25	25	50	94.5	65	M		
	1998.03-2002.04	MT	R	F	Coupe Engine G4GR	GDS24163	Drive Shaft	44T	25	25	50	94.5	928			
	1998.03-2002.04				Coupe Engine G4GR	GC039033	Outer Joint		25	25	50	95	65	M		
<b>COUPE (KG)</b>																
1.6 i 16V DOHC	1998.07-2002.02	5MT/AT	L	F	Engine G4	GDS24113	Drive Shaft	44T	25		50	95.5	554			
<b>COUPE II (GK)</b>																
1.6 16V (77 kW)	2002.03-					GC024044	Outer Joint	29T	25	25	50	94.5	65	M		
2.0 (102 kW)	2002.03-					GC024044	Outer Joint	29T	25	25	50	94.5	65	M		
2.7 V6 (123 kW)	2002.03-					GC024044	Outer Joint	29T	25	25	50	94.5	65	M		
<b>ELANTRA</b>																
-	2007-			L		GDS24077	Drive Shaft	46T	27	27	60	94.5	671			
	2007-			R		GDS24076	Drive Shaft	46T	27	27	60	94.5	940			
1.5	1990-			L		GDS24020	Drive Shaft		25	25	50	95	596.5			
1.6						GC024031	Outer Joint	44T	27	23	60	95	60	M		
			4AT			GC039147	Outer Joint		25	30	50	96	59	M		
				L		GDS24061	Drive Shaft	44T	27	25	60	95	656			
				R		GDS24062	Drive Shaft	44T	27	25	60	95	940			
	2000-2006			L	F	GDS24061	Drive Shaft	44T	27	25	60	95	656			
	2000-2006			L	F	GC024031	Outer Joint	44T	27	23	60	95	60	M		
	2000-2006			R	F	GDS24062	Drive Shaft	44T	27	25	60	95	940			
	2000-2006			R	F	GC024031	Outer Joint	44T	27	23	60	95	60	M		
1.6 2WD	2003-2005	5MT	L			GDS24364	Drive Shaft	44T	25	25	50	95.5	655			
	2003-2005	5MT	L			GC039190	Outer Joint	44T	25	23	50	95.5	60.5	M		
	2003-2005	5MT	L			GCI24032	Inner Joint		25	23	35	63	88			
	2003-2005	5MT	R			GDS24363	Drive Shaft	44T	25	25	50	95.5	936			
	2011-2013	6AT	R		GAMMA	GDS24265	Drive Shaft		27	27	60	95	957			
	2011-2013	6AT	R		GAMMA	GC024144	Outer Joint		27	24	60	95	59	M		
1.8	2000.01-2002.12	MT	L			GDS24059	Drive Shaft	47T	25	25	50	94.5	643			
	2000.01-2002.12	MT	R			GDS24060	Drive Shaft	47T	25	25	50	94.5	927			
1.8 2WD	2011-2013	6AT	R		NU	GDS24265	Drive Shaft		27	27	60	95	957			
	2011-2013	6AT	R		NU	GC024144	Outer Joint		27	24	60	95	59	M		
	2011-2013	6AT	R		NU	GCI24065	Inner Joint		27	22	30	68	77			
	2012-	6MT	L		NU	GDS24248	Drive Shaft	46T	27	27	60	94.5	681			
	2012-	6MT	R		NU	GDS24249	Drive Shaft	46T	27	27	60	94.5	964			
	2012-	6MT	R		NU	GC024132	Outer Joint	46T	27	22	60	94.5	54.5	M		
	2012-	6MT	R		NU	GCI24061	Inner Joint		27	22	41	62	86			
2.0 2WD	2012-2013	6AT	R		NU	GDS24265	Drive Shaft		27	27	60	95	957			
	2012-2013	6AT	R		NU	GC024144	Outer Joint		27	24	60	95	59	M		
	2012-2013	6AT	R		NU	GCI24065	Inner Joint		27	22	30	68	77			
<b>ELANTRA (XD)</b>																
1.6 (77 kW)	2001.01-2004.08				Hatchback Engine G4ED-G	GC039185	Outer Joint	44T	25	23	50	94.5	63.5	M		
	2001.01-2004.08				Saloon Engine G4ED-G	GC039185	Outer Joint	44T	25	23	50	94.5	63.5	M		
1.6 (79 kW)	2000.06-2006.07				Hatchback Engine G4ED-G	GC039185	Outer Joint	44T	25	23	50	94.5	63.5	M		
	2000.06-2006.07				Saloon Engine G4ED-G	GC039185	Outer Joint	44T	25	23	50	94.5	63.5	M		
1.8 (97 kW)	2000.06-					GC024044	Outer Joint	29T	25	25	50	94.5	65	M		
2.0 (102 kW)	2000.06-					GC024044	Outer Joint	29T	25	25	50	94.5	65	M		
2.0 (104 kW)	2000.06-					GC024044	Outer Joint	29T	25	25	50	94.5	65	M		
2.0 (105 kW)	2003.10-					GC024044	Outer Joint	29T	25	25	50	94.5	65	M		
2.0 CRDi (83 kW)	2001.04-2006.07				Hatchback Engine D4EA	GC024060	Outer Joint	44T	27	26	60	95	69	M		
	2001.04-2006.07				Saloon Engine D4EA	GC024060	Outer Joint	44T	27	26	60	95	69	M		
	2001.04-					GC024044	Outer Joint	29T	25	25	50	94.5	65	M		

	 YEAR	TRANSM	L/R	F/R		G-AP Ref.	PRODUCT	ABS	Technical Specifications							
									A	B	C	H	L	P		
<b>HYUNDAI EXCEL</b>																
-						GC099164	Outer Joint		25	30	49.9	94.5	56	O		
<b>EXCEL/SCOUPE</b>																
-	1994-1999			R	X3	GDS24010	Drive Shaft		25	25	50	95	913			
-	1994-1999			L	X3	GDS24009	Drive Shaft		25	25	50	95	613			
<b>GETZ</b>																
1.3/1.6	2003-					GC024025	Outer Joint		25	22	52.5	95	58	M		
1.5 CRDi	2003-2009			L	F	GDS24140	Drive Shaft	48T	25	27	50	94.5	631			
	2003-2009			L/R	F	GC024026	Outer Joint		25	23	50	94.5	63.5	M		
	2003-2009			R	F	GDS24141	Drive Shaft		25	26	50	94.5	579			
	2003-2009			R	F	GC024026	Outer Joint		25	23	50	94.5	63.5	M		
	2003-2009			R	F	GCI24031	Inner Joint		26	23	42	40	68			
<b>GETZ (TB)</b>																
1.1 (46 kW)	2002.09-2007.01					GC024041	Outer Joint	48T	25	19	52.5	95	52.5	M		
	2002.09-2005.09				F Hatchback Engine G4HD	GC024041	Outer Joint	48T	25	19	52.5	95	52.5	M		
	2002.09-2005.09	AT			F Hatchback Engine G4HD	GC024025	Outer Joint		25	22	52.5	95	58	M		
	2002.09-2005.09	MT	L	F	Hatchback Engine G4HD	GDS24200	Drive Shaft	48T	25	25	52.5	95	626			
	2002.09-2005.09	MT	L	F	Hatchback Engine G4HD	GC024098	Outer Joint	48T	25	22	52.5	95	58	M		
	2002.09-2005.09			L/R	F Hatchback Engine G4HD	GC024151	Outer Joint	48T	25	20	52.5	94.5	63	M		
	2002.09-2005.09	MT	R	F	Hatchback Engine G4HD	GDS24194	Drive Shaft	48T	25	25	52.5	95	914			
	2002.09-2005.09	MT	R	F	Hatchback Engine G4HD	GCI24009	Inner Joint		25	22	35	54.5	87			
	2002.09-2005.09	MT	R	F	Hatchback Engine G4HD	GC039232	Outer Joint		25	22	52.5	95	58	M		
1.1 (49 kW)	2005.09-2007.01					GC024041	Outer Joint	48T	25	19	52.5	95	52.5	M		
	2005.10-2008.02				F Hatchback Engine G4HD	GC024041	Outer Joint	48T	25	19	52.5	95	52.5	M		
	2005.10-2008.02	AT			F Hatchback Engine G4HD	GC024025	Outer Joint		25	22	52.5	95	58	M		
	2005.10-2008.02	MT	L	F	Hatchback Engine G4HD	GDS24200	Drive Shaft	48T	25	25	52.5	95	626			
	2005.10-2008.02	MT	L	F	Hatchback Engine G4HD	GC024098	Outer Joint	48T	25	22	52.5	95	58	M		
	2005.10-2008.02			L/R	F Hatchback Engine G4HD	GC024151	Outer Joint	48T	25	20	52.5	94.5	63	M		
	2005.10-2008.02	MT	R	F	Hatchback Engine G4HD	GDS24194	Drive Shaft	48T	25	25	52.5	95	914			
	2005.10-2008.02	MT	R	F	Hatchback Engine G4HD	GCI24009	Inner Joint		25	22	35	54.5	87			
	2005.10-2008.02	MT	R	F	Hatchback Engine G4HD	GC039232	Outer Joint		25	22	52.5	95	58	M		
	2005.10-2008.02				Hatchback Engine G4HD	GC024098	Outer Joint	48T	25	22	52.5	95	58	M		
1.3	2002.09-			MT/AT		GC024098	Outer Joint	48T	25	22	52.5	95	58	M		
1.3 (61 kW)	2004.09-2009.06	MT	L	F	Hatchback Engine G4EA	GDS24200	Drive Shaft	48T	25	25	52.5	95	626			
	2004.09-2009.06	MT	L	F	Hatchback Engine G4EA	GC024098	Outer Joint	48T	25	22	52.5	95	58	M		
	2004.09-2009.06	MT	R	F	Hatchback Engine G4EA	GDS24194	Drive Shaft	48T	25	25	52.5	95	914			
	2004.09-2009.06	MT	R	F	Hatchback Engine G4EA	GCI24009	Inner Joint		25	22	35	54.5	87			
	2004.09-2009.06	MT	R	F	Hatchback Engine G4EA	GC039232	Outer Joint		25	22	52.5	95	58	M		
	2004.09-2009.06				Hatchback Engine G4EA	GC024098	Outer Joint	48T	25	22	52.5	95	58	M		
1.3 (63 kW)	2003.09-2005.09	AT		F	Hatchback Engine G4EA	GC024025	Outer Joint		25	22	52.5	95	58	M		
	2003.09-2005.09	MT		F	Hatchback Engine G4EA	GC024046	Outer Joint	48T	25	22	52.5	95	58	M		
	2003.09-2005.09	MT	L	F	Hatchback Engine G4EA	GDS24200	Drive Shaft	48T	25	25	52.5	95	626			
	2003.09-2005.09	MT	L	F	Hatchback Engine G4EA	GC024098	Outer Joint	48T	25	22	52.5	95	58	M		
	2003.09-2005.09	MT	R	F	Hatchback Engine G4EA	GDS24194	Drive Shaft	48T	25	25	52.5	95	914			
	2003.09-2005.09	MT	R	F	Hatchback Engine G4EA	GCI24009	Inner Joint		25	22	35	54.5	87			
	2003.09-2005.09	MT	R	F	Hatchback Engine G4EA	GC039232	Outer Joint		25	22	52.5	95	58	M		
	2003.09-2005.09				Hatchback Engine G4EA	GC024098	Outer Joint	48T	25	22	52.5	95	58	M		
	2003.09-2005.09				Hatchback Engine G4EA	GC024098	Outer Joint	48T	25	22	52.5	95	58	M		
1.3 i (60 kW)	2002.09-2004.03	AT		F	Hatchback Engine G4EA	GC024025	Outer Joint		25	22	52.5	95	58	M		
	2002.09-2004.03	MT		F	Hatchback Engine G4EA	GC024046	Outer Joint	48T	25	22	52.5	95	58	M		
	2002.09-2004.03	MT	L	F	Hatchback Engine G4EA	GDS24200	Drive Shaft	48T	25	25	52.5	95	626			
	2002.09-2004.03	MT	L	F	Hatchback Engine G4EA	GC024098	Outer Joint	48T	25	22	52.5	95	58	M		
	2002.09-2004.03	MT	R	F	Hatchback Engine G4EA	GDS24194	Drive Shaft	48T	25	25	52.5	95	914			
	2002.09-2004.03	MT	R	F	Hatchback Engine G4EA	GCI24009	Inner Joint		25	22	35	54.5	87			
	2002.09-2004.03	MT	R	F	Hatchback Engine G4EA	GC039232	Outer Joint		25	22	52.5	95	58	M		
	2002.09-2004.03				Hatchback Engine G4EA	GC024098	Outer Joint	48T	25	22	52.5	95	58	M		
1.4 i (71 kW)	2005.08-2009.06	AT		F	Hatchback Engine G4EE	GC024025	Outer Joint		25	22	52.5	95	58	M		
	2005.08-2009.06	MT	L	F	Hatchback Engine G4EE	GDS24200	Drive Shaft	48T	25	25	52.5	95	626			
	2005.08-2009.06	MT	L	F	Hatchback Engine G4EE	GC024098	Outer Joint	48T	25	22	52.5	95	58	M		
	2005.08-2009.06	MT	R	F	Hatchback Engine G4EE	GDS24194	Drive Shaft	48T	25	25	52.5	95	914			
	2005.08-2009.06	MT	R	F	Hatchback Engine G4EE	GCI24009	Inner Joint		25	22	35	54.5	87			
	2005.08-2009.06	MT	R	F	Hatchback Engine G4EE	GC039232	Outer Joint		25	22	52.5	95	58	M		
	2005.08-2009.06				Hatchback Engine G4EE	GC024098	Outer Joint	48T	25	22	52.5	95	58	M		









		TRANSM	L/R	F/R		G-AP Ref.	PRODUCT	ABS	Technical Specifications								
									YEAR	A	B	C	H	L	P		
<b>HYUNDAI</b>																	
<b>GETZ (TB)</b>																	
1.5 CRDi (60 kW)	2003.03-					GC024047	Outer Joint	48T	25	23	50	94.5	63.5	M			
	2003.03-2005.09			F	Hatchback Engine D3-EA	GC024047	Outer Joint	48T	25	23	50	94.5	63.5	M			
	2003.03-2005.09	AT		F	Hatchback Engine D3-EA	GC024025	Outer Joint		25	22	52.5	95	58	M			
1.5 CRDi (65 kW)	2005.08-2009.06			F	Hatchback Engine D4FA	GC024047	Outer Joint	48T	25	23	50	94.5	63.5	M			
	2005.08-2009.06	AT		F	Hatchback Engine D4FA	GC024025	Outer Joint		25	22	52.5	95	58	M			
1.5 CRDi GLS (81 kW)	2005.08-2009.06	AT		F	Hatchback Engine D4FA	GC024025	Outer Joint		25	22	52.5	95	58	M			
	2005.08-					GC024047	Outer Joint	48T	25	23	50	94.5	63.5	M			
	2005.08-2009.06			F	Hatchback Engine D4FA	GC024047	Outer Joint	48T	25	23	50	94.5	63.5	M			
1.6	2002.09-		MT/AT			GC024098	Outer Joint	48T	25	22	52.5	95	58	M			
1.6 (77 kW)	2002.09-2005.09	MT		F	Hatchback Engine G4ED-G	GC024046	Outer Joint	48T	25	22	52.5	95	58	M			
	2002.09-2005.09				Hatchback Engine G4ED-G	GC024098	Outer Joint	48T	25	22	52.5	95	58	M			
<b>GRANDEUR</b>																	
3.0 V6	1999.01-2003.12	MT/AT				GC024034	Outer Joint		27	34	60	95	69	I			
3.3	2005-2010	5AT	L		LAMBDA	GDS24127	Drive Shaft	47T	30	28	65	95	662				
	2005-2010	5AT	R		LAMBDA	GDS24128	Drive Shaft	47T	30	28	65	95	981.5				
<b>GRANDEUR (TG)</b>																	
3.3 (173 kW)	2006.10-				Saloon Engine G6DB	GC024063	Outer Joint	47T	30	36	65	95	68	I			
<b>i10</b>																	
1.1 2WD	2007-2010	4AT	L		EPSILON > SOHC - MPI	GDS24240	Drive Shaft	48T	24	25	52.5	86.5	601				
	2007-2010	5MT	L		EPSILON > SOHC - MPI	GDS24156	Drive Shaft		24	25	52.5	86.5	624				
	2007-2010	5MT	L		EPSILON > SOHC - MPI	GC024087	Outer Joint		24	20	52.5	86.5	63	M			
	2007-2010	5MT	L		EPSILON > SOHC - MPI	GCI24048	Inner Joint		25	20	35	54	91				
	2007-2010	4AT	R		EPSILON > SOHC - MPI	GDS24241	Drive Shaft	48T	24	25	52.5	86.5	870				
	2007-2010	5MT	R		EPSILON > SOHC - MPI	GDS39192	Drive Shaft	48T	24	25	52.5	86.5	845				
	2007-	5MT	L		EPSILON > SOHC - MPI	GDS39191	Drive Shaft	48T	24	25	52.5	86.5	624				
	2007-	5MT	L		EPSILON > SOHC - MPI	GC024129	Outer Joint	48T	24	20	52.5	86.5	63	M			
	2007-	5MT	R		EPSILON > SOHC - MPI	GDS24157	Drive Shaft		24	25	52.5	86.5	845				
<b>i10 (PA)</b>																	
1.2 (57 kW)	2008.11-		MT	L	F	Hatchback Engine G4LA	GDS57145	Drive Shaft	48T	24	25	52.5	86	597			
	2008.11-		MT	R	F	Hatchback Engine G4LA	GDS39192	Drive Shaft	48T	24	25	52.5	86.5	845			
	2008.11-					Hatchback Engine G4LA	GC034146	Outer Joint	48T	24	21	52.5	86	63.5	M		
1.2 (63 kW)	2011.04-			L	F	Hatchback Engine G4LA	GDS57145	Drive Shaft	48T	24	25	52.5	86	597			
	2011.04-			R	F	Hatchback Engine G4LA	GDS39192	Drive Shaft	48T	24	25	52.5	86.5	845			
	2011.04-					Hatchback Engine G4LA	GC034146	Outer Joint	48T	24	21	52.5	86	63.5	M		
<b>i20</b>																	
1.4 2WD	2007-2012	5MT	L		U/U2	GDS39189	Drive Shaft	48T	25	27	52.6	94.5	646				
	2007-2012	5MT	L		U/U2	GC039192	Outer Joint	48T	25	24	52.6	94.5	63.5	M			
	2007-2012	5MT	L		U/U2	GCI27037	Inner Joint		27	24	41	61.5	91				
	2007-2012	5MT	R		U/U2	GDS39190	Drive Shaft	48T	25	27	52.6	94.5	938				
	2007-2014	6MT	R		U2	GDS39190	Drive Shaft	48T	25	27	52.6	94.5	938				
	2008-2014	6MT	L		U2	GDS39189	Drive Shaft	48T	25	27	52.6	94.5	646				
	2008-2014	6MT	L		U2	GC039192	Outer Joint	48T	25	24	52.6	94.5	63.5	M			
	2008-2014	6MT	L		U2	GCI27037	Inner Joint		27	24	41	61.5	91				
1.6 2WD	2008-2012	6MT	L		U2	GDS39189	Drive Shaft	48T	25	27	52.6	94.5	646				
	2008-2012	6MT	L		U2	GC039192	Outer Joint	48T	25	24	52.6	94.5	63.5	M			
	2008-2012	6MT	L		U2	GCI27037	Inner Joint		27	24	41	61.5	91				
	2008-2012	6MT	R		U2	GDS39190	Drive Shaft	48T	25	27	52.6	94.5	938				
<b>i20 (PB, PBT)</b>																	
1.4 (74 kW)	2008.09-		MT	L	F	Hatchback Engine G4FA	GDS24304	Drive Shaft	48T	25	25	52.5	93.5	656			
	2008.09-		MT	R	F	Hatchback Engine G4FA	GDS24153	Drive Shaft	48T	25	25	52.5	94.5	930			
	2008.09-					Hatchback Engine G4FA	GC039181	Outer Joint	48T	25	22	52.5	93.5	59	M		
<b>i30</b>																	
1.6 2WD	2011-		6AT	R		GAMMA/NU	GDS24321	Drive Shaft	46T	27	27	60	95	957			
	2011-		6AT			GAMMA/NU	GDS24272	Drive Shaft		27	27	60	95	668			
1.6/1.8 2WD	2011-		6AT	L		GAMMA/NU	GDS24264	Drive Shaft	46T	27	27	60	95	668			
	2011-		6AT	R		GAMMA/NU	GDS24265	Drive Shaft		27	27	60	95	957			
	2011-		6AT	R		GAMMA/NU	GC024144	Outer Joint		27	24	60	95	59	M		
	2011-		6AT	R		GAMMA/NU	GCI24065	Inner Joint		27	22	30	68	77			
1.8 2WD	2011-		6AT	R		GAMMA/NU	GDS24321	Drive Shaft	46T	27	27	60	95	957			
	2011-		6AT			GAMMA/NU	GDS24272	Drive Shaft		27	27	60	95	668			
	2012-		6MT	L		NU	GDS24248	Drive Shaft	46T	27	27	60	94.5	681			
	2012-		6MT	R		NU	GDS24249	Drive Shaft	46T	27	27	60	94.5	964			

		TRANSM	L/R	F/R		G-AP Ref.	PRODUCT	ABS	Technical Specifications					
									YEAR	A	B	C	H	L
<b>HYUNDAI</b>														
<b>i30</b>														
1.8 2WD	2012-		6MT	R	NU	GC024132	Outer Joint	46T	27	22	60	94.5	54.5	M
	2012-		6MT	R	NU	GCI24061	Inner Joint		27	22	41	62	86	
<b>i30 (FD)</b>														
1.4 (77 kW)	2007.10-	2011.11	5MT		F Hatchback Engine G4FA	GC024095	Outer Joint	46T	27	22	60	94.5	58.5	M
1.4 (80 kW)	2007.10-	2011.11	5MT		F Hatchback Engine D4FA	GC024095	Outer Joint	46T	27	22	60	94.5	58.5	M
1.6 (85 kW)	2007.10-	2011.11	5MT		F Hatchback Engine G4FC	GC024095	Outer Joint	46T	27	22	60	94.5	58.5	M
1.6 (90 kW)	2007.10-	2011.11	5MT		F Hatchback Engine G4FC	GC024095	Outer Joint	46T	27	22	60	94.5	58.5	M
1.6 CRDi (66 kW)	2007.10-	2011.11	5MT		F Hatchback Engine D4FB	GC024152	Outer Joint	46T	27	26	60	94	67	M
1.6 CRDi (85 kW)	2007.10-	2011.11	5MT		F Hatchback Engine D4FB	GC024152	Outer Joint	46T	27	26	60	94	67	M
2.0 (105 kW)	2007.10-	2011.11	5MT/4AT	R	F Hatchback Engine G4GC-G	GC027080	Outer Joint	46T	27	23	60	95	58	M
2.0 CRDi (103 kW)	2007.10-	2011.11	6MT		F Hatchback Engine D4EA	GC024152	Outer Joint	46T	27	26	60	94	67	M
<b>i30 / i30 CW</b>														
1.4 2WD	2010-	2012	5MT/6MT	L	GAMMA	GDS24283	Drive Shaft	46T	27	25	60	94.5	674	
	2010-	2012	5MT/6MT	L	GAMMA	GC024077	Outer Joint	46T	27	22	60	94.5	54.5	M
	2010-	2012	5MT/6MT	L	GAMMA	GCI27019	Inner Joint		25	22	41	62	93.5	
	2010-	2012	5MT/6MT	R	GAMMA	GDS24282	Drive Shaft	46T	27	25	60	94.5	941	
	2010-	2012	5MT/6MT	R	GAMMA	GCI39052	Inner Joint		25	22	41	63	86	
1.6 2WD	2007-	2012	4AT	L	U2 > DOHC - TCI	GDS24305	Drive Shaft	46T	27	27	60	95	675	
	2007-	2012	4AT	L	U2 > DOHC - TCI	GC024137	Outer Joint	46T	27	24	60	95	59	M
	2007-	2012	4AT	L	U2 > DOHC - TCI	GCI24097	Inner Joint		27	22	41	62.5	94	
	2007-	2012	5MT/6MT	L	U2 > DOHC - TCI	GDS24296	Drive Shaft	46T	27	27	60	95	663	
	2007-	2012	5MT/6MT	L	U2 > DOHC - TCI	GC024126	Outer Joint	46T	27	25	60	95	63	M
	2007-	2012	5MT/6MT	L	U2 > DOHC - TCI	GCI24098	Inner Joint		27	25	41	61.5	100.5	
	2007-	2012	5MT/6MT	R	U2 > DOHC - TCI	GDS24297	Drive Shaft	46T	27	27	60	95	954	
	2008-	2012	4AT/5MT/6MT	L	GAMMA	GDS24283	Drive Shaft	46T	27	25	60	94.5	674	
	2008-	2012	4AT/5MT/6MT	L	GAMMA	GC024077	Outer Joint	46T	27	22	60	94.5	54.5	M
	2008-	2012	4AT/5MT/6MT	L	GAMMA	GCI27019	Inner Joint		25	22	41	62	93.5	
	2008-	2012	4AT/5MT/6MT	R	GAMMA	GDS24282	Drive Shaft	46T	27	25	60	94.5	941	
2008-	2012	4AT/5MT/6MT	R	GAMMA	GCI39052	Inner Joint		25	22	41	63	86		
<b>i30 CW (FD)</b>														
1.6 (90 kW)	2008.02-	2012.06	5MT		F Estate Engine G4FC	GC024095	Outer Joint	46T	27	22	60	94.5	58.5	M
1.6 (93 kW)	2008.02-	2012.06	5MT		F Estate Engine G4FC	GC024095	Outer Joint	46T	27	22	60	94.5	58.5	M
1.6 CRDi (66 kW)	2008.02-	2012.06	5MT		F Estate Engine D4FB	GC024152	Outer Joint	46T	27	26	60	94	67	M
1.6 CRDi (85 kW)	2008.02-	2012.06	5MT		F Estate Engine D4FB	GC024152	Outer Joint	46T	27	26	60	94	67	M
2.0 (105 kW)	2008.02-	2012.06	5MT/4AT	R	F Estate Engine G4GC-G	GC027080	Outer Joint	46T	27	23	60	95	58	M
2.0 CRDi (103 kW)	2008.02-	2012.06	6MT		F Estate Engine D4EA	GC024152	Outer Joint	46T	27	26	60	94	67	M
<b>i40 (VF)</b>														
1.7 CRDi (100 kW)	2012.03-		MT	R	F Saloon Engine D4FD	GDS24347	Drive Shaft	48T	27	28	62	92.5	988	
<b>i40 CW (VF)</b>														
1.7 CRDi (100 kW)	2011.07-		MT	R	F Estate Engine D4FD	GDS24347	Drive Shaft	48T	27	28	62	92.5	988	
<b>i45</b>														
2.4 2WD	2010-	2014	6AT	L	THETA 2	GDS24262	Drive Shaft	48T	27	27	62	92.5	672	
	2010-	2014	6AT	L	THETA 2	GC024138	Outer Joint	48T	27	25	62	92.5	61	M
	2010-	2014	6AT	L	THETA 2	GCI24056	Inner Joint		27	25	30	67	83.5	
	2010-	2014	6AT	R	THETA 2	GDS24261	Drive Shaft	48T	27	27	62	92.5	970	
<b>ix20 (JC)</b>														
1.4 (66 kW)	2010.11-			R	F Hatchback Engine G4FA	GDS39237	Drive Shaft	46T	27	25	60	94.5	959	
1.4 CRDi (57 kW)	2011.06-		MT	L	F Hatchback Engine D4FC-M	GDS24318	Drive Shaft	46T	27	27	60	95	672	
	2011.06-		MT	R	F Hatchback Engine D4FC-M	GDS24400	Drive Shaft	46T	27	27	60	95	967	
1.4 CRDi (66 kW)	2010.11-		MT	L	F Hatchback Engine D4FC	GDS24318	Drive Shaft	46T	27	27	60	95	672	
	2010.11-		MT	R	F Hatchback Engine D4FC	GDS24400	Drive Shaft	46T	27	27	60	95	967	
1.6 (92 kW)	2010.11-		AT	R	F Hatchback Engine G4FC	GDS39237	Drive Shaft	46T	27	25	60	94.5	959	
1.6 CRDi (85 kW)	2011.06-		MT	L	F Hatchback Engine D4FB	GDS24318	Drive Shaft	46T	27	27	60	95	672	
	2011.06-		MT	R	F Hatchback Engine D4FB	GDS24400	Drive Shaft	46T	27	27	60	95	967	
<b>ix35 (LM, EL, ELH)</b>														
1.6 (99 kW)	2010.11-		MT	R	F Closed Off-Road Vehicle Engine G4FD	GDS24317	Drive Shaft	48T	27	25	62	95	691	
2.0 (120 kW)	2010.01-		MT	R	F Closed Off-Road Vehicle Engine G4KD	GDS24362	Drive Shaft	48T	30	27	62	95	979	
2.0 CRDi (100 kW)	2010.01-		MT	L	F Closed Off-Road Vehicle Engine D4HA	GDS24299	Drive Shaft	48T	30	27	62	95	690	
	2010.01-		MT	R	F Closed Off-Road Vehicle Engine D4HA	GDS24362	Drive Shaft	48T	30	27	62	95	979	
2.0 CRDi (135 kW)	2012.01-		MT	R	F Closed Off-Road Vehicle Engine D4HA	GDS24362	Drive Shaft	48T	30	27	62	95	979	



		TRANSM	L/R	F/R		G-AP Ref.	PRODUCT	ABS	Technical Specifications					
									YEAR	A	B	C	H	L
<b>HYUNDAI LANTRA</b>														
1.6 2WD	2003-2005	5MT	L			GDS24364	Drive Shaft	44T	25	25	50	95.5	655	
	2003-2005	5MT	L			GC039190	Outer Joint	44T	25	23	50	95.5	60.5	M
	2003-2005	5MT	L			GCI24032	Inner Joint		25	23	35	63	88	
	2003-2005	5MT	R			GDS24363	Drive Shaft	44T	25	25	50	95.5	936	
1.8	1993.01-1995.08	MT/AT	L			GDS24107	Drive Shaft	44T	25	25	50	94.5	940	
<b>LANTRA (GK)</b>														
1.6 16V (77 kW)	2006.11-2009.08	MT	L	F	Coupe Engine G4ED-G	GDS24162	Drive Shaft	44T	25	25	50	94.5	643	
	2006.11-2009.08	MT	L/R	F	Coupe Engine G4ED-G	GCI24049	Inner Joint		25	25	35	63	87.5	
	2006.11-2009.08	MT	L/R	F	Coupe Engine G4ED-G	GC024024	Outer Joint		25	25	50	94.5	65	M
	2006.11-2009.08	MT	R	F	Coupe Engine G4ED-G	GDS24163	Drive Shaft	44T	25	25	50	94.5	928	
	2006.11-2009.08				Coupe Engine G4ED-G	GC039185	Outer Joint	44T	25	23	50	94.5	63.5	M
1.6 16V (79 kW)	2002.03-2009.08	MT	L	F	Coupe Engine G4ED-G	GDS24162	Drive Shaft	44T	25	25	50	94.5	643	
	2002.03-2009.08	MT	L/R	F	Coupe Engine G4ED-G	GCI24049	Inner Joint		25	25	35	63	87.5	
	2002.03-2009.08	MT	L/R	F	Coupe Engine G4ED-G	GC024024	Outer Joint		25	25	50	94.5	65	M
	2002.03-2009.08	MT	R	F	Coupe Engine G4ED-G	GDS24163	Drive Shaft	44T	25	25	50	94.5	928	
	2002.03-2009.08				Coupe Engine G4ED-G	GC039185	Outer Joint	44T	25	23	50	94.5	63.5	M
2.0 (100 kW)	2001.08-2009.08				Coupe Engine G4GC-G	GC039185	Outer Joint	44T	25	23	50	94.5	63.5	M
2.0 (102 kW)	2002.03-2009.08				Coupe Engine G4GC-G	GC039185	Outer Joint	44T	25	23	50	94.5	63.5	M
2.0 GLS (105 kW)	2005.01-2007.03				Coupe Engine G4GC-G	GC039185	Outer Joint	44T	25	23	50	94.5	63.5	M
2.7 V6 (121 kW)	2007.01-2009.08				Coupe Engine G6BA-G	GC024060	Outer Joint	44T	27	26	60	95	69	M
2.7 V6 (123 kW)	2002.03-2009.08				Coupe Engine G6BA-G	GC024060	Outer Joint	44T	27	26	60	95	69	M
<b>LANTRA (J-1)</b>														
1.5 i.e. (63 kW)	1990.10-1995.11			F	Saloon Engine G15B/G4DJ	GC039034	Outer Joint		25	25	50	94.5	65	M
	1990.10-1995.11	MT		F	Saloon Engine G15B/G4DJ	GC089003	Outer Joint		25	25	50	95	64.5	M
	1990.10-1995.11	MT		F	Saloon Engine G15B/G4DJ	GC089004	Outer Joint		25	22	50	95	58	M
1.6 i.e. 16V (78 kW)	1990.10-1995.11			F	Saloon Engine G4CR	GC024001	Outer Joint		25	23	50	95.5	60.5	M
	1990.10-1995.11			F	Saloon Engine G4CR	GC024008	Outer Joint	44T	25	23	50	94.5	63.5	M
1.6 i.e. 16V (84 kW)	1990.10-1995.11			F	Saloon Engine G4CR	GC024001	Outer Joint		25	23	50	95.5	60.5	M
	1990.10-1995.11			F	Saloon Engine G4CR	GC024008	Outer Joint	44T	25	23	50	94.5	63.5	M
1.8 i.e. 16V (93 kW)	1990.10-1995.11	MT/AT		F	Saloon Engine G4CN	GC089003	Outer Joint		25	25	50	95	64.5	M
	1990.10-1995.11	MT/AT		F	Saloon Engine G4CN	GC039054	Outer Joint		25	23	50	96	59	M
<b>LANTRA (RD)</b>														
1.6 i 16V (84 kW)	1996.12-2002.04	MT	L	F	Coupe Engine 4G61	GDS24162	Drive Shaft	44T	25	25	50	94.5	643	
	1996.12-2002.04	MT	L/R	F	Coupe Engine 4G61	GCI24049	Inner Joint		25	25	35	63	87.5	
	1996.12-2002.04	MT	L/R	F	Coupe Engine 4G61	GC024024	Outer Joint		25	25	50	94.5	65	M
	1996.12-2002.04	MT	R	F	Coupe Engine 4G61	GDS24163	Drive Shaft	44T	25	25	50	94.5	928	
	1996.12-2002.04			R	Coupe Engine 4G61	GC039033	Outer Joint		25	25	50	95	65	M
2.0 (101 kW)	1999.08-2002.01	MT	L	F	Coupe Engine G4DF	GDS24162	Drive Shaft	44T	25	25	50	94.5	643	
	1999.08-2002.01	MT	L/R	F	Coupe Engine G4DF	GCI24049	Inner Joint		25	25	35	63	87.5	
	1999.08-2002.01	MT	L/R	F	Coupe Engine G4DF	GC024024	Outer Joint		25	25	50	94.5	65	M
	1999.08-2002.01	MT	R	F	Coupe Engine G4DF	GDS24163	Drive Shaft	44T	25	25	50	94.5	928	
	1999.08-2002.01				Coupe Engine G4DF	GC039185	Outer Joint	44T	25	23	50	94.5	63.5	M
2.0 16V (102 kW)	1996.08-2002.04	MT	L	F	Coupe Engine G4GF	GDS24162	Drive Shaft	44T	25	25	50	94.5	643	
	1996.08-2002.04	MT	L/R	F	Coupe Engine G4GF	GCI24049	Inner Joint		25	25	35	63	87.5	
	1996.08-2002.04	MT	L/R	F	Coupe Engine G4GF	GC024024	Outer Joint		25	25	50	94.5	65	M
	1996.08-2002.04	MT	R	F	Coupe Engine G4GF	GDS24163	Drive Shaft	44T	25	25	50	94.5	928	
	1996.08-2002.04				Coupe Engine G4GF	GC039185	Outer Joint	44T	25	23	50	94.5	63.5	M
<b>LANTRA II (J-2)</b>														
1.5 12V (65 kW)	1996.12-2000.09			F	Saloon Engine G4EK	GC024006	Outer Joint	44T	25	25	50	94.5	65	M
	1997.04-2000.10			F	Estate Engine G4EK	GC024001	Outer Joint		25	23	50	95.5	60.5	M
	1997.04-2000.10			F	Estate Engine G4EK	GC024006	Outer Joint	44T	25	25	50	94.5	65	M
	1997.04-2000.10			F	Estate Engine G4EK	GC024008	Outer Joint	44T	25	23	50	94.5	63.5	M
1.6 16V (84 kW)	1995.11-2000.09			F	Saloon Engine 4G61	GC024001	Outer Joint		25	23	50	95.5	60.5	M
	1995.11-2000.09			F	Saloon Engine 4G61	GC024006	Outer Joint	44T	25	25	50	94.5	65	M
	1995.11-2000.09			F	Saloon Engine 4G61	GC024008	Outer Joint	44T	25	23	50	94.5	63.5	M
	1995.11-2000.09			F	Saloon Engine 4G61	GC039067	Outer Joint	29T	25	30	50	95	60.5	M
	1996.02-2000.10			F	Estate Engine 4G61	GC039067	Outer Joint	29T	25	30	50	95	60.5	M
	1996.02-2000.10			F	Estate Engine 4G61	GC024001	Outer Joint		25	23	50	95.5	60.5	M
	1996.02-2000.10			F	Estate Engine 4G61	GC024006	Outer Joint	44T	25	25	50	94.5	65	M
1.6 i (66 kW)	1995.11-2000.09			F	Saloon Engine G4GR	GC024001	Outer Joint		25	23	50	95.5	60.5	M
	1995.11-2000.09	MT/AT		F	Saloon Engine G4GR	GC099181	Outer Joint		25	30	50	97	57	M





	 YEAR	TRANSM L/R F/R		G-AP Ref.	PRODUCT	ABS	Technical Specifications								
							A	B	C	H	L	P			
<b>HYUNDAI LANTRA II (J-2)</b>															
1.6 i (66 kW)	1995.11-2000.09			F	Saloon Engine G4GR	GC024008	Outer Joint	44T	25	23	50	94.5	63.5	M	
	1996.02-2000.10			F	Estate Engine G4GR	GC024001	Outer Joint		25	23	50	95.5	60.5	M	
	1996.02-2000.10	MT/AT		F	Estate Engine G4GR	GC099181	Outer Joint		25	30	50	97	57	M	
	1996.02-2000.10			F	Estate Engine G4GR	GC024008	Outer Joint	44T	25	23	50	94.5	63.5	M	
1.8 16V (94 kW)	1995.11-2000.09			F	Saloon Engine G4GM	GC039067	Outer Joint	29T	25	30	50	95	60.5	M	
	1996.02-2000.10			F	Estate Engine G4GM	GC039067	Outer Joint	29T	25	30	50	95	60.5	M	
<b>LANTRA II (J-2), SW</b>															
1.9 D (50 kW)	1998-	2000.09				GC024074	Outer Joint	44T	25	30	50	95.5	60.5	I	
<b>MATRIX</b>															
1.8						GCI24016	Inner Joint		25	30	41	62.5	92		
						GC024036	Outer Joint	44T	25	30	50	95.5	60.5	M	
			L			GDS24053	Drive Shaft	44T	25	25	50	95.5	651		
			R			GDS24054	Drive Shaft	44T	25	25	50	95.5	936		
<b>MATRIX (FC)</b>															
1.5	2003-		MT		Engine D3-EA	GC099331	Outer Joint	44T	25	23	50	95.1	64.5	M	
1.5 CRDi (60 kW)	2001.10-2010.08			F	MPV Engine D3EA	GC024061	Outer Joint	44T	25	23	50	94.5	63.5	M	
	2001.10-2010.08	MT	L	F	MPV Engine D3EA	GDS39262	Drive Shaft	44T	25	25	50	94.5	657		
	2001.10-2010.08	MT	R	F	MPV Engine D3EA	GDS39249	Drive Shaft	44T	25	26	50	94.5	585		
1.5 CRDi (75 kW)	2004.11-2007.03			F	MPV Engine D4FA	GC024038	Outer Joint	44T	25	25	50	94.5	65	M	
	2004.11-2007.03	MT	L	F	MPV Engine D4FA	GDS39262	Drive Shaft	44T	25	25	50	94.5	657		
	2004.11-2007.03	MT	R	F	MPV Engine D4FA	GDS39249	Drive Shaft	44T	25	26	50	94.5	585		
1.5 CRDi VGT (81 kW)	2005.08-2010.08	MT	L	F	MPV Engine D4FA	GDS39262	Drive Shaft	44T	25	25	50	94.5	657		
	2005.08-2010.08	MT	R	F	MPV Engine D4FA	GDS39249	Drive Shaft	44T	25	26	50	94.5	585		
1.6 (76 kW)	2001.06-2010.08	MT		F	MPV Engine G4ED-G	GC024036	Outer Joint	44T	25	30	50	95.5	60.5	M	
1.8 (90 kW)	2001.06-2010.08				MPV Engine G4GB-G	GC024100	Outer Joint	44T	25	24	50	94.5	63.5	M	
	2001.06-					GC024074	Outer Joint	44T	25	30	50	95.5	60.5	I	
<b>PONY (X-1)</b>															
1.3 (50 kW)	1985.10-1989.09	MT		F	Saloon Engine G13B	GC089004	Outer Joint		25	22	50	95	58	M	
1.5 (53 kW)	1985.10-1989.09	MT		F	Saloon Engine G15B/G4DJ	GC089004	Outer Joint		25	22	50	95	58	M	
<b>PONY (X-2)</b>															
1.3 (43 kW)	1989.10-1995.01	MT		F	Hatchback Engine G4DG	GC089002	Outer Joint		25	23	50	94.5	63.5	M	
	1989.10-1995.01	MT		F	Hatchback Engine G4DG	GC089004	Outer Joint		25	22	50	95	58	M	
1.5 (53 kW)	1989.10-1995.01	MT		F	Hatchback Engine G15B/G4DJ	GC089002	Outer Joint		25	23	50	94.5	63.5	M	
	1989.10-1995.01	MT		F	Hatchback Engine G15B/G4DJ	GC089004	Outer Joint		25	22	50	95	58	M	
1.5 i (61 kW)	1989.10-1995.01	MT		F	Hatchback Engine G15B/G4DJ	GC089002	Outer Joint		25	23	50	94.5	63.5	M	
	1989.10-1995.01	MT		F	Hatchback Engine G15B/G4DJ	GC089004	Outer Joint		25	22	50	95	58	M	
1.5 i (62 kW)	1989.10-1995.01	MT		F	Hatchback Engine G15B/G4DJ	GC089002	Outer Joint		25	23	50	94.5	63.5	M	
	1989.10-1995.01	MT		F	Hatchback Engine G15B/G4DJ	GC089004	Outer Joint		25	22	50	95	58	M	
<b>PONY / EXCEL (X-2)</b>															
1.5 (53 kW)	1990.01-1995.01	MT		F	Saloon Engine G15B/G4DJ	GC089002	Outer Joint		25	23	50	94.5	63.5	M	
	1990.01-1995.01	MT		F	Saloon Engine G15B/G4DJ	GC089004	Outer Joint		25	22	50	95	58	M	
1.5 i (61 kW)	1990.01-1995.01	MT		F	Saloon Engine G15B/G4DJ	GC089002	Outer Joint		25	23	50	94.5	63.5	M	
	1990.01-1995.01	MT		F	Saloon Engine G15B/G4DJ	GC089004	Outer Joint		25	22	50	95	58	M	
1.5 i (62 kW)	1990.01-1995.01	MT		F	Saloon Engine G15B/G4DJ	GC089002	Outer Joint		25	23	50	94.5	63.5	M	
	1990.01-1995.01	MT		F	Saloon Engine G15B/G4DJ	GC089004	Outer Joint		25	22	50	95	58	M	
<b>S (SLC)</b>															
1.5 i (62 kW)	1990.02-1996.05	MT/AT		F	Coupe Engine G15B/G4DJ	GC089003	Outer Joint		25	25	50	95	64.5	M	
	1990.02-1996.05			F	Coupe Engine G15B/G4DJ	GC024003	Outer Joint		25	22	50	95	58	I	
	1990.02-1996.05	MT/AT		F	Coupe Engine G15B/G4DJ	GC089004	Outer Joint		25	22	50	95	58	M	
	1990.02-1996.05	MT/AT		F	Coupe Engine G15B/G4DJ	GC039054	Outer Joint		25	23	50	96	59	M	
1.5 i (65 kW)	1992.04-1996.05	MT/AT		F	Coupe Engine G4EK	GC089003	Outer Joint		25	25	50	95	64.5	M	
	1992.04-1996.05			F	Coupe Engine G4EK	GC024008	Outer Joint	44T	25	23	50	94.5	63.5	M	
	1992.04-1996.05	MT/AT		F	Coupe Engine G4EK	GC089004	Outer Joint		25	22	50	95	58	M	
	1992.04-1996.05	MT/AT		F	Coupe Engine G4EK	GC039054	Outer Joint		25	23	50	96	59	M	
1.5 i Turbo (85 kW)	1991.04-1996.05	MT/AT		F	Coupe Engine G4EK-TC	GC089003	Outer Joint		25	25	50	95	64.5	M	
	1991.04-1996.05			F	Coupe Engine G4EK-TC	GC024008	Outer Joint	44T	25	23	50	94.5	63.5	M	
	1991.04-1996.05	MT/AT		F	Coupe Engine G4EK-TC	GC089004	Outer Joint		25	22	50	95	58	M	
	1991.04-1996.05	MT/AT		F	Coupe Engine G4EK-TC	GC039054	Outer Joint		25	23	50	96	59	M	
	1991.04-1996.05			F	Coupe Engine G4EK-TC	GC039034	Outer Joint		25	25	50	94.5	65	M	
<b>S COUPE</b>															
2.0	1996.01-2002.03	MT/AT	L		FX	GDS24059	Drive Shaft	47T	25	25	50	94.5	643		
	1996.01-2002.03	MT/AT	R		FX	GDS24060	Drive Shaft	47T	25	25	50	94.5	927		



		YEAR	TRANSM	L/R	F/R		G-AP Ref.	PRODUCT	ABS	Technical Specifications										
										A	B	C	H	L	P					
<b>HYUNDAI SANTA FE</b>																				
2.4 2WD	2009-2010	2010	6AT	L		THETA 2	GDS24233	Drive Shaft	52T	30	28	73	97	659						
	2009-2010	2010	6AT	L		THETA 2	GCI24066	Inner Joint		28	35	33	67.5	100						
	2009-2010	2010	6AT	L		THETA 2	GC024072	Outer Joint	52T	30	36	73	97	67.5	I					
	2009-2010	2010	6AT	R		THETA 2	GDS24232	Drive Shaft	52T	30	28	73	97	597						
	2009-2010	2010	6AT	R		THETA 2	GC024072	Outer Joint	52T	30	36	73	97	67.5	I					
	2009-2010	2010	6AT	R		THETA 2	GCI24054	Inner Joint		28	35	42	42	83						
2.7			AT	L	F		GDS24116	Drive Shaft	52T	30	27	73	97	667						
3.3	2007.01-	2008.06	5AT	L			GDS39247	Drive Shaft	52T	30	28	73	97	670						
<b>SANTA FE I (SM)</b>																				
2.0 CRDi (83 kW)	2001.08-	2006.03		L	F	Closed Off-Road Vehicle Engine D4EA	GDS24218	Drive Shaft	52T	27	27	60	95	648						
	2001.08-	2006.03		R	F	Closed Off-Road Vehicle Engine D4EA	GDS24217	Drive Shaft	52T	27	26	60	95	609						
	2001.08-	2006.03		R	F	Closed Off-Road Vehicle Engine D4EA	GCI39075	Inner Joint		26	34	42	43	64						
	2001.08-	2006.03		R	F	Closed Off-Road Vehicle Engine D4EA	GC024022	Outer Joint		27	34	60	96.5	71	I					
	2001.08-	2006.03				Closed Off-Road Vehicle Engine D4EA	GC024056	Outer Joint	52T	27	26	60	95	69.5	M					
2.0 CRDi 4WD (92 kW)	2003.08-						GC024091	Outer Joint	52T	27	26	60	95	69	M					
2.0 CRDi 4x4 (83 kW)	2001.04-	2006.03	MT		F	Closed Off-Road Vehicle Engine D4EA	GC024091	Outer Joint	52T	27	26	60	95	69	M					
	2001.04-	2006.03		L	F	Closed Off-Road Vehicle Engine D4EA	GDS24218	Drive Shaft	52T	27	27	60	95	648						
	2001.04-	2006.03		R	F	Closed Off-Road Vehicle Engine D4EA	GDS24217	Drive Shaft	52T	27	26	60	95	609						
	2001.04-	2006.03		R	F	Closed Off-Road Vehicle Engine D4EA	GCI39075	Inner Joint		26	34	42	43	64						
	2001.04-	2006.03		R	F	Closed Off-Road Vehicle Engine D4EA	GC024022	Outer Joint		27	34	60	96.5	71	I					
	2001.04-	2006.03				Closed Off-Road Vehicle Engine D4EA	GC024056	Outer Joint	52T	27	26	60	95	69.5	M					
2.0 CRDi 4x4 (92 kW)	2003.08-	2006.03	MT		F	Closed Off-Road Vehicle Engine D4EA	GC024091	Outer Joint	52T	27	26	60	95	69	M					
2.4 16V (100 kW)	2001.02-	2006.03	AT		F	Closed Off-Road Vehicle Engine G4JS-G	GC024091	Outer Joint	52T	27	26	60	95	69	M					
	2001.02-	2006.03	MT		F	Closed Off-Road Vehicle Engine G4JS-G	GC024029	Outer Joint	47T	27	25	60	95	63.5	M					
2.4 16V (107 kW)	2001.02-	2006.03	AT		F	Closed Off-Road Vehicle Engine G4JS-G	GC024091	Outer Joint	52T	27	26	60	95	69	M					
	2001.02-	2006.03	MT		F	Closed Off-Road Vehicle Engine G4JS-G	GC024029	Outer Joint	47T	27	25	60	95	63.5	M					
2.4 16V 4x4 (100 kW)	2001.02-	2006.03	MT		F	Closed Off-Road Vehicle Engine G4JS-G	GC024029	Outer Joint	47T	27	25	60	95	63.5	M					
	2001.02-	2006.03	MT	L	F	Closed Off-Road Vehicle Engine G4JS-G	GDS24218	Drive Shaft	52T	27	27	60	95	648						
	2001.02-	2006.03	MT	R	F	Closed Off-Road Vehicle Engine G4JS-G	GDS24217	Drive Shaft	52T	27	26	60	95	609						
	2001.02-	2006.03	MT	R	F	Closed Off-Road Vehicle Engine G4JS-G	GCI39075	Inner Joint		26	34	42	43	64						
	2001.02-	2006.03	MT	R	F	Closed Off-Road Vehicle Engine G4JS-G	GC024022	Outer Joint		27	34	60	96.5	71	I					
	2001.02-	2006.03				Closed Off-Road Vehicle Engine G4JS-G	GC024056	Outer Joint	52T	27	26	60	95	69.5	M					
2.4 16V 4x4 (107 kW)	2001.02-	2006.03	MT		F	Closed Off-Road Vehicle Engine G4JS-G	GC024029	Outer Joint	47T	27	25	60	95	63.5	M					
	2001.02-	2006.03	MT	L	F	Closed Off-Road Vehicle Engine G4JS-G	GDS24218	Drive Shaft	52T	27	27	60	95	648						
	2001.02-	2006.03	MT	R	F	Closed Off-Road Vehicle Engine G4JS-G	GDS24217	Drive Shaft	52T	27	26	60	95	609						
	2001.02-	2006.03	MT	R	F	Closed Off-Road Vehicle Engine G4JS-G	GCI39075	Inner Joint		26	34	42	43	64						
	2001.02-	2006.03	MT	R	F	Closed Off-Road Vehicle Engine G4JS-G	GC024022	Outer Joint		27	34	60	96.5	71	I					
2001.02-	2006.03				Closed Off-Road Vehicle Engine G4JS-G	GC024056	Outer Joint	52T	27	26	60	95	69.5	M						
2.7 (139 kW)	2005.10-	2006.03	AT	R	F	Closed Off-Road Vehicle Engine G6EA	GCI39075	Inner Joint		26	34	42	43	64						
	2005.10-	2006.03	AT	R	F	Closed Off-Road Vehicle Engine G6EA	GC024022	Outer Joint		27	34	60	96.5	71	I					
2.7 4x4 (132 kW)	2000.11-	2006.03	AT	R	F	Closed Off-Road Vehicle Engine G6EA	GDS24217	Drive Shaft	52T	27	26	60	95	609						
	2000.11-	2006.03	AT	R	F	Closed Off-Road Vehicle Engine G6EA	GCI39075	Inner Joint		26	34	42	43	64						
	2000.11-	2006.03	AT	R	F	Closed Off-Road Vehicle Engine G6EA	GC024022	Outer Joint		27	34	60	96.5	71	I					
	2000.11-	2006.03				Closed Off-Road Vehicle Engine G6EA	GC024056	Outer Joint	52T	27	26	60	95	69.5	M					
2.7 4x4 (139 kW)	2005.10-	2006.03	AT	R	F	Closed Off-Road Vehicle Engine G6EA	GCI39075	Inner Joint		26	34	42	43	64						
	2005.10-	2006.03	AT	R	F	Closed Off-Road Vehicle Engine G6EA	GC024022	Outer Joint		27	34	60	96.5	71	I					
2.7 V6 4x4 (127 kW)	2001.02-	2006.03	AT		F	Closed Off-Road Vehicle Engine G6BA-G	GC024091	Outer Joint	52T	27	26	60	95	69	M					
	2001.02-	2006.03	MT		F	Closed Off-Road Vehicle Engine G6BA-G	GC024029	Outer Joint	47T	27	25	60	95	63.5	M					
	2001.02-	2006.03	AT	R	F	Closed Off-Road Vehicle Engine G6BA-G	GDS24217	Drive Shaft	52T	27	26	60	95	609						
	2001.02-	2006.03	AT	R	F	Closed Off-Road Vehicle Engine G6BA-G	GCI39075	Inner Joint		26	34	42	43	64						
	2001.02-	2006.03	AT	R	F	Closed Off-Road Vehicle Engine G6BA-G	GC024022	Outer Joint		27	34	60	96.5	71	I					
	2001.02-	2006.03				Closed Off-Road Vehicle Engine G6BA-G	GC024056	Outer Joint	52T	27	26	60	95	69.5	M					
<b>SANTA FE II (CM)</b>																				
2.2 CRDi (102 kW)	2006.03-			R	F	Closed Off-Road Vehicle Engine D4EB	GDS24117	Drive Shaft	52T	30	28	73	97	611						
	2006.03-			L	F	Closed Off-Road Vehicle Engine D4EB	GDS24195	Drive Shaft	52T	30	28	73	97	659						
	2006.03-			R	F	Closed Off-Road Vehicle Engine D4EB	GCI24094	Inner Joint		28	35	42		129.5						
	2006.03-					Closed Off-Road Vehicle Engine D4EB	GC024072	Outer Joint	52T	30	36	73	97	67.5	I					
2.2 CRDi (114 kW)	2006.03-			R	F	Closed Off-Road Vehicle Engine D4EB	GDS24117	Drive Shaft	52T	30	28	73	97	611						
	2006.03-			L	F	Closed Off-Road Vehicle Engine D4EB	GDS24195	Drive Shaft	52T	30	28	73	97	659						
	2006.03-			R	F	Closed Off-Road Vehicle Engine D4EB	GCI24094	Inner Joint		28	35	42		129.5						
	2006.03-					Closed Off-Road Vehicle Engine D4EB	GC024072	Outer Joint	52T	30	36	73	97	67.5	I					





	 YEAR	TRANSM	L/R	F/R		G-AP Ref.	PRODUCT	ABS	Technical Specifications							
									A	B	C	H	L	P		
<b>HYUNDAI</b>																
<b>SANTA FE II (CM)</b>																
2.2 CRDi (145 kW)	2009.01-			L	F	Closed Off-Road Vehicle Engine D4HB	GDS24195	Drive Shaft	52T	30	28	73	97	659		
	2009.01-					Closed Off-Road Vehicle Engine D4HB	GC024072	Outer Joint	52T	30	36	73	97	67.5	I	
2.2 CRDi 4x4 (102 kW)	2006.03-			R	F	Closed Off-Road Vehicle Engine D4EB	GDS24117	Drive Shaft	52T	30	28	73	97	611		
	2006.03-			L	F	Closed Off-Road Vehicle Engine D4EB	GDS24195	Drive Shaft	52T	30	28	73	97	659		
	2006.03-			R	F	Closed Off-Road Vehicle Engine D4EB	GCI24094	Inner Joint		28	35	42		129.5		
	2006.03-					Closed Off-Road Vehicle Engine D4EB	GC024072	Outer Joint	52T	30	36	73	97	67.5	I	
2.2 CRDi 4x4 (114 kW)	2006.08-			R	F	Closed Off-Road Vehicle Engine D4EB	GDS24117	Drive Shaft	52T	30	28	73	97	611		
	2006.08-			L	F	Closed Off-Road Vehicle Engine D4EB	GDS24195	Drive Shaft	52T	30	28	73	97	659		
	2006.08-			R	F	Closed Off-Road Vehicle Engine D4EB	GCI24094	Inner Joint		28	35	42		129.5		
	2006.08-					Closed Off-Road Vehicle Engine D4EB	GC024072	Outer Joint	52T	30	36	73	97	67.5	I	
2.2 CRDi 4x4 (145 kW)	2009.01-			L	F	Closed Off-Road Vehicle Engine D4HB	GDS24195	Drive Shaft	52T	30	28	73	97	659		
	2009.01-					Closed Off-Road Vehicle Engine D4HB	GC024072	Outer Joint	52T	30	36	73	97	67.5	I	
2.2 CRDi GLS (110 kW)	2006.03-			R	F	Closed Off-Road Vehicle Engine D4EB	GDS24117	Drive Shaft	52T	30	28	73	97	611		
	2006.03-	AT		L	F	Closed Off-Road Vehicle Engine D4EB	GDS39247	Drive Shaft	52T	30	28	73	97	670		
	2006.03-			L	F	Closed Off-Road Vehicle Engine D4EB	GDS24195	Drive Shaft	52T	30	28	73	97	659		
	2006.03-			R	F	Closed Off-Road Vehicle Engine D4EB	GCI24094	Inner Joint		28	35	42		129.5		
	2006.03-					Closed Off-Road Vehicle Engine D4EB	GC024072	Outer Joint	52T	30	36	73	97	67.5	I	
2.2 CRDi GLS 4x4 (110 kW)	2006.03-			R	F	Closed Off-Road Vehicle Engine D4EB	GDS24117	Drive Shaft	52T	30	28	73	97	611		
	2006.03-	AT		L	F	Closed Off-Road Vehicle Engine D4EB	GDS39247	Drive Shaft	52T	30	28	73	97	670		
	2006.03-			L	F	Closed Off-Road Vehicle Engine D4EB	GDS24195	Drive Shaft	52T	30	28	73	97	659		
	2006.03-			R	F	Closed Off-Road Vehicle Engine D4EB	GCI24094	Inner Joint		28	35	42		129.5		
	2006.03-					Closed Off-Road Vehicle Engine D4EB	GC024072	Outer Joint	52T	30	36	73	97	67.5	I	
2.7 (125 kW)	2006.03-	AT		R	F	Closed Off-Road Vehicle Engine G6BA	GDS24117	Drive Shaft	52T	30	28	73	97	611		
	2006.03-	AT		R	F	Closed Off-Road Vehicle Engine G6BA	GCI24022	Inner Joint		28	35	42	39.5	78.5		
	2006.03-	AT		R	F	Closed Off-Road Vehicle Engine G6BA	GC024071	Outer Joint		30	36	73	97	67.5	I	
	2006.03-					Closed Off-Road Vehicle Engine G6BA	GC024072	Outer Joint	52T	30	36	73	97	67.5	I	
2.7 (129 kW)	2004.08-	AT		R	F	Closed Off-Road Vehicle	GDS24117	Drive Shaft	52T	30	28	73	97	611		
	2004.08-	AT		R	F	Closed Off-Road Vehicle	GCI24022	Inner Joint		28	35	42	39.5	78.5		
	2004.08-	AT		R	F	Closed Off-Road Vehicle	GC024071	Outer Joint		30	36	73	97	67.5	I	
	2004.08-					Closed Off-Road Vehicle	GC024072	Outer Joint	52T	30	36	73	97	67.5	I	
2.7 4x4 (125 kW)	2006.03-	AT		R	F	Closed Off-Road Vehicle Engine G6BA	GDS24117	Drive Shaft	52T	30	28	73	97	611		
	2006.03-	AT		R	F	Closed Off-Road Vehicle Engine G6BA	GCI24022	Inner Joint		28	35	42	39.5	78.5		
	2006.03-	AT		R	F	Closed Off-Road Vehicle Engine G6BA	GC024071	Outer Joint		30	36	73	97	67.5	I	
	2006.03-					Closed Off-Road Vehicle Engine G6BA	GC024072	Outer Joint	52T	30	36	73	97	67.5	I	
2.7 V6 GLS (139 kW)	2006.03-	AT		R	F	Closed Off-Road Vehicle Engine G6EA	GDS24117	Drive Shaft	52T	30	28	73	97	611		
	2006.03-	AT		R	F	Closed Off-Road Vehicle Engine G6EA	GCI24022	Inner Joint		28	35	42	39.5	78.5		
	2006.03-	AT		R	F	Closed Off-Road Vehicle Engine G6EA	GC024071	Outer Joint		30	36	73	97	67.5	I	
	2006.03-					Closed Off-Road Vehicle Engine G6EA	GC024072	Outer Joint	52T	30	36	73	97	67.5	I	
2.7 V6 GLS 4x4 (139 kW)	2006.03-	AT		R	F	Closed Off-Road Vehicle Engine G6EA	GDS24117	Drive Shaft	52T	30	28	73	97	611		
	2006.03-	AT		R	F	Closed Off-Road Vehicle Engine G6EA	GCI24022	Inner Joint		28	35	42	39.5	78.5		
	2006.03-	AT		R	F	Closed Off-Road Vehicle Engine G6EA	GC024071	Outer Joint		30	36	73	97	67.5	I	
	2006.03-					Closed Off-Road Vehicle Engine G6EA	GC024072	Outer Joint	52T	30	36	73	97	67.5	I	
<b>SANTRO</b>																
-				L			GC024014	Outer Joint		25	20	50	94.5	56	I	
				R			GDS24016	Drive Shaft		25	22	50	94.5	589.5		
							GDS24017	Drive Shaft		25	22	50	94.5	805		
<b>SENTA FE</b>																
2.7 4WD	2000-2006	MT/AT		L	F		GDS24218	Drive Shaft	52T	27	27	60	95	648		
	2000-2006	MT/AT		R	F		GDS24217	Drive Shaft	52T	27	26	60	95	609		
<b>SOLARIS (SB)</b>																
-	2010-						GCI39052	Inner Joint		25	22	41	63	86		
<b>SONATA</b>																
-				L		6 Cyl (BEIJING)	GDS24003	Drive Shaft		27	27	60	95	663		
				R		6 Cyl (BEIJING)	GC024013	Outer Joint		27	26	60	95	69	M	
				R		6 Cyl (BEIJING)	GDS24004	Drive Shaft		27	27	60	95	976.5		
							GC024027	Outer Joint	47T	27	23	60	95	63.5	M	
				L		6 Cyl (BEIJING)	GC024012	Outer Joint		27	26	60	95	69.5	M	
	2001-2005	AT		L		4 Cyl	GDS24124	Drive Shaft		27	25	60	95	661		
	2001-2005	AT		R		4 Cyl	GDS24123	Drive Shaft		27	25	60	95	974		
	2001-	AT				4 Cyl	GCI24008	Inner Joint		25	23	41	63	92.5		
	2001-			L		6 Cyl	GDS24126	Drive Shaft	47T	27	27	60	95	662		
	2001-			R		6 Cyl	GDS24125	Drive Shaft	47T	27	26	60	95	619		









	 YEAR	TRANSM	L/R	F/R		G-AP Ref.	PRODUCT	ABS	Technical Specifications							
									A	B	C	H	L	P		
<b>HYUNDAI SONATA</b>																
-	NULL-			R	6 Cyl (BEIJING)	GC024013	Outer Joint		27	26	60	95	69	M		
	NULL-			R	6 Cyl (BEIJING)	GCI24001	Inner Joint		27	25	41	62.8	92.5			
2.0						GCI24001	Inner Joint		27	25	41	62.8	92.5			
	1992-1998					GC099038	Outer Joint	47T	25	25	50	94.5	65	M		
	1993-1996			L		GDS24011	Drive Shaft		25	25	50	94.5	982			
	1993-1996			R		GDS24012	Drive Shaft		25	25	50	94.5	639			
2.4 2WD	2010-2014	6AT	L		THETA 2	GDS24262	Drive Shaft	48T	27	27	62	92.5	672			
	2010-2014	6AT	L		THETA 2	GC024138	Outer Joint	48T	27	25	62	92.5	61	M		
	2010-2014	6AT	L		THETA 2	GCI24056	Inner Joint		27	25	30	67	83.5			
	2010-2014	6AT	R		THETA 2	GDS24261	Drive Shaft	48T	27	27	62	92.5	970			
2.4	1999-2001	AT	L			GDS24014	Drive Shaft	47T	27	27	60	95	659			
	1999-2001	AT	R			GDS24015	Drive Shaft	47T	27	27	60	95	974			
	1999-2001	AT	L	F		GDS27001	Drive Shaft		27	27	60	95	659			
	2006.01-2006.01	MT/AT				GC024170	Outer Joint	47T	27	25	62.2	95	61.5	M		
2.4 2WD	2009-2014	6AT	L		THETA 2	GDS24229	Drive Shaft		27	27	62	94.5	674			
	2009-2014	6AT	L		THETA 2	GC024125	Outer Joint		27	25	62	94.5	61	M		
	2009-2014	6AT	R		THETA 2	GDS24228	Drive Shaft		27	27	62	94.5	972			
2.7	2002-			L	6 Cyl	GDS24094	Drive Shaft	47T	27	27	60	96.5	661			
3.0 V6	1989-1991					GC024019	Outer Joint		25	26	50	95	69	M		
3.3	2005-2010	5AT	L		LAMBDA	GDS24127	Drive Shaft	47T	30	28	65	95	662			
	2005-2010	5AT	R		LAMBDA	GDS24128	Drive Shaft	47T	30	28	65	95	981.5			
<b>SONATA (NF)</b>																
-				L		GDS24031	Drive Shaft	47T	27	28	62	94.5	660			
				R		GDS24032	Drive Shaft	47T	27	28	62	94.5	986			
2.4	2007-	AT	L			GDS24145	Drive Shaft	47T	27	27	62.2	95	671			
	2007-	AT	R			GDS24144	Drive Shaft	47T	27	27	62.2	95	979			
<b>SONATA (Y-2)</b>																
1.8 i (70 kW)	1988.09-1993.10			F	Saloon Engine 4G62	GC039034	Outer Joint		25	25	50	94.5	65	M		
	1988.09-1993.10	MT&AT		F	Saloon Engine 4G62	GC039054	Outer Joint		25	23	50	96	59	M		
2.0 i (74 kW)	1988.09-1991.08			F	Saloon Engine G4CP	GC039034	Outer Joint		25	25	50	94.5	65	M		
	1988.09-1991.08	MT&AT		F	Saloon Engine G4CP	GC039054	Outer Joint		25	23	50	96	59	M		
2.0 i (80 kW)	1991.01-1993.10			F	Saloon Engine G4CP-U	GC039034	Outer Joint		25	25	50	94.5	65	M		
2.0 i 16V (96 kW)	1991.01-1993.10			F	Saloon Engine G4CP-D	GC039034	Outer Joint		25	25	50	94.5	65	M		
2.4 i (83 kW)	1988.09-1991.08			F	Saloon Engine G4CS	GC039034	Outer Joint		25	25	50	94.5	65	M		
3.0 i V6 (107 kW)	1991.01-1993.10			F	Saloon Engine G6AT	GC039034	Outer Joint		25	25	50	94.5	65	M		
<b>SONATA II (Y-3)</b>																
1.8 i (72 kW)	1993.05-1998.06			F	Saloon Engine G4CM	GC039034	Outer Joint		25	25	50	94.5	65	M		
2.0 i (70 kW)	1996.08-1998.06			F	Saloon	GC039034	Outer Joint		25	25	50	94.5	65	M		
2.0 i (77 kW)	1994.06-1996.08			F	Saloon Engine G4CP	GC039034	Outer Joint		25	25	50	94.5	65	M		
2.0 i 16V (102 kW)	1993.05-1998.06			F	Saloon Engine G4CP-D	GC039034	Outer Joint		25	25	50	94.5	65	M		
3.0 i V6 (107 kW)	1993.05-1998.06			F	Saloon Engine G6AT	GC039034	Outer Joint		25	25	50	94.5	65	M		
<b>SONATA III (EF)</b>																
2.0 16V (96 kW)	2001.10-2004.11	MT		F	Saloon Engine G4JP-EG	GC024029	Outer Joint	47T	27	25	60	95	63.5	M		
	2001.10-2004.11	MT/AT		F	Saloon Engine G4JP-EG	GC039104	Outer Joint		27	25	60	97	63.5	I		
<b>SONATA V (NF)</b>																
2.0 CRDi (100 kW)	2006.02-			F	Saloon Engine D4EA	GC024062	Outer Joint	47T	27	25	62.2	95	60	M		
	2006.02-	AT		F	Saloon Engine D4EA	GC024062	Outer Joint	47T	27	25	62.2	95	60	M		
	2006.02-	MT		F	Saloon Engine D4EA	GC024058	Outer Joint	47T	27	26	62	94.5	65	M		
2.0 CRDi (103 kW)	2006.07-			F	Saloon Engine D4EA	GC024062	Outer Joint	47T	27	25	62.2	95	60	M		
	2006.07-	AT		F	Saloon Engine D4EA	GC024062	Outer Joint	47T	27	25	62.2	95	60	M		
	2006.07-	MT		F	Saloon Engine D4EA	GC024058	Outer Joint	47T	27	26	62	94.5	65	M		
2.0 CRDi (110 kW)	2009.03-			F	Saloon	GC024062	Outer Joint	47T	27	25	62.2	95	60	M		
	2009.03-	AT		F	Saloon	GC024062	Outer Joint	47T	27	25	62.2	95	60	M		
	2009.03-	MT		F	Saloon	GC024058	Outer Joint	47T	27	26	62	94.5	65	M		
<b>SONICA</b>																
2.0						GDS24108	Drive Shaft	47T	25	25	50	94.5	637			
<b>TERRACAN (HP)</b>																
2.9 CRDi 4WD (110 kW)	2001.12-2006.12		L/R	F	Closed Off-Road Vehicle Engine J3	GC024173	Outer Joint		28	34	56	152	68	I		
2.9 CRDi 4WD (120 kW)	2003.06-2004.11		L/R	F	Closed Off-Road Vehicle Engine J3	GC024173	Outer Joint		28	34	56	152	68	I		
3.5 i V6 4WD (143 kW)	2001.12-2006.12		L/R	F	Closed Off-Road Vehicle Engine G6CU	GC024173	Outer Joint		28	34	56	152	68	I		



	 YEAR	TRANSM	L/R	F/R		G-AP Ref.	PRODUCT	ABS	Technical Specifications							
									A	B	C	H	L	P		
<b>HYUNDAI TRAJET (FO)</b>																
2.0 (100 kW)	2000.03-2008.07	5MT		F	MPV Engine G4JP-G	GC027009	Outer Joint		27	25	60	95	63.5	M		
	2000.03-2008.07	MT		F	MPV Engine G4JP-G	GC024029	Outer Joint	47T	27	25	60	95	63.5	M		
	2000.03-2008.07	AT	L	F	MPV Engine G4JP-G	GDS24158	Drive Shaft	47T	27	27	60	95	660			
	2000.03-2008.07	MT	R	F	MPV Engine G4JP-G	GDS24058	Drive Shaft	47T	27	27	60	95	976.5			
	2000.03-2008.07	MT	R	F	MPV Engine G4JP-G	GCI24001	Inner Joint		27	25	41	62.8	92.5			
	2000.03-2008.07	MT	R	F	MPV Engine G4JP-G	GC024013	Outer Joint		27	26	60	95	69	M		
2.0 (103 kW)	2004.07-2007.01			F	MPV Engine G4GC-G	GC024130	Outer Joint	47T	27	25	60	95	65	M		
	2004.07-2007.01			F	MPV Engine G4GC-G	GC027009	Outer Joint		27	25	60	95	63.5	M		
	2004.07-2007.01	MT		F	MPV Engine G4GC-G	GC024029	Outer Joint	47T	27	25	60	95	63.5	M		
	2004.07-2007.01	MT	L	F	MPV Engine G4GC-G	GDS24158	Drive Shaft	47T	27	27	60	95	660			
2.0 (104 kW)	2003.11-2008.07			F	MPV Engine G4GC	GC024130	Outer Joint	47T	27	25	60	95	65	M		
2.0 CRDi (83 kW)	2001.04-2008.07	MT/AT		F	MPV Engine D4EA	GC024066	Outer Joint	47T	27	26	60	95	69	M		
	2001.04-2008.07	MT	L	F	MPV Engine D4EA	GDS24158	Drive Shaft	47T	27	27	60	95	660			
	2001.04-2008.07	MT	R	F	MPV Engine D4EA	GDS24058	Drive Shaft	47T	27	27	60	95	976.5			
	2001.04-2008.07	MT	R	F	MPV Engine D4EA	GCI24001	Inner Joint		27	25	41	62.8	92.5			
	2001.04-2008.07	MT	R	F	MPV Engine D4EA	GC024013	Outer Joint		27	26	60	95	69	M		
2.7 V6 (127 kW)	2000.09-2008.07	MT		F	MPV Engine G6BA-G	GC024029	Outer Joint	47T	27	25	60	95	63.5	M		
	2000.09-2008.07	AT	L	F	MPV Engine G6BA-G	GDS24158	Drive Shaft	47T	27	27	60	95	660			
	2000.09-2008.07	MT	R	F	MPV Engine G6BA-G	GDS24058	Drive Shaft	47T	27	27	60	95	976.5			
	2000.09-2008.07	MT	R	F	MPV Engine G6BA-G	GCI24001	Inner Joint		27	25	41	62.8	92.5			
	2000.09-2008.07	MT	R	F	MPV Engine G6BA-G	GC024013	Outer Joint		27	26	60	95	69	M		
<b>TUCSON</b>																
-						GC024094	Outer Joint	48T	27	26	62	94.5	65	M		
	2005-2007	AT	L			GDS99053	Drive Shaft	48T	27	27	62.2	95	668			
	2005-2007	MT	L			GDS24110	Drive Shaft	48T	27	27	62.2	95	673			
	2005-2007	AT	R			GDS24112	Drive Shaft	48T	27	27	62.2	95	955			
	2005-2007	MT	R			GDS24111	Drive Shaft	48T	27	27	62.2	95	956			
	2005-2009					GC099249	Outer Joint		27	23	62.2	95	60	M		
	2005-2009					GC024048	Outer Joint	48T	27	23	62.2	95	60	M		
	2005-2007	AT	L/R			GC099249	Outer Joint		27	23	62.2	95	60	M		
2.0 2WD	2006-2009	5MT	L		BETA	GDS24216	Drive Shaft	48T	27	27	62.2	95	673			
	2006-2009	5MT	L		BETA	GCI24044	Inner Joint		27	25	41	62	87			
	2006-2009	5MT	R		BETA	GDS24111	Drive Shaft	48T	27	27	62.2	95	956			
<b>TUCSON (JM)</b>																
2.0 (104 kW)	2004.08-2006.02			F	Closed Off-Road Vehicle Engine G4GC	GC024090	Outer Joint	48T	27	25	61.9	95	61	M		
	2004.08-2006.02	MT	R	F	Closed Off-Road Vehicle Engine G4GC	GDS24221	Drive Shaft	48T	27	26	61.9	95	610			
	2004.08-2006.02	MT	R	F	Closed Off-Road Vehicle Engine G4GC	GCI39063	Inner Joint		26	25	42	39.5	68.5			
	2004.08-2006.02		R	F	Closed Off-Road Vehicle Engine G4GC	GCI24030	Inner Joint		26	25	42	40	68			
	2004.08-2006.02		L	F	Closed Off-Road Vehicle Engine G4GC	GDS24172	Drive Shaft	48T	27	27	62.2	95	668			
	2006.03-2010.03				Closed Off-Road Vehicle Engine G4GC	GC024090	Outer Joint	48T	27	25	61.9	95	61	M		
	2006.03-2010.03		L	F	Closed Off-Road Vehicle Engine G4GC	GDS24172	Drive Shaft	48T	27	27	62.2	95	668			
	2006.03-2010.03	MT	R	F	Closed Off-Road Vehicle Engine G4GC	GDS24221	Drive Shaft	48T	27	26	61.9	95	610			
	2006.03-2010.03	MT	R	F	Closed Off-Road Vehicle Engine G4GC	GCI39063	Inner Joint		26	25	42	39.5	68.5			
	2006.03-2010.03		R	F	Closed Off-Road Vehicle Engine G4GC	GDS24173	Drive Shaft	48T	27	26	62.2	95	609			
	2006.03-2010.03		R	F	Closed Off-Road Vehicle Engine G4GC	GCI24030	Inner Joint		26	25	42	40	68			
	2006.03-2010.03	MT/AT		R	Closed Off-Road Vehicle Engine G4GC	GDS24287	Drive Shaft	48T	27	27	60	94	800			
	2006.03-2010.03			R	Closed Off-Road Vehicle Engine G4GC	GC024178	Outer Joint	48T	27	23	60	94	60	M		
2.0 (105 kW)	2010.01-2010.03	MT	R	F	Closed Off-Road Vehicle Engine G4GC	GDS24221	Drive Shaft	48T	27	26	61.9	95	610			
	2010.01-2010.03	MT	R	F	Closed Off-Road Vehicle Engine G4GC	GCI39063	Inner Joint		26	25	42	39.5	68.5			
	2010.01-2010.03		R	F	Closed Off-Road Vehicle Engine G4GC	GCI24030	Inner Joint		26	25	42	40	68			
2.0 CRDi (100 kW)	2006.01-2010.03	MT	L	F	Closed Off-Road Vehicle Engine D4EA	GDS24300	Drive Shaft	48T	30	28	65	95	653			
	2006.01-2010.03	MT	L	F	Closed Off-Road Vehicle Engine D4EA	GDS24352	Drive Shaft	48T	27	27	62	94.5	671			
	2006.01-2010.03	MT/AT	R	F	Closed Off-Road Vehicle Engine D4EA	GDS24221	Drive Shaft	48T	27	26	61.9	95	610			
	2006.01-2010.03	MT/AT	R	F	Closed Off-Road Vehicle Engine D4EA	GCI39063	Inner Joint		26	25	42	39.5	68.5			
	2006.01-2010.03		R	F	Closed Off-Road Vehicle Engine D4EA	GCI24030	Inner Joint		26	25	42	40	68			
	2006.01-2010.03		R		Closed Off-Road Vehicle Engine D4EA	GC024178	Outer Joint	48T	27	23	60	94	60	M		
2.0 CRDi (103 kW)	2006.03-2007.12	MT	L	F	Closed Off-Road Vehicle Engine D4EA-F/D4EA-V	GDS24300	Drive Shaft	48T	30	28	65	95	653			
	2006.03-2007.12	MT	L	F	Closed Off-Road Vehicle Engine D4EA-F/D4EA-V	GDS24352	Drive Shaft	48T	27	27	62	94.5	671			
	2006.03-2007.12	MT	R	F	Closed Off-Road Vehicle Engine D4EA-F/D4EA-V	GDS24221	Drive Shaft	48T	27	26	61.9	95	610			
	2006.03-2007.12	MT	R	F	Closed Off-Road Vehicle Engine D4EA-F/D4EA-V	GCI39063	Inner Joint		26	25	42	39.5	68.5			
	2006.03-2007.12		R	F	Closed Off-Road Vehicle Engine D4EA-F/D4EA-V	GCI24030	Inner Joint		26	25	42	40	68			

	 YEAR	TRANSM	L/R	F/R		G-AP Ref.	PRODUCT	ABS	Technical Specifications							
									A	B	C	H	L	P		
<b>HYUNDAI TUCSON (JM)</b>																
2.0 CRDi (103 kW)	2006.03-2007.12			R	Closed Off-Road Vehicle Engine D4EA-F/D4EA-V	GC024178	Outer Joint	48T	27	23	60	94	60	M		
	2006.03-2007.12				Closed Off-Road Vehicle Engine D4EA-F/D4EA-V	GC024048	Outer Joint	48T	27	23	62.2	95	60	M		
	2006.04-2010.03	MT	L	F	Closed Off-Road Vehicle Engine D4EA-V	GDS24300	Drive Shaft	48T	30	28	65	95	653			
	2006.04-2010.03	MT	L	F	Closed Off-Road Vehicle Engine D4EA-V	GDS24352	Drive Shaft	48T	27	27	62	94.5	671			
	2006.04-2010.03	MT/AT	R	F	Closed Off-Road Vehicle Engine D4EA-V	GDS24221	Drive Shaft	48T	27	26	61.9	95	610			
	2006.04-2010.03	MT/AT	R	F	Closed Off-Road Vehicle Engine D4EA-V	GCI39063	Inner Joint		26	25	42	39.5	68.5			
	2006.04-2010.03		R	F	Closed Off-Road Vehicle Engine D4EA-V	GCI24030	Inner Joint		26	25	42	40	68			
	2006.04-2010.03				Closed Off-Road Vehicle Engine D4EA-V	GC024048	Outer Joint	48T	27	23	62.2	95	60	M		
2.0 CRDi (110 kW)	2009.01-2010.03	MT	L	F	Closed Off-Road Vehicle Engine D4EA	GDS24300	Drive Shaft	48T	30	28	65	95	653			
	2009.01-2010.03		R	F	Closed Off-Road Vehicle Engine D4EA	GCI24030	Inner Joint		26	25	42	40	68			
	2009.01-2010.03		R		Closed Off-Road Vehicle Engine D4EA	GC024178	Outer Joint	48T	27	23	60	94	60	M		
	2009.01-2010.03	6MT			Closed Off-Road Vehicle Engine D4EA	GC024148	Outer Joint	48T	30	36	65	93	67.5	I		
	2009.01-2010.03				Closed Off-Road Vehicle Engine D4EA	GC024153	Outer Joint	48T	30	25	65	95	69.5	M		
2.0 CRDi (83 kW)	2004.08-2006.03	MT	L	F	Closed Off-Road Vehicle Engine D4EA	GDS24300	Drive Shaft	48T	30	28	65	95	653			
	2004.08-2006.03	MT	L	F	Closed Off-Road Vehicle Engine D4EA	GDS24352	Drive Shaft	48T	27	27	62	94.5	671			
	2004.08-2006.03	MT/AT	R	F	Closed Off-Road Vehicle Engine D4EA	GDS24221	Drive Shaft	48T	27	26	61.9	95	610			
	2004.08-2006.03	MT/AT	R	F	Closed Off-Road Vehicle Engine D4EA	GCI39063	Inner Joint		26	25	42	39.5	68.5			
	2004.08-2006.03		R	F	Closed Off-Road Vehicle Engine D4EA	GCI24030	Inner Joint		26	25	42	40	68			
	2004.08-2006.03				Closed Off-Road Vehicle Engine D4EA	GC024048	Outer Joint	48T	27	23	62.2	95	60	M		
	2004.08-2010.03	MT	L	F	Closed Off-Road Vehicle Engine D4EA	GDS24300	Drive Shaft	48T	30	28	65	95	653			
	2004.08-2010.03	MT	L	F	Closed Off-Road Vehicle Engine D4EA	GDS24352	Drive Shaft	48T	27	27	62	94.5	671			
	2004.08-2010.03	MT/AT	R	F	Closed Off-Road Vehicle Engine D4EA	GDS24221	Drive Shaft	48T	27	26	61.9	95	610			
	2004.08-2010.03	MT/AT	R	F	Closed Off-Road Vehicle Engine D4EA	GCI39063	Inner Joint		26	25	42	39.5	68.5			
	2004.08-2010.03		R	F	Closed Off-Road Vehicle Engine D4EA	GCI24030	Inner Joint		26	25	42	40	68			
	2004.08-2010.03		R		Closed Off-Road Vehicle Engine D4EA	GC024178	Outer Joint	48T	27	23	60	94	60	M		
	2004.08-2010.03				Closed Off-Road Vehicle Engine D4EA	GC024048	Outer Joint	48T	27	23	62.2	95	60	M		
	2.0 CRDi 4WD (100 kW)	2006.01-					GC099289	Outer Joint	48T	27	26	62	94.5	65	M	
2.0 CRDi 4WD (83 kW)	2004.08-					GC099289	Outer Joint	48T	27	26	62	94.5	65	M		
2.7 (129 kW)	2004.08-2010.03		L	F	Closed Off-Road Vehicle Engine G6BA-G	GDS24172	Drive Shaft	48T	27	27	62.2	95	668			
	2004.08-2010.03		R	F	Closed Off-Road Vehicle Engine G6BA-G	GDS24173	Drive Shaft	48T	27	26	62.2	95	609			
	2004.08-2010.03		R	F	Closed Off-Road Vehicle Engine G6BA-G	GCI24030	Inner Joint		26	25	42	40	68			
	2004.08-2010.03	MT/AT		R	Closed Off-Road Vehicle Engine G6BA-G	GDS24287	Drive Shaft	48T	27	27	60	94	800			
	2004.08-2010.03		R		Closed Off-Road Vehicle Engine G6BA-G	GC024178	Outer Joint	48T	27	23	60	94	60	M		
<b>VELOSTER</b>																
- 2WD	2011-	6AT	L		DOHC - MPI	GDS24289	Drive Shaft	46T	27	27	60	95	956			
	2011-	6AT	L		DOHC - MPI	GC024161	Outer Joint	46T	27	23	60	95	57	M		
	2011-	6AT	R		DOHC - MPI	GDS24288	Drive Shaft	46T	27	27	60	95	669			
<b>VELOSTER (FS)</b>																
1.6 GDi (103 kW)	2011.03-	MT	R	F	Coupe Engine G4FD	GDS24398	Drive Shaft	46T	27	25	60	94.5	965			
<b>VERNA</b>																
-						GC099164	Outer Joint		25	30	49.9	94.5	56	O		
1.5	1999.06-	4AT				GC024075	Outer Joint		25	22	52.5	95	58	M		
	1999.06-	5MT				GC024075	Outer Joint		25	22	52.5	95	58	M		
1.5/1.6 2WD	1999-2001	4AT	L		MPI-SOHC	GDS39213	Drive Shaft	44T	25	25	52.5	95	625			
	1999-2001	4AT	L		MPI-SOHC	GCI24010	Inner Joint		25	22	35	63	87			
	1999-2001	5MT	L		MPI-SOHC	GDS39211	Drive Shaft	44T	25	25	52.5	95	622			
	1999-2001	5MT	L		MPI-SOHC	GC039105	Outer Joint	44T	25	22	52.5	95	58	M		
	1999-2001	4AT	R		MPI-SOHC	GDS39212	Drive Shaft	44T	25	25	52.5	95	911			
	1999-2001	5MT	R		MPI-SOHC	GDS39214	Drive Shaft	44T	25	25	52.5	95	912			
<b>INFINITI G20</b>																
-	1991-1993					GCI41013	Inner Joint		25	25	33	345	102.5			
<b>I30</b>																
-	1996-1999					GCI41008	Inner Joint		29/31	27	46	86.8	124			
<b>QX4</b>																
-	1997-2003				4WD SUV/Truck/VAN	GCI41014	Inner Joint			27		81.2				
<b>ISUZU AMIGO</b>																
-	1989-1995					GCI26001	Inner Joint		17	26	30	517	97.5			
-	1989-1995					GCI26002	Inner Joint		17	26	30	98	98.5			









		TRANSM	L/R	F/R		G-AP Ref.	PRODUCT	ABS	Technical Specifications									
									YEAR	A	B	C	H	L	P			
<b>ISUZU AXIOM</b>																		
-	2002-			L/R	F		GDS23129	Drive Shaft		17	17	53	144	606.5				
<b>CAMPO (KB)</b>																		
2.2 D (39 kW)	1986.04-	1990.12			R	Pickup Engine C223	GC026003	Outer Joint		17	26	53	144	70.5	M			
	1986.04-	1990.12			R	Pickup Engine C223	GC026002	Outer Joint		17	23	53	144	62.5	M			
2.2 D 4WD (39 kW)	1983.01-	1990.12				Pickup Engine C223	GC026003	Outer Joint		17	26	53	144	70.5	M			
	1983.01-	1990.12				Pickup Engine C223	GC026002	Outer Joint		17	23	53	144	62.5	M			
<b>FASTER RODEO (TFSIS)</b>																		
2.2	1988-					Engine C223	GCI26005	Inner Joint		23	23	28	97	90				
	1988-					Engine C223	GCI26004	Inner Joint		23	23	28	487	90				
<b>GEMINI (JT)</b>																		
1.5 (52 kW)	1988.02-	1990.12			F	Hatchback Engine 4XC1UKat.	GC021002	Outer Joint		22	21	50	94.5	54	M			
	1988.02-	1990.12			F	Saloon Engine 4XC1UKat.	GC021002	Outer Joint		22	21	50	94.5	54	M			
	1988.02-	1990.12			F	Hatchback Engine 4XC1UKat.	GC026001	Outer Joint		22	22	50	91	54	I			
	1988.02-	1990.12			F	Saloon Engine 4XC1UKat.	GC026001	Outer Joint		22	22	50	91	54	I			
1.5 D (37 kW)	1988.02-	1990.12	MT/AT		F	Hatchback Engine 4EC1	GC021002	Outer Joint		22	21	50	94.5	54	M			
	1988.02-	1990.12	MT/AT		F	Saloon Engine 4EC1	GC021002	Outer Joint		22	21	50	94.5	54	M			
	1988.02-	1990.12			F	Hatchback Engine 4EC1	GC026001	Outer Joint		22	22	50	91	54	I			
	1988.02-	1990.12			F	Saloon Engine 4EC1	GC026001	Outer Joint		22	22	50	91	54	I			
1.5 TD (49 kW)	1988.02-	1990.12	MT/AT		F	Hatchback Engine 4EC1T	GC021002	Outer Joint		22	21	50	94.5	54	M			
	1988.02-	1990.12	MT/AT		F	Saloon Engine 4EC1T	GC021002	Outer Joint		22	21	50	94.5	54	M			
	1988.02-	1990.12			F	Saloon Engine 4EC1T	GC026001	Outer Joint		22	22	50	91	54	I			
	1988.02-	1990.12			F	Hatchback Engine 4EC1T	GC026005	Outer Joint		24	21	50	90.5	55	M			
	1988.02-	1990.12			F	Hatchback Engine 4EC1T	GC026006	Outer Joint		24	22	50	90.5	55	I			
1.6 GTi 16V (84 kW)	1988.08-	1990.12	MT/AT		F	Hatchback Engine 4XE1	GC021002	Outer Joint		22	21	50	94.5	54	M			
<b>IMPULSE</b>																		
-	1990-	1992	MT			2WD	GC088015	Outer Joint		24	30	50	87.5	55	M			
<b>PIAZZA (JR_)</b>																		
2.0 Turbo (104 kW)	1985.06-	1990.12			R	Coupe Engine 4ZC1-T	GC026002	Outer Joint		17	23	53	144	62.5	M			
<b>PICK UP</b>																		
-	1988-	1995					GCI26001	Inner Joint		17	26	30	517	97.5				
	1988-	1995					GCI26002	Inner Joint		17	26	30	98	98.5				
<b>RODEO</b>																		
-	1991-	1995					GCI26001	Inner Joint		17	26	30	517	97.5				
	1991-	1995					GCI26002	Inner Joint		17	26	30	98	98.5				
	1992-	2002				Truck	GCI26003	Inner Joint		17	33	30	517	90.5				
	1992-	2002			L	Truck	GDS23003	Drive Shaft		17	17	53	144	970				
	1992-	2002			R	Truck	GDS23002	Drive Shaft		17	17	53	144	550				
	1998-	2002				4WD	GCI23001	Inner Joint		17	33	30	97.5	91.5				
<b>STYLUS</b>																		
-	1991-	1993				DOHC	GC088015	Outer Joint		24	30	50	87.5	55	M			
<b>TROOPER</b>																		
3.0 DTi (118 kW)	1998.05-		5MT		F	Closed Off-Road Vehicle Engine 4JX1	GC026007	Outer Joint		17	25	53	144	70.5	M			
	2000.04-		5MT		F	Open Off-Road Vehicle Engine 4JX1T	GC026007	Outer Joint		17	25	53	144	70.5	M			
3.5 V6 24V (158 kW)	1998.05-				F	Closed Off-Road Vehicle Engine 6VE1	GC026007	Outer Joint		17	25	53	144	70.5	M			
	2000.04-				F	Open Off-Road Vehicle Engine 6VE1	GC026007	Outer Joint		17	25	53	144	70.5	M			
	2000.04-						GC026009	Outer Joint		17	25	53	144	69.5	M			
<b>TROOPER &amp; TROOPER II</b>																		
-	1988-	1991					GCI26001	Inner Joint		17	26	30	517	97.5				
	1988-	1991					GCI26002	Inner Joint		17	26	30	98	98.5				
	1998-	2002			F		GCI23001	Inner Joint		17	33	30	97.5	91.5				
<b>TROOPER (UB)</b>																		
3.2 (130 kW)	1991.08-	1998.07			F	Closed Off-Road Vehicle Engine 6VD1	GC026004	Outer Joint		17	33	53	144	69.5	I			
<b>TROOPER (UBS)</b>																		
2.2 D 4x4 (39 kW)	1984.05-	1989.12				Closed Off-Road Vehicle Engine C223	GC026003	Outer Joint		17	26	53	144	70.5	M			
	1984.05-	1989.12				Closed Off-Road Vehicle Engine C223	GC026002	Outer Joint		17	23	53	144	62.5	M			
2.2 TD (53 kW)	1984.03-	1991.12	MT		F	Open Off-Road Vehicle Engine C223T	GC022002	Outer Joint		24	23	47.9	149	56	M			
	1984.03-	1991.12				Open Off-Road Vehicle Engine C223T	GC026003	Outer Joint		17	26	53	144	70.5	M			
	1984.03-	1991.12				Open Off-Road Vehicle Engine C223T	GC026002	Outer Joint		17	23	53	144	62.5	M			
2.3 (66 kW)	1985.11-	1991.12	MT		F	Open Off-Road Vehicle Engine 4ZD1	GC022002	Outer Joint		24	23	47.9	149	56	M			
2.6 i (85 kW)	1987.10-	1991.12				Open Off-Road Vehicle Engine 4ZE1	GC026003	Outer Joint		17	26	53	144	70.5	M			
	1987.10-	1991.12				Open Off-Road Vehicle Engine 4ZE1	GC026002	Outer Joint		17	23	53	144	62.5	M			











	 YEAR	TRANSM	L/R	F/R		G-AP Ref.	PRODUCT	ABS	Technical Specifications												
									A	B	C	H	L	P							
<b>ISUZU</b>																					
<b>TROOPER (UBS)</b>																					
2.8 TD (71 kW)	1987.10-	1991.12				Closed Off-Road Vehicle Engine 4JB1T	GC026003	Outer Joint		17	26	53	144	70.5	M						
	1987.10-	1991.12				Closed Off-Road Vehicle Engine 4JB1T	GC026002	Outer Joint		17	23	53	144	62.5	M						
2.8 TD (78 kW)	1988.10-	1991.12				Closed Off-Road Vehicle Engine 4JB1-TC	GC026003	Outer Joint		17	26	53	144	70.5	M						
	1988.10-	1991.12				Closed Off-Road Vehicle Engine 4JB1-TC	GC026002	Outer Joint		17	23	53	144	62.5	M						
<b>JAGUAR</b>																					
<b>S-TYPE (CCX)</b>																					
2.5 V6 (147 kW)	2002.04-	2007.10		R	R	Saloon	GDS18230	Drive Shaft	46T	28	28	55	106	831							
	2002.04-	2007.10		R	R	Saloon	GCI18179	Inner Joint		28	28	46	101	78.5							
	2002.04-	2007.10		R	R	Saloon	GC018271	Outer Joint	46T	28	24	55	106	59	M						
2.7 D (152 kW)	2004.06-	2007.10		R	R	Saloon Engine AJD	GDS18342	Drive Shaft	46W	28	28	54.9	105.5	830							
3.0 V6 (175 kW)	1999.01-	2007.10		R	R	Saloon Engine AJ-V6	GDS18342	Drive Shaft	46W	28	28	54.9	105.5	830							
4.2 V8 (219 kW)	2002.04-	2007.10		R	R	Saloon	GDS18342	Drive Shaft	46W	28	28	54.9	105.5	830							
R 4.2 V8 (291 kW)	2002.04-	2007.10		R	R	Saloon Engine AJ8FT	GDS18342	Drive Shaft	46W	28	28	54.9	105.5	830							
<b>X-TYPE</b>																					
2.0 D (96 kW)	2004.02-	2009.12		L	F	Estate Engine FMBA/FMBB/R4-X404	GDS99177	Drive Shaft		27	26	56.1	91.5	624							
	2004.02-	2009.12		L	F	Estate Engine FMBA/FMBB/R4-X404	GCI99147	Inner Joint		26	24	40	68.5	159.5							
	2004.02-	2009.12		L/R	F	Estate Engine FMBA/FMBB/R4-X404	GC099147	Outer Joint		27	24	56.1	91.5	58.5	M						
	2004.02-	2009.12		R	F	Estate Engine FMBA/FMBB/R4-X404	GDS99176	Drive Shaft		27	26	56.1	91.5	956							
	2004.02-	2009.12		R	F	Estate Engine FMBA/FMBB/R4-X404	GCI99146	Inner Joint		26	24	40	469	91							
	2004.02-	2009.12		L	R	Estate Engine FMBA/FMBB/R4-X404	GDS35030	Drive Shaft	32W	28	26	46	85	791							
	2004.02-	2009.12		R	R	Estate Engine FMBA/FMBB/R4-X404	GDS35029	Drive Shaft	32W	28	26	46	85	826							
	2004.02-	2009.12		R	R	Estate Engine FMBA/FMBB/R4-X404	GCI35007	Inner Joint		26	24	58	83	83							
2.0 V6 (115 kW)	2003.11-	2009.03		L	F	Estate	GDS99177	Drive Shaft		27	26	56.1	91.5	624							
	2003.11-	2009.03		L	F	Estate	GCI99147	Inner Joint		26	24	40	68.5	159.5							
	2003.11-	2009.03		L/R	F	Estate	GC099147	Outer Joint		27	24	56.1	91.5	58.5	M						
	2003.11-	2009.03		R	F	Estate	GDS99176	Drive Shaft		27	26	56.1	91.5	956							
	2003.11-	2009.03		R	F	Estate	GCI99146	Inner Joint		26	24	40	469	91							
	2003.11-	2009.03		L	R	Estate	GDS35030	Drive Shaft	32W	28	26	46	85	791							
	2003.11-	2009.03		R	R	Estate	GDS35029	Drive Shaft	32W	28	26	46	85	826							
	2003.11-	2009.03		R	R	Estate	GCI35007	Inner Joint		26	24	58	83	83							
2.2 D (107 kW)	2007.01-	2009.12		L	F	Estate Engine LJ46G	GDS99177	Drive Shaft		27	26	56.1	91.5	624							
	2007.01-	2009.12		L	F	Estate Engine LJ46G	GCI99147	Inner Joint		26	24	40	68.5	159.5							
	2007.01-	2009.12		L/R	F	Estate Engine LJ46G	GC099147	Outer Joint		27	24	56.1	91.5	58.5	M						
	2007.01-	2009.12		R	F	Estate Engine LJ46G	GDS99176	Drive Shaft		27	26	56.1	91.5	956							
	2007.01-	2009.12		R	F	Estate Engine LJ46G	GCI99146	Inner Joint		26	24	40	469	91							
	2007.01-	2009.12		L	R	Estate Engine LJ46G	GDS35030	Drive Shaft	32W	28	26	46	85	791							
	2007.01-	2009.12		R	R	Estate Engine LJ46G	GDS35029	Drive Shaft	32W	28	26	46	85	826							
	2007.01-	2009.12		R	R	Estate Engine LJ46G	GCI35007	Inner Joint		26	24	58	83	83							
2.2 D (110 kW)	2005.10-	2009.12		L	F	Estate Engine LJ46G	GDS99177	Drive Shaft		27	26	56.1	91.5	624							
	2005.10-	2009.12		L	F	Estate Engine LJ46G	GCI99147	Inner Joint		26	24	40	68.5	159.5							
	2005.10-	2009.12		L/R	F	Estate Engine LJ46G	GC099147	Outer Joint		27	24	56.1	91.5	58.5	M						
	2005.10-	2009.12		R	F	Estate Engine LJ46G	GDS99176	Drive Shaft		27	26	56.1	91.5	956							
	2005.10-	2009.12		R	F	Estate Engine LJ46G	GCI99146	Inner Joint		26	24	40	469	91							
	2005.10-	2009.12		L	R	Estate Engine LJ46G	GDS35030	Drive Shaft	32W	28	26	46	85	791							
	2005.10-	2009.12		R	R	Estate Engine LJ46G	GDS35029	Drive Shaft	32W	28	26	46	85	826							
	2005.10-	2009.12		R	R	Estate Engine LJ46G	GCI35007	Inner Joint		26	24	58	83	83							
2.2 D (114 kW)	2005.10-	2009.12		L	F	Estate Engine LJ46G	GDS99177	Drive Shaft		27	26	56.1	91.5	624							
	2005.10-	2009.12		L	F	Estate Engine LJ46G	GCI99147	Inner Joint		26	24	40	68.5	159.5							
	2005.10-	2009.12		L/R	F	Estate Engine LJ46G	GC099147	Outer Joint		27	24	56.1	91.5	58.5	M						
	2005.10-	2009.12		R	F	Estate Engine LJ46G	GDS99176	Drive Shaft		27	26	56.1	91.5	956							
	2005.10-	2009.12		R	F	Estate Engine LJ46G	GCI99146	Inner Joint		26	24	40	469	91							
	2005.10-	2009.12		R	R	Estate Engine LJ46G	GCI35007	Inner Joint		26	24	58	83	83							
2.5 (144 kW)	2004.02-	2009.12		R	F	Estate	GDS18240	Drive Shaft		27	23	56.1	91.5	970							
	2004.02-	2009.12		L	R	Estate	GDS35030	Drive Shaft	32W	28	26	46	85	791							
	2004.02-	2009.12		R	R	Estate	GDS35029	Drive Shaft	32W	28	26	46	85	826							
	2004.02-	2009.12			R	Estate	GCI35007	Inner Joint		26	24	58	83	83							
3.0 (169 kW)	2004.02-	2009.12		R	F	Estate Engine AJ-V6	GDS18240	Drive Shaft		27	23	56.1	91.5	970							
	2004.02-	2009.12		L	R	Estate Engine AJ-V6	GDS35030	Drive Shaft	32W	28	26	46	85	791							
	2004.02-	2009.12		R	R	Estate Engine AJ-V6	GDS35029	Drive Shaft	32W	28	26	46	85	826							
	2004.02-	2009.12		R	R	Estate Engine AJ-V6	GCI35007	Inner Joint		26	24	58	83	83							
<b>X-TYPE (CF1)</b>																					
2.0 D (96 kW)	2003.07-	2005.10					GC099147	Outer Joint		27	24	56.1	91.5	58.5	M						
	2003.07-	2009.11		L	F	Saloon Engine FMBA/FMBB/R4-X404	GDS99177	Drive Shaft		27	26	56.1	91.5	624							

		TRANSM	L/R	F/R		G-AP Ref.	PRODUCT	ABS	Technical Specifications								
									YEAR	A	B	C	H	L	P		
<b>JAGUAR</b>																	
<b>X-TYPE (CF1)</b>																	
2.0 D (96 kW)	2003.07-2009.11		L	F	Saloon Engine FMBA/FMBB/R4-X404	GCI99147	Inner Joint		26	24	40	68.5	159.5				
	2003.07-2009.11		L/R	F	Saloon Engine FMBA/FMBB/R4-X404	GC099147	Outer Joint		27	24	56.1	91.5	58.5	M			
	2003.07-2009.11		R	F	Saloon Engine FMBA/FMBB/R4-X404	GDS99176	Drive Shaft		27	26	56.1	91.5	956				
	2003.07-2009.11		R	F	Saloon Engine FMBA/FMBB/R4-X404	GCI99146	Inner Joint		26	24	40	469	91				
	2003.07-2009.11		L	R	Saloon Engine FMBA/FMBB/R4-X404	GDS35030	Drive Shaft	32W	28	26	46	85	791				
	2003.07-2009.11		R	R	Saloon Engine FMBA/FMBB/R4-X404	GDS35029	Drive Shaft	32W	28	26	46	85	826				
	2003.07-2009.11			R	Saloon Engine FMBA/FMBB/R4-X404	GCI35007	Inner Joint		26	24	58	83	83				
2.0 V6 (115 kW)	2002.03-2005.10		L	F	Saloon	GDS99177	Drive Shaft		27	26	56.1	91.5	624				
	2002.03-2005.10		L	F	Saloon	GCI99147	Inner Joint		26	24	40	68.5	159.5				
	2002.03-2005.10		L/R	F	Saloon	GC099147	Outer Joint		27	24	56.1	91.5	58.5	M			
	2002.03-2005.10		R	F	Saloon	GDS99176	Drive Shaft		27	26	56.1	91.5	956				
	2002.03-2005.10		R	F	Saloon	GCI99146	Inner Joint		26	24	40	469	91				
	2002.03-2005.10		L	R	Saloon	GDS35030	Drive Shaft	32W	28	26	46	85	791				
	2002.03-2005.10		R	R	Saloon	GDS35029	Drive Shaft	32W	28	26	46	85	826				
	2002.03-2005.10			R	Saloon	GCI35007	Inner Joint		26	24	58	83	83				
2.2 D (107 kW)	2007.01-2009.11		L	F	Saloon Engine LJ46G	GDS99177	Drive Shaft		27	26	56.1	91.5	624				
	2007.01-2009.11		L	F	Saloon Engine LJ46G	GCI99147	Inner Joint		26	24	40	68.5	159.5				
	2007.01-2009.11		L/R	F	Saloon Engine LJ46G	GC099147	Outer Joint		27	24	56.1	91.5	58.5	M			
	2007.01-2009.11		R	F	Saloon Engine LJ46G	GDS99176	Drive Shaft		27	26	56.1	91.5	956				
	2007.01-2009.11		R	F	Saloon Engine LJ46G	GCI99146	Inner Joint		26	24	40	469	91				
	2007.01-2009.11			R	Saloon Engine LJ46G	GCI35007	Inner Joint		26	24	58	83	83				
2.2 D (110 kW)	2005.10-2009.11		L	F	Saloon Engine LJ46G	GDS99177	Drive Shaft		27	26	56.1	91.5	624				
	2005.10-2009.11		L	F	Saloon Engine LJ46G	GCI99147	Inner Joint		26	24	40	68.5	159.5				
	2005.10-2009.11		L/R	F	Saloon Engine LJ46G	GC099147	Outer Joint		27	24	56.1	91.5	58.5	M			
	2005.10-2009.11		R	F	Saloon Engine LJ46G	GDS99176	Drive Shaft		27	26	56.1	91.5	956				
	2005.10-2009.11		R	F	Saloon Engine LJ46G	GCI99146	Inner Joint		26	24	40	469	91				
	2005.10-2009.11		L	R	Saloon Engine LJ46G	GDS35030	Drive Shaft	32W	28	26	46	85	791				
	2005.10-2009.11		R	R	Saloon Engine LJ46G	GDS35029	Drive Shaft	32W	28	26	46	85	826				
	2005.10-2009.11			R	Saloon Engine LJ46G	GCI35007	Inner Joint		26	24	58	83	83				
2.2 D (114 kW)	2005.10-2009.11		L	F	Saloon Engine LJ46G	GDS99177	Drive Shaft		27	26	56.1	91.5	624				
	2005.10-2009.11		L	F	Saloon Engine LJ46G	GCI99147	Inner Joint		26	24	40	68.5	159.5				
	2005.10-2009.11		L/R	F	Saloon Engine LJ46G	GC099147	Outer Joint		27	24	56.1	91.5	58.5	M			
	2005.10-2009.11		R	F	Saloon Engine LJ46G	GDS99176	Drive Shaft		27	26	56.1	91.5	956				
	2005.10-2009.11		R	F	Saloon Engine LJ46G	GCI99146	Inner Joint		26	24	40	469	91				
	2005.10-2009.11			R	Saloon Engine LJ46G	GCI35007	Inner Joint		26	24	58	83	83				
2.5 V6 (144 kW)	2001.06-2009.11		R	F	Saloon	GDS18240	Drive Shaft		27	23	56.1	91.5	970				
	2001.06-2009.11		L	R	Saloon	GDS35030	Drive Shaft	32W	28	26	46	85	791				
	2001.06-2009.11		R	R	Saloon	GDS35029	Drive Shaft	32W	28	26	46	85	826				
	2001.06-2009.11			R	Saloon	GCI35007	Inner Joint		26	24	58	83	83				
	2001.06-					GC099147	Outer Joint		27	24	56.1	91.5	58.5	M			
3.0 V6 (169 kW)	2001.06-2007.11		R	F	Saloon Engine AJ-V6	GDS18240	Drive Shaft		27	23	56.1	91.5	970				
	2001.06-2007.11		L	R	Saloon Engine AJ-V6	GDS35030	Drive Shaft	32W	28	26	46	85	791				
	2001.06-2007.11		R	R	Saloon Engine AJ-V6	GDS35029	Drive Shaft	32W	28	26	46	85	826				
	2001.06-2007.11			R	Saloon Engine AJ-V6	GCI35007	Inner Joint		26	24	58	83	83				
<b>X-TYPE ESTATE</b>																	
2.0 D (96 kW)	2004.02-2005.10					GC099147	Outer Joint		27	24	56.1	91.5	58.5	M			
2.0 V6 (115 kW)	2003.11-					GC099147	Outer Joint		27	24	56.1	91.5	58.5	M			
<b>JEEP</b>																	
<b>CHEROKEE (KJ)</b>																	
2.4 (108 kW)	2001.09-				Transmission Cardante	GC099032	Outer Joint			25		30		I			
2.4 LareDo (108 kW)	2001.10-2004.09				Transmission Cardante	GC099032	Outer Joint			25		30		I			
2.5 CRD (105 kW)	2001.09-				Transmission Cardante	GC099032	Outer Joint			25		30		I			
2.5 TD (85 kW)	1999.01-2001.08				Transmission Cardante	GC099032	Outer Joint			25		30		I			
2.8 CRD (110 kW)	2002.11-				Transmission Cardante	GC099032	Outer Joint			25		30		I			
2.8 CRD (120 kW)	2004.11-				Transmission Cardante	GC099032	Outer Joint			25		30		I			
3.7 V6 (150 kW)	2003.08-				Transmission Cardante	GC099032	Outer Joint			25		30		I			
3.7 V6 (155 kW)	2003.08-				Transmission Cardante	GC099032	Outer Joint			25		30		I			
3.7 V6 LareDo (150 kW)	2001.01-2004.09				Transmission Cardante	GC099032	Outer Joint			25		30		I			
<b>CHEROKEE (XJ)</b>																	
2.5 i 4x4 (87 kW)	1984.10-2001.09		L	F	Closed Off-Road Vehicle Engine EPE	GDS99167	Drive Shaft	54T	27		60	102.5	576				
	1984.10-2001.09		R	F	Closed Off-Road Vehicle Engine EPE	GDS99168	Drive Shaft	54T	27		60	102.5	979				









		TRANSM	L/R	F/R		G-AP Ref.	PRODUCT	ABS	Technical Specifications						
									YEAR	A	B	C	H	L	P
<b>JEEP</b>															
<b>CHEROKEE (XJ)</b>															
2.5 TDi 4x4 (85 kW)	1996.10-	2001.09		L	F	Closed Off-Road Vehicle Engine ENC	GDS99167	Drive Shaft	54T	27		60	102.5	576	
	1996.10-	2001.09		R	F	Closed Off-Road Vehicle Engine ENC	GDS99168	Drive Shaft	54T	27		60	102.5	979	
4.0 i (135 kW)	1999.02-	2001.09		L	F	Closed Off-Road Vehicle Engine MX	GDS99167	Drive Shaft	54T	27		60	102.5	576	
	1999.02-	2001.09		R	F	Closed Off-Road Vehicle Engine MX	GDS99168	Drive Shaft	54T	27		60	102.5	979	
4.0 i 4x4 (131 kW)	1995.01-	2001.09		L	F	Closed Off-Road Vehicle Engine ERH	GDS99167	Drive Shaft	54T	27		60	102.5	576	
	1995.01-	2001.09		R	F	Closed Off-Road Vehicle Engine ERH	GDS99168	Drive Shaft	54T	27		60	102.5	979	
<b>CHEROKEE / COMANCHE / GRAND CHEROKEE / GRAND WAGONEER / WAGONEER</b>															
-	1984-	1985				4WD SUV/Truck/VAN	GC016006	Outer Joint		27	32	60	104	70	I
	1986-	1987				4WD SUV/Truck/VAN	GC016006	Outer Joint		27	32	60	104	70	I
	1986-	1987				4WD SUV/Truck/VAN	GC016003	Outer Joint	48T	27	32	60	104	70	I
	1988-	1992				4WD SUV/Truck/VAN	GC016003	Outer Joint	48T	27	32	60	104	70	I
<b>COMMANDER (XK)</b>															
3.0 CRD 4x4 (160 kW)	2006.02-	2007.12				Closed Off-Road Vehicle Engine EXL	GC089056	Outer Joint		29	36	70	112	59.5	I
5.7 V8 4x4 (240 kW)	2006.02-	2006.10	AT	L	F	Closed Off-Road Vehicle Engine EZB	GDS88115	Drive Shaft		29	29	70	112	653	
	2006.02-	2006.10	AT	R	F	Closed Off-Road Vehicle Engine EZB	GDS88150	Drive Shaft		29	29	70	112	607	
	2006.02-	2006.10				Closed Off-Road Vehicle Engine EZB	GC089056	Outer Joint		29	36	70	112	59.5	I
<b>COMPASS (MK49)</b>															
2.0 CRD (103 kW)	2007.04-		MT	R	F	Closed Off-Road Vehicle Engine ECD/ECE	GDS51041	Drive Shaft		28	24	59.5	95	977.5	
	2007.04-					Closed Off-Road Vehicle Engine ECD/ECE	GC015010	Outer Joint		28	36	59.5	95	68	I
2.4 4x4 (125 kW)	2007.04-		MT	R	F	Closed Off-Road Vehicle Engine ED3	GDS51041	Drive Shaft		28	24	59.5	95	977.5	
	2007.04-					Closed Off-Road Vehicle Engine ED3	GC015010	Outer Joint		28	36	59.5	95	68	I
<b>GRAND</b>															
-	1995-	2008					GCI16005	Inner Joint			25		40		
<b>GRAND CHEROKEE</b>															
2.5	1999-	2004					GC099032	Outer Joint			25		30		I
<b>GRAND CHEROKEE (ZJ)</b>															
2.5 TD 4x4 (85 kW)	1995.10-	1999.04				Closed Off-Road Vehicle Engine M51/M52	GC016007	Outer Joint	54T	27	32	60	104	70	I
4.0 i 4x4 (130 kW)	1995.10-	1999.04				Closed Off-Road Vehicle Engine S01	GC016007	Outer Joint	54T	27	32	60	104	70	I
4.0 i 4x4 (132 kW)	1991.09-	1999.04				Closed Off-Road Vehicle Engine ERH	GC016007	Outer Joint	54T	27	32	60	104	70	I
4.0 i 4x4 (135 kW)	1991.09-	1999.04				Closed Off-Road Vehicle Engine MX	GC016007	Outer Joint	54T	27	32	60	104	70	I
5.2 4x4 (156 kW)	1995.10-	1999.04				Closed Off-Road Vehicle Engine Y01	GC016007	Outer Joint	54T	27	32	60	104	70	I
5.2 i 4x4 (155 kW)	1992.01-	1999.04				Closed Off-Road Vehicle Engine ELF	GC016007	Outer Joint	54T	27	32	60	104	70	I
5.2 i 4x4 (158 kW)	1992.09-	1999.04				Closed Off-Road Vehicle Engine Y	GC016007	Outer Joint	54T	27	32	60	104	70	I
<b>GRAND CHEROKEE II (WJ, WG)</b>															
2.7 CRD 4WD (120 kW)	2004.10-	2005.09				Transmission Cardanic	GC099032	Outer Joint			25		30		I
2.7 CRD 4x4 (120 kW)	2001.10-	2005.09	AT	L	F	Closed Off-Road Vehicle Engine ENF	GDS16009	Drive Shaft	48T	27		65.4	108	589	
	2001.10-	2005.09	AT	L/R	F	Closed Off-Road Vehicle Engine ENF	GC016002	Outer Joint		27	32	65.4	108	70	I
	2001.10-	2005.09			F	Closed Off-Road Vehicle Engine ENF	GDS35040	Drive Shaft					30	795	
2.7 CRD LareDo (120 kW)	2004.10-	2005.09				Transmission Cardanic	GC099032	Outer Joint			25		30		I
3.1 TD 4x4 (103 kW)	1999.04-	2001.12	MT	L	F	Closed Off-Road Vehicle Engine EXA	GDS16009	Drive Shaft	48T	27		65.4	108	589	
	1999.04-	2001.12	MT	L/R	F	Closed Off-Road Vehicle Engine EXA	GC016002	Outer Joint		27	32	65.4	108	70	I
	1999.04-	2001.12			F	Closed Off-Road Vehicle Engine EXA	GDS35040	Drive Shaft					30	795	
3.7 LareDo (157 kW)	2004.10-	2005.09				Transmission Cardanic	GC099032	Outer Joint			25		30		I
4.0 4WD (140 kW)	1999.04-	2005.08				Transmission Cardanic	GC099032	Outer Joint			25		30		I
4.0 4x4 (140 kW)	1999.04-	2005.09				Closed Off-Road Vehicle Engine ERH	GC016005	Outer Joint	48T	27	32	65.4	108	70	I
	1999.04-	2005.09			F	Closed Off-Road Vehicle Engine ERH	GDS16021	Drive Shaft					30	826	
4.7 V8 (162 kW)	1999.04-	2000.08				Transmission Cardanic	GC099032	Outer Joint			25		30		I
4.7 V8 (164 kW)	2000.08-					Transmission Cardanic	GC099032	Outer Joint			25		30		I
4.7 V8 (167 kW)	2004.10-	2005.09	AT	L	F	Closed Off-Road Vehicle Engine EVA	GDS16009	Drive Shaft	48T	27		65.4	108	589	
	2004.10-	2005.09	AT	L/R	F	Closed Off-Road Vehicle Engine EVA	GC016002	Outer Joint		27	32	65.4	108	70	I
4.7 V8 (190 kW)	2001.10-					Transmission Cardanic	GC099032	Outer Joint			25		30		I
4.7 V8 4WD (167 kW)	2003.06-						GC099032	Outer Joint			25		30		I
4.7 V8 4x4 (164 kW)	1999.04-	2005.09	AT	L	F	Closed Off-Road Vehicle Engine EVA	GDS16009	Drive Shaft	48T	27		65.4	108	589	
	1999.04-	2005.09	AT	L/R	F	Closed Off-Road Vehicle Engine EVA	GC016002	Outer Joint		27	32	65.4	108	70	I
	1999.04-	2005.09			F	Closed Off-Road Vehicle Engine EVA	GDS16021	Drive Shaft					30	826	
4.7 V8 4x4 (167 kW)	2003.06-	2005.09	AT	L	F	Closed Off-Road Vehicle Engine EVA	GDS16009	Drive Shaft	48T	27		65.4	108	589	
	2003.06-	2005.09	AT	L/R	F	Closed Off-Road Vehicle Engine EVA	GC016002	Outer Joint		27	32	65.4	108	70	I
	2003.06-	2005.09			F	Closed Off-Road Vehicle Engine EVA	GDS16021	Drive Shaft					30	826	
4.7 V8 4x4 (190 kW)	2001.10-	2005.09	AT	L	F	Closed Off-Road Vehicle Engine EVC	GDS16009	Drive Shaft	48T	27		65.4	108	589	
	2001.10-	2005.09	AT	L/R	F	Closed Off-Road Vehicle Engine EVC	GC016002	Outer Joint		27	32	65.4	108	70	I
	2001.10-	2005.09			F	Closed Off-Road Vehicle Engine EVC	GDS16021	Drive Shaft					30	826	



		YEAR	TRANSM	L/R	F/R		G-AP Ref.	PRODUCT	ABS	Technical Specifications										
										A	B	C	H	L	P					
<b>JEEP</b>																				
<b>GRAND CHEROKEE III (WH)</b>																				
3.0 CRD (160 kW)	2005.06-						GC089056	Outer Joint			29	36	70	112	59.5	I				
<b>GRAND CHEROKEE III (WH, WK)</b>																				
3.0 CRD 4x4 (155 kW)	2006.05-	2010.12	AT	L	F	Closed Off-Road Vehicle Engine EXL	GDS88115	Drive Shaft			29	29	70	112	653					
	2006.05-	2010.12	AT	R	F	Closed Off-Road Vehicle Engine EXL	GDS88150	Drive Shaft			29	29	70	112	607					
	2006.05-	2010.12				Closed Off-Road Vehicle Engine EXL	GC089056	Outer Joint			29	36	70	112	59.5	I				
3.0 CRD 4x4 (160 kW)	2005.06-	2010.12	AT	L	F	Closed Off-Road Vehicle Engine EXL	GDS88115	Drive Shaft			29	29	70	112	653					
	2005.06-	2010.12	AT	R	F	Closed Off-Road Vehicle Engine EXL	GDS88150	Drive Shaft			29	29	70	112	607					
	2005.06-	2010.12				Closed Off-Road Vehicle Engine EXL	GC089056	Outer Joint			29	36	70	112	59.5	I				
5.7 V8 4x4 (240 kW)	2005.06-	2010.12	AT	L	F	Closed Off-Road Vehicle Engine EZB	GDS88115	Drive Shaft			29	29	70	112	653					
	2005.06-	2010.12	AT	R	F	Closed Off-Road Vehicle Engine EZB	GDS88150	Drive Shaft			29	29	70	112	607					
	2005.06-	2010.12				Closed Off-Road Vehicle Engine EZB	GC089056	Outer Joint			29	36	70	112	59.5	I				
6.1 SRT8 4x4 (313 kW)	2006.07-	2010.12				Closed Off-Road Vehicle Engine ESF	GC089056	Outer Joint			29	36	70	112	59.5	I				
<b>LIBERTY</b>																				
-	2001-	2008					GCI16005	Inner Joint				25		40						
	2002-	2005					GC089049	Outer Joint			27	35	57.9	126	64	O				
3.7	2002-	2005					GCI16004	Inner Joint			27	35	34.9	114	113					
<b>PATRIOT (MK74)</b>																				
2.0 CRD 4x4 (103 kW)	2007.02-					Closed Off-Road Vehicle Engine ECD/ECE	GC015010	Outer Joint			28	36	59.5	95	68	I				
<b>WRANGLER II (TJ)</b>																				
2.5 (87 kW)	1996.08-	2007.04				Open Off-Road Vehicle Engine P00	GC016001	Outer Joint			27	32	60	102.5	77.5	I				
	1996.08-	2007.04				Open Off-Road Vehicle Engine P00	GC016004	Outer Joint	54T		27	32	60	102.5	77.5	I				
	1996.08-	2007.04		L	F	Open Off-Road Vehicle Engine P00	GDS16012	Drive Shaft			27		60	102.5	576					
	1996.08-	2007.04		L	F	Open Off-Road Vehicle Engine P00	GDS16003	Drive Shaft	54T		27		60	102.5	576					
	1996.08-	2007.04		R	F	Open Off-Road Vehicle Engine P00	GDS16013	Drive Shaft			27		60	102.5	975.5					
	1996.08-	2007.04		R	F	Open Off-Road Vehicle Engine P00	GDS16004	Drive Shaft	54T		27		60	102.5	975.5					
4.0 (124 kW)	1998.06-	2007.04				Open Off-Road Vehicle	GC016001	Outer Joint			27	32	60	102.5	77.5	I				
	1998.06-	2007.04				Open Off-Road Vehicle	GC016004	Outer Joint	54T		27	32	60	102.5	77.5	I				
	1998.06-	2007.04		L	F	Open Off-Road Vehicle	GDS16012	Drive Shaft			27		60	102.5	576					
	1998.06-	2007.04		L	F	Open Off-Road Vehicle	GDS16003	Drive Shaft	54T		27		60	102.5	576					
	1998.06-	2007.04		R	F	Open Off-Road Vehicle	GDS16013	Drive Shaft			27		60	102.5	975.5					
	1998.06-	2007.04		R	F	Open Off-Road Vehicle	GDS16004	Drive Shaft	54T		27		60	102.5	975.5					
4.0 (130 kW)	1996.08-	2007.04				Open Off-Road Vehicle Engine S01	GC016001	Outer Joint			27	32	60	102.5	77.5	I				
	1996.08-	2007.04				Open Off-Road Vehicle Engine S01	GC016004	Outer Joint	54T		27	32	60	102.5	77.5	I				
	1996.08-	2007.04		L	F	Open Off-Road Vehicle Engine S01	GDS16012	Drive Shaft			27		60	102.5	576					
	1996.08-	2007.04		L	F	Open Off-Road Vehicle Engine S01	GDS16003	Drive Shaft	54T		27		60	102.5	576					
	1996.08-	2007.04		R	F	Open Off-Road Vehicle Engine S01	GDS16013	Drive Shaft			27		60	102.5	975.5					
	1996.08-	2007.04		R	F	Open Off-Road Vehicle Engine S01	GDS16004	Drive Shaft	54T		27		60	102.5	975.5					
4.0 Rubicon (128 kW)	1997.04-	2007.12		L	F	Open Off-Road Vehicle	GDS99167	Drive Shaft	54T		27		60	102.5	576					
	1997.04-	2007.12		R	F	Open Off-Road Vehicle	GDS99168	Drive Shaft	54T		27		60	102.5	979					
<b>KIA</b>																				
<b>CARENS</b>																				
1.8							GCI27003	Inner Joint			27	24	41	64.7	105					
2.0 2WD	2006-	2008	5MT/4AT	L		DOHC - MPI	GDS27111	Drive Shaft	48T		27	27	62.1	95	688					
	2006-	2008	5MT/4AT	L		DOHC - MPI	GC027067	Outer Joint	48T		27	24	62.1	95	63	M				
	2006-	2008	5MT/4AT	L		DOHC - MPI	GCI27018	Inner Joint			27	24	41	61.5	100.5					
	2006-	2008	5MT/4AT	R		DOHC - MPI	GDS27102	Drive Shaft	48T		27	27	62.2	95	957					
<b>CARENS I (FC)</b>																				
1.8 i (81 kW)	2000.11-	2002.07	MT	L	F	MPV Engine T8	GDS27071	Drive Shaft	46T		28	24	56	90	624					
<b>CARENS II</b>																				
1.8				L			GDS27035	Drive Shaft	46T		28	27	56	90	630.5					
				R			GDS27034	Drive Shaft	46T		28	28	56	90	584.5					
<b>CARENS II (FJ)</b>																				
1.6 (77 kW)	2002.07-				F	MPV Engine GA6D	GC027029	Outer Joint	46T		28	24	56	90	60	M				
1.8 (93 kW)	2002.07-				F	MPV	GC027029	Outer Joint	46T		28	24	56	90	60	M				
	2002.07-		MT	L	F	MPV	GDS27071	Drive Shaft	46T		28	24	56	90	624					
2.0 CVVT (102 kW)	2005.04-	2006.09	MT	L	F	MPV Engine G4GC	GDS27071	Drive Shaft	46T		28	24	56	90	624					
<b>CARNIVAL</b>																				
-							GC027013	Outer Joint			28	24	56	102	60	M				
							GC027031	Outer Joint	54T		28	24	56	102	60	M				

																				
									YEAR	A	B	C	H	L	P					
<b>KIA CARNIVAL</b>																				
-	1999-2001		AT	L		GDS27037	Drive Shaft	54T	28	34	56	102	732							
	1999-2001		AT			GC027015	Outer Joint		28	24	56	102	60	M						
	1999-2001		MT			GC027012	Outer Joint		28	26	56	102.5	66	M						
	2001-					GCI27003	Inner Joint		27	24	41	64.7	105							
2.5	2001-		AT			GCI27002	Inner Joint		28	24	43	40.1	83.5							
	2001-		AT	L		GDS27020	Drive Shaft		28	27	56	102	715							
	2001-		AT	R		GDS27018	Drive Shaft		28	28	56	102	657							
2.5 V6			MT			GCI27013	Inner Joint		28	26	43	41	75							
			MT			GCI27014	Inner Joint		28	26	35	68	102							
			MT	L		GDS27079	Drive Shaft		28	28	56	102.5	722							
			MT	R		GDS27078	Drive Shaft		28	28	56	102.5	668							
<b>CARNIVAL (VQ)</b>																				
2.7	2006-2010		4AT	L	MU > DOHC - MPI	GDS27114	Drive Shaft	54T	31	27	56	102	720							
	2006-2010		4AT	L	MU > DOHC - MPI	GCI27020	Inner Joint		27	25	41	62	100.5							
	2006-2010		4AT	R	MU > DOHC - MPI	GDS27115	Drive Shaft	54T	31	28	56	102	663							
	2006-2010		4AT	R	MU > DOHC - MPI	GC027075	Outer Joint	54T	31	26	56	102	66	M						
	2006-2010		4AT	R	MU > DOHC - MPI	GCI27023	Inner Joint		28	25	42	43.5	77.5							
3.5 2WD	2011-		6AT	L	LAMBDA 2	GDS27152	Drive Shaft	54T	31	28	56	102	701							
	2011-		6AT	L	LAMBDA 2	GC027091	Outer Joint	54T	31	25	56	102	63	M						
	2011-		6AT	L	LAMBDA 2	GCI27033	Inner Joint		28	25	43	67	103.5							
3.8 2WD	2006-2010		5AT	L	LAMBDA > DOHC - MPI	GDS27151	Drive Shaft	54T	31	28	56	102	708.5							
	2006-2010		5AT	L	LAMBDA > DOHC - MPI	GCI27034	Inner Joint		28	25	41	72.5	104							
<b>CARNIVAL I (UP)</b>																				
2.5 V6 (121 kW)	1999.08-2001.10				MPV Engine KRV6	GC027062	Outer Joint	54T	28	24	56	102	60	M						
2.9 TD (93 kW)	1999.08-2001.10	MT	L	F	MPV Engine J3	GDS27097	Drive Shaft	54T	28	28	56	102.5	650							
	1999.08-2001.10	AT	L	F	MPV Engine J3	GDS27099	Drive Shaft	54T	28	28	56	102.5	624							
	1999.08-2001.10	AT	L	F	MPV Engine J3	GCI27036	Inner Joint		28	25	35	79	113.5							
	1999.08-2001.10	AT	L	F	MPV Engine J3	GC027030	Outer Joint	54T	28	26	56	102.5	66	M						
	1999.08-2001.10	AT	R	F	MPV Engine J3	GDS27096	Drive Shaft	54T	28	28	56	102.5	549							
	1999.08-2001.10	MT	R	F	MPV Engine J3	GDS34166	Drive Shaft	54T	28	28	56	102.5	596							
	1999.08-2001.10	AT	R	F	MPV Engine J3	GCI34075	Inner Joint		28	25	43	40.3	76							
<b>CEE'D</b>																				
2.0 (105 kW)	2006.12-					GC027080	Outer Joint	46T	27	23	60	95	58	M						
<b>CEE'D (ED)</b>																				
1.4 (77 kW)	2006.12-		MT	R	F	Hatchback Engine G4FA	GDS24399	Drive Shaft	46T	27	25	60	94.5	939						
	2010.10-			L	F	Estate Engine G4FA	GCI24039	Inner Joint		25	22	41	61	100						
	2010.10-		MT	R	F	Estate Engine G4FA	GDS24399	Drive Shaft	46T	27	25	60	94.5	939						
1.4 (80 kW)	2007.01-		5MT		F	Hatchback Engine G4FA	GC024095	Outer Joint	46T	27	22	60	94.5	58.5	M					
	2007.01-		MT	R	F	Hatchback Engine G4FA	GDS24399	Drive Shaft	46T	27	25	60	94.5	939						
	2007.09-		5MT		F	Estate Engine G4FA	GC024095	Outer Joint	46T	27	22	60	94.5	58.5	M					
	2007.09-			L	F	Estate Engine G4FA	GCI24039	Inner Joint		25	22	41	61	100						
	2007.09-		MT	R	F	Estate Engine G4FA	GDS24399	Drive Shaft	46T	27	25	60	94.5	939						
1.4 CVVT (66 kW)	2010.06-			L	F	Hatchback Engine G4FA-L	GCI24039	Inner Joint		25	22	41	61	100						
	2010.10-			L	F	Estate Engine G4FA-L	GCI24039	Inner Joint		25	22	41	61	100						
	2010.10-		MT	R	F	Estate Engine G4FA-L	GDS24399	Drive Shaft	46T	27	25	60	94.5	939						
1.6 (85 kW)	2007.09-			L	F	Estate Engine G4FC	GCI24039	Inner Joint		25	22	41	61	100						
	2007.09-			L	F	Hatchback Engine G4FC	GCI24039	Inner Joint		25	22	41	61	100						
	2007.09-	MT	R	F	Estate Engine G4FC	GDS24399	Drive Shaft	46T	27	25	60	94.5	939							
	2007.09-	MT	R	F	Hatchback Engine G4FC	GDS24399	Drive Shaft	46T	27	25	60	94.5	939							
1.6 (90 kW)	2007.01-				F	Hatchback Engine G4FC	GC024095	Outer Joint	46T	27	22	60	94.5	58.5	M					
	2007.01-			L	F	Hatchback Engine G4FC	GCI24039	Inner Joint		25	22	41	61	100						
	2007.01-	MT	R	F	Hatchback Engine G4FC	GDS24399	Drive Shaft	46T	27	25	60	94.5	939							
	2007.09-				F	Estate Engine G4FC	GC024095	Outer Joint	46T	27	22	60	94.5	58.5	M					
	2007.09-			L	F	Estate Engine G4FC	GCI24039	Inner Joint		25	22	41	61	100						
	2007.09-	MT	R	F	Estate Engine G4FC	GDS24399	Drive Shaft	46T	27	25	60	94.5	939							
1.6 (93 kW)	2007.09-				F	Estate Engine G4FC	GC024095	Outer Joint	46T	27	22	60	94.5	58.5	M					
	2007.09-			L	F	Estate Engine G4FC	GCI24039	Inner Joint		25	22	41	61	100						
	2007.09-	MT	R	F	Estate Engine G4FC	GDS24399	Drive Shaft	46T	27	25	60	94.5	939							
	2008.02-				F	Hatchback Engine G4FC	GC024095	Outer Joint	46T	27	22	60	94.5	58.5	M					
	2008.02-			L	F	Hatchback Engine G4FC	GCI24039	Inner Joint		25	22	41	61	100						
	2008.02-		MT	R	F	Hatchback Engine G4FC	GDS24399	Drive Shaft	46T	27	25	60	94.5	939						









	 YEAR	TRANSM	L/R	F/R		G-AP Ref.	PRODUCT	ABS	Technical Specifications											
									A	B	C	H	L	P						
<b>KIA CEE'D (ED)</b>																				
1.6 CRDi (66 kW)	2007.01-		5MT		F	Hatchback Engine D4FB-L	GC024152	Outer Joint	46T	27	26	60	94	67	M					
	2007.01-		MT	L	F	Hatchback Engine D4FB-L	GDS39263	Drive Shaft	46T	27	27	60	94	658						
	2007.09-		5MT		F	Estate Engine D4FB-L	GC024152	Outer Joint	46T	27	26	60	94	67	M					
	2007.09-		MT	L	F	Estate Engine D4FB-L	GDS39263	Drive Shaft	46T	27	27	60	94	658						
1.6 CRDi (85 kW)	2007.01-		5MT		F	Hatchback Engine D4FB	GC024152	Outer Joint	46T	27	26	60	94	67	M					
	2007.01-		MT	L	F	Hatchback Engine D4FB	GDS39263	Drive Shaft	46T	27	27	60	94	658						
	2007.09-		5MT		F	Estate Engine D4FB	GC024152	Outer Joint	46T	27	26	60	94	67	M					
	2007.09-		MT	L	F	Estate Engine D4FB	GDS39263	Drive Shaft	46T	27	27	60	94	658						
1.6 CRDi (94 kW)	2010.10-		MT	L	F	Estate Engine D4FB	GDS39263	Drive Shaft	46T	27	27	60	94	658						
1.6 CVVT (92 kW)	2009.06-			L	F	Estate Engine G4FC	GCI24039	Inner Joint		25	22	41	61	100						
	2009.06-		MT	R	F	Estate Engine G4FC	GDS24399	Drive Shaft	46T	27	25	60	94.5	939						
	2010.10-			L	F	Hatchback Engine G4FC	GCI24039	Inner Joint		25	22	41	61	100						
	2010.10-		MT	R	F	Hatchback Engine G4FC	GDS24399	Drive Shaft	46T	27	25	60	94.5	939						
2.0 (105 kW)	2006.12-			R	F	Hatchback Engine G4GC	GC027080	Outer Joint	46T	27	23	60	95	58	M					
	2006.12-		MT	L	F	Hatchback Engine G4GC	GDS39263	Drive Shaft	46T	27	27	60	94	658						
	2007.09-			R	F	Estate Engine G4GC	GC027080	Outer Joint	46T	27	23	60	95	58	M					
2.0 CRDi (103 kW)	2008.04-		6MT		F	Estate Engine D4EA-F	GC024152	Outer Joint	46T	27	26	60	94	67	M					
	2008.04-		6MT		F	Hatchback Engine D4EA-F	GC024152	Outer Joint	46T	27	26	60	94	67	M					
<b>CERATO</b>																				
1.6	2004.01-	2006.12	MT/AT				GC099294	Outer Joint	44T	25	22	50	90	60	M					
1.6 2WD	2008-	2009	5MT/6AT	L		GAMMA DOHC - MPI	GDS27143	Drive Shaft	46T	27	25	60	94.5	671						
	2008-	2009	5MT/6AT	L		GAMMA DOHC - MPI	GC027088	Outer Joint	46T	27	22	60	94.5	54.5	M					
	2008-	2009	5MT/6AT	R		GAMMA DOHC - MPI	GDS27142	Drive Shaft	46T	27	25	60	94.5	943						
<b>CERATO (LD)</b>																				
1.5 CRDi (75 kW)	2005.04-	2007.05				Hatchback Engine D4FA	GC024139	Outer Joint	44T	27	24	60	90	63	M					
	2005.04-	2007.05				Saloon Engine D4FA	GC024139	Outer Joint	44T	27	24	60	90	63	M					
1.6 (77 kW)	2004.08-	2007.05	MT		F	Hatchback Engine G4ED	GC027076	Outer Joint	44T	25	22	50	95	58	M					
	2004.08-	2007.05	MT		F	Saloon Engine G4ED	GC027076	Outer Joint	44T	25	22	50	95	58	M					
	2004.08-	2007.05	AT	L	F	Hatchback Engine G4ED	GDS27168	Drive Shaft	44T	25	25	50	89	645						
	2004.08-	2007.05	AT	L	F	Saloon Engine G4ED	GDS27168	Drive Shaft	44T	25	25	50	89	645						
	2004.08-	2007.05	AT	R	F	Saloon Engine G4ED	GDS27169	Drive Shaft	44T	25	25	50	89	931						
1.6 CRDi (85 kW)	2005.06-					Hatchback Engine D4FB	GC024139	Outer Joint	44T	27	24	60	90	63	M					
	2005.06-					Saloon Engine D4FB	GC024139	Outer Joint	44T	27	24	60	90	63	M					
2.0 (105 kW)	2005.01-	2005.11	MT/AT		F	Hatchback Engine G4GC	GC027073	Outer Joint	44T	25	24	50	90	63	M					
	2005.12-	2007.05	MT/AT		F	Saloon Engine G4GC	GC027073	Outer Joint	44T	25	24	50	90	63	M					
<b>CLARUS (GC)</b>																				
1.8 i 16V (85 kW)	1998.05-		MT		F	Estate Engine T8	GC027010	Outer Joint		28	24	56	90	60	M					
2.0 i 16V (98 kW)	1998.05-		MT		F	Estate Engine FE	GC027010	Outer Joint		28	24	56	90	60	M					
<b>CLARUS (K9A)</b>																				
1.8 i 16V (85 kW)	1996.07-		MT		F	Saloon Engine T8	GC027010	Outer Joint		28	24	56	90	60	M					
2.0 i 16V (98 kW)	1996.07-		MT		F	Saloon Engine FE	GC027010	Outer Joint		28	24	56	90	60	M					
<b>MAGENTIS</b>																				
-	2001-	2005		L		6 Cyl	GDS24094	Drive Shaft	47T	27	27	60	96.5	661						
-	2001-	2005			F	6 Cyl	GCI27001	Inner Joint		27	25	41	62.5	93						
<b>MAGENTIS (GD)</b>																				
2.0 (100 kW)	2001.05-		MT		F	Saloon Engine G4JP	GC024029	Outer Joint	47T	27	25	60	95	63.5	M					
	2001.05-		MT/AT		F	Saloon Engine G4JP	GC027029	Outer Joint	46T	28	24	56	90	60	M					
	2001.05-		AT	L	F	Saloon Engine G4JP	GDS24158	Drive Shaft	47T	27	27	60	95	660						
	2001.05-		MT	R	F	Saloon Engine G4JP	GDS24058	Drive Shaft	47T	27	27	60	95	976.5						
	2001.05-		MT	R	F	Saloon Engine G4JP	GCI24001	Inner Joint		27	25	41	62.8	92.5						
	2001.05-		MT	R	F	Saloon Engine G4JP	GC024013	Outer Joint		27	26	60	95	69	M					
2.5 V6 (124 kW)	2001.05-		MT	L	F	Saloon Engine G6BV	GDS24158	Drive Shaft	47T	27	27	60	95	660						
	2001.05-		MT	R	F	Saloon Engine G6BV	GDS24058	Drive Shaft	47T	27	27	60	95	976.5						
	2001.05-		MT	R	F	Saloon Engine G6BV	GCI24001	Inner Joint		27	25	41	62.8	92.5						
	2001.05-		MT	R	F	Saloon Engine G6BV	GC024013	Outer Joint		27	26	60	95	69	M					
	2001.05-					Saloon Engine G6BV	GC024037	Outer Joint	47T	27	34	60	96.5	71	I					
<b>MENTOR (FA)</b>																				
1.5 i (59 kW)	1996.02-	1997.10			F	Saloon Engine B5	GC034006	Outer Joint	44T	26	22	56	94	59	M					
	1996.02-	1997.10			F	Hatchback Engine B5	GC034006	Outer Joint	44T	26	22	56	94	59	M					
	1996.02-	1997.10			F	Saloon Engine B5	GC034022	Outer Joint	44T	26	22	56	94	59	I					
	1996.02-	1997.10			F	Hatchback Engine B5	GC034022	Outer Joint	44T	26	22	56	94	59	I					
	1996.02-	1997.10	MT		F	Saloon Engine B5	GC027001	Outer Joint		26	22	56	93.5	55.5	M					



		TRANSM	L/R	F/R		G-AP Ref.	PRODUCT	ABS	Technical Specifications								
									YEAR	A	B	C	H	L	P		
<b>KIA MENTOR (FA)</b>																	
1.5 i (59 kW)	1996.02-	1997.10	MT		F	Hatchback Engine B5	GC027001	Outer Joint		26	22	56	93.5	55.5	M		
1.6 i (59 kW)	1993.09-	1997.10			F	Saloon Engine B6	GC034006	Outer Joint	44T	26	22	56	94	59	M		
	1993.09-	1997.10			F	Saloon Engine B6	GC034022	Outer Joint	44T	26	22	56	94	59	I		
	1993.09-	1997.10	MT		F	Saloon Engine B6	GC027001	Outer Joint		26	22	56	93.5	55.5	M		
	1995.01-	1997.10			F	Hatchback Engine B6	GC034006	Outer Joint	44T	26	22	56	94	59	M		
	1995.01-	1997.10			F	Hatchback Engine B6	GC034022	Outer Joint	44T	26	22	56	94	59	I		
	1995.01-	1997.10	MT		F	Hatchback Engine B6	GC027001	Outer Joint		26	22	56	93.5	55.5	M		
1.8 i 16V (82 kW)	1995.01-	1997.10			F	Hatchback Engine OK24N/OK26Y	GC027027	Outer Joint	44T	26	23	56	93	55	M		
	1995.01-	1997.10			F	Saloon Engine OK24N/OK26Y	GC027027	Outer Joint	44T	26	23	56	93	55	M		
	1995.01-	1997.10			F	Hatchback Engine OK24N/OK26Y	GC034006	Outer Joint	44T	26	22	56	94	59	M		
	1995.01-	1997.10			F	Saloon Engine OK24N/OK26Y	GC034006	Outer Joint	44T	26	22	56	94	59	M		
	1995.01-	1997.10			F	Hatchback Engine OK24N/OK26Y	GC034022	Outer Joint	44T	26	22	56	94	59	I		
	1995.01-	1997.10			F	Saloon Engine OK24N/OK26Y	GC034022	Outer Joint	44T	26	22	56	94	59	I		
	1995.01-	1997.10	MT		F	Hatchback Engine OK24N/OK26Y	GC027001	Outer Joint		26	22	56	93.5	55.5	M		
	1995.01-	1997.10	MT		F	Saloon Engine OK24N/OK26Y	GC027001	Outer Joint		26	22	56	93.5	55.5	M		
	1995.01-	1997.10	MT		F	Hatchback Engine OK24N/OK26Y	GC027007	Outer Joint		26	23	56	93	55	M		
	1995.01-	1997.10	MT		F	Saloon Engine OK24N/OK26Y	GC027007	Outer Joint		26	23	56	93	55	M		
<b>MORNING</b>																	
1.0 2WD			5MT	L		KAPPA> DOHC - MPI	GDS27117	Drive Shaft		24	25	52.5	86.5	606			
			5MT	L		KAPPA> DOHC - MPI	GC027074	Outer Joint		24	20	52.5	86.5	52	M		
	2011-		5MT	R		KAPPA> DOHC - MPI	GDS27116	Drive Shaft		24	25	52.5	86.5	876			
<b>OPTIMA</b>																	
-	2000-	2004	AT				GCI24008	Inner Joint		25	23	41	63	92.5			
	2001-	2002		L			GDS24094	Drive Shaft	47T	27	27	60	96.5	661			
	2001-			R			GDS27002	Drive Shaft		27	27	60	95	974			
2.0	1999.01-		MT/AT				GC027008	Outer Joint		27	23	60	95	63.5	M		
	2001.01-		MT/AT				GC027009	Outer Joint		27	25	60	95	63.5	M		
	2001.01-		MT/AT				GC024029	Outer Joint	47T	27	25	60	95	63.5	M		
2.7	2003-	2006	AT			6 Cyl	GCI27001	Inner Joint		27	25	41	62.5	93			
	2003-	2006	AT	L		6 Cyl	GDS24094	Drive Shaft	47T	27	27	60	96.5	661			
<b>PICANTO</b>																	
1.0 2WD			5MT	L		KAPPA> DOHC - MPI	GDS27117	Drive Shaft		24	25	52.5	86.5	606			
			5MT	L		KAPPA> DOHC - MPI	GC027074	Outer Joint		24	20	52.5	86.5	52	M		
	2004-	2007	4AT	L		SOHC - MPI	GDS34168	Drive Shaft	48T	24		52.5	86.5	533			
	2004-	2007	5MT	L		SOHC - MPI	GDS34169	Drive Shaft	48T	24		52.5	86.5	557			
	2004-	2007	5MT	L		SOHC - MPI	GDS27132	Drive Shaft	48T	24	25	52.5	86.5	631			
	2004-	2007	5MT	L		SOHC - MPI	GCI24019	Inner Joint		25	20	35	54.5	82.5			
	2004-	2007	4AT	R		SOHC - MPI	GDS34167	Drive Shaft	48T	24		52.5	86.5	807			
	2011-		5MT	R		KAPPA> DOHC - MPI	GDS27116	Drive Shaft		24	25	52.5	86.5	876			
1.1 CRDi	2005-						GC027107	Outer Joint		24	20	52.5	86.5	52	M		
<b>PICANTO (BA)</b>																	
1.0 (45 kW)	2004.05-	2008.02			F	Hatchback Engine G4HE	GC027072	Outer Joint	48T	24	20	52.5	85.5	51	M		
	2004.05-	2008.02			F	Hatchback Engine G4HE	GC027077	Outer Joint		24	20	52.5	85.5	51	M		
	2004.05-	2008.02	AT	L	F	Hatchback Engine G4HE	GDS27207	Drive Shaft	48T	24	25	52.5	86.5	606			
	2004.05-	2008.02	MT	L	F	Hatchback Engine G4HE	GDS27132	Drive Shaft	48T	24	25	52.5	86.5	631			
	2004.05-	2008.02	MT	L	F	Hatchback Engine G4HE	GCI24019	Inner Joint		25	20	35	54.5	82.5			
	2004.05-	2008.02	AT	R	F	Hatchback Engine G4HE	GDS27206	Drive Shaft	48T	24	25	52.5	86.5	876			
	2004.05-	2008.02	MT	R	F	Hatchback Engine G4HE	GDS99216	Drive Shaft	48T	24	25	52.5	86.5	853			
	2004.05-	2008.02	MT	R	F	Hatchback Engine G4HE	GCI24019	Inner Joint		25	20	35	54.5	82.5			
	2004.05-	2008.02	MT	R	F	Hatchback Engine G4HE	GC027074	Outer Joint		24	20	52.5	86.5	52	M		
	1.1 (48 kW)	2004.05-	2008.02			F	Hatchback Engine G4HG	GC027072	Outer Joint	48T	24	20	52.5	85.5	51	M	
2004.05-		2008.02			F	Hatchback Engine G4HG	GC027077	Outer Joint		24	20	52.5	85.5	51	M		
2004.05-		2008.02	AT	L	F	Hatchback Engine G4HG	GDS27207	Drive Shaft	48T	24	25	52.5	86.5	606			
2004.05-		2008.02	MT	L	F	Hatchback Engine G4HG	GDS27132	Drive Shaft	48T	24	25	52.5	86.5	631			
2004.05-		2008.02	MT	L	F	Hatchback Engine G4HG	GCI24019	Inner Joint		25	20	35	54.5	82.5			
2004.05-		2008.02	AT	R	F	Hatchback Engine G4HG	GDS27206	Drive Shaft	48T	24	25	52.5	86.5	876			
2004.05-		2008.02	MT	R	F	Hatchback Engine G4HG	GDS99216	Drive Shaft	48T	24	25	52.5	86.5	853			
2004.05-		2008.02	MT	R	F	Hatchback Engine G4HG	GCI24019	Inner Joint		25	20	35	54.5	82.5			
1.1 CRDi (55 kW)	2005.11-				F	Hatchback Engine D3FA	GC034094	Outer Joint	48T	24	21	52.5	86.5	54.5	M		
	2005.11-				F	Hatchback Engine D3FA	GC027072	Outer Joint	48T	24	20	52.5	85.5	51	M		
	2005.11-				F	Hatchback Engine D3FA	GC027077	Outer Joint		24	20	52.5	85.5	51	M		

	 YEAR	TRANSM	L/R	F/R		G-AP Ref.	PRODUCT	ABS	Technical Specifications								
									A	B	C	H	L	P			
<b>KIA</b>																	
<b>PICANTO (TA)</b>																	
1.0 (49 kW)	2015.04-				Hatchback Engine G3LA	GC034156	Outer Joint	48T	24	20	52.5	86.5	52	M			
1.0 (51 kW)	2011.05-				Hatchback Engine G3LA	GC034156	Outer Joint	48T	24	20	52.5	86.5	52	M			
1.0 BiFuel (60 kW)	2011.05-				Hatchback Engine B3LA	GC034156	Outer Joint	48T	24	20	52.5	86.5	52	M			
1.0 LPG (49 kW)	2013.08-				Hatchback Engine B3LA	GC034156	Outer Joint	48T	24	20	52.5	86.5	52	M			
1.2 (63 kW)	2011.09-		MT	R	F	Hatchback Engine G4LA	GDS34171	Drive Shaft	48T	24	25	52.5	86.5	882			
	2011.09-					Hatchback Engine G4LA	GC034156	Outer Joint	48T	24	20	52.5	86.5	52	M		
<b>PRIDE</b>																	
-			AT	L		Hatchback Engine B1	GDS27109	Drive Shaft		24	24	52	86.5	597			
			AT	R		Hatchback Engine B1	GDS27108	Drive Shaft		24	24	52	86.5	881			
1.1	1989-		MT	L			GDS27040	Drive Shaft		24	22	52	86	605.4			
	1989-		MT	R			GDS27042	Drive Shaft		24	22	52	86	880			
1.3	1989-		MT	L			GDS27040	Drive Shaft		24	22	52	86	605.4			
	1989-		MT	R			GDS27042	Drive Shaft		24	22	52	86	880			
1.3 (47 kW)	1999.08-				F	Estate	GC027005	Outer Joint		24	19	52	86	50.5	O		
<b>PRIDE (DA)</b>																	
1.1 (DA)	1991.01-		MT			Engine B3	GC018033	Outer Joint		24	20	52	86	50.5	M		
1.1 i (38 kW)	1991.01-				F	Hatchback Engine B1	GC027005	Outer Joint		24	19	52	86	50.5	O		
	1991.01-		MT		F	Hatchback Engine B1	GC018030	Outer Joint		24	19	52	86	50.5	M		
1.3 (DA)	1991.01-		MT			Engine B3	GC018033	Outer Joint		24	20	52	86	50.5	M		
1.3 16V (44 kW)	1990.01-				F	Hatchback Engine B3	GC027005	Outer Joint		24	19	52	86	50.5	O		
	1990.01-		MT		F	Hatchback Engine B3	GC018030	Outer Joint		24	19	52	86	50.5	M		
1.3 16V (47 kW)	1996.10-				F	Hatchback Engine B3	GC027005	Outer Joint		24	19	52	86	50.5	O		
	1996.10-		MT		F	Hatchback Engine B3	GC018030	Outer Joint		24	19	52	86	50.5	M		
	1996.10-		MT		F	Hatchback Engine B3	GC027003	Outer Joint		24	21	52	86	54.5	I		
1.3 16V (53 kW)	1990.01-				F	Hatchback Engine B3	GC027005	Outer Joint		24	19	52	86	50.5	O		
	1990.01-		MT		F	Hatchback Engine B3	GC018030	Outer Joint		24	19	52	86	50.5	M		
	1990.01-		MT		F	Hatchback Engine B3	GC027003	Outer Joint		24	21	52	86	54.5	I		
1.3 i (51 kW)	1990.01-				F	Hatchback	GC027005	Outer Joint		24	19	52	86	50.5	O		
	1990.01-		MT		F	Hatchback	GC018030	Outer Joint		24	19	52	86	50.5	M		
<b>PRO CEED (ED)</b>																	
1.4 (77 kW)	2008.02-			L	F	Hatchback Engine G4FA	GCI24039	Inner Joint		25	22	41	61	100			
	2008.02-		MT	R	F	Hatchback Engine G4FA	GDS24399	Drive Shaft	46T	27	25	60	94.5	939			
1.4 (80 kW)	2008.02-			L	F	Hatchback Engine G4FA	GCI24039	Inner Joint		25	22	41	61	100			
	2008.02-		MT	R	F	Hatchback Engine G4FA	GDS24399	Drive Shaft	46T	27	25	60	94.5	939			
1.4 CVVT (66 kW)	2010.06-			L	F	Hatchback Engine G4FA-L	GCI24039	Inner Joint		25	22	41	61	100			
	2010.06-		MT	R	F	Hatchback Engine G4FA-L	GDS24399	Drive Shaft	46T	27	25	60	94.5	939			
1.6 (90 kW)	2008.02-			L	F	Hatchback Engine G4FC	GCI24039	Inner Joint		25	22	41	61	100			
	2008.02-		MT	R	F	Hatchback Engine G4FC	GDS24399	Drive Shaft	46T	27	25	60	94.5	939			
1.6 (93 kW)	2008.02-			L	F	Hatchback Engine G4FC	GCI24039	Inner Joint		25	22	41	61	100			
	2008.02-		MT	R	F	Hatchback Engine G4FC	GDS24399	Drive Shaft	46T	27	25	60	94.5	939			
1.6 CRDi (66 kW)	2008.02-		MT	L	F	Hatchback Engine D4FB-L	GDS39263	Drive Shaft	46T	27	27	60	94	658			
1.6 CRDi (85 kW)	2008.02-		MT	L	F	Hatchback Engine D4FB	GDS39263	Drive Shaft	46T	27	27	60	94	658			
1.6 CRDi (94 kW)	2010.10-		MT	L	F	Hatchback Engine D4FB	GDS39263	Drive Shaft	46T	27	27	60	94	658			
1.6 CVVT (92 kW)	2010.10-			L	F	Hatchback Engine G4FC	GCI24039	Inner Joint		25	22	41	61	100			
	2010.10-		MT	R	F	Hatchback Engine G4FC	GDS24399	Drive Shaft	46T	27	25	60	94.5	939			
<b>RIO</b>																	
-	2000-2001		MT	L			GDS27024	Drive Shaft		24	26	52	86	605			
	2000-2001		MT	R			GDS27026	Drive Shaft		24	26	52	86	888			
	2000-2004						GCI27008	Inner Joint		26	22	35	66.5	95			
	2000-2005		MT	L	F		GDS27025	Drive Shaft	44T	24	26	52	86	605			
	2000-2005		MT	R	F		GDS27027	Drive Shaft	44T	24	26	52	86	888			
	2000-2001		MT	L/R			GCI27008	Inner Joint		26	22	35	66.5	95			
	2000-2005		MT	L/R	F		GCI27008	Inner Joint		26	22	35	66.5	95			
	2001-2004						GC034127	Outer Joint		24	22	52	86	58.5	M		
	2011-						GCI39052	Inner Joint		25	22	41	63	86			
1.4 2WD	2007-2009		4AT	L		ALPHA DOHC> DOHC - MPI	GDS27186	Drive Shaft	48T	25	25	52.5	95	638			
	2007-2009		4AT	L		ALPHA DOHC> DOHC - MPI	GC024046	Outer Joint	48T	25	22	52.5	95	58	M		
	2007-2009		4AT	L		ALPHA DOHC> DOHC - MPI	GCI27038	Inner Joint		25	22	35	62	94			
	2007-2009		5MT	L		ALPHA DOHC> DOHC - MPI	GDS27155	Drive Shaft	48T	25	25	52.5	93.5	637			
	2007-2009		5MT	L		ALPHA DOHC> DOHC - MPI	GC027097	Outer Joint	48T	25	22	52.5	93.5	59.5	M		
	2007-2009		4AT	R		ALPHA DOHC> DOHC - MPI	GDS27185	Drive Shaft	48T	25	25	52.5	95	926			
	2007-2009		5MT	R		ALPHA DOHC> DOHC - MPI	GDS27156	Drive Shaft	48T	25	25	52.5	93.5	925			









		YEAR	TRANSM	L/R	F/R		G-AP Ref.	PRODUCT	ABS	Technical Specifications									
										A	B	C	H	L	P				
<b>KIA</b>																			
<b>RIO (BC)</b>																			
1.5 2WD	2000-	2005	5MT	L		DOHC - MPI	GC034127	Outer Joint		24	22	52	86	58.5	M				
	2000-	2005	5MT	L		DOHC - MPI	GCI34008	Inner Joint		26	22	35	66.7	92					
<b>RIO (DC)</b>																			
1.3 (55 kW)	2000.08-	2005.02			F	Estate Engine A3E	GC027070	Outer Joint		24	21	52	86	55	M				
	2000.08-	2005.02	MT			Estate Engine A3E	GC027078	Outer Joint	44T	24	21	52	86	55	M				
	2000.08-	2005.02				Estate Engine A3E	GC099232	Outer Joint	44T	24	21	52	86.5	53	I				
1.3 (60 kW)	2000.08-	2005.02			F	Estate Engine A3E	GC027070	Outer Joint		24	21	52	86	55	M				
	2000.08-	2005.02	MT			Estate Engine A3E	GC027078	Outer Joint	44T	24	21	52	86	55	M				
	2000.08-	2005.02				Estate Engine A3E	GC099232	Outer Joint	44T	24	21	52	86.5	53	I				
1.5 16V (71 kW)	2002.09-	2005.02			F	Estate Engine A5D	GC027016	Outer Joint		24	22	52	86	58.5	M				
	2002.09-	2005.02				Estate Engine A5D	GC027033	Outer Joint	44T	24	22	52	86	58.5	M				
	2002.09-	2005.02				Estate Engine A5D	GC099232	Outer Joint	44T	24	21	52	86.5	53	I				
1.5 16V (72 kW)	2000.08-	2005.02			F	Estate Engine A5D	GC027016	Outer Joint		24	22	52	86	58.5	M				
	2000.08-	2005.02				Estate Engine A5D	GC099232	Outer Joint	44T	24	21	52	86.5	53	I				
<b>RIO (DC_)</b>																			
1.3 (55 kW)	2000.09-	2005.02			F	Saloon	GC027070	Outer Joint		24	21	52	86	55	M				
	2000.09-	2005.02	MT			Saloon	GC027078	Outer Joint	44T	24	21	52	86	55	M				
	2000.09-	2005.02				Saloon	GC099232	Outer Joint	44T	24	21	52	86.5	53	I				
1.3 (60 kW)	2002.08-	2005.02			F	Saloon Engine A3E	GC027070	Outer Joint		24	21	52	86	55	M				
	2002.08-	2005.02	MT			Saloon Engine A3E	GC027078	Outer Joint	44T	24	21	52	86	55	M				
	2002.08-	2005.02				Saloon Engine A3E	GC099232	Outer Joint	44T	24	21	52	86.5	53	I				
1.5 16V (72 kW)	2000.09-	2005.02			F	Saloon Engine A5D	GC027016	Outer Joint		24	22	52	86	58.5	M				
	2000.09-	2005.02				Saloon Engine A5D	GC027033	Outer Joint	44T	24	22	52	86	58.5	M				
<b>RIO I</b>																			
1.3	2000-						GC027108	Outer Joint		24	21	52	86	58.5	M				
<b>RIO II (JB)</b>																			
1.4 16V (71 kW)	2005.03-				F	Saloon Engine G4EE	GC027076	Outer Joint	44T	25	22	50	95	58	M				
	2005.09-	2007.01			F	Hatchback Engine G4EE	GC027076	Outer Joint	44T	25	22	50	95	58	M				
1.5 CRDi (81 kW)	2005.09-	2008.02			F	Hatchback Engine D4FA	GC027068	Outer Joint	48T	25	24	50	94.5	63.5	M				
	2005.09-	2008.02			F	Saloon Engine D4FA	GC027068	Outer Joint	48T	25	24	50	94.5	63.5	M				
	2005.09-	2008.02	MT	L	F	Hatchback Engine D4FA	GDS24401	Drive Shaft	48T	25	27	50	93.5	637					
	2005.09-	2008.02	MT	L	F	Saloon Engine D4FA	GDS24401	Drive Shaft	48T	25	27	50	93.5	637					
	2005.09-	2008.02				Hatchback Engine D4FA	GC024114	Outer Joint	48T	25	24	50	94.5	63.5	M				
	2005.09-	2008.02				Saloon Engine D4FA	GC024114	Outer Joint	48T	25	24	50	94.5	63.5	M				
1.6 16V (82 kW)	2005.03-					Saloon Engine G4ED	GC024114	Outer Joint	48T	25	24	50	94.5	63.5	M				
1.6 CVVT (82 kW)	2005.03-				F	Hatchback Engine G4ED	GC027076	Outer Joint	44T	25	22	50	95	58	M				
	2005.03-					Hatchback Engine G4ED	GC024114	Outer Joint	48T	25	24	50	94.5	63.5	M				
<b>SEDONA</b>																			
3.5 2WD	2011-		6AT	L		LAMBDA 2	GDS27152	Drive Shaft	54T	31	28	56	102	701					
	2011-		6AT	L		LAMBDA 2	GC027091	Outer Joint	54T	31	25	56	102	63	M				
	2011-		6AT	L		LAMBDA 2	GCI27033	Inner Joint		28	25	43	67	103.5					
<b>SEDONA II (GQ)</b>																			
2.5 V6 (110 kW)	2001.10-					MPV Engine K5	GC027062	Outer Joint	54T	28	24	56	102	60	M				
2.9 CRDi (106 kW)	2001.10-		AT	L	F	MPV Engine J3	GDS27099	Drive Shaft	54T	28	28	56	102.5	624					
	2001.10-		AT	L	F	MPV Engine J3	GCI27036	Inner Joint		28	25	35	79	113.5					
	2001.10-		AT	L	F	MPV Engine J3	GC027030	Outer Joint	54T	28	26	56	102.5	66	M				
	2001.10-		MT	L	F	MPV Engine J3	GDS27097	Drive Shaft	54T	28	28	56	102.5	650					
	2001.10-		AT	R	F	MPV Engine J3	GDS27096	Drive Shaft	54T	28	28	56	102.5	549					
	2001.10-		AT	R	F	MPV Engine J3	GCI34075	Inner Joint		28	25	43	40.3	76					
	2001.10-		MT	R	F	MPV Engine J3	GDS34166	Drive Shaft	54T	28	28	56	102.5	596					
<b>SEDONA II (VQ)</b>																			
2.7 V6 (139 kW)	2006.06-		MT	R	F	MPV Engine G6EA	GDS99278	Drive Shaft	54T	31	28	56	102	554					
	2006.06-					MPV Engine G6EA	GC034128	Outer Joint	54T	31	28	56	102	69.5	M				
2.9 CRDi (136 kW)	2006.06-		AT	L	F	MPV Engine J3	GDS34210	Drive Shaft	54T	31	28	56	102	661					
	2006.06-		MT	R	F	MPV Engine J3	GDS99278	Drive Shaft	54T	31	28	56	102	554					
<b>SEPHIA</b>																			
-	1994-	1997	MT/AT				GCI27007	Inner Joint		28	23	43	40.8	75.5					
	1995-	1997		L			GDS18087	Drive Shaft		26	24	56	93	626.5					
	1995-	1997					GCI18039	Inner Joint		24	28	35	64.1	91.5					
	1996-		MT	L		S15	GDS27005	Drive Shaft		26	26	56	93	629					
	1996-		MT	R		S15	GDS27006	Drive Shaft		26	26	56	93	898					
	1998-	1999					GC027022	Outer Joint		26	24	56	92	60	M				



	 YEAR	TRANSM	L/R	F/R		G-AP Ref.	PRODUCT	ABS	Technical Specifications								
									A	B	C	H	L	P			
<b>KIA SEPHIA</b>																	
-	1998-2001		R	F		GDS27066	Drive Shaft		26	28	56	93	625.5				
	1998-2001	AT	L	F		GDS27053	Drive Shaft	44T	26	24	56	92	626				
	1998-2001	MT/AT		F		GCI27015	Inner Joint		28	23	43	40.8	75				
	2001-		L			GDS27071	Drive Shaft	46T	28	24	56	90	624				
	2001-		R			GDS27070	Drive Shaft	46T	28	28	56	90	618.5				
1.5	1994-1998		R			GDS27031	Drive Shaft		26	24	56	93.5	895				
1.6	1994-1998					GC027028	Outer Joint	44T	26	22	56	93	55	M			
1.6 DOHC	1994-1997		R			GDS27050	Drive Shaft		26	28	56	93	615.5				
1.8	1994-1997	MT	R			GDS27055	Drive Shaft	44T	26	28	56	93	617.5				
	1995-1998					GC027024	Outer Joint	44T	26	23	56	93	56.5	M			
	1995-1997					GC015002	Outer Joint		26	23	56	93	56.5	M			
<b>SHUMA</b>																	
-		MT	L			GDS27049	Drive Shaft		26	28	56	92	615.5				
<b>SHUMA (FB)</b>																	
1.5 i 16V (65 kW)	1997.10-2001.03	MT		F	Hatchback	GC027001	Outer Joint		26	22	56	93.5	55.5	M			
1.6 (75 kW)	2001.01-2001.12	MT	R	F	Hatchback Engine GA6D	GCI18015	Inner Joint		28	23	43	42	76.5				
	2001.01-2001.12	MT	R	F	Hatchback Engine GA6D	GC018035	Outer Joint		28	23	56	90	59	I			
<b>SHUMA II (FB)</b>																	
1.6 (75 kW)	2001.05-2004.05	MT/AT		F	Saloon Engine GA6D	GC027006	Outer Joint		26	22	56	93	55	M			
	2001.05-2004.05		L/R	F	Saloon Engine GA6D	GC027032	Outer Joint	46T	28	22	56	89.7	55.5	M			
	2001.05-2004.05	MT	R	F	Saloon Engine GA6D	GCI18015	Inner Joint		28	23	43	42	76.5				
	2001.05-2004.05	MT	R	F	Saloon Engine GA6D	GC018035	Outer Joint		28	23	56	90	59	I			
	2001.05-2004.08	MT/AT		F	Hatchback Engine GA6D	GC027006	Outer Joint		26	22	56	93	55	M			
	2001.05-2004.08		L/R	F	Hatchback Engine GA6D	GC027032	Outer Joint	46T	28	22	56	89.7	55.5	M			
1.8 (84 kW)	2002.03-2004.05			F	Hatchback Engine T8	GC027006	Outer Joint		26	22	56	93	55	M			
<b>SORENTO</b>																	
-						GC027014	Outer Joint		28	25	56	102	63	M			
<b>SORENTO I (JC)</b>																	
2.4 (102 kW)	2002.08-	AT			Closed Off-Road Vehicle Engine G4JS	GC027014	Outer Joint		28	25	56	102	63	M			
2.5 CRDi (103 kW)	2002.08-	AT			Closed Off-Road Vehicle Engine D4CB	GC027014	Outer Joint		28	25	56	102	63	M			
	2002.08-		L		Closed Off-Road Vehicle Engine D4CB	GDS27065	Drive Shaft		28	30	56	102	635				
	2002.08-		R		Closed Off-Road Vehicle Engine D4CB	GDS27064	Drive Shaft		28	28	56	102	567				
2.5 CRDi (125 kW)	2006.08-2007.05	AT			Closed Off-Road Vehicle Engine D4CB	GC027014	Outer Joint		28	25	56	102	63	M			
3.5 V6 (143 kW)	2002.08-	AT			Closed Off-Road Vehicle Engine G6CU	GC027014	Outer Joint		28	25	56	102	63	M			
	2002.08-		L		Closed Off-Road Vehicle Engine G6CU	GDS27065	Drive Shaft		28	30	56	102	635				
	2002.08-		R		Closed Off-Road Vehicle Engine G6CU	GDS27064	Drive Shaft		28	28	56	102	567				
<b>SORENTO II (XM)</b>																	
2.0 CRDi (110 kW)	2010.11-	MT	L	F	Closed Off-Road Vehicle Engine D4HA	GDS24195	Drive Shaft	52T	30	28	73	97	659				
	2010.11-	MT	R	F	Closed Off-Road Vehicle Engine D4HA	GCI24094	Inner Joint		28	35	42		129.5				
	2010.11-		R	F	Closed Off-Road Vehicle Engine D4HA	GCI24058	Inner Joint		28	36	42.1	43.5	88				
	2010.11-				Closed Off-Road Vehicle Engine D4HA	GC024072	Outer Joint	52T	30	36	73	97	67.5	I			
	2010.11-	MT	R	F	Closed Off-Road Vehicle Engine D4HA	GDS24117	Drive Shaft	52T	30	28	73	97	611				
2.0 CRDi 4WD (110 kW)	2010.11-	MT	L	F	Closed Off-Road Vehicle Engine D4HA	GDS24195	Drive Shaft	52T	30	28	73	97	659				
	2010.11-	MT	R	F	Closed Off-Road Vehicle Engine D4HA	GCI24094	Inner Joint		28	35	42		129.5				
	2010.11-		R	F	Closed Off-Road Vehicle Engine D4HA	GCI24058	Inner Joint		28	36	42.1	43.5	88				
	2010.11-				Closed Off-Road Vehicle Engine D4HA	GC024072	Outer Joint	52T	30	36	73	97	67.5	I			
	2010.11-	MT	R	F	Closed Off-Road Vehicle Engine D4HA	GDS24117	Drive Shaft	52T	30	28	73	97	611				
2.2 CRDi (145 kW)	2009.11-	AT	L	F	Closed Off-Road Vehicle Engine D4HB	GDS39247	Drive Shaft	52T	30	28	73	97	670				
	2009.11-		L	F	Closed Off-Road Vehicle Engine D4HB	GDS24195	Drive Shaft	52T	30	28	73	97	659				
	2009.11-		R	F	Closed Off-Road Vehicle Engine D4HB	GCI24094	Inner Joint		28	35	42		129.5				
	2009.11-				Closed Off-Road Vehicle Engine D4HB	GC024072	Outer Joint	52T	30	36	73	97	67.5	I			
	2009.11-		R	F	Closed Off-Road Vehicle Engine D4HB	GDS24117	Drive Shaft	52T	30	28	73	97	611				
2.2 CRDi 4WD (145 kW)	2009.11-	AT	L	F	Closed Off-Road Vehicle Engine D4HB	GDS39247	Drive Shaft	52T	30	28	73	97	670				
	2009.11-		L	F	Closed Off-Road Vehicle Engine D4HB	GDS24195	Drive Shaft	52T	30	28	73	97	659				
	2009.11-		R	F	Closed Off-Road Vehicle Engine D4HB	GCI24094	Inner Joint		28	35	42		129.5				
	2009.11-				Closed Off-Road Vehicle Engine D4HB	GC024072	Outer Joint	52T	30	36	73	97	67.5	I			
	2009.11-		R	F	Closed Off-Road Vehicle Engine D4HB	GDS24117	Drive Shaft	52T	30	28	73	97	611				
<b>SOUL (AM)</b>																	
1.6 CRDi (85 kW)	2009.02-	MT	R	F	Hatchback Engine D4FB	GDS39210	Drive Shaft	46T	27	27	60	94	945				
1.6 CRDi (94 kW)	2009.02-	MT	R	F	Hatchback Engine D4FB	GDS39210	Drive Shaft	46T	27	27	60	94	945				
1.6 GDi (103 kW)	2011.06-	MT	R	F	Hatchback Engine G4FD	GDS39210	Drive Shaft	46T	27	27	60	94	945				

	 YEAR	TRANSM L/R F/R		G-AP Ref.	PRODUCT	ABS	Technical Specifications								
							A	B	C	H	L	P			
<b>KIA SPECTRA</b>															
-	2000-2001		R F		GDS27066	Drive Shaft		26	28	56	93	625.5			
	2000-2001	AT	L F		GDS27053	Drive Shaft	44T	26	24	56	92	626			
	2000-2001	MT/AT		F	GCI27015	Inner Joint		28	23	43	40.8	75			
	2001-2004		L		GDS27071	Drive Shaft	46T	28	24	56	90	624			
	2001-2004		R		GDS27070	Drive Shaft	46T	28	28	56	90	618.5			
1.5		MT			GC027006	Outer Joint		26	22	56	93	55	M		
	1991-	AT	L	BFD (RHD)	GDS27011	Drive Shaft	46T	28	24	56	89.7	635			
	2000-		L		GDS27059	Drive Shaft		28	26	56	89.7	633			
1.6	2002-2003				GCI27004	Inner Joint		28	22	43	40	67			
	2002-2003		R		GDS27030	Drive Shaft	46T	28	28	56	89.7	574			
<b>SPECTRA (BFD)</b>															
1.5	1991.01-	4AT			GC027004	Outer Joint		28	22	56	90	55.5	M		
<b>SPORTAGE</b>															
-					GC024094	Outer Joint	48T	27	26	62	94.5	65	M		
					GC027011	Outer Joint		26	24	65	136	64	M		
	1995-2000				GDS27067	Drive Shaft		26	26	65	122	577.5			
	1995-2000				GCI27016	Inner Joint		26	24	35	82.5	100			
	2001-2002			F Truck/VAN	GCI34037	Inner Joint		26	25	35	82.5	100			
	2001-2002		R F	Truck/VAN	GDS27084	Drive Shaft		26	26	66.8	125	582			
	2005-				GDS27105	Drive Shaft	48T	27	26	62.2	95	608			
<b>SPORTAGE (JE)</b>															
2.0 CRDi (103 kW)	2006.01-				GC099289	Outer Joint	48T	27	26	62	94.5	65	M		
2.0 CRDi (110 kW)	2008.09-				GC099289	Outer Joint	48T	27	26	62	94.5	65	M		
2.0 CRDi (83 kW)	2005.02-				GC099289	Outer Joint	48T	27	26	62	94.5	65	M		
2.0 CRDi 4WD (103 kW)	2006.01-				GC099289	Outer Joint	48T	27	26	62	94.5	65	M		
2.0 CRDi 4WD (110 kW)	2008.09-				GC099289	Outer Joint	48T	27	26	62	94.5	65	M		
2.0 CRDi 4WD (83 kW)	2004.09-				GC099289	Outer Joint	48T	27	26	62	94.5	65	M		
<b>SPORTAGE (JE_)</b>															
2.0 16V 4WD (104 kW)	2005.01-2007.01		L F	Closed Off-Road Vehicle Engine G4GC	GDS24172	Drive Shaft	48T	27	27	62.2	95	668			
	2005.01-2007.01	MT	R F	Closed Off-Road Vehicle Engine G4GC	GDS24221	Drive Shaft	48T	27	26	61.9	95	610			
	2005.01-2007.01	MT	R F	Closed Off-Road Vehicle Engine G4GC	GCI39063	Inner Joint		26	25	42	39.5	68.5			
	2005.01-2007.01		R F	Closed Off-Road Vehicle Engine G4GC	GDS24173	Drive Shaft	48T	27	26	62.2	95	609			
	2005.01-2007.01		R F	Closed Off-Road Vehicle Engine G4GC	GCI24030	Inner Joint		26	25	42	40	68			
	2005.01-2007.01			F Closed Off-Road Vehicle Engine G4GC	GC027067	Outer Joint	48T	27	24	62.1	95	63	M		
	2005.01-2007.01		R	Closed Off-Road Vehicle Engine G4GC	GC024111	Outer Joint	48T	27	22	60	95	59.5	M		
2.0 CRDi (100 kW)	2006.01-	MT	L F	Closed Off-Road Vehicle Engine D4EA	GDS24352	Drive Shaft	48T	27	27	62	94.5	671			
	2006.01-	MT/AT	L F	Closed Off-Road Vehicle Engine D4EA	GDS24300	Drive Shaft	48T	30	28	65	95	653			
	2006.01-	MT	R F	Closed Off-Road Vehicle Engine D4EA	GDS24221	Drive Shaft	48T	27	26	61.9	95	610			
	2006.01-	MT	R F	Closed Off-Road Vehicle Engine D4EA	GCI39063	Inner Joint		26	25	42	39.5	68.5			
	2006.01-			F Closed Off-Road Vehicle Engine D4EA	GC027067	Outer Joint	48T	27	24	62.1	95	63	M		
	2006.01-			Closed Off-Road Vehicle Engine D4EA	GC024153	Outer Joint	48T	30	25	65	95	69.5	M		
2.0 CRDi (103 kW)	2006.01-	MT	L F	Closed Off-Road Vehicle Engine D4EA-V	GDS24352	Drive Shaft	48T	27	27	62	94.5	671			
	2006.01-	MT/AT	L F	Closed Off-Road Vehicle Engine D4EA-V	GDS24300	Drive Shaft	48T	30	28	65	95	653			
	2006.01-	MT	R F	Closed Off-Road Vehicle Engine D4EA-V	GDS24221	Drive Shaft	48T	27	26	61.9	95	610			
	2006.01-	MT	R F	Closed Off-Road Vehicle Engine D4EA-V	GCI39063	Inner Joint		26	25	42	39.5	68.5			
	2006.01-			F Closed Off-Road Vehicle Engine D4EA-V	GC027067	Outer Joint	48T	27	24	62.1	95	63	M		
	2006.01-			Closed Off-Road Vehicle Engine D4EA-V	GC024153	Outer Joint	48T	30	25	65	95	69.5	M		
2.0 CRDi (110 kW)	2008.09-	MT	L F	Closed Off-Road Vehicle Engine D4EA	GDS24352	Drive Shaft	48T	27	27	62	94.5	671			
	2008.09-	MT/AT	L F	Closed Off-Road Vehicle Engine D4EA	GDS24300	Drive Shaft	48T	30	28	65	95	653			
	2008.09-	MT	R F	Closed Off-Road Vehicle Engine D4EA	GDS24221	Drive Shaft	48T	27	26	61.9	95	610			
	2008.09-	MT	R F	Closed Off-Road Vehicle Engine D4EA	GCI39063	Inner Joint		26	25	42	39.5	68.5			
	2008.09-			F Closed Off-Road Vehicle Engine D4EA	GC027067	Outer Joint	48T	27	24	62.1	95	63	M		
	2008.09-			Closed Off-Road Vehicle Engine D4EA	GC024153	Outer Joint	48T	30	25	65	95	69.5	M		
2.0 CRDi (83 kW)	2005.02-	MT	L F	Closed Off-Road Vehicle Engine D4EA	GDS24352	Drive Shaft	48T	27	27	62	94.5	671			
	2005.02-	MT/AT	L F	Closed Off-Road Vehicle Engine D4EA	GDS24300	Drive Shaft	48T	30	28	65	95	653			
	2005.02-	MT	R F	Closed Off-Road Vehicle Engine D4EA	GDS24221	Drive Shaft	48T	27	26	61.9	95	610			
	2005.02-	MT	R F	Closed Off-Road Vehicle Engine D4EA	GCI39063	Inner Joint		26	25	42	39.5	68.5			
	2005.02-			F Closed Off-Road Vehicle Engine D4EA	GC027067	Outer Joint	48T	27	24	62.1	95	63	M		
	2005.02-			Closed Off-Road Vehicle Engine D4EA	GC024153	Outer Joint	48T	30	25	65	95	69.5	M		
2.0 CRDi 4WD (100 kW)	2006.01-	MT	L F	Closed Off-Road Vehicle Engine D4EA	GDS24352	Drive Shaft	48T	27	27	62	94.5	671			
	2006.01-	MT/AT	L F	Closed Off-Road Vehicle Engine D4EA	GDS24300	Drive Shaft	48T	30	28	65	95	653			
	2006.01-	MT	R F	Closed Off-Road Vehicle Engine D4EA	GDS24221	Drive Shaft	48T	27	26	61.9	95	610			









		YEAR	TRANSM	L/R	F/R		G-AP Ref.	PRODUCT	ABS	Technical Specifications								
										A	B	C	H	L	P			
<b>KIA</b>																		
<b>SPORTAGE (JE_)</b>																		
2.0 CRDi 4WD (100 kW)	2006.01-		MT	R	F	Closed Off-Road Vehicle Engine D4EA	GCI39063	Inner Joint		26	25	42	39.5	68.5				
	2006.01-				F	Closed Off-Road Vehicle Engine D4EA	GC027067	Outer Joint	48T	27	24	62.1	95	63	M			
	2006.01-				R	Closed Off-Road Vehicle Engine D4EA	GC024111	Outer Joint	48T	27	22	60	95	59.5	M			
	2006.01-					Closed Off-Road Vehicle Engine D4EA	GC024153	Outer Joint	48T	30	25	65	95	69.5	M			
2.0 CRDi 4WD (103 kW)	2006.01-		MT	L	F	Closed Off-Road Vehicle Engine D4EA-F/D4EA-V	GDS24352	Drive Shaft	48T	27	27	62	94.5	671				
	2006.01-		MT/AT	L	F	Closed Off-Road Vehicle Engine D4EA-F/D4EA-V	GDS24300	Drive Shaft	48T	30	28	65	95	653				
	2006.01-		MT	R	F	Closed Off-Road Vehicle Engine D4EA-F/D4EA-V	GDS24221	Drive Shaft	48T	27	26	61.9	95	610				
	2006.01-		MT	R	F	Closed Off-Road Vehicle Engine D4EA-F/D4EA-V	GCI39063	Inner Joint		26	25	42	39.5	68.5				
	2006.01-				F	Closed Off-Road Vehicle Engine D4EA-F/D4EA-V	GC027067	Outer Joint	48T	27	24	62.1	95	63	M			
	2006.01-					Closed Off-Road Vehicle Engine D4EA-F/D4EA-V	GC024111	Outer Joint	48T	27	22	60	95	59.5	M			
2.0 CRDi 4WD (110 kW)	2008.09-		MT	L	F	Closed Off-Road Vehicle Engine D4EA	GDS24352	Drive Shaft	48T	27	27	62	94.5	671				
	2008.09-		MT/AT	L	F	Closed Off-Road Vehicle Engine D4EA	GDS24300	Drive Shaft	48T	30	28	65	95	653				
	2008.09-		MT	R	F	Closed Off-Road Vehicle Engine D4EA	GDS24221	Drive Shaft	48T	27	26	61.9	95	610				
	2008.09-		MT	R	F	Closed Off-Road Vehicle Engine D4EA	GCI39063	Inner Joint		26	25	42	39.5	68.5				
	2008.09-				F	Closed Off-Road Vehicle Engine D4EA	GC027067	Outer Joint	48T	27	24	62.1	95	63	M			
	2008.09-				R	Closed Off-Road Vehicle Engine D4EA	GC024111	Outer Joint	48T	27	22	60	95	59.5	M			
	2008.09-					Closed Off-Road Vehicle Engine D4EA	GC024153	Outer Joint	48T	30	25	65	95	69.5	M			
2.0 CRDi 4WD (83 kW)	2005.02-	2005.12	MT	L	F	Closed Off-Road Vehicle Engine D4EA	GDS24352	Drive Shaft	48T	27	27	62	94.5	671				
	2005.02-	2005.12	MT/AT	L	F	Closed Off-Road Vehicle Engine D4EA	GDS24300	Drive Shaft	48T	30	28	65	95	653				
	2005.02-	2005.12	MT	R	F	Closed Off-Road Vehicle Engine D4EA	GDS24221	Drive Shaft	48T	27	26	61.9	95	610				
	2005.02-	2005.12	MT	R	F	Closed Off-Road Vehicle Engine D4EA	GCI39063	Inner Joint		26	25	42	39.5	68.5				
	2005.02-	2005.12			F	Closed Off-Road Vehicle Engine D4EA	GC027067	Outer Joint	48T	27	24	62.1	95	63	M			
	2005.02-	2005.12			R	Closed Off-Road Vehicle Engine D4EA	GC024111	Outer Joint	48T	27	22	60	95	59.5	M			
	2005.02-	2005.12				Closed Off-Road Vehicle Engine D4EA	GC024153	Outer Joint	48T	30	25	65	95	69.5	M			
2.0 i 16V (104 kW)	2008.04-			L	F	Closed Off-Road Vehicle Engine G4GC	GDS24172	Drive Shaft	48T	27	27	62.2	95	668				
	2008.04-		MT	R	F	Closed Off-Road Vehicle Engine G4GC	GDS24221	Drive Shaft	48T	27	26	61.9	95	610				
	2008.04-		MT	R	F	Closed Off-Road Vehicle Engine G4GC	GCI39063	Inner Joint		26	25	42	39.5	68.5				
	2008.04-					Closed Off-Road Vehicle Engine G4GC	GC027067	Outer Joint	48T	27	24	62.1	95	63	M			
2.7 V6 4WD (129 kW)	2005.01-	2007.01		L	F	Closed Off-Road Vehicle Engine G6BA	GDS24172	Drive Shaft	48T	27	27	62.2	95	668				
	2005.01-	2007.01		R	F	Closed Off-Road Vehicle Engine G6BA	GDS24173	Drive Shaft	48T	27	26	62.2	95	609				
	2005.01-	2007.01		R	F	Closed Off-Road Vehicle Engine G6BA	GCI24030	Inner Joint		26	25	42	40	68				
	2005.01-	2007.01		R		Closed Off-Road Vehicle Engine G6BA	GC024111	Outer Joint	48T	27	22	60	95	59.5	M			
<b>SPORTAGE (K00)</b>																		
2.0 i 16V (94 kW)	1999.10-	2003.08			R	Closed Off-Road Vehicle Engine FE	GC099053	Outer Joint		26	25	65	122	63	M			
2.0 i 16V 4WD (94 kW)	1994.04-	2003.08				Closed Off-Road Vehicle Engine FE	GC099053	Outer Joint		26	25	65	122	63	M			
	1994.04-	2003.08	MT		F	Closed Off-Road Vehicle Engine FE	GC027002	Outer Joint		26	24	65	122	62	M			
2.0 TD 4WD (61 kW)	1997.10-	2003.08			F	Closed Off-Road Vehicle Engine RF	GC027002	Outer Joint		26	24	65	122	62	M			
<b>SPORTAGE (SL)</b>																		
1.6 GDi (99 kW)	2011.02-		MT	R	F	Closed Off-Road Vehicle Engine G4FD	GDS24317	Drive Shaft	48T	27	25	62	95	691				
2.0 CRDi (100 kW)	2010.07-		MT	R	F	Closed Off-Road Vehicle Engine D4HA	GDS24362	Drive Shaft	48T	30	27	62	95	979				
<b>VENGA (YN)</b>																		
1.4 CRDi (55 kW)	2010.02-		MT	L	F	Hatchback Engine D4FC	GDS24318	Drive Shaft	46T	27	27	60	95	672				
	2010.02-		MT	R	F	Hatchback Engine D4FC	GDS24400	Drive Shaft	46T	27	27	60	95	967				
1.4 CRDi (57 kW)	2010.02-		MT	L	F	Hatchback Engine D4FC	GDS24318	Drive Shaft	46T	27	27	60	95	672				
	2010.02-		MT	R	F	Hatchback Engine D4FC	GDS24400	Drive Shaft	46T	27	27	60	95	967				
1.4 CRDi (66 kW)	2010.02-		MT	L	F	Hatchback Engine D4FC	GDS24318	Drive Shaft	46T	27	27	60	95	672				
	2010.02-		MT	R	F	Hatchback Engine D4FC	GDS24400	Drive Shaft	46T	27	27	60	95	967				
1.4 CVVT (66 kW)	2010.02-		MT	R	F	Hatchback Engine G4FA-L	GDS39237	Drive Shaft	46T	27	25	60	94.5	959				
1.6 CRDi (85 kW)	2010.02-		MT	L	F	Hatchback Engine D4FB	GDS24318	Drive Shaft	46T	27	27	60	95	672				
	2010.02-		MT	R	F	Hatchback Engine D4FB	GDS24400	Drive Shaft	46T	27	27	60	95	967				
1.6 CRDi (94 kW)	2010.02-		MT	L	F	Hatchback Engine D4FB	GDS24318	Drive Shaft	46T	27	27	60	95	672				
	2010.02-		MT	R	F	Hatchback Engine D4FB	GDS24400	Drive Shaft	46T	27	27	60	95	967				
1.6 CVVT (92 kW)	2010.02-		MT/AT	R	F	Hatchback Engine G4FC	GDS39237	Drive Shaft	46T	27	25	60	94.5	959				
<b>LADA</b>																		
<b>110</b>																		
1.3 Wankel (88 kW)	1997.06-		MT		F	Saloon Engine VAZ-415	GC028001	Outer Joint		22	22	50	77	53.5	I			
1.5 (54 kW)	1995.01-		MT		F	Saloon Engine BA32111	GC028001	Outer Joint		22	22	50	77	53.5	I			
	1995.01-		5MT	L	F	Saloon Engine BA32111	GDS28001	Drive Shaft		22	24	50	77	600				
	1995.01-		5MT	R	F	Saloon Engine BA32111	GDS28002	Drive Shaft		22	24	50	77	848				
1.5 (56 kW)	2000.10-		5MT	L	F	Saloon Engine VAZ-2111	GDS28001	Drive Shaft		22	24	50	77	600				
	2000.10-		5MT	R	F	Saloon Engine VAZ-2111	GDS28002	Drive Shaft		22	24	50	77	848				



		TRANSM	L/R	F/R		G-AP Ref.	PRODUCT	ABS	Technical Specifications								
									YEAR	A	B	C	H	L	P		
<b>LADA</b>																	
<b>110</b>																	
1.5 (57 kW)	1995.01-				Saloon Engine VAZ-2111	GC028001	Outer Joint		22	22	50	77	53.5	I			
	1995.01-		L	F	Saloon Engine VAZ-2111	GDS28001	Drive Shaft		22	24	50	77	600				
	1995.01-		R	F	Saloon Engine VAZ-2111	GDS28002	Drive Shaft		22	24	50	77	848				
1.5 16V (70 kW)	1995.01-				Saloon Engine VAZ-2112	GC028001	Outer Joint		22	22	50	77	53.5	I			
2.0 i (110 kW)	1996.08-				Saloon Engine C20XE	GC028001	Outer Joint		22	22	50	77	53.5	I			
<b>111</b>																	
1.5 (56 kW)	2000.10-		L	F	Estate Engine VAZ-2111	GDS28001	Drive Shaft		22	24	50	77	600				
	2000.10-		R	F	Estate Engine VAZ-2111	GDS28002	Drive Shaft		22	24	50	77	848				
1.5 (57 kW)	1996.01-		L	F	Estate Engine VAZ-2111	GDS28001	Drive Shaft		22	24	50	77	600				
	1996.01-		R	F	Estate Engine VAZ-2111	GDS28002	Drive Shaft		22	24	50	77	848				
<b>112</b>																	
1.5 (57 kW)	1995.01-		L	F	Hatchback Engine VAZ-2111	GDS28001	Drive Shaft		22	24	50	77	600				
	1995.01-		R	F	Hatchback Engine VAZ-2111	GDS28002	Drive Shaft		22	24	50	77	848				
<b>2170 KALINA / PRIORA</b>																	
-						GC028010	Outer Joint	43T	22	22	50	77	53.5	I			
<b>NIVA (2121)</b>																	
1.6 (54 kW)	1987.01-	1995.03			Closed Off-Road Vehicle Engine BA32121	GC028002	Outer Joint		22	22	56	107.5	66.5	I			
1.6 (56 kW)	1976.12-	1987.05	L	F	Closed Off-Road Vehicle Engine BA32121	GDS28005	Drive Shaft		22	22	56	107.5	707				
	1976.12-	1987.05	R	F	Closed Off-Road Vehicle Engine BA32121	GDS28006	Drive Shaft		22	22	56	107.5	831				
	1976.12-	1987.05		F	Closed Off-Road Vehicle Engine BA32121	GCI28003	Inner Joint		22	22	40	93.5	116				
	1976.12-	1987.05		F	Closed Off-Road Vehicle Engine BA32121	GCI28004	Inner Joint		22	22	30	217.8	116				
	1976.12-	1987.05	MT		Closed Off-Road Vehicle Engine BA32121	GC028002	Outer Joint		22	22	56	107.5	66.5	I			
	1980.04-	1987.12	L	F	Closed Off-Road Vehicle Engine BA32121	GDS28005	Drive Shaft		22	22	56	107.5	707				
	1980.04-	1987.12	R	F	Closed Off-Road Vehicle Engine BA32121	GDS28006	Drive Shaft		22	22	56	107.5	831				
	1980.04-	1987.12		F	Closed Off-Road Vehicle Engine BA32121	GCI28003	Inner Joint		22	22	40	93.5	116				
	1980.04-	1987.12		F	Closed Off-Road Vehicle Engine BA32121	GCI28004	Inner Joint		22	22	30	217.8	116				
	1980.04-	1987.12	MT		Closed Off-Road Vehicle Engine BA32121	GC028002	Outer Joint		22	22	56	107.5	66.5	I			
<b>NIVA (2123)</b>																	
-	2000-					GC028004	Outer Joint		24	22	46	107.5	66.5	I			
	2000-		L			GDS28011	Drive Shaft		24	24	46	107.5	707				
	2000-				TRIPOD TYPE	GCI28007	Inner Joint		24	22	40	215.5	116				
	2000-		R			GDS28012	Drive Shaft		24	24	46	107.5	829				
	2000-				TRIPOD TYPE	GCI28006	Inner Joint		24	22	40	93.5	116				
<b>OKA</b>																	
0.6 (22 kW)	1987-	1995				GCI28005	Inner Joint		20	19	35	53.5	88				
	1987-	1995	R			GDS28007	Drive Shaft		20	20	42	90	696				
	1987-	1995	L			GDS28008	Drive Shaft		20	20	42	90	606				
0.8 (26 kW)	1987-	1995				GCI28005	Inner Joint		20	19	35	53.5	88				
	1987-	1995	R			GDS28007	Drive Shaft		20	20	42	90	696				
	1987-	1995	L			GDS28008	Drive Shaft		20	20	42	90	606				
<b>OKA (1111)</b>																	
0.6 (22 kW)						GC099012	Outer Joint		20	19	42	90	47	M			
0.8 (26 kW)						GC099012	Outer Joint		20	19	42	90	47	M			
<b>SAMARA (2108, 2109)</b>																	
1.1 (39 kW)	1988.02-	1994.12	MT		Hatchback Engine BA321081	GCI28001	Inner Joint		24	22	35	60.8	97				
	1988.02-	1994.12	MT		Hatchback Engine BA321081	GC028001	Outer Joint		22	22	50	77	53.5	I			
	1988.02-	1994.12	MT	L	Hatchback Engine BA321081	GDS28001	Drive Shaft		22	24	50	77	600				
	1988.02-	1994.12	MT	R	Hatchback Engine BA321081	GDS28002	Drive Shaft		22	24	50	77	848				
1.3 (45 kW)	1991.09-		MT		Hatchback Engine BA32108(KAT)	GCI28001	Inner Joint		24	22	35	60.8	97				
	1991.09-		MT		Hatchback Engine BA32108(KAT)	GC028001	Outer Joint		22	22	50	77	53.5	I			
	1991.09-		MT	L	Hatchback Engine BA32108(KAT)	GDS28001	Drive Shaft		22	24	50	77	600				
	1991.09-		MT	R	Hatchback Engine BA32108(KAT)	GDS28002	Drive Shaft		22	24	50	77	848				
1.3 (46 kW)	1988.01-		MT		Hatchback Engine BA32108	GCI28001	Inner Joint		24	22	35	60.8	97				
	1988.01-		MT		Hatchback Engine BA32108	GC028001	Outer Joint		22	22	50	77	53.5	I			
	1988.01-		MT	L	Hatchback Engine BA32108	GDS28001	Drive Shaft		22	24	50	77	600				
	1988.01-		MT	R	Hatchback Engine BA32108	GDS28002	Drive Shaft		22	24	50	77	848				
1.3 (48 kW)	1986.01-	1994.12	MT		Hatchback Engine BA32108	GCI28001	Inner Joint		24	22	35	60.8	97				
	1986.01-	1994.12	MT		Hatchback Engine BA32108	GC028001	Outer Joint		22	22	50	77	53.5	I			
	1986.01-	1994.12	MT	L	Hatchback Engine BA32108	GDS28001	Drive Shaft		22	24	50	77	600				
	1986.01-	1994.12	MT	R	Hatchback Engine BA32108	GDS28002	Drive Shaft		22	24	50	77	848				

		YEAR	TRANSM	L/R	F/R		G-AP Ref.	PRODUCT	ABS	Technical Specifications										
										A	B	C	H	L	P					
<b>LADA</b>																				
<b>SAMARA (2108, 2109)</b>																				
1.5 (50 kW)	1991.09-		MT		F	Hatchback Engine BA321083(KAT)	GCI28001	Inner Joint		24	22	35	60.8	97						
	1991.09-		MT		F	Hatchback Engine BA321083(KAT)	GC028001	Outer Joint		22	22	50	77	53.5	I					
	1991.09-		MT	L	F	Hatchback Engine BA321083(KAT)	GDS28001	Drive Shaft		22	24	50	77	600						
	1991.09-		MT	R	F	Hatchback Engine BA321083(KAT)	GDS28002	Drive Shaft		22	24	50	77	848						
1.5 (52 kW)	1995.02-		MT		F	Hatchback Engine BA32111	GCI28001	Inner Joint		24	22	35	60.8	97						
	1995.02-		MT		F	Hatchback Engine BA32111	GC028001	Outer Joint		22	22	50	77	53.5	I					
	1995.02-		MT	L	F	Hatchback Engine BA32111	GDS28001	Drive Shaft		22	24	50	77	600						
	1995.02-		MT	R	F	Hatchback Engine BA32111	GDS28002	Drive Shaft		22	24	50	77	848						
1.5 (53 kW)	1988.01-		MT		F	Hatchback Engine BA321083	GCI28001	Inner Joint		24	22	35	60.8	97						
	1988.01-		MT		F	Hatchback Engine BA321083	GC028001	Outer Joint		22	22	50	77	53.5	I					
	1988.01-		MT	L	F	Hatchback Engine BA321083	GDS28001	Drive Shaft		22	24	50	77	600						
	1988.01-		MT	R	F	Hatchback Engine BA321083	GDS28002	Drive Shaft		22	24	50	77	848						
<b>SAMARA 2110</b>																				
-			MT	L			GDS28003	Drive Shaft		22	24	50	77	594						
			MT	R			GDS28004	Drive Shaft		22	24	50	77	856.2						
<b>SAMARA FORMA (21099)</b>																				
1.1 (39 kW)	1991.07-		MT		F	Saloon Engine BA321081(KAT)	GCI28001	Inner Joint		24	22	35	60.8	97						
	1991.07-		MT		F	Saloon Engine BA321081(KAT)	GC028001	Outer Joint		22	22	50	77	53.5	I					
	1991.07-		MT	L	F	Saloon Engine BA321081(KAT)	GDS28001	Drive Shaft		22	24	50	77	600						
	1991.07-		MT	R	F	Saloon Engine BA321081(KAT)	GDS28002	Drive Shaft		22	24	50	77	848						
1.3 (45 kW)	1991.07-		MT		F	Saloon Engine BA32108	GCI28001	Inner Joint		24	22	35	60.8	97						
	1991.07-		MT		F	Saloon Engine BA32108	GC028001	Outer Joint		22	22	50	77	53.5	I					
	1991.07-		MT	L	F	Saloon Engine BA32108	GDS28001	Drive Shaft		22	24	50	77	600						
	1991.07-		MT	R	F	Saloon Engine BA32108	GDS28002	Drive Shaft		22	24	50	77	848						
1.3 (46 kW)	1990.05-		MT		F	Saloon Engine BA32108	GCI28001	Inner Joint		24	22	35	60.8	97						
	1990.05-		MT		F	Saloon Engine BA32108	GC028001	Outer Joint		22	22	50	77	53.5	I					
	1990.05-		MT	L	F	Saloon Engine BA32108	GDS28001	Drive Shaft		22	24	50	77	600						
	1990.05-		MT	R	F	Saloon Engine BA32108	GDS28002	Drive Shaft		22	24	50	77	848						
1.3 (48 kW)	1989.05-1997.07		MT		F	Saloon Engine BA32108	GCI28001	Inner Joint		24	22	35	60.8	97						
	1989.05-1997.07		MT		F	Saloon Engine BA32108	GC028001	Outer Joint		22	22	50	77	53.5	I					
	1989.05-1997.07		MT	L	F	Saloon Engine BA32108	GDS28001	Drive Shaft		22	24	50	77	600						
	1989.05-1997.07		MT	R	F	Saloon Engine BA32108	GDS28002	Drive Shaft		22	24	50	77	848						
1.5 (50 kW)	1991.07-		MT		F	Saloon Engine BA321083(KAT)	GCI28001	Inner Joint		24	22	35	60.8	97						
	1991.07-		MT		F	Saloon Engine BA321083(KAT)	GC028001	Outer Joint		22	22	50	77	53.5	I					
	1991.07-		MT	L	F	Saloon Engine BA321083(KAT)	GDS28001	Drive Shaft		22	24	50	77	600						
	1991.07-		MT	R	F	Saloon Engine BA321083(KAT)	GDS28002	Drive Shaft		22	24	50	77	848						
1.5 (53 kW)	1991.09-		MT		F	Saloon Engine BA321083	GCI28001	Inner Joint		24	22	35	60.8	97						
	1991.09-		MT		F	Saloon Engine BA321083	GC028001	Outer Joint		22	22	50	77	53.5	I					
	1991.09-		MT	L	F	Saloon Engine BA321083	GDS28001	Drive Shaft		22	24	50	77	600						
	1991.09-		MT	R	F	Saloon Engine BA321083	GDS28002	Drive Shaft		22	24	50	77	848						
<b>LANCIA</b>																				
<b>BETA (828BC)</b>																				
1.3 (62 kW)	1981.12-	1984.12	MT		F	Coupe Engine 828D3.000	GCI48004	Inner Joint			25		32							
1.6 (74 kW)	1976.04-	1984.12	MT		F	Coupe Engine 828B.000	GCI48004	Inner Joint			25		32							
2.0 (85 kW)	1981.01-	1984.12	MT		F	Coupe	GCI48004	Inner Joint			25		32							
2.0 (88 kW)	1976.04-	1984.12	MT		F	Coupe Engine 828B1.000	GCI48004	Inner Joint			25		32							
2.0 i.e. (90 kW)	1981.12-	1984.12	MT		F	Coupe	GCI48004	Inner Joint			25		32							
<b>BETA (828_B_)</b>																				
1.3 (61 kW)	1976.04-	1982.07			F	Hatchback	GCI18070	Inner Joint			25		32							
	1976.04-	1982.07	MT		F	Hatchback	GCI48004	Inner Joint			25		32							
1.6 (74 kW)	1973.08-	1982.07			F	Hatchback Engine 828B.000	GCI48004	Inner Joint			25		32							
2.0 (85 kW)	1978.07-	1982.07	MT		F	Hatchback Engine 828B1.000	GCI48004	Inner Joint			25		32							
<b>BETA H.P.E. (828BF)</b>																				
1.6 (74 kW)	1980.08-	1984.09	MT		F	Hatchback Engine 828B.000	GCI48004	Inner Joint			25		32							
2.0 (85 kW)	1979.04-	1984.09	MT		F	Hatchback Engine 828B1.000	GCI18070	Inner Joint			25		32							
2.0 (88 kW)	1976.05-	1978.05			F	Hatchback Engine 828B1.000	GC017002	Outer Joint		25	25	54.5	77	58	I					
	1976.05-	1978.05			F	Hatchback Engine 828B1.000	GCI18070	Inner Joint			25		32							
	1976.05-	1978.05	MT		F	Hatchback Engine 828B1.000	GCI48004	Inner Joint			25		32							
2.0 i.e. (90 kW)	1981.05-	1984.09	MT		F	Hatchback Engine 828B4.000	GCI48004	Inner Joint			25		32							
<b>BETA MONTE CARLO (137AS, 137BS)</b>																				
2.0 (88 kW)	1975.09-	1981.05			R	Targa Engine 134AS.000	GCI18070	Inner Joint			25		32							









		TRANSM	L/R	F/R		G-AP Ref.	PRODUCT	ABS	Technical Specifications									
									YEAR	A	B	C	H	L	P			
<b>LANCIA</b>																		
<b>BETA SPIDER (828BS)</b>																		
1.6 (74 kW)	1976.05-	1982.08	MT		F	Targa Engine 828B.000	GCI48004	Inner Joint			25		32					
2.0 (85 kW)	1979.04-	1986.10	MT		F	Targa Engine 828B1.000	GCI48004	Inner Joint			25		32					
2.0 (88 kW)	1976.05-	1979.11			F	Targa Engine 828B1.000	GCI48004	Inner Joint			25		32					
<b>DEDRA (835)</b>																		
1.8 i.e. (66 kW)	1993.08-	1999.07			F	Saloon Engine 835C5.000	GCI18070	Inner Joint			25		32					
	1993.08-	1999.07	MT		F	Saloon Engine 835C5.000	GCI48004	Inner Joint			25		32					
1.8 i.e. (77 kW)	1989.09-	1999.07	MT		F	Saloon Engine 835A2.046	GCI48004	Inner Joint			25		32					
1.8 i.e. (80 kW)	1989.09-	1994.06	MT		F	Saloon Engine 835A2.000	GCI48004	Inner Joint			25		32					
1.9 TDS (66 kW)	1989.04-	1999.07	MT		F	Saloon Engine 160D1.000/835A4.000/835A4.046	GCI48004	Inner Joint			25		32					
	1994.07-	1999.07	MT		F	Estate Engine 160D1.000/835A4.000	GCI18070	Inner Joint			25		32					
2.0 i.e. (83 kW)	1989.09-	1999.07	MT		F	Saloon Engine 835A5.046	GCI48004	Inner Joint			25		32					
2.0 i.e. (86 kW)	1989.09-	1992.07	MT		F	Saloon Engine 835A5.000	GCI48004	Inner Joint			25		32					
<b>DELTA (831AB0)</b>																		
1.3 (55 kW)	1979.09-	1992.08	MT		F	Hatchback Engine 831A2.000/831B.000	GC017005	Outer Joint		22	20	48.1	90.5	59.5		O		
1.5 (63 kW)	1979.09-	1992.12	MT		F	Hatchback Engine 831A1.000/831B1.000	GC017006	Outer Joint		22	25	48.1	93.5	60.5		I		
	1979.09-	1992.12	MT		F	Hatchback Engine 831A1.000/831B1.000	GCI48004	Inner Joint			25		32					
1.6 GT (77 kW)	1982.11-	1986.04	MT		F	Hatchback Engine 831A4.000	GC017006	Outer Joint		22	25	48.1	93.5	60.5		I		
	1982.11-	1986.04	MT		F	Hatchback Engine 831A4.000	GCI48004	Inner Joint			25		32					
1.6 GT i.e. (66 kW)	1987.05-	1992.08	MT		F	Hatchback Engine 149C2.000	GC017006	Outer Joint		22	25	48.1	93.5	60.5		I		
	1987.05-	1992.08	MT		F	Hatchback Engine 149C2.000	GCI48004	Inner Joint			25		32					
1.6 GT i.e. (80 kW)	1986.08-	1988.08	MT		F	Hatchback Engine 831B7.000	GC017006	Outer Joint		22	25	48.1	93.5	60.5		I		
	1986.08-	1988.08	MT		F	Hatchback Engine 831B7.000	GCI48004	Inner Joint			25		32					
2.0 16V HF Integrale (144 kW)	1989.03-	1991.09	MT			Hatchback Engine 831D5.000	GC017018	Outer Joint	90T	25	25	52	85	58		I		
<b>DELTA II (836)</b>																		
1.6 i.e. (55 kW)	1993.06-	1999.08	MT		F	Hatchback Engine 835C1.000	GC017021	Outer Joint		22	22	46.8	75.5	52		O		
	1993.06-	1999.08	MT		F	Hatchback Engine 835C1.000	GC017022	Outer Joint	44T	22	22	46.8	75.5	52		O		
<b>DELTA III (844)</b>																		
1.4 (110 kW)	2008.09-				F	Hatchback Engine 198A1.000	GC017030	Outer Joint		25	26	51	84.5	64.5		M		
	2008.09-			L			GCI17035	Inner Joint		25	26	34.9	57.5	114.5				
	2008.09-			R			GCI17058	Inner Joint		25	26	34.9	367	108.5				
	2008.09-		MT/AT				GC017030	Outer Joint		25	26	51	84.5	64.5		M		
1.4 (88 kW)	2008.09-				F	Hatchback Engine 198A4.000	GC017030	Outer Joint		25	26	51	84.5	64.5		M		
	2008.09-			R			GCI17058	Inner Joint		25	26	34.9	367	108.5				
	2008.09-		MT/AT				GC017030	Outer Joint		25	26	51	84.5	64.5		M		
1.4 16V (103 kW)	2010.07-			L			GCI17031	Inner Joint		25	26	32	59	110.5				
1.4 16V (88 kW)	2010.07-			L			GCI17031	Inner Joint		25	26	32	59	110.5				
1.6 D Multijet (77 kW)	2008.09-	2011.04		L			GCI17031	Inner Joint		25	26	32	59	110.5				
1.6 D Multijet (85 kW)	2008.08-			L/R	F	Hatchback Engine 955A4.000	GDS17194	Drive Shaft		25	39.2	51	84.5	523				
1.6 D Multijet (88 kW)	2008.09-				F	Hatchback Engine 198A2.000	GC017030	Outer Joint		25	26	51	84.5	64.5		M		
	2008.09-	2011.04		L			GCI17031	Inner Joint		25	26	32	59	110.5				
	2008.09-			L		w/o Selespeed	GCI17005	Inner Joint		25	26	32	91	95				
	2008.09-						GC017063	Outer Joint		25	25	51.1	84.5	61		M		
	2008.09-						GC017030	Outer Joint		25	26	51	84.5	64.5		M		
1.8 (147 kW)	2009.01-			L			GCI21017	Inner Joint		27	27	35	78.5	112				
	2009.01-						GC017064	Outer Joint		27	27	59	84.5	64		M		
1.9 D Multijet (140 kW)	2009.01-			L			GCI21017	Inner Joint		27	27	35	78.5	112				
	2009.01-						GC017064	Outer Joint		27	27	59	84.5	64		M		
2.0 D Multijet (121 kW)	2008.09-			L			GCI21017	Inner Joint		27	27	35	78.5	112				
	2008.09-						GC017064	Outer Joint		27	27	59	84.5	64		M		
<b>KAPPA (838)</b>																		
2.0 20V Turbo (162 kW)	1998.06-	2001.03	MT/AT		F	Coupe Engine 175A3.000	GC029001	Outer Joint	44T	27	25	60	84.5	57.5		O		
<b>KAPPA (838A)</b>																		
2.0 20V (107 kW)	1994.10-	2001.10	MT		F	Saloon Engine 838A1.000	GC029001	Outer Joint	44T	27	25	60	84.5	57.5		O		
2.0 20V (114 kW)	1996.07-	2001.10	MT/AT		F	Saloon Engine 838A6.000	GC029001	Outer Joint	44T	27	25	60	84.5	57.5		O		
2.0 20V Turbo (162 kW)	1998.06-	2001.10	MT/AT		F	Saloon Engine 175A3.000	GC029001	Outer Joint	44T	27	25	60	84.5	57.5		O		
<b>KAPPA (838A, B), SW</b>																		
2.0 16V T Coupe (151 kW)	1995.02-	2001.10					GC082011	Outer Joint	44T	27	28	56	85	63.5		O		
2.0 20V (107 kW)	1994.10-	2001.10					GC029003	Outer Joint	44T	27	25	60	85	58		I		
2.0 20V Turbo (162 kW)	1998.06-	2001.10		L			GCI82007	Inner Joint			34		47.5					
2.4 20V (129 kW)	1994.08-	2001.10		L		Ch-2084919	GCI82007	Inner Joint			34		47.5					
2.4 20V Coupe (129 kW)	1994.08-	2004.10				Ch-2084918	GC082011	Outer Joint	44T	27	28	56	85	63.5		O		
2.4 JTD (100 kW)	1998.06-	2001.10		L			GCI82007	Inner Joint			34		47.5					



		YEAR	TRANSM	L/R	F/R		G-AP Ref.	PRODUCT	ABS	Technical Specifications						
										A	B	C	H	L	P	
<b>LANCIA</b>																
<b>KAPPA (838A, B), SW</b>																
2.4 TDS (91 kW)	1994.08-	2001.10					GC082011	Outer Joint	44T		27	28	56	85	63.5	O
3.0 24V (150 kW)	1994.08-	2001.10		L		Ch-2084919	GCI82007	Inner Joint				34		47.5		
3.0 24V Coupe (150 kW)	1994.08-	2001.10				Ch-2084918	GC082011	Outer Joint	44T		27	28	56	85	63.5	O
<b>KAPPA (838B)</b>																
2.0 20V (114 kW)	1996.07-	2001.10	MT/AT		F	Estate Engine 838A6.000	GC029001	Outer Joint	44T		27	25	60	84.5	57.5	O
2.0 20V Turbo (162 kW)	1998.06-	2001.10	MT/AT		F	Estate Engine 175A3.000	GC029001	Outer Joint	44T		27	25	60	84.5	57.5	O
<b>LYBRA (839AX)</b>																
1.6 16V (76 kW)	1999.07-	2005.10	MT		F	Saloon Engine 182A4.000	GC017011	Outer Joint			25	22	51	84.5	57	O
1.8 16V (96 kW)	1999.07-	2005.10	5MT		F	Saloon Engine 839A4.000/839A7.000/839A9.000	GC017042	Outer Joint			25	25	51	85	58	O
	1999.07-	2005.10	5MT		F	Saloon Engine 839A4.000/839A7.000/839A9.000	GCI82005	Inner Joint				25		32		
1.9 JTD (85 kW)	2001.05-	2005.10		L	F	Saloon Engine 937A2.000	GDS82003	Drive Shaft			25	26.65	59	84	502	
	2001.05-	2005.10		R	F	Saloon Engine 937A2.000	GDS82004	Drive Shaft			25	26.65	59	84	521	
<b>LYBRA (839AX, BX), SW</b>																
1.9 JTD (77 kW)	1999.07-	2001.05		L			GCI82007	Inner Joint				34		47.5		
	1999.07-	2000.09					GC082012	Outer Joint			25	28	59	85	63	O
1.9 JTD (81 kW)	1999.07-	2001.05		L			GCI82007	Inner Joint				34		47.5		
	2000.09-	2001.05					GC082012	Outer Joint			25	28	59	85	63	O
1.9 JTD (85 kW)	1999.07-	2001.05		L			GCI82007	Inner Joint				34		47.5		
	2001.05-			L		Ch-0137878	GCI17005	Inner Joint			25	26	32	91	95	
	2001.05-			R		Ch-0137878	GCI17006	Inner Joint			25	26	29.8	377	108	
	2001.05-					Ch-0137877	GC082012	Outer Joint			25	28	59	85	63	O
	2001.05-					Ch-0137878	GC017009	Outer Joint			25	26	59	84	63	M
2.0 20V (113 kW)	1999.07-	2000.09					GC017042	Outer Joint			25	25	51	85	58	O
2.4 20V Blindata (125 kW)	2002-						GC017009	Outer Joint			25	26	59	84	63	M
2.4 JTD (103 kW)	1999.07-	2002.05		L			GCI17005	Inner Joint			25	26	32	91	95	
	1999.07-	2002.05		R			GCI99130	Inner Joint			25	26	29.8	469	108	
	2000.09-	2002.05					GC017009	Outer Joint			25	26	59	84	63	M
2.4 JTD (110 kW)	1999.07-	2002.05		L			GCI17005	Inner Joint			25	26	32	91	95	
	1999.07-	2002.05		R			GCI99130	Inner Joint			25	26	29.8	469	108	
	2002.05-						GC017009	Outer Joint			25	26	59	84	63	M
2.4 JTD (99 kW)	1999.07-	2000.09					GC017009	Outer Joint			25	26	59	84	63	M
	1999.07-	2002.05		L			GCI17005	Inner Joint			25	26	32	91	95	
<b>LYBRA (839BX)</b>																
1.6 16V (76 kW)	1999.07-	2005.10	MT		F	Estate Engine 182A4.000	GC017011	Outer Joint			25	22	51	84.5	57	O
1.8 16V (96 kW)	1999.07-	2005.10	5MT		F	Estate Engine 839A4.000/839A7.000	GC017042	Outer Joint			25	25	51	85	58	O
	1999.07-	2005.10	5MT		F	Estate Engine 839A4.000/839A7.000	GCI82005	Inner Joint				25		32		
1.9 JTD (85 kW)	2001.05-	2005.10		L	F	Estate Engine 937A2.000	GDS82003	Drive Shaft			25	26.65	59	84	502	
	2001.05-	2005.10		R	F	Estate Engine 937A2.000	GDS82004	Drive Shaft			25	26.65	59	84	521	
<b>MUSA (350)</b>																
1.3 D Multijet (51 kW)	2004.10-				F	MPV Engine 188A9.000	GC017027	Outer Joint			25	23	51	84.5	60	M
	2004.10-				F	MPV Engine 188A9.000	GCI82005	Inner Joint				25		32		
	2004.10-		5MT	L	F	MPV Engine 188A9.000	GDS17147	Drive Shaft			25		51	84.5	480	
	2004.10-		5MT	R	F	MPV Engine 188A9.000	GDS17066	Drive Shaft			25	33.9	51	84.5	497	
	2004.10-			L			GCI17011	Inner Joint			24	23	29.7	86.5	93	
	2004.10-			R			GCI17012	Inner Joint			24	23	29.7	379	100.5	
1.3 D Multijet (66 kW)	2006.09-				F	MPV Engine 199A3.000	GC017028	Outer Joint			25	24	51	84.5	62	M
	2006.09-	2009.03		L			GCI99008	Inner Joint			24	24	29.7	86.5	93	
	2006.09-	2009.03		R			GCI17015	Inner Joint			24	24	29.7	379	100.5	
	2006.09-			L	F	MPV Engine 199A3.000	GDS17054	Drive Shaft			25	35.45	51	84.5	472	
1.3 D Multijet (68 kW)	2006.09-	2009.03		L			GCI99008	Inner Joint			24	24	29.7	86.5	93	
	2006.09-	2009.03		R			GCI17015	Inner Joint			24	24	29.7	379	100.5	
1.3 D Multijet (70 kW)	2006.09-	2009.03		L			GCI99008	Inner Joint			24	24	29.7	86.5	93	
	2006.09-	2009.03		R			GCI17015	Inner Joint			24	24	29.7	379	100.5	
	2009.03-				F	MPV Engine 199B1.000	GC017028	Outer Joint			25	24	51	84.5	62	M
1.4 (57 kW)	2004.10-	2010				GCI17027	Inner Joint			22	22	36	61.5	93.5		
1.4 (66 kW)	2005.09-				F	MPV Engine 350A1.000	GC017014	Outer Joint			22	21	51	79.5	54	M
	2004.10-	2010					GCI17027	Inner Joint			22	22	36	61.5	93.5	
1.4 (70 kW)	2004.10-				F	MPV Engine 843A1.000	GC017014	Outer Joint			22	21	51	79.5	54	M
	2004.10-	2010					GCI17027	Inner Joint			22	22	36	61.5	93.5	
1.6 D Multijet (85 kW)	2008.07-	2010		L			GCI17005	Inner Joint			25	26	32	91	95	
	2008.07-			R			GCI17006	Inner Joint			25	26	29.8	377	108	

		YEAR	TRANSM	L/R	F/R		G-AP Ref.	PRODUCT	ABS	Technical Specifications							
										A	B	C	H	L	P		
<b>LANCIA MUSA (350)</b>																	
1.6 D Multijet (88 kW)	2008.07-				F	MPV Engine 350A2.000	GC082025	Outer Joint		25	26	51	84.5	64.5	M		
	2008.07-2010-2010-	2010		L			GCI17005	Inner Joint		25	26	32	91	95			
1.9 D Multijet (74 kW)	2004.10-				F	MPV Engine 188B2.000	GC017028	Outer Joint		25	24	51	84.5	62	M		
	2004.10-			R			GCI17062	Inner Joint		34	24	34.9	300	102.5			
<b>PHEDRA (179)</b>																	
2.0 (100 kW)	2002.09-	2010.11	MT	L	F	MPV Engine RFN(EW10J4)	GDS10422	Drive Shaft		27	24	58	81.5	659			
2.0 JTD (80 kW)	2002.09-	2010.11			F	MPV Engine RHW(DW10ATED4)	GC017044	Outer Joint		27	28	58	81.5	62	M		
2.2 JTD (94 kW)	2002.09-	2010.11			F	MPV Engine 4HW(DW12ATED4)	GC017044	Outer Joint		27	28	58	81.5	62	M		
	2002.09-	2010.11			F	MPV Engine 4HW(DW12ATED4)	GC018098	Outer Joint		27	29	58	81	71	M		
2002.09-						GC018098	Outer Joint		27	29	58	81	71	M			
3.0 V6 (150 kW)	2002.09-						GC018098	Outer Joint		27	29	58	81	71	M		
<b>PRISMA (831AB0)</b>																	
1.5 (55 kW)	1985.09-	1992.02	AT		F	Saloon Engine 138C2.048/831B1.048	GC017006	Outer Joint		22	25	48.1	93.5	60.5	I		
	1985.09-	1992.02	MT		F	Saloon Engine 138C2.048/831B1.048	GC017005	Outer Joint		22	20	48.1	90.5	59.5	O		
1.5 (59 kW)	1986.08-	1992.02	AT		F	Saloon Engine 831B1.000	GC017006	Outer Joint		22	25	48.1	93.5	60.5	I		
	1986.08-	1992.02	MT		F	Saloon Engine 831B1.000	GC017005	Outer Joint		22	20	48.1	90.5	59.5	O		
1.5 (63 kW)	1983.01-	1986.04	AT		F	Saloon Engine 831A1.000	GC017006	Outer Joint		22	25	48.1	93.5	60.5	I		
	1983.01-	1986.04	MT		F	Saloon Engine 831A1.000	GC017005	Outer Joint		22	20	48.1	90.5	59.5	O		
1.6 (73 kW)	1986.08-	1992.02	MT		F	Saloon Engine 831B6.000	GC017006	Outer Joint		22	25	48.1	93.5	60.5	I		
	1986.08-	1992.02	MT		F	Saloon Engine 831B6.000	GCI48004	Inner Joint			25		32				
1.6 (77 kW)	1983.01-	1986.04	MT		F	Saloon Engine 831A4.000	GC017006	Outer Joint		22	25	48.1	93.5	60.5	I		
	1983.01-	1986.04	MT		F	Saloon Engine 831A4.000	GCI48004	Inner Joint			25		32				
1.6 i.e. (80 kW)	1986.05-	1989.12	MT		F	Saloon Engine 831B7.000	GC017006	Outer Joint		22	25	48.1	93.5	60.5	I		
	1986.05-	1989.12	MT		F	Saloon Engine 831B7.000	GCI48004	Inner Joint			25		32				
1.6 i.e. Super (66 kW)	1987.05-	1989.12	MT		F	Saloon Engine 149C2.000	GCI18070	Inner Joint			25		32				
1.9 Diesel (48 kW)	1983.01-	1992.02	MT		F	Saloon Engine 831D.000	GC017006	Outer Joint		22	25	48.1	93.5	60.5	I		
	1983.01-	1992.02	MT		F	Saloon Engine 831D.000	GCI48004	Inner Joint			25		32				
1.9 Turbo Diesel (59 kW)	1985.05-	1989.12	MT		F	Saloon Engine 831D1.000	GC017006	Outer Joint		22	25	48.1	93.5	60.5	I		
	1985.05-	1989.12	MT		F	Saloon Engine 831D1.000	GCI48004	Inner Joint			25		32				
2.0 i.e. (85 kW)	1986.04-	1989.12	MT		F	Saloon Engine 831B4.000	GCI48004	Inner Joint			25		32				
	1986.04-	1989.12				Saloon Engine 831B4.000	GCI82006	Inner Joint			25		32				
<b>THEMA (834)</b>																	
2.0 16V (112 kW)	1992.08-	1993.12	MT/AT		F	Saloon Engine 834F1.000	GCI48004	Inner Joint			25		32				
	1992.08-	1993.12	MT/AT		F	Saloon Engine 834F1.000	GC017003	Outer Joint	90T	25	25	54.5	77	58	I		
2.0 16V Turbo (133 kW)	1988.12-	1990.06	MT/AT		F	Saloon Engine 834C1.000	GC017003	Outer Joint	90T	25	25	54.5	77	58	I		
2.0 16V Turbo (148 kW)	1992.10-	1994.07	MT/AT		F	Saloon Engine 834F2.000	GC017003	Outer Joint	90T	25	25	54.5	77	58	I		
2.0 i.e. (83 kW)	1986.03-	1988.09	MT/AT		F	Saloon Engine 834B.048	GC017002	Outer Joint		25	25	54.5	77	58	I		
	1986.03-	1988.09	MT/AT		F	Saloon Engine 834B.048	GCI48004	Inner Joint			25		32				
	1986.03-	1988.09	MT/AT		F	Saloon Engine 834B.048	GC017003	Outer Joint	90T	25	25	54.5	77	58	I		
	1986.03-	1988.09	MT/AT		F	Saloon Engine 834B.048	GC017018	Outer Joint	90T	25	25	52	85	58	I		
2.0 i.e. (85 kW)	1987.09-	1992.05	MT/AT		F	Saloon Engine 834B.146	GCI18070	Inner Joint			25		32				
	1987.09-	1992.05	MT		F	Saloon Engine 834B.146	GC017033	Outer Joint		27	25	56	85	58	I		
	1987.09-	1992.05			F	Saloon Engine 834B.146	GC017013	Outer Joint	44T	27	25	56	85	58	I		
	1987.09-	1992.05	MT/AT		F	Saloon Engine 834B.146	GC017018	Outer Joint	90T	25	25	52	85	58	I		
2.0 i.e. (88 kW)	1984.11-	1988.09	MT/AT		F	Saloon Engine 834B.000	GC017002	Outer Joint		25	25	54.5	77	58	I		
	1984.11-	1988.09	MT/AT		F	Saloon Engine 834B.000	GCI48004	Inner Joint			25		32				
	1984.11-	1988.09	MT/AT		F	Saloon Engine 834B.000	GC017003	Outer Joint	90T	25	25	54.5	77	58	I		
2.0 i.e. 16V Turbo (130 kW)	1989.04-	1993.03	MT/AT		F	Estate Engine 834C1.246	GCI48004	Inner Joint			25		32				
	1989.04-	1992.05	MT/AT		F	Saloon Engine 834C1.246	GC017003	Outer Joint	90T	25	25	54.5	77	58	I		
	1989.04-	1993.03	MT/AT		F	Estate Engine 834C1.246	GC017003	Outer Joint	90T	25	25	54.5	77	58	I		
2.0 i.e. Turbo (110 kW)	1986.07-	1990.05	MT/AT		F	Saloon Engine 834C.146	GC017002	Outer Joint		25	25	54.5	77	58	I		
	1986.07-	1990.05	MT/AT		F	Saloon Engine 834C.146	GCI48004	Inner Joint			25		32				
	1986.07-	1990.05	MT/AT		F	Saloon Engine 834C.146	GC017003	Outer Joint	90T	25	25	54.5	77	58	I		
2.0 i.e. Turbo (122 kW)	1984.11-	1987.12	MT/AT		F	Saloon Engine 834C.000	GCI18070	Inner Joint			25		32				
	1984.11-	1987.12	MT		F	Saloon Engine 834C.000	GC017033	Outer Joint		27	25	56	85	58	I		
	1984.11-	1987.12	MT/AT		F	Saloon Engine 834C.000	GC017013	Outer Joint	44T	27	25	56	85	58	I		
	1984.11-	1987.12	MT/AT		F	Saloon Engine 834C.000	GC017003	Outer Joint	90T	25	25	54.5	77	58	I		
	1984.11-	1987.12	MT/AT		F	Saloon Engine 834C.000	GC017018	Outer Joint	90T	25	25	52	85	58	I		
2.0 Turbo (110 kW)	1989.01-	1992.03	MT/AT		F	Estate Engine 834C.146	GC017002	Outer Joint		25	25	54.5	77	58	I		
	1989.01-	1992.03	MT/AT		F	Estate Engine 834C.146	GCI48004	Inner Joint			25		32				
	1989.01-	1992.03	MT/AT		F	Estate Engine 834C.146	GC017003	Outer Joint	90T	25	25	54.5	77	58	I		









		TRANSM	L/R	F/R		G-AP Ref.	PRODUCT	ABS	Technical Specifications						
									YEAR	A	B	C	H	L	P
<b>LANCIA</b>															
<b>THEMA (834)</b>															
2.0 Turbo 16V (148 kW)	1992.11-	1994.07	MT/AT		F	Estate Engine 834F2.000	GCO17003	Outer Joint	90T	25	25	54.5	77	58	I
2.5 Turbo D (74 kW)	1984.11-	1988.09	MT/AT		F	Saloon Engine 8144.91	GCO17002	Outer Joint		25	25	54.5	77	58	I
	1984.11-	1988.09	MT/AT		F	Saloon Engine 8144.91	GCI48004	Inner Joint			25		32		
	1984.11-	1988.09	MT/AT		F	Saloon Engine 8144.91	GCO17003	Outer Joint	90T	25	25	54.5	77	58	I
2.5 Turbo DS (74 kW)	1987.03-	1990.09	MT/AT		F	Estate Engine 8144.91	GCI18070	Inner Joint			25		32		
2.5 Turbo DS (77 kW)	1988.05-	1992.07	MT/AT		F	Saloon Engine 8144.97S	GCO17002	Outer Joint		25	25	54.5	77	58	I
	1988.05-	1992.07	MT/AT		F	Estate Engine 8144.97S	GCO17002	Outer Joint		25	25	54.5	77	58	I
	1988.05-	1992.07	MT/AT		F	Saloon Engine 8144.97S	GCO17003	Outer Joint	90T	25	25	54.5	77	58	I
	1988.05-	1992.07	MT/AT		F	Estate Engine 8144.97S	GCO17003	Outer Joint	90T	25	25	54.5	77	58	I
2.5 Turbo DS (85 kW)	1988.06-	1992.05	MT/AT		F	Saloon Engine 8144.97	GCO17013	Outer Joint	44T	27	25	56	85	58	I
	1988.06-	1992.05	MT/AT		F	Saloon Engine 8144.97	GCO17018	Outer Joint	90T	25	25	52	85	58	I
	1992.05-	1994.07	MT/AT		F	Saloon Engine 8144.97Y	GCO17013	Outer Joint	44T	27	25	56	85	58	I
	1992.05-	1994.07	MT/AT		F	Saloon Engine 8144.97Y	GCO17018	Outer Joint	90T	25	25	52	85	58	I
	1992.09-	1994.07	MT/AT		F	Estate Engine 8144.97Y	GCO17013	Outer Joint	44T	27	25	56	85	58	I
	1992.09-	1994.07	MT/AT		F	Estate Engine 8144.97Y	GCO17018	Outer Joint	90T	25	25	52	85	58	I
2.9 V6 i.e. (108 kW)	1988.06-	1992.05	MT/AT		F	Saloon Engine 834E.146	GCO17002	Outer Joint		25	25	54.5	77	58	I
	1988.06-	1992.05	MT/AT		F	Saloon Engine 834E.146	GCI48004	Inner Joint			25		32		
2.9 V6 i.e. (110 kW)	1984.11-	1988.09	MT/AT		F	Saloon Engine 834E.000	GCO17002	Outer Joint		25	25	54.5	77	58	I
	1984.11-	1988.09	MT/AT		F	Saloon Engine 834E.000	GCI48004	Inner Joint			25		32		
3.0 V6 (126 kW)	1992.08-	1994.07	MT		F	Saloon Engine 834F.000	GCO17033	Outer Joint		27	25	56	85	58	I
	1992.08-	1994.07			F	Saloon Engine 834F.000	GCO17013	Outer Joint	44T	27	25	56	85	58	I
	1992.09-	1994.07	MT		F	Estate Engine 834F.000	GCO17033	Outer Joint		27	25	56	85	58	I
	1992.09-	1994.07			F	Estate Engine 834F.000	GCO17013	Outer Joint	44T	27	25	56	85	58	I
<b>THESIS (841AX)</b>															
2.0 T (136 kW)	2002.07-						GCO17047	Outer Joint		27	26	59	83.5	63	M
2.0 Turbo (136 kW)	2002.07-			L			GCI17005	Inner Joint		25	26	32	91	95	
2.4 (125 kW)	2002.07-						GCO17047	Outer Joint		27	26	59	83.5	63	M
2.4 Bz (125 kW)	2002.07-			L			GCI17005	Inner Joint		25	26	32	91	95	
2.4 D Multijet (136 kW)	2006.04-						GCO17047	Outer Joint		27	26	59	83.5	63	M
2.4 JTD (110 kW)	2002.07-						GCO17047	Outer Joint		27	26	59	83.5	63	M
	2006.04-			L			GCI17005	Inner Joint		25	26	32	91	95	
2.4 JTD (120 kW)	2006.04-		AT	L			GCI17048	Inner Joint		26	26	31	68	94.5	
	2006.04-		MT	L			GCI21016	Inner Joint		27	26	35	78.5	112	
	2006.04-		AT	R			GCI17069	Inner Joint		26	26	31	418.5	108.5	
	2006.04-		MT	R			GCI17076	Inner Joint		27	26	35	428	108.5	
2.4 JTD (129 kW)	2003.05-						GCO17047	Outer Joint		27	26	59	83.5	63	M
	2006.04-		AT	L			GCI17048	Inner Joint		26	26	31	68	94.5	
	2006.04-		MT	L			GCI21016	Inner Joint		27	26	35	78.5	112	
	2006.04-		AT	R			GCI17069	Inner Joint		26	26	31	418.5	108.5	
3.0 V6 (158 kW)	2002.07-		AT	L			GCI17048	Inner Joint		26	26	31	68	94.5	
	2002.07-		AT	R			GCI17069	Inner Joint		26	26	31	418.5	108.5	
3.2 V6 (169 kW)	2003.05-		AT	L			GCI17048	Inner Joint		26	26	31	68	94.5	
	2003.05-		AT	R			GCI17069	Inner Joint		26	26	31	418.5	108.5	
<b>TREVI (828DB)</b>															
1.6 (74 kW)	1980.05-	1987.01	MT		F	Saloon Engine 828B.000	GCO17002	Outer Joint		25	25	54.5	77	58	I
	1980.05-	1987.01			F	Saloon Engine 828B.000	GCI82006	Inner Joint			25		32		
2.0 i.e. (90 kW)	1980.05-	1987.01			F	Saloon Engine 828B4.000	GCI18070	Inner Joint			25		32		
	1980.05-	1987.01	MT		F	Saloon Engine 828B4.000	GCI48004	Inner Joint			25		32		
2.0 Volumex (99 kW)	1983.08-	1985.05			F	Saloon Engine 828B7.000	GCI18070	Inner Joint			25		32		
<b>Y (840A)</b>															
1.1 (40 kW)	1995.11-	2003.09	MT		F	Hatchback Engine 176B2.000	GCO17039	Outer Joint	44T	22	20	46.8	75.5	52	O
	1995.11-	2003.09	MT		F	Hatchback Engine 176B2.000	GCO17001	Outer Joint		22	20	46.8	75.5	52	O
	1995.11-	2003.09	MT	L	F	Hatchback Engine 176B2.000	GDS17010	Drive Shaft		22	31.95	46.8	75.5	569	
	1995.11-	2003.09	MT	L	F	Hatchback Engine 176B2.000	GCO17001	Outer Joint		22	20	46.8	75.5	52	O
	1995.11-	2003.09	MT	R	F	Hatchback Engine 176B2.000	GDS17011	Drive Shaft		22	31.95	46.8	75.5	928.5	
	1995.11-	2003.09					GCI17001	Inner Joint		22	19	36	61.5	88.5	
1.2 (44 kW)	1996.03-	2003.09	MT		F	Hatchback Engine 188A4.000/840A3.000	GCO17039	Outer Joint	44T	22	20	46.8	75.5	52	O
	1996.03-	2003.09	MT		F	Hatchback Engine 188A4.000/840A3.000	GCO17001	Outer Joint		22	20	46.8	75.5	52	O
	1996.03-	2003.09	MT	L	F	Hatchback Engine 188A4.000/840A3.000	GDS17010	Drive Shaft		22	31.95	46.8	75.5	569	
	1996.03-	2003.09	MT	L	F	Hatchback Engine 188A4.000/840A3.000	GCO17001	Outer Joint		22	20	46.8	75.5	52	O
	1996.03-	2003.09	MT	R	F	Hatchback Engine 188A4.000/840A3.000	GDS17011	Drive Shaft		22	31.95	46.8	75.5	928.5	

		TRANSM	L/R	F/R		G-AP Ref.	PRODUCT	ABS	Technical Specifications									
									YEAR	A	B	C	H	L	P			
<b>LANCIA</b>																		
<b>Y (840A)</b>																		
1.2 (44 kW)	1996.03-	2003.09				GCI17001	Inner Joint		22	19	36	61.5	88.5					
1.2 16V (59 kW)	1997.04-	2003.09			Vett3336903-	GC017008	Outer Joint		22	20	51	79.5	51.5	O				
	1997.04-	2003.09				GCI17027	Inner Joint		22	22	36	61.5	93.5					
	2000.10-	2003.09		F	Hatchback Engine 188A5.000	GC017014	Outer Joint		22	21	51	79.5	54	M				
1.2 16V (63 kW)	1997.04-	2003.09		F	Hatchback Engine 176B9.000	GC017014	Outer Joint		22	21	51	79.5	54	M				
	1997.04-	2003.09		F	Hatchback Engine 176B9.000	GC017008	Outer Joint		22	20	51	79.5	51.5	O				
	1997.04-	2003.09	MT/AT	F	Hatchback Engine 176B9.000	GC017039	Outer Joint	44T	22	20	46.8	75.5	52	O				
	1997.04-	2003.09	MT/AT	F	Hatchback Engine 176B9.000	GC017001	Outer Joint		22	20	46.8	75.5	52	O				
	1997.04-	2003.09			Vett3336903-	GC017008	Outer Joint		22	20	51	79.5	51.5	O				
	1997.04-	2003.09				GCI17027	Inner Joint		22	22	36	61.5	93.5					
	1997.04-	2003.09	MT/AT	F	Hatchback Engine 840A4.000	GC017039	Outer Joint	44T	22	20	46.8	75.5	52	O				
1.4 12V (55 kW)	1996.03-	2003.09	MT/AT	F	Hatchback Engine 840A4.000	GC017001	Outer Joint		22	20	46.8	75.5	52	O				
	1996.03-	2003.09	MT	L	F	Hatchback Engine 840A4.000	GDS17010	Drive Shaft	22	31.95	46.8	75.5	569					
	1996.03-	2003.09	MT	L	F	Hatchback Engine 840A4.000	GC017001	Outer Joint	22	20	46.8	75.5	52	O				
	1996.03-	2003.09	MT	R	F	Hatchback Engine 840A4.000	GDS17011	Drive Shaft	22	31.95	46.8	75.5	928.5					
	1996.03-	2003.09	MT	R	F	Hatchback Engine 840A2.000	GC017039	Outer Joint	44T	22	20	46.8	75.5	52	O			
1.4 12V (59 kW)	1996.10-	2003.09	MT/AT	F	Hatchback Engine 840A2.000	GC017001	Outer Joint		22	20	46.8	75.5	52	O				
	1996.10-	2003.09	MT	L	F	Hatchback Engine 840A2.000	GDS17010	Drive Shaft	22	31.95	46.8	75.5	569					
	1996.10-	2003.09	MT	L	F	Hatchback Engine 840A2.000	GC017001	Outer Joint	22	20	46.8	75.5	52	O				
	1996.10-	2003.09	MT	R	F	Hatchback Engine 840A2.000	GDS17011	Drive Shaft	22	31.95	46.8	75.5	928.5					
	1996.10-	2003.09	MT	R	F	Hatchback Engine 840A2.000	GDS17011	Drive Shaft	22	31.95	46.8	75.5	928.5					
<b>YPSILON (843)</b>																		
1.2 (44 kW)	2003.10-	2011.12		F	Hatchback Engine 188A4.000	GC017014	Outer Joint		22	21	51	79.5	54	M				
1.2 (59 kW)	2003.10-	2011.12		F	Hatchback Engine 188A5.000	GC017014	Outer Joint		22	21	51	79.5	54	M				
1.3 D Multijet (55 kW)	2006.09-	2011.12		F	Hatchback Engine 199A2.000	GC029002	Outer Joint		25	28	51	84	58.5	O				
	2006.09-	2011.12	5MT	L	F	Hatchback Engine 199A2.000	GDS17147	Drive Shaft	25		51	84.5	480					
	2006.09-	2011.12	5MT	L	F	Hatchback Engine 199A2.000	GDS17082	Drive Shaft	25	33.9	51	84.5	514					
	2006.09-	2011.12	5MT	R	F	Hatchback Engine 199A2.000	GDS17066	Drive Shaft	25	33.9	51	84.5	497					
1.3 D Multijet (66 kW)	2006.09-	2011.12		F	Hatchback Engine 199A3.000	GC017028	Outer Joint		25	24	51	84.5	62	M				
	2006.09-	2011.12	6MT	L	F	Hatchback Engine 199A3.000	GDS17172	Drive Shaft	25	33.9	51	84.5	486					
	2006.09-	2011.12	6MT	L	F	Hatchback Engine 199A3.000	GC017053	Outer Joint	25	23	51	84.5	60	M				
	2006.09-	2011.12	6MT	R	F	Hatchback Engine 199A3.000	GDS17146	Drive Shaft	25		51	84.5	522					
1.3 D Multijet (77 kW)	2007.05-	2011.12		F	Hatchback Engine 199A3.000	GC017028	Outer Joint		25	24	51	84.5	62	M				
	2007.05-	2011.12		L	F	Hatchback Engine 199A3.000	GDS17054	Drive Shaft	25	35.45	51	84.5	472					
1.3 JTD (51 kW)	2003.10-	2011.12		F	Hatchback Engine 188A9.000	GC029002	Outer Joint		25	28	51	84	58.5	O				
	2003.10-	2011.12	5MT	L	F	Hatchback Engine 188A9.000	GDS17147	Drive Shaft	25		51	84.5	480					
1.4 (57 kW)	2006.02-	2011.12		F	Hatchback Engine 350A1.000	GC017014	Outer Joint		22	21	51	79.5	54	M				
1.4 16V (70 kW)	2003.10-	2011.12		F	Hatchback Engine 843A1.000	GC017014	Outer Joint		22	21	51	79.5	54	M				
<b>YPSILON I (843)</b>																		
0.9 (62 kW)	2011.05-					GCI17027	Inner Joint		22	22	36	61.5	93.5					
1.2 (51 kW)	2003.10-	2010.08				GCI17027	Inner Joint		22	22	36	61.5	93.5					
1.2 (59 kW)	2003.10-	2010.08				GCI17027	Inner Joint		22	22	36	61.5	93.5					
1.2 8V (50 kW)	2011.05-					GCI17001	Inner Joint		22	19	36	61.5	88.5					
1.3 D Multijet (51 kW)	2003.10-	2006.03		L		GCI17011	Inner Joint		24	23	29.7	86.5	93					
	2003.10-	2006.03		R		GCI17012	Inner Joint		24	23	29.7	379	100.5					
	2006.09-					GCI17016	Inner Joint			28		48.5						
	2006.09-					GC029002	Outer Joint		25	28	51	84	58.5	O				
1.3 D Multijet (55 kW)	2006.09-					GCI17016	Inner Joint			28		48.5						
	2006.09-					GC029002	Outer Joint		25	28	51	84	58.5	O				
1.3 D Multijet (56 kW)	2003.10-	2006.03		L		GCI17011	Inner Joint		24	23	29.7	86.5	93					
	2003.10-	2006.03		R		GCI17012	Inner Joint		24	23	29.7	379	100.5					
1.3 D Multijet (66 kW)	2007.05-			L		GCI99008	Inner Joint		24	24	29.7	86.5	93					
	2007.05-			R		GCI17015	Inner Joint		24	24	29.7	379	100.5					
1.3 D Multijet (77 kW)	2007.05-			L		GCI99008	Inner Joint		24	24	29.7	86.5	93					
	2007.05-			R		GCI17015	Inner Joint		24	24	29.7	379	100.5					
1.3 DS (70 kW)	2011.05-			L		GCI17011	Inner Joint		24	23	29.7	86.5	93					
1.4 (57 kW)	2006.02-					GCI17027	Inner Joint		22	22	36	61.5	93.5					
1.4 16V (70 kW)	2003.10-					GCI17027	Inner Joint		22	22	36	61.5	93.5					
1.4 LPG (57 kW)	2010.11-					GCI17027	Inner Joint		22	22	36	61.5	93.5					
<b>ZETA (220)</b>																		
2.0 16V (100 kW)	2000.07-	2002.09		F	MPV Engine RFN	GC010018	Outer Joint	48T	27	34	61	82	55	I				
2.0 JTD (80 kW)	1999.09-	2002.09		F	MPV Engine RHW	GC010015	Outer Joint	48T	27	39	59	82	63	I				
	1999.09-	2002.09	MT	L	F	MPV Engine RHW	GDS10264	Drive Shaft	48T	27	37	59	82	630				







		TRANSM	L/R	F/R		G-AP Ref.	PRODUCT	ABS	Technical Specifications						
									YEAR	A	B	C	H	L	P
<b>LANCIA</b>															
<b>ZETA (220)</b>															
2.0 JTD (80 kW)	1999.09-	2002.09	MT	R	F	MPV Engine RHW	GDS10057	Drive Shaft		27	37	59	82	960	
	1999.09-	2002.09	MT	R	F	MPV Engine RHW	GDS45120	Drive Shaft	48T	27	37	59	82	960	
	1999.09-	2002.09		R	F	MPV Engine RHW	GDS10237	Drive Shaft	48T	27	37	59	82	953	
	2000.04-	2002.09			F	MPV Engine RHZ	GC010015	Outer Joint	48T	27	39	59	82	63	I
2.0 Turbo (108 kW)	1995.05-	2002.09			F	MPV Engine RGX	GC010015	Outer Joint	48T	27	39	59	82	63	I
<b>LAND ROVER</b>															
<b>90/110 (DHMC)</b>															
2.5 4x4 (62 kW)	1985.09-	1990.07	MT		F	Closed Off-Road Vehicle Engine 17H	GC051016	Outer Joint		24	32	44.3	180.5	56	I
2.5 TD 4x4 (63 kW)	1986.09-	1990.07	5MT		F	Closed Off-Road Vehicle Engine 19J	GC051016	Outer Joint		24	32	44.3	180.5	56	I
3.5 V8 4x4 (100 kW)	1983.09-	1990.07	MT		F	Closed Off-Road Vehicle	GC051016	Outer Joint		24	32	44.3	180.5	56	I
<b>DEFENDER</b>															
110	1995.01-		MT				GC030003	Outer Joint		24	32	67	154	56	I
2.5 Diesel 110			MT				GC099113	Outer Joint		24	23	44.3	180.5	56	I
90	1995.01-		MT				GC030003	Outer Joint		24	32	67	154	56	I
<b>DEFENDER STATION WAGON (LD)</b>															
2.5 90,110 TDi 4x4 (83 kW)	1990.09-	1998.12			F	Closed Off-Road Vehicle Engine 11L/16L/23L	GC051016	Outer Joint		24	32	44.3	180.5	56	I
3.5 4x4 (100 kW)	1990.09-	1998.12	MT		F	Closed Off-Road Vehicle Engine 22D	GC051016	Outer Joint		24	32	44.3	180.5	56	I
<b>DISCOVERY</b>															
-	1990.01-		MT				GC030005	Outer Joint		24	32	67	154	56	I
-	1990.01-						GC030004	Outer Joint		24	32	67	154	56	I
<b>DISCOVERY (LJ, LG)</b>															
2.5 TDi 4x4 (83 kW)	1989.10-	1998.10	MT		F	Closed Off-Road Vehicle Engine 12L/17L/19L/21L	GC030002	Outer Joint		10	32	66.6	32.5	57	I
3.5 4x4 (113 kW)	1989.10-	1994.06	MT		F	Closed Off-Road Vehicle Engine 22D	GC030002	Outer Joint		10	32	66.6	32.5	57	I
<b>DISCOVERY I</b>															
-							GC030011	Outer Joint		24	23	66.7	184	58	I
<b>DISCOVERY II (LJ, LT)</b>															
2.5 TD5 4x4 (102 kW)	1999.01-	2004.06			F	Closed Off-Road Vehicle Engine 10P	GC099211	Outer Joint		24	32	62	100	95	I
4.0 V8 4x4 (136 kW)	1998.11-	2004.06	MT		F	Closed Off-Road Vehicle Engine 56D	GC099211	Outer Joint		24	32	62	100	95	I
<b>DISCOVERY III</b>															
-	2005-	2009					GC018229	Outer Joint	48T	31	27	73	97.5	67.5	M
<b>DISCOVERY III (TAA)</b>															
2.7 TD 4x4 (140 kW)	2004.07-	2009.09	AT	L	F	Closed Off-Road Vehicle Engine 276DT	GDS59535	Drive Shaft	48T	29	29	74	96	639	
	2004.07-	2009.09	AT			Closed Off-Road Vehicle Engine 276DT	GC030015	Outer Joint	48T	29	26	74	96	64.5	M
	2004.07-	2009.09	MT			Closed Off-Road Vehicle Engine 276DT	GC030012	Outer Joint	48T	29	27	74	96	67.5	M
4.0 4x4 (160 kW)	2005.02-	2009.09	AT	L	F	Closed Off-Road Vehicle	GDS30002	Drive Shaft	48T	29	29	74	96	638	
	2005.02-	2009.09	AT	R	F	Closed Off-Road Vehicle	GDS59480	Drive Shaft	48T	29	29	74	96	999	
	2005.02-	2009.09				Closed Off-Road Vehicle	GC030012	Outer Joint	48T	29	27	74	96	67.5	M
4.0 4x4 (161 kW)	2005.02-	2009.09	AT	L	F	Closed Off-Road Vehicle	GDS30002	Drive Shaft	48T	29	29	74	96	638	
	2005.02-	2009.09	AT	R	F	Closed Off-Road Vehicle	GDS59480	Drive Shaft	48T	29	29	74	96	999	
4.0 V6 4x4 (160 kW)	2004.10-	2009.09	AT	L	F	Closed Off-Road Vehicle Engine 406PN	GDS30002	Drive Shaft	48T	29	29	74	96	638	
	2004.10-	2009.09	AT	R	F	Closed Off-Road Vehicle Engine 406PN	GDS59480	Drive Shaft	48T	29	29	74	96	999	
	2004.10-	2009.09				Closed Off-Road Vehicle Engine 406PN	GC030012	Outer Joint	48T	29	27	74	96	67.5	M
4.4 4x4 (220 kW)	2004.07-	2009.09	AT	L	F	Closed Off-Road Vehicle Engine 448PN	GDS30002	Drive Shaft	48T	29	29	74	96	638	
	2004.07-	2009.09	AT	R	F	Closed Off-Road Vehicle Engine 448PN	GDS59480	Drive Shaft	48T	29	29	74	96	999	
	2004.07-	2009.09				Closed Off-Road Vehicle Engine 448PN	GC030012	Outer Joint	48T	29	27	74	96	67.5	M
<b>DISCOVERY IV</b>															
-	2010-						GC018229	Outer Joint	48T	31	27	73	97.5	67.5	M
<b>DISCOVERY IV (LA)</b>															
2.7 TD 4x4 (140 kW)	2009.09-		AT	L	F	Closed Off-Road Vehicle Engine 276DT	GDS59535	Drive Shaft	48T	29	29	74	96	639	
	2009.09-		MT	L	F	Closed Off-Road Vehicle Engine 276DT	GDS30002	Drive Shaft	48T	29	29	74	96	638	
	2009.09-		MT	R	F	Closed Off-Road Vehicle Engine 276DT	GDS59480	Drive Shaft	48T	29	29	74	96	999	
	2009.09-		AT			Closed Off-Road Vehicle Engine 276DT	GC030015	Outer Joint	48T	29	26	74	96	64.5	M
	2009.09-		MT			Closed Off-Road Vehicle Engine 276DT	GC030012	Outer Joint	48T	29	27	74	96	67.5	M
3.0 SD V6 4x4 (188 kW)	2009.11-		AT	L	F	Closed Off-Road Vehicle Engine 30DDTX	GDS59535	Drive Shaft	48T	29	29	74	96	639	
	2009.11-					Closed Off-Road Vehicle Engine 30DDTX	GC030015	Outer Joint	48T	29	26	74	96	64.5	M
3.0 TD 4x4 (155 kW)	2010.05-		AT	L	F	Closed Off-Road Vehicle Engine 30DDTX/306DT	GDS59535	Drive Shaft	48T	29	29	74	96	639	
	2010.05-					Closed Off-Road Vehicle Engine 30DDTX/306DT	GC030015	Outer Joint	48T	29	26	74	96	64.5	M
3.0 TD 4x4 (180 kW)	2009.09-		AT	L	F	Closed Off-Road Vehicle Engine 306DT	GDS59535	Drive Shaft	48T	29	29	74	96	639	
	2009.09-					Closed Off-Road Vehicle Engine 306DT	GC030015	Outer Joint	48T	29	26	74	96	64.5	M
3.0 TD 4x4 (183 kW)	2012.07-		AT	L	F	Closed Off-Road Vehicle Engine 306DT	GDS59535	Drive Shaft	48T	29	29	74	96	639	
	2012.07-					Closed Off-Road Vehicle Engine 306DT	GC030015	Outer Joint	48T	29	26	74	96	64.5	M





	 YEAR	TRANSM	L/R	F/R		G-AP Ref.	PRODUCT	ABS	Technical Specifications							
									A	B	C	H	L	P		
<b>LAND ROVER DISCOVERY IV (LA)</b>																
3.0 TD 4x4 (200 kW)	2009.09-		AT	L	F	Closed Off-Road Vehicle Engine 30DDTX	GDS59535	Drive Shaft	48T	29	29	74	96	639		
	2009.09-					Closed Off-Road Vehicle Engine 30DDTX	GC030015	Outer Joint	48T	29	26	74	96	64.5	M	
4.0 4x4 (160 kW)	2009.09-		AT	L	F	Closed Off-Road Vehicle	GDS30002	Drive Shaft	48T	29	29	74	96	638		
	2009.09-		AT	R	F	Closed Off-Road Vehicle	GDS59480	Drive Shaft	48T	29	29	74	96	999		
	2009.09-					Closed Off-Road Vehicle	GC030012	Outer Joint	48T	29	27	74	96	67.5	M	
5.0 V8 4x4 (276 kW)	2009.09-		AT	L	F	Closed Off-Road Vehicle Engine 508PN	GDS30002	Drive Shaft	48T	29	29	74	96	638		
	2009.09-		AT	R	F	Closed Off-Road Vehicle Engine 508PN	GDS59480	Drive Shaft	48T	29	29	74	96	999		
	2009.09-					Closed Off-Road Vehicle Engine 508PN	GC030012	Outer Joint	48T	29	27	74	96	67.5	M	
<b>FREELANDER</b>																
-	1998.01-	2000.12	MT/AT	L/R			GDS51009	Drive Shaft	60W	28	25	55.6	85	611		
1.8	1998.01-	2000.12	MT/AT				GCI30001	Inner Joint		25	32	40	57.5	101.5		
1.8 i	1997.12-	2000.08	MT/AT		F/R		GC051015	Outer Joint		28	32	55.6	85	61	I	
	1997.12-	2000.08			F	Ch.-No A999999	GCI51007	Inner Joint		25	25	40	57.5	93		
	1997.12-	2000.08		L/R	F		GDS51008	Drive Shaft	60W	28	25	57.7	85	613		
	2000.09-		MT/AT		F/R		GC030009	Outer Joint		28	32	56	83.5	61	I	
2.0 TD 16V	2000.09-		MT/AT	L/R	F		GDS51013	Drive Shaft		28	25	57.7	85	631		
	2000.09-		MT/AT	L/R	F	TD4	GDS51013	Drive Shaft		28	25	57.7	85	631		
2.0 TD 8V	1997.12-	2000.08		L/R	F		GDS51008	Drive Shaft	60W	28	25	57.7	85	613		
	1997.12-	2000.08	MT/AT		F/R		GC051015	Outer Joint		28	32	55.6	85	61	I	
	1997.12-	2000.08			F		GCI51007	Inner Joint		25	25	40	57.5	93		
2.5 V6	2000.09-		MT/AT		F/R		GC030009	Outer Joint		28	32	56	83.5	61	I	
	2000.09-		MT/AT	L/R	F		GDS51013	Drive Shaft		28	25	57.7	85	631		
<b>FREELANDER (LN)</b>																
1.8 16V 4x4 (86 kW)	2000.11-	2006.10	MT			Closed Off-Road Vehicle Engine 18K4F	GC051020	Outer Joint	60W	28	32	55.6	85	61	I	
	2000.11-	2006.10		L/R	F	Closed Off-Road Vehicle Engine 18K4F	GDS30005	Drive Shaft		28	25	56	83.5	610.5		
	2000.11-	2006.10		L/R	R	Closed Off-Road Vehicle Engine 18K4F	GDS51030	Drive Shaft	60W	28	23	57.7	85	806		
	2000.11-	2006.10		L/R	R	Closed Off-Road Vehicle Engine 18K4F	GDS51037	Drive Shaft		28	23	57.7	85	806		
	2000.11-	2006.10				Closed Off-Road Vehicle Engine 18K4F	GC018200	Outer Joint	60W	28	21	57.7	85	61	M	
2.0 TD4 4x4 (80 kW)	2001.03-	2006.10	MT			Closed Off-Road Vehicle Engine M47/204D3	GC051020	Outer Joint	60W	28	32	55.6	85	61	I	
	2001.03-	2006.10		L	F	Closed Off-Road Vehicle Engine M47/204D3	GDS30003	Drive Shaft		28	25	56	83.5	629.5		
	2001.03-	2006.10		R	F	Closed Off-Road Vehicle Engine M47/204D3	GDS30004	Drive Shaft		28	25	56	83.5	589		
	2001.03-	2006.10		L/R	R	Closed Off-Road Vehicle Engine M47/204D3	GDS51030	Drive Shaft	60W	28	23	57.7	85	806		
	2001.03-	2006.10		L/R	R	Closed Off-Road Vehicle Engine M47/204D3	GDS51037	Drive Shaft		28	23	57.7	85	806		
	2001.03-	2006.10			R	Closed Off-Road Vehicle Engine M47/204D3	GDS51025	Drive Shaft	60W	28	23	55.6	85	808		
	2001.03-	2006.10			R	Closed Off-Road Vehicle Engine M47/204D3	GCI51012	Inner Joint		23	32	35.7	85.5	124.5		
	2001.03-	2006.10			R	Closed Off-Road Vehicle Engine M47/204D3	GC051020	Outer Joint	60W	28	32	55.6	85	61	I	
	2001.03-	2006.10				Closed Off-Road Vehicle Engine M47/204D3	GC018200	Outer Joint	60W	28	21	57.7	85	61	M	
2.0 TD4 4x4 (82 kW)	2000.11-	2006.10	MT			Closed Off-Road Vehicle Engine 204D3/M47	GC051020	Outer Joint	60W	28	32	55.6	85	61	I	
	2000.11-	2006.10		L	F	Closed Off-Road Vehicle Engine 204D3/M47	GDS51003	Drive Shaft	60W	28	25	55.6	85	629		
	2000.11-	2006.10		L	F	Closed Off-Road Vehicle Engine 204D3/M47	GDS30003	Drive Shaft		28	25	56	83.5	629.5		
	2000.11-	2006.10		R	F	Closed Off-Road Vehicle Engine 204D3/M47	GDS51002	Drive Shaft	60W	28	25	55.6	85	592		
	2000.11-	2006.10		R	F	Closed Off-Road Vehicle Engine 204D3/M47	GDS30004	Drive Shaft		28	25	56	83.5	589		
	2000.11-	2006.10		L/R	R	Closed Off-Road Vehicle Engine 204D3/M47	GDS51030	Drive Shaft	60W	28	23	57.7	85	806		
	2000.11-	2006.10		L/R	R	Closed Off-Road Vehicle Engine 204D3/M47	GDS51037	Drive Shaft		28	23	57.7	85	806		
	2000.11-	2006.10			R	Closed Off-Road Vehicle Engine 204D3/M47	GDS51025	Drive Shaft	60W	28	23	55.6	85	808		
	2000.11-	2006.10			R	Closed Off-Road Vehicle Engine 204D3/M47	GCI51012	Inner Joint		23	32	35.7	85.5	124.5		
	2000.11-	2006.10			R	Closed Off-Road Vehicle Engine 204D3/M47	GC051020	Outer Joint	60W	28	32	55.6	85	61	I	
2000.11-	2006.10				Closed Off-Road Vehicle Engine 204D3/M47	GC018200	Outer Joint	60W	28	21	57.7	85	61	M		
2.5 V6 4x4 (130 kW)	2000.11-	2006.10	MT			Closed Off-Road Vehicle Engine 25K4F	GC051020	Outer Joint	60W	28	32	55.6	85	61	I	
	2000.11-	2006.10		L	F	Closed Off-Road Vehicle Engine 25K4F	GDS51003	Drive Shaft	60W	28	25	55.6	85	629		
	2000.11-	2006.10		L	F	Closed Off-Road Vehicle Engine 25K4F	GDS30003	Drive Shaft		28	25	56	83.5	629.5		
	2000.11-	2006.10		R	F	Closed Off-Road Vehicle Engine 25K4F	GDS51002	Drive Shaft	60W	28	25	55.6	85	592		
	2000.11-	2006.10		R	F	Closed Off-Road Vehicle Engine 25K4F	GDS30004	Drive Shaft		28	25	56	83.5	589		
	2000.11-	2006.10		L/R	R	Closed Off-Road Vehicle Engine 25K4F	GDS51030	Drive Shaft	60W	28	23	57.7	85	806		
	2000.11-	2006.10		L/R	R	Closed Off-Road Vehicle Engine 25K4F	GDS51037	Drive Shaft		28	23	57.7	85	806		
	2000.11-	2006.10				Closed Off-Road Vehicle Engine 25K4F	GC018200	Outer Joint	60W	28	21	57.7	85	61	M	
<b>FREELANDER 2 (FA_)</b>																
2.0 Si4 4x4 (177 kW)	2011.10-	2014.10			F	Closed Off-Road Vehicle Engine 204PT	GC059285	Outer Joint		40	27	57.4	52	63.5	M	
	2011.10-	2014.10	MT		R	Closed Off-Road Vehicle Engine 204PT	GDS57165	Drive Shaft		28	26	57.7	84	819.5		
2.2 ED4 (110 kW)	2010.08-		AT	L	F	Closed Off-Road Vehicle Engine 224DT/DW12BTED4	GDS51038	Drive Shaft		40	31	57.4	52	538		
	2010.08-		MT	L	F	Closed Off-Road Vehicle Engine 224DT/DW12BTED4	GDS59344	Drive Shaft		40	31	57.4	52	554.5		



	 YEAR	TRANSM	L/R	F/R		G-AP Ref.	PRODUCT	ABS	Technical Specifications								
									A	B	C	H	L	P			
<b>LAND ROVER</b>																	
<b>FREELANDER 2 (FA_)</b>																	
2.2 ED4 (110 kW)	2010.08-		MT	R	F	Closed Off-Road Vehicle Engine 224DT/DW12BTED4	GDS59346	Drive Shaft		40	28	57.4	52	1022.5			
	2010.08-				F	Closed Off-Road Vehicle Engine 224DT/DW12BTED4	GC059285	Outer Joint		40	27	57.4	52	63.5	M		
	2010.08-				R	Closed Off-Road Vehicle Engine 224DT/DW12BTED4	GDS57165	Drive Shaft		28	26	57.7	84	819.5			
2.2 SD4 4x4 (140 kW)	2010.08-		AT	L	F	Closed Off-Road Vehicle Engine 224DT	GDS51038	Drive Shaft		40	31	57.4	52	538			
	2010.08-		MT	L	F	Closed Off-Road Vehicle Engine 224DT	GDS59344	Drive Shaft		40	31	57.4	52	554.5			
	2010.08-		MT	R	F	Closed Off-Road Vehicle Engine 224DT	GDS59346	Drive Shaft		40	28	57.4	52	1022.5			
	2010.08-				F	Closed Off-Road Vehicle Engine 224DT	GC059285	Outer Joint		40	27	57.4	52	63.5	M		
	2010.08-				R	Closed Off-Road Vehicle Engine 224DT	GDS57165	Drive Shaft		28	26	57.7	84	819.5			
2.2 TD4 4x4 (110 kW)	2006.10-		AT	L	F	Closed Off-Road Vehicle Engine 224DT/DW12BTED4	GDS51038	Drive Shaft		40	31	57.4	52	538			
	2006.10-		MT	L	F	Closed Off-Road Vehicle Engine 224DT/DW12BTED4	GDS59344	Drive Shaft		40	31	57.4	52	554.5			
	2006.10-		MT	R	F	Closed Off-Road Vehicle Engine 224DT/DW12BTED4	GDS59346	Drive Shaft		40	28	57.4	52	1022.5			
	2006.10-				F	Closed Off-Road Vehicle Engine 224DT/DW12BTED4	GC059285	Outer Joint		40	27	57.4	52	63.5	M		
	2006.10-				R	Closed Off-Road Vehicle Engine 224DT/DW12BTED4	GDS57165	Drive Shaft		28	26	57.7	84	819.5			
2.2 TD4 4x4 (112 kW)	2007.01-		AT	L	F	Closed Off-Road Vehicle Engine 224DT	GDS51038	Drive Shaft		40	31	57.4	52	538			
	2007.01-		MT	L	F	Closed Off-Road Vehicle Engine 224DT	GDS59344	Drive Shaft		40	31	57.4	52	554.5			
	2007.01-		MT	R	F	Closed Off-Road Vehicle Engine 224DT	GDS59346	Drive Shaft		40	28	57.4	52	1022.5			
	2007.01-				F	Closed Off-Road Vehicle Engine 224DT	GC059285	Outer Joint		40	27	57.4	52	63.5	M		
	2007.01-				R	Closed Off-Road Vehicle Engine 224DT	GDS57165	Drive Shaft		28	26	57.7	84	819.5			
2.2 TD4 4x4 (115 kW)	2006.10-		AT	L	F	Closed Off-Road Vehicle Engine 224DT	GDS51038	Drive Shaft		40	31	57.4	52	538			
	2006.10-		MT	L	F	Closed Off-Road Vehicle Engine 224DT	GDS59344	Drive Shaft		40	31	57.4	52	554.5			
	2006.10-		MT	R	F	Closed Off-Road Vehicle Engine 224DT	GDS59346	Drive Shaft		40	28	57.4	52	1022.5			
	2006.10-				F	Closed Off-Road Vehicle Engine 224DT	GC059285	Outer Joint		40	27	57.4	52	63.5	M		
	2006.10-				R	Closed Off-Road Vehicle Engine 224DT	GDS57165	Drive Shaft		28	26	57.7	84	819.5			
2.2 TD4 4x4 (118 kW)	2006.10-		AT	L	F	Closed Off-Road Vehicle Engine 224DT	GDS51038	Drive Shaft		40	31	57.4	52	538			
	2006.10-		MT	L	F	Closed Off-Road Vehicle Engine 224DT	GDS59344	Drive Shaft		40	31	57.4	52	554.5			
	2006.10-		MT	R	F	Closed Off-Road Vehicle Engine 224DT	GDS59346	Drive Shaft		40	28	57.4	52	1022.5			
	2006.10-				F	Closed Off-Road Vehicle Engine 224DT	GC059285	Outer Joint		40	27	57.4	52	63.5	M		
	2006.10-				R	Closed Off-Road Vehicle Engine 224DT	GDS57165	Drive Shaft		28	26	57.7	84	819.5			
3.2 4x4 (171 kW)	2006.10-		AT	L	F	Closed Off-Road Vehicle Engine 224DT	GDS51038	Drive Shaft		40	31	57.4	52	538			
	2006.10-		MT	L	F	Closed Off-Road Vehicle Engine 224DT	GDS59344	Drive Shaft		40	31	57.4	52	554.5			
	2006.10-		MT	R	F	Closed Off-Road Vehicle Engine 224DT	GDS59346	Drive Shaft		40	28	57.4	52	1022.5			
	2006.10-				F	Closed Off-Road Vehicle Engine 224DT	GC059285	Outer Joint		40	27	57.4	52	63.5	M		
	2006.10-				R	Closed Off-Road Vehicle Engine 224DT	GDS57165	Drive Shaft		28	26	57.7	84	819.5			
3.2 4x4 (171 kW)	2006.10-				F	Closed Off-Road Vehicle Engine B6324S	GC059285	Outer Joint		40	27	57.4	52	63.5	M		
	2006.10-				R	Closed Off-Road Vehicle Engine B6324S	GDS57165	Drive Shaft		28	26	57.7	84	819.5			
<b>FREELANDER I</b>																	
1.8	2000.09-	2007.04	MT	L/R	F	Hard Top	GDS51024	Drive Shaft	60W	28	25	57.7	85	631			
2.0 TD 16V	2000.09-	2006.01	MT/AT	L/R	F	Hard Top	GDS51024	Drive Shaft	60W	28	25	57.7	85	631			
2.5 V6	2000.09-	2006.01	AT	L/R	F	Hard Top	GDS51024	Drive Shaft	60W	28	25	57.7	85	631			
<b>FREELANDER I (LN)</b>																	
1.8 16V (86 kW)	2000.11-				R		GC030016	Outer Joint		28	21	57.7	85	61	M		
<b>FREELANDER SOFT TOP</b>																	
1.8 i 16V 4x4 (88 kW)	1998.02-	2006.10	MT			Open Off-Road Vehicle Engine 18K4F	GC051020	Outer Joint	60W	28	32	55.6	85	61	I		
	1998.02-	2006.10			F	Open Off-Road Vehicle Engine 18K4F	GDS30005	Drive Shaft		28	25	56	83.5	610.5			
	1998.02-	2006.10			R	Open Off-Road Vehicle Engine 18K4F	GDS51030	Drive Shaft	60W	28	23	57.7	85	806			
	1998.02-	2006.10			R	Open Off-Road Vehicle Engine 18K4F	GDS51037	Drive Shaft		28	23	57.7	85	806			
	1998.02-	2006.10			R	Open Off-Road Vehicle Engine 18K4F	GCI51012	Inner Joint		23	32	35.7	85.5	124.5			
	1998.02-	2006.10			R	Open Off-Road Vehicle Engine 18K4F	GC051020	Outer Joint	60W	28	32	55.6	85	61	I		
2.0 Di 4x4 (72 kW)	1998.02-	2006.10	MT			Open Off-Road Vehicle Engine 20T2N	GC051020	Outer Joint	60W	28	32	55.6	85	61	I		
	1998.02-	2006.10		L	F	Open Off-Road Vehicle Engine 20T2N	GDS30003	Drive Shaft		28	25	56	83.5	629.5			
	1998.02-	2006.10		R	F	Open Off-Road Vehicle Engine 20T2N	GDS30004	Drive Shaft		28	25	56	83.5	589			
	1998.02-	2006.10		L/R	R	Open Off-Road Vehicle Engine 20T2N	GDS51030	Drive Shaft	60W	28	23	57.7	85	806			
	1998.02-	2006.10		L/R	R	Open Off-Road Vehicle Engine 20T2N	GDS51037	Drive Shaft		28	23	57.7	85	806			
	1998.02-	2006.10			R	Open Off-Road Vehicle Engine 20T2N	GDS51025	Drive Shaft	60W	28	23	55.6	85	808			
	1998.02-	2006.10			R	Open Off-Road Vehicle Engine 20T2N	GCI51012	Inner Joint		23	32	35.7	85.5	124.5			
	1998.02-	2006.10			R	Open Off-Road Vehicle Engine 20T2N	GC051020	Outer Joint	60W	28	32	55.6	85	61	I		
	1998.02-	2006.10				Open Off-Road Vehicle Engine 20T2N	GC018200	Outer Joint	60W	28	21	57.7	85	61	M		
	<b>FREELANDER V6</b>																
2.0							GCI51005	Inner Joint		25	26	40	57.5	101.5			
<b>FREELANDER VAN</b>																	
1.8 i	1997.12-	2000.08		L/R	F		GDS51008	Drive Shaft	60W	28	25	57.7	85	613			
	1997.12-	2000.08	MT/AT		F/R		GC051015	Outer Joint		28	32	55.6	85	61	I		
	1997.12-	2000.08			F		GCI51007	Inner Joint		25	25	40	57.5	93			
	2000.09-		MT/AT	L/R	F	Ch.-No 1A000001	GDS51013	Drive Shaft		28	25	57.7	85	631			
2.0 TD 16V	2000.09-		MT/AT		F/R		GC030009	Outer Joint		28	32	56	83.5	61	I		
	2000.09-		MT/AT	L/R	F	TD4	GDS51013	Drive Shaft		28	25	57.7	85	631			





	 YEAR	 TRANSM	 L/R	 F/R		G-AP Ref.	PRODUCT	ABS	Technical Specifications									
									A	B	C	H	L	P				
<b>LAND ROVER FREELANDER VAN</b>																		
2.0 TD 8V	1997.12-2000.08			L/R	F		GDS51008	Drive Shaft	60W	28	25	57.7	85	613				
	1997.12-2000.08	MT/AT			F/R		GC051015	Outer Joint		28	32	55.6	85	61	I			
	1997.12-2000.08				F		GC151007	Inner Joint		25	25	40	57.5	93				
<b>LAND ROVER</b>																		
110							GC099113	Outer Joint		24	23	44.3	180.5	56	I			
90							GC099113	Outer Joint		24	23	44.3	180.5	56	I			
<b>LANDROVER RANGE ROVER SPORT (LS)</b>																		
3.0 TD 4x4 (183 kW)	2012.08-2013.03	AT	L	F	Closed Off-Road Vehicle Engine 306DT	GDS59535	Drive Shaft	48T	29	29	74	96	639					
	2012.08-2013.03				Closed Off-Road Vehicle Engine 306DT	GC030015	Outer Joint	48T	29	26	74	96	64.5	M				
<b>RANGE ROVER (AE, AN, HAA, HAB, HAM, HBM, RE, RN)</b>																		
2.4 Diesel 4x4 (78 kW)	1986.04-1990.12	MT		F	Closed Off-Road Vehicle Engine 11A	GC030001	Outer Joint		10	23	44.4	17	57	I				
	1986.04-1990.12	MT		F	Closed Off-Road Vehicle Engine 11A	GC030002	Outer Joint		10	32	66.6	32.5	57	I				
3.5 4x4 (107 kW)	1987.01-1990.09	MT		F	Closed Off-Road Vehicle Engine 31D	GC030002	Outer Joint		10	32	66.6	32.5	57	I				
3.5 Vogue 4x4 (120 kW)	1985.10-1990.09	MT		F	Closed Off-Road Vehicle Engine 24D/25D	GC030001	Outer Joint		10	23	44.4	17	57	I				
	1985.10-1990.09	MT		F	Closed Off-Road Vehicle Engine 24D/25D	GC030002	Outer Joint		10	32	66.6	32.5	57	I				
3.5 Vogue 4x4 (93 kW)	1981.08-1990.09	MT		F	Closed Off-Road Vehicle Engine 11D	GC030001	Outer Joint		10	23	44.4	17	57	I				
	1981.08-1990.09	MT		F	Closed Off-Road Vehicle Engine 11D	GC030002	Outer Joint		10	32	66.6	32.5	57	I				
3.9 4x4 CAT (127 kW)	1988.11-1994.07	MT		F	Closed Off-Road Vehicle Engine 37D/38D	GC030002	Outer Joint		10	32	66.6	32.5	57	I				
3.9 Vogue SEI 4x4 (134 kW)	1988.11-1994.07	MT		F	Closed Off-Road Vehicle Engine 35D/36D	GC030002	Outer Joint		10	32	66.6	32.5	57	I				
<b>RANGE ROVER EVOQUE (LV)</b>																		
2.0 4x4 (177 kW)	2011.06-				Closed Off-Road Vehicle Engine 204PT	GC018250	Outer Joint		31	27	68.3	97	61	I				
2.2 ED4 (110 kW)	2011.06-	MT	L	F	Closed Off-Road Vehicle Engine 224DT	GDS18408	Drive Shaft		31	31	68.3	97	602					
	2011.06-				Closed Off-Road Vehicle Engine 224DT	GC018250	Outer Joint		31	27	68.3	97	61	I				
2.2 SD4 4x4 (140 kW)	2011.06-	MT	L	F	Closed Off-Road Vehicle Engine 224DT	GDS18408	Drive Shaft		31	31	68.3	97	602					
	2011.06-	MT	R	F	Closed Off-Road Vehicle Engine 224DT	GDS18409	Drive Shaft		31	28	68.3	97	1069					
	2011.06-				Closed Off-Road Vehicle Engine 224DT	GC018250	Outer Joint		31	27	68.3	97	61	I				
2.2 TD4 4x4 (110 kW)	2011.06-	MT	L	F	Closed Off-Road Vehicle Engine 224DT	GDS18408	Drive Shaft		31	31	68.3	97	602					
	2011.06-	MT	R	F	Closed Off-Road Vehicle Engine 224DT	GDS18409	Drive Shaft		31	28	68.3	97	1069					
	2011.06-				Closed Off-Road Vehicle Engine 224DT	GC018250	Outer Joint		31	27	68.3	97	61	I				
<b>RANGE ROVER II (LP)</b>																		
2.5 TD 4x4 (100 kW)	1994.07-2002.03			F	Closed Off-Road Vehicle Engine 256T(BMW)	GC030006	Outer Joint	60T	24	32	61.7	101	60	I				
3.9 4x4 (140 kW)	1994.07-2002.03			F	Closed Off-Road Vehicle Engine 42D	GC030006	Outer Joint	60T	24	32	61.7	101	60	I				
4.0 4x4 (136 kW)	1998.06-2002.03			F	Closed Off-Road Vehicle Engine 42D	GC030006	Outer Joint	60T	24	32	61.7	101	60	I				
4.6 4x4 (160 kW)	1998.06-2002.03	4MT/AT		F	Closed Off-Road Vehicle Engine 60D	GC030006	Outer Joint	60T	24	32	61.7	101	60	I				
4.6 4x4 (165 kW)	1994.07-2002.03	AT		F	Closed Off-Road Vehicle Engine 46D	GC030006	Outer Joint	60T	24	32	61.7	101	60	I				
<b>RANGE ROVER III (LM)</b>																		
3.0 TD 6 4x4 (130 kW)	2002.03-2012.08		L/R	F	Closed Off-Road Vehicle Engine 306D1	GDS51036	Drive Shaft	48W	30		68	84	690					
	2002.03-2012.08				Closed Off-Road Vehicle Engine 306D1	GC085004	Outer Joint	48W	30	29	68	84	74	M				
3.6 TD 8 4x4 (200 kW)	2006.04-2012.08		L/R	F	Closed Off-Road Vehicle Engine 368DT	GDS51036	Drive Shaft	48W	30		68	84	690					
	2006.04-2012.08				Closed Off-Road Vehicle Engine 368DT	GC085004	Outer Joint	48W	30	29	68	84	74	M				
4.2 4x4 (291 kW)	2005.05-2012.08				Closed Off-Road Vehicle Engine 428PS	GC085004	Outer Joint	48W	30	29	68	84	74	M				
4.4 4x4 (210 kW)	2002.03-2012.08		L/R	F	Closed Off-Road Vehicle Engine M62B44	GDS51036	Drive Shaft	48W	30		68	84	690					
	2002.03-2012.08				Closed Off-Road Vehicle Engine M62B44	GC085004	Outer Joint	48W	30	29	68	84	74	M				
4.4 4x4 (220 kW)	2004.08-2012.08				Closed Off-Road Vehicle Engine 448PN	GC085004	Outer Joint	48W	30	29	68	84	74	M				
4.4 4x4 (225 kW)	2005.05-2012.08				Closed Off-Road Vehicle Engine 448PN	GC085004	Outer Joint	48W	30	29	68	84	74	M				
4.4 D 4x4 (230 kW)	2010.07-2012.08				Closed Off-Road Vehicle Engine 448DT	GC085004	Outer Joint	48W	30	29	68	84	74	M				
5.0 4x4 (276 kW)	2009.09-2012.08				Closed Off-Road Vehicle Engine 508PN	GC085004	Outer Joint	48W	30	29	68	84	74	M				
5.0 4x4 (375 kW)	2009.09-2012.08				Closed Off-Road Vehicle Engine 508PS	GC085004	Outer Joint	48W	30	29	68	84	74	M				
<b>RANGE ROVER IV (LG)</b>																		
3.0 TD 4x4 (183 kW)	2012.08-	AT	L	F	Closed Off-Road Vehicle Engine 306DT	GDS59535	Drive Shaft	48T	29	29	74	96	639					
	2012.08-				Closed Off-Road Vehicle Engine 306DT	GC030015	Outer Joint	48T	29	26	74	96	64.5	M				
<b>RANGE ROVER SPORT</b>																		
-	2005-2009						GC018229	Outer Joint	48T	31	27	73	97.5	67.5	M			
<b>RANGE ROVER SPORT (LS)</b>																		
2.7 TDVM 4x4 (140 kW)	2005.02-				Closed Off-Road Vehicle Engine 276DT	GC030015	Outer Joint	48T	29	26	74	96	64.5	M				
3.0 TD 4x4 (180 kW)	2009.09-	AT	L	F	Closed Off-Road Vehicle Engine 30DDTX	GDS59535	Drive Shaft	48T	29	29	74	96	639					
	2009.09-				Closed Off-Road Vehicle Engine 30DDTX	GC030015	Outer Joint	48T	29	26	74	96	64.5	M				
3.0 TD 4x4 (188 kW)	2011.06-	AT	L	F	Closed Off-Road Vehicle Engine 30DDTX	GDS59535	Drive Shaft	48T	29	29	74	96	639					
	2011.06-				Closed Off-Road Vehicle Engine 30DDTX	GC030015	Outer Joint	48T	29	26	74	96	64.5	M				
3.0 TD V6 4x4 (155 kW)	2010.05-	AT	L	F	Closed Off-Road Vehicle Engine 30DDTX	GDS59535	Drive Shaft	48T	29	29	74	96	639					
	2010.05-				Closed Off-Road Vehicle Engine 30DDTX	GC030015	Outer Joint	48T	29	26	74	96	64.5	M				









		YEAR	TRANSM	L/R	F/R		G-AP Ref.	PRODUCT	ABS	Technical Specifications										
										A	B	C	H	L	P					
<b>LAND ROVER</b>																				
<b>RANGE ROVER SPORT (LS)</b>																				
3.6 TD 8 4x4 (200 kW)	2006.04-		AT	L	F	Closed Off-Road Vehicle Engine 368DT	GDS30002	Drive Shaft	48T	29	29	74	96	638						
	2006.04-		AT	R	F	Closed Off-Road Vehicle Engine 368DT	GDS59480	Drive Shaft	48T	29	29	74	96	999						
	2006.04-					Closed Off-Road Vehicle Engine 368DT	GC030012	Outer Joint	48T	29	27	74	96	67.5	M					
4.2 4x4 (287 kW)	2005.02-		AT	L	F	Closed Off-Road Vehicle Engine 428PS	GDS30002	Drive Shaft	48T	29	29	74	96	638						
	2005.02-		AT	R	F	Closed Off-Road Vehicle Engine 428PS	GDS59480	Drive Shaft	48T	29	29	74	96	999						
	2005.02-					Closed Off-Road Vehicle Engine 428PS	GC030012	Outer Joint	48T	29	27	74	96	67.5	M					
4.4 4x4 (220 kW)	2005.02-		AT	L	F	Closed Off-Road Vehicle Engine 448PN	GDS30002	Drive Shaft	48T	29	29	74	96	638						
	2005.02-		AT	R	F	Closed Off-Road Vehicle Engine 448PN	GDS59480	Drive Shaft	48T	29	29	74	96	999						
	2005.02-					Closed Off-Road Vehicle Engine 448PN	GC030012	Outer Joint	48T	29	27	74	96	67.5	M					
<b>RANGE ROVER SPORT II</b>																				
-	2010-						GC018229	Outer Joint	48T	31	27	73	97.5	67.5	M					
<b>LANDWIND</b>																				
<b>X5</b>																				
2.0 T (140 kW)	2013.01-					Closed Off-Road Vehicle Engine 4G63S4T	GC018222	Outer Joint		25	23	53.3	87	56	M					
<b>LDV</b>																				
<b>MAXUS</b>																				
2.5 D (70 kW)	2005.02-	2008.12		L	F	Box Engine VM39C/VM40C	GDS18231	Drive Shaft	48T	30	30	70	117.5	723						
	2005.02-	2008.12		L	F	Box Engine VM39C/VM40C	GDS18402	Drive Shaft		30	30	70	117.5	723						
	2005.02-	2008.12		L	F	Box Engine VM39C/VM40C	GCI34112	Inner Joint		30	26	35	86	81						
	2005.02-	2008.12		L	F	Box Engine VM39C/VM40C	GDS18231	Drive Shaft	48T	30	30	70	117.5	723						
	2005.02-	2008.12		L	F	Bus Engine VM39C/VM40C	GDS18402	Drive Shaft		30	30	70	117.5	723						
	2005.02-	2008.12		L	F	Bus Engine VM39C/VM40C	GCI34112	Inner Joint		30	26	35	86	81						
	2005.02-	2008.12		L/R	F	Box Engine VM39C/VM40C	GC035025	Outer Joint		30	36	70	117.5	68.5	I					
	2005.02-	2008.12		L/R	F	Bus Engine VM39C/VM40C	GC035025	Outer Joint		30	36	70	117.5	68.5	I					
	2005.02-	2008.12		R	F	Box Engine VM39C/VM40C	GDS18232	Drive Shaft	48T	30	30	70	117.5	1095						
	2005.02-	2008.12		R	F	Box Engine VM39C/VM40C	GDS75056	Drive Shaft		30	30	70	117.5	1095						
	2005.02-	2008.12		R	F	Box Engine VM39C/VM40C	GCI18174	Inner Joint		30	26	35	434	105						
	2005.02-	2008.12		R	F	Bus Engine VM39C/VM40C	GDS18232	Drive Shaft	48T	30	30	70	117.5	1095						
	2005.02-	2008.12		R	F	Bus Engine VM39C/VM40C	GDS75056	Drive Shaft		30	30	70	117.5	1095						
	2005.02-	2008.12		R	F	Bus Engine VM39C/VM40C	GCI18174	Inner Joint		30	26	35	434	105						
	2005.02-	2008.12				Box Engine VM39C/VM40C	GC099317	Outer Joint	48T	30	36	70	117.5	68.5	I					
	2005.02-	2008.12				Bus Engine VM39C/VM40C	GC099317	Outer Joint	48T	30	36	70	117.5	68.5	I					
	2005.02-	2008.12		L	F	Platform/Chassis Engine VM39C	GDS18231	Drive Shaft	48T	30	30	70	117.5	723						
	2005.02-	2008.12		L	F	Platform/Chassis Engine VM39C	GDS18402	Drive Shaft		30	30	70	117.5	723						
	2005.02-	2008.12		L	F	Platform/Chassis Engine VM39C	GCI34112	Inner Joint		30	26	35	86	81						
	2005.02-	2008.12		L/R	F	Platform/Chassis Engine VM39C	GC035025	Outer Joint		30	36	70	117.5	68.5	I					
	2005.02-	2008.12		R	F	Platform/Chassis Engine VM39C	GDS18232	Drive Shaft	48T	30	30	70	117.5	1095						
	2005.02-	2008.12		R	F	Platform/Chassis Engine VM39C	GDS75056	Drive Shaft		30	30	70	117.5	1095						
	2005.02-	2008.12		R	F	Platform/Chassis Engine VM39C	GCI18174	Inner Joint		30	26	35	434	105						
2005.02-	2008.12				Platform/Chassis Engine VM39C	GC099317	Outer Joint	48T	30	36	70	117.5	68.5	I						
2.5 D (88 kW)	2005.02-	2009.12		L	F	Bus Engine VM39C	GDS18231	Drive Shaft	48T	30	30	70	117.5	723						
	2005.02-	2009.12		L	F	Bus Engine VM39C	GDS18402	Drive Shaft		30	30	70	117.5	723						
	2005.02-	2009.12		L	F	Bus Engine VM39C	GCI34112	Inner Joint		30	26	35	86	81						
	2005.02-	2009.12		L/R	F	Bus Engine VM39C	GC035025	Outer Joint		30	36	70	117.5	68.5	I					
	2005.02-	2009.12		R	F	Bus Engine VM39C	GDS18232	Drive Shaft	48T	30	30	70	117.5	1095						
	2005.02-	2009.12		R	F	Bus Engine VM39C	GDS75056	Drive Shaft		30	30	70	117.5	1095						
	2005.02-	2009.12		R	F	Bus Engine VM39C	GCI18174	Inner Joint		30	26	35	434	105						
	2005.02-	2009.12				Bus Engine VM39C	GC099317	Outer Joint	48T	30	36	70	117.5	68.5	I					
	2005.10-	2009.12		L	F	Box	GDS18231	Drive Shaft	48T	30	30	70	117.5	723						
	2005.10-	2009.12		L	F	Box	GDS18402	Drive Shaft		30	30	70	117.5	723						
	2005.10-	2009.12		L	F	Box	GCI34112	Inner Joint		30	26	35	86	81						
	2005.10-	2009.12		L	F	Platform/Chassis	GDS18231	Drive Shaft	48T	30	30	70	117.5	723						
	2005.10-	2009.12		L	F	Platform/Chassis	GDS18402	Drive Shaft		30	30	70	117.5	723						
	2005.10-	2009.12		L	F	Platform/Chassis	GCI34112	Inner Joint		30	26	35	86	81						
	2005.10-	2009.12		L/R	F	Box	GC035025	Outer Joint		30	36	70	117.5	68.5	I					
	2005.10-	2009.12		L/R	F	Platform/Chassis	GC035025	Outer Joint		30	36	70	117.5	68.5	I					
	2005.10-	2009.12		R	F	Box	GDS18232	Drive Shaft	48T	30	30	70	117.5	1095						
	2005.10-	2009.12		R	F	Box	GDS75056	Drive Shaft		30	30	70	117.5	1095						
	2005.10-	2009.12		R	F	Box	GCI18174	Inner Joint		30	26	35	434	105						
	2005.10-	2009.12		R	F	Platform/Chassis	GDS18232	Drive Shaft	48T	30	30	70	117.5	1095						
	2005.10-	2009.12		R	F	Platform/Chassis	GDS75056	Drive Shaft		30	30	70	117.5	1095						



		TRANSM	L/R	F/R		G-AP Ref.	PRODUCT	ABS	Technical Specifications								
									YEAR	A	B	C	H	L	P		
<b>LDV MAXUS</b>																	
2.5 D (88 kW)	2005.10-	2009.12		R	F	Platform/Chassis	GCI18174	Inner Joint		30	26	35	434	105			
	2005.10-	2009.12				Box	GC099317	Outer Joint	48T	30	36	70	117.5	68.5	I		
	2005.10-	2009.12				Platform/Chassis	GC099317	Outer Joint	48T	30	36	70	117.5	68.5	I		
2.5 D (99 kW)	2006.02-	2009.12		L	F	Box	GDS18231	Drive Shaft	48T	30	30	70	117.5	723			
	2006.02-	2009.12		L	F	Box	GDS18402	Drive Shaft		30	30	70	117.5	723			
	2006.02-	2009.12		L	F	Box	GCI34112	Inner Joint		30	26	35	86	81			
	2006.02-	2009.12		L	F	Platform/Chassis	GDS18231	Drive Shaft	48T	30	30	70	117.5	723			
	2006.02-	2009.12		L	F	Platform/Chassis	GDS18402	Drive Shaft		30	30	70	117.5	723			
	2006.02-	2009.12		L	F	Platform/Chassis	GCI34112	Inner Joint		30	26	35	86	81			
	2006.02-	2009.12		L/R	F	Box	GC035025	Outer Joint		30	36	70	117.5	68.5	I		
	2006.02-	2009.12		L/R	F	Platform/Chassis	GC035025	Outer Joint		30	36	70	117.5	68.5	I		
	2006.02-	2009.12		R	F	Box	GDS18232	Drive Shaft	48T	30	30	70	117.5	1095			
	2006.02-	2009.12		R	F	Box	GDS75056	Drive Shaft		30	30	70	117.5	1095			
	2006.02-	2009.12		R	F	Box	GCI18174	Inner Joint		30	26	35	434	105			
	2006.02-	2009.12		R	F	Platform/Chassis	GDS18232	Drive Shaft	48T	30	30	70	117.5	1095			
	2006.02-	2009.12		R	F	Platform/Chassis	GDS75056	Drive Shaft		30	30	70	117.5	1095			
	2006.02-	2009.12		R	F	Platform/Chassis	GCI18174	Inner Joint		30	26	35	434	105			
	2006.02-	2009.12				Box	GC099317	Outer Joint	48T	30	36	70	117.5	68.5	I		
	2006.02-	2009.12				Platform/Chassis	GC099317	Outer Joint	48T	30	36	70	117.5	68.5	I		
	2006.02-	2009.12		L	F	Bus	GDS18231	Drive Shaft	48T	30	30	70	117.5	723			
	2006.02-	2009.12		L	F	Bus	GDS18402	Drive Shaft		30	30	70	117.5	723			
	2006.02-	2009.12		L	F	Bus	GCI34112	Inner Joint		30	26	35	86	81			
	2006.02-	2009.12		L/R	F	Bus	GC035025	Outer Joint		30	36	70	117.5	68.5	I		
	2006.02-	2009.12		R	F	Bus	GDS18232	Drive Shaft	48T	30	30	70	117.5	1095			
	2006.02-	2009.12		R	F	Bus	GDS75056	Drive Shaft		30	30	70	117.5	1095			
	2006.02-	2009.12		R	F	Bus	GCI18174	Inner Joint		30	26	35	434	105			
	2006.02-	2009.12				Bus	GC099317	Outer Joint	48T	30	36	70	117.5	68.5	I		
<b>LEXUS</b>																	
<b>CT (2WA1 )</b>																	
200 H (73 kW)	2010.12-						GC059244	Outer Joint		26	25	55.6	95.5	57	I		
<b>ES (F1, F2)</b>																	
250 (118 kW)	1989.12-	1991.09	MT/AT		R	Saloon Engine 2VZ-FE	GC031001	Outer Joint		26	27	56	99.5	63	I		
300 (138 kW)	1991.09-	1997.12	MT		R	Saloon Engine 3VZ-FE	GC059161	Outer Joint	48T	30	34	56	95.5	70	I		
<b>ES300</b>																	
-	1992-	1996					GC059162	Outer Joint	48T	30	34	56	95.5	70	I		
<b>IS I (JCE1_, GXE1_)</b>																	
200 (114 kW)	1999.04-	2005.07		L/R	R	Saloon Engine 1G-FE	GC059390	Outer Joint	48T	30	27	63	108.5	64	I		
300 (157 kW)	2001.09-	2005.07		L/R	R	Saloon Engine 2JZ-GE	GC059390	Outer Joint	48T	30	27	63	108.5	64	I		
<b>IS SPORTCROSS</b>																	
200 (114 kW)	2002.10	2005.10		L/R	R	Estate Engine 1G-FE	GC059390	Outer Joint	48T	30	27	63	108.5	64	I		
300 (157 kW)	2001.10-	2005.10		L/R	R	Estate Engine 2JZ-GE	GC059390	Outer Joint	48T	30	27	63	108.5	64	I		
<b>LX (UZJ100)</b>																	
470 (173 kW)	2001.09-	2008.03		L/R	F	Closed Off-Road Vehicle Engine 2UZ-FE	GC059085	Outer Joint		30	30	72.58	176	78	I		
<b>RX (GYL1_, GGL15, AGL10)</b>																	
350 AWD (204 kW)	2008.12-			L	F	Closed Off-Road Vehicle Engine 2GR-FE	GCI59082	Inner Joint		24	27	50	67	109			
	2008.12-				F	Closed Off-Road Vehicle Engine 2GR-FE	GC059233	Outer Joint	48T	30	36	63	99	67	I		
<b>RX (MCU15)</b>																	
300 AWD (148 kW)	2000.10-	2003.05	4AT			Closed Off-Road Vehicle Engine 1MZ-FE	GC059261	Outer Joint	48T	26	25	56	95	61	I		
<b>RX (MHU3_, GSU3_, MCU3_)</b>																	
350 AWD (203 kW)	2006.04-	2006.09			F	Closed Off-Road Vehicle Engine 2GR-FE	GC059233	Outer Joint	48T	30	36	63	99	67	I		
400h (155 kW)	2005.05-	2006.09			F	Closed Off-Road Vehicle Engine 3MZ-FE	GC059233	Outer Joint	48T	30	36	63	99	67	I		
400h AWD (155 kW)	2007.04-	2008.12			F	Closed Off-Road Vehicle Engine 3MZ-FE	GC059233	Outer Joint	48T	30	36	63	99	67	I		
<b>LINCOLN</b>																	
<b>CONTINENTAL</b>																	
3.8	1988-	1994	AT				GC018085	Outer Joint	50T	26	32	55.9	105.5	64.5	I		
<b>MARUTI</b>																	
<b>1000</b>																	
1.0	1991.01-						GC057053	Outer Joint		23	18	44	92	48.5	I		

		TRANSM	L/R	F/R		G-AP Ref.	PRODUCT	ABS	Technical Specifications									
									YEAR	A	B	C	H	L	P			
<b>MARUTI</b>																		
<b>800</b>																		
0.8				L		GDS57001	Drive Shaft		23	22	44	89.5	534.5					
				R		GDS57002	Drive Shaft		23	22	44	89.5	689.5					
	1991.01-					GC057053	Outer Joint		23	18	44	92	48.5	I				
<b>SX4</b>																		
-				L		GDS57075	Drive Shaft		28	26	58	85	613					
				R		GDS57074	Drive Shaft		28	26	58	85	699.5					
<b>MAZDA</b>																		
<b>121 (DA)</b>																		
1.1 (42 kW)	1987.10-	1990.10	MT		F Hatchback Engine B1/B116	GC018027	Outer Joint		24	22	52	86.5	55	M				
<b>121 I (DA)</b>																		
1.3 (DAJ)	1986.01-		MT		Engine BJ DOHC	GC018033	Outer Joint		24	20	52	86	50.5	M				
<b>121 II (DB)</b>																		
1.3 16V (39 kW)	1990.11-	1996.03	MT		F Saloon Engine B3	GC018030	Outer Joint		24	19	52	86	50.5	M				
	1990.11-	1996.03	MT		F Saloon Engine B3	GC034062	Outer Joint	44T	24	19	52	86	54.5	I				
	1990.11-	1996.03	MT		F Saloon Engine B3	GC027003	Outer Joint		24	21	52	86	54.5	I				
1.3 i 16V (53 kW)	1990.11-	1996.03	MT		F Saloon Engine B3	GC018030	Outer Joint		24	19	52	86	50.5	M				
	1990.11-	1996.03	MT		F Saloon Engine B3	GC034062	Outer Joint	44T	24	19	52	86	54.5	I				
	1990.11-	1996.03	MT		F Saloon Engine B3	GC027003	Outer Joint		24	21	52	86	54.5	I				
<b>121 III (JASM, JBSM)</b>																		
1.25 (55 kW)	1996.03-	2003.04	MT		F Hatchback Engine DHF/DHG	GC018004	Outer Joint		25	22	56.5	88.5	53.5	O				
1.3 (37 kW)	1996.03-	2003.04	MT		F Hatchback Engine JJK/JJM	GC018012	Outer Joint		25	20	56.5	88.5	49	O				
1.3 (44 kW)	1996.03-	2003.04	MT		F Hatchback Engine J4R/J4T	GC018012	Outer Joint		25	20	56.5	88.5	49	O				
1.8 D (44 kW)	1996.03-	2003.04	MT		F Hatchback Engine RTJ/RTK	GC018004	Outer Joint		25	22	56.5	88.5	53.5	O				
<b>2 (DE)</b>																		
1.3 (55 kW)	2007.10-		MT	R	F Hatchback Engine ZJ-VE	GDS18324	Drive Shaft		25	28	53.8	89	576					
	2007.10-		MT		Hatchback Engine ZJ-VE	GC018223	Outer Joint		25	29	53.8	89	51.5	I				
1.3 (63 kW)	2007.10-			R	F Hatchback Engine ZJ-VE	GDS18324	Drive Shaft		25	28	53.8	89	576					
1.3 MZR (62 kW)	2010.01-		MT	R	F Hatchback Engine ZJ-VE	GDS18324	Drive Shaft		25	28	53.8	89	576					
1.5 (76 kW)	2007.10-			R	F Hatchback Engine ZY-DE/ZY-VE	GDS18324	Drive Shaft		25	28	53.8	89	576					
	2007.10-		MT		Hatchback Engine ZY-DE/ZY-VE	GC018223	Outer Joint		25	29	53.8	89	51.5	I				
1.5 MZR (75 kW)	2011.06-			R	F Hatchback	GDS18324	Drive Shaft		25	28	53.8	89	576					
<b>2 (DY)</b>																		
1.2 (55 kW)	2003.02-		MT	L	F Hatchback Engine FUJA	GDS18202	Drive Shaft		25	23	53	88	620					
1.25 (55 kW)	2003.04-		MT	L	F Hatchback Engine FUJA	GDS18202	Drive Shaft		25	23	53	88	620					
	2003.04-		MT	R	F Hatchback Engine FUJA	GDS18201	Drive Shaft		25	23	53.3	90	919					
1.4 (59 kW)	2003.02-			L	F Hatchback Engine FXJA	GDS18202	Drive Shaft		25	23	53	88	620					
	2003.02-			R	F Hatchback Engine FXJA	GDS18201	Drive Shaft		25	23	53.3	90	919					
	2003.04-			L	F Hatchback Engine FXJA	GDS18202	Drive Shaft		25	23	53	88	620					
	2003.04-			R	F Hatchback Engine FXJA	GDS18201	Drive Shaft		25	23	53.3	90	919					
1.4 CD (50 kW)	2003.04-		MT	L	F Hatchback Engine F6JA/F6JB	GDS18202	Drive Shaft		25	23	53	88	620					
1.6 (74 kW)	2003.02-		MT	L	F Hatchback Engine FYJA	GDS18202	Drive Shaft		25	23	53	88	620					
	2003.04-		MT	L	F Hatchback Engine FYJA	GDS18202	Drive Shaft		25	23	53	88	620					
<b>2 I (DY)</b>																		
1.4 TD (50 kW)	2003.04-	2007				GC018001	Outer Joint		25	20	52.9	89	52	M				
<b>3</b>																		
2.0	2004-	2005	AT	R	F	GDS34101	Drive Shaft		36	28	55.2	48.5	501					
2.3	2004-	2005	AT	R	F	GDS34101	Drive Shaft		36	28	55.2	48.5	501					
<b>3 (BK)</b>																		
1.4 (62 kW)	2004.01-	2008.04			F Hatchback Engine ZJ-VE	GC034015	Outer Joint		36	22	55.2	48.5	55.5	I				
1.5	2006.03-	2007.03		R	F	GDS34101	Drive Shaft		36	28	55.2	48.5	501					
1.6	2006.03-	2007.03		R	F	GDS34101	Drive Shaft		36	28	55.2	48.5	501					
1.6 (77 kW)	2004.01-	2008.04	MT		F Hatchback Engine B6ZE	GC034015	Outer Joint		36	22	55.2	48.5	55.5	I				
	2004.01-	2008.04	MT		F Saloon Engine Z6	GC034015	Outer Joint		36	22	55.2	48.5	55.5	I				
	2004.01-	2008.04			Hatchback Engine B6ZE	GC034105	Outer Joint		28	23	56	90	59	I				
	2004.01-	2008.04			Saloon Engine Z6	GC034105	Outer Joint		28	23	56	90	59	I				
	2004.01-	2008.04			Saloon Engine Z6	GC099272	Outer Joint		28	22	58.6	90	59	I				
1.6 Di Turbo (80 kW)	2004.01-	2008.04	MT		Hatchback Engine Y601	GC034091	Outer Joint		28	24	59	90	64	I				
	2004.01-	2008.04			Hatchback Engine Y601	GC034093	Outer Joint		36	24	55.3	48	60	I				
	2004.01-	2008.04			Saloon Engine Y601	GC034091	Outer Joint		28	24	59	90	64	I				
	2004.01-	2008.04			Saloon Engine Y601	GC034093	Outer Joint		36	24	55.3	48	60	I				









		TRANSM	L/R	F/R		G-AP Ref.	PRODUCT	ABS	Technical Specifications									
									YEAR	A	B	C	H	L	P			
<b>MAZDA</b>																		
<b>3 (BK)</b>																		
2.0 (110 kW)	2004.01-	2008.03			F	Hatchback Engine LF17	GC034015	Outer Joint		36	22	55.2	48.5	55.5	I			
	2004.01-	2008.03			F	Saloon Engine LF17	GC034015	Outer Joint		36	22	55.2	48.5	55.5	I			
	2004.01-	2008.03	MT			Hatchback Engine LF17	GC034091	Outer Joint		28	24	59	90	64	I			
	2004.01-	2008.03				Saloon Engine LF17	GC034091	Outer Joint		28	24	59	90	64	I			
<b>3 (BK3P)</b>																		
2.3	2003.09-		4AT/F			Engine L3-VE	GC034048	Outer Joint		36	24	55.3	48.3	55.5	M			
	2003.12-		5MT/F			Engine L3-VE	GC034048	Outer Joint		36	24	55.3	48.3	55.5	M			
<b>3 (BK5P)</b>																		
1.5	2005.01-		4AT/F			Engine ZY-VE	GC034131	Outer Joint		28	22	58.6	90	59	I			
<b>3 (BL)</b>																		
1.6 MZR (77 kW)	2009.06-					Hatchback Engine Z6	GC099272	Outer Joint		28	22	58.6	90	59	I			
1.6 MZR CD (80 kW)	2009.06-		MT	R	F	Hatchback Engine Y601	GDS34195	Drive Shaft		28	28	58.5	92	586				
	2009.06-		MT	R	F	Saloon	GDS34195	Drive Shaft		28	28	58.5	92	586				
	2009.06-					Saloon	GC034200	Outer Joint		28	24	58.5	92	63	I			
1.6 MZR CD (85 kW)	2010.11-		MT	R	F	Hatchback	GDS34195	Drive Shaft		28	28	58.5	92	586				
	2010.11-		MT	R	F	Saloon	GDS34195	Drive Shaft		28	28	58.5	92	586				
	2010.11-					Hatchback	GC034200	Outer Joint		28	24	58.5	92	63	I			
	2010.11-					Saloon	GC034200	Outer Joint		28	24	58.5	92	63	I			
<b>3 BK</b>																		
-	2003-	2008					GCI34049	Inner Joint		28	24	35	67	115				
<b>323</b>																		
-							GCI34001	Inner Joint		24	22	35	64	87				
							GC099044	Outer Joint		24	30	52	86.5	55	O			
	1982-	1985					GC034027	Outer Joint		24	22	52	86	55.5	M			
	1987.01-	1989.07	MT/AT	L	F		GDS34076	Drive Shaft		24	26	52	86	595				
	1987.01-	1989.07	MT/AT	R	F		GDS34077	Drive Shaft		24	26	52	86	541				
	1988-	1989					GCI18004	Inner Joint		24	21	35	64	87				
	1998-	2002					GCI34022	Inner Joint		28	29	43	45	70				
	2002-						GCI34027	Inner Joint		24	29	35	64	96				
1.6	1982-	1986					GCI18004	Inner Joint		24	21	35	64	87				
	1986-	1993					GCI18006	Inner Joint		24	22	35	64	98.5				
1.6 SOHC BG	1989.01-	1996.05					GCI18009	Inner Joint		24	23	35	64	98.5				
	1989.01-	1996.05	MT/AT	L			GDS18056	Drive Shaft		26	24	56	93	625				
	1989.01-	1996.05	MT/AT	R			GDS18057	Drive Shaft		26	24	56	93	905				
1.8	1982-	1986					GCI18004	Inner Joint		24	21	35	64	87				
<b>323 ASTINA</b>																		
1.8	1994-	1998					GC034028	Outer Joint		28	30	56	89	59.5	I			
2.0 V6	1994.01-	1998.05		L			GDS34078	Drive Shaft	44T	26	28	56	92	634				
	1994.01-	1998.05		R			GDS34079	Drive Shaft	44T	26	28	56	92	565				
<b>323 C IV (BG)</b>																		
1.3 (49 kW)	1989.09-	1994.07				Hatchback Engine B3E	GC034051	Outer Joint		26	21	56	94	56	M			
	1989.09-	1994.07	MT/AT	R	F	Hatchback Engine B3E	GDS34044	Drive Shaft		26	24	56	94	903				
	1989.09-	1994.07	MT		F	Hatchback Engine B3E	GC034019	Outer Joint		26	21	56	94	56	I			
1.3 16V (54 kW)	1989.09-	1994.07	MT/AT	R	F	Hatchback Engine B3	GDS34044	Drive Shaft		26	24	56	94	903				
	1989.09-	1994.07	MT/AT		F	Hatchback Engine B3	GC034019	Outer Joint		26	21	56	94	56	I			
1.6 (62 kW)	1989.09-	1991.06			F	Hatchback Engine B6E	GC034022	Outer Joint	44T	26	22	56	94	59	I			
	1989.09-	1991.06	MT		F	Hatchback Engine B6E	GC018034	Outer Joint		26	22	56	94	59	I			
	1989.09-	1991.06	MT		F	Hatchback Engine B6E	GC034007	Outer Joint		26	22	56	93	56.5	I			
1.6 16V (65 kW)	1991.03-	1994.10			F	Hatchback Engine B6	GC034022	Outer Joint	44T	26	22	56	94	59	I			
	1991.03-	1994.10	MT		F	Hatchback Engine B6	GC018034	Outer Joint		26	22	56	94	59	I			
	1991.03-	1994.10	MT		F	Hatchback Engine B6	GC034007	Outer Joint		26	22	56	93	56.5	I			
1.7 D (41 kW)	1989.08-	1994.07	MT		F	Hatchback Engine PN54	GC034019	Outer Joint		26	21	56	94	56	I			
	1989.08-	1994.07	MT/AT	R	F	Hatchback Engine PN54	GDS34044	Drive Shaft		26	24	56	94	903				
1.8 16V 4WD (76 kW)	1991.11-	1993.12				Hatchback Engine BP	GC027027	Outer Joint	44T	26	23	56	93	55	M			
1.8 16V GT (94 kW)	1989.09-	1993.03	MT		F	Hatchback Engine BP(DOHC)	GC034081	Outer Joint		26	30	56	93	56.5	M			
	1989.09-	1993.03	MT		F	Hatchback Engine BP(DOHC)	GC018034	Outer Joint		26	22	56	94	59	I			
	1989.09-	1993.03	MT		F	Hatchback Engine BP(DOHC)	GC034007	Outer Joint		26	22	56	93	56.5	I			
1.8 16V Turbo 4WD (120 kW)	1990.09-	1992.12				Hatchback Engine BP	GC027027	Outer Joint	44T	26	23	56	93	55	M			
1.8 16V Turbo 4WD (136 kW)	1993.01-	1994.07				Hatchback Engine BP	GC027027	Outer Joint	44T	26	23	56	93	55	M			
1.8 DOHC (USA)	1990.01-	1992.12	MT				GC034025	Outer Joint		26	30	56	92.5	57.5	I			



		TRANSM	L/R	F/R		G-AP Ref.	PRODUCT	ABS	Technical Specifications										
									YEAR	A	B	C	H	L	P				
<b>MAZDA</b>																			
<b>323 C V (BA)</b>																			
1.3 16V (54 kW)	1994.08-	1998.09			F	Hatchback Engine B3	GC034055	Outer Joint		26	22	56	94	59	M				
	1994.08-	1998.09			F	Hatchback Engine B3	GC034022	Outer Joint	44T	26	22	56	94	59	I				
	1994.08-	1998.09	MT/AT		F	Hatchback Engine B3	GC034005	Outer Joint		26	22	56	94	59	M				
	1994.08-	1998.09	MT/AT		F	Hatchback Engine B3	GC034006	Outer Joint	44T	26	22	56	94	59	M				
1.5 16V (65 kW)	1994.08-	1998.09				Hatchback Engine Z5-DE	GC034051	Outer Joint		26	21	56	94	56	M				
	1994.08-	1998.09			F	Hatchback Engine Z5-DE	GC034055	Outer Joint		26	22	56	94	59	M				
	1994.08-	1998.09			F	Hatchback Engine Z5-DE	GC034022	Outer Joint	44T	26	22	56	94	59	I				
	1994.08-	1998.09	MT/AT		F	Hatchback Engine Z5-DE	GC034005	Outer Joint		26	22	56	94	59	M				
	1994.08-	1998.09	MT/AT		F	Hatchback Engine Z5-DE	GC034006	Outer Joint	44T	26	22	56	94	59	M				
1.8 16V (84 kW)	1994.08-	1998.09	MT		F	Hatchback Engine BP-ZE	GC034081	Outer Joint		26	30	56	93	56.5	M				
	1994.08-	1998.09	MT		F	Hatchback Engine BP-ZE	GC034023	Outer Joint		26	30	56	93	55	I				
	1994.08-	1998.09	MT		F	Hatchback Engine BP-ZE	GC034058	Outer Joint	44T	26	30	56	93	55	I				
<b>323 F IV (BG)</b>																			
1.6 (62 kW)	1989.09-	1991.06			F	Hatchback Engine B6E	GC034022	Outer Joint	44T	26	22	56	94	59	I				
	1989.09-	1991.06	MT		F	Hatchback Engine B6E	GC018034	Outer Joint		26	22	56	94	59	I				
	1989.09-	1991.06	MT		F	Hatchback Engine B6E	GC034007	Outer Joint		26	22	56	93	56.5	I				
1.6 16V (65 kW)	1991.03-	1994.10			F	Hatchback Engine B6	GC034022	Outer Joint	44T	26	22	56	94	59	I				
	1991.03-	1994.10	MT		F	Hatchback Engine B6	GC018034	Outer Joint		26	22	56	94	59	I				
	1991.03-	1994.10	MT		F	Hatchback Engine B6	GC034007	Outer Joint		26	22	56	93	56.5	I				
1.8 16V GT (94 kW)	1989.08-	1994.07	MT		F	Hatchback Engine BP(DOHC)	GC034081	Outer Joint		26	30	56	93	56.5	M				
	1989.08-	1994.07	MT		F	Hatchback Engine BP(DOHC)	GC018034	Outer Joint		26	22	56	94	59	I				
	1989.08-	1994.07	MT		F	Hatchback Engine BP(DOHC)	GC034007	Outer Joint		26	22	56	93	56.5	I				
<b>323 F V (BA)</b>																			
1.5 16V (65 kW)	1994.07-	1998.09				Coupe Engine Z5-DE	GC034051	Outer Joint		26	21	56	94	56	M				
	1994.07-	1998.09			F	Coupe Engine Z5-DE	GC034055	Outer Joint		26	22	56	94	59	M				
	1994.07-	1998.09			F	Coupe Engine Z5-DE	GC034022	Outer Joint	44T	26	22	56	94	59	I				
	1994.07-	1998.09	MT/AT		F	Coupe Engine Z5-DE	GC034005	Outer Joint		26	22	56	94	59	M				
	1994.07-	1998.09	MT/AT		F	Coupe Engine Z5-DE	GC034006	Outer Joint	44T	26	22	56	94	59	M				
1.8 16V (84 kW)	1994.08-	1998.09	MT		F	Coupe Engine BP-ZE	GC034081	Outer Joint		26	30	56	93	56.5	M				
	1994.08-	1998.09			F	Coupe Engine BP-ZE	GC034023	Outer Joint		26	30	56	93	55	I				
	1994.08-	1998.09			F	Coupe Engine BP-ZE	GC034058	Outer Joint	44T	26	30	56	93	55	I				
	1994.08-	1998.09	MT		F	Coupe Engine BP-ZE	GC018034	Outer Joint		26	22	56	94	59	I				
<b>323 F/P VI (BJ)</b>																			
1.4 (53 kW)	2001.01-	2004.05	MT/AT		F	Hatchback Engine B3(16V)	GC034026	Outer Joint		26	28	56	93.5	53	I				
1.6 (70 kW)	2001.01-	2004.05	MT/AT		F	Hatchback Engine ZM	GC034026	Outer Joint		26	28	56	93.5	53	I				
1.6 (72 kW)	2001.01-	2004.05	MT/AT		F	Hatchback Engine ZM	GC034026	Outer Joint		26	28	56	93.5	53	I				
2.0 (96 kW)	2001.01-	2004.05	MT/AT		F	Hatchback Engine FS7E/FS7G	GC034008	Outer Joint		26	29	56	93.5	59	I				
2.0 D (52 kW)	1998.09-	2004.05	MT/AT		F	Hatchback Engine RF1G	GC034008	Outer Joint		26	29	56	93.5	59	I				
2.0 TD (74 kW)	2001.01-	2004.05	MT/AT		F	Hatchback Engine RF4F	GC034008	Outer Joint		26	29	56	93.5	59	I				
<b>323 II (BD)</b>																			
1.1 (40 kW)	1980.11-	1985.10	MT		F	Hatchback Engine E1	GC018027	Outer Joint		24	22	52	86.5	55	M				
	1980.11-	1985.10	MT		F	Saloon Engine E1	GC018027	Outer Joint		24	22	52	86.5	55	M				
1.3 (44 kW)	1980.11-	1985.10	MT		F	Hatchback Engine E3	GC018027	Outer Joint		24	22	52	86.5	55	M				
	1981.09-	1985.10	MT		F	Saloon Engine E3	GC018027	Outer Joint		24	22	52	86.5	55	M				
1.5 (55 kW)	1981.05-	1985.07	MT		F	Hatchback Engine E5	GC018027	Outer Joint		24	22	52	86.5	55	M				
	1981.05-	1985.12	MT		F	Saloon Engine E5	GC018027	Outer Joint		24	22	52	86.5	55	M				
1.5 (63 kW)	1980.11-	1983.12	MT		F	Hatchback Engine E5	GC018027	Outer Joint		24	22	52	86.5	55	M				
1.5 (65 kW)	1982.03-	1985.12	MT		F	Hatchback Engine E5	GC018027	Outer Joint		24	22	52	86.5	55	M				
	1982.03-	1986.09	MT		F	Saloon Engine E5	GC018027	Outer Joint		24	22	52	86.5	55	M				
<b>323 III (BF)</b>																			
1.1 (40 kW)	1985.09-	1989.10	MT		F	Hatchback Engine E1	GC018027	Outer Joint		24	22	52	86.5	55	M				
1.3 (44 kW)	1985.08-	1989.05	MT		F	Saloon Engine E3	GC034003	Outer Joint		24	21	52	86.5	53	M				
	1985.08-	1989.05	AT		F	Saloon Engine E3	GC018027	Outer Joint		24	22	52	86.5	55	M				
	1985.09-	1987.12	MT		F	Hatchback Engine E3	GC034003	Outer Joint		24	21	52	86.5	53	M				
	1985.09-	1987.12	AT		F	Hatchback Engine E3	GC018027	Outer Joint		24	22	52	86.5	55	M				
	1987.04-	1989.07	MT		F	Saloon Engine B3	GC034003	Outer Joint		24	21	52	86.5	53	M				
1.4 (44 kW)	1987.04-	1989.07	AT		F	Saloon Engine B3	GC018027	Outer Joint		24	22	52	86.5	55	M				
	1987.09-	1989.10	MT		F	Hatchback Engine B3	GC034003	Outer Joint		24	21	52	86.5	53	M				
	1987.09-	1989.10	AT		F	Hatchback Engine B3	GC018027	Outer Joint		24	22	52	86.5	55	M				
	1987.09-	1989.10	MT/AT		F	Saloon Engine B5	GC018027	Outer Joint		24	22	52	86.5	55	M				
1.5 (54 kW)	1987.09-	1989.10	MT/AT		F	Hatchback Engine B5	GC018027	Outer Joint		24	22	52	86.5	55	M				

		TRANSM	L/R	F/R		G-AP Ref.	PRODUCT	ABS	Technical Specifications											
									YEAR	A	B	C	H	L	P					
<b>MAZDA</b>																				
<b>323 III (BF)</b>																				
1.5 (55 kW)	1985.08-	1989.05	MT/AT		F	Hatchback Engine E5	GC018027	Outer Joint		24	22	52	86.5	55	M					
	1985.08-	1989.05	MT/AT		F	Saloon Engine E5	GC018027	Outer Joint		24	22	52	86.5	55	M					
1.5 i Turbo (85 kW)	1985.08-	1989.05	MT		F	Hatchback Engine E5E2	GC018032	Outer Joint		24	23	52	86	57.5	M					
	1985.08-	1989.05	MT		F	Saloon Engine E5E2	GC018032	Outer Joint		24	23	52	86	57.5	M					
1.6 (54 kW)	1987.09-	1989.10	MT/AT		F	Hatchback Engine B68	GC018027	Outer Joint		24	22	52	86.5	55	M					
1.6 GT (63 kW)	1986.11-	1989.10	AT		F	Saloon Engine B6	GC018027	Outer Joint		24	22	52	86.5	55	M					
	1987.09-	1989.10	AT		F	Hatchback Engine B6	GC018027	Outer Joint		24	22	52	86.5	55	M					
1.6 GT (77 kW)	1985.08-	1993.08	AT		F	Hatchback Engine B6(SOHC)	GC018027	Outer Joint		24	22	52	86.5	55	M					
	1986.01-	1988.12	AT		F	Saloon Engine B6(SOHC)	GC018027	Outer Joint		24	22	52	86.5	55	M					
1.6 GT Turbo (103 kW)	1985.10-	1993.08	MT		F	Hatchback Engine B6T	GC018032	Outer Joint		24	23	52	86	57.5	M					
	1985.10-	1991.11	MT		F	Saloon Engine B6T	GC018032	Outer Joint		24	23	52	86	57.5	M					
1.7 D (40 kW)	1986.04-	1989.05	MT/AT		F	Hatchback Engine PN27	GC018027	Outer Joint		24	22	52	86.5	55	M					
	1986.09-	1989.05	MT/AT		F	Saloon Engine PN27	GC018027	Outer Joint		24	22	52	86.5	55	M					
1.7 D (42 kW)	1987.01-	1989.05	MT/AT		F	Hatchback Engine PN46	GC018027	Outer Joint		24	22	52	86.5	55	M					
	1987.01-	1989.05	MT/AT		F	Saloon Engine PN46	GC018027	Outer Joint		24	22	52	86.5	55	M					
<b>323 III (BW)</b>																				
1.3 (44 kW)	1986.07-	1990.04	MT		F	Estate Engine E3	GC018074	Outer Joint		24	21	52	86.5	53	I					
1.5 (54 kW)	1987.01-	1989.05	MT/AT		F	Estate Engine B5/B50/B53	GC018027	Outer Joint		24	22	52	86.5	55	M					
1.5 (55 kW)	1986.05-	1989.05	MT/AT		F	Estate Engine B50/B53/E5	GC018027	Outer Joint		24	22	52	86.5	55	M					
1.6 (54 kW)	1987.09-	1989.10	MT/AT		F	Estate Engine B68	GC018027	Outer Joint		24	22	52	86.5	55	M					
1.6 (63 kW)	1986.09-	1995.10	MT/AT		F	Estate Engine B6(SOHC)/B6E/B65M	GC018034	Outer Joint		26	22	56	94	59	I					
	1986.09-	1995.10	MT/AT		F	Estate Engine B6(SOHC)/B6E/B65M	GC034007	Outer Joint		26	22	56	93	56.5	I					
	1986.09-	1995.10	MT/AT		F	Estate Engine B6(SOHC)/B6E/B65M	GC018027	Outer Joint		24	22	52	86.5	55	M					
1.6 4x4 (63 kW)	1990.05-	1993.03	MT/AT		F	Estate Engine B65M/B6E	GC018034	Outer Joint		26	22	56	94	59	I					
	1990.05-	1993.03	MT/AT		F	Estate Engine B65M/B6E	GC034007	Outer Joint		26	22	56	93	56.5	I					
1.7 D (40 kW)	1986.11-	1987.08	MT/AT		F	Estate Engine PN26	GC018027	Outer Joint		24	22	52	86.5	55	M					
1.7 D (41 kW)	1989.10-	1993.03	MT/AT		F	Estate Engine PN26/PN54	GC018027	Outer Joint		24	22	52	86.5	55	M					
1.7 D (42 kW)	1986.11-	1989.10	MT/AT		F	Estate Engine PN26/PN54	GC018027	Outer Joint		24	22	52	86.5	55	M					
<b>323 P V (BA)</b>																				
1.3 16V (54 kW)	1996.10-				F	Hatchback Engine B3	GC034055	Outer Joint		26	22	56	94	59	M					
	1996.10-				F	Hatchback Engine B3	GC034022	Outer Joint	44T	26	22	56	94	59	I					
	1996.10-		MT/AT		F	Hatchback Engine B3	GC034005	Outer Joint		26	22	56	94	59	M					
	1996.10-		MT/AT		F	Hatchback Engine B3	GC034006	Outer Joint	44T	26	22	56	94	59	M					
1.5 16V (65 kW)	1996.10-				F	Hatchback Engine Z5-DE	GC034055	Outer Joint		26	22	56	94	59	M					
	1996.10-				F	Hatchback Engine Z5-DE	GC034022	Outer Joint	44T	26	22	56	94	59	I					
	1996.10-		MT/AT		F	Hatchback Engine Z5-DE	GC034005	Outer Joint		26	22	56	94	59	M					
	1996.10-		MT/AT		F	Hatchback Engine Z5-DE	GC034006	Outer Joint	44T	26	22	56	94	59	M					
2.0 D (52 kW)	1996.10-		5MT		F	Hatchback Engine RF1G	GC034051	Outer Joint		26	21	56	94	56	M					
	1996.10-				F	Hatchback Engine RF1G	GC034055	Outer Joint		26	22	56	94	59	M					
<b>323 S IV (BG)</b>																				
1.3 (49 kW)	1989.09-	1991.06	MT		F	Saloon Engine B383/B3E	GC034019	Outer Joint		26	21	56	94	56	I					
	1989.09-	1991.06	MT/AT	R	F	Saloon Engine B383/B3E	GDS34044	Drive Shaft		26	24	56	94	903						
	1989.09-	1991.06				Saloon Engine B383/B3E	GC034051	Outer Joint		26	21	56	94	56	M					
1.3 16V (54 kW)	1991.04-	1994.07	MT/AT		F	Saloon Engine B3	GC034019	Outer Joint		26	21	56	94	56	I					
	1991.04-	1994.07	MT/AT	R	F	Saloon Engine B3	GDS34044	Drive Shaft		26	24	56	94	903						
1.6 (62 kW)	1989.09-	1991.06			F	Saloon Engine B6E	GC034022	Outer Joint	44T	26	22	56	94	59	I					
	1989.09-	1991.06	MT		F	Saloon Engine B6E	GC018034	Outer Joint		26	22	56	94	59	I					
	1989.09-	1991.06	MT		F	Saloon Engine B6E	GC034007	Outer Joint		26	22	56	93	56.5	I					
1.6 16V (65 kW)	1989.08-	1994.10			F	Saloon Engine B6	GC034022	Outer Joint	44T	26	22	56	94	59	I					
	1989.08-	1994.10	MT		F	Saloon Engine B6	GC018034	Outer Joint		26	22	56	94	59	I					
	1989.08-	1994.10	MT		F	Saloon Engine B6	GC034007	Outer Joint		26	22	56	93	56.5	I					
1.7 D (41 kW)	1989.08-	1994.07	MT		F	Saloon Engine PN46/PN54/PN62	GC034019	Outer Joint		26	21	56	94	56	I					
	1989.08-	1994.07	MT/AT	R	F	Saloon Engine PN46/PN54/PN62	GDS34044	Drive Shaft		26	24	56	94	903						
1.8 16V (76 kW)	1989.08-	1994.07			F	Saloon Engine BP52	GC027027	Outer Joint	44T	26	23	56	93	55	M					
1.8 16V GT (94 kW)	1989.06-	1994.07	MT		F	Saloon Engine BP(DOHC)	GC034081	Outer Joint		26	30	56	93	56.5	M					
	1989.06-	1994.07	MT		F	Saloon Engine BP(DOHC)	GC018034	Outer Joint		26	22	56	94	59	I					
	1989.06-	1994.07	MT		F	Saloon Engine BP(DOHC)	GC034007	Outer Joint		26	22	56	93	56.5	I					
1.8 16V Turbo 4WD (120 kW)	1991.01-	1994.07				Saloon Engine BP	GC027027	Outer Joint	44T	26	23	56	93	55	M					
<b>323 S V (BA)</b>																				
1.3 16V (54 kW)	1994.08-	1998.09			F	Saloon Engine B3	GC034055	Outer Joint		26	22	56	94	59	M					
	1994.08-	1998.09			F	Saloon Engine B3	GC034022	Outer Joint	44T	26	22	56	94	59	I					
	1994.08-	1998.09	MT/AT		F	Saloon Engine B3	GC034005	Outer Joint		26	22	56	94	59	M					









		TRANSM	L/R	F/R		G-AP Ref.	PRODUCT	ABS	Technical Specifications								
									YEAR	A	B	C	H	L	P		
<b>MAZDA</b>																	
<b>323 S V (BA)</b>																	
1.3 16V (54 kW)	1994.08-	1998.09	MT/AT		F	Saloon Engine B3	GC034006	Outer Joint	44T	26	22	56	94	59	M		
1.5 16V (65 kW)	1994.08-	1998.09			F	Saloon Engine Z5-DE	GC034055	Outer Joint		26	22	56	94	59	M		
	1994.08-	1998.09			F	Saloon Engine Z5-DE	GC034022	Outer Joint	44T	26	22	56	94	59	I		
	1994.08-	1998.09	MT/AT		F	Saloon Engine Z5-DE	GC034005	Outer Joint		26	22	56	94	59	M		
	1994.08-	1998.09	MT/AT		F	Saloon Engine Z5-DE	GC034006	Outer Joint	44T	26	22	56	94	59	M		
	1994.08-	1998.09				Saloon Engine Z5-DE	GC034051	Outer Joint		26	21	56	94	56	M		
1.6 TD (60 kW)	1994.05-	1998.09			F	Saloon Engine 4EE1-T	GC034023	Outer Joint		26	30	56	93	55	I		
	1994.05-	1998.09			F	Saloon Engine 4EE1-T	GC034058	Outer Joint	44T	26	30	56	93	55	I		
	1994.05-	1998.09	MT		F	Saloon Engine 4EE1-T	GC034005	Outer Joint		26	22	56	94	59	M		
	1994.05-	1998.09	MT		F	Saloon Engine 4EE1-T	GC034006	Outer Joint	44T	26	22	56	94	59	M		
1.8 16V (84 kW)	1994.08-	1998.09	MT		F	Saloon Engine BP-ZE	GC034081	Outer Joint		26	30	56	93	56.5	M		
	1994.08-	1998.09			F	Saloon Engine BP-ZE	GC034023	Outer Joint		26	30	56	93	55	I		
	1994.08-	1998.09			F	Saloon Engine BP-ZE	GC034058	Outer Joint	44T	26	30	56	93	55	I		
2.0 D (52 kW)	1996.10-	1998.09	5MT		F	Saloon Engine RF1G	GC034055	Outer Joint		26	22	56	94	59	M		
<b>323 S VI (BJ)</b>																	
1.4 (53 kW)	2001.01-	2004.05	MT/AT		F	Saloon Engine B3(16V)	GC034026	Outer Joint		26	28	56	93.5	53	I		
1.6 (70 kW)	2001.01-	2004.05	MT/AT		F	Saloon Engine ZM	GC034026	Outer Joint		26	28	56	93.5	53	I		
1.6 (72 kW)	2001.01-	2004.05	MT/AT		F	Saloon Engine ZM	GC034026	Outer Joint		26	28	56	93.5	53	I		
1.9 16V (84 kW)	1998.09-	2004.05	MT/AT		F	Saloon Engine FP	GC034008	Outer Joint		26	29	56	93.5	59	I		
2.0 D (52 kW)	1998.09-	2004.05	MT/AT		F	Saloon Engine RF1G	GC034008	Outer Joint		26	29	56	93.5	59	I		
2.0 TD (66 kW)	1998.09-	2004.05	MT/AT		F	Saloon Engine RF3F	GC034008	Outer Joint		26	29	56	93.5	59	I		
<b>5 (CR19)</b>																	
1.8 (85 kW)	2005.06-	2008.02	MT	L	F	MPV Engine L823	GDS34091	Drive Shaft		28	28	59	90	639			
	2005.06-	2008.02				MPV Engine L823	GC034091	Outer Joint		28	24	59	90	64	I		
2.0 (107 kW)	2005.06-	2008.02	MT	L	F	MPV Engine LFF7	GDS34091	Drive Shaft		28	28	59	90	639			
	2005.06-	2008.02				MPV Engine LFF7	GC034091	Outer Joint		28	24	59	90	64	I		
2.0 CD (105 kW)	2005.06-	2008.02	MT	L	F	MPV Engine RF7J	GDS34226	Drive Shaft		28	30	58.5	88	587			
	2005.06-	2008.02	MT	R	F	MPV Engine RF7J	GDS34225	Drive Shaft		28	28	58.5	88	541			
	2005.06-	2008.02				MPV Engine RF7J	GC034091	Outer Joint		28	24	59	90	64	I		
2.0 CD (81 kW)	2005.06-	2008.02	MT	L	F	MPV	GDS34226	Drive Shaft		28	30	58.5	88	587			
	2005.06-	2008.02	MT	R	F	MPV	GDS34225	Drive Shaft		28	28	58.5	88	541			
	2005.06-	2008.02				MPV	GC034091	Outer Joint		28	24	59	90	64	I		
<b>5 CR</b>																	
-	2005-	2010					GCI34049	Inner Joint		28	24	35	67	115			
<b>6</b>																	
-	2004-	2006					GC034070	Outer Joint	44T	28	32	56	90	59	I		
	2004-	2006				CAPACITY	GCI34029	Inner Joint		28	33	35	66.5	114			
1.8/2.0	2002.02-						GC034046	Outer Joint		28	32	56	90	59	I		
2.3							GC034065	Outer Joint	44T	28	24	56.6	90	60	M		
<b>6 (GG)</b>																	
1.8 (88 kW)	2002.08-	2007.08			F	Hatchback Engine L813	GC034084	Outer Joint	44T	28	32	62	90	58	I		
	2002.08-	2007.08			F	Saloon Engine L813	GC034084	Outer Joint	44T	28	32	62	90	58	I		
	2002.08-	2007.08	MT		F	Hatchback Engine L813	GC034135	Outer Joint	44T	28	23	56	90	57.5	I		
	2002.08-	2007.08	MT		F	Saloon Engine L813	GC034135	Outer Joint	44T	28	23	56	90	57.5	I		
	2002.08-	2007.08	MT	L	F	Hatchback Engine L813	GDS34137	Drive Shaft	44T	28	28	56.6	90	648			
	2002.08-	2007.08	MT	L	F	Saloon Engine L813	GDS34137	Drive Shaft	44T	28	28	56.6	90	648			
	2002.08-	2007.08		L/R	F	Saloon Engine L813	GC034110	Outer Joint	44T	28	32	62	90	57.5	I		
	2002.08-	2007.08	MT	R	F	Hatchback Engine L813	GDS34088	Drive Shaft	44T	28	28	56.6	90	599			
	2002.08-	2007.08	MT	R	F	Saloon Engine L813	GDS34088	Drive Shaft	44T	28	28	56.6	90	599			
	2002.08-	2007.08				Hatchback Engine L813	GC034070	Outer Joint	44T	28	32	56	90	59	I		
	2002.08-	2007.08				Saloon Engine L813	GC034070	Outer Joint	44T	28	32	56	90	59	I		
2.0	2002.06-		MT/AT				GC034147	Outer Joint	44T	28	33	56.5	90	58.5	M		
2.0 (104 kW)	2002.06-	2007.08			F	Saloon Engine LF17/LF18	GC034084	Outer Joint	44T	28	32	62	90	58	I		
	2002.06-	2007.08	MT		F	Saloon Engine LF17/LF18	GC034135	Outer Joint	44T	28	23	56	90	57.5	I		
	2002.06-	2007.08	MT	L	F	Saloon Engine LF17/LF18	GDS34137	Drive Shaft	44T	28	28	56.6	90	648			
	2002.06-	2007.08		L/R	F	Saloon Engine LF17/LF18	GC034110	Outer Joint	44T	28	32	62	90	57.5	I		
	2002.06-	2007.08	MT	R	F	Saloon Engine LF17/LF18	GDS34088	Drive Shaft	44T	28	28	56.6	90	599			
	2002.06-	2007.08				Saloon Engine LF17/LF18	GC034070	Outer Joint	44T	28	32	56	90	59	I		
	2002.08-	2007.08			F	Hatchback Engine LF17/LF18	GC034084	Outer Joint	44T	28	32	62	90	58	I		
	2002.08-	2007.08	MT		F	Hatchback Engine LF17/LF18	GC034135	Outer Joint	44T	28	23	56	90	57.5	I		
	2002.08-	2007.08	MT	L	F	Hatchback Engine LF17/LF18	GDS34137	Drive Shaft	44T	28	28	56.6	90	648			
	2002.08-	2007.08		L/R	F	Hatchback Engine LF17/LF18	GC034110	Outer Joint	44T	28	32	62	90	57.5	I		



		YEAR	TRANSM	L/R	F/R		G-AP Ref.	PRODUCT	ABS	Technical Specifications											
										A	B	C	H	L	P						
<b>MAZDA</b>																					
<b>6 (GG)</b>																					
2.0 (104 kW)	2002.08-	2007.08	MT	R	F	Hatchback Engine LF17/LF18	GDS34088	Drive Shaft	44T	28	28	56.6	90	599							
	2002.08-	2007.08				Hatchback Engine LF17/LF18	GC034070	Outer Joint	44T	28	32	56	90	59	I						
2.0 (108 kW)	2005.06-	2008.02	MT		F	Hatchback Engine LFF7	GC034135	Outer Joint	44T	28	23	56	90	57.5	I						
	2005.06-	2008.02	MT		F	Saloon Engine LFF7	GC034135	Outer Joint	44T	28	23	56	90	57.5	I						
	2005.06-	2008.02	MT	L	F	Hatchback Engine LFF7	GDS34137	Drive Shaft	44T	28	28	56.6	90	648							
	2005.06-	2008.02	MT	L	F	Saloon Engine LFF7	GDS34137	Drive Shaft	44T	28	28	56.6	90	648							
	2005.06-	2008.02		L/R	F	Hatchback Engine LFF7	GC034110	Outer Joint	44T	28	32	62	90	57.5	I						
	2005.06-	2008.02		L/R	F	Saloon Engine LFF7	GC034110	Outer Joint	44T	28	32	62	90	57.5	I						
	2005.06-	2008.02	MT	R	F	Hatchback Engine LFF7	GDS34088	Drive Shaft	44T	28	28	56.6	90	599							
	2005.06-	2008.02	MT	R	F	Saloon Engine LFF7	GDS34088	Drive Shaft	44T	28	28	56.6	90	599							
	2005.06-	2008.02				Hatchback Engine LFF7	GC034070	Outer Joint	44T	28	32	56	90	59	I						
2.0 Di (100 kW)	2002.06-	2007.08			F	Saloon Engine RF5C	GC034084	Outer Joint	44T	28	32	62	90	58	I						
	2002.06-	2007.08			F	Saloon Engine RF5C	GC099273	Outer Joint	44T	28	33	56.6	90	59	I						
	2002.06-	2007.08		L	F	Saloon Engine RF5C	GDS34039	Drive Shaft	44T	28	30	56.6	90	643							
	2002.06-	2007.08		L	F	Saloon Engine RF5C	GDS34153	Drive Shaft	44T	31	30	65	94	611.5							
	2002.06-	2007.08		R	F	Saloon Engine RF5C	GDS99064	Drive Shaft	44T	28	28	56.6	90	587							
	2002.06-	2007.08		R	F	Saloon Engine RF5C	GDS34165	Drive Shaft	44T	31	31	65	94	555							
	2002.06-	2007.08	5MT	R	F	Saloon Engine RF5C	GDS34088	Drive Shaft	44T	28	28	56.6	90	599							
	2002.06-	2007.08	6MT	R	F	Saloon Engine RF5C	GDS34120	Drive Shaft	44T	31	31	65	94	556							
	2002.06-	2007.08	5MT			Saloon Engine RF5C	GC034070	Outer Joint	44T	28	32	56	90	59	I						
	2002.06-	2007.08	6MT			Saloon Engine RF5C	GC034114	Outer Joint	44T	31	36	65	94	65	I						
	2002.08-	2007.08		L	F	Hatchback Engine RF5C	GDS34039	Drive Shaft	44T	28	30	56.6	90	643							
	2002.08-	2007.08		L	F	Hatchback Engine RF5C	GDS34153	Drive Shaft	44T	31	30	65	94	611.5							
	2002.08-	2007.08		R	F	Hatchback Engine RF5C	GDS99064	Drive Shaft	44T	28	28	56.6	90	587							
	2002.08-	2007.08		R	F	Hatchback Engine RF5C	GDS34165	Drive Shaft	44T	31	31	65	94	555							
	2002.08-	2007.08	5MT	R	F	Hatchback Engine RF5C	GDS34088	Drive Shaft	44T	28	28	56.6	90	599							
	2002.08-	2007.08	6MT	R	F	Hatchback Engine RF5C	GDS34120	Drive Shaft	44T	31	31	65	94	556							
	2002.08-	2007.08	5MT			Hatchback Engine RF5C	GC034070	Outer Joint	44T	28	32	56	90	59	I						
	2002.08-	2007.08	6MT			Hatchback Engine RF5C	GC034114	Outer Joint	44T	31	36	65	94	65	I						
	2.0 Di (105 kW)	2005.06-	2008.02		L	F	Hatchback Engine RF7J	GDS34039	Outer Joint	44T	28	33	56.6	90	59	I					
		2005.06-	2008.02		L	F	Hatchback Engine RF7J	GDS34153	Drive Shaft	44T	31	30	65	94	611.5						
2005.06-		2008.02		L	F	Saloon Engine RF7J	GDS34153	Drive Shaft	44T	31	30	65	94	611.5							
2005.06-		2008.02		R	F	Hatchback Engine RF7J	GDS99064	Drive Shaft	44T	28	28	56.6	90	587							
2005.06-		2008.02		R	F	Hatchback Engine RF7J	GDS34165	Drive Shaft	44T	31	31	65	94	555							
2005.06-		2008.02		R	F	Saloon Engine RF7J	GDS34165	Drive Shaft	44T	31	31	65	94	555							
2005.06-		2008.02	5MT	R	F	Hatchback Engine RF7J	GDS34088	Drive Shaft	44T	28	28	56.6	90	599							
2005.06-		2008.02	5MT	R	F	Saloon Engine RF7J	GDS34088	Drive Shaft	44T	28	28	56.6	90	599							
2005.06-		2008.02	AT	R	F	Hatchback Engine RF7J	GDS34120	Drive Shaft	44T	31	31	65	94	556							
2005.06-		2008.02	AT	R	F	Saloon Engine RF7J	GDS34120	Drive Shaft	44T	31	31	65	94	556							
2005.06-		2008.02	5MT			Hatchback Engine RF7J	GC034070	Outer Joint	44T	28	32	56	90	59	I						
2005.06-		2008.02	5MT			Saloon Engine RF7J	GC034070	Outer Joint	44T	28	32	56	90	59	I						
2005.06-		2008.02	6MT			Hatchback Engine RF7J	GC034114	Outer Joint	44T	31	36	65	94	65	I						
2.0 Di (89 kW)	2002.08-	2007.08			F	Hatchback Engine RF5C	GC034084	Outer Joint	44T	28	32	62	90	58	I						
	2002.08-	2007.08			F	Hatchback Engine RF5C	GC099273	Outer Joint	44T	28	33	56.6	90	59	I						
	2002.08-	2007.08			F	Saloon Engine RF5C	GC034084	Outer Joint	44T	28	32	62	90	58	I						
	2002.08-	2007.08			F	Saloon Engine RF5C	GC099273	Outer Joint	44T	28	33	56.6	90	59	I						
	2002.08-	2007.08		L	F	Hatchback Engine RF5C	GDS34039	Drive Shaft	44T	28	30	56.6	90	643							
	2002.08-	2007.08		L	F	Hatchback Engine RF5C	GDS34153	Drive Shaft	44T	31	30	65	94	611.5							
	2002.08-	2007.08		L	F	Saloon Engine RF5C	GDS34039	Drive Shaft	44T	28	30	56.6	90	643							
	2002.08-	2007.08		L	F	Saloon Engine RF5C	GDS34153	Drive Shaft	44T	31	30	65	94	611.5							
	2002.08-	2007.08		R	F	Hatchback Engine RF5C	GDS99064	Drive Shaft	44T	28	28	56.6	90	587							
	2002.08-	2007.08		R	F	Hatchback Engine RF5C	GDS34165	Drive Shaft	44T	31	31	65	94	555							
	2002.08-	2007.08		R	F	Saloon Engine RF5C	GDS34165	Drive Shaft	44T	31	31	65	94	555							
	2002.08-	2007.08		R	F	Saloon Engine RF5C	GDS99064	Drive Shaft	44T	28	28	56.6	90	587							
	2002.08-	2007.08	5MT	R	F	Hatchback Engine RF5C	GDS34088	Drive Shaft	44T	28	28	56.6	90	599							
	2002.08-	2007.08	5MT	R	F	Saloon Engine RF5C	GDS34088	Drive Shaft	44T	28	28	56.6	90	599							
	2002.08-	2007.08	6MT	R	F	Hatchback Engine RF5C	GDS34120	Drive Shaft	44T	31	31	65	94	556							
	2002.08-	2007.08	6MT	R	F	Saloon Engine RF5C	GDS34120	Drive Shaft	44T	31	31	65	94	556							
	2002.08-	2007.08	5MT			Hatchback Engine RF5C	GC034070	Outer Joint	44T	28	32	56	90	59	I						

		YEAR	TRANSM	L/R	F/R		G-AP Ref.	PRODUCT	ABS	Technical Specifications						
										A	B	C	H	L	P	
<b>MAZDA</b>																
<b>6 (GG)</b>																
2.0 Di (89 kW)	2002.08-	2007.08	5MT			Saloon Engine RF5C	GC034070	Outer Joint	44T	28	32	56	90	59	I	
	2002.08-	2007.08	6MT			Hatchback Engine RF5C	GC034114	Outer Joint	44T	31	36	65	94	65	I	
	2002.08-	2007.08	6MT			Saloon Engine RF5C	GC034114	Outer Joint	44T	31	36	65	94	65	I	
2.3 (120 kW)	2005.03-	2007.07	AT			Saloon Engine L3C1	GC034070	Outer Joint	44T	28	32	56	90	59	I	
2.3 (122 kW)	2002.06-	2007.08			F	Saloon Engine L3C1	GC034084	Outer Joint	44T	28	32	62	90	58	I	
	2002.06-	2007.08		L/R	F	Saloon Engine L3C1	GC034110	Outer Joint	44T	28	32	62	90	57.5	I	
	2002.06-	2007.08	AT			Saloon Engine L3C1	GC034070	Outer Joint	44T	28	32	56	90	59	I	
	2002.08-	2007.08			F	Hatchback Engine L3C1	GC034084	Outer Joint	44T	28	32	62	90	58	I	
	2002.08-	2007.08		L/R	F	Hatchback Engine L3C1	GC034110	Outer Joint	44T	28	32	62	90	57.5	I	
2.3 MPS Turbo (191 kW)	2006.01-	2008.02		L	F	Saloon Engine L3KG	GDS34153	Drive Shaft	44T	31	30	65	94	611.5		
	2006.01-	2008.02		L/R	F	Saloon Engine L3KG	GC034110	Outer Joint	44T	28	32	62	90	57.5	I	
	2006.01-	2008.02			R	F	Saloon Engine L3KG	GDS34165	Drive Shaft	44T	31	31	65	94	555	
<b>6 (GH)</b>																
1.8 MZR (88 kW)	2007.08-		MT	R	F	Hatchback Engine L813	GDS18325	Drive Shaft		31	31	65	94	567		
	2007.08-		MT	R	F	Saloon Engine L813	GDS18325	Drive Shaft		31	31	65	94	567		
	2008.02-		MT	R	F	Estate Engine L813	GDS18325	Drive Shaft		31	31	65	94	567		
2.0 MZR (108 kW)	2007.08-		MT	R	F	Hatchback Engine LF17	GDS18325	Drive Shaft		31	31	65	94	567		
	2007.08-		MT	R	F	Saloon Engine LF17	GDS18325	Drive Shaft		31	31	65	94	567		
	2008.02-		MT	R	F	Estate Engine LF17	GDS18325	Drive Shaft		31	31	65	94	567		
2.0 MZR (114 kW)	2010.01-		MT	R	F	Estate Engine LF-DE	GDS18325	Drive Shaft		31	31	65	94	567		
	2010.01-		MT	R	F	Hatchback Engine LF-DE	GDS18325	Drive Shaft		31	31	65	94	567		
	2010.01-		MT	R	F	Saloon Engine LF-DE	GDS18325	Drive Shaft		31	31	65	94	567		
2.0 MZR CD (103 kW)	2007.08-					Hatchback Engine RF7J	GC018245	Outer Joint		31	36	65	94	63	I	
	2007.08-					Saloon Engine RF7J	GC018245	Outer Joint		31	36	65	94	63	I	
	2008.02-					Estate Engine RF7J	GC018245	Outer Joint		31	36	65	94	63	I	
2.2 D (132 kW)	2010.01-				Saloon Engine R2AA	GC018245	Outer Joint		31	36	65	94	63	I		
2.2 MZR CD (120 kW)	2009.01-					Estate Engine R2AA	GC018245	Outer Joint		31	36	65	94	63	I	
	2009.01-					Hatchback Engine R2AA	GC018245	Outer Joint		31	36	65	94	63	I	
	2009.01-					Saloon Engine R2AA	GC018245	Outer Joint		31	36	65	94	63	I	
2.2 MZR CD (132 kW)	2010.01-					Estate Engine R2AA	GC018245	Outer Joint		31	36	65	94	63	I	
	2010.01-					Hatchback Engine R2AA	GC018245	Outer Joint		31	36	65	94	63	I	
2.2 MZR CD (136 kW)	2009.01-					Estate Engine R2AA	GC018245	Outer Joint		31	36	65	94	63	I	
	2009.01-					Hatchback Engine R2AA	GC018245	Outer Joint		31	36	65	94	63	I	
	2009.01-					Saloon Engine R2AA	GC018245	Outer Joint		31	36	65	94	63	I	
<b>6 (GY)</b>																
2.0	2002.08-		MT/AT				GC034147	Outer Joint	44T	28	33	56.5	90	58.5	M	
<b>6 STATION WAGON (GY)</b>																
1.8 (88 kW)	2002.08-	2007.08			F	Estate Engine L813	GC034084	Outer Joint	44T	28	32	62	90	58	I	
	2002.08-	2007.08	MT		F	Estate Engine L813	GC034135	Outer Joint	44T	28	23	56	90	57.5	I	
	2002.08-	2007.08	MT	L	F	Estate Engine L813	GDS34137	Drive Shaft	44T	28	28	56.6	90	648		
	2002.08-	2007.08		L/R	F	Estate Engine L813	GC034110	Outer Joint	44T	28	32	62	90	57.5	I	
	2002.08-	2007.08	MT	R	F	Estate Engine L813	GDS34088	Drive Shaft	44T	28	28	56.6	90	599		
	2002.08-	2007.08				Estate Engine L813	GC034070	Outer Joint	44T	28	32	56	90	59	I	
2.0 (104 kW)	2002.08-	2007.08			F	Estate Engine LF17/LF18	GC034084	Outer Joint	44T	28	32	62	90	58	I	
	2002.08-	2007.08	MT		F	Estate Engine LF17/LF18	GC034135	Outer Joint	44T	28	23	56	90	57.5	I	
	2002.08-	2007.08	MT	L	F	Estate Engine LF17/LF18	GDS34137	Drive Shaft	44T	28	28	56.6	90	648		
	2002.08-	2007.08		L/R	F	Estate Engine LF17/LF18	GC034110	Outer Joint	44T	28	32	62	90	57.5	I	
	2002.08-	2007.08	MT	R	F	Estate Engine LF17/LF18	GDS34088	Drive Shaft	44T	28	28	56.6	90	599		
	2002.08-	2007.08				Estate Engine LF17/LF18	GC034070	Outer Joint	44T	28	32	56	90	59	I	
2.0 (108 kW)	2005.06-	2008.02	MT		F	Estate Engine LFF7	GC034135	Outer Joint	44T	28	23	56	90	57.5	I	
	2005.06-	2008.02	MT	L	F	Estate Engine LFF7	GDS34137	Drive Shaft	44T	28	28	56.6	90	648		
	2005.06-	2008.02		L/R	F	Estate Engine LFF7	GC034110	Outer Joint	44T	28	32	62	90	57.5	I	
	2005.06-	2008.02	MT	R	F	Estate Engine LFF7	GDS34088	Drive Shaft	44T	28	28	56.6	90	599		
	2005.06-	2008.02				Estate Engine LFF7	GC034070	Outer Joint	44T	28	32	56	90	59	I	
2.0 Di (100 kW)	2002.08-	2007.08			F	Estate Engine RF5C	GC034084	Outer Joint	44T	28	32	62	90	58	I	
	2002.08-	2007.08			F	Estate Engine RF5C	GC099273	Outer Joint	44T	28	33	56.6	90	59	I	
	2002.08-	2007.08		L	F	Estate Engine RF5C	GDS34039	Drive Shaft	44T	28	30	56.6	90	643		
	2002.08-	2007.08		L	F	Estate Engine RF5C	GDS34153	Drive Shaft	44T	31	30	65	94	611.5		
	2002.08-	2007.08		R	F	Estate Engine RF5C	GDS99064	Drive Shaft	44T	28	28	56.6	90	587		
	2002.08-	2007.08		R	F	Estate Engine RF5C	GDS34165	Drive Shaft	44T	31	31	65	94	555		
	2002.08-	2007.08	5MT	R	F	Estate Engine RF5C	GDS34088	Drive Shaft	44T	28	28	56.6	90	599		
	2002.08-	2007.08	6MT	R	F	Estate Engine RF5C	GDS34120	Drive Shaft	44T	31	31	65	94	556		









		YEAR	TRANSM	L/R	F/R		G-AP Ref.	PRODUCT	ABS	Technical Specifications						
										A	B	C	H	L	P	
<b>MAZDA</b>																
<b>6 STATION WAGON (GY)</b>																
2.0 Di (100 kW)	2002.08-	2007.08	5MT			Estate Engine RF5C	GC034070	Outer Joint	44T	28	32	56	90	59	I	
	2002.08-	2007.08	6MT			Estate Engine RF5C	GC034114	Outer Joint	44T	31	36	65	94	65	I	
2.0 Di (105 kW)	2005.06-	2008.02		L	F	Estate Engine RF7J	GDS34153	Drive Shaft	44T	31	30	65	94	611.5		
	2005.06-	2008.02		R	F	Estate Engine RF7J	GDS34165	Drive Shaft	44T	31	31	65	94	555		
	2005.06-	2008.02	5MT	R	F	Estate Engine RF7J	GDS34088	Drive Shaft	44T	28	28	56.6	90	599		
	2005.06-	2008.02	6MT	R	F	Estate Engine RF7J	GDS34120	Drive Shaft	44T	31	31	65	94	556		
	2005.06-	2008.02	5MT			Estate Engine RF7J	GC034070	Outer Joint	44T	28	32	56	90	59	I	
	2005.06-	2008.02	6MT			Estate Engine RF7J	GC034114	Outer Joint	44T	31	36	65	94	65	I	
2.0 Di (89 kW)	2002.08-	2007.08			F	Estate Engine RF5C	GC034084	Outer Joint	44T	28	32	62	90	58	I	
	2002.08-	2007.08			F	Estate Engine RF5C	GC099273	Outer Joint	44T	28	33	56.6	90	59	I	
	2002.08-	2007.08		L	F	Estate Engine RF5C	GDS34039	Drive Shaft	44T	28	30	56.6	90	643		
	2002.08-	2007.08		L	F	Estate Engine RF5C	GDS34153	Drive Shaft	44T	31	30	65	94	611.5		
	2002.08-	2007.08		R	F	Estate Engine RF5C	GDS99064	Drive Shaft	44T	28	28	56.6	90	587		
	2002.08-	2007.08		R	F	Estate Engine RF5C	GDS34165	Drive Shaft	44T	31	31	65	94	555		
	2002.08-	2007.08	5MT	R	F	Estate Engine RF5C	GDS34088	Drive Shaft	44T	28	28	56.6	90	599		
	2002.08-	2007.08	6MT	R	F	Estate Engine RF5C	GDS34120	Drive Shaft	44T	31	31	65	94	556		
	2002.08-	2007.08	5MT			Estate Engine RF5C	GC034070	Outer Joint	44T	28	32	56	90	59	I	
	2002.08-	2007.08	6MT			Estate Engine RF5C	GC034114	Outer Joint	44T	31	36	65	94	65	I	
2.3 (122 kW)	2002.08-	2007.08			F	Estate Engine L3C1	GC034084	Outer Joint	44T	28	32	62	90	58	I	
	2002.08-	2007.08		L/R	F	Estate Engine L3C1	GC034110	Outer Joint	44T	28	32	62	90	57.5	I	
	2002.08-	2007.08				Estate Engine L3C1	GC034070	Outer Joint	44T	28	32	56	90	59	I	
2.3 AWD (119 kW)	2002.11-	2005.05		L/R	F	Estate Engine L3C1	GC034110	Outer Joint	44T	28	32	62	90	57.5	I	
	2002.11-	2005.05	AT			Estate Engine L3C1	GC034070	Outer Joint	44T	28	32	56	90	59	I	
<b>626</b>																
-						GE 4WD	GC039123	Outer Joint		28	21	56	90	58	I	
	1987-	1991				GD6P GD8S	GC034050	Outer Joint		26	23	56	93.5	56.5	M	
	1991-	1997					GC034029	Outer Joint		28	23	56	89	60.5	M	
	1991-	1997					GC034061	Outer Joint	44T	28	23	56	89	60.5	M	
	1998-	2001					GCI34013	Inner Joint		28	23	43	42	76.5		
	1998-	2001	AT				GCI99113	Inner Joint		26	23	35	67	95		
1.8	1998-	2000	AT				GC034038	Outer Joint		28	23	56	90	59	M	
							GCI34003	Inner Joint		26	23	43	37.8	75.5		
							GC034045	Outer Joint		26	25	56	93.5	56.5	O	
	1984-	1988					GC099048	Outer Joint		26	25	52	93	61	O	
1.8 Male	1988-					GC034054	Outer Joint		26	30	56	93	55	M		
1.8 Male	1984-	1992				GCI34004	Inner Joint		26	23	35	66.7	99.5			
2.0	1984-	1992					GCI34002	Inner Joint		26	25	42.3	37.8	76.5		
	1984-	1992					GCI18005	Inner Joint		26	25	35	66.5	103.4		
	1984-	1988					GC099047	Outer Joint		26	25	52	92	61	O	
	1988-	1992					GC099052	Outer Joint		26	25	56	93	61	O	
	1993-	1996	AT				GC018078	Outer Joint	44T	28	32	56	91.5	65	I	
	1993-	1997	MT				GC034036	Outer Joint		28	32	56	90	59	I	
	1993-	1997	MT				GC034063	Outer Joint	44T	28	32	56	90	59	I	
2.5	1993-	1996	AT				GC018045	Outer Joint		28	32	56	91.5	65	I	
	1993-	1996	AT				GC018078	Outer Joint	44T	28	32	56	91.5	65	I	
	1993-	1997	MT				GC034036	Outer Joint		28	32	56	90	59	I	
	1993-	1997	MT				GC034063	Outer Joint	44T	28	32	56	90	59	I	
<b>626 (GE)</b>																
-	1991-	1997					GCI34033	Inner Joint		28	23	43	46	77		
<b>626 / MX-6 MYSTERE&amp;CRONOS</b>																
-	1983-	1987					GCI34036	Inner Joint		26	25	43	37.8	75.5		
<b>626 II (GC)</b>																
1.6 (55 kW)	1983.03-	1987.09	MT		F	Hatchback	GC034002	Outer Joint		26	23	52	93	61	M	
	1983.03-	1987.09			F	Hatchback	GC034086	Outer Joint		26	23	52	92	56	M	
1.6 (59 kW)	1982.11-	1987.06	MT		F	Saloon Engine F6	GC034002	Outer Joint		26	23	52	93	61	M	
	1982.11-	1987.06			F	Saloon Engine F6	GC034086	Outer Joint		26	23	52	92	56	M	
	1983.03-	1987.09	MT		F	Hatchback Engine F6	GC034002	Outer Joint		26	23	52	93	61	M	
	1983.03-	1987.09			F	Hatchback Engine F6	GC034086	Outer Joint		26	23	52	92	56	M	
2.0 (68 kW)	1985.01-	1987.09			F	Hatchback Engine FE(8V)	GC034086	Outer Joint		26	23	52	92	56	M	
	1985.01-	1987.09	MT		F	Hatchback Engine FE(8V)	GC034001	Outer Joint		26	25	52	92	61	M	
	1986.11-	1987.09			F	Saloon Engine FE(8V)	GC034086	Outer Joint		26	23	52	92	56	M	



		YEAR	TRANSM	L/R	F/R		G-AP Ref.	PRODUCT	ABS	Technical Specifications									
										A	B	C	H	L	P				
<b>MAZDA</b>																			
<b>626 II (GC)</b>																			
2.0 (68 kW)	1986.11-	1987.09	MT			Saloon Engine FE(8V)	GC034001	Outer Joint		26	25	52	92	61	M				
2.0 (74 kW)	1983.03-	1987.09				Hatchback Engine FE(8V)	GC034086	Outer Joint		26	23	52	92	56	M				
	1983.03-	1987.09				Saloon Engine FE(8V)	GC034086	Outer Joint		26	23	52	92	56	M				
	1983.03-	1987.09	MT			Hatchback Engine FE(8V)	GC034001	Outer Joint		26	25	52	92	61	M				
	1983.03-	1987.09	MT			Saloon Engine FE(8V)	GC034001	Outer Joint		26	25	52	92	61	M				
2.0 (88 kW)	1986.01-	1987.09				Hatchback Engine FE(8V)	GC034086	Outer Joint		26	23	52	92	56	M				
	1986.01-	1987.09				Saloon Engine FE(8V)	GC034086	Outer Joint		26	23	52	92	56	M				
	1986.01-	1987.09	MT			Hatchback Engine FE(8V)	GC034001	Outer Joint		26	25	52	92	61	M				
	1986.01-	1987.09	MT			Saloon Engine FE(8V)	GC034001	Outer Joint		26	25	52	92	61	M				
2.0 D (46 kW)	1983.01-	1987.06				Saloon Engine RF46	GC034086	Outer Joint		26	23	52	92	56	M				
	1983.01-	1987.06	MT/AT			Saloon Engine RF46	GC034001	Outer Joint		26	25	52	92	61	M				
	1984.03-	1987.06				Hatchback Engine RF46	GC034086	Outer Joint		26	23	52	92	56	M				
	1984.03-	1987.06	MT/AT			Hatchback Engine RF46	GC034001	Outer Joint		26	25	52	92	61	M				
<b>626 III (GD)</b>																			
1.6 (60 kW)	1987.06-	1992.05	AT			Coupe	GC027027	Outer Joint	44T	26	23	56	93	55	M				
	1987.06-	1992.05	AT			Hatchback	GC027027	Outer Joint	44T	26	23	56	93	55	M				
1.8 (65 kW)	1987.09-	1991.08	MT			Coupe Engine F8(12V)	GC034019	Outer Joint		26	21	56	94	56	I				
	1987.09-	1991.08	MT			Coupe Engine F8(12V)	GC018031	Outer Joint		26	25	56	93	61	M				
	1987.09-	1991.08	AT			Coupe Engine F8(12V)	GC034004	Outer Joint		26	23	56	93.5	56.5	M				
	1987.11-	1992.05	MT			Saloon Engine F8(12V)	GC034019	Outer Joint		26	21	56	94	56	I				
	1987.11-	1992.05				Hatchback Engine F8(12V)	GC034019	Outer Joint		26	21	56	94	56	I				
	1987.11-	1992.05	MT			Hatchback Engine F8(12V)	GC018031	Outer Joint		26	25	56	93	61	M				
	1987.11-	1992.05	MT			Saloon Engine F8(12V)	GC018031	Outer Joint		26	25	56	93	61	M				
	1987.11-	1992.05	AT			Hatchback Engine F8(12V)	GC034004	Outer Joint		26	23	56	93.5	56.5	M				
2.0 (66 kW)	1987.11-	1992.05	AT			Saloon Engine F8(12V)	GC034004	Outer Joint		26	23	56	93.5	56.5	M				
	1987.09-	1990.10	MT			Coupe Engine FE(8V)	GC034019	Outer Joint		26	21	56	94	56	I				
	1987.09-	1990.10	MT			Hatchback Engine FE(8V)	GC034019	Outer Joint		26	21	56	94	56	I				
	1987.09-	1990.10				Coupe Engine FE(8V)	GC034074	Outer Joint	90T	26	25	56	93	61	M				
	1987.09-	1990.10				Hatchback Engine FE(8V)	GC034074	Outer Joint	90T	26	25	56	93	61	M				
	1987.09-	1990.10	AT			Coupe Engine FE(8V)	GC034068	Outer Joint	90T	26	25	56	93	61	I				
	1987.09-	1990.10	AT			Hatchback Engine FE(8V)	GC034068	Outer Joint	90T	26	25	56	93	61	I				
	1987.09-	1990.10	AT			Saloon Engine FE(12V)	GC034068	Outer Joint	90T	26	25	56	93	61	I				
2.0 12V (79 kW)	1987.09-	1990.10	MT			Coupe Engine FE(8V)	GC018031	Outer Joint		26	25	56	93	61	M				
	1987.09-	1990.10	MT			Hatchback Engine FE(8V)	GC018031	Outer Joint		26	25	56	93	61	M				
	1987.09-	1990.10				Saloon Engine FE(12V)	GC018031	Outer Joint		26	25	56	93	61	M				
	1987.09-	1990.10	MT			Coupe Engine FE	GC034019	Outer Joint		26	21	56	94	56	I				
	1987.09-	1992.05	MT			Saloon Engine FE	GC034019	Outer Joint		26	21	56	94	56	I				
	1987.09-	1992.05				Saloon Engine FE	GC034074	Outer Joint	90T	26	25	56	93	61	M				
	1987.09-	1988.12	MT			Coupe Engine FE	GC018029	Outer Joint	44T	28	26	56	89	65	I				
	1987.09-	1992.05	MT			Saloon Engine FE	GC018029	Outer Joint	44T	28	26	56	89	65	I				
	1987.09-	1988.12	MT			Coupe Engine FE	GC034082	Outer Joint	44T	28	26	56	94	63	M				
	1987.09-	1992.05	MT			Saloon Engine FE	GC034082	Outer Joint	44T	28	26	56	94	63	M				
	1987.09-	1988.12	AT			Coupe Engine FE	GC034068	Outer Joint	90T	26	25	56	93	61	I				
	1987.09-	1992.05	AT			Saloon Engine FE	GC034068	Outer Joint	90T	26	25	56	93	61	I				
	1987.09-	1988.12	AT			Coupe Engine FE	GC018031	Outer Joint		26	25	56	93	61	M				
	1987.09-	1992.05	AT			Saloon Engine FE	GC018031	Outer Joint		26	25	56	93	61	M				
	1987.09-	1988.12	MT			Coupe Engine FE	GC018028	Outer Joint		28	26	56	89	65	I				
	1987.09-	1992.05	MT			Saloon Engine FE	GC018028	Outer Joint		28	26	56	89	65	I				
2.0 16V (103 kW)	1987.11-	1992.05	MT			Hatchback Engine FE	GC034019	Outer Joint		26	21	56	94	56	I				
	1987.11-	1992.05				Hatchback Engine FE	GC034074	Outer Joint	90T	26	25	56	93	61	M				
	1987.11-	1992.05	MT			Hatchback Engine FE	GC018029	Outer Joint	44T	28	26	56	89	65	I				
	1987.11-	1992.05	MT			Hatchback Engine FE	GC034082	Outer Joint	44T	28	26	56	94	63	M				
	1987.11-	1992.05	AT			Hatchback Engine FE	GC034068	Outer Joint	90T	26	25	56	93	61	I				
	1987.11-	1992.05	AT			Hatchback Engine FE	GC018031	Outer Joint		26	25	56	93	61	M				
	1987.11-	1992.05	MT			Hatchback Engine FE	GC018028	Outer Joint		28	26	56	89	65	I				
	1987.11-	1990.10	MT			Hatchback Engine FE	GC018028	Outer Joint		28	26	56	89	65	I				
	1987.11-	1990.10	MT			Saloon Engine FE	GC034019	Outer Joint		26	21	56	94	56	I				
	1987.11-	1990.10				Hatchback Engine FE	GC034074	Outer Joint	90T	26	25	56	93	61	M				
1987.11-	1992.05				Saloon Engine FE	GC034074	Outer Joint	90T	26	25	56	93	61	M					
1987.11-	1990.10	MT			Hatchback Engine FE	GC018029	Outer Joint	44T	28	26	56	89	65	I					

		TRANSM	L/R	F/R		G-AP Ref.	PRODUCT	ABS	Technical Specifications						
									YEAR	A	B	C	H	L	P
<b>MAZDA</b>															
<b>626 III (GD)</b>															
2.0 16V (103 kW)	1987.11-	1992.05	MT		F	Saloon Engine FE	GC018029	Outer Joint	44T	28	26	56	89	65	I
	1987.11-	1990.10	MT		F	Hatchback Engine FE	GC034082	Outer Joint	44T	28	26	56	94	63	M
	1987.11-	1992.05	MT		F	Saloon Engine FE	GC034082	Outer Joint	44T	28	26	56	94	63	M
	1987.11-	1990.10	AT		F	Hatchback Engine FE	GC034068	Outer Joint	90T	26	25	56	93	61	I
	1987.11-	1992.05	AT		F	Saloon Engine FE	GC034068	Outer Joint	90T	26	25	56	93	61	I
	1987.11-	1990.10	AT		F	Hatchback Engine FE	GC018031	Outer Joint		26	25	56	93	61	M
	1987.11-	1992.05	AT		F	Saloon Engine FE	GC018031	Outer Joint		26	25	56	93	61	M
	1987.12-	1990.10	MT		F	Coupe Engine FE	GC018028	Outer Joint		28	26	56	89	65	I
	1987.12-	1990.10	MT		F	Coupe Engine FE	GC034019	Outer Joint		26	21	56	94	56	I
	1987.12-	1990.10			F	Coupe Engine FE	GC034074	Outer Joint	90T	26	25	56	93	61	M
	1987.12-	1990.10	MT		F	Coupe Engine FE	GC018029	Outer Joint	44T	28	26	56	89	65	I
	1987.12-	1990.10	MT		F	Coupe Engine FE	GC034082	Outer Joint	44T	28	26	56	94	63	M
	1987.12-	1990.10	AT		F	Coupe Engine FE	GC034068	Outer Joint	90T	26	25	56	93	61	I
	1987.12-	1990.10	AT		F	Coupe Engine FE	GC018031	Outer Joint		26	25	56	93	61	M
2.0 16V (109 kW)	1987.06-	1989.08	MT		F	Hatchback Engine FE	GC018028	Outer Joint		28	26	56	89	65	I
	1987.06-	1989.09	MT		F	Coupe Engine FE	GC018028	Outer Joint		28	26	56	89	65	I
	1987.06-	1989.08	MT		F	Hatchback Engine FE	GC034019	Outer Joint		26	21	56	94	56	I
	1987.06-	1989.09	MT		F	Coupe Engine FE	GC034019	Outer Joint		26	21	56	94	56	I
	1987.06-	1989.08	MT		F	Hatchback Engine FE	GC018029	Outer Joint	44T	28	26	56	89	65	I
	1987.06-	1989.09	MT		F	Coupe Engine FE	GC018029	Outer Joint	44T	28	26	56	89	65	I
	1987.06-	1989.08	MT		F	Hatchback Engine FE	GC034082	Outer Joint	44T	28	26	56	94	63	M
	1987.06-	1989.09	MT		F	Coupe Engine FE	GC034082	Outer Joint	44T	28	26	56	94	63	M
	1987.06-	1989.08	AT		F	Hatchback Engine FE	GC018031	Outer Joint		26	25	56	93	61	M
	1987.06-	1989.09	AT		F	Coupe Engine FE	GC018031	Outer Joint		26	25	56	93	61	M
	1987.07-	1989.09	MT		F	Saloon Engine FE	GC018028	Outer Joint		28	26	56	89	65	I
	1987.07-	1989.09	MT		F	Saloon Engine FE	GC034019	Outer Joint		26	21	56	94	56	I
	1987.07-	1989.09	MT		F	Saloon Engine FE	GC018029	Outer Joint	44T	28	26	56	89	65	I
	1987.07-	1989.09	MT		F	Saloon Engine FE	GC034082	Outer Joint	44T	28	26	56	94	63	M
1987.07-	1989.09	AT		F	Saloon Engine FE	GC018031	Outer Joint		26	25	56	93	61	M	
2.0 D (44 kW)	1987.07-	1991.07	MT		F	Hatchback Engine RF-N	GC018028	Outer Joint		28	26	56	89	65	I
	1987.07-	1991.07	MT		F	Saloon Engine RF-N	GC018028	Outer Joint		28	26	56	89	65	I
	1987.07-	1991.07	MT		F	Hatchback Engine RF-N	GC018029	Outer Joint	44T	28	26	56	89	65	I
	1987.07-	1991.07	MT		F	Saloon Engine RF-N	GC018029	Outer Joint	44T	28	26	56	89	65	I
	1987.07-	1991.07	MT		F	Hatchback Engine RF-N	GC034082	Outer Joint	44T	28	26	56	94	63	M
	1987.07-	1991.07	MT		F	Saloon Engine RF-N	GC034082	Outer Joint	44T	28	26	56	94	63	M
	1987.07-	1991.07	AT		F	Hatchback Engine RF-N	GC018031	Outer Joint		26	25	56	93	61	M
	1987.07-	1991.07	AT		F	Saloon Engine RF-N	GC018031	Outer Joint		26	25	56	93	61	M
2.2 12V (85 kW)	1987.11-	1991.07	MT		F	Saloon Engine F2	GC018028	Outer Joint		28	26	56	89	65	I
	1987.11-	1991.07	MT		F	Saloon Engine F2	GC018029	Outer Joint	44T	28	26	56	89	65	I
	1987.11-	1991.07	MT		F	Saloon Engine F2	GC034082	Outer Joint	44T	28	26	56	94	63	M
	1987.11-	1991.07	AT		F	Saloon Engine F2	GC034068	Outer Joint	90T	26	25	56	93	61	I
	1987.11-	1991.07	AT		F	Saloon Engine F2	GC018031	Outer Joint		26	25	56	93	61	M
	1988.04-	1991.12	MT		F	Coupe Engine F2	GC018028	Outer Joint		28	26	56	89	65	I
	1988.04-	1991.12	MT		F	Coupe Engine F2	GC018029	Outer Joint	44T	28	26	56	89	65	I
	1988.04-	1991.12	MT		F	Coupe Engine F2	GC034082	Outer Joint	44T	28	26	56	94	63	M
	1988.04-	1991.12	AT		F	Coupe Engine F2	GC034068	Outer Joint	90T	26	25	56	93	61	I
	1988.04-	1991.12	AT		F	Coupe Engine F2	GC018031	Outer Joint		26	25	56	93	61	M
	1988.06-	1992.04	MT		F	Hatchback Engine F2	GC018028	Outer Joint		28	26	56	89	65	I
	1988.06-	1992.04	MT		F	Hatchback Engine F2	GC018029	Outer Joint	44T	28	26	56	89	65	I
	1988.06-	1992.04	MT		F	Hatchback Engine F2	GC034082	Outer Joint	44T	28	26	56	94	63	M
	1988.06-	1992.04	AT		F	Hatchback Engine F2	GC034068	Outer Joint	90T	26	25	56	93	61	I
1988.06-	1992.04	AT		F	Hatchback Engine F2	GC018031	Outer Joint		26	25	56	93	61	M	
2.2 12V 4WD (85 kW)	1990.01-	1992.05	AT		F	Saloon Engine F2	GC034068	Outer Joint	90T	26	25	56	93	61	I
	1990.01-	1992.05	AT			Saloon Engine F2	GC018031	Outer Joint		26	25	56	93	61	M
<b>626 III (GV)</b>															
1.8 (65 kW)	1988.01-	1992.03	MT		F	Estate Engine F8(12V)	GC034019	Outer Joint		26	21	56	94	56	I
	1988.01-	1992.03	MT		F	Estate Engine F8(12V)	GC018031	Outer Joint		26	25	56	93	61	M
	1988.01-	1992.03	AT		F	Estate Engine F8(12V)	GC034004	Outer Joint		26	23	56	93.5	56.5	M
2.0 (66 kW)	1988.10-	1997.09	MT		F	Estate Engine FE(8V)	GC018028	Outer Joint		28	26	56	89	65	I
	1988.10-	1997.09	MT		F	Estate Engine FE(8V)	GC034019	Outer Joint		26	21	56	94	56	I
	1988.10-	1997.09			F	Estate Engine FE(8V)	GC034074	Outer Joint	90T	26	25	56	93	61	M
	1988.10-	1997.09	MT		F	Estate Engine FE(8V)	GC018029	Outer Joint	44T	28	26	56	89	65	I









		TRANSM	L/R	F/R		G-AP Ref.	PRODUCT	ABS	Technical Specifications								
									YEAR	A	B	C	H	L	P		
<b>MAZDA</b>																	
<b>626 III (GV)</b>																	
2.0 (66 kW)	1988.10-	1997.09	MT		F Estate Engine FE(8V)	GC034082	Outer Joint	44T	28	26	56	94	63	M			
	1988.10-	1997.09	MT		F Estate Engine FE(8V)	GC018031	Outer Joint		26	25	56	93	61	M			
2.0 12V (81 kW)	1987.09-	1990.01	MT		F Estate Engine FE	GC018028	Outer Joint		28	26	56	89	65	I			
	1987.09-	1990.01	MT		F Estate Engine FE	GC034019	Outer Joint		26	21	56	94	56	I			
	1987.09-	1990.01	MT		F Estate Engine FE	GC018029	Outer Joint	44T	28	26	56	89	65	I			
	1987.09-	1990.01	MT		F Estate Engine FE	GC034082	Outer Joint	44T	28	26	56	94	63	M			
	1987.09-	1990.01	AT		F Estate Engine FE	GC034068	Outer Joint	90T	26	25	56	93	61	I			
	1987.09-	1990.01	AT		F Estate Engine FE	GC018031	Outer Joint		26	25	56	93	61	M			
2.0 16V (103 kW)	1988.01-	1992.03	MT		F Estate Engine FE	GC034019	Outer Joint		26	21	56	94	56	I			
	1988.01-	1992.03			F Estate Engine FE	GC034074	Outer Joint	90T	26	25	56	93	61	M			
	1988.01-	1992.03	AT		F Estate Engine FE	GC034068	Outer Joint	90T	26	25	56	93	61	I			
	1988.01-	1992.03	AT		F Estate Engine FE	GC018031	Outer Joint		26	25	56	93	61	M			
2.0 D (44 kW)	1988.09-	1991.07	MT		F Estate Engine RF-N	GC018028	Outer Joint		28	26	56	89	65	I			
	1988.09-	1991.07	MT		F Estate Engine RF-N	GC018029	Outer Joint	44T	28	26	56	89	65	I			
	1988.09-	1991.07	MT		F Estate Engine RF-N	GC034082	Outer Joint	44T	28	26	56	94	63	M			
	1988.09-	1991.07	AT		F Estate Engine RF-N	GC018031	Outer Joint		26	25	56	93	61	M			
2.0 D (60 kW)	1994.11-	1997.09	AT		F Estate Engine RFG5	GC034081	Outer Joint		26	30	56	93	56.5	M			
	1994.11-	1997.09	MT		F Estate Engine RFG5	GC034004	Outer Joint		26	23	56	93.5	56.5	M			
2.0 D Complex (55 kW)	1993.05-	1996.11	MT		F Estate Engine RF-CX	GC034004	Outer Joint		26	23	56	93.5	56.5	M			
2.2 12V (85 kW)	1989.03-	1996.11	MT		F Estate Engine F2	GC018028	Outer Joint		28	26	56	89	65	I			
	1989.03-	1996.11	MT		F Estate Engine F2	GC018029	Outer Joint	44T	28	26	56	89	65	I			
	1989.03-	1996.11	MT		F Estate Engine F2	GC034082	Outer Joint	44T	28	26	56	94	63	M			
	1989.03-	1996.11	AT		F Estate Engine F2	GC018031	Outer Joint		26	25	56	93	61	M			
2.2 12V 4WD (85 kW)	1991.05-	1992.11	MT		F Estate Engine F2/F2L1	GC018028	Outer Joint		28	26	56	89	65	I			
	1991.05-	1992.11	MT		F Estate Engine F2/F2L1	GC018029	Outer Joint	44T	28	26	56	89	65	I			
	1991.05-	1992.11	MT		F Estate Engine F2/F2L1	GC034082	Outer Joint	44T	28	26	56	94	63	M			
	1991.05-	1992.11	AT		F Estate Engine F2/F2L1	GC018031	Outer Joint		26	25	56	93	61	M			
<b>626 IV (CBA,GE)</b>																	
1.8 i 16V (CBA8P) (USA)	1992.01-	1993.12	MT			GC034025	Outer Joint		26	30	56	92.5	57.5	I			
<b>626 IV (GE)</b>																	
1.8 (66 kW)	1994.08-	1997.04			F Hatchback	GC099045	Outer Joint		28	23	56	90	59	M			
	1994.08-	1997.04			F Hatchback	GC034021	Outer Joint	44T	28	23	56	90	59	I			
1.8 (77 kW)	1991.08-	1997.04	MT/AT		F Hatchback Engine FP	GC034021	Outer Joint	44T	28	23	56	90	59	I			
1.8 i (66 kW)	1994.08-	1997.04			F Saloon	GC034021	Outer Joint	44T	28	23	56	90	59	I			
	1994.08-	1997.04			F Saloon	GC099045	Outer Joint		28	23	56	90	59	M			
1.8 i (77 kW)	1992.01-	1997.04			F Saloon Engine FP	GC099045	Outer Joint		28	23	56	90	59	M			
	1992.01-	1997.04	MT/AT		F Saloon Engine FP	GC034021	Outer Joint	44T	28	23	56	90	59	I			
2.0 D GLX Complex (55 kW)	1992.10-	1997.04			F Saloon Engine RFOHC	GC099045	Outer Joint		28	23	56	90	59	M			
	1992.10-	1997.04	MT/AT		F Saloon Engine RFOHC	GC034021	Outer Joint	44T	28	23	56	90	59	I			
	1993.01-	1997.04			F Hatchback Engine RFOHC	GC099045	Outer Joint		28	23	56	90	59	M			
	1993.01-	1997.04	MT/AT		F Hatchback Engine RFOHC	GC034021	Outer Joint	44T	28	23	56	90	59	I			
2.0 i (85 kW)	1991.08-	1997.04			F Hatchback Engine FS	GC099045	Outer Joint		28	23	56	90	59	M			
	1991.08-	1997.04	MT/AT		F Hatchback Engine FS	GC034021	Outer Joint	44T	28	23	56	90	59	I			
	1992.01-	1997.04	MT/AT		F Saloon Engine FS	GC034021	Outer Joint	44T	28	23	56	90	59	I			
2.0 i 4WD (85 kW)	1992.04-	1997.04	MT/AT		Hatchback Engine FS	GC034021	Outer Joint	44T	28	23	56	90	59	I			
	1992.04-	1997.04	MT/AT		Saloon Engine FS	GC034021	Outer Joint	44T	28	23	56	90	59	I			
2.5 24V (120 kW)	1994.08-	1997.04	MT/AT		F Hatchback Engine KL	GC018028	Outer Joint		28	26	56	89	65	I			
	1994.08-	1997.04			F Hatchback Engine KL	GC034087	Outer Joint		26	24	56	93	56.5	M			
	1994.08-	1997.04	MT/AT		F Hatchback Engine KL	GC018029	Outer Joint	44T	28	26	56	89	65	I			
	1994.08-	1997.04	MT/AT		F Hatchback Engine KL	GC034082	Outer Joint	44T	28	26	56	94	63	M			
2.5 24V (121 kW)	1992.01-	1997.04	MT/AT		F Hatchback Engine KL	GC018028	Outer Joint		28	26	56	89	65	I			
	1992.01-	1997.04			F Hatchback Engine KL	GC034087	Outer Joint		26	24	56	93	56.5	M			
	1992.01-	1997.04			F Hatchback Engine KL	GC018073	Outer Joint		28	26	56	89	65	M			
	1992.01-	1997.04			F Hatchback Engine KL	GC034073	Outer Joint	90T	28	26	56	89	65	M			
	1992.01-	1997.04	MT/AT		F Hatchback Engine KL	GC018029	Outer Joint	44T	28	26	56	89	65	I			
	1992.01-	1997.04	MT/AT		F Hatchback Engine KL	GC034082	Outer Joint	44T	28	26	56	94	63	M			
<b>626 MATSURI</b>																	
-						GCI34006	Inner Joint		28	23	35	65.5	104				
						GCI34005	Inner Joint		28	23	42.8	42	76.5				
<b>626 V (GF)</b>																	
1.8 (66 kW)	1997.05-	1999.12	MT/AT		F Hatchback Engine FPY3	GC099042	Outer Joint		28	22	56	89.1	59.5	I			
	1997.05-	1999.12	MT/AT		F Saloon Engine FPY3	GC099042	Outer Joint		28	22	56	89.1	59.5	I			



		YEAR	TRANSM	L/R	F/R		G-AP Ref.	PRODUCT	ABS	Technical Specifications						
										A	B	C	H	L	P	
<b>MAZDA</b>																
<b>626 V (GF)</b>																
1.8 (74 kW)	1999.12-	2002.10			F	Hatchback Engine FP	GC034013	Outer Joint	44T	28	23	56	90	59	M	
	1999.12-	2002.10			F	Saloon Engine FP9A	GC034013	Outer Joint	44T	28	23	56	90	59	M	
	1999.12-	2002.10	MT/AT		F	Hatchback Engine FP	GC034010	Outer Joint		28	30	56	89.5	57	I	
	1999.12-	2002.10	MT/AT		F	Saloon Engine FP9A	GC034010	Outer Joint		28	30	56	89.5	57	I	
2.0 (100 kW)	1998.04-	2002.10			F	Saloon Engine FS2C	GC034013	Outer Joint	44T	28	23	56	90	59	M	
	1998.04-	2002.10	MT/AT		F	Saloon Engine FS2C	GC034010	Outer Joint		28	30	56	89.5	57	I	
2.0 (85 kW)	1997.05-	2002.10			F	Hatchback Engine FS	GC034013	Outer Joint	44T	28	23	56	90	59	M	
	1997.05-	2002.10			F	Saloon Engine FS	GC034013	Outer Joint	44T	28	23	56	90	59	M	
	1997.05-	2002.10	MT/AT		F	Hatchback Engine FS	GC034010	Outer Joint		28	30	56	89.5	57	I	
	1997.05-	2002.10	MT/AT		F	Hatchback Engine FS	GC034072	Outer Joint	44T	28	30	56	89.5	57	I	
	1997.05-	2002.10	MT/AT		F	Saloon Engine FS	GC034010	Outer Joint		28	30	56	89.5	57	I	
	1997.05-	2002.10	MT/AT		F	Saloon Engine FS	GC034072	Outer Joint	44T	28	30	56	89.5	57	I	
2.0 Di TD (66 kW)	1998.04-	2002.10			F	Saloon Engine RF3F	GC034013	Outer Joint	44T	28	23	56	90	59	M	
	1998.04-	2002.10	MT	L	F	Saloon Engine RF3F	GDS18176	Drive Shaft	44T	28	28	56	91.5	629		
2.0 DiTD (66 kW)	1998.04-	2002.10			F	Hatchback Engine RF3F	GC034013	Outer Joint	44T	28	23	56	90	59	M	
2.0 H.P. (100 kW)	1998.02-	2002.10			F	Hatchback Engine FS2C	GC034013	Outer Joint	44T	28	23	56	90	59	M	
	1998.02-	2002.10	MT/AT		F	Hatchback Engine FS2C	GC034010	Outer Joint		28	30	56	89.5	57	I	
2.0 TD (81 kW)	2000.10-	2002.10			F	Hatchback	GC034013	Outer Joint	44T	28	23	56	90	59	M	
	2000.10-	2002.10			F	Saloon	GC034013	Outer Joint	44T	28	23	56	90	59	M	
	2000.10-	2002.10	MT	L	F	Hatchback	GDS18176	Drive Shaft	44T	28	28	56	91.5	629		
	2000.10-	2002.10	MT	L	F	Saloon	GDS18176	Drive Shaft	44T	28	28	56	91.5	629		
2.0 Turbo Di (74 kW)	1998.04-	2002.10			F	Hatchback	GC034013	Outer Joint	44T	28	23	56	90	59	M	
	1998.04-	2002.10			F	Saloon	GC034013	Outer Joint	44T	28	23	56	90	59	M	
	1998.04-	2002.10	MT		F	Hatchback	GC034080	Outer Joint	44T	28	23	56	90	59	M	
	1998.04-	2002.10	MT		F	Saloon	GC034080	Outer Joint	44T	28	23	56	90	59	M	
	1998.04-	2002.10	MT	L	F	Saloon	GDS18176	Drive Shaft	44T	28	28	56	91.5	629		
<b>626 V (GW)</b>																
1.8 (74 kW)	2000.01-	2002.10			F	Estate Engine FP9A	GC034013	Outer Joint	44T	28	23	56	90	59	M	
	2000.01-	2002.10	MT/AT		F	Estate Engine FP9A	GC034010	Outer Joint		28	30	56	89.5	57	I	
	2000.01-	2002.10				Estate Engine FP9A	GC059055	Outer Joint		26	25	56	96	56	M	
2.0 (85 kW)	1998.02-	2002.10			F	Estate Engine FS	GC034013	Outer Joint	44T	28	23	56	90	59	M	
	1998.02-	2002.10	MT/AT		F	Estate Engine FS	GC034010	Outer Joint		28	30	56	89.5	57	I	
2.0 DiTD (66 kW)	1999.09-	2002.10			F	Estate Engine RF3F	GC034013	Outer Joint	44T	28	23	56	90	59	M	
2.0 H.P. (100 kW)	1998.02-	2002.10			F	Estate Engine FS2C	GC034013	Outer Joint	44T	28	23	56	90	59	M	
	1998.02-	2002.10	MT/AT		F	Estate Engine FS2C	GC034010	Outer Joint		28	30	56	89.5	57	I	
2.0 TD (81 kW)	2000.10-	2002.10			F	Estate	GC034013	Outer Joint	44T	28	23	56	90	59	M	
	2000.10-	2002.10	MT	L	F	Estate	GDS18176	Drive Shaft	44T	28	28	56	91.5	629		
2.0 Turbo Di (74 kW)	1998.04-	2002.10			F	Estate Engine RF4F	GC034013	Outer Joint	44T	28	23	56	90	59	M	
	1998.04-	2002.10	MT		F	Estate Engine RF4F	GC034080	Outer Joint	44T	28	23	56	90	59	M	
	1998.04-	2002.10	MT	L	F	Estate Engine RF4F	GDS18176	Drive Shaft	44T	28	28	56	91.5	629		
<b>ATENZA (GH5AP)</b>																
2.5 4WD	2007.12-		6AT		F	Engine L5-VE	GC034173	Outer Joint		28	33	62	90	58	M	
<b>ATENZA (GH5AS)</b>																
2.5 4WD	2007.12-		6AT		F	Engine L5-VE	GC034173	Outer Joint		28	33	62	90	58	M	
<b>ATENZA (GH5FP)</b>																
2.5	2007.12-		5AT		F	Engine L5-VE	GC034173	Outer Joint		28	33	62	90	58	M	
<b>ATENZA (GH5FS)</b>																
2.5	2007.12-		5AT		F	Engine L5-VE	GC034173	Outer Joint		28	33	62	90	58	M	
	2007.12-		6MT		F	Engine L5-VE	GC034173	Outer Joint		28	33	62	90	58	M	
<b>ATENZA (GHEFP)</b>																
2.0	2007.12-		5AT		F	Engine LF-VE	GC034173	Outer Joint		28	33	62	90	58	M	
<b>ATENZA (GHEFS)</b>																
2.0	2007.12-		5AT		F	Engine LF-VE	GC034173	Outer Joint		28	33	62	90	58	M	
<b>ATENZA SPORT WAGON (GH5AW)</b>																
2.5 4WD	2007.12-		6AT		F	Engine L5-VE	GC034173	Outer Joint		28	33	62	90	58	M	
<b>ATENZA SPORT WAGON (GH5FW)</b>																
2.5	2007.12-		5AT		F	Engine L5-VE	GC034173	Outer Joint		28	33	62	90	58	M	
	2007.12-		6MT		F	Engine L5-VE	GC034173	Outer Joint		28	33	62	90	58	M	
<b>ATENZA SPORT WAGON (GHEFW)</b>																
2.0	2007.12-		5AT		F	Engine LF-VE	GC034173	Outer Joint		28	33	62	90	58	M	

	 YEAR	TRANSM	L/R	F/R		G-AP Ref.	PRODUCT	ABS	Technical Specifications					
									A	B	C	H	L	P
<b>MAZDA</b>														
<b>ATENZA SPORT WAGON (GY3W)</b>														
2.3	2002.05-2007.12	5MT			Engine L3-VE	GC034180	Outer Joint	44T	28	33	62	90	58	I
	2002.05-2007.12	6MT			Engine L3-VE	GC034180	Outer Joint	44T	28	33	62	90	58	I
	2002.06-2007.12	4AT/F			Engine L3-VE	GC034110	Outer Joint	44T	28	32	62	90	57.5	I
2.3 4WD	2002.08-2007.12	5AT/F			Engine L3-VE	GC034110	Outer Joint	44T	28	32	62	90	57.5	I
<b>ATENZA SPORT WAGON (GYEW)</b>														
2.0	2002.06-2005.05	4AT/F			Engine LF-DE	GC034110	Outer Joint	44T	28	32	62	90	57.5	I
	2002.06-2007.12	5AT/F			Engine LF-VE	GC034110	Outer Joint	44T	28	32	62	90	57.5	I
<b>AXELA</b>														
-	2003-2009					GCI34049	Inner Joint		28	24	35	67	115	
<b>AZ-3 (ECPSA)</b>														
1.8	1993.09-1998.01	4AT			Engine K8	GC034009	Outer Joint		26	30	56	93	55	M
	1993.09-1998.01	5MT			Engine K8	GC034009	Outer Joint		26	30	56	93	55	M
<b>B-SERIE (UN)</b>														
2.5 D (62 kW)	2002.12-			R	Pickup Engine WLE7	GC027017	Outer Joint		26	25	61	103.5	75.5	M
2.5 D 4WD (61 kW)	1999.11-2001.12		L	F	Pickup Engine WLE7	GDS27063	Drive Shaft	44W	26	26	61	103.5	509	
	1999.11-2001.12	MT	L	F	Pickup Engine WLE7	GDS39001	Drive Shaft		26	26	65	143.5	527	
	1999.11-2001.12	MT	L	F	Pickup Engine WLE7	GCI34011	Inner Joint		26	25	40	39	81	
	1999.11-2001.12	MT	L	F	Pickup Engine WLE7	GC034056	Outer Joint		26	25	65	143.5	60.5	M
	1999.11-2001.12		L	F	Pickup Engine WLE7	GCI34018	Inner Joint		26	25	40	39	68	
	1999.11-2001.12		L/R	F	Pickup Engine WLE7	GC034067	Outer Joint	44W	26	25	61	103.5	75.5	M
	1999.11-2001.12		R	F	Pickup Engine WLE7	GDS27062	Drive Shaft	44W	26	26	61	103.5	579.5	
	1999.11-2001.12	MT	R	F	Pickup Engine WLE7	GDS34012	Drive Shaft		26	26	65	143.5	606	
	1999.11-2001.12		R	F	Pickup Engine WLE7	GCI34019	Inner Joint		26	25	35	82.5	95.5	
2.5 D 4WD (62 kW)	2002.12-				Pickup Engine WLE7	GC027017	Outer Joint		26	25	61	103.5	75.5	M
	2002.12-			F	Pickup Engine WLE7	GC034056	Outer Joint		26	25	65	143.5	60.5	M
	2002.12-		L	F	Pickup Engine WLE7	GDS27063	Drive Shaft	44W	26	26	61	103.5	509	
	2002.12-		L	F	Pickup Engine WLE7	GCI34018	Inner Joint		26	25	40	39	68	
	2002.12-		L/R	F	Pickup Engine WLE7	GC034067	Outer Joint	44W	26	25	61	103.5	75.5	M
	2002.12-		R	F	Pickup Engine WLE7	GDS27062	Drive Shaft	44W	26	26	61	103.5	579.5	
2.5 TD 4WD (80 kW)	1999.06-2006.07		L	F	Pickup Engine MD25TI	GDS27063	Drive Shaft	44W	26	26	61	103.5	509	
	1999.06-2006.07		L	F	Pickup Engine MD25TI	GCI34018	Inner Joint		26	25	40	39	68	
	1999.06-2006.07		L/R	F	Pickup Engine MD25TI	GC034067	Outer Joint	44W	26	25	61	103.5	75.5	M
	1999.06-2006.07		R	F	Pickup Engine MD25TI	GDS27062	Drive Shaft	44W	26	26	61	103.5	579.5	
	1999.06-2006.07		R	F	Pickup Engine MD25TI	GCI34019	Inner Joint		26	25	35	82.5	95.5	
<b>B2500</b>														
2.5 D 4WD	2002-2006		L	F		GDS34132	Drive Shaft	44W	26	26	61	103.5	510	
	2002-2006		R	F		GDS34133	Drive Shaft	44W	26	26	61	103.5	579	
<b>B2500 B2600 B3000 B4000</b>														
-	1998-2000				SUV/Truck/VAN 4WD	GC018037	Outer Joint		27	34	66.8	115	66	I
<b>B2600</b>														
-	1988.01-1998.12		R			GDS34019	Drive Shaft		26	26	65	143.5	606	
<b>B2600 / BRAVO</b>														
-						GCI34019	Inner Joint		26	25	35	82.5	95.5	
<b>BONGO</b>														
-						GC099046	Outer Joint		26	23	56	101	59.5	I
<b>BONGO BRAWNY TRUCK (SK2)</b>														
2.2 4WD	1999.07-	5MT			Engine R2	GC034017	Outer Joint		26	23	65	148.5	57	M
<b>BONGO BRAWNY TRUCK (SK5)</b>														
2.5 4WD	1999.07-	5MT			Engine WL	GC034017	Outer Joint		26	23	65	148.5	57	M
<b>BONGO BRAWNY VAN (SK5)</b>														
2.5 4WD	1999.07-	MT/AT			Engine WL	GC034017	Outer Joint		26	23	65	148.5	57	M
<b>BONGO FRIENDEE MPV (SG)</b>														
2.0 i (74 kW)	1999.08-2001.10			F	MPV Engine FE(12V)	GC034069	Outer Joint	44T	26	23	56	101	59.5	I
<b>BONGO J80 / 100 (SD29M)</b>														
2.2 4WD	1987.09-1997.03	5MT			Engine R2	GC034017	Outer Joint		26	23	65	148.5	57	M
<b>BONGO J80 / 100 (SD5)</b>														
2.5 4WD	1997.04-1999.07	5MT			Engine WL	GC034017	Outer Joint		26	23	65	148.5	57	M
<b>BONGO J80 / 100 (SE28)</b>														
2.2 4WD	1987.09-1995.08	5MT			Engine R2	GC034017	Outer Joint		26	23	65	148.5	57	M









		YEAR	TRANSM	L/R	F/R		G-AP Ref.	PRODUCT	ABS	Technical Specifications						
										A	B	C	H	L	P	
<b>MAZDA</b>																
<b>BONGO J80 / 100 (SE88M)</b>																
1.8 4WD	1985.09-	1997.03	5MT			Engine F8	GC034017	Outer Joint			26	23	65	148.5	57	M
<b>BONGO J80 / 100 (SR2AM)</b>																
2.2 4WD	1987.09-	1997.03	5MT			Engine R2	GC034017	Outer Joint			26	23	65	148.5	57	M
<b>BONGO J80 / 100 (SS28)</b>																
2.2 4WD	1985.08-	1997.03	5MT			Engine R2	GC034017	Outer Joint			26	23	65	148.5	57	M
	1986.11-	1995.08	MT/AT			Engine R2	GC034017	Outer Joint			26	23	65	148.5	57	M
<b>BONGO J80 / 100 (SS88M)</b>																
1.8 4WD	1984.10-	1997.03	5MT			Engine F8	GC034017	Outer Joint			26	23	65	148.5	57	M
<b>BONGO J80 / 100 (SSE8R)</b>																
2.0 4WD	1986.11-	1995.09	5MT			Engine FE	GC034017	Outer Joint			26	23	65	148.5	57	M
<b>BONGO J80 / 100 (SSF8R)</b>																
2.0 4WD	1989.01-	1995.08	MT/AT			Engine RF TBO	GC034017	Outer Joint			26	23	65	148.5	57	M
	1995.08-	1997.03	MT/AT			Engine RF	GC034017	Outer Joint			26	23	65	148.5	57	M
<b>BONGO TRUCK (SK22)</b>																
2.2 4WD	1999.06-		MT/AT			Engine R2	GC034017	Outer Joint			26	23	65	148.5	57	M
<b>BONGO TRUCK (SK82)</b>																
1.8 4WD	1999.06-		5MT			Engine F8-E	GC034017	Outer Joint			26	23	65	148.5	57	M
<b>BONGO VAN (SK22)</b>																
2.2 4WD	1999.06-		MT/AT			Engine R2	GC034017	Outer Joint			26	23	65	148.5	57	M
<b>BONGO VAN (SK82)</b>																
1.6 4WD	1999.06-		MT/AT			Engine F8-E	GC034017	Outer Joint			26	23	65	148.5	57	M
<b>BRAVO</b>																
-	1988.01-	1998.12			R		GDS34019	Drive Shaft			26	26	65	143.5	606	
<b>BT-50 (CD, UN)</b>																
2.5 CDVi (105 kW)	2006.12-					Platform/Chassis Engine WLAT (16 V)	GC018206	Outer Joint	44W		28	36	61	104.5	78.5	I
3.0 CDVi (115 kW)	2006.12-					Pickup Engine WEAT	GC018206	Outer Joint	44W		28	36	61	104.5	78.5	I
<b>CAPELLA 626</b>																
2.5	1991-		MT			Engine GE5P	GCI18012	Inner Joint			28	26	43	44	80	
<b>CAPELLA 626 TELSTER (CG2PP)</b>																
1.8	1994.07-	1997.08	MT/AT			Engine FP	GC034014	Outer Joint			28	23	56	89.1	59.5	M
	1994.07-	1997.08	4AT			Engine FP	GC034145	Outer Joint	44T		28	23	56	89.1	59.5	M
	1994.07-	1997.08	5MT			Engine FP	GC034145	Outer Joint	44T		28	23	56	89.1	59.5	M
	1994.07-	1997.08	MT/AT			Engine FP	GC034145	Outer Joint	44T		28	23	56	89.1	59.5	M
	1994.07-	1997.08	4AT			Engine FP	GC034014	Outer Joint			28	23	56	89.1	59.5	M
	1994.07-	1997.08	5MT			Engine FP	GC034014	Outer Joint			28	23	56	89.1	59.5	M
<b>CAPELLA 626 TELSTER (CG2SP)</b>																
2.0	1994.07-	1997.08	4AT			Engine FS	GC034014	Outer Joint			28	23	56	89.1	59.5	M
	1994.07-	1997.08	5MT			Engine FS	GC034014	Outer Joint			28	23	56	89.1	59.5	M
	1994.07-	1997.08	MT/AT			Engine FS	GC034014	Outer Joint			28	23	56	89.1	59.5	M
	1994.07-	1997.08	4AT			Engine FS	GC034145	Outer Joint	44T		28	23	56	89.1	59.5	M
	1994.07-	1997.08	5MT			Engine FS	GC034145	Outer Joint	44T		28	23	56	89.1	59.5	M
	1994.07-	1997.08	MT/AT			Engine FS	GC034145	Outer Joint	44T		28	23	56	89.1	59.5	M
1994.08-	1997.08	5MT			Engine FS-DE	GC034145	Outer Joint	44T		28	23	56	89.1	59.5	M	
<b>CAPELLA 626 TELSTER (GD8R)</b>																
1.8 4WD	1989.04-	1991.10	4AT			Engine F8	GC034016	Outer Joint			26	21	56	93.5	55	M
	1989.04-	1991.10	5MT			Engine F8	GC034016	Outer Joint			26	21	56	93.5	55	M
<b>CAPELLA 626 TELSTER (GDEA B)</b>																
2.0 4WS	1987.05-	1991.10	4AT			Engine FE	GC034011	Outer Joint			26	25	56	95	61	M
	1987.05-	1991.10	5MT			Engine FE	GC034011	Outer Joint			26	25	56	95	61	M
<b>CAPELLA 626 TELSTER (GDEPS)</b>																
2.0	1987.01-	1991.01	MT&AT			Engine FE	GC034011	Outer Joint			26	25	56	95	61	M
	1987.05-	1991.10	4AT			Engine FE	GC034011	Outer Joint			26	25	56	95	61	M
	1987.05-	1991.10	5MT			Engine FE	GC034011	Outer Joint			26	25	56	95	61	M
	1989.04-	1991.10	4AT			Engine FE	GC034016	Outer Joint			26	21	56	93.5	55	M
<b>CAPELLA 626 TELSTER (GDER)</b>																
2.0 4WD	1989.04-	1991.10	4AT			Engine FE	GC034016	Outer Joint			26	21	56	93.5	55	M
	1989.04-	1991.10	5MT			Engine FE	GC034016	Outer Joint			26	21	56	93.5	55	M
<b>CAPELLA 626 TELSTER (GDFFP)</b>																
2.0	1987.07-	1991.10	5MT			Engine RF	GC034011	Outer Joint			26	25	56	95	61	M
<b>CAPELLA 626 TELSTER (GE8P)</b>																
1.8	1991.10-		MT&AT			Engine K8	GC034014	Outer Joint			28	23	56	89.1	59.5	M



		TRANSM	L/R	F/R		G-AP Ref.	PRODUCT	ABS	Technical Specifications								
									YEAR	A	B	C	H	L	P		
<b>MAZDA</b>																	
<b>CAPELLA 626 TELSTER (GEEP)</b>																	
2.0	1991.10-		MT&AT		Engine KF	GC034014	Outer Joint		28	23	56	89.1	59.5	M			
<b>CAPELLA 626 TELSTER (GEFP)</b>																	
2.0	1992.04-	1994.07	5MT		Engine RF	GC034014	Outer Joint		28	23	56	89.1	59.5	M			
	1992.04-	1995.10	4AT		Engine RF	GC034014	Outer Joint		28	23	56	89.1	59.5	M			
	1992.04-	1994.07	5MT		Engine RF	GC034145	Outer Joint	44T	28	23	56	89.1	59.5	M			
	1992.04-	1995.10	4AT		Engine RF	GC034145	Outer Joint	44T	28	23	56	89.1	59.5	M			
<b>CAPELLA 626 TELSTER (GF)</b>																	
1.8	1998.01-		MT/AT		Engine GE9E	GC034044	Outer Joint		28	30	56	89.1	59.5	M			
<b>CAPELLA 626 TELSTER (GF8P)</b>																	
1.8	1997.08-	2002.05	4AT		Engine FP-DE	GC034121	Outer Joint	44T	28	23	56	89.1	59.5	M			
<b>CAPELLA 626 TELSTER (GFEP)</b>																	
2.0	1997.08-	1999.08	4AT		Engine FS	GC034145	Outer Joint	44T	28	23	56	89.1	59.5	M			
	1997.08-	1999.09	4AT		Engine FS-ZE	GC034145	Outer Joint	44T	28	23	56	89.1	59.5	M			
	1999.09-	2002.05	4AT		Engine FS-ZE	GC034121	Outer Joint	44T	28	23	56	89.1	59.5	M			
<b>CAPELLA 626 TELSTER (GFER)</b>																	
2.0 4WD	1997.08-	2002.05	4AT		Engine FS-DE	GC034120	Outer Joint	44T	28	22	56	89.1	59.5	M			
<b>CAPELLA TELSTER CARGO / WAGO (GFFP)</b>																	
2.0	1998.07-	1999.09	4AT		Engine RF	GC034145	Outer Joint	44T	28	23	56	89.1	59.5	M			
<b>CAPELLA TELSTER CARGO / WAGO (GV8W)</b>																	
1.8	1988.01-		4AT		Engine F8	GC034011	Outer Joint		26	25	56	95	61	M			
	1988.01-		5MT		Engine F8	GC034011	Outer Joint		26	25	56	95	61	M			
<b>CAPELLA TELSTER CARGO / WAGO (GVER)</b>																	
2.0 4WD	1990.08-	1994.10	4AT		Engine FE	GC034016	Outer Joint		26	21	56	93.5	55	M			
<b>CAPELLA TELSTER CARGO / WAGO (GVFR)</b>																	
2.0 4WD	1992.08-	1994.10	4AT		Engine RF DSC	GC034016	Outer Joint		26	21	56	93.5	55	M			
<b>CAPELLA TELSTER CARGO / WAGO (GVFV)</b>																	
2.0	1989.05-	1994.10	4AT		Engine RF	GC034011	Outer Joint		26	25	56	95	61	M			
	1989.05-	1994.10	5MT		Engine RF	GC034011	Outer Joint		26	25	56	95	61	M			
<b>CAPELLA TELSTER CARGO / WAGO (GW5R)</b>																	
2.5 4WD	1997.11-	2002.05	MT/AT		Engine KL-ZE	GC034120	Outer Joint	44T	28	22	56	89.1	59.5	M			
<b>CAPELLA TELSTER CARGO / WAGO (GW8W)</b>																	
1.8	1997.10-	2002.05	4AT		Engine FP-DE	GC034121	Outer Joint	44T	28	23	56	89.1	59.5	M			
<b>CAPELLA TELSTER CARGO / WAGO (GWEW)</b>																	
2.0	1997.10-	1999.08	4AT		Engine FS-DE	GC034145	Outer Joint	44T	28	23	56	89.1	59.5	M			
<b>CAPRLLA 626 TELSTER (GE5P)</b>																	
2.5	1992.04-	1996.01	4AT		Engine KL	GC034012	Outer Joint		28	26	56	94	63	M			
<b>CAPRLLA 626 TELSTER (GE5PF)</b>																	
2.5	1992.04-	1996.01	4AT		Engine KL	GC034012	Outer Joint		28	26	56	94	63	M			
<b>CLEF (GE5PA)</b>																	
2.5	1992.04-		4AT		Engine KL	GC034012	Outer Joint		28	26	56	94	63	M			
<b>CLEF (GEEPA)</b>																	
2.0	1992.04-		4AT		Engine KF	GC034014	Outer Joint		28	23	56	89.1	59.5	M			
<b>CRONOS (GE5P)</b>																	
2.5	1992.04-	1996.04	4AT		Engine KL	GC034012	Outer Joint		28	26	56	94	63	M			
<b>CRONOS (GE8P)</b>																	
1.8	1991.09-	1994.07	4AT		Engine K8	GC034014	Outer Joint		28	23	56	89.1	59.5	M			
	1991.09-	1994.07	5MT		Engine K8	GC034014	Outer Joint		28	23	56	89.1	59.5	M			
	1991.09-	1994.07	4AT		Engine K8	GC034145	Outer Joint	44T	28	23	56	89.1	59.5	M			
	1991.09-	1994.07	5MT		Engine K8	GC034145	Outer Joint	44T	28	23	56	89.1	59.5	M			
<b>CRONOS (GEEP)</b>																	
2.0	1991.09-	1996.04	4AT		Engine KF	GC034014	Outer Joint		28	23	56	89.1	59.5	M			
	1991.09-	1996.04	5MT		Engine KF	GC034014	Outer Joint		28	23	56	89.1	59.5	M			
	1991.09-	1996.04	4AT		Engine KF	GC034145	Outer Joint	44T	28	23	56	89.1	59.5	M			
	1991.09-	1996.04	5MT		Engine KF	GC034145	Outer Joint	44T	28	23	56	89.1	59.5	M			
<b>CRONOS (GEFP)</b>																	
2.0	1992.04-	1996.04	4AT		Engine RF	GC034014	Outer Joint		28	23	56	89.1	59.5	M			
	1992.04-	1996.04	5MT		Engine RF	GC034014	Outer Joint		28	23	56	89.1	59.5	M			
	1992.04-	1996.04	4AT		Engine RF	GC034145	Outer Joint	44T	28	23	56	89.1	59.5	M			
	1992.04-	1996.04	5MT		Engine RF	GC034145	Outer Joint	44T	28	23	56	89.1	59.5	M			
<b>CRONOS (GESR)</b>																	
2.0 4WD	1991.11-	1996.04	5MT		Engine FS	GC034016	Outer Joint		26	21	56	93.5	55	M			

		YEAR	TRANSM	L/R	F/R		G-AP Ref.	PRODUCT	ABS	Technical Specifications										
										A	B	C	H	L	P					
<b>MAZDA</b>																				
<b>DEMIO (DE3AS)</b>																				
1.3 4WD	2008.11-	2011.04	4AT			Engine ZJ-VE	GC034181	Outer Joint			25	29	53.8	89	51.5	I				
<b>DEMIO (DE3FS)</b>																				
1.3	2008.11-	2011.04	4AT			Engine ZJ-VE	GC034181	Outer Joint			25	29	53.8	89	51.5	I				
	2008.11-	2011.04	5MT			Engine ZJ-VE	GC034181	Outer Joint			25	29	53.8	89	51.5	I				
	2008.11-	2011.04	CVT			Engine ZJ-VEM	GC034181	Outer Joint			25	29	53.8	89	51.5	I				
<b>DEMIO (DE5FS)</b>																				
1.5	2008.11-	2011.04	5MT			Engine ZY-VE	GC034181	Outer Joint			25	29	53.8	89	51.5	I				
	2008.11-	2011.04	CVT			Engine ZY-VE	GC034181	Outer Joint			25	29	53.8	89	51.5	I				
<b>DEMIO (DEJFS)</b>																				
1.3	2011.04-		CVT			Engine P3-PVS	GC034181	Outer Joint			25	29	53.8	89	51.5	I				
<b>DEMIO (DW)</b>																				
1.5 16V (55 kW)	2000.04-	2003.07	MT		F	Estate Engine B5E	GC018036	Outer Joint			24	19	52	86	50	M				
<b>EUNOS 100 (BG8PE)</b>																				
1.8	1989.10-	1994.06	4AT			Engine BP	GC034009	Outer Joint			26	30	56	93	55	M				
	1989.10-	1994.06	5MT			Engine BP	GC034009	Outer Joint			26	30	56	93	55	M				
<b>EUNOS 300 (MAEPE)</b>																				
2.0	1989.11-	1992.01	MT/AT			Engine FE	GC034011	Outer Joint			26	25	56	95	61	M				
<b>EUNOS 500 (CA8P)</b>																				
1.8	1991.12-	1994.02	5MT			Engine K8	GC034014	Outer Joint			28	23	56	89.1	59.5	M				
	1991.12-	1994.03	4AT			Engine K8	GC034014	Outer Joint			28	23	56	89.1	59.5	M				
	1991.12-	1994.02	5MT			Engine K8	GC034145	Outer Joint	44T		28	23	56	89.1	59.5	M				
	1991.12-	1994.03	4AT			Engine K8	GC034145	Outer Joint	44T		28	23	56	89.1	59.5	M				
<b>EUNOS 500 (CAEP)</b>																				
2.0	1991.12-	1994.03	4AT			Engine KF	GC034014	Outer Joint			28	23	56	89.1	59.5	M				
	1991.12-	1995.12	5MT			Engine KF	GC034014	Outer Joint			28	23	56	89.1	59.5	M				
	1991.12-	1994.03	4AT			Engine KF	GC034145	Outer Joint	44T		28	23	56	89.1	59.5	M				
	1991.12-	1995.12	5MT			Engine KF	GC034145	Outer Joint	44T		28	23	56	89.1	59.5	M				
<b>EUNOS 500 (CAPP)</b>																				
1.8	1994.02-	1995.12	4AT			Engine FP	GC034014	Outer Joint			28	23	56	89.1	59.5	M				
	1994.02-	1995.12	5MT			Engine FP	GC034014	Outer Joint			28	23	56	89.1	59.5	M				
	1994.02-	1995.12	4AT			Engine FP	GC034145	Outer Joint	44T		28	23	56	89.1	59.5	M				
	1994.02-	1995.12	5MT			Engine FP	GC034145	Outer Joint	44T		28	23	56	89.1	59.5	M				
<b>EUNOS 800 (MILLERCYCLE)</b>																				
-							GC034057	Outer Joint			31	26	62	95	65	I				
<b>EUNOS 800 (TA5)</b>																				
2.5	1993.09-	2000.07	4AT			Engine KL	GC034012	Outer Joint			28	26	56	94	63	M				
<b>EUNOS PRESSO (EC8S)</b>																				
1.8	1991.04-	1998.01	4AT			Engine K8	GC034009	Outer Joint			26	30	56	93	55	M				
	1991.04-	1998.01	5MT			Engine K8	GC034009	Outer Joint			26	30	56	93	55	M				
<b>FAMILIA 323</b>																				
1.3	1989-	1990	AT				GCI34017	Inner Joint			24	21	35	64	97.5					
1.5	1989-	1990	AT				GCI34017	Inner Joint			24	21	35	64	97.5					
	1989-	1990	MT/AT				GCI34028	Inner Joint			24	22	35	64	94					
1.6	1989-	1990	AT				GCI34017	Inner Joint			24	21	35	64	97.5					
	1989-	1990	MT/AT				GCI34028	Inner Joint			24	22	35	64	94					
1.7	1989-	1990	AT				GCI34017	Inner Joint			24	21	35	64	97.5					
<b>FAMILIA 323 LASER (BF3TP)</b>																				
1.3	1984.01-	1989.01	MT			Engine B3	GC034018	Outer Joint			24	21	52	86	50	M				
<b>FAMILIA 323 LASER (BG8PSP)</b>																				
1.8	1990.11-	1994.04	4AT			Engine BP	GC034009	Outer Joint			26	30	56	93	55	M				
<b>FAMILIA 323 LASER (BG8SP)</b>																				
1.8	1990.03-	1994.04	5MT			Engine BP	GC034009	Outer Joint			26	30	56	93	55	M				
<b>FAMILIA 323 LASER (BHA6R)</b>																				
1.6 4WD	1994.09-	1998.06	5MT			Engine B6	GC034016	Outer Joint			26	21	56	93.5	55	M				
	1994.10-		MT/AT			Engine B6	GC034016	Outer Joint			26	21	56	93.5	55	M				
<b>FAMILIA 323 LASER (BHA7P)</b>																				
1.7	1994.09-	1998.06	5MT			Engine 4EE1 TBO	GC034009	Outer Joint			26	30	56	93	55	M				
	1994.10-		4AT			Engine 4EE1 TBO	GC034009	Outer Joint			26	30	56	93	55	M				
	1994.10-		MT/AT			Engine 4EE1 TBO	GC034009	Outer Joint			26	30	56	93	55	M				
<b>FAMILIA 323 LASER (BHA7R)</b>																				
1.7 4WD	1994.09-	1998.06	5MT			Engine 4EE1 TBO	GC034016	Outer Joint			26	21	56	93.5	55	M				









		TRANSM	L/R	F/R		G-AP Ref.	PRODUCT	ABS	Technical Specifications										
									YEAR	A	B	C	H	L	P				
<b>MAZDA</b>																			
<b>FAMILIA 323 LASER (BHA8PS)</b>																			
1.8	1994.05-				Engine BP	GC034009	Outer Joint		26	30	56	93	55	M					
	1994.06-1998.06	MT/AT			Engine BP	GC034009	Outer Joint		26	30	56	93	55	M					
<b>FAMILIA 323 LASER (BJFW)</b>																			
2.0 4WD	1999.08-	2002.08	MT/AT		Engine FS-ZE	GC034020	Outer Joint		26	28	56	93.1	53	M					
<b>FAMILIA VAN / WAGON LASER VAN (1BF3V)</b>																			
1.3	1985.11-	1994.08	MT		Engine E3	GC034018	Outer Joint		24	21	52	86	50	M					
<b>FAMILIA VAN / WAGON LASER VAN (2BW3W)</b>																			
1.3	1989.10-	1994.08	5MT		Engine E3	GC034018	Outer Joint		24	21	52	86	50	M					
<b>FAMILIA VAN / WAGON LASER VAN (3BVSY10)</b>																			
1.7	1994.08-	1999.06	4AT		Engine CD17	GC034024	Outer Joint		25	22	55	107	57	M					
	1994.08-	1999.06	5MT		Engine CD17	GC034024	Outer Joint		25	22	55	107	57	M					
<b>FAMILIA VAN / WAGON LASER VAN (3BVY10)</b>																			
1.3	1994.08-	1999.06	4AT		Engine GA13DS E	GC034024	Outer Joint		25	22	55	107	57	M					
	1994.08-	1999.06	5MT		Engine GA13DS E	GC034024	Outer Joint		25	22	55	107	57	M					
<b>FAMILIA VAN / WAGON LASER VAN (BVFY10)</b>																			
1.5	1994.08-	1999.06	4AT		Engine GA15DS E	GC034024	Outer Joint		25	22	55	107	57	M					
<b>FAMILIA VAN / WAGON LASER VAN (BWE / BVE Y10)</b>																			
2.0	1994.08-	1999.06	4AT		Engine CD20	GC034024	Outer Joint		25	22	55	107	57	M					
<b>FAMILIA VAN / WAGON LASER VAN (BWFY10)</b>																			
1.5	1994.08-	1995.06	4AT		Engine GA15DS E	GC034024	Outer Joint		25	22	55	107	57	M					
	1994.08-	1999.06	5MT		Engine GA15DS E	GC034024	Outer Joint		25	22	55	107	57	M					
<b>FESTIVA (D23PF)</b>																			
1.3	1992.11-	1997.10	4AT		Engine B3	GC034018	Outer Joint		24	21	52	86	50	M					
	1992.11-	1997.10	5MT		Engine B3	GC034018	Outer Joint		24	21	52	86	50	M					
<b>FESTIVA (D25PF)</b>																			
1.3	1992.11-	1997.10	4AT		Engine B3	GC034018	Outer Joint		24	21	52	86	50	M					
1.5	1992.11-	1994.09	MT/AT		Engine B5	GC034018	Outer Joint		24	21	52	86	50	M					
	1992.11-	1997.10	4AT		Engine B5	GC034018	Outer Joint		24	21	52	86	50	M					
	1994.09-	1997.10	5MT		Engine B5	GC034018	Outer Joint		24	21	52	86	50	M					
<b>FESTIVA (DA3PF)</b>																			
1.3	1986.11-	1993.01	4MT		Engine B3	GC034018	Outer Joint		24	21	52	86	50	M					
<b>FESTIVA (DAJPF)</b>																			
1.3	1986.10-	1993.01	5MT		Engine BJ	GC034018	Outer Joint		24	21	52	86	50	M					
<b>GLC</b>																			
-	1981-	1986				GCI18006	Inner Joint		24	22	35	64	98.5						
<b>IXION (CP8WF)</b>																			
1.8	1999.04-	2004.12	4AT/C		Engine FP-DE	GC034123	Outer Joint	44T	26	29	56	92	56	I					
1.8 4WD	1999.04-	2004.12	4AT/C		Engine FP-DE	GC034124	Outer Joint	44T	26	28	56	93.1	53	M					
<b>LANTIS</b>																			
-						GC034075	Outer Joint	44T	26	24	56	92	60	M					
	1999-				ON (Small Hole)	GC034059	Outer Joint	44T	26	28	56	93.5	53	I					
2.0	1993-		MT/AT		KF	GC027022	Outer Joint		26	24	56	92	60	M					
<b>LANTIS (CBA)</b>																			
1.8 i 16V (CBA8P)	1993.08-		MT			GC034025	Outer Joint		26	30	56	92.5	57.5	I					
<b>LANTIS (CBA8P)</b>																			
1.8	1993.08-	1997.06	4AT		Engine BP	GC034009	Outer Joint		26	30	56	93	55	M					
	1993.08-	1997.06	5MT		Engine BP	GC034009	Outer Joint		26	30	56	93	55	M					
	1993.08-	1997.06	MT/AT		Engine BP	GC034009	Outer Joint		26	30	56	93	55	M					
<b>LASER (FORD)FIESTA</b>																			
1.8	1990-		MT		BG8PE BP	GCI88013	Inner Joint		26	30	43	41	72						
	1990-		MT		BG8PE BP	GCI34007	Inner Joint		26	30	35	66.7	99.5						
<b>MAZDA 3</b>																			
2.0 4WD	2006.05-	2009.04	4AT		Engine LF-VE	GC034177	Outer Joint		28	24	58.6	90	60	M					
<b>MAZDA 3 (BK3P)</b>																			
2.3	2006.05-	2009.04	5AT		Engine L3-VE	GC034174	Outer Joint		28	23	58.6	90	59	M					
	2006.05-		6MT		Engine L3-VDT	GC034178	Outer Joint		28	26	58.6	92	64	M					
<b>MAZDA 3 (BK5P)</b>																			
1.5	2006.05-	2009.04	4AT		Engine ZY-VE	GC034174	Outer Joint		28	23	58.6	90	59	M					
	2006.05-	2009.04	5MT		Engine ZY-VE	GC034174	Outer Joint		28	23	58.6	90	59	M					
<b>MAZDA 3 (BK6P)</b>																			
2.0	2006.05-	2009.04	5AT		Engine LF-VE	GC034174	Outer Joint		28	23	58.6	90	59	M					

		TRANSM	L/R	F/R		G-AP Ref.	PRODUCT	ABS	Technical Specifications									
									YEAR	A	B	C	H	L	P			
<b>MAZDA</b>																		
<b>MILLENNIA</b>																		
2.3	1995-1999					GC034085	Outer Joint	44T	31	26	62	95	65	I				
<b>MILLENNIA (TA5P)</b>																		
2.5	2000.07-	4AT			Engine KL-ZE	GC034012	Outer Joint		28	26	56	94	63	M				
<b>MILLENNIA (TAFP)</b>																		
2.0	2000.07-	4AT			Engine KF-ZE	GC034012	Outer Joint		28	26	56	94	63	M				
<b>MPV</b>																		
-						GC099046	Outer Joint		26	23	56	101	59.5	I				
	1989-1995		R		Truck	GDS34068	Drive Shaft		26	26	56	101	547					
	1989-1998				SUV/Truck/VAN	GC034037	Outer Joint		26	25	56	102	61	M				
	1996-1998				Truck/VAN 4WD	GCI34012	Inner Joint		26	25	35	82.5	108.5					
	2000-2001		R		Truck/VAN 4WD	GDS34055	Drive Shaft	44T	28	28	56	89	582					
	2002-					GC034077	Outer Joint	44T	28	35	56	91	65	I				
<b>MPV I (LV)</b>																		
3.0 i V6 (109 kW)	1996.05-1999.09		R		MPV Engine JE94	GC018031	Outer Joint		26	25	56	93	61	M				
3.0 i V6 (113 kW)	1995.03-1999.09		R		MPV Engine JE94	GC018031	Outer Joint		26	25	56	93	61	M				
<b>MPV II (LW)</b>																		
2.0 (88 kW)	1999.10-2003.04		F		MPV Engine FS	GC034117	Outer Joint	44T	28	32	56	89	59	M				
	1999.10-2003.04		F		MPV Engine FS	GC034118	Outer Joint	44T	28	33	56.5	89	59	M				
2.0 Di (100 kW)	2002.07-2006.02		F		MPV Engine RF5C	GC034117	Outer Joint	44T	28	32	56	89	59	M				
	2002.07-2006.02				MPV Engine RF5C	GC099285	Outer Joint	44T	28	36	56.6	90	76	I				
2.3 (104 kW)	2002.07-2006.02		F		MPV Engine L3	GC034118	Outer Joint	44T	28	33	56.5	89	59	M				
	2002.07-2006.02				MPV Engine L3	GC099285	Outer Joint	44T	28	36	56.6	90	76	I				
<b>MS-6 (GE8P)</b>																		
1.8	1991.10-1994.07	4AT			Engine K8	GC034014	Outer Joint		28	23	56	89.1	59.5	M				
	1991.10-1994.07	5MT			Engine K8	GC034014	Outer Joint		28	23	56	89.1	59.5	M				
	1991.10-1994.07	4AT			Engine K8	GC034145	Outer Joint	44T	28	23	56	89.1	59.5	M				
	1991.10-1994.07	5MT			Engine K8	GC034145	Outer Joint	44T	28	23	56	89.1	59.5	M				
<b>MS-6 (GEEP)</b>																		
2.0	1991.10-1994.07	4AT			Engine KF	GC034014	Outer Joint		28	23	56	89.1	59.5	M				
	1991.10-1994.07	5MT			Engine KF	GC034014	Outer Joint		28	23	56	89.1	59.5	M				
	1991.10-1994.07	4AT			Engine KF	GC034145	Outer Joint	44T	28	23	56	89.1	59.5	M				
	1991.10-1994.07	5MT			Engine KF	GC034145	Outer Joint	44T	28	23	56	89.1	59.5	M				
<b>MS-6 (GEFP)</b>																		
2.0	1993.06-1994.07	4AT			Engine RF SPC	GC034014	Outer Joint		28	23	56	89.1	59.5	M				
	1993.06-1994.07	4AT			Engine RF SPC	GC034145	Outer Joint	44T	28	23	56	89.1	59.5	M				
<b>MS-8 (MB5A)</b>																		
2.5	1992.01-1994.05	4AT			Engine KL	GC034012	Outer Joint		28	26	56	94	63	M				
<b>MS-8 (MBEP)</b>																		
2.0	1992.01-1994.05	4AT			Engine KF	GC034014	Outer Joint		28	23	56	89.1	59.5	M				
	1992.01-1994.05	4AT			Engine KF	GC034145	Outer Joint	44T	28	23	56	89.1	59.5	M				
<b>MX-3</b>																		
1.6	1992-1993					GCI18006	Inner Joint		24	22	35	64	98.5					
1.8	1992-1995	MT	L	F		GDS34046	Drive Shaft	44T	26	28	56	93	622.5					
	1992-1995	MT				GCI34009	Inner Joint		28	30	35	66.5	99					
<b>MX-3 (EC)</b>																		
1.6 i (65 kW)	1991.07-	MT/AT	F		Coupe Engine B69	GC034007	Outer Joint		26	22	56	93	56.5	I				
1.6 i (79 kW)	1994.01-		F		Coupe Engine B6D	GC034055	Outer Joint		26	22	56	94	59	M				
1.8 i V6 (98 kW)	1992.01-1994.01	MT/AT	F		Coupe Engine K819	GC034007	Outer Joint		26	22	56	93	56.5	I				
	1992.01-1994.01	MT/AT	F		Coupe Engine K819	GC018034	Outer Joint		26	22	56	94	59	I				
<b>MX-5</b>																		
1.6	1990-1994					GC034052	Outer Joint		26	30	56	93.5	60	I				
1.8	1994-1998					GC034052	Outer Joint		26	30	56	93.5	60	I				
<b>MX-5 (NA)</b>																		
1.6 (85 kW)	1990.05-1994.01		R		Convertible Engine B64F	GC034022	Outer Joint	44T	26	22	56	94	59	I				
<b>MX-5 III (NC)</b>																		
1.8 (93 kW)	2005.03-		L	R	Convertible Engine L828/L8-DE	GDS34211	Drive Shaft	44T	28	28	56.5	81.5	759					
	2005.03-		R	R	Convertible Engine L828/L8-DE	GDS34212	Drive Shaft	44T	28	28	56.5	81.5	799					
2.0 (118 kW)	2005.08-2008.02		L	R	Convertible Engine LF62/LF-DE	GDS34211	Drive Shaft	44T	28	28	56.5	81.5	759					
	2005.08-2008.02		R	R	Convertible Engine LF62/LF-DE	GDS34212	Drive Shaft	44T	28	28	56.5	81.5	799					
<b>MX-6</b>																		
-	1988-1992				4 Cy	GCI34002	Inner Joint		26	25	42.3	37.8	76.5					
	1988-1992				4 Cyl	GCI18005	Inner Joint		26	25	35	66.5	103.4					



		YEAR	TRANSM	L/R	F/R		G-AP Ref.	PRODUCT	ABS	Technical Specifications								
										A	B	C	H	L	P			
<b>MAZDA</b>																		
<b>MX-6</b>																		
2.0	1993-	1997	MT				GC034036	Outer Joint			28	32	56	90	59	I		
	1993-	1997	MT				GC034063	Outer Joint	44T		28	32	56	90	59	I		
2.5	1993-	1997	MT				GC034036	Outer Joint			28	32	56	90	59	I		
	1993-	1997	MT				GC034063	Outer Joint	44T		28	32	56	90	59	I		
<b>MX-6 (GE)</b>																		
-	1991-	1996					GCI34033	Inner Joint			28	23	43	46	77			
2.5 24V (121 kW)	1992.02-	1997.02	MT/AT		F	Coupe Engine KL	GC018028	Outer Joint			28	26	56	89	65	I		
	1992.02-	1997.02			F	Coupe Engine KL	GC018073	Outer Joint			28	26	56	89	65	M		
	1992.02-	1997.02			F	Coupe Engine KL	GC034073	Outer Joint	90T		28	26	56	89	65	M		
	1992.02-	1997.02	MT/AT		F	Coupe Engine KL	GC018029	Outer Joint	44T		28	26	56	89	65	I		
	1992.02-	1997.02	MT/AT		F	Coupe Engine KL	GC034082	Outer Joint	44T		28	26	56	94	63	M		
	1992.02-	1997.02			F	Coupe Engine KL	GC099045	Outer Joint			28	23	56	90	59	M		
2.5 i 24V (120 kW)	1994.08-	1997.02	MT/AT		F	Coupe Engine KL	GC018028	Outer Joint			28	26	56	89	65	I		
	1994.08-	1997.02			F	Coupe Engine KL	GC018073	Outer Joint			28	26	56	89	65	M		
	1994.08-	1997.02			F	Coupe Engine KL	GC034073	Outer Joint	90T		28	26	56	89	65	M		
	1994.08-	1997.02	MT/AT		F	Coupe Engine KL	GC018029	Outer Joint	44T		28	26	56	89	65	I		
	1994.08-	1997.02	MT/AT		F	Coupe Engine KL	GC034082	Outer Joint	44T		28	26	56	94	63	M		
<b>MX-6 (GE5SB)</b>																		
2.5	1991.11-	1996.01	4AT			Engine KL	GC034012	Outer Joint			28	26	56	94	63	M		
<b>MX-6 (GEESB)</b>																		
2.0	1991.11-	1996.01	4AT			Engine KF	GC034014	Outer Joint			28	23	56	89.1	59.5	M		
	1991.11-	1996.01	5MT			Engine KF	GC034014	Outer Joint			28	23	56	89.1	59.5	M		
	1991.11-	1996.01	4AT			Engine KF	GC034145	Outer Joint	44T		28	23	56	89.1	59.5	M		
	1991.11-	1996.01	5MT			Engine KF	GC034145	Outer Joint	44T		28	23	56	89.1	59.5	M		
<b>PICK UP</b>																		
-	1987-	1994		L		Truck	GDS34067	Drive Shaft			26	26	65	143.5	541			
	1987-	1993				Truck/VAN 4WD	GCI34012	Inner Joint			26	25	35	82.5	108.5			
B3000	2000-	2002			F	6 Cyl	GC018055	Outer Joint			27	34	59.7	112	80	I		
B4000	2000-	2002			F	6 Cyl	GC018055	Outer Joint			27	34	59.7	112	80	I		
<b>PRECIDIA</b>																		
-	1992-	1995	MT			6 Cyl	GCI34009	Inner Joint			28	30	35	66.5	99			
<b>PREMACY (CP)</b>																		
1.9 (74 kW)	1999.07-	2005.03			F	MPV Engine FP	GC034060	Outer Joint	44T		26	29	56	93.5	59	I		
	1999.07-	2005.03	MT/AT		F	MPV Engine FP	GC034008	Outer Joint			26	29	56	93.5	59	I		
1.9 (84 kW)	1999.07-	2005.03	MT/AT		F	MPV Engine FP	GC034008	Outer Joint			26	29	56	93.5	59	I		
2.0 TD (74 kW)	2000.07-	2005.03	MT/AT		F	MPV Engine RF4F	GC034008	Outer Joint			26	29	56	93.5	59	I		
<b>PREMACY (CP8W)</b>																		
1.8	1999.04-	2004.12	4AT/C			Engine FP-DE	GC034123	Outer Joint	44T		26	29	56	92	56	I		
1.8 4WD	1999.04-	2004.12	4AT/C			Engine FP-DE	GC034124	Outer Joint	44T		26	28	56	93.1	53	M		
<b>PREMACY (CPEW)</b>																		
2.0	2001.06-	2004.12	4AT/C			Engine FS-DE	GC034123	Outer Joint	44T		26	29	56	92	56	I		
<b>PRIDE</b>																		
-	1994.01-	1995.12					GC027023	Outer Joint			24	19	52	86	51	O		
<b>PROBE</b>																		
-	1988-						GC034054	Outer Joint			26	30	56	93	55	M		
	1988-	1992				4 Cyl W/O Turbo	GCI34036	Inner Joint			26	25	43	37.8	75.5			
	1988-	1992					GCI34002	Inner Joint			26	25	42.3	37.8	76.5			
	1988-	1992					GCI18005	Inner Joint			26	25	35	66.5	103.4			
<b>PROBE (PT22L)</b>																		
2.2	1989.11-	1992.09	AT			Engine F2	GC034012	Outer Joint			28	26	56	94	63	M		
<b>PROTEGE</b>																		
-	1990-	1994					GCI18009	Inner Joint			24	23	35	64	98.5			
	1990-	1994				Sohc	GC015002	Outer Joint			26	23	56	93	56.5	M		
1.5	1995-	1998				4 Cyl	GCI18006	Inner Joint			24	22	35	64	98.5			
1.8	1990-	1994		L			GDS18087	Drive Shaft			26	24	56	93	626.5			
	1990-	1994					GC034050	Outer Joint			26	23	56	93.5	56.5	M		
	1990-	1994					GCI18039	Inner Joint			24	28	35	64.1	91.5			
	1995-	1998	MT	L	F		GDS34046	Drive Shaft	44T		26	28	56	93	622.5			
	1995-	1998	MT				GCI34009	Inner Joint			28	30	35	66.5	99			
<b>PROTEGE (USA)</b>																		
1.8 DOHC	1990.01-	1992.12	MT				GC034025	Outer Joint			26	30	56	92.5	57.5	I		





		YEAR	TRANSM	L/R	F/R		G-AP Ref.	PRODUCT	ABS	Technical Specifications						
										A	B	C	H	L	P	
<b>MAZDA</b>																
<b>REVUE (DB3PA)</b>																
1.3	1990.08-	1995.10	4AT			Engine B3	GC034018	Outer Joint		24	21	52	86	50	M	
	1990.08-	1996.10	5MT			Engine B3	GC034018	Outer Joint		24	21	52	86	50	M	
<b>REVUE (DB5PA)</b>																
1.5	1990.01-	1995.10	MT/AT			Engine B5	GC034018	Outer Joint		24	21	52	86	50	M	
<b>TRIBUTE</b>																
-	2001-	2004				Truck/VAN	GC034039	Outer Joint		28	24	56	94	62	M	
	2001-	2004				Truck/VAN	GC034064	Outer Joint	44T	28	24	56	94	62	M	
<b>TRIBUTE (EP)</b>																
2.0 (91 kW)	2000.03-	2008.05	MT/AT		F	Closed Engine YF	GC034090	Outer Joint	44T	28	24	56	89.1	59.5	M	
	2000.03-	2008.05		L	F	Closed Engine YF	GDS34096	Drive Shaft	44T	28	28	56	94	635		
	2000.03-	2008.05		L	F	Closed Engine YF	GCI34071	Inner Joint		28	32	35	66.5	112		
	2000.03-	2008.05		L	F	Closed Engine YF	GC034039	Outer Joint		28	24	56	94	62	M	
	2000.03-	2008.05		L	F	Closed Engine YF	GC034064	Outer Joint	44T	28	24	56	94	62	M	
	2000.03-	2008.05	MT	R	F	Closed Engine YF	GDS34196	Drive Shaft	44T	28	35	56	94	570		
	2000.03-	2008.05			R	Closed Engine YF	GC018204	Outer Joint	44T	26	30	56	114	58	I	
2.0 4WD (91 kW)	2000.03-	2008.05	MT/AT		F	Closed Engine YF	GC034090	Outer Joint	44T	28	24	56	89.1	59.5	M	
	2000.03-	2008.05	MT	L	F	Closed Engine YF	GDS34096	Drive Shaft	44T	28	28	56	94	635		
	2000.03-	2008.05	MT	L	F	Closed Engine YF	GCI34071	Inner Joint		28	32	35	66.5	112		
	2000.03-	2008.05	MT	L	F	Closed Engine YF	GC034039	Outer Joint		28	24	56	94	62	M	
	2000.03-	2008.05	MT	L	F	Closed Engine YF	GC034064	Outer Joint	44T	28	24	56	94	62	M	
	2000.03-	2008.05	MT	R	F	Closed Engine YF	GDS34196	Drive Shaft	44T	28	35	56	94	570		
	2000.03-	2008.05			R	Closed Engine YF	GC018204	Outer Joint	44T	26	30	56	114	58	I	
2.3 AWD (110 kW)	2004.04-	2008.05	MT/AT		F	Closed Engine L3-VE	GC034090	Outer Joint	44T	28	24	56	89.1	59.5	M	
3.0 V6 24V 4WD (145 kW)	2000.03-	2008.05	MT/AT		F	Closed Engine AJ	GC034090	Outer Joint	44T	28	24	56	89.1	59.5	M	
	2000.03-	2008.05	AT	L	F	Closed Engine AJ	GDS18083	Drive Shaft	44T	28	35	56	91.5	670		
	2000.03-	2008.05	AT	R	F	Closed Engine AJ	GDS34087	Drive Shaft	44T	28	35	56	94	545		
	2000.03-	2008.05			F	Closed Engine AJ	GC034064	Outer Joint	44T	28	24	56	94	62	M	
	2000.03-	2008.05			R	Closed Engine AJ	GC018204	Outer Joint	44T	26	30	56	114	58	I	
3.0 V6 AWD (149 kW)	2004.04-	2008.05	MT/AT		F	Closed Engine AJ	GC034090	Outer Joint	44T	28	24	56	89.1	59.5	M	
<b>XEDOS 6</b>																
1.6 16V	1993-	1997	MT/AT				GC099233	Outer Joint	44T	28	22	56	90	59	I	
2.0 24V V6	1992-	1998	MT/AT				GC099233	Outer Joint	44T	28	22	56	90	59	I	
<b>XEDOS 6 (CA)</b>																
1.6 16V (79 kW)	1994.06-	1999.10	MT		F	Saloon Engine B6(DOHC)	GC034100	Outer Joint		28	22	56	89.1	59.5	M	
1.6 16V (83 kW)	1992.08-	1994.05	MT		F	Saloon Engine B69	GC034100	Outer Joint		28	22	56	89.1	59.5	M	
2.0 V6 (103 kW)	1994.06-	1999.10	AT		F	Saloon Engine KF1	GC099045	Outer Joint		28	23	56	90	59	M	
2.0 V6 (106 kW)	1992.01-	1994.05	AT		F	Saloon Engine KF1	GC099045	Outer Joint		28	23	56	90	59	M	
<b>XEDOS 9 (TA)</b>																
2.0 24V (105 kW)	1993.08-	2000.01	MT		F	Saloon Engine KF	GC018029	Outer Joint	44T	28	26	56	89	65	I	
<b>MERCEDES BENZ</b>																
<b>100 (631)</b>																
2.4 D (41 kW)	1990.12-	1994.12	MT	L/R	F	Bus Engine OM616	GDS35010	Drive Shaft		30	30	72	142	729		
2.4 D (53 kW)	1988.02-	1992.05	MT	L/R	F	Box Engine OM616.963	GDS35010	Drive Shaft		30	30	72	142	729		
	1988.02-	1992.05	MT	L/R	F	Bus Engine OM616.963	GDS35010	Drive Shaft		30	30	72	142	729		
2.4 D (55 kW)	1990.12-	1996.02	MT	L/R	F	Box Engine OM616.963	GDS35010	Drive Shaft		30	30	72	142	729		
	1990.12-	1996.02	MT	L/R	F	Bus Engine OM616/OM616.963	GDS35010	Drive Shaft		30	30	72	142	729		
<b>190 (W201)</b>																
2.0 (66 kW)	1982.10-	1984.10	MT/AT	L/R	R	Saloon Engine M102.921	GDS35006	Drive Shaft		25		62	69	627		
	1982.10-	1984.10	MT/AT		R	Saloon Engine M102.921	GCI35003	Inner Joint		25	25	62	69	56		
2.0 D (53 kW)	1983.08-	1989.08	MT/AT	L/R	R	Saloon Engine OM601.911	GDS35006	Drive Shaft		25		62	69	627		
2.0 D (55 kW)	1989.08-	1993.08	MT/AT	L/R	R	Saloon Engine OM601.911	GDS35006	Drive Shaft		25		62	69	627		
2.5 D (66 kW)	1985.04-	1993.08	MT/AT	L/R	R	Saloon Engine OM602.911	GDS35006	Drive Shaft		25		62	69	627		
2.5 D (69 kW)	1989.08-	1993.08	MT/AT	L/R	R	Saloon Engine OM602.911	GDS35006	Drive Shaft		25		62	69	627		
E 1.8 (80 kW)	1990.04-	1993.08	MT/AT	L/R	R	Saloon Engine M102.910	GDS35006	Drive Shaft		25		62	69	627		
E 2.0 (83 kW)	1985.02-	1986.12	MT/AT	L/R	R	Saloon Engine M102.961/102.962	GDS35006	Drive Shaft		25		62	69	627		
E 2.0 (85 kW)	1985.02-	1986.12	MT/AT	L/R	R	Saloon Engine M102.962	GDS35006	Drive Shaft		25		62	69	627		
E 2.0 (87 kW)	1985.01-	1993.08	MT/AT	L/R	R	Saloon Engine M102.962	GDS35006	Drive Shaft		25		62	69	627		
E 2.0 (90 kW)	1982.10-	1993.06	MT/AT	L/R	R	Saloon Engine M102.961/102.962	GDS35006	Drive Shaft		25		62	69	627		
E 2.3 (100 kW)	1986.10-	1993.08	MT/AT	L/R	R	Saloon Engine M102.985	GDS35006	Drive Shaft		25		62	69	627		
E 2.3 (97 kW)	1986.09-	1991.08	MT/AT	L/R	R	Saloon Engine M102.985	GDS35006	Drive Shaft		25		62	69	627		



		YEAR	TRANSM	L/R	F/R		G-AP Ref.	PRODUCT	ABS	Technical Specifications						
										A	B	C	H	L	P	
<b>MERCEDES BENZ</b>																
<b>A-CLASS (W168)</b>																
A 140 (60 kW)	1997.07-	2004.08	5MT		F	Hatchback Engine M166.940	GC035010	Outer Joint		24	27	57	67.5	50	I	
	1997.07-	2004.08	AT		F	Hatchback Engine M166.940	GC035004	Outer Joint	48W	24	27	57	67.5	56	I	
	1997.07-	2004.08	MT		F	Hatchback Engine M166.940	GC035022	Outer Joint	48W	24	27	57	67.5	56	I	
	1997.07-	2004.08	6MT	L	F	Hatchback Engine M166.940	GCI35013	Inner Joint		22	27	36	55	79		
	1997.07-	2004.08	6MT	L	F	Hatchback Engine M166.940	GDS35037	Drive Shaft	48W	24	22	57	67.5	572		
	1997.07-	2004.08	5MT	R	F	Hatchback Engine M166.940	GDS35038	Drive Shaft	48W	24	22	57	67.5	954		
	1997.07-	2004.08		R		Hatchback Engine M166.940	GDS35047	Drive Shaft		24	22	57	67.5	954		
	2001.01-	2004.08	AT		F	Hatchback Engine M166.960	GC035004	Outer Joint	48W	24	27	57	67.5	56	I	
	2001.01-	2004.08	MT		F	Hatchback Engine M166.960	GC035022	Outer Joint	48W	24	27	57	67.5	56	I	
2001.01-	2004.08		R		Hatchback Engine M166.960	GDS35047	Drive Shaft		24	22	57	67.5	954			
A 160 (75 kW)	1997.07-	2004.08			F	Hatchback Engine M166.960	GC035010	Outer Joint		24	27	57	67.5	50	I	
	1997.07-	2004.08	AT		F	Hatchback Engine M166.960	GC035004	Outer Joint	48W	24	27	57	67.5	56	I	
	1997.07-	2004.08	MT		F	Hatchback Engine M166.960	GC035022	Outer Joint	48W	24	27	57	67.5	56	I	
	1997.07-	2004.08		L	F	Hatchback Engine M166.960	GDS35037	Drive Shaft	48W	24	22	57	67.5	572		
	1997.07-	2004.08		L	F	Hatchback Engine M166.960	GCI35013	Inner Joint		22	27	36	55	79		
	1997.07-	2004.08		R	F	Hatchback Engine M166.960	GDS35038	Drive Shaft	48W	24	22	57	67.5	954		
A 160 CDi (44 kW)	1998.07-	2001.02		L	F	Hatchback Engine OM668.941	GCI35013	Inner Joint		22	27	36	55	79		
	1998.07-	2001.02		R		Hatchback Engine OM668.941	GDS35047	Drive Shaft		24	22	57	67.5	954		
A 160 CDi (55 kW)	2001.02-	2004.08			F	Hatchback Engine OM668.940	GC035010	Outer Joint		24	27	57	67.5	50	I	
	2001.02-	2004.08	AT		F	Hatchback Engine OM668.940	GC035004	Outer Joint	48W	24	27	57	67.5	56	I	
	2001.02-	2004.08	MT		F	Hatchback Engine OM668.940	GC035022	Outer Joint	48W	24	27	57	67.5	56	I	
	2001.02-	2004.08	MT	R	F	Hatchback Engine OM668.940	GDS35038	Drive Shaft	48W	24	22	57	67.5	954		
	2001.02-	2004.08		R		Hatchback Engine OM668.940	GDS35047	Drive Shaft		24	22	57	67.5	954		
A 170 CDi (66 kW)	1998.07-	2001.02	AT		F	Hatchback Engine OM668.940	GC035003	Outer Joint	48W	24	27	57	67.5	50	I	
	1998.07-	2001.02	MT	L	F	Hatchback Engine OM668.940	GCI35013	Inner Joint		22	27	36	55	79		
	1998.07-	2001.02		R		Hatchback Engine OM668.940	GDS35047	Drive Shaft		24	22	57	67.5	954		
A 170 CDi (70 kW)	2001.02-	2004.08			F	Hatchback Engine OM668.942	GC035010	Outer Joint		24	27	57	67.5	50	I	
	2001.02-	2004.08	AT		F	Hatchback Engine OM668.942	GC035004	Outer Joint	48W	24	27	57	67.5	56	I	
	2001.02-	2004.08	MT		F	Hatchback Engine OM668.942	GC035022	Outer Joint	48W	24	27	57	67.5	56	I	
	2001.02-	2004.08	MT	R	F	Hatchback Engine OM668.942	GDS35038	Drive Shaft	48W	24	22	57	67.5	954		
A 190 (92 kW)	1999.03-	2004.08			F	Hatchback Engine M166.990	GC035010	Outer Joint		24	27	57	67.5	50	I	
	1999.03-	2004.08	AT		F	Hatchback Engine M166.990	GC035005	Outer Joint	48W	24	27	57	67.5	58	I	
	1999.03-	2004.08	MT		F	Hatchback Engine M166.990	GC035023	Outer Joint	48W	24	27	57	67.5	58	I	
	1999.03-	2004.08		R		Hatchback Engine M166.990	GDS35047	Drive Shaft		24	22	57	67.5	954		
A 210 (103 kW)	2002.03-	2004.08		R		Hatchback Engine M166.995	GDS35047	Drive Shaft		24	22	57	67.5	954		
<b>A-CLASS (W169)</b>																
A 150 (70 kW)	2004.12-	2007.03			F	Hatchback Engine M266.920	GC035026	Outer Joint		25	27	60	73.5	52	I	
	2004.12-	2007.03	AT	L	F	Hatchback Engine M266.920	GDS35025	Drive Shaft		25	27	60	73.5	613		
	2004.12-	2007.03	MT	L	F	Hatchback Engine M266.920	GDS35032	Drive Shaft		25	22	60.3	43	582		
	2004.12-	2007.03	MT	L	F	Hatchback Engine M266.920	GCI99136	Inner Joint		22	27	36	55	100		
	2004.12-	2007.03		L	F	Hatchback Engine M266.920	GDS35054	Drive Shaft		25	27	60	73.5	608		
	2004.12-	2007.03		L	F	Hatchback Engine M266.920	GCI35024	Inner Joint		27	25	38	62	120		
	2004.12-	2007.03		L/R	F	Hatchback Engine M266.920	GC099037	Outer Joint		25	25	60	73.5	58.5	I	
	2004.12-	2007.03	MT	R	F	Hatchback Engine M266.920	GDS35039	Drive Shaft		25	22	60	73.5	977		
	2004.12-	2007.03	MT	R	F	Hatchback Engine M266.920	GCI35011	Inner Joint		22	27	36	459	81		
	2004.12-	2007.03		R	F	Hatchback Engine M266.920	GDS35045	Drive Shaft		25	22	56	73.5	985		
	2004.12-	2007.03		R	F	Hatchback Engine M266.920	GDS35055	Drive Shaft		25	27	60	73.5	948		
	2004.12-	2007.03		R	F	Hatchback Engine M266.920	GCI35040	Inner Joint		27	25	38	422	100		
	2004.12-	2007.03	MT			Hatchback Engine M266.920	GC035040	Outer Joint		25	27	56	73.5	53.5	I	
	2004.12-	2007.03				Hatchback Engine M266.920	GC035027	Outer Joint		25	27	60.3	43	53	I	
A 160 (70 kW)	2009.04-	2012.06			F	Hatchback Engine M266.920	GC035026	Outer Joint		25	27	60	73.5	52	I	
	2009.04-	2012.06	AT	L	F	Hatchback Engine M266.920	GDS35025	Drive Shaft		25	27	60	73.5	613		
	2009.04-	2012.06	AT	L	F	Hatchback Engine M266.920	GDS35054	Drive Shaft		25	27	60	73.5	608		
	2009.04-	2012.06	AT	L	F	Hatchback Engine M266.920	GCI35024	Inner Joint		27	25	38	62	120		
	2009.04-	2012.06	MT	L	F	Hatchback Engine M266.920	GDS35032	Drive Shaft		25	22	60.3	43	582		
	2009.04-	2012.06	MT	L	F	Hatchback Engine M266.920	GCI99136	Inner Joint		22	27	36	55	100		
	2009.04-	2012.06	AT	L/R	F	Hatchback Engine M266.920	GC099037	Outer Joint		25	25	60	73.5	58.5	I	
	2009.04-	2012.06	AT	R	F	Hatchback Engine M266.920	GDS35055	Drive Shaft		25	27	60	73.5	948		
	2009.04-	2012.06	AT	R	F	Hatchback Engine M266.920	GCI35040	Inner Joint		27	25	38	422	100		
	2009.04-	2012.06	MT	R	F	Hatchback Engine M266.920	GDS35075	Drive Shaft		25	22	60.5	42	944		





		YEAR	TRANSM	L/R	F/R		G-AP Ref.	PRODUCT	ABS	Technical Specifications						
										A	B	C	H	L	P	
<b>MERCEDES BENZ</b>																
<b>A-CLASS (W169)</b>																
A 160 (70 kW)	2009.04-	2012.06	MT	R	F	Hatchback Engine M266.920	GCI35011	Inner Joint		22	27	36	459	81		
	2009.04-	2012.06		R	F	Hatchback Engine M266.920	GDS35045	Drive Shaft		25	22	56	73.5	985		
	2009.04-	2012.06	MT			Hatchback Engine M266.920	GC035040	Outer Joint		25	27	56	73.5	53.5	I	
	2009.04-	2012.06				Hatchback Engine M266.920	GC035027	Outer Joint		25	27	60.3	43	53	I	
A 160 CDi (60 kW)	2004.12-	2007.03			F	Hatchback Engine OM640.942	GC035026	Outer Joint		25	27	60	73.5	52	I	
	2004.12-	2007.03	AT	L	F	Hatchback Engine OM640.942	GDS35025	Drive Shaft		25	27	60	73.5	613		
	2004.12-	2007.03	MT	L	F	Hatchback Engine OM640.942	GDS35032	Drive Shaft		25	22	60.3	43	582		
	2004.12-	2007.03	MT	L	F	Hatchback Engine OM640.942	GCI99136	Inner Joint		22	27	36	55	100		
	2004.12-	2007.03		L	F	Hatchback Engine OM640.942	GDS35054	Drive Shaft		25	27	60	73.5	608		
	2004.12-	2007.03		L	F	Hatchback Engine OM640.942	GCI35024	Inner Joint		27	25	38	62	120		
	2004.12-	2007.03		L/R	F	Hatchback Engine OM640.942	GC099037	Outer Joint		25	25	60	73.5	58.5	I	
	2004.12-	2007.03	MT	R	F	Hatchback Engine OM640.942	GDS35039	Drive Shaft		25	22	60	73.5	977		
	2004.12-	2007.03	MT	R	F	Hatchback Engine OM640.942	GCI35011	Inner Joint		22	27	36	459	81		
	2004.12-	2007.03		R	F	Hatchback Engine OM640.942	GDS35055	Drive Shaft		25	27	60	73.5	948		
	2004.12-	2007.03		R	F	Hatchback Engine OM640.942	GCI35040	Inner Joint		27	25	38	422	100		
	2004.12-	2007.03	AT			Hatchback Engine OM640.942	GC035040	Outer Joint		25	27	56	73.5	53.5	I	
	2004.12-	2007.03	MT/AT			Hatchback Engine OM640.942	GC035027	Outer Joint		25	27	60.3	43	53	I	
A 170 (85 kW)	2004.12-	2007.03			F	Hatchback Engine M266.940	GC035026	Outer Joint		25	27	60	73.5	52	I	
	2004.12-	2007.03	AT	L	F	Hatchback Engine M266.940	GDS35025	Drive Shaft		25	27	60	73.5	613		
	2004.12-	2007.03	MT	L	F	Hatchback Engine M266.940	GDS35032	Drive Shaft		25	22	60.3	43	582		
	2004.12-	2007.03	MT	L	F	Hatchback Engine M266.940	GCI99136	Inner Joint		22	27	36	55	100		
	2004.12-	2007.03		L	F	Hatchback Engine M266.940	GDS35054	Drive Shaft		25	27	60	73.5	608		
	2004.12-	2007.03		L	F	Hatchback Engine M266.940	GCI35024	Inner Joint		27	25	38	62	120		
	2004.12-	2007.03		L/R	F	Hatchback Engine M266.940	GC099037	Outer Joint		25	25	60	73.5	58.5	I	
	2004.12-	2007.03	MT	R	F	Hatchback Engine M266.940	GDS35039	Drive Shaft		25	22	60	73.5	977		
	2004.12-	2007.03	MT	R	F	Hatchback Engine M266.940	GCI35011	Inner Joint		22	27	36	459	81		
	2004.12-	2007.03		R	F	Hatchback Engine M266.940	GDS35045	Drive Shaft		25	22	56	73.5	985		
	2004.12-	2007.03		R	F	Hatchback Engine M266.940	GDS35055	Drive Shaft		25	27	60	73.5	948		
	2004.12-	2007.03		R	F	Hatchback Engine M266.940	GCI35040	Inner Joint		27	25	38	422	100		
	2004.12-	2007.03	AT			Hatchback Engine M266.940	GC035040	Outer Joint		25	27	56	73.5	53.5	I	
	2004.12-	2007.03				Hatchback Engine M266.940	GC035027	Outer Joint		25	27	60.3	43	53	I	
A 180 (85 kW)	2009.04-	2012.06			F	Hatchback Engine M266.940	GC035026	Outer Joint		25	27	60	73.5	52	I	
	2009.04-	2012.06	AT	L	F	Hatchback Engine M266.940	GDS35025	Drive Shaft		25	27	60	73.5	613		
	2009.04-	2012.06	MT	L	F	Hatchback Engine M266.940	GDS35032	Drive Shaft		25	22	60.3	43	582		
	2009.04-	2012.06	MT	L	F	Hatchback Engine M266.940	GCI99136	Inner Joint		22	27	36	55	100		
	2009.04-	2012.06		L	F	Hatchback Engine M266.940	GDS35054	Drive Shaft		25	27	60	73.5	608		
	2009.04-	2012.06		L	F	Hatchback Engine M266.940	GCI35024	Inner Joint		27	25	38	62	120		
	2009.04-	2012.06		L/R	F	Hatchback Engine M266.940	GC099037	Outer Joint		25	25	60	73.5	58.5	I	
	2009.04-	2012.06	MT	R	F	Hatchback Engine M266.940	GDS35075	Drive Shaft		25	22	60.5	42	944		
	2009.04-	2012.06	MT	R	F	Hatchback Engine M266.940	GCI35011	Inner Joint		22	27	36	459	81		
	2009.04-	2012.06		R	F	Hatchback Engine M266.940	GDS35045	Drive Shaft		25	22	56	73.5	985		
	2009.04-	2012.06		R	F	Hatchback Engine M266.940	GDS35055	Drive Shaft		25	27	60	73.5	948		
	2009.04-	2012.06		R	F	Hatchback Engine M266.940	GCI35040	Inner Joint		27	25	38	422	100		
	2009.04-	2012.06				Hatchback Engine M266.940	GC035027	Outer Joint		25	27	60.3	43	53	I	
	A 180 CDi (80 kW)	2004.12-	2007.03			F	Hatchback Engine OM640.940	GC099037	Outer Joint		25	25	60	73.5	58.5	I
2004.12-		2007.03	MT		F	Hatchback Engine OM640.940	GCI35014	Inner Joint		27	25	38	62	102		
2004.12-		2007.03		L	F	Hatchback Engine OM640.940	GDS99296	Drive Shaft		25	27	60	73.5	598		
2004.12-		2007.03	AT	L	F	Hatchback Engine OM640.940	GDS35025	Drive Shaft		25	27	60	73.5	613		
2004.12-		2007.03	MT	L	F	Hatchback Engine OM640.940	GDS35032	Drive Shaft		25	22	60.3	43	582		
2004.12-		2007.03	MT	L	F	Hatchback Engine OM640.940	GCI99136	Inner Joint		22	27	36	55	100		
2004.12-		2007.03		L	F	Hatchback Engine OM640.940	GDS35054	Drive Shaft		25	27	60	73.5	608		
2004.12-		2007.03		L	F	Hatchback Engine OM640.940	GCI35024	Inner Joint		27	25	38	62	120		
2004.12-		2007.03		L/R	F	Hatchback Engine OM640.940	GC099037	Outer Joint		25	25	60	73.5	58.5	I	
2004.12-		2007.03	MT	R	F	Hatchback Engine OM640.940	GDS35081	Drive Shaft		25	27	60	73.5	987		
2004.12-		2007.03	MT	R	F	Hatchback Engine OM640.940	GCI35012	Inner Joint		27	25	38	476	83		
2004.12-		2007.03	MT	R	F	Hatchback Engine OM640.940	GC035030	Outer Joint		25	25	60.4	74	56	I	
2004.12-		2007.03		R	F	Hatchback Engine OM640.940	GDS35055	Drive Shaft		25	27	60	73.5	948		
2004.12-		2007.03		R	F	Hatchback Engine OM640.940	GCI35040	Inner Joint		27	25	38	422	100		
2004.12-	2007.03	AT			Hatchback Engine OM640.940	GC035040	Outer Joint		25	27	56	73.5	53.5	I		
A 200 (100 kW)	2004.12-	2007.03			F	Hatchback Engine M266.960	GC035026	Outer Joint		25	27	60	73.5	52	I	
	2004.12-	2007.03	AT	L	F	Hatchback Engine M266.960	GDS35025	Drive Shaft		25	27	60	73.5	613		
	2004.12-	2007.03	MT	L	F	Hatchback Engine M266.960	GDS35032	Drive Shaft		25	22	60.3	43	582		
	2004.12-	2007.03	MT	L	F	Hatchback Engine M266.960	GCI99136	Inner Joint		22	27	36	55	100		





		YEAR	TRANSM	L/R	F/R		G-AP Ref.	PRODUCT	ABS	Technical Specifications						
										A	B	C	H	L	P	
<b>MERCEDES BENZ</b>																
<b>A-CLASS (W169)</b>																
A 200 (100 kW)	2004.12-	2007.03			L	F	Hatchback Engine M266.960	GDS35054	Drive Shaft		25	27	60	73.5	608	
	2004.12-	2007.03			L	F	Hatchback Engine M266.960	GCI35024	Inner Joint		27	25	38	62	120	
	2004.12-	2007.03			L/R	F	Hatchback Engine M266.960	GC099037	Outer Joint		25	25	60	73.5	58.5	I
	2004.12-	2007.03	MT		R	F	Hatchback Engine M266.960	GDS35039	Drive Shaft		25	22	60	73.5	977	
	2004.12-	2007.03	MT		R	F	Hatchback Engine M266.960	GCI35011	Inner Joint		22	27	36	459	81	
	2004.12-	2007.03			R	F	Hatchback Engine M266.960	GDS35045	Drive Shaft		25	22	56	73.5	985	
	2004.12-	2007.03			R	F	Hatchback Engine M266.960	GDS35055	Drive Shaft		25	27	60	73.5	948	
	2004.12-	2007.03			R	F	Hatchback Engine M266.960	GCI35040	Inner Joint		27	25	38	422	100	
A 200 CDI (100 kW)	2004.12-	2007.03					Hatchback Engine M266.960	GC035027	Outer Joint		25	27	60.3	43	53	I
	2004.09-	2012.06	AT		L	F	Hatchback Engine OM640.941	GDS35025	Drive Shaft		25	27	60	73.5	613	
	2004.09-	2012.06	MT		L	F	Hatchback Engine OM640.941	GDS35082	Drive Shaft		25	27	60.4	74	583	
	2004.09-	2012.06			L	F	Hatchback Engine OM640.941	GDS35054	Drive Shaft		25	27	60	73.5	608	
	2004.09-	2012.06			L	F	Hatchback Engine OM640.941	GCI35024	Inner Joint		27	25	38	62	120	
	2004.09-	2012.06			L/R	F	Hatchback Engine OM640.941	GC099037	Outer Joint		25	25	60	73.5	58.5	I
	2004.09-	2012.06	MT		R	F	Hatchback Engine OM640.941	GDS35081	Drive Shaft		25	27	60	73.5	987	
	2004.09-	2012.06			R	F	Hatchback Engine OM640.941	GDS35055	Drive Shaft		25	27	60	73.5	948	
A 200 CDI (103 kW)	2004.09-	2012.06			R	F	Hatchback Engine OM640.941	GCI35040	Inner Joint		27	25	38	422	100	
	2004.09-	2012.06					Hatchback Engine OM640.941	GC035040	Outer Joint		25	27	56	73.5	53.5	I
	2004.12-	2012.06				F	Hatchback Engine OM640.941	GC099037	Outer Joint		25	25	60	73.5	58.5	I
	2004.12-	2012.06	MT			F	Hatchback Engine OM640.941	GCI35014	Inner Joint		27	25	38	62	102	
	2004.12-	2012.06			L	F	Hatchback Engine OM640.941	GDS99296	Drive Shaft		25	27	60	73.5	598	
	2004.12-	2012.06	AT		L	F	Hatchback Engine OM640.941	GDS35025	Drive Shaft		25	27	60	73.5	613	
	2004.12-	2012.06	MT		L	F	Hatchback Engine OM640.941	GDS35082	Drive Shaft		25	27	60.4	74	583	
	2004.12-	2012.06			L	F	Hatchback Engine OM640.941	GDS35054	Drive Shaft		25	27	60	73.5	608	
	2004.12-	2012.06			L	F	Hatchback Engine OM640.941	GCI35024	Inner Joint		27	25	38	62	120	
	2004.12-	2012.06			L/R	F	Hatchback Engine OM640.941	GC099037	Outer Joint		25	25	60	73.5	58.5	I
	2004.12-	2012.06	MT		R	F	Hatchback Engine OM640.941	GDS35062	Drive Shaft		25	27	60.4	74	98.9	
	2004.12-	2012.06	MT		R	F	Hatchback Engine OM640.941	GCI35012	Inner Joint		27	25	38	476	83	
A 200 TURBO (142 kW)	2004.12-	2012.06	MT		R	F	Hatchback Engine OM640.941	GC035030	Outer Joint		25	25	60.4	74	56	I
	2004.12-	2012.06			R	F	Hatchback Engine OM640.941	GDS35055	Drive Shaft		25	27	60	73.5	948	
	2004.12-	2012.06			R	F	Hatchback Engine OM640.941	GCI35040	Inner Joint		27	25	38	422	100	
	2004.12-	2012.06					Hatchback Engine OM640.941	GC035040	Outer Joint		25	27	56	73.5	53.5	I
	2005.10-	2012.06				F	Hatchback Engine M266.980	GC099037	Outer Joint		25	25	60	73.5	58.5	I
	2005.10-	2012.06	MT			F	Hatchback Engine M266.980	GCI35014	Inner Joint		27	25	38	62	102	
	2005.10-	2012.06	AT		L	F	Hatchback Engine M266.980	GDS35025	Drive Shaft		25	27	60	73.5	613	
	2005.10-	2012.06	MT		L	F	Hatchback Engine M266.980	GDS35082	Drive Shaft		25	27	60.4	74	583	
	2005.10-	2012.06			L	F	Hatchback Engine M266.980	GDS35054	Drive Shaft		25	27	60	73.5	608	
	2005.10-	2012.06			L	F	Hatchback Engine M266.980	GCI35024	Inner Joint		27	25	38	62	120	
	2005.10-	2012.06			L/R	F	Hatchback Engine M266.980	GC099037	Outer Joint		25	25	60	73.5	58.5	I
	2005.10-	2012.06	MT		R	F	Hatchback Engine M266.980	GDS35081	Drive Shaft		25	27	60	73.5	987	
<b>A-CLASSE</b>																
A 160	1999.01-	2006.12	MT					GCI35015	Inner Joint		22	28	36	55	79	
	1999.01-	2006.12	MT					GC035021	Outer Joint	48W	24	28	57	67	50	I
A 190	2000.01-	2006.12	MT					GCI35015	Inner Joint		22	28	36	55	79	
	2000.01-	2006.12	MT					GC035032	Outer Joint	48W	24	28	57	67	54	I
<b>B-CLASS (W245)</b>																
B 150 (70 kW)	2005.07-	2011.11				F	Hatchback Engine M266.920	GC035026	Outer Joint		25	27	60	73.5	52	I
	2005.07-	2011.11	AT		L	F	Hatchback Engine M266.920	GDS35025	Drive Shaft		25	27	60	73.5	613	
	2005.07-	2011.11	MT		L	F	Hatchback Engine M266.920	GDS35057	Drive Shaft		25	22	60	73.5	580	
	2005.07-	2011.11			L	F	Hatchback Engine M266.920	GDS35054	Drive Shaft		25	27	60	73.5	608	
	2005.07-	2011.11			L	F	Hatchback Engine M266.920	GCI35024	Inner Joint		27	25	38	62	120	
	2005.07-	2011.11			L/R	F	Hatchback Engine M266.920	GC099037	Outer Joint		25	25	60	73.5	58.5	I
	2005.07-	2011.11	MT		R	F	Hatchback Engine M266.920	GDS35039	Drive Shaft		25	22	60	73.5	977	
	2005.07-	2011.11	MT		R	F	Hatchback Engine M266.920	GCI35011	Inner Joint		22	27	36	459	81	
	2005.07-	2011.11			R	F	Hatchback Engine M266.920	GDS35055	Drive Shaft		25	27	60	73.5	948	
	2005.07-	2011.11			R	F	Hatchback Engine M266.920	GCI35040	Inner Joint		27	25	38	422	100	
	2005.07-	2011.11	MT/AT				Hatchback Engine M266.920	GC035040	Outer Joint		25	27	56	73.5	53.5	I
B 160 (70 kW)	2009.04-	2011.11				F	Hatchback Engine M266.920	GC035026	Outer Joint		25	27	60	73.5	52	I
	2009.04-	2011.11	AT		L	F	Hatchback Engine M266.920	GDS35025	Drive Shaft		25	27	60	73.5	613	



		YEAR	TRANSM	L/R	F/R		G-AP Ref.	PRODUCT	ABS	Technical Specifications						
										A	B	C	H	L	P	
<b>MERCEDES BENZ</b>																
<b>B-CLASS (W245)</b>																
B 160 (70 kW)	2009.04-	2011.11	AT	L	F	Hatchback Engine M266.920	GDS35054	Drive Shaft		25	27	60	73.5	608		
	2009.04-	2011.11	AT	L	F	Hatchback Engine M266.920	GCI35024	Inner Joint		27	25	38	62	120		
	2009.04-	2011.11	MT	L	F	Hatchback Engine M266.920	GDS35057	Drive Shaft		25	22	60	73.5	580		
	2009.04-	2011.11	AT	L/R	F	Hatchback Engine M266.920	GC099037	Outer Joint		25	25	60	73.5	58.5	I	
	2009.04-	2011.11	AT	R	F	Hatchback Engine M266.920	GDS35055	Drive Shaft		25	27	60	73.5	948		
	2009.04-	2011.11	AT	R	F	Hatchback Engine M266.920	GCI35040	Inner Joint		27	25	38	422	100		
	2009.04-	2011.11	MT	R	F	Hatchback Engine M266.920	GDS35045	Drive Shaft		25	22	56	73.5	985		
	2009.04-	2011.11	MT	R	F	Hatchback Engine M266.920	GCI35011	Inner Joint		22	27	36	459	81		
	2009.04-	2011.11				Hatchback Engine M266.920	GC035040	Outer Joint		25	27	56	73.5	53.5	I	
B 170 (85 kW)	2005.07-	2011.11			F	Hatchback Engine M266.940	GC035026	Outer Joint		25	27	60	73.5	52	I	
	2005.07-	2011.11	AT	L	F	Hatchback Engine M266.940	GDS35025	Drive Shaft		25	27	60	73.5	613		
	2005.07-	2011.11	MT	L	F	Hatchback Engine M266.940	GDS35057	Drive Shaft		25	22	60	73.5	580		
	2005.07-	2011.11		L	F	Hatchback Engine M266.940	GDS35054	Drive Shaft		25	27	60	73.5	608		
	2005.07-	2011.11		L	F	Hatchback Engine M266.940	GCI35024	Inner Joint		27	25	38	62	120		
	2005.07-	2011.11		L/R	F	Hatchback Engine M266.940	GC099037	Outer Joint		25	25	60	73.5	58.5	I	
	2005.07-	2011.11	MT	R	F	Hatchback Engine M266.940	GDS35039	Drive Shaft		25	22	60	73.5	977		
	2005.07-	2011.11	MT	R	F	Hatchback Engine M266.940	GCI35011	Inner Joint		22	27	36	459	81		
	2005.07-	2011.11		R	F	Hatchback Engine M266.940	GDS35055	Drive Shaft		25	27	60	73.5	948		
	2005.07-	2011.11		R	F	Hatchback Engine M266.940	GCI35040	Inner Joint		27	25	38	422	100		
B 170 NGT (85 kW)	2008.04-	2011.11		L	F	Hatchback Engine M266.960	GDS35054	Drive Shaft		25	27	60	73.5	608		
	2008.04-	2011.11		L	F	Hatchback Engine M266.960	GCI35024	Inner Joint		27	25	38	62	120		
	2008.04-	2011.11		L/R	F	Hatchback Engine M266.960	GC099037	Outer Joint		25	25	60	73.5	58.5	I	
	2008.04-	2011.11		R	F	Hatchback Engine M266.960	GDS35055	Drive Shaft		25	27	60	73.5	948		
	2008.04-	2011.11		R	F	Hatchback Engine M266.960	GCI35040	Inner Joint		27	25	38	422	100		
B 180 (85 kW)	2009.04-	2011.11			F	Hatchback Engine M266.940	GC035026	Outer Joint		25	27	60	73.5	52	I	
	2009.04-	2011.11	AT	L	F	Hatchback Engine M266.940	GDS35025	Drive Shaft		25	27	60	73.5	613		
	2009.04-	2011.11	MT	L	F	Hatchback Engine M266.940	GDS35057	Drive Shaft		25	22	60	73.5	580		
	2009.04-	2011.11		L	F	Hatchback Engine M266.940	GDS35054	Drive Shaft		25	27	60	73.5	608		
	2009.04-	2011.11		L	F	Hatchback Engine M266.940	GCI35024	Inner Joint		27	25	38	62	120		
	2009.04-	2011.11		L/R	F	Hatchback Engine M266.940	GC099037	Outer Joint		25	25	60	73.5	58.5	I	
	2009.04-	2011.11	MT	R	F	Hatchback Engine M266.940	GDS35039	Drive Shaft		25	22	60	73.5	977		
	2009.04-	2011.11	MT	R	F	Hatchback Engine M266.940	GCI35011	Inner Joint		22	27	36	459	81		
	2009.04-	2011.11		R	F	Hatchback Engine M266.940	GDS35055	Drive Shaft		25	27	60	73.5	948		
	2009.04-	2011.11		R	F	Hatchback Engine M266.940	GCI35040	Inner Joint		27	25	38	422	100		
	2009.04-	2011.11				Hatchback Engine M266.940	GC035040	Outer Joint		25	27	56	73.5	53.5	I	
B 180 CDi (80 kW)	2005.07-	2011.11			F	Hatchback Engine OM640.940	GC099037	Outer Joint		25	25	60	73.5	58.5	I	
	2005.07-	2011.11	MT		F	Hatchback Engine OM640.940	GCI35014	Inner Joint		27	25	38	62	102		
	2005.07-	2011.11		L	F	Hatchback Engine OM640.940	GDS99296	Drive Shaft		25	27	60	73.5	598		
	2005.07-	2011.11	AT	L	F	Hatchback Engine OM640.940	GDS35025	Drive Shaft		25	27	60	73.5	613		
	2005.07-	2011.11	MT	L	F	Hatchback Engine OM640.940	GDS35082	Drive Shaft		25	27	60.4	74	583		
	2005.07-	2011.11		L	F	Hatchback Engine OM640.940	GDS35054	Drive Shaft		25	27	60	73.5	608		
	2005.07-	2011.11		L	F	Hatchback Engine OM640.940	GCI35024	Inner Joint		27	25	38	62	120		
	2005.07-	2011.11		L/R	F	Hatchback Engine OM640.940	GC099037	Outer Joint		25	25	60	73.5	58.5	I	
	2005.07-	2011.11	AT	R	F	Hatchback Engine OM640.940	GDS35049	Drive Shaft		25	27	60	73.5	954		
	2005.07-	2011.11	MT	R	F	Hatchback Engine OM640.940	GDS35062	Drive Shaft		25	27	60.4	74	989		
	2005.07-	2011.11	MT	R	F	Hatchback Engine OM640.940	GCI35012	Inner Joint		27	25	38	476	83		
	2005.07-	2011.11	MT	R	F	Hatchback Engine OM640.940	GC035030	Outer Joint		25	25	60.4	74	56	I	
	2005.07-	2011.11		R	F	Hatchback Engine OM640.940	GDS35055	Drive Shaft		25	27	60	73.5	948		
	2005.07-	2011.11		R	F	Hatchback Engine OM640.940	GCI35040	Inner Joint		27	25	38	422	100		
	B 180 NGT (85 kW)	2008.04-	2011.11		L	F	Hatchback Engine M266.960	GDS35054	Drive Shaft		25	27	60	73.5	608	
2008.04-		2011.11		L	F	Hatchback Engine M266.960	GCI35024	Inner Joint		27	25	38	62	120		
2008.04-		2011.11		L/R	F	Hatchback Engine M266.960	GC099037	Outer Joint		25	25	60	73.5	58.5	I	
2008.04-		2011.11		R	F	Hatchback Engine M266.960	GDS35055	Drive Shaft		25	27	60	73.5	948		
2008.04-		2011.11		R	F	Hatchback Engine M266.960	GCI35040	Inner Joint		27	25	38	422	100		
B 200 (100 kW)	2005.07-	2011.11			F	Hatchback Engine M266.960	GC035026	Outer Joint		25	27	60	73.5	52	I	
	2005.07-	2011.11	AT	L	F	Hatchback Engine M266.960	GDS35025	Drive Shaft		25	27	60	73.5	613		
	2005.07-	2011.11		L	F	Hatchback Engine M266.960	GDS35054	Drive Shaft		25	27	60	73.5	608		
	2005.07-	2011.11		L	F	Hatchback Engine M266.960	GCI35024	Inner Joint		27	25	38	62	120		
	2005.07-	2011.11		L/R	F	Hatchback Engine M266.960	GC099037	Outer Joint		25	25	60	73.5	58.5	I	
	2005.07-	2011.11	AT	R	F	Hatchback Engine M266.960	GDS35049	Drive Shaft		25	27	60	73.5	954		
	2005.07-	2011.11		R	F	Hatchback Engine M266.960	GDS35055	Drive Shaft		25	27	60	73.5	948		





		TRANSM	L/R	F/R		G-AP Ref.	PRODUCT	ABS	Technical Specifications															
									YEAR	A	B	C	H	L	P									
<b>MERCEDES BENZ</b>																								
<b>B-CLASS (W245)</b>																								
B 200 (100 kW)	2005.07-	2011.11			R	F	Hatchback Engine M266.960	GCI35040	Inner Joint		27	25	38	422	100									
B 200 CDI (103 kW)	2005.07-	2011.11				F	Hatchback Engine OM640.941	GC099037	Outer Joint		25	25	60	73.5	58.5	I								
	2005.07-	2011.11	MT			F	Hatchback Engine OM640.941	GCI35014	Inner Joint		27	25	38	62	102									
	2005.07-	2011.11			L	F	Hatchback Engine OM640.941	GDS99296	Drive Shaft		25	27	60	73.5	598									
	2005.07-	2011.11	AT		L	F	Hatchback Engine OM640.941	GDS35025	Drive Shaft		25	27	60	73.5	613									
	2005.07-	2011.11	MT		L	F	Hatchback Engine OM640.941	GDS35082	Drive Shaft		25	27	60.4	74	583									
	2005.07-	2011.11			L	F	Hatchback Engine OM640.941	GDS35054	Drive Shaft		25	27	60	73.5	608									
	2005.07-	2011.11			L	F	Hatchback Engine OM640.941	GCI35024	Inner Joint		27	25	38	62	120									
	2005.07-	2011.11			L/R	F	Hatchback Engine OM640.941	GC099037	Outer Joint		25	25	60	73.5	58.5	I								
	2005.07-	2011.11	AT		R	F	Hatchback Engine OM640.941	GDS35049	Drive Shaft		25	27	60	73.5	954									
	2005.07-	2011.11	MT		R	F	Hatchback Engine OM640.941	GDS35062	Drive Shaft		25	27	60.4	74	989									
	2005.07-	2011.11	MT		R	F	Hatchback Engine OM640.941	GCI35012	Inner Joint		27	25	38	476	83									
	2005.07-	2011.11	MT		R	F	Hatchback Engine OM640.941	GC035030	Outer Joint		25	25	60.4	74	56	I								
2005.07-	2011.11			R	F	Hatchback Engine OM640.941	GDS35055	Drive Shaft		25	27	60	73.5	948										
2005.07-	2011.11			R	F	Hatchback Engine OM640.941	GCI35040	Inner Joint		27	25	38	422	100										
B 200 TURBO (142 kW)	2005.07-	2011.11				F	Hatchback Engine M266.980	GC099037	Outer Joint		25	25	60	73.5	58.5	I								
	2005.07-	2011.11	MT			F	Hatchback Engine M266.980	GCI35014	Inner Joint		27	25	38	62	102									
	2005.07-	2011.11	CVT		L	F	Hatchback Engine M266.980	GDS35025	Drive Shaft		25	27	60	73.5	613									
	2005.07-	2011.11			L	F	Hatchback Engine M266.980	GDS35054	Drive Shaft		25	27	60	73.5	608									
	2005.07-	2011.11			L	F	Hatchback Engine M266.980	GCI35024	Inner Joint		27	25	38	62	120									
	2005.07-	2011.11			L/R	F	Hatchback Engine M266.980	GC099037	Outer Joint		25	25	60	73.5	58.5	I								
	2005.07-	2011.11			R	F	Hatchback Engine M266.980	GDS35055	Drive Shaft		25	27	60	73.5	948									
2005.07-	2011.11			R	F	Hatchback Engine M266.980	GCI35040	Inner Joint		27	25	38	422	100										
<b>C-CLASS (S202)</b>																								
C 180 T (90 kW)	1996.06-	2000.09	MT/AT		L/R	R	Estate Engine M111.920/M111.921	GDS35007	Drive Shaft		25		62	70.5	630									
C 200 T (100 kW)	1996.06-	2001.03	MT/AT		L/R	R	Estate Engine M111.941/M111.945	GDS35007	Drive Shaft		25		62	70.5	630									
C 220 T D (55 kW)	1996.06-	2001.03			L/R	R	Estate Engine OM604.910	GDS35007	Drive Shaft		25		62	70.5	630									
C 220 T D (70 kW)	1996.06-	1998.09	MT/AT		L/R	R	Estate Engine OM604.910	GDS35007	Drive Shaft		25		62	70.5	630									
C 230 T (110 kW)	1996.06-	1998.06	MT/AT		L/R	R	Estate Engine M111.974	GDS35007	Drive Shaft		25		62	70.5	630									
<b>C-CLASS (W202)</b>																								
C 180 (90 kW)	1993.03-	2000.05	MT/AT		L/R	R	Saloon Engine M111.920/M111.921	GDS35007	Drive Shaft		25		62	70.5	630									
C 200 (100 kW)	1994.01-	2000.05	MT/AT		L/R	R	Saloon Engine M111.941/M111.945	GDS35007	Drive Shaft		25		62	70.5	630									
C 200 D (55 kW)	1993.03-	2000.05	MT/AT		L/R	R	Saloon Engine OM601.913	GDS35007	Drive Shaft		25		62	70.5	630									
C 220 (110 kW)	1993.03-	2000.05	MT/AT		L/R	R	Saloon Engine M111.961	GDS35007	Drive Shaft		25		62	70.5	630									
C 220 D (70 kW)	1993.08-	2000.05	MT/AT		L/R	R	Saloon Engine OM604.910	GDS35007	Drive Shaft		25		62	70.5	630									
C 230 (110 kW)	1996.06-	1997.06	MT/AT		L/R	R	Saloon Engine M111.974	GDS35007	Drive Shaft		25		62	70.5	630									
<b>CLASSE A I (W168)</b>																								
A 140 (60 kW)	1997.07-	2004.08			L		Engine M166.940	GCI35013	Inner Joint		22	27	36	55	79									
	1997.07-	2004.08			R		Engine M166.940	GCI35010	Inner Joint		22	27	36	459	61									
A 160 (75 kW)	1997.07-	2004.08			L		Engine M 166.960	GCI35013	Inner Joint		22	27	36	55	79									
	1997.07-	2004.08			R		Engine M 166.960	GCI35010	Inner Joint		22	27	36	459	61									
A 160 CDi (44 kW)	1998.07-	2001.02			L		Engine OM668.941	GCI35013	Inner Joint		22	27	36	55	79									
	1998.07-	2001.02			R		Engine OM668.941	GCI35010	Inner Joint		22	27	36	459	61									
A 160 CDi (55 kW)	2001.02-	2004.08			L		Engine OM668.940	GCI35013	Inner Joint		22	27	36	55	79									
	2001.02-	2004.08			R		Engine OM668.940	GCI35010	Inner Joint		22	27	36	459	61									
A 170 CDi (66 kW)	1998.07-	2001.02	MT		L		Engine OM668.940	GCI35013	Inner Joint		22	27	36	55	79									
	1998.07-	2001.02	MT		R		Engine OM668.940	GCI35010	Inner Joint		22	27	36	459	61									
A 170 CDi (70 kW)	2001.02-	2004.08			L		Engine OM668.942	GCI35013	Inner Joint		22	27	36	55	79									
	2001.02-	2004.08			R		Engine OM668.942	GCI35010	Inner Joint		22	27	36	459	61									
A 190 (92 kW)	1999.03-	2004.08			L		Engine OM166.990	GCI35013	Inner Joint		22	27	36	55	79									
	1999.03-	2004.08			R		Engine OM166.990	GCI35010	Inner Joint		22	27	36	459	61									
<b>CLASSE A II (W169)</b>																								
A 150 (70 kW)	2004.09-				L		Engine 266.920	GCI99136	Inner Joint		22	27	36	55	100									
	2004.09-				R		Engine 266.920	GCI35011	Inner Joint		22	27	36	459	81									
	2004.09-						Engine 266.920	GC035026	Outer Joint		25	27	60	73.5	52	I								
	2004.09-						Engine 266.920	GC035027	Outer Joint		25	27	60.3	43	53	I								
	2004.09-							GC035020	Outer Joint		25	27	60	73.5	50	I								
A 160 (70 kW)	2004-		MT		L		Engine 266.920	GCI99136	Inner Joint		22	27	36	55	100									
	2004-		MT		R		Engine 266.920	GCI35011	Inner Joint		22	27	36	459	81									
	2004-		MT				Engine 266.920	GC035026	Outer Joint		25	27	60	73.5	52	I								
	2004-		MT				Engine 266.920	GC035027	Outer Joint		25	27	60.3	43	53	I								









		TRANSM	L/R	F/R		G-AP Ref.	PRODUCT	ABS	Technical Specifications								
									YEAR	A	B	C	H	L	P		
<b>MERCEDES BENZ</b>																	
<b>CLASSE A II (W169)</b>																	
A 160 CDi (60 kW)	2004-		MT	L	Engine 640.920	GCI99136	Inner Joint		22	27	36	55	100				
	2004-		MT	R	Engine 640.920	GCI35011	Inner Joint		22	27	36	459	81				
	2004-		MT		Engine 640.920	GC035026	Outer Joint		25	27	60	73.5	52	I			
	2004-		MT		Engine 64C.920	GC035027	Outer Joint		25	27	60.3	43	53	I			
A 170 (85 kW)	2004-		MT	L	Engine 266.940	GCI99136	Inner Joint		22	27	36	55	100				
	2004-		MT	R	Engine 266.940	GCI35011	Inner Joint		22	27	36	459	81				
	2004-		MT		Engine 266.940	GC035026	Outer Joint		25	27	60	73.5	52	I			
	2004-		MT		Engine 266.940	GC035027	Outer Joint		25	27	60.3	43	53	I			
A 170 NGT (85 kW)	2008-		MT	L	Engine 266.940	GCI99136	Inner Joint		22	27	36	55	100				
	2008-		MT	R	Engine 266.940	GCI35011	Inner Joint		22	27	36	459	81				
	2008-		MT		Engine 266.940	GC035026	Outer Joint		25	27	60	73.5	52	I			
	2008-		MT		Engine 266.940	GC035027	Outer Joint		25	27	60.3	43	53	I			
A 180 (85 kW)	2009-		MT	L	Engine 266.940	GCI99136	Inner Joint		22	27	36	55	100				
	2009-		MT	R	Engine 266.940	GCI35011	Inner Joint		22	27	36	459	81				
	2009-		MT		Engine 266.940	GC035026	Outer Joint		25	27	60	73.5	52	I			
	2009-		MT		Engine 266.940	GC035027	Outer Joint		25	27	60.3	43	53	I			
A 180 CDi (80 kW)	2004-		AT	L		GCI35024	Inner Joint		27	25	38	62	120				
	2004-		MT	L	Engine 640.940	GCI35014	Inner Joint		27	25	38	62	102				
	2004-		AT	R		GCI35040	Inner Joint		27	25	38	422	100				
	2004-		MT	R	Engine 640.940	GCI35012	Inner Joint		27	25	38	476	83				
	2004-		MT		Engine 640.940	GC099037	Outer Joint		25	25	60	73.5	58.5	I			
	2004-		MT		Engine 640.940	GC035019	Outer Joint		25	25	60.5	42	59	I			
A 200 (100 kW)	2004-		MT	L	Engine 266.920	GCI99136	Inner Joint		22	27	36	55	100				
	2004-		MT	R	Engine 266.920	GCI35011	Inner Joint		22	27	36	459	81				
	2004-		MT		Engine 256.920	GC035026	Outer Joint		25	27	60	73.5	52	I			
	2004-		MT		Engine 266.960	GC035027	Outer Joint		25	27	60.3	43	53	I			
A 200 CDi (100 kW)	2004-		AT	L		GCI35024	Inner Joint		27	25	38	62	120				
	2004-		MT	L	Engine 640.941	GCI35014	Inner Joint		27	25	38	62	102				
	2004-		AT	R		GCI35040	Inner Joint		27	25	38	422	100				
	2004-		MT	R	Engine 640.941	GCI35012	Inner Joint		27	25	38	476	83				
	2004-		MT		Engine 640.941	GC099037	Outer Joint		25	25	60	73.5	58.5	I			
	2004-		MT		Engine 640.941	GC035019	Outer Joint		25	25	60.5	42	59	I			
A 200 CDi (103 kW)	2004-		AT	L		GCI35024	Inner Joint		27	25	38	62	120				
	2004-		MT	L	Engine 640.941	GCI35014	Inner Joint		27	25	38	62	102				
	2004-		AT	R		GCI35040	Inner Joint		27	25	38	422	100				
	2004-		MT		Engine 640.941	GC099037	Outer Joint		25	25	60	73.5	58.5	I			
	2004-		MT		Engine 640.941	GC035019	Outer Joint		25	25	60.5	42	59	I			
A 200 CDi (130 kW)	2004-		MT	R	Engine 640.941	GCI35012	Inner Joint		27	25	38	476	83				
A 200 T (142 kW)	2005-		AT	L		GCI35024	Inner Joint		27	25	38	62	120				
	2005-		MT	L	Engine 266.980	GCI35014	Inner Joint		27	25	38	62	102				
	2005-		AT	R		GCI35040	Inner Joint		27	25	38	422	100				
	2005-		MT	R	Engine 266.980	GCI35012	Inner Joint		27	25	38	476	83				
	2005-		MT		Engine 266.980	GC099037	Outer Joint		25	25	60	73.5	58.5	I			
2005-		MT		Engine 266.980	GC035019	Outer Joint		25	25	60.5	42	59	I				
<b>CLASSE A III (W169)</b>																	
A 150 (70 kW)	2008.01-		AT			GC035030	Outer Joint		25	25	60.4	74	56	I			
A 160 (70 kW)	2009.04-		AT			GC035030	Outer Joint		25	25	60.4	74	56	I			
A 160 CDi (60 kW)	2008.01-		AT			GC035030	Outer Joint		25	25	60.4	74	56	I			
A 170 (85 kW)	2008.01-		AT			GC035030	Outer Joint		25	25	60.4	74	56	I			
A 180 (85 kW)	2009.04-		AT			GC035030	Outer Joint		25	25	60.4	74	56	I			
A 200 (100 kW)	2008.01-		AT			GC035030	Outer Joint		25	25	60.4	74	56	I			
A 200 CDi (103 kW)	2008.01-		AT			GC035030	Outer Joint		25	25	60.4	74	56	I			
A 200 T (142 kW)	2008.01-		AT			GC035030	Outer Joint		25	25	60.4	74	56	I			
<b>CLASSE B I (W245)</b>																	
B 150 (70 kW)	2005-		MT	L	Engine 266.920	GCI99136	Inner Joint		22	27	36	55	100				
	2005-		MT	R	Engine 266.920	GCI35011	Inner Joint		22	27	36	459	81				
	2005-		MT		Engine 266.92C	GC035027	Outer Joint		25	27	60.3	43	53	I			
	2005-		MT		Engine 266920	GC035026	Outer Joint		25	27	60	73.5	52	I			
B 160 (70 kW)	2009-		MT	L	Engine 266.920	GCI99136	Inner Joint		22	27	36	55	100				
	2009-		MT	R	Engine 266.920	GCI35011	Inner Joint		22	27	36	459	81				
	2009-		MT		Engine 266.920	GC035026	Outer Joint		25	27	60	73.5	52	I			
	2009-		MT		Engine 266.920	GC035027	Outer Joint		25	27	60.3	43	53	I			

		TRANSM	L/R	F/R		G-AP Ref.	PRODUCT	ABS	Technical Specifications							
									YEAR	A	B	C	H	L	P	
<b>MERCEDES BENZ</b>																
<b>CLASSE B I (W245)</b>																
B 170 (85 kW)	2005-		MT	L	Engine 266.940	GCI99136	Inner Joint		22	27	36	55	100			
	2005-		MT	R	Engine 266.940	GCI35011	Inner Joint		22	27	36	459	81			
	2005-		MT		Engine 266.940	GC035026	Outer Joint		25	27	60	73.5	52	I		
	2005-		MT		Engine 266.940	GC035027	Outer Joint		25	27	60.3	43	53	I		
B 180 (85 kW)	2009-		MT	L	Engine 266.940	GCI99136	Inner Joint		22	27	36	55	100			
	2009-		MT	R	Engine 266.940	GCI35011	Inner Joint		22	27	36	459	81			
	2009-		MT		Engine 266.940	GC035026	Outer Joint		25	27	60	73.5	52	I		
	2009-		MT		Engine 266.940	GC035027	Outer Joint		25	27	60.3	43	53	I		
B 180 CDI (80 kW)	2005-		AT	L		GCI35024	Inner Joint		27	25	38	62	120			
	2005-		MT	L	Engine 640.940	GCI35014	Inner Joint		27	25	38	62	102			
	2005-		AT	R		GCI35040	Inner Joint		27	25	38	422	100			
	2005-		MT	R	Engine 640.940	GCI35012	Inner Joint		27	25	38	476	83			
	2005-		MT		Engine 640.940	GC099037	Outer Joint		25	25	60	73.5	58.5	I		
	2005-		MT		Engine 640.940	GC035019	Outer Joint		25	25	60.5	42	59	I		
B 180 NGT (85 kW)	2008-2011		MT		Engine 266.940	GC035026	Outer Joint		25	27	60	73.5	52	I		
	2008-2011		MT		Engine 266.940	GC035027	Outer Joint		25	27	60.3	43	53	I		
	2008.11-		MT	L	Engine 266.940	GCI99136	Inner Joint		22	27	36	55	100			
	2008.11-		MT	R	Engine 266.940	GCI35011	Inner Joint		22	27	36	459	81			
B 200 (100 kW)	2005-		MT	L	Engine 266.960	GCI99136	Inner Joint		22	27	36	55	100			
	2005-		MT	R	Engine 266.960	GCI35011	Inner Joint		22	27	36	459	81			
	2005-		MT		Engine 266.960	GC035026	Outer Joint		25	27	60	73.5	52	I		
	2005-		MT		Engine 266.960	GC035027	Outer Joint		25	27	60.3	43	53	I		
B 200 CDI (103 kW)	2005-		AT	L		GCI35024	Inner Joint		27	25	38	62	120			
	2005-		MT	L	Engine 640.941	GCI35014	Inner Joint		27	25	38	62	102			
	2005-		AT	R		GCI35040	Inner Joint		27	25	38	422	100			
	2005-		MT	R	Engine 640.941	GCI35012	Inner Joint		27	25	38	476	83			
	2005-		MT		Engine 640.941	GC099037	Outer Joint		25	25	60	73.5	58.5	I		
	2005-		MT		Engine 640.941	GC035019	Outer Joint		25	25	60.5	42	59	I		
B 200 T (142 kW)	2005-		AT	L		GCI35024	Inner Joint		27	25	38	62	120			
	2005-		MT	L	Engine 266.980	GCI35014	Inner Joint		27	25	38	62	102			
	2005-		AT	R		GCI35040	Inner Joint		27	25	38	422	100			
	2005-		MT	R	Engine 266.980	GCI35012	Inner Joint		27	25	38	476	83			
	2005-		MT		Engine 266.980	GC099037	Outer Joint		25	25	60	73.5	58.5	I		
	2005-		MT		Engine 266.980	GC035019	Outer Joint		25	25	60.5	42	59	I		
<b>CLASSE B II (W245)</b>																
B 150 (70 kW)	2005.06-2008.04		MT	L	Engine 266.920	GCI99136	Inner Joint		22	27	36	55	100			
	2005.06-2008.04		MT	R	Engine 266.920	GCI35011	Inner Joint		22	27	36	459	81			
	2009.01-2011.11		AT			GC035030	Outer Joint		25	25	60.4	74	56	I		
B 160 (70 kW)	2009.04-2011.11		MT	L	Engine 266.920	GCI99136	Inner Joint		22	27	36	55	100			
	2009.04-2011.11		MT	R	Engine 266.920	GCI35011	Inner Joint		22	27	36	459	81			
	2009.04-2011.11		AT			GC035030	Outer Joint		25	25	60.4	74	56	I		
B 170 (85 kW)	2005.06-2008.04		MT	L	Engine 266.920	GCI99136	Inner Joint		22	27	36	55	100			
	2005.06-2008.04		MT	R	Engine 266.920	GCI35011	Inner Joint		22	27	36	459	81			
	2009.01-2011.11		AT			GC035030	Outer Joint		25	25	60.4	74	56	I		
B 180 (85 kW)	2009.01-2011.11		MT	L	Engine 266.940	GCI99136	Inner Joint		22	27	36	55	100			
	2009.01-2011.11		MT	R	Engine 266.940	GCI35011	Inner Joint		22	27	36	459	81			
	2009.01-2011.11		AT			GC035030	Outer Joint		25	25	60.4	74	56	I		
B 180 NGT (85 kW)	2008.04-2011.11		MT	L	Engine 266.960	GCI99136	Inner Joint		22	27	36	55	100			
	2008.04-2011.11		MT	R	Engine 266.960	GCI35011	Inner Joint		22	27	36	459	81			
	2008.04-2011.11		AT			GC035030	Outer Joint		25	25	60.4	74	56	I		
B 200 (100 kW)	2009.04-2011.11		MT	L	Engine 640.941	GCI99136	Inner Joint		22	27	36	55	100			
	2009.04-2011.11		MT	R	Engine 640.941	GCI35011	Inner Joint		22	27	36	459	81			
	2009.04-2011.11		AT			GC035030	Outer Joint		25	25	60.4	74	56	I		
B 200 CDI (103 kW)	2009.04-2011.11		AT		GC035030	Outer Joint		25	25	60.4	74	56	I			
B 200 T (142 kW)	2009.04-2011.11		AT		GC035030	Outer Joint		25	25	60.4	74	56	I			
<b>CLASSE GL (X164)</b>																
GL 320 CDI (165 kW)	2006.09-2009.05					GC085007	Outer Joint		30	37	70.2	90.5	65.5	I		
GL 420 CDI (225 kW)	2006.09-2009.05					GC085007	Outer Joint		30	37	70.2	90.5	65.5	I		
GL 450 CDI (250 kW)	2006.09-					GC085007	Outer Joint		30	37	70.2	90.5	65.5	I		
GL 500 (285 kW)	2006.09-					GC085007	Outer Joint		30	37	70.2	90.5	65.5	I		
<b>CLASSE M I (W163)</b>																
ML 230 (110 kW)	1998.02-2005.06					GC035016	Outer Joint	48W	30	26	79.1	89	60.5	I		



		TRANSM	L/R	F/R		G-AP Ref.	PRODUCT	ABS	Technical Specifications							
									YEAR	A	B	C	H	L	P	
<b>MERCEDES BENZ</b>																
<b>CLASSE M I (W163)</b>																
ML 270 CDi (120 kW)	1999.12-	2006.06				GC035016	Outer Joint	48W	30	26	79.1	89	60.5	I		
ML 320 (160 kW)	1998.02-	2002.08				GC035016	Outer Joint	48W	30	26	79.1	89	60.5	I		
ML 350 (173 kW)	2002.08-	2005.06				GC035016	Outer Joint	48W	30	26	79.1	89	60.5	I		
ML 350 (180 kW)	2002.08-	2005.06				GC035016	Outer Joint	48W	30	26	79.1	89	60.5	I		
ML 400 CDi (184 kW)	2001.09-	2005.06				GC035016	Outer Joint	48W	30	26	79.1	89	60.5	I		
ML 430 (200 kW)	1998.02-	2005.06				GC035016	Outer Joint	48W	30	26	79.1	89	60.5	I		
ML 500 (215 kW)	2001.09-	2005.06				GC035016	Outer Joint	48W	30	26	79.1	89	60.5	I		
ML 55 AMG (255 kW)	2000.02-	2005.06				GC035016	Outer Joint	48W	30	26	79.1	89	60.5	I		
<b>CLASSE M II (W164)</b>																
ML 280 CDi 4-matic (140 kW)	2005.07-	2009.07				GC085007	Outer Joint		30	37	70.2	90.5	65.5	I		
ML 320 CDi 4-matic (165 kW)	2005.07-	2009.07				GC085007	Outer Joint		30	37	70.2	90.5	65.5	I		
ML 350 4-matic (200 kW)	2005.07-					GC085007	Outer Joint		30	37	70.2	90.5	65.5	I		
ML 420 CDi 4-matic (225 kW)	2006.02-	2009.09				GC085007	Outer Joint		30	37	70.2	90.5	65.5	I		
ML 500 4-matic (225 kW)	2005.07-					GC085007	Outer Joint		30	37	70.2	90.5	65.5	I		
ML 500 4-matic (285 kW)	2005.07-					GC085007	Outer Joint		30	37	70.2	90.5	65.5	I		
<b>CLASSE R (W251, V251)</b>																
R 300 CDi (140 kW)	2009.07-					GC085007	Outer Joint		30	37	70.2	90.5	65.5	I		
R 300 CDi (165 kW)	2009.07-					GC085007	Outer Joint		30	37	70.2	90.5	65.5	I		
R 300 CDi 4-matic (140 kW)	2009.07-					GC085007	Outer Joint		30	37	70.2	90.5	65.5	I		
R 300 CDi 4-matic (165 kW)	2009.07-					GC085007	Outer Joint		30	37	70.2	90.5	65.5	I		
R 350 (200 kW)	2007.01-					GC085007	Outer Joint		30	37	70.2	90.5	65.5	I		
R 350 4-matic (200 kW)	2006.01-					GC085007	Outer Joint		30	37	70.2	90.5	65.5	I		
R 500 4-matic (225 kW)	2006.01-					GC085007	Outer Joint		30	37	70.2	90.5	65.5	I		
R 63 AMG (375 kW)	2006.02-					GC085007	Outer Joint		30	37	70.2	90.5	65.5	I		
<b>COUPE (C123)</b>																
230 CE (100 kW)	1980.04-	1985.12	MT/AT	L/R	R	Coupe Engine M102.980	Drive Shaft		27		60	32.5	627			
280 CE (136 kW)	1977.03-	1985.11	MT/AT	L/R	R	Coupe Engine M110.988	Drive Shaft		27		60	32.5	627			
300 C Turbo-D (92 kW)	1981.09-	1985.07	MT/AT	L/R	R	Coupe Engine OM617.952	Drive Shaft		27		60	32.5	627			
<b>COUPE (C124)</b>																
230 CE (100 kW)	1987.03-	1992.12	MT/AT	L/R	R	Coupe Engine M102.982	Drive Shaft		25		62	69	665			
230 CE (97 kW)	1987.03-	1992.12	MT/AT	L/R	R	Coupe Engine M102.982	Drive Shaft		25		62	69	665			
230 CE CAT (97 kW)	1989.06-	1992.12	MT/AT	L/R	R	Coupe Engine M102.982	Drive Shaft		25		62	69	665			
300 CE (132 kW)	1987.03-	1993.05	MT/AT	L/R	R	Coupe Engine M103.983	Drive Shaft		25		62	69	659			
300 CE (138 kW)	1987.03-	1989.12	MT/AT	L/R	R	Coupe Engine M103.983	Drive Shaft		25		62	69	659			
<b>E CLASS (W124)</b>																
2.0	1987-	1992		L/R	R		GCI35003	Inner Joint	25	25	62	69	56			
<b>E-CLASS (S124)</b>																
E 200 T (100 kW)	1993.06-	1996.06	MT/AT	L/R	R	Estate Engine M111.940	Drive Shaft		25		62	69	665			
E 300 T Turbo-D (108 kW)	1993.06-	1996.06	MT/AT	L/R	R	Estate Engine OM603.960	Drive Shaft		25		62	69	659			
<b>E-CLASS (S210)</b>																
E 240 T (125 kW)	1997.06-	2003.03			R	Estate Engine M112.911	Drive Shaft	48W	27		63.5	79.5	687.5			
	1997.06-	2003.03			R	Estate Engine M112.911	Inner Joint			25		26				
	1997.06-	2003.03			R	Estate Engine M112.911	Inner Joint		27	25	63.5	79.5	57			
	2000.08-	2003.03			R	Estate Engine M112.914	Drive Shaft	48W	27		63.5	79.5	687.5			
	2000.08-	2003.03			R	Estate Engine M112.914	Inner Joint			25		26				
	2000.08-	2003.03			R	Estate Engine M112.914	Inner Joint		27	25	63.5	79.5	57			
<b>E-CLASS (W124)</b>																
E 250 Turbo-D (93 kW)	1993.06-	1995.06	MT/AT	L/R	R	Saloon Engine OM602.962	Drive Shaft		25		62	69	659			
E 300 Turbo-D (108 kW)	1993.06-	1995.06	MT/AT	L/R	R	Saloon Engine OM603.960	Drive Shaft		25		62	69	659			
<b>E-CLASS (W210)</b>																
E 200 CDi (75 kW)	1998.06-	2002.03	MT/AT	L/R	R	Saloon Engine OM611.961	Drive Shaft	48T	25		62	70.5	660			
E 200 D (65 kW)	1996.01-	2002.03	MT/AT	L/R	R	Saloon Engine OM604.917	Inner Joint			24		27				
	1996.01-	2002.03	MT/AT	L/R	R	Saloon Engine OM604.917	Drive Shaft	48T	25		62	70.5	674			
E 200 Kompressor (120 kW)	2000.08-	2002.03			R	Saloon Engine M111.957	Drive Shaft	48T	25		62	70.5	674			
E 220 D (55 kW)	1996.05-	2002.03		L/R	R	Saloon Engine OM604.912	Drive Shaft	48T	25		62	70.5	674			
	1996.05-	2002.03			R	Saloon Engine OM604.912	Drive Shaft	48W	27		63.5	79.5	687.5			
E 240 (125 kW)	2000.08-	2002.03			R	Saloon Engine M112.914	Drive Shaft	48W	27		63.5	79.5	687.5			
E 280 (150 kW)	1996.12-	2002.03	MT/AT	L/R	R	Saloon Engine M112.921	Drive Shaft	48T	25		62	70.5	660			
E 280 4-matic (150 kW)	1996.12-	2002.03		L/R	R	Saloon Engine M112.921	Drive Shaft	48T	25		62	70.5	660			
E 320 4-matic (165 kW)	1997.06-	2002.03		L/R	R	Saloon Engine M112.941	Drive Shaft	48T	25		62	70.5	660			
E 430 (205 kW)	1997.06-	2002.03		L/R	R	Saloon Engine M113.940	Drive Shaft	48T	25		62	70.5	660			





		TRANSM	L/R	F/R		G-AP Ref.	PRODUCT	ABS	Technical Specifications							
									YEAR	A	B	C	H	L	P	
<b>MERCEDES BENZ</b>																
<b>G-CLASS (W460)</b>																
230 G (66 kW)	1979.03-	1993.07	MT/AT		F	Closed Off-Road Vehicle Engine M115.973	GC035018	Outer Joint		27	28	58	110	62	O	
230 G (75 kW)	1980.02-	1987.07	MT/AT		F	Closed Off-Road Vehicle Engine M115.973	GC035018	Outer Joint		27	28	58	110	62	O	
230 GE (90 kW)	1987.05-	1992.08	MT/AT		F	Closed Off-Road Vehicle Engine M102.979/M102.987	GC035018	Outer Joint		27	28	58	110	62	O	
230 GE (92 kW)	1982.04-	1992.08	MT/AT		F	Closed Off-Road Vehicle Engine M102.981/M102.987/M102.989	GC035018	Outer Joint		27	28	58	110	62	O	
240 GD (53 kW)	1979.03-	1987.08	MT/AT		F	Closed Off-Road Vehicle Engine OM616.936	GC035018	Outer Joint		27	28	58	110	62	O	
250 GD (62 kW)	1987.10-	1992.12	MT/AT		F	Closed Off-Road Vehicle Engine OM602.930	GC035018	Outer Joint		27	28	58	110	62	O	
250 GD (68 kW)	1988.12-	1992.08	MT/AT		F	Closed Off-Road Vehicle Engine OM602.930	GC035018	Outer Joint		27	28	58	110	62	O	
280 GE (110 kW)	1984.08-	1989.08	MT/AT		F	Closed Off-Road Vehicle Engine M110.994	GC035018	Outer Joint		27	28	58	110	62	O	
280 GE (115 kW)	1979.11-	1989.08	MT/AT		F	Closed Off-Road Vehicle Engine M110.994	GC035018	Outer Joint		27	28	58	110	62	O	
300 GD (65 kW)	1979.12-	1991.12	MT/AT		F	Closed Off-Road Vehicle Engine OM617.931	GC035018	Outer Joint		27	28	58	110	62	O	
300 GD (83 kW)	1979.03-	1993.07	MT/AT		F	Closed Off-Road Vehicle Engine OM603.912	GC035018	Outer Joint		27	28	58	110	62	O	
<b>G-CLASS (W461)</b>																
230 GE (90 kW)	1993.02-		MT/AT		F	Closed Off-Road Vehicle Engine M102.979	GC035033	Outer Joint	54T	26	28	62	124	62	O	
230 GE (92 kW)	1993.06-		MT/AT		F	Closed Off-Road Vehicle Engine M102.996/M102.997	GC035033	Outer Joint	54T	26	28	62	124	62	O	
<b>G-CLASS (W463)</b>																
230 GE (93 kW)	1990.06-	1993.06	MT/AT		F	Closed Off-Road Vehicle Engine M102.989	GC035033	Outer Joint	54T	26	28	62	124	62	O	
250 GD (69 kW)	1990.06-		MT/AT		F	Closed Off-Road Vehicle Engine OM602.931	GC035033	Outer Joint	54T	26	28	62	124	62	O	
300 GD (83 kW)	1989.09-		MT/AT		F	Closed Off-Road Vehicle Engine OM603.931	GC035033	Outer Joint	54T	26	28	62	124	62	O	
300 GE (125 kW)	1990.06-		MT/AT		F	Closed Off-Road Vehicle Engine M103.987	GC035033	Outer Joint	54T	26	28	62	124	62	O	
300 GE (128 kW)	1990.06-		MT/AT		F	Closed Off-Road Vehicle Engine M103.987	GC035033	Outer Joint	54T	26	28	62	124	62	O	
<b>G-CLASS CABRIO (W463)</b>																
300 GE (125 kW)	1989.09-	1997.09	MT/AT		F	Open Off-Road Vehicle Engine M103.987	GC035033	Outer Joint	54T	26	28	62	124	62	O	
<b>KOMBI (S123)</b>																
200 T (74 kW)	1980.11-	1985.11	MT/AT	L/R	R	Estate Engine M102.939	GDS35004	Drive Shaft		27		60	32.5	627		
200 T (80 kW)	1980.11-	1985.11	MT/AT	L/R	R	Estate Engine M102.920	GDS35004	Drive Shaft		27		60	32.5	627		
230 TE (100 kW)	1980.04-	1985.11	MT/AT	L/R	R	Estate Engine M102.980	GDS35004	Drive Shaft		27		60	32.5	627		
240 T D (53 kW)	1979.03-	1985.12	MT/AT	L/R	R	Estate Engine OM616.912	GDS35004	Drive Shaft		27		60	32.5	627		
280 TE (136 kW)	1977.09-	1985.11	MT/AT	L/R	R	Estate Engine M110.988	GDS35004	Drive Shaft		27		60	32.5	627		
300 T D (59 kW)	1977.09-	1985.10	MT/AT	L/R	R	Estate Engine OM617.912	GDS35004	Drive Shaft		27		60	32.5	627		
300 T D (65 kW)	1979.03-	1985.11	MT/AT	L/R	R	Estate Engine OM617.912	GDS35004	Drive Shaft		27		60	32.5	627		
300 T Turbo-D (92 kW)	1980.10-	1985.11	MT/AT	L/R	R	Estate Engine OM617.952	GDS35004	Drive Shaft		27		60	32.5	627		
<b>KOMBI (S124)</b>																
200 T (77 kW)	1986.01-	1990.05	MT/AT	L/R	R	Estate Engine M102.922	GDS35001	Drive Shaft		25		62	69	665		
200 T (80 kW)	1985.09-	1989.08	MT/AT	L/R	R	Estate Engine M102.922	GDS35001	Drive Shaft		25		62	69	665		
200 T D (53 kW)	1985.09-	1991.08	MT/AT	L/R	R	Estate Engine OM601.912	GDS35001	Drive Shaft		25		62	69	665		
200 T D (55 kW)	1988.09-	1991.08	MT/AT	L/R	R	Estate Engine OM601.912	GDS35001	Drive Shaft		25		62	69	665		
200 TE (87 kW)	1988.09-	1992.08	MT/AT	L/R	R	Estate Engine M102.963	GDS35001	Drive Shaft		25		62	69	665		
200 TE (90 kW)	1988.09-	1989.12	MT/AT	L/R	R	Estate Engine M102.962	GDS35001	Drive Shaft		25		62	69	665		
230 TE (100 kW)	1985.09-	1992.08	MT/AT	L/R	R	Estate Engine M102.982	GDS35001	Drive Shaft		25		62	69	665		
230 TE (97 kW)	1985.09-	1992.08	MT/AT	L/R	R	Estate Engine M102.982	GDS35001	Drive Shaft		25		62	69	665		
230 TE CAT (97 kW)	1989.06-	1992.08	MT/AT	L/R	R	Estate Engine M102.982	GDS35001	Drive Shaft		25		62	69	665		
250 T D (66 kW)	1985.09-	1993.06	MT/AT	L/R	R	Estate Engine OM602.912	GDS35001	Drive Shaft		25		62	69	665		
250 T D (69 kW)	1989.01-	1993.06	MT/AT	L/R	R	Estate Engine OM602.912	GDS35001	Drive Shaft		25		62	69	665		
260 TE FGST. (118 kW)	1989.09-	1992.08	MT/AT	L/R	R	Estate Engine M103.940	GDS35005	Drive Shaft		25		62	69	659		
260 TE FGST. (122 kW)	1985.09-	1989.12	MT/AT	L/R	R	Estate Engine M103.940	GDS35005	Drive Shaft		25		62	69	659		
300 T D (80 kW)	1986.09-	1993.06	MT/AT	L/R	R	Estate Engine OM603.912	GDS35005	Drive Shaft		25		62	69	659		
300 T D (81 kW)	1989.01-	1993.06	MT/AT	L/R	R	Estate Engine OM603.912	GDS35005	Drive Shaft		25		62	69	659		
300 T D (83 kW)	1989.01-	1993.06	MT/AT	L/R	R	Estate Engine OM603.912	GDS35005	Drive Shaft		25		62	69	659		
300 T Turbo-D (105 kW)	1986.09-	1989.01	MT/AT	L/R	R	Estate Engine OM603.963/OM603.960	GDS35005	Drive Shaft		25		62	69	659		
300 T Turbo-D (108 kW)	1989.01-	1993.06	MT/AT	L/R	R	Estate Engine OM603.960	GDS35005	Drive Shaft		25		62	69	659		
300 TE (132 kW)	1986.01-	1992.08	MT/AT	L/R	R	Estate Engine M103.983	GDS35005	Drive Shaft		25		62	69	659		
300 TE (138 kW)	1986.01-	1989.12	MT/AT	L/R	R	Estate Engine M103.983	GDS35005	Drive Shaft		25		62	69	659		
<b>M-CLASS (W163)</b>																
ML 230 (110 kW)	1998.02-	2005.06		L	F	Closed Off-Road Vehicle Engine M111.977	GDS35027	Drive Shaft	48W	30	37	79.1	89	630		
	1998.02-	2005.06		L/R	F	Closed Off-Road Vehicle Engine M111.977	GC035052	Outer Joint		30	26	79.1	89	60.5	I	
	1998.02-	2005.06		R	F	Closed Off-Road Vehicle Engine M111.977	GCI35039	Inner Joint		37	26	45	83	117.5		
ML 270 CDi (120 kW)	1999.12-	2005.06		L	F	Closed Off-Road Vehicle Engine OM612.963	GDS35027	Drive Shaft	48W	30	37	79.1	89	630		
	1999.12-	2005.06		L/R	F	Closed Off-Road Vehicle Engine OM612.963	GC035052	Outer Joint		30	26	79.1	89	60.5	I	
	1999.12-	2005.06		R	F	Closed Off-Road Vehicle Engine OM612.963	GCI35039	Inner Joint		37	26	45	83	117.5		
ML 320 (160 kW)	1998.02-	2002.08		L	F	Closed Off-Road Vehicle Engine M112.942	GDS35027	Drive Shaft	48W	30	37	79.1	89	630		
	1998.02-	2002.08		L/R	F	Closed Off-Road Vehicle Engine M112.942	GC035052	Outer Joint		30	26	79.1	89	60.5	I	
	1998.02-	2002.08		R	F	Closed Off-Road Vehicle Engine M112.942	GCI35039	Inner Joint		37	26	45	83	117.5		



		TRANSM	L/R	F/R		G-AP Ref.	PRODUCT	ABS	Technical Specifications						
									YEAR	A	B	C	H	L	P
<b>MERCEDES BENZ</b>															
<b>M-CLASS (W163)</b>															
ML 350 (173 kW)	2003.02-	2005.06		L	F	Closed Off-Road Vehicle Engine M112.970	GDS35027	Drive Shaft	48W	30	37	79.1	89	630	
	2003.02-	2005.06		L/R	F	Closed Off-Road Vehicle Engine M112.970	GC035052	Outer Joint		30	26	79.1	89	60.5	I
	2003.02-	2005.06		R	F	Closed Off-Road Vehicle Engine M112.970	GCI35039	Inner Joint		37	26	45	83	117.5	
ML 350 (180 kW)	2002.08-	2005.06		L	F	Closed Off-Road Vehicle Engine M112.970	GDS35027	Drive Shaft	48W	30	37	79.1	89	630	
	2002.08-	2005.06		L/R	F	Closed Off-Road Vehicle Engine M112.970	GC035052	Outer Joint		30	26	79.1	89	60.5	I
	2002.08-	2005.06		R	F	Closed Off-Road Vehicle Engine M112.970	GCI35039	Inner Joint		37	26	45	83	117.5	
ML 400 CDi (184 kW)	2001.09-	2005.06		L	F	Closed Off-Road Vehicle Engine OM628.963	GDS35027	Drive Shaft	48W	30	37	79.1	89	630	
	2001.09-	2005.06		L/R	F	Closed Off-Road Vehicle Engine OM628.963	GC035052	Outer Joint		30	26	79.1	89	60.5	I
	2001.09-	2005.06		R	F	Closed Off-Road Vehicle Engine OM628.963	GCI35039	Inner Joint		37	26	45	83	117.5	
ML 430 (200 kW)	1998.02-	2005.06		L	F	Closed Off-Road Vehicle Engine M113.942	GDS35027	Drive Shaft	48W	30	37	79.1	89	630	
	1998.02-	2005.06		L/R	F	Closed Off-Road Vehicle Engine M113.942	GC035052	Outer Joint		30	26	79.1	89	60.5	I
	1998.02-	2005.06		R	F	Closed Off-Road Vehicle Engine M113.942	GCI35039	Inner Joint		37	26	45	83	117.5	
ML 500 (215 kW)	2001.09-	2005.06		L	F	Closed Off-Road Vehicle Engine M113.964/M113.965	GDS35027	Drive Shaft	48W	30	37	79.1	89	630	
	2001.09-	2005.06		L/R	F	Closed Off-Road Vehicle Engine M113.964/M113.965	GC035052	Outer Joint		30	26	79.1	89	60.5	I
	2001.09-	2005.06		R	F	Closed Off-Road Vehicle Engine M113.964/M113.965	GCI35039	Inner Joint		37	26	45	83	117.5	
ML 55 AMG (255 kW)	2000.02-	2005.06		L	F	Closed Off-Road Vehicle Engine M113.981	GDS35027	Drive Shaft	48W	30	37	79.1	89	630	
	2000.02-	2005.06		L/R	F	Closed Off-Road Vehicle Engine M113.981	GC035052	Outer Joint		30	26	79.1	89	60.5	I
	2000.02-	2005.06		R	F	Closed Off-Road Vehicle Engine M113.981	GCI35039	Inner Joint		37	26	45	83	117.5	
<b>M-CLASS (W164)</b>															
ML 280 CDi 4-matic (140 kW)	2005.07-	2009.07		L	F	Closed Off-Road Vehicle Engine OM642.940	GDS85060	Drive Shaft		30	37	70.2	90.5	666	
	2005.07-	2009.07		L	F	Closed Off-Road Vehicle Engine OM642.940	GCI85041	Inner Joint		37	33	45	80	104.5	
	2005.07-	2009.07		L/R	F	Closed Off-Road Vehicle Engine OM642.940	GC085007	Outer Joint		30	37	70.2	90.5	65.5	I
	2005.07-	2009.07		R	F	Closed Off-Road Vehicle Engine OM642.940	GDS85061	Drive Shaft		30	37	70.2	90.5	1004	
	2005.07-	2009.07		R	F	Closed Off-Road Vehicle Engine OM642.940	GCI85042	Inner Joint		37	33	45	264	111	
ML 300 CDi 4-matic (140 kW)	2009.07-				F	Closed Off-Road Vehicle Engine OM642.940	GC085007	Outer Joint		30	37	70.2	90.5	65.5	I
ML 300 CDi 4-matic (150 kW)	2010.02-				F	Closed Off-Road Vehicle Engine OM642.820/OM642.832	GC085007	Outer Joint		30	37	70.2	90.5	65.5	I
ML 320 CDi 4-matic (165 kW)	2005.07-	2009.07		L	F	Closed Off-Road Vehicle Engine OM642.940	GDS85060	Drive Shaft		30	37	70.2	90.5	666	
	2005.07-	2009.07		L	F	Closed Off-Road Vehicle Engine OM642.940	GCI85041	Inner Joint		37	33	45	80	104.5	
	2005.07-	2009.07		L/R	F	Closed Off-Road Vehicle Engine OM642.940	GC085007	Outer Joint		30	37	70.2	90.5	65.5	I
	2005.07-	2009.07		R	F	Closed Off-Road Vehicle Engine OM642.940	GDS85061	Drive Shaft		30	37	70.2	90.5	1004	
	2005.07-	2009.07		R	F	Closed Off-Road Vehicle Engine OM642.940	GCI85042	Inner Joint		37	33	45	264	111	
ML 350 4-matic (200 kW)	2005.07-			L	F	Closed Off-Road Vehicle Engine M272.967	GDS85060	Drive Shaft		30	37	70.2	90.5	666	
	2005.07-			L	F	Closed Off-Road Vehicle Engine M272.967	GCI85041	Inner Joint		37	33	45	80	104.5	
	2005.07-			L/R	F	Closed Off-Road Vehicle Engine M272.967	GC085007	Outer Joint		30	37	70.2	90.5	65.5	I
	2005.07-			R	F	Closed Off-Road Vehicle Engine M272.967	GDS85061	Drive Shaft		30	37	70.2	90.5	1004	
	2005.07-			R	F	Closed Off-Road Vehicle Engine M272.967	GCI85042	Inner Joint		37	33	45	264	111	
ML 350 CDi 4-matic (155 kW)	2009.09-				F	Closed Off-Road Vehicle Engine OM642.820	GC085007	Outer Joint		30	37	70.2	90.5	65.5	I
ML 350 CDi 4-matic (165 kW)	2009.07-				F	Closed Off-Road Vehicle Engine OM642.940	GC085007	Outer Joint		30	37	70.2	90.5	65.5	I
ML 350 CDi 4-matic (170 kW)	2010.02-				F	Closed Off-Road Vehicle Engine OM642.820	GC085007	Outer Joint		30	37	70.2	90.5	65.5	I
ML 420 CDi 4-matic (225 kW)	2006.02-	2009.09		R	F	Closed Off-Road Vehicle Engine OM629.912	GDS85061	Drive Shaft		30	37	70.2	90.5	1004	
	2006.02-	2009.09		R	F	Closed Off-Road Vehicle Engine OM629.912	GCI85042	Inner Joint		37	33	45	264	111	
	2006.02-	2009.09		L	F	Closed Off-Road Vehicle Engine OM629.912	GDS85060	Drive Shaft		30	37	70.2	90.5	666	
	2006.02-	2009.09		L	F	Closed Off-Road Vehicle Engine OM629.912	GCI85041	Inner Joint		37	33	45	80	104.5	
	2006.02-	2009.09		L/R	F	Closed Off-Road Vehicle Engine OM629.912	GC085007	Outer Joint		30	37	70.2	90.5	65.5	I
ML 450 CDi 4-matic (225 kW)	2009.09-				F	Closed Off-Road Vehicle Engine OM629.912	GC085007	Outer Joint		30	37	70.2	90.5	65.5	I
ML 500 4-matic (225 kW)	2005.07-			L	F	Closed Off-Road Vehicle Engine M113.964	GDS85060	Drive Shaft		30	37	70.2	90.5	666	
	2005.07-			L	F	Closed Off-Road Vehicle Engine M113.964	GCI85041	Inner Joint		37	33	45	80	104.5	
	2005.07-			L/R	F	Closed Off-Road Vehicle Engine M113.964	GC085007	Outer Joint		30	37	70.2	90.5	65.5	I
	2005.07-			R	F	Closed Off-Road Vehicle Engine M113.964	GDS85061	Drive Shaft		30	37	70.2	90.5	1004	
ML 500 4-matic (285 kW)	2007.12-			L	F	Closed Off-Road Vehicle Engine M273.963	GDS85060	Drive Shaft		30	37	70.2	90.5	666	
	2007.12-			L	F	Closed Off-Road Vehicle Engine M273.963	GCI85041	Inner Joint		37	33	45	80	104.5	
	2007.12-			L/R	F	Closed Off-Road Vehicle Engine M273.963	GC085007	Outer Joint		30	37	70.2	90.5	65.5	I
	2007.12-			R	F	Closed Off-Road Vehicle Engine M273.963	GDS85061	Drive Shaft		30	37	70.2	90.5	1004	
	2007.12-			R	F	Closed Off-Road Vehicle Engine M273.963	GCI85042	Inner Joint		37	33	45	264	111	
ML 63 AMG 4-matic (375 kW)	2006.01-				F	Closed Off-Road Vehicle Engine M156.980	GC085007	Outer Joint		30	37	70.2	90.5	65.5	I
<b>MB</b>															
-				L/R		100-120-140	GDS35014	Drive Shaft		30	30	72	138.5	732.5	
				L/R		100-120-140	GCI35004	Inner Joint		30	30	55	47	73	
				L/R		100-120-140	GC035006	Outer Joint		30	27	72	138.5	80	I





		TRANSM	L/R	F/R		G-AP Ref.	PRODUCT	ABS	Technical Specifications														
									YEAR	A	B	C	H	L	P								
<b>MERCEDES BENZ R-CLASS (W251, V251)</b>																							
R 280 CDI 4-matic (140 kW)	2006.05-			L	F	MPV Engine OM 642.950	GDS85068	Drive Shaft		30	37	70.2	90.5	682									
	2006.05-			L	R	MPV Engine OM 642.950	GDS35063	Drive Shaft		30	37	70.2	90.5	852									
R 300 CDI 4-matic (140 kW)	2009.07-			L	F	MPV Engine OM 642.950	GDS85068	Drive Shaft		30	37	70.2	90.5	682									
	2009.07-			L	R	MPV Engine OM 642.950	GDS35063	Drive Shaft		30	37	70.2	90.5	852									
R 320 CDI 4-matic (155 kW)	2006.01-			L	F	MPV Engine OM 642.950/OM 642.870	GDS85068	Drive Shaft		30	37	70.2	90.5	682									
	2006.01-			L	R	MPV Engine OM 642.950/OM 642.870	GDS35063	Drive Shaft		30	37	70.2	90.5	852									
R 320 CDI 4-matic (165 kW)	2006.01-			L	F	MPV Engine OM 642.950	GDS85068	Drive Shaft		30	37	70.2	90.5	682									
	2006.01-			L	R	MPV Engine OM 642.950	GDS35063	Drive Shaft		30	37	70.2	90.5	852									
R 350 (200 kW)	2007.01-		AT	L	F	MPV Engine M 272.967	GDS85068	Drive Shaft		30	37	70.2	90.5	682									
	2007.01-		AT	L	R	MPV Engine M 272.967	GDS35063	Drive Shaft		30	37	70.2	90.5	852									
R 350 4-matic (200 kW)	2006.01-			L	R	MPV Engine M 272.967	GDS35063	Drive Shaft		30	37	70.2	90.5	852									
R 350 CDI 4-matic (155 kW)	2006.01-			L	F	MPV Engine OM 642.950/OM 642.870	GDS85068	Drive Shaft		30	37	70.2	90.5	682									
R 350 CGI 4-matic (225 kW)	2006.01-			L	F	MPV Engine M 276.958	GDS85068	Drive Shaft		30	37	70.2	90.5	682									
	2006.01-			L	R	MPV Engine M 276.958	GDS35063	Drive Shaft		30	37	70.2	90.5	852									
R 500 4-matic (225 kW)	2006.01-			L	R	MPV Engine M 113.971	GDS35063	Drive Shaft		30	37	70.2	90.5	852									
<b>SALOON (W123)</b>																							
200 (74 kW)	1980.06-	1985.11	MT/AT	L/R	R	Saloon Engine M102.939	GDS35004	Drive Shaft		27		60	32.5	627									
200 (80 kW)	1980.06-	1985.11	MT/AT	L/R	R	Saloon Engine M102.920	GDS35004	Drive Shaft		27		60	32.5	627									
200 D (44 kW)	1979.03-	1985.11	MT/AT	L/R	R	Saloon Engine OM615.940	GDS35004	Drive Shaft		27		60	32.5	627									
230 (80 kW)	1976.02-	1981.03	MT/AT	L/R	R	Saloon Engine M115.954	GDS35004	Drive Shaft		27		60	32.5	627									
230 E (100 kW)	1980.04-	1985.12	MT/AT	L/R	R	Saloon Engine M102.980	GDS35004	Drive Shaft		27		60	32.5	627									
240 D (53 kW)	1979.03-	1985.11	MT/AT	L/R	R	Saloon Engine OM616.912	GDS35004	Drive Shaft		27		60	32.5	627									
280 (115 kW)	1976.02-	1981.08	MT/AT	L/R	R	Saloon Engine M110.923	GDS35004	Drive Shaft		27		60	32.5	627									
280 E (130 kW)	1976.08-	1981.08	MT/AT	L/R	R	Saloon Engine M110.988	GDS35004	Drive Shaft		27		60	32.5	627									
280 E (136 kW)	1976.02-	1985.11	MT/AT	L/R	R	Saloon Engine M110.984/M110.988	GDS35004	Drive Shaft		27		60	32.5	627									
300 D (65 kW)	1979.03-	1985.11	MT/AT	L/R	R	Saloon Engine OM617.912	GDS35004	Drive Shaft		27		60	32.5	627									
300 Turbo-D (92 kW)	1981.08-	1985.07	MT/AT	L/R	R	Saloon Engine OM617.952	GDS35004	Drive Shaft		27		60	32.5	627									
<b>SALOON (W124)</b>																							
200 (75 kW)	1986.01-	1990.05	MT/AT	L/R	R	Saloon Engine M102.922	GDS35001	Drive Shaft		25		62	69	665									
200 (77 kW)	1986.01-	1990.05	MT/AT	L/R	R	Saloon Engine M102.922	GDS35001	Drive Shaft		25		62	69	665									
200 (80 kW)	1985.12-	1990.05	MT/AT	L/R	R	Saloon Engine M102.922	GDS35001	Drive Shaft		25		62	69	665									
200 D (53 kW)	1984.12-	1989.08	MT/AT	L/R	R	Saloon Engine OM601.912	GDS35001	Drive Shaft		25		62	69	665									
200 D (55 kW)	1989.08-	1993.06	MT/AT	L/R	R	Saloon Engine OM601.912	GDS35001	Drive Shaft		25		62	69	665									
200 E (87 kW)	1988.09-	1992.08	MT/AT	L/R	R	Saloon Engine M102.963	GDS35001	Drive Shaft		25		62	69	665									
230 E (100 kW)	1985.01-	1993.06	MT/AT	L/R	R	Saloon Engine M102.982	GDS35001	Drive Shaft		25		62	69	665									
230 E (97 kW)	1984.12-	1992.03	MT/AT	L/R	R	Saloon Engine M102.982	GDS35001	Drive Shaft		25		62	69	665									
	1989.06-	1993.06	MT/AT	L/R	R	Saloon Engine M102.982	GDS35001	Drive Shaft		25		62	69	665									
250 D (66 kW)	1985.04-	1993.06	MT/AT	L/R	R	Saloon Engine OM602.912	GDS35001	Drive Shaft		25		62	69	665									
250 D (69 kW)	1989.01-	1993.06	MT/AT	L/R	R	Saloon Engine OM602.912	GDS35001	Drive Shaft		25		62	69	665									
250 Turbo-D (93 kW)	1988.09-	1993.06	MT/AT	L/R	R	Saloon Engine OM602.962	GDS35005	Drive Shaft		25		62	69	659									
260 E (118 kW)	1985.09-	1992.08	MT/AT	L/R	R	Saloon Engine M103.940	GDS35005	Drive Shaft		25		62	69	659									
300 D (80 kW)	1984.12-	1989.08	MT/AT	L/R	R	Saloon Engine OM603.912	GDS35005	Drive Shaft		25		62	69	659									
300 D (81 kW)	1990.06-	1993.06	MT/AT	L/R	R	Saloon Engine OM603.912	GDS35005	Drive Shaft		25		62	69	659									
300 D (83 kW)	1989.08-	1993.06	MT/AT	L/R	R	Saloon Engine OM603.912	GDS35005	Drive Shaft		25		62	69	659									
300 E (132 kW)	1985.08-	1992.08	MT/AT	L/R	R	Saloon Engine M103.983	GDS35005	Drive Shaft		25		62	69	659									
300 Turbo-D (105 kW)	1986.09-	1988.09	MT/AT	L/R	R	Saloon Engine OM603.960/OM603.963	GDS35005	Drive Shaft		25		62	69	659									
300 Turbo-D (108 kW)	1988.09-	1993.06	MT/AT	L/R	R	Saloon Engine OM603.960	GDS35005	Drive Shaft		25		62	69	659									
<b>SL (C107)</b>																							
280 SL (136 kW)	1974.08-	1985.07	MT/AT	L/R	R	Convertible Engine M110.982/M110.986/M110.990	GDS35004	Drive Shaft		27		60	32.5	627									
280 SLC (130 kW)	1976.06-	1981.09	MT/AT	L/R	R	Coupe Engine M110.982/M110.986/M110.990	GDS35004	Drive Shaft		27		60	32.5	627									
280 SLC (136 kW)	1974.08-	1981.09	MT/AT	L/R	R	Coupe Engine M110.982/M110.986/M110.990	GDS35004	Drive Shaft		27		60	32.5	627									
380 SLC (160 kW)	1980.07-	1981.08	MT/AT	L/R	R	Coupe Engine M116.960	GDS35004	Drive Shaft		27		60	32.5	627									
<b>SL (R107)</b>																							
280 SL (130 kW)	1976.06-	1981.09	MT/AT	L/R	R	Convertible Engine M110.982/M110.986/M110.990	GDS35004	Drive Shaft		27		60	32.5	627									
380 SL (150 kW)	1980.09-	1985.08	MT/AT	L/R	R	Convertible Engine M116.962	GDS35004	Drive Shaft		27		60	32.5	627									
380 SL (160 kW)	1980.09-	1981.08	MT/AT	L/R	R	Convertible Engine M116.960	GDS35004	Drive Shaft		27		60	32.5	627									
<b>SLK (R170)</b>																							
200 (100 kW)	1996.09-	2000.03		L/R	R	Convertible Engine M111.946	GDS35007	Drive Shaft		25		62	70.5	630									
<b>SPRINTER 3-T (903)</b>																							
312 D 2.9 4x4 (90 kW)	1997.05-	2002.08			F	Bus Engine OM602.980	GC035034	Outer Joint		26	28	62	124	62	O								
	1997.05-	2002.08			F	Bus Engine OM602.980	GCI35020	Inner Joint			28		32										





		TRANSM	L/R	F/R		G-AP Ref.	PRODUCT	ABS	Technical Specifications							
									YEAR	A	B	C	H	L	P	
<b>MERCEDES BENZ</b>																
<b>V-CLASS (638/2)</b>																
V 200 (95 kW)	1997.02-2003.07		MT/AT		F	MPV Engine M111.948/M111.950	GC035001	Outer Joint	48W	27	27	59.8	99	63	I	
	1997.02-2003.07			L/R	F	MPV Engine M111.948/M111.950	GDS35016	Drive Shaft		27		59.8	99	515		
	1997.02-2003.07			L/R	F	MPV Engine M111.948/M111.950	GDS35002	Drive Shaft	48W	27		59.8	99	515		
V 200 CDI (75 kW)	1999.03-2003.07				F	MPV Engine OM611.980	GCI35001	Inner Joint			30		36.2			
	1999.03-2003.07				F	MPV Engine OM611.980	GC035002	Outer Joint	48W	27	36	71.5	99	68	I	
	1999.03-2003.07				F	MPV Engine OM611.980	GC035008	Outer Joint		27	36	71.5	99	68	I	
	1999.03-2003.07			L/R	F	MPV Engine OM611.980	GDS35011	Drive Shaft		27		71.5	99	506		
	1999.03-2003.07			L/R	F	MPV Engine OM611.980	GDS35003	Drive Shaft	48W	27		71.5	99	506		
V 220 CDI (90 kW)	1999.03-2003.07				F	MPV Engine OM611.980	GCI35001	Inner Joint			30		36.2			
	1999.03-2003.07				F	MPV Engine OM611.980	GC035002	Outer Joint	48W	27	36	71.5	99	68	I	
	1999.03-2003.07				F	MPV Engine OM611.980	GC035008	Outer Joint		27	36	71.5	99	68	I	
	1999.03-2003.07			L/R	F	MPV Engine OM611.980	GDS35011	Drive Shaft		27		71.5	99	506		
	1999.03-2003.07			L/R	F	MPV Engine OM611.980	GDS35003	Drive Shaft	48W	27		71.5	99	506		
V 230 (105 kW)	1996.10-2003.07		MT/AT		F	MPV Engine M111.978	GC035001	Outer Joint	48W	27	27	59.8	99	63	I	
	1996.10-2003.07			L/R	F	MPV Engine M111.978	GDS35016	Drive Shaft		27		59.8	99	515		
	1996.10-2003.07			L/R	F	MPV Engine M111.978	GDS35002	Drive Shaft	48W	27		59.8	99	515		
V 230 TD (72 kW)	1996.09-2003.07		MT/AT		F	MPV Engine OM601.970	GC035001	Outer Joint	48W	27	27	59.8	99	63	I	
	1996.09-2003.07			L/R	F	MPV Engine OM601.970	GDS35016	Drive Shaft		27		59.8	99	515		
	1996.09-2003.07			L/R	F	MPV Engine OM601.970	GDS35002	Drive Shaft	48W	27		59.8	99	515		
V 280 (128 kW)	1997.08-2003.07			L/R	F	MPV Engine M104.900	GDS35016	Drive Shaft		27		59.8	99	515		
	1997.08-2003.07			L/R	F	MPV Engine M104.900	GDS35002	Drive Shaft	48W	27		59.8	99	515		
<b>VANEO (414)</b>																
1.6 (60 kW)	2002.02-				L		GCI35013	Inner Joint		22	27	36	55	79		
	2002.02-				R		GCI35010	Inner Joint		22	27	36	459	61		
1.6 (75 kW)	2002.02-				L		GCI35013	Inner Joint		22	27	36	55	79		
	2002.02-				R		GCI35010	Inner Joint		22	27	36	459	61		
1.7 CDI (55 kW)	2002.02-				L		GCI35013	Inner Joint		22	27	36	55	79		
	2002.02-				R		GCI35010	Inner Joint		22	27	36	459	61		
1.7 CDI (67 kW)	2002.02-				L		GCI35013	Inner Joint		22	27	36	55	79		
	2002.02-				R		GCI35010	Inner Joint		22	27	36	459	61		
1.9 (92 kW)	2002.02-				L		GCI35013	Inner Joint		22	27	36	55	79		
	2002.02-				R		GCI35010	Inner Joint		22	27	36	459	61		
<b>VIANO (W639)</b>																
2.0 CDI (80 kW)	2004.01-				R	MPV Engine OM646.982	GC035028	Outer Joint		30	36	70	95	68	I	
	2004.01-			L/R	R	MPV Engine OM646.982	GDS35022	Drive Shaft		30	26	70	94.5	849		
	2004.01-			L/R	R	MPV Engine OM646.982	GCI99177	Inner Joint		26	28	45	83.5	78		
	2004.01-			L/R	R	MPV Engine OM646.982	GC035024	Outer Joint		30	36	70	94.5	68	I	
2.0 CDI 4-matic (80 kW)	2005.07-					MPV Engine OM646.982	GC035028	Outer Joint		30	36	70	95	68	I	
	2005.07-			L/R	F	MPV Engine OM646.982	GDS35084	Drive Shaft		30		66	96.5	652		
	2005.07-			L/R	R	MPV Engine OM646.982	GDS35022	Drive Shaft		30	26	70	94.5	849		
	2005.07-			L/R	R	MPV Engine OM646.982	GCI99177	Inner Joint		26	28	45	83.5	78		
	2005.07-			L/R	R	MPV Engine OM646.982	GC035024	Outer Joint		30	36	70	94.5	68	I	
3.2 (160 kW)	2004.01-	2004.10			R	MPV Engine M112.951	GC035036	Outer Joint		30	37	70	94.5	61	I	
3.7 (170 kW)	2004.10-				R	MPV Engine M112.976	GC035036	Outer Joint		30	37	70	94.5	61	I	
CDi 2.2 4-matic (110 kW)	2005.07-			L/R	F	MPV Engine OM 646.982	GDS35084	Drive Shaft		30		66	96.5	652		
<b>VITO (638)</b>																
2.0 (95 kW)	1996.02-2003.07		MT/AT		F	Bus Engine M111.948/M111.950	GC035001	Outer Joint	48W	27	27	59.8	99	63	I	
	1996.02-2003.07			L/R	F	Bus Engine M111.948/M111.950	GDS35016	Drive Shaft		27		59.8	99	515		
	1996.02-2003.07			L/R	F	Bus Engine M111.948/M111.950	GDS35002	Drive Shaft	48W	27		59.8	99	515		
	1997.03-2003.07				F	Box Engine M111.948/M111.950	GC035007	Outer Joint		27	27	59.8	99	63	I	
	1997.03-2003.07				F	Box Engine M111.948/M111.950	GCI48002	Inner Joint			28		32			
	1997.03-2003.07		MT/AT		F	Box Engine M111.948/M111.950	GC035001	Outer Joint	48W	27	27	59.8	99	63	I	
	1997.03-2003.07			L/R	F	Box Engine M111.948/M111.950	GDS35016	Drive Shaft		27		59.8	99	515		
	1997.03-2003.07			L/R	F	Box Engine M111.948/M111.950	GDS35002	Drive Shaft	48W	27		59.8	99	515		
2.2 CDI (60 kW)	1999.03-2003.07				F	Box Engine OM611A	GC035007	Outer Joint		27	27	59.8	99	63	I	
	1999.03-2003.07				F	Box Engine OM611A	GCI35001	Inner Joint			30		36.2			
	1999.03-2003.07				F	Box Engine OM611A	GC035002	Outer Joint	48W	27	36	71.5	99	68	I	
	1999.03-2003.07				F	Box Engine OM611A	GC035008	Outer Joint		27	36	71.5	99	68	I	
	1999.03-2003.07				F	Bus Engine OM611A	GCI35001	Inner Joint			30		36.2			
	1999.03-2003.07				F	Bus Engine OM611A	GC035002	Outer Joint	48W	27	36	71.5	99	68	I	
	1999.03-2003.07				F	Bus Engine OM611A	GC035008	Outer Joint		27	36	71.5	99	68	I	
	1999.03-2003.07			L/R	F	Box Engine OM611A	GDS35011	Drive Shaft		27		71.5	99	506		



		TRANSM	L/R	F/R		G-AP Ref.	PRODUCT	ABS	Technical Specifications						
									YEAR	A	B	C	H	L	P
<b>MERCEDES BENZ VITO (638)</b>															
2.2 CDi (60 kW)	1999.03-2003.07			L/R	F	Box Engine OM611A	GDS35003	Drive Shaft	48W	27		71.5	99	506	
	1999.03-2003.07			L/R	F	Bus Engine OM611A	GDS35011	Drive Shaft		27		71.5	99	506	
	1999.03-2003.07			L/R	F	Bus Engine OM611A	GDS35003	Drive Shaft	48W	27		71.5	99	506	
2.2 CDi (75 kW)	1999.03-2003.07				F	Box Engine OM611LA(75KWCDI)	GC035007	Outer Joint		27	27	59.8	99	63	I
	1999.03-2003.07				F	Box Engine OM611LA(75KWCDI)	GCI35001	Inner Joint			30		36.2		
	1999.03-2003.07				F	Box Engine OM611LA(75KWCDI)	GC035002	Outer Joint	48W	27	36	71.5	99	68	I
	1999.03-2003.07				F	Box Engine OM611LA(75KWCDI)	GC035008	Outer Joint		27	36	71.5	99	68	I
	1999.03-2003.07				F	Bus Engine OM611LA(75KWCDI)	GCI35001	Inner Joint			30		36.2		
	1999.03-2003.07				F	Bus Engine OM611LA(75KWCDI)	GC035002	Outer Joint	48W	27	36	71.5	99	68	I
	1999.03-2003.07				F	Bus Engine OM611LA(75KWCDI)	GC035008	Outer Joint		27	36	71.5	99	68	I
	1999.03-2003.07			L/R	F	Box Engine OM611LA(75KWCDI)	GDS35011	Drive Shaft		27		71.5	99	506	
	1999.03-2003.07			L/R	F	Box Engine OM611LA(75KWCDI)	GDS35003	Drive Shaft	48W	27		71.5	99	506	
	1999.03-2003.07			L/R	F	Bus Engine OM611LA(75KWCDI)	GDS35011	Drive Shaft		27		71.5	99	506	
	1999.03-2003.07			L/R	F	Bus Engine OM611LA(75KWCDI)	GDS35003	Drive Shaft	48W	27		71.5	99	506	
2.2 CDi (90 kW)	1999.03-2003.07				F	Box Engine OM611.980	GCI35001	Inner Joint			30		36.2		
	1999.03-2003.07				F	Bus Engine OM611.980	GCI35001	Inner Joint			30		36.2		
	1999.03-2003.07				F	Box Engine OM611.980	GC035002	Outer Joint	48W	27	36	71.5	99	68	I
	1999.03-2003.07	5MT			F	Box Engine OM611.980	GC035007	Outer Joint		27	27	59.8	99	63	I
	1999.03-2003.07	5MT			F	Box Engine OM611.980	GC035008	Outer Joint		27	36	71.5	99	68	I
	1999.03-2003.07	5MT			F	Bus Engine OM611.980	GC035008	Outer Joint		27	36	71.5	99	68	I
	1999.03-2003.07	MT			F	Box Engine OM611.980	GC035002	Outer Joint	48W	27	36	71.5	99	68	I
	1999.03-2003.07	5MT	L/R	F	Box Engine OM611.980	GDS35011	Drive Shaft		27		71.5	99	506		
	1999.03-2003.07	5MT	L/R	F	Box Engine OM611.980	GDS35003	Drive Shaft	48W	27		71.5	99	506		
	1999.03-2003.07	5MT	L/R	F	Bus Engine OM611.980	GDS35011	Drive Shaft		27		71.5	99	506		
	1999.03-2003.07	5MT	L/R	F	Bus Engine OM611.980	GDS35003	Drive Shaft	48W	27		71.5	99	506		
2.3 (105 kW)	1996.12-2003.07	MT/AT			F	Bus Engine M111.978	GC035001	Outer Joint	48W	27	27	59.8	99	63	I
	1996.12-2003.07			L/R	F	Bus Engine M111.978	GDS35016	Drive Shaft		27		59.8	99	515	
	1996.12-2003.07			L/R	F	Bus Engine M111.978	GDS35002	Drive Shaft	48W	27		59.8	99	515	
	1997.03-2003.07				F	Box Engine M111.978	GC035007	Outer Joint		27	27	59.8	99	63	I
	1997.03-2003.07				F	Box Engine M111.978	GCI48002	Inner Joint			28		32		
	1997.03-2003.07	MT/AT			F	Box Engine M111.978	GC035001	Outer Joint	48W	27	27	59.8	99	63	I
	1997.03-2003.07			L/R	F	Box Engine M111.978	GDS35016	Drive Shaft		27		59.8	99	515	
	1997.03-2003.07			L/R	F	Box Engine M111.978	GDS35002	Drive Shaft	48W	27		59.8	99	515	
2.3 D (58 kW)	1996.02-2003.07	MT/AT			F	Bus Engine OM601.942	GC035001	Outer Joint	48W	27	27	59.8	99	63	I
	1996.02-2003.07			L/R	F	Bus Engine OM601.942	GDS35016	Drive Shaft		27		59.8	99	515	
	1996.02-2003.07			L/R	F	Bus Engine OM601.942	GDS35002	Drive Shaft	48W	27		59.8	99	515	
	1997.03-2003.07				F	Box Engine OM601.942	GC035007	Outer Joint		27	27	59.8	99	63	I
	1997.03-2003.07				F	Box Engine OM601.942	GCI48002	Inner Joint			28		32		
	1997.03-2003.07	MT/AT			F	Box Engine OM601.942	GC035001	Outer Joint	48W	27	27	59.8	99	63	I
	1997.03-2003.07			L/R	F	Box Engine OM601.942	GDS35016	Drive Shaft		27		59.8	99	515	
2.3 D (72 kW)	1997.03-2003.07				F	Box Engine OM601.970	GC035007	Outer Joint		27	27	59.8	99	63	I
	1997.03-2003.07				F	Box Engine OM601.970	GCI48002	Inner Joint			28		32		
	1997.03-2003.07	MT/AT			F	Box Engine OM601.970	GC035001	Outer Joint	48W	27	27	59.8	99	63	I
	1997.03-2003.07			L/R	F	Box Engine OM601.970	GDS35016	Drive Shaft		27		59.8	99	515	
	1997.03-2003.07			L/R	F	Box Engine OM601.970	GDS35002	Drive Shaft	48W	27		59.8	99	515	
2.3 TD (72 kW)	1996.02-2003.07	MT/AT			F	Bus Engine OM601.970	GC035001	Outer Joint	48W	27	27	59.8	99	63	I
	1996.02-2003.07			L/R	F	Bus Engine OM601.970	GDS35016	Drive Shaft		27		59.8	99	515	
	1996.02-2003.07			L/R	F	Bus Engine OM601.970	GDS35002	Drive Shaft	48W	27		59.8	99	515	
<b>VITO (W639)</b>															
2.1 CDi (100 kW)	2010.09-			L/R	R	Bus Engine OM651.940	GDS35022	Drive Shaft		30	26	70	94.5	849	
	2010.09-			L/R	R	Bus Engine OM651.940	GCI99177	Inner Joint		26	28	45	83.5	78	
	2010.09-			L/R	R	Bus Engine OM651.940	GC035024	Outer Joint		30	36	70	94.5	68	I
2.1 CDi (120 kW)	2010.09-			L/R	R	Bus Engine OM651.940	GDS35022	Drive Shaft		30	26	70	94.5	849	
	2010.09-			L/R	R	Bus Engine OM651.940	GCI99177	Inner Joint		26	28	45	83.5	78	
	2010.09-			L/R	R	Bus Engine OM651.940	GC035024	Outer Joint		30	36	70	94.5	68	I
2.1 CDi (70 kW)	2010.09-			L/R	R	Bus Engine OM651.940	GDS35022	Drive Shaft		30	26	70	94.5	849	
	2010.09-			L/R	R	Bus Engine OM651.940	GCI99177	Inner Joint		26	28	45	83.5	78	
	2010.09-			L/R	R	Bus Engine OM651.940	GC035024	Outer Joint		30	36	70	94.5	68	I
2.2 CDi (65 kW)	2003.09-				R	Bus Engine OM646.983	GC035028	Outer Joint		30	36	70	95	68	I
	2003.09-		MT	L/R	R	Bus Engine OM646.983	GDS35022	Drive Shaft		30	26	70	94.5	849	
	2003.09-		MT	L/R	R	Bus Engine OM646.983	GCI99177	Inner Joint		26	28	45	83.5	78	

	 YEAR	TRANSM	L/R	F/R		G-AP Ref.	PRODUCT	ABS	Technical Specifications									
									A	B	C	H	L	P				
<b>MERCEDES BENZ</b>																		
<b>VITO (W639)</b>																		
2.2 CDi (65 kW)	2003.09-		MT	L/R	R	Bus Engine OM646.983	GC035024	Outer Joint		30	36	70	94.5	68	I			
2.2 CDi (70 kW)	2006.09-			L/R	R	Bus Engine OM646.980	GDS35022	Drive Shaft		30	26	70	94.5	849				
	2006.09-			L/R	R	Bus Engine OM646.980	GCI99177	Inner Joint		26	28	45	83.5	78				
	2006.09-			L/R	R	Bus Engine OM646.980	GC035024	Outer Joint		30	36	70	94.5	68	I			
2.2 CDi (80 kW)	2003.09-				R	Bus Engine OM646.982	GC035028	Outer Joint		30	36	70	95	68	I			
	2003.09-		MT/AT	L/R	R	Bus Engine OM646.982	GDS35022	Drive Shaft		30	26	70	94.5	849				
	2003.09-		MT/AT	L/R	R	Bus Engine OM646.982	GCI99177	Inner Joint		26	28	45	83.5	78				
	2003.09-		MT/AT	L/R	R	Bus Engine OM646.982	GC035024	Outer Joint		30	36	70	94.5	68	I			
2.2 CDi (85 kW)	2007.09-			L/R	R	Bus Engine OM646.980/OM646.982	GDS35022	Drive Shaft		30	26	70	94.5	849				
	2007.09-			L/R	R	Bus Engine OM646.980/OM646.982	GCI99177	Inner Joint		26	28	45	83.5	78				
	2007.09-			L/R	R	Bus Engine OM646.980/OM646.982	GC035024	Outer Joint		30	36	70	94.5	68	I			
2.2 CDi 4x4 (110 kW)	2007.09-			L/R	F	Bus Engine OM646.982	GDS35084	Drive Shaft		30		66	96.5	652				
	2007.09-			L/R	R	Bus Engine OM646.982	GDS35022	Drive Shaft		30	26	70	94.5	849				
	2007.09-			L/R	R	Bus Engine OM646.982	GCI99177	Inner Joint		26	28	45	83.5	78				
	2007.09-			L/R	R	Bus Engine OM646.982	GC035024	Outer Joint		30	36	70	94.5	68	I			
2.2 CDi 4x4 (70 kW)	2007.09-			L/R	F	Bus Engine OM646.981	GDS35084	Drive Shaft		30		66	96.5	652				
	2007.09-			L/R	R	Bus Engine OM646.981	GDS35022	Drive Shaft		30	26	70	94.5	849				
	2007.09-			L/R	R	Bus Engine OM646.981	GCI99177	Inner Joint		26	28	45	83.5	78				
	2007.09-			L/R	R	Bus Engine OM646.981	GC035024	Outer Joint		30	36	70	94.5	68	I			
2.2 CDi 4x4 (80 kW)	2007.09-					Bus Engine OM646.982	GC035028	Outer Joint		30	36	70	95	68	I			
	2007.09-			L/R	F	Bus Engine OM646.982	GDS35084	Drive Shaft		30		66	96.5	652				
	2007.09-			L/R	R	Bus Engine OM646.982	GDS35022	Drive Shaft		30	26	70	94.5	849				
	2007.09-			L/R	R	Bus Engine OM646.982	GCI99177	Inner Joint		26	28	45	83.5	78				
	2007.09-			L/R	R	Bus Engine OM646.982	GC035024	Outer Joint		30	36	70	94.5	68	I			
<b>VITO / MIXTO (W639)</b>																		
2.1 CDi (100 kW)	2010.09-			L/R	R	Box Engine OM651.940	GDS35022	Drive Shaft		30	26	70	94.5	849				
	2010.09-			L/R	R	Box Engine OM651.940	GCI99177	Inner Joint		26	28	45	83.5	78				
	2010.09-			L/R	R	Box Engine OM651.940	GC035024	Outer Joint		30	36	70	94.5	68	I			
2.1 CDi (120 kW)	2010.09-			L/R	R	Box Engine OM651.940	GDS35022	Drive Shaft		30	26	70	94.5	849				
	2010.09-			L/R	R	Box Engine OM651.940	GCI99177	Inner Joint		26	28	45	83.5	78				
	2010.09-			L/R	R	Box Engine OM651.940	GC035024	Outer Joint		30	36	70	94.5	68	I			
2.1 CDi (70 kW)	2010.09-			L/R	R	Box Engine OM651.940	GDS35022	Drive Shaft		30	26	70	94.5	849				
	2010.09-			L/R	R	Box Engine OM651.940	GCI99177	Inner Joint		26	28	45	83.5	78				
	2010.09-			L/R	R	Box Engine OM651.940	GC035024	Outer Joint		30	36	70	94.5	68	I			
2.2 CDi (65 kW)	2003.09-				R	Box Engine OM646.983	GC035028	Outer Joint		30	36	70	95	68	I			
	2003.09-		MT	L/R	R	Box Engine OM646.983	GDS35022	Drive Shaft		30	26	70	94.5	849				
	2003.09-		MT	L/R	R	Box Engine OM646.983	GCI99177	Inner Joint		26	28	45	83.5	78				
	2003.09-		MT	L/R	R	Box Engine OM646.983	GC035024	Outer Joint		30	36	70	94.5	68	I			
2.2 CDi (70 kW)	2006.08-			L/R	R	Box Engine OM646.981	GDS35022	Drive Shaft		30	26	70	94.5	849				
	2006.08-			L/R	R	Box Engine OM646.981	GCI99177	Inner Joint		26	28	45	83.5	78				
	2006.08-			L/R	R	Box Engine OM646.981	GC035024	Outer Joint		30	36	70	94.5	68	I			
2.2 CDi (80 kW)	2003.09-				R	Box Engine OM646.982	GC035028	Outer Joint		30	36	70	95	68	I			
	2003.09-		MT/AT	L/R	R	Box Engine OM646.982	GDS35022	Drive Shaft		30	26	70	94.5	849				
	2003.09-		MT/AT	L/R	R	Box Engine OM646.982	GCI99177	Inner Joint		26	28	45	83.5	78				
	2003.09-		MT/AT	L/R	R	Box Engine OM646.982	GC035024	Outer Joint		30	36	70	94.5	68	I			
2.2 CDi (85 kW)	2007.09-			L/R	R	Box Engine OM646.982	GDS35022	Drive Shaft		30	26	70	94.5	849				
	2007.09-			L/R	R	Box Engine OM646.982	GCI99177	Inner Joint		26	28	45	83.5	78				
	2007.09-			L/R	R	Box Engine OM646.982	GC035024	Outer Joint		30	36	70	94.5	68	I			
	2007.09-					Box Engine OM646.982	GC035036	Outer Joint		30	37	70	94.5	61	I			
2.2 CDi 4x4 (110 kW)	2006.07-			L/R	F	Box Engine OM646.982	GDS35084	Drive Shaft		30		66	96.5	652				
	2006.07-			L/R	R	Box Engine OM646.982	GDS35022	Drive Shaft		30	26	70	94.5	849				
	2006.07-			L/R	R	Box Engine OM646.982	GCI99177	Inner Joint		26	28	45	83.5	78				
	2006.07-			L/R	R	Box Engine OM646.982	GC035024	Outer Joint		30	36	70	94.5	68	I			
2.2 CDi 4x4 (80 kW)	2007.09-					Box Engine OM646.982	GC035028	Outer Joint		30	36	70	95	68	I			
	2007.09-			L/R	F	Box Engine OM646.982	GDS35084	Drive Shaft		30		66	96.5	652				
	2007.09-			L/R	R	Box Engine OM646.982	GDS35022	Drive Shaft		30	26	70	94.5	849				
	2007.09-			L/R	R	Box Engine OM646.982	GCI99177	Inner Joint		26	28	45	83.5	78				
	2007.09-			L/R	R	Box Engine OM646.982	GC035024	Outer Joint		30	36	70	94.5	68	I			
<b>VITO II (W639)</b>																		
2.2 CDi (65 kW)	2003.09-					GC035028	Outer Joint		30	36	70	95	68	I				
2.2 CDi (80 kW)	2003.09-				Engine OM646982	GC035028	Outer Joint		30	36	70	95	68	I				









	YEAR	TRANSM	L/R	F/R	G-AP Ref.	PRODUCT	ABS	Technical Specifications								
								A	B	C	H	L	P			
<b>MERCURY COUGAR</b>																
-	1989-1997				GC099146	Outer Joint		28	32	55.9	95.5	64	I			
2.5	1999-2000			F	GC018081	Outer Joint	44W	27	32	54.3	91	62	I			
<b>COUGAR (FWD)</b>																
2.5	1999-2000				GC018056	Outer Joint		27	32	54.3	91	62	I			
<b>LYNX / LN7</b>																
-	1981-1987			R	GDS18081	Drive Shaft		26	23	51	88.5	892				
	1983.06-1990	MT	L		GDS18153	Drive Shaft		26	23	51	88.5	560				
	1984-1987	AT	L		GDS18148	Drive Shaft		26	23	51	88.5	562				
All Models	1983.04-1983.12	MT			GC018042	Outer Joint		26	23	51	88.5	60	I			
	1984.01-1985.12				GC018042	Outer Joint		26	23	51	88.5	60	I			
	1985.01-1985.12				GC018042	Outer Joint		26	23	51	88.5	60	I			
	1986.01-1987.12				GC018042	Outer Joint		26	23	51	88.5	60	I			
<b>MYSTIQUE</b>																
2.5	1995-2000				GC018056	Outer Joint		27	32	54.3	91	62	I			
	1995-2000				GC018081	Outer Joint	44W	27	32	54.3	91	62	I			
<b>SABLE</b>																
-	1986-1993			6 Cyl	GC018041	Outer Joint		26	30	56	106	61	I			
	1994-1999				GC018041	Outer Joint		26	30	56	106	61	I			
3.8	1986-1993			6 Cyl	GC018046	Outer Joint		26	32	55.9	105.5	64.5	I			
	1990-1993			6 Cyl	GC018085	Outer Joint	50T	26	32	55.9	105.5	64.5	I			
<b>TOPAZ</b>																
-	1984-1991	MT	L		GDS18153	Drive Shaft		26	23	51	88.5	560				
	1984-1991	AT	L		GDS18148	Drive Shaft		26	23	51	88.5	562				
	1984-		R		GDS18081	Drive Shaft		26	23	51	88.5	892				
2.3	1992-1994				GC018047	Outer Joint		26	28	51	107.5	58	I			
All Models	1984.01-1984.12	MT			GC018042	Outer Joint		26	23	51	88.5	60	I			
	1984.01-1991.12	AT			GC018042	Outer Joint		26	23	51	88.5	60	I			
	1985.01-1986.12				GC018042	Outer Joint		26	23	51	88.5	60	I			
	1985.01-1991.12	MT			GC018042	Outer Joint		26	23	51	88.5	60	I			
	1986-1991	AT			GC018059	Outer Joint		26	24	51	88	62	I			
<b>TRACER</b>																
-	1987-1989				GCI18006	Inner Joint		24	22	35	64	98.5				
	1991-1996		L		GDS18087	Drive Shaft		26	24	56	93	626.5				
	1991-1996				GC018048	Outer Joint		26	28	56	93	61	I			
	1991-1996				GC018079	Outer Joint	44T	26	28	56	93	61	I			
	1991-1996				GCI18039	Inner Joint		24	28	35	64.1	91.5				
1.8	1991-1996	AT			GCI18068	Inner Joint		24	28	35	63.9	89.5				
1.9	1991-1996	AT			GCI18068	Inner Joint		24	28	35	63.9	89.5				
2.0	1997-1999	AT			GCI18068	Inner Joint		24	28	35	63.9	89.5				
<b>VILLAGER</b>																
-	1993-1999				GC018075	Outer Joint		32	34	62	117.5	71.5	I			
	1993-1999				GC035017	Outer Joint	50T	32	34	62	117.5	71.5	I			
<b>MG</b>																
<b>MG TF</b>																
1.6 (85 kW)	2002.03-		L	R	Convertible Engine 16K4F	GDS51035	Drive Shaft	42T	25	29	50	82	567.5			
	2002.03-				Convertible Engine 16K4F	GC099242	Outer Joint	42T	25	22	50	82	56	I		
1.8 (100 kW)	2002.03-		L	R	Convertible Engine 18K4F	GDS51035	Drive Shaft	42T	25	29	50	82	567.5			
	2002.03-	MT		R	Convertible Engine 18K4F	GC099242	Outer Joint	42T	25	22	50	82	56	I		
1.8 (118 kW)	2002.03-		L	R	Convertible Engine 18K4K	GDS51035	Drive Shaft	42T	25	29	50	82	567.5			
	2002.03-	MT		R	Convertible Engine 18K4K	GC099242	Outer Joint	42T	25	22	50	82	56	I		
1.8 (88 kW)	2002.03-		L	R	Convertible Engine 18K4F	GDS51035	Drive Shaft	42T	25	29	50	82	567.5			
	2002.03-				Convertible Engine 18K4F	GC099242	Outer Joint	42T	25	22	50	82	56	I		
<b>MG ZR</b>																
1.8 (118 kW)	2001.06-2005.04	AT	L	F	Hatchback Engine 18K4K	GDS51019	Drive Shaft	43T	26	23	49	78.8	630.5			
	2001.06-2005.04	AT	R	F	Hatchback Engine 18K4K	GDS51018	Drive Shaft	43T	26	23	49	78.8	887			
1.8 (86 kW)	2001.06-2005.04	AT	L	F	Hatchback Engine 18K4F	GDS51019	Drive Shaft	43T	26	23	49	78.8	630.5			
	2001.06-2005.04	AT	R	F	Hatchback Engine 18K4F	GDS51018	Drive Shaft	43T	26	23	49	78.8	887			
<b>MGF (RD)</b>																
1.8 i VVC (118 kW)	2001.10-	2002.03	L	R	Convertible Engine 18K4K	GDS51035	Drive Shaft	42T	25	29	50	82	567.5			
	2001.10-	2002.03		R	Convertible Engine 18K4K	GC099242	Outer Joint	42T	25	22	50	82	56	I		
1.8 i 16V (88 kW)	1995.03-	2002.03	L	R	Convertible Engine 18K4F	GDS51035	Drive Shaft	42T	25	29	50	82	567.5			



		YEAR	TRANSM	L/R	F/R		G-AP Ref.	PRODUCT	ABS	Technical Specifications								
										A	B	C	H	L	P			
<b>MG</b>																		
<b>MGF (RD)</b>																		
1.8 i 16V (88 kW)	1995.03-	2002.03				Convertible Engine 18K4F	GC099242	Outer Joint	42T		25	22	50	82	56	I		
1.8 i VVC (107 kW)	1995.03-	2002.03	MT	L	R	Convertible Engine 18K4K	GDS51035	Drive Shaft	42T		25	29	50	82	567.5			
	1995.03-	2002.03	MT		R	Convertible Engine 18K4K	GC099242	Outer Joint	42T		25	22	50	82	56	I		
<b>MINI</b>																		
<b>MINI (R50, R53)</b>																		
1.4 One D (55 kW)	2003.06-	2006.09			F	Hatchback Engine 1ND	GC038001	Outer Joint			26	23	53.5	76	64	M		
	2003.06-	2006.09	MT		F	Hatchback Engine 1ND	GCI38001	Inner Joint			34	23	40	54	97			
	2003.06-	2006.09	MT	L	F	Hatchback Engine 1ND	GDS38001	Drive Shaft			26	34	53.5	74	590			
	2003.06-	2006.09	MT	R	F	Hatchback Engine 1ND	GDS81067	Drive Shaft			26	34	53.5	74	916			
1.4 One D (65 kW)	2003.06-	2006.09			F	Hatchback Engine 1ND-TV	GC038003	Outer Joint			26	23	53.5	74	63.5	M		
	2003.06-	2006.09	MT		F	Hatchback Engine 1ND-TV	GCI38001	Inner Joint			34	23	40	54	97			
	2003.06-	2006.09	MT	L	F	Hatchback Engine 1ND-TV	GDS38001	Drive Shaft			26	34	53.5	74	590			
1.6 Cooper (85 kW)	2001.06-	2006.09			F	Hatchback Engine W10B16A	GC038002	Outer Joint			26	21	53.5	76	61	M		
	2001.06-	2006.09	AT	L	F	Hatchback Engine W10B16A	GDS99288	Drive Shaft			26	23	53.5	76	617			
	2001.06-	2006.09	MT	L	F	Hatchback Engine W10B16A	GDS85053	Drive Shaft			26	33	53.5	76	588			
	2001.06-	2006.09	MT	L	F	Hatchback Engine W10B16A	GCI85044	Inner Joint			33	22	34.9	58	106			
	2001.06-	2006.09	MT	L	F	Hatchback Engine W10B16A	GDS99285	Drive Shaft			26	22	53.5	76	616			
	2001.06-	2006.09		L	F	Hatchback Engine W10B16A	GDS38005	Drive Shaft			26	22	53.5	76	616			
	2001.06-	2006.09	MT	L/R	F	Hatchback Engine W10B16A	GC085016	Outer Joint			26	22	53.5	76	56.5	M		
	2001.06-	2006.09	AT	R	F	Hatchback Engine W10B16A	GDS81066	Drive Shaft			26	23	53.5	76	894			
	2001.06-	2006.09	MT	R	F	Hatchback Engine W10B16A	GDS85025	Drive Shaft			26	33	53.5	76	924			
	2001.06-	2006.09	MT	R	F	Hatchback Engine W10B16A	GDS38003	Drive Shaft			26	22	53.5	76	886			
	2001.06-	2006.09	MT	R	F	Hatchback Engine W10B16A	GCI85043	Inner Joint			33	22	34.8	380	115			
	2001.06-	2006.09	MT	R	F	Hatchback Engine W10B16A	GCI38004	Inner Joint			22	21	28.5	332	96			
	2001.06-	2006.09	MT	R	F	Hatchback Engine W10B16A	GC038002	Outer Joint			26	21	53.5	76	61	M		
	1.6 Cooper S (120 kW)	2002.03-	2006.09	MT	R	F	Hatchback Engine W11B16A	GDS38002	Drive Shaft			26	34	53.5	74	917		
2002.03-		2006.09			F	Hatchback Engine W11B16A	GC038003	Outer Joint			26	23	53.5	74	63.5	M		
2002.03-		2006.09	MT		F	Hatchback Engine W11B16A	GCI38001	Inner Joint			34	23	40	54	97			
2002.03-		2006.09	MT		F	Hatchback Engine W11B16A	GCI38002	Inner Joint			34	23	28.5	333	145			
2002.03-		2006.09	AT	L	F	Hatchback Engine W11B16A	GDS85024	Drive Shaft			26	26	54	75.5	604			
2002.03-		2006.09	AT	L	F	Hatchback Engine W11B16A	GCI85012	Inner Joint			26	32	40	65	93			
2002.03-		2006.09	AT	L	F	Hatchback Engine W11B16A	GC085008	Outer Joint			26	26	54	75.5	70	M		
2002.03-		2006.09	MT	L	F	Hatchback Engine W11B16A	GDS38001	Drive Shaft			26	34	53.5	74	590			
1.6 Cooper S (125 kW)		2004.07-	2006.09	5MT		F	Hatchback Engine W11B16A	GCI38001	Inner Joint			34	23	40	54	97		
		2004.07-	2006.09	5MT		F	Hatchback Engine W11B16A	GCI38002	Inner Joint			34	23	28.5	333	145		
	2004.07-	2006.09	MT/AT		F	Hatchback Engine W11B16A	GC038003	Outer Joint			26	23	53.5	74	63.5	M		
	2004.07-	2006.09	5MT	L	F	Hatchback Engine W11B16A	GDS38001	Drive Shaft			26	34	53.5	74	590			
	2004.07-	2006.09	AT	L	F	Hatchback Engine W11B16A	GDS85024	Drive Shaft			26	26	54	75.5	604			
	2004.07-	2006.09	AT	L	F	Hatchback Engine W11B16A	GCI85012	Inner Joint			26	32	40	65	93			
	2004.07-	2006.09	AT	L	F	Hatchback Engine W11B16A	GC085008	Outer Joint			26	26	54	75.5	70	M		
	2004.07-	2006.09	5MT	R	F	Hatchback Engine W11B16A	GDS38002	Drive Shaft			26	34	53.5	74	917			
1.6 One (66 kW)	2001.06-	2006.09			F	Hatchback Engine W10B16A	GC038002	Outer Joint			26	21	53.5	76	61	M		
	2001.06-	2006.09	AT	L	F	Hatchback Engine W10B16A	GDS99288	Drive Shaft			26	23	53.5	76	617			
	2001.06-	2006.09	MT	L	F	Hatchback Engine W10B16A	GDS85053	Drive Shaft			26	33	53.5	76	588			
	2001.06-	2006.09	MT	L	F	Hatchback Engine W10B16A	GCI85044	Inner Joint			33	22	34.9	58	106			
	2001.06-	2006.09	MT	L	F	Hatchback Engine W10B16A	GDS99285	Drive Shaft			26	22	53.5	76	616			
	2001.06-	2006.09		L	F	Hatchback Engine W10B16A	GDS38005	Drive Shaft			26	22	53.5	76	616			
	2001.06-	2006.09	MT	L/R	F	Hatchback Engine W10B16A	GC085016	Outer Joint			26	22	53.5	76	56.5	M		
	2001.06-	2006.09	AT	R	F	Hatchback Engine W10B16A	GDS81066	Drive Shaft			26	23	53.5	76	894			
	2001.06-	2006.09	MT	R	F	Hatchback Engine W10B16A	GDS85025	Drive Shaft			26	33	53.5	76	924			
	2001.06-	2006.09	MT	R	F	Hatchback Engine W10B16A	GDS38003	Drive Shaft			26	22	53.5	76	886			
	2001.06-	2006.09	MT	R	F	Hatchback Engine W10B16A	GCI85043	Inner Joint			33	22	34.8	380	115			
	2001.06-	2006.09	MT	R	F	Hatchback Engine W10B16A	GCI38004	Inner Joint			22	21	28.5	332	96			
	2001.06-	2006.09	MT	R	F	Hatchback Engine W10B16A	GC038002	Outer Joint			26	21	53.5	76	61	M		
	1.6 Works (155 kW)	2003.11-	2006.09		L	F	Hatchback Engine W11B16A	GDS38001	Drive Shaft			26	34	53.5	74	590		
2003.11-		2006.09		R	F	Hatchback Engine W11B16A	GDS38002	Drive Shaft			26	34	53.5	74	917			
<b>MINI (R52)</b>																		
1.6 Cooper (85 kW)	2004.07-	2007.11	AT	L	F	Convertible Engine W10B16A	GDS99288	Drive Shaft			26	23	53.5	76	617			
	2004.07-	2007.11	MT	L	F	Convertible Engine W10B16A	GDS85053	Drive Shaft			26	33	53.5	76	588			
	2004.07-	2007.11	MT	L	F	Convertible Engine W10B16A	GCI85044	Inner Joint			33	22	34.9	58	106			
	2004.07-	2007.11		L	F	Convertible Engine W10B16A	GDS85026	Drive Shaft			26	33	53.5	76	591			

		YEAR	TRANSM	L/R	F/R		G-AP Ref.	PRODUCT	ABS	Technical Specifications										
										A	B	C	H	L	P					
<b>MINI</b>																				
<b>MINI (R52)</b>																				
1.6 Cooper (85 kW)	2004.07-	2007.11	MT	L/R	F	Convertible Engine W10B16A	GC085016	Outer Joint		26	22	53.5	76	56.5	M					
	2004.07-	2007.11	AT	R	F	Convertible Engine W10B16A	GDS81066	Drive Shaft		26	23	53.5	76	894						
	2004.07-	2007.11	MT	R	F	Convertible Engine W10B16A	GDS85054	Drive Shaft		26	33	53.5	76	921						
	2004.07-	2007.11	MT	R	F	Convertible Engine W10B16A	GCI85043	Inner Joint		33	22	34.8	380	115						
	2004.07-	2007.11		R	F	Convertible Engine W10B16A	GDS85025	Drive Shaft		26	33	53.5	76	924						
1.6 Cooper S (125 kW)	2004.07-	2007.11	MT		F	Convertible Engine W11B16A	GC038003	Outer Joint		26	23	53.5	74	63.5	M					
	2004.07-	2007.11	MT		F	Convertible Engine W11B16A	GCI38001	Inner Joint		34	23	40	54	97						
	2004.07-	2007.11	MT		F	Convertible Engine W11B16A	GCI38002	Inner Joint		34	23	28.5	333	145						
	2004.07-	2007.11	AT	L	F	Convertible Engine W11B16A	GDS85024	Drive Shaft		26	26	54	75.5	604						
	2004.07-	2007.11	AT	L	F	Convertible Engine W11B16A	GCI85012	Inner Joint		26	32	40	65	93						
	2004.07-	2007.11	AT	L	F	Convertible Engine W11B16A	GC085008	Outer Joint		26	26	54	75.5	70	M					
	2004.07-	2007.11	MT	L	F	Convertible Engine W11B16A	GDS38001	Drive Shaft		26	34	53.5	74	590						
	2004.07-	2007.11	MT	R	F	Convertible Engine W11B16A	GDS38002	Drive Shaft		26	34	53.5	74	917						
1.6 One (66 kW)	2004.07-	2007.11	MT	L	F	Convertible Engine W10B16A	GDS85053	Drive Shaft		26	33	53.5	76	588						
	2004.07-	2007.11	MT	L	F	Convertible Engine W10B16A	GCI85044	Inner Joint		33	22	34.9	58	106						
	2004.07-	2007.11		L	F	Convertible Engine W10B16A	GDS85026	Drive Shaft		26	33	53.5	76	591						
	2004.07-	2007.11	MT	L/R	F	Convertible Engine W10B16A	GC085016	Outer Joint		26	22	53.5	76	56.5	M					
	2004.07-	2007.11	MT	R	F	Convertible Engine W10B16A	GDS85054	Drive Shaft		26	33	53.5	76	921						
	2004.07-	2007.11	MT	R	F	Convertible Engine W10B16A	GCI85043	Inner Joint		33	22	34.8	380	115						
2004.07-	2007.11		R	F	Convertible Engine W10B16A	GDS85025	Drive Shaft		26	33	53.5	76	924							
<b>MINI (R56)</b>																				
1.4 One (55 kW)	2009.03-		MT	R	F	Hatchback Engine N12B14A	GDS85045	Drive Shaft		26	33	54	75.5	901						
	2009.03-		MT			Hatchback Engine N12B14A	GC085009	Outer Joint		26	24	54	75.5	65.5	M					
1.4 One (70 kW)	2007.03-		MT	L	F	Hatchback Engine N12B14A	GDS85041	Drive Shaft		26	33	54	75.5	619						
	2007.03-		MT	R	F	Hatchback Engine N12B14A	GDS85045	Drive Shaft		26	33	54	75.5	901						
	2007.03-		MT			Hatchback Engine N12B14A	GC085009	Outer Joint		26	24	54	75.5	65.5	M					
1.6 Cooper (85 kW)	2010.03-		MT	L	F	Hatchback Engine N12B16A/N16B16A	GDS85041	Drive Shaft		26	33	54	75.5	619						
	2010.03-		MT	R	F	Hatchback Engine N12B16A/N16B16A	GDS85045	Drive Shaft		26	33	54	75.5	901						
1.6 Cooper (88 kW)	2006.10-		AT	L	F	Hatchback Engine N12B16A	GDS85024	Drive Shaft		26	26	54	75.5	604						
	2006.10-		AT	L	F	Hatchback Engine N12B16A	GCI85012	Inner Joint		26	32	40	65	93						
	2006.10-		AT	L	F	Hatchback Engine N12B16A	GC085008	Outer Joint		26	26	54	75.5	70	M					
	2006.10-		MT	L	F	Hatchback Engine N12B16A	GDS85041	Drive Shaft		26	33	54	75.5	619						
	2006.10-		MT	R	F	Hatchback Engine N12B16A	GDS85045	Drive Shaft		26	33	54	75.5	901						
2006.10-		MT			Hatchback Engine N12B16A	GC085009	Outer Joint		26	24	54	75.5	65.5	M						
1.6 Cooper (90 kW)	2010.03-		AT	L	F	Hatchback Engine N16B16A	GDS85024	Drive Shaft		26	26	54	75.5	604						
	2010.03-		AT	L	F	Hatchback Engine N16B16A	GCI85012	Inner Joint		26	32	40	65	93						
	2010.03-		AT	L	F	Hatchback Engine N16B16A	GC085008	Outer Joint		26	26	54	75.5	70	M					
	2010.03-		MT	L	F	Hatchback Engine N16B16A	GDS85041	Drive Shaft		26	33	54	75.5	619						
	2010.03-		MT	R	F	Hatchback Engine N16B16A	GDS85045	Drive Shaft		26	33	54	75.5	901						
	2010.03-		MT			Hatchback Engine N16B16A	GC085009	Outer Joint		26	24	54	75.5	65.5	M					
1.6 Cooper D (80 kW)	2007.03-		MT	L	F	Hatchback Engine 9HZ(DV6TED4)	GDS85063	Drive Shaft		26	34	54	75.5	590						
	2007.03-		MT	R	F	Hatchback Engine 9HZ(DV6TED4)	GDS85071	Drive Shaft		26	34	54	75.5	918						
1.6 Cooper D (82 kW)	2010.06-		MT	L	F	Hatchback Engine N47C16A	GDS85063	Drive Shaft		26	34	54	75.5	590						
	2010.06-		MT	R	F	Hatchback Engine N47C16A	GDS85071	Drive Shaft		26	34	54	75.5	918						
1.6 Cooper S (120 kW)	2010.03-		MT	L	F	Hatchback Engine N18B16A	GDS85063	Drive Shaft		26	34	54	75.5	590						
	2010.03-		MT	R	F	Hatchback Engine N18B16A	GDS85071	Drive Shaft		26	34	54	75.5	918						
1.6 Cooper S (128 kW)	2006.10-		MT	L	F	Hatchback Engine N14B16A	GDS85063	Drive Shaft		26	34	54	75.5	590						
	2006.10-		MT	R	F	Hatchback Engine N14B16A	GDS85071	Drive Shaft		26	34	54	75.5	918						
1.6 Cooper S (135 kW)	2010.03-		MT	L	F	Hatchback Engine N18B16A	GDS85063	Drive Shaft		26	34	54	75.5	590						
	2010.03-		MT	R	F	Hatchback Engine N18B16A	GDS85071	Drive Shaft		26	34	54	75.5	918						
1.6 Cooper S (147 kW)	2012.01-		MT	L	F	Hatchback Engine N18B16A	GDS85063	Drive Shaft		26	34	54	75.5	590						
	2012.01-		MT	R	F	Hatchback Engine N18B16A	GDS85071	Drive Shaft		26	34	54	75.5	918						
1.6 John Cooper Works (155 kW)	2008.03-		MT	L	F	Hatchback Engine N14B16C	GDS85063	Drive Shaft		26	34	54	75.5	590						
	2008.03-		MT	R	F	Hatchback Engine N14B16C	GDS85071	Drive Shaft		26	34	54	75.5	918						
1.6 John Cooper Works GP (160 kW)	2012.09-		MT	L	F	Hatchback Engine N18B16B	GDS85063	Drive Shaft		26	34	54	75.5	590						
	2012.09-		MT	R	F	Hatchback Engine N18B16B	GDS85071	Drive Shaft		26	34	54	75.5	918						
1.6 One (55 kW)	2010.03-		MT	L	F	Hatchback Engine N16B16A	GDS85041	Drive Shaft		26	33	54	75.5	619						
	2010.03-		MT			Hatchback Engine N16B16A	GC085009	Outer Joint		26	24	54	75.5	65.5	M					
1.6 One (72 kW)	2010.03-		MT	L	F	Hatchback Engine N16B16A	GDS85041	Drive Shaft		26	33	54	75.5	619						
	2010.03-		MT	R	F	Hatchback Engine N16B16A	GDS85045	Drive Shaft		26	33	54	75.5	901						
	2010.03-		MT			Hatchback Engine N16B16A	GC085009	Outer Joint		26	24	54	75.5	65.5	M					









		TRANSM	L/R	F/R		G-AP Ref.	PRODUCT	ABS	Technical Specifications									
									YEAR	A	B	C	H	L	P			
<b>MINI</b>																		
<b>MINI (R56)</b>																		
1.6 One D (66 kW)	2009.06-	2010.07	MT	L	F	Hatchback Engine 9HZ(DV6TED4)	GDS85063	Drive Shaft		26	34	54	75.5	590				
	2009.06-	2010.07	MT	R	F	Hatchback Engine 9HZ(DV6TED4)	GDS85071	Drive Shaft		26	34	54	75.5	918				
	2010.07-		MT	L	F	Estate Engine N47C16A	GDS85063	Drive Shaft		26	34	54	75.5	590				
	2010.07-		MT	R	F	Estate Engine N47C16A	GDS85071	Drive Shaft		26	34	54	75.5	918				
2.0 Cooper D (82 kW)	2011.02-		MT	L	F	Hatchback Engine N47C20A	GDS85063	Drive Shaft		26	34	54	75.5	590				
	2011.02-		MT	R	F	Hatchback Engine N47C20A	GDS85071	Drive Shaft		26	34	54	75.5	918				
<b>MINI (R57)</b>																		
1.6 Cooper (85 kW)	2009.03-		AT	L	F	Convertible Engine N16B16A	GDS85024	Drive Shaft		26	26	54	75.5	604				
	2009.03-		AT	L	F	Convertible Engine N16B16A	GCI85012	Inner Joint		26	32	40	65	93				
	2009.03-		AT	L	F	Convertible Engine N16B16A	GC085008	Outer Joint		26	26	54	75.5	70	M			
	2009.03-		MT	L	F	Convertible Engine N16B16A	GDS85041	Drive Shaft		26	33	54	75.5	619				
	2009.03-		MT	R	F	Convertible Engine N16B16A	GDS85045	Drive Shaft		26	33	54	75.5	901				
1.6 Cooper (88 kW)	2009.03-		AT	L	F	Convertible Engine N12B16A	GDS85024	Drive Shaft		26	26	54	75.5	604				
	2009.03-		AT	L	F	Convertible Engine N12B16A	GCI85012	Inner Joint		26	32	40	65	93				
	2009.03-		AT	L	F	Convertible Engine N12B16A	GC085008	Outer Joint		26	26	54	75.5	70	M			
	2009.03-		MT	L	F	Convertible Engine N12B16A	GDS85041	Drive Shaft		26	33	54	75.5	619				
	2009.03-		MT	R	F	Convertible Engine N12B16A	GDS85045	Drive Shaft		26	33	54	75.5	901				
1.6 Cooper (90 kW)	2010.03-		MT	L	F	Convertible Engine N16B16A	GDS85041	Drive Shaft		26	33	54	75.5	619				
	2010.03-		MT	R	F	Convertible Engine N16B16A	GDS85045	Drive Shaft		26	33	54	75.5	901				
	2010.03-		MT			Convertible Engine N16B16A	GC085009	Outer Joint		26	24	54	75.5	65.5	M			
	2010.03-		MT			Convertible Engine N16B16A	GDS85041	Drive Shaft		26	33	54	75.5	619				
1.6 Cooper S (128 kW)	2009.03-		MT	L	F	Convertible Engine N14B16A	GDS85063	Drive Shaft		26	34	54	75.5	590				
	2009.03-		MT	R	F	Convertible Engine N14B16A	GDS85071	Drive Shaft		26	34	54	75.5	918				
1.6 Cooper S (135 kW)	2010.03-		MT	L	F	Convertible Engine N18B16A	GDS85063	Drive Shaft		26	34	54	75.5	590				
	2010.03-		MT	R	F	Convertible Engine N18B16A	GDS85071	Drive Shaft		26	34	54	75.5	918				
1.6 Cooper S (147 kW)	2010.03-		MT	L	F	Convertible Engine N18B16A	GDS85063	Drive Shaft		26	34	54	75.5	590				
	2010.03-		MT	R	F	Convertible Engine N18B16A	GDS85071	Drive Shaft		26	34	54	75.5	918				
1.6 John Cooper Works (155 kW)	2008.03-		MT	L	F	Convertible Engine N14B16C	GDS85063	Drive Shaft		26	34	54	75.5	590				
	2008.03-		MT	R	F	Convertible Engine N14B16C	GDS85071	Drive Shaft		26	34	54	75.5	918				
1.6 One (72 kW)	2010.03-		MT	L	F	Convertible Engine N16B16A	GDS85041	Drive Shaft		26	33	54	75.5	619				
	2010.03-		MT	R	F	Convertible Engine N16B16A	GDS85045	Drive Shaft		26	33	54	75.5	901				
	2010.03-		MT			Convertible Engine N16B16A	GC085009	Outer Joint		26	24	54	75.5	65.5	M			
<b>MINI (R58)</b>																		
1.6 Cooper (90 kW)	2011.09-		MT			Coupe Engine N16B16A	GC085009	Outer Joint		26	24	54	75.5	65.5	M			
1.6 Cooper S (120 kW)	2011.09-		MT	L	F	Coupe Engine N18B16A	GDS85063	Drive Shaft		26	34	54	75.5	590				
	2011.09-		MT	R	F	Coupe Engine N18B16A	GDS85071	Drive Shaft		26	34	54	75.5	918				
1.6 Cooper S (135 kW)	2011.09-		MT	L	F	Coupe Engine N18B16A	GDS85063	Drive Shaft		26	34	54	75.5	590				
	2011.09-		MT	R	F	Coupe Engine N18B16A	GDS85071	Drive Shaft		26	34	54	75.5	918				
1.6 Cooper S (147 kW)	2011.09-		MT	L	F	Coupe Engine N18B16A	GDS85063	Drive Shaft		26	34	54	75.5	590				
	2011.09-		MT	R	F	Coupe Engine N18B16A	GDS85071	Drive Shaft		26	34	54	75.5	918				
1.6 John Cooper Works (155 kW)	2011.09-		MT	L	F	Coupe Engine N14B16C	GDS85063	Drive Shaft		26	34	54	75.5	590				
	2011.09-		MT	R	F	Coupe Engine N14B16C	GDS85071	Drive Shaft		26	34	54	75.5	918				
2.0 Cooper SD (100 kW)	2011.09-		MT	L	F	Coupe Engine N47C20A	GDS85063	Drive Shaft		26	34	54	75.5	590				
	2011.09-		MT	R	F	Coupe Engine N47C20A	GDS85071	Drive Shaft		26	34	54	75.5	918				
2.0 Cooper SD (105 kW)	2011.09-		MT	L	F	Coupe Engine N47C20A	GDS85063	Drive Shaft		26	34	54	75.5	590				
	2011.09-		MT	R	F	Coupe Engine N47C20A	GDS85071	Drive Shaft		26	34	54	75.5	918				
<b>MINI CLUBMAN (R55)</b>																		
1.4 One (70 kW)	2009.03-	2010.02	MT			Estate Engine N12B14A	GC085009	Outer Joint		26	24	54	75.5	65.5	M			
1.6 Cooper (88 kW)	2007.10-		MT			Estate Engine N12B16A/N16B16A	GC085009	Outer Joint		26	24	54	75.5	65.5	M			
1.6 Cooper D (80 kW)	2007.10-		MT	L	F	Estate Engine 9HZ(DV6TED4)	GDS85063	Drive Shaft		26	34	54	75.5	590				
	2007.10-		MT	R	F	Estate Engine 9HZ(DV6TED4)	GDS85071	Drive Shaft		26	34	54	75.5	918				
	2007.10-		MT			Estate Engine 9HZ(DV6TED4)	GC085009	Outer Joint		26	24	54	75.5	65.5	M			
1.6 Cooper D (82 kW)	2010.03-		MT	L	F	Estate Engine N47C16A	GDS85063	Drive Shaft		26	34	54	75.5	590				
	2010.03-		MT	R	F	Estate Engine N47C16A	GDS85071	Drive Shaft		26	34	54	75.5	918				
1.6 Cooper S (128 kW)	2007.10-		MT	L	F	Estate Engine N14B16A	GDS85063	Drive Shaft		26	34	54	75.5	590				
	2007.10-		MT	R	F	Estate Engine N14B16A	GDS85071	Drive Shaft		26	34	54	75.5	918				
	2007.10-		MT			Estate Engine N14B16A	GC085009	Outer Joint		26	24	54	75.5	65.5	M			
1.6 Cooper S (135 kW)	2010.03-		MT	L	F	Estate Engine N18B16A	GDS85063	Drive Shaft		26	34	54	75.5	590				
	2010.03-		MT	R	F	Estate Engine N18B16A	GDS85071	Drive Shaft		26	34	54	75.5	918				
1.6 Cooper S (147 kW)	2010.03-		MT	L	F	Estate Engine N18B16A	GDS85063	Drive Shaft		26	34	54	75.5	590				
	2010.03-		MT	R	F	Estate Engine N18B16A	GDS85071	Drive Shaft		26	34	54	75.5	918				



		TRANSM	L/R	F/R		G-AP Ref.	PRODUCT	ABS	Technical Specifications									
									YEAR	A	B	C	H	L	P			
<b>MINI</b>																		
<b>MINI CLUBMAN (R55)</b>																		
1.6 John Cooper Works (141 kW)	2008.10-		MT	L	F	Estate Engine N14B16A	GDS85063	Drive Shaft		26	34	54	75.5	590				
	2008.10-		MT	R	F	Estate Engine N14B16A	GDS85071	Drive Shaft		26	34	54	75.5	918				
1.6 John Cooper Works (155 kW)	2008.03-		MT	L	F	Estate Engine N14B16C	GDS85063	Drive Shaft		26	34	54	75.5	590				
	2008.03-		MT	R	F	Estate Engine N14B16C	GDS85071	Drive Shaft		26	34	54	75.5	918				
2.0 Cooper D (82 kW)	2011.02-		MT	L	F	Estate Engine N47C20A	GDS85063	Drive Shaft		26	34	54	75.5	590				
	2011.02-		MT	R	F	Estate Engine N47C20A	GDS85071	Drive Shaft		26	34	54	75.5	918				
<b>MINI COUNTRYMAN (R60)</b>																		
One (72 kW)	2010.06-		MT			Hatchback Engine N16B16A	GC085009	Outer Joint		26	24	54	75.5	65.5	M			
<b>MINI I (R50, R53)</b>																		
1.4 (55 kW)	2003.04-	2006.10					GC038002	Outer Joint		26	21	53.5	76	61	M			
1.6 Cooper (85 kW)	2001.06-						GC038002	Outer Joint		26	21	53.5	76	61	M			
1.6 One (66 kW)	2001.06-						GC038002	Outer Joint		26	21	53.5	76	61	M			
<b>MINI I CABRIO (R52)</b>																		
1.6 Cooper (85 kW)	2004-	2007					GC038002	Outer Joint		26	21	53.5	76	61	M			
1.6 One (66 kW)	2004-	2007					GC038002	Outer Joint		26	21	53.5	76	61	M			
<b>MINI II CLUBMAN (R55)</b>																		
1.4 (70 kW)	2010-		MT				GC085009	Outer Joint		26	24	54	75.5	65.5	M			
1.6 Cooper (88 kW)	2007-		AT				GC085008	Outer Joint		26	26	54	75.5	70	M			
	2007-		MT				GC085009	Outer Joint		26	24	54	75.5	65.5	M			
1.6 Cooper D (80 kW)	2007-		MT				GC085009	Outer Joint		26	24	54	75.5	65.5	M			
	2009-		MT				GC085008	Outer Joint		26	26	54	75.5	70	M			
1.6 Cooper S (128 kW)	2007-		MT				GC085009	Outer Joint		26	24	54	75.5	65.5	M			
	2009-		MT				GC085008	Outer Joint		26	26	54	75.5	70	M			
2.0 SD Cooper (105 kW)	2011-		MT				GC085008	Outer Joint		26	26	54	75.5	70	M			
<b>MINI II, CABRIO (R56, R57)</b>																		
1.4 One (55 kW)	2007.03-		MT				GC085009	Outer Joint		26	24	54	75.5	65.5	M			
1.4 One (70 kW)	2007.03-		MT				GC085009	Outer Joint		26	24	54	75.5	65.5	M			
1.6 Cooper (160 kW)	2007-		MT				GC085008	Outer Joint		26	26	54	75.5	70	M			
1.6 Cooper (90 kW)	2010-		MT				GC085009	Outer Joint		26	24	54	75.5	65.5	M			
1.6 Cooper Cabrio (155 kW)	2008-		MT				GC085008	Outer Joint		26	26	54	75.5	70	M			
1.6 Cooper Cabrio (88 kW)	2006-		MT				GC085009	Outer Joint		26	24	54	75.5	65.5	M			
1.6 Cooper D (80 kW)	2007-	2010	MT				GC085008	Outer Joint		26	26	54	75.5	70	M			
1.6 Cooper D (82 kW)	2007-	2010	MT				GC085008	Outer Joint		26	26	54	75.5	70	M			
1.6 Cooper S (135 kW)	2010-		MT				GC085008	Outer Joint		26	26	54	75.5	70	M			
1.6 Cooper S Cabrio (128 kW)	2006-		MT				GC085008	Outer Joint		26	26	54	75.5	70	M			
1.6 D (66 kW)	2009-		MT				GC085008	Outer Joint		26	26	54	75.5	70	M			
1.6 One (55 kW)	2009-		MT				GC085009	Outer Joint		26	24	54	75.5	65.5	M			
1.6 One Cabrio (72 kW)	2009-		MT				GC085009	Outer Joint		26	24	54	75.5	65.5	M			
2.0 SD Cooper (105 kW)	2011-		MT				GC085008	Outer Joint		26	26	54	75.5	70	M			
<b>MINI III (R58, R59)</b>																		
1.6 Cooper (90 kW)	2011-		MT				GC085009	Outer Joint		26	24	54	75.5	65.5	M			
1.6 Cooper S (135 kW)	2011-		MT				GC085008	Outer Joint		26	26	54	75.5	70	M			
1.6 Cooper S JCW (155 kW)	2011-		MT				GC085008	Outer Joint		26	26	54	75.5	70	M			
2.0 SD Cooper (105 kW)	2011-		MT				GC085008	Outer Joint		26	26	54	75.5	70	M			
<b>MINI ROADSTER (R59)</b>																		
1.6 Cooper (90 kW)	2012.02-		MT			Convertible Engine N16B16A	GC085009	Outer Joint		26	24	54	75.5	65.5	M			
1.6 Cooper S (120 kW)	2012.02-		MT	L	F	Convertible Engine N18B16A	GDS85063	Drive Shaft		26	34	54	75.5	590				
	2012.02-		MT	R	F	Convertible Engine N18B16A	GDS85071	Drive Shaft		26	34	54	75.5	918				
1.6 Cooper S (135 kW)	2012.02-		MT	L	F	Convertible Engine N18B16A	GDS85063	Drive Shaft		26	34	54	75.5	590				
	2012.02-		MT	R	F	Convertible Engine N18B16A	GDS85071	Drive Shaft		26	34	54	75.5	918				
1.6 Cooper S (147 kW)	2012.02-		MT	L	F	Convertible Engine N18B16A	GDS85063	Drive Shaft		26	34	54	75.5	590				
	2012.02-		MT	R	F	Convertible Engine N18B16A	GDS85071	Drive Shaft		26	34	54	75.5	918				
1.6 John Cooper Works (155 kW)	2012.02-		MT	L	F	Convertible Engine N14B16C	GDS85063	Drive Shaft		26	34	54	75.5	590				
	2012.02-		MT	R	F	Convertible Engine N14B16C	GDS85071	Drive Shaft		26	34	54	75.5	918				
2.0 Cooper SD (100 kW)	2012.02-		MT	L	F	Convertible Engine N47C20A	GDS85063	Drive Shaft		26	34	54	75.5	590				
	2012.02-		MT	R	F	Convertible Engine N47C20A	GDS85071	Drive Shaft		26	34	54	75.5	918				
2.0 Cooper SD (105 kW)	2012.02-		MT	L	F	Convertible Engine N47C20A	GDS85063	Drive Shaft		26	34	54	75.5	590				
	2012.02-		MT	R	F	Convertible Engine N47C20A	GDS85071	Drive Shaft		26	34	54	75.5	918				

		TRANSM	L/R	F/R		G-AP Ref.	PRODUCT	ABS	Technical Specifications									
									YEAR	A	B	C	H	L	P			
<b>MITSUBISHI</b>																		
<b>3000 GT (FWD)</b>																		
-	1991-	1992				GCI15006	Inner Joint		26	26	42	39.5	78.5					
<b>3000 GT (Z16A)</b>																		
3.0 i 24V 4WD (210 kW)	1992.06-	1999.08			F Coupe Engine 6G72(DOHC24V)	GC039077	Outer Joint	47T	27	26	60	97	69	I				
<b>AIRTREK (CU2W)</b>																		
2.0 4WD	2001.03-		4AT/I		Engine 4G63	GC039176	Outer Joint	43T	25	29	57	95	58	M				
	2002.05-	2003.02	5AT/I		Engine 4G63	GC039176	Outer Joint	43T	25	29	57	95	58	M				
	2003.03-		5AT/I		Engine 4G63 TBO	GC039176	Outer Joint	43T	25	29	57	95	58	M				
<b>AIRTREK (CU4W)</b>																		
2.4 4WD	2001.03-		4AT/I		Engine 4G64	GC039176	Outer Joint	43T	25	29	57	95	58	M				
<b>AIRTREK (CU5W)</b>																		
2.4 4WD	2004.01-		4AT/I		Engine 4G69	GC039176	Outer Joint	43T	25	29	57	95	58	M				
<b>CARISMA (DA)</b>																		
1.6 (70 kW)	1997.05-	2006.06				GC039022	Outer Joint	43T	25	29	54	94.5	64.5	O				
1.6 (73 kW)	1997.05-	2006.06				GC039022	Outer Joint	43T	25	29	54	94.5	64.5	O				
1.6 (76 kW)	1997.05-	2006.06				GC039022	Outer Joint	43T	25	29	54	94.5	64.5	O				
1.9 TD (66 kW)	1996.10-	2000.09				GC039022	Outer Joint	43T	25	29	54	94.5	64.5	O				
<b>CARISMA (DA_)</b>																		
1.6 (66 kW)	1995.07-	2006.06	MT/AT	F	Hatchback Engine 4G92	GC039022	Outer Joint	43T	25	29	54	94.5	64.5	O				
	1995.07-	2006.06	MT/AT	F	Hatchback Engine 4G92	GC039024	Outer Joint	43T	25	23	54	95.5	64	M				
	1995.07-	2006.06	MT/AT	F	Hatchback Engine 4G92	GC039007	Outer Joint	43T	25	23	54	95	60	I				
	1995.07-	2006.06	MT/AT	F	Hatchback Engine 4G92	GC039098	Outer Joint		25	23	54	95	60	I				
	1995.07-	2006.06			Hatchback Engine 4G92	GC099230	Outer Joint	43T	25	29	54	95	60	O				
	1996.09-	2006.06	MT/AT	F	Saloon Engine 4G92	GC039022	Outer Joint	43T	25	29	54	94.5	64.5	O				
	1996.09-	2006.06	MT/AT	F	Saloon Engine 4G92	GC039024	Outer Joint	43T	25	23	54	95.5	64	M				
	1996.09-	2006.06	MT/AT	F	Saloon Engine 4G92	GC039007	Outer Joint	43T	25	23	54	95	60	I				
	1996.09-	2006.06	MT/AT	F	Saloon Engine 4G92	GC039098	Outer Joint		25	23	54	95	60	I				
1.6 (70 kW)	1998.12-	2006.06		F	Saloon Engine 4G92	GC051014	Outer Joint		25	29	54	95	60	O				
	1998.12-	2006.06	MT/AT	F	Hatchback Engine 4G92	GC039022	Outer Joint	43T	25	29	54	94.5	64.5	O				
	1998.12-	2006.06	MT/AT	F	Hatchback Engine 4G92	GC039024	Outer Joint	43T	25	23	54	95.5	64	M				
	1998.12-	2006.06	MT/AT	F	Hatchback Engine 4G92	GC039007	Outer Joint	43T	25	23	54	95	60	I				
	1998.12-	2006.06	MT/AT	F	Hatchback Engine 4G92	GC039098	Outer Joint		25	23	54	95	60	I				
	1998.12-	2006.06	MT/AT	F	Saloon Engine 4G92	GC039022	Outer Joint	43T	25	29	54	94.5	64.5	O				
	1998.12-	2006.06	MT/AT	F	Saloon Engine 4G92	GC039024	Outer Joint	43T	25	23	54	95.5	64	M				
	1998.12-	2006.06	MT/AT	F	Saloon Engine 4G92	GC039007	Outer Joint	43T	25	23	54	95	60	I				
	1998.12-	2006.06	MT/AT	F	Saloon Engine 4G92	GC039098	Outer Joint		25	23	54	95	60	I				
	1998.12-	2006.06			Saloon Engine 4G92	GC039070	Outer Joint	43T	25	29	54	95	60	O				
1.6 (73 kW)	1997.05-	2006.06	MT/AT	F	Hatchback Engine 4G92	GC039022	Outer Joint	43T	25	29	54	94.5	64.5	O				
	1997.05-	2006.06	MT/AT	F	Hatchback Engine 4G92	GC039024	Outer Joint	43T	25	23	54	95.5	64	M				
	1997.05-	2006.06	MT/AT	F	Hatchback Engine 4G92	GC039007	Outer Joint	43T	25	23	54	95	60	I				
	1997.05-	2006.06	MT/AT	F	Hatchback Engine 4G92	GC039098	Outer Joint		25	23	54	95	60	I				
	1997.05-	2006.06	MT/AT	F	Saloon Engine 4G92	GC039022	Outer Joint	43T	25	29	54	94.5	64.5	O				
	1997.05-	2006.06	MT/AT	F	Saloon Engine 4G92	GC039024	Outer Joint	43T	25	23	54	95.5	64	M				
	1997.05-	2006.06	MT/AT	F	Saloon Engine 4G92	GC039007	Outer Joint	43T	25	23	54	95	60	I				
	1997.05-	2006.06	MT/AT	F	Saloon Engine 4G92	GC039098	Outer Joint		25	23	54	95	60	I				
	1997.05-	2006.06			Hatchback Engine 4G92	GC099230	Outer Joint	43T	25	29	54	95	60	O				
1.6 (76 kW)	1999.08-	2004.12		F	Hatchback Engine 4G92	GC039024	Outer Joint	43T	25	23	54	95.5	64	M				
	1999.08-	2004.12		F	Saloon Engine 4G92	GC039024	Outer Joint	43T	25	23	54	95.5	64	M				
	1999.08-	2004.12			Hatchback Engine 4G92	GC099230	Outer Joint	43T	25	29	54	95	60	O				
1.8 (85 kW)	1995.07-	2006.06	MT/AT	F	Hatchback Engine 4G93	GC039022	Outer Joint	43T	25	29	54	94.5	64.5	O				
	1995.07-	2006.06	MT/AT	F	Hatchback Engine 4G93	GC039024	Outer Joint	43T	25	23	54	95.5	64	M				
	1995.07-	2006.06			Hatchback Engine 4G93	GC099230	Outer Joint	43T	25	29	54	95	60	O				
	1996.09-	2006.06		F	Saloon Engine 4G93	GC051014	Outer Joint		25	29	54	95	60	O				
	1996.09-	2006.06	MT/AT	F	Saloon Engine 4G93	GC039022	Outer Joint	43T	25	29	54	94.5	64.5	O				
	1996.09-	2006.06	MT/AT	F	Saloon Engine 4G93	GC039024	Outer Joint	43T	25	23	54	95.5	64	M				
	1996.09-	2006.06			Saloon Engine 4G93	GC099230	Outer Joint	43T	25	29	54	95	60	O				
1.8 16V (103 kW)	1995.07-	2006.06		F	Hatchback Engine 4G93	GC039024	Outer Joint	43T	25	23	54	95.5	64	M				
	1995.07-	2006.06		F	Hatchback Engine 4G93	GC039017	Outer Joint	43T	25	23	54	95.5	63.5	I				
1.8 16V GDi (92 kW)	1997.09-	2006.06		F	Hatchback Engine 4G93	GC039017	Outer Joint	43T	25	23	54	95.5	63.5	I				
	1997.09-	2006.06		F	Saloon Engine 4G93	GC039017	Outer Joint	43T	25	23	54	95.5	63.5	I				
	1997.09-	2006.06	MT/AT	F	Hatchback Engine 4G93	GC039022	Outer Joint	43T	25	29	54	94.5	64.5	O				
	1997.09-	2006.06	MT/AT	F	Hatchback Engine 4G93	GC039024	Outer Joint	43T	25	23	54	95.5	64	M				
	1997.09-	2006.06	MT/AT	F	Hatchback Engine 4G93	GC039007	Outer Joint	43T	25	23	54	95	60	I				









		TRANSM	L/R	F/R		G-AP Ref.	PRODUCT	ABS	Technical Specifications							
									YEAR	A	B	C	H	L	P	
<b>MITSUBISHI</b>																
<b>CARISMA (DA_)</b>																
1.8 16V GDi (92 kW)	1997.09-2006.06	MT/AT		F	Hatchback Engine 4G93	GC039098	Outer Joint		25	23	54	95	60	I		
	1997.09-2006.06	MT/AT		F	Saloon Engine 4G93	GC039022	Outer Joint	43T	25	29	54	94.5	64.5	O		
	1997.09-2006.06	MT/AT		F	Saloon Engine 4G93	GC039024	Outer Joint	43T	25	23	54	95.5	64	M		
	1997.09-2006.06	MT/AT		F	Saloon Engine 4G93	GC039007	Outer Joint	43T	25	23	54	95	60	I		
	1997.09-2006.06	MT/AT		F	Saloon Engine 4G93	GC039098	Outer Joint		25	23	54	95	60	I		
1.8 GDi (90 kW)	2000.10-2006.06			F	Hatchback Engine 4G93	GC039024	Outer Joint	43T	25	23	54	95.5	64	M		
	2000.10-2006.06			F	Saloon Engine 4G93	GC039024	Outer Joint	43T	25	23	54	95.5	64	M		
1.9 Di-D (75 kW)	2000.09-2006.06			F	Hatchback Engine F9Q1	GC039084	Outer Joint	43T	26	33	54	95	60	M		
	2000.09-2006.06			F	Saloon Engine F9Q1	GC039084	Outer Joint	43T	26	33	54	95	60	M		
1.9 Di-D (85 kW)	2000.09-2006.06			F	Hatchback Engine F9Q2	GC039084	Outer Joint	43T	26	33	54	95	60	M		
	2000.09-2006.06			F	Saloon Engine F9Q2	GC039084	Outer Joint	43T	26	33	54	95	60	M		
<b>CHALLENGER (K90)</b>																
2.5 TD (85 kW)	2000.02-2007.06			F	Closed Off-Road Vehicle Engine 4D56T	GC039018	Outer Joint		28	25	56	154	62	M		
	2000.02-2007.06		L	F	Closed Off-Road Vehicle Engine 4D56T	GCI99083	Inner Joint		28	26	34.7	90.5	90.6			
	2000.02-2007.06		R	F	Closed Off-Road Vehicle Engine 4D56T	GDS39006	Drive Shaft		28		56	154	538			
	2000.02-2007.06				Closed Off-Road Vehicle Engine 4D56T	GCI39037	Inner Joint		28	33	34.7	90.5	81.5			
2.5 TD (98 kW)	2003.08-		R	F	Closed Off-Road Vehicle Engine 4D56T	GDS39006	Drive Shaft		28		56	154	538			
	2003.08-		L	F	Closed Off-Road Vehicle Engine 4D56T	GCI99083	Inner Joint		28	26	34.7	90.5	90.6			
	2003.08-				Closed Off-Road Vehicle Engine 4D56T	GCI39037	Inner Joint		28	33	34.7	90.5	81.5			
3.0 V6 (125 kW)	2001.10-2005.03			Closed Off-Road Vehicle Engine 6G72(SOHC24V)	GCI39037	Inner Joint		28	33	34.7	90.5	81.5				
<b>CHAMP</b>																
-	1980-1983					GC039030	Outer Joint		25	22	50	97	57	M		
<b>CHARADE (CU2W)</b>																
2.0	2001.03-	4AT/I			Engine 4G63	GC039143	Outer Joint	43T	25	33	57	95	60.5	I		
<b>CHARADE (CU4W)</b>																
2.4	2001.03-	4AT/I			Engine 4G64	GC039143	Outer Joint	43T	25	33	57	95	60.5	I		
<b>CHARADE (CU5W)</b>																
2.4	2004.01-	4AT/I			Engine 4G69	GC039143	Outer Joint	43T	25	33	57	95	60.5	I		
<b>CHARIOT (D02W)</b>																
1.6	1983.01-1986.08	MT			Engine G32B	GC089001	Outer Joint		25	22	50	96	57	M		
<b>CHARIOT (D03W)</b>																
1.8	1983.01-1984.05	MT/AT			Engine G62B	GC089001	Outer Joint		25	22	50	96	57	M		
<b>CHARIOT (D05W)</b>																
1.8	1984.01-1991.03	MT/AT			Engine G37B	GC089001	Outer Joint		25	22	50	96	57	M		
<b>CHARIOT (NIMBUS) / GRANDIS</b>																
1.8	1986-1991	MT/AT			D09W 4D65	GC039032	Outer Joint		25	23	50	95	60.5	M		
<b>COLT</b>																
1.2	1978-1981					GC039030	Outer Joint		25	22	50	97	57	M		
1.4	1978-1981					GC039030	Outer Joint		25	22	50	97	57	M		
<b>COLT (A15_A)</b>																
1.2 GL (40 kW)	1978.12-1984.01			F	Hatchback Engine 4G11	GC024003	Outer Joint		25	22	50	95	58	I		
	1978.12-1984.01	MT/AT		F	Hatchback Engine 4G11	GC089004	Outer Joint		25	22	50	95	58	M		
1.4 GLX,GT (51 kW)	1979.05-1984.01			F	Hatchback Engine 4G12	GC024003	Outer Joint		25	22	50	95	58	I		
	1979.05-1984.01	MT/AT		F	Hatchback Engine 4G12	GC089004	Outer Joint		25	22	50	95	58	M		
1.4 Turbo (77 kW)	1981.09-1984.01	MT/AT		F	Hatchback Engine 4G12T	GC039054	Outer Joint		25	23	50	96	59	M		
<b>COLT (RG)</b>																
1.5 Turbo (110 kW)	2006.05-2009.07				Convertible Engine 4G15T	GC039103	Outer Joint		25	23	54	98	59	M		
<b>COLT (Z23A)</b>																
1.5	2004.09-	MT/CVT			Engine 4A91	GC039221	Outer Joint		25	29	55	97	57	I		
	2005.10-2006.10	MT/CVT			Engine 4A91	GC039236	Outer Joint		25	30	52.5	96.5	58	M		
<b>COLT (Z24A)</b>																
1.5 4WD	2004.08-	MT/CVT			Engine 4A91	GC039236	Outer Joint		25	30	52.5	96.5	58	M		
<b>COLT (Z25A)</b>																
1.3	2002.10-	CVT			Engine 4G19	GC039221	Outer Joint		25	29	55	97	57	I		
<b>COLT (Z26A)</b>																
1.3 4WD	2002.11-	CVT			Engine 4G19	GC039177	Outer Joint		25	21	55	97	57	M		
<b>COLT (Z27A)</b>																
1.5	2002.10-	CVT			Engine 4G15	GC039221	Outer Joint		25	29	55	97	57	I		
<b>COLT (Z28A)</b>																
1.5	2002.11-	CVT			Engine 4G15	GC039177	Outer Joint		25	21	55	97	57	M		



		TRANSM	L/R	F/R		G-AP Ref.	PRODUCT	ABS	Technical Specifications											
									YEAR	A	B	C	H	L	P					
<b>MITSUBISHI</b>																				
<b>COLT II (C1_A)</b>																				
1.2 EL, GL (40 kW)	1984.02-	1986.09	MT/AT		F	Hatchback Engine 4G16	GC089004	Outer Joint		25	22	50	95	58	M					
1.2 EL, GL (44 kW)	1986.09-	1988.04	MT/AT		F	Hatchback Engine 4G16	GC089004	Outer Joint		25	22	50	95	58	M					
1.5 GLX (51 kW)	1985.09-	1988.04	MT/AT		F	Hatchback Engine G15B	GC089004	Outer Joint		25	22	50	95	58	M					
	1985.09-	1988.04	MT/AT		F	Hatchback Engine G15B	GC039054	Outer Joint		25	23	50	96	59	M					
1.5 GLX (55 kW)	1984.09-	1988.04	MT/AT		F	Hatchback Engine 4G15	GC089004	Outer Joint		25	22	50	95	58	M					
	1984.09-	1988.04	MT/AT		F	Hatchback Engine 4G15	GC039054	Outer Joint		25	23	50	96	59	M					
1.6 Turbo ECi (77 kW)	1986.07-	1988.04	MT/AT		F	Hatchback Engine G32BT	GC089004	Outer Joint		25	22	50	95	58	M					
1.6 Turbo ECi (92 kW)	1984.02-	1988.04	MT/AT		F	Hatchback Engine 4G32T/C	GC039054	Outer Joint		25	23	50	96	59	M					
1.8 GL Diesel (43 kW)	1984.02-	1986.09	MT/AT		F	Hatchback Engine 4D65	GC039054	Outer Joint		25	23	50	96	59	M					
1.8 GL Diesel (44 kW)	1986.09-	1988.04	MT/AT		F	Hatchback Engine 4D65	GC039054	Outer Joint		25	23	50	96	59	M					
<b>COLT III (C5_A)</b>																				
1.3 (51 kW)	1988.04-	1992.05			F	Hatchback Engine 4G13	GC024003	Outer Joint		25	22	50	95	58	I					
	1988.04-	1992.05	MT/AT		F	Hatchback Engine 4G13	GC089004	Outer Joint		25	22	50	95	58	M					
1.3 12V (55 kW)	1988.04-	1992.05			F	Hatchback Engine 4G13	GC024003	Outer Joint		25	22	50	95	58	I					
	1988.04-	1992.05	MT/AT		F	Hatchback Engine 4G13	GC089004	Outer Joint		25	22	50	95	58	M					
1.3 GL (44 kW)	1988.04-	1990.12			F	Hatchback Engine 4G13	GC024003	Outer Joint		25	22	50	95	58	I					
	1988.04-	1990.12	MT/AT		F	Hatchback Engine 4G13	GC089004	Outer Joint		25	22	50	95	58	M					
1.5 (66 kW)	1990.07-	1992.05			F	Hatchback Engine 4G15	GC024003	Outer Joint		25	22	50	95	58	I					
	1990.07-	1992.05	MT/AT		F	Hatchback Engine 4G15	GC089004	Outer Joint		25	22	50	95	58	M					
1.5 GLXi (62 kW)	1988.04-	1992.05			F	Hatchback Engine 4G15	GC024003	Outer Joint		25	22	50	95	58	I					
	1988.04-	1992.05	MT/AT		F	Hatchback Engine 4G15	GC089004	Outer Joint		25	22	50	95	58	M					
1.6 GTi 16V (91 kW)	1988.04-	1990.05	MT		F	Hatchback Engine 4G61	GC039014	Outer Joint		25	30	50	95	60.5	M					
1.8 Diesel GLX (44 kW)	1988.04-	1992.05	MT/AT		F	Hatchback Engine 4D65	GC039014	Outer Joint		25	30	50	95	60.5	M					
<b>COLT IV</b>																				
1.3	1992.04-	1996.03	MT		F		GC039085	Outer Joint		25	22	54	96	60	M					
<b>COLT IV (CA_A)</b>																				
1.3 GLi 12V (55 kW)	1992.04-	1996.04			F	Hatchback Engine 4G13	GC015003	Outer Joint		25	22	54	95	59.8	I					
	1992.04-	1996.04	MT/AT		F	Hatchback Engine 4G13	GC039011	Outer Joint		25	22	54	96	59	M					
	1992.04-	1996.04			F	Hatchback Engine 4G13	GC039023	Outer Joint		25	22	54	95	60	I					
1.6 GLXi 16V (83 kW)	1992.04-	1996.04	MT		F	Hatchback Engine 4G92	GC015003	Outer Joint		25	22	54	95	59.8	I					
<b>COLT V (CJ_, CP_)</b>																				
1.3 (60 kW)	2000.09-	2003.09			F	Hatchback Engine 4G13(16V)	GC039008	Outer Joint	43T	25	29	54	95	58	I					
1.5 (69 kW)	1995.11-	2003.09			F	Hatchback Engine 4G15(16V)	GC039119	Outer Joint	43T	25	21	54	95	51	I					
	1995.11-	2003.09			F	Hatchback Engine 4G15(16V)	GC039120	Outer Joint	43T	25	22	54	94	61	I					
	1995.11-	2003.09			F	Hatchback Engine 4G15(16V)	GC039121	Outer Joint		25	21	54	95	51	I					
1.6 (76 kW)	2000.09-	2003.09	MT/AT		F	Hatchback Engine 4G92	GC039004	Outer Joint	43T	25	30	54	95	60	I					
	2000.09-	2003.09				Hatchback Engine 4G92	GCI39057	Inner Joint		25	30	41	62.5	95						
<b>COLT VI (CZ)</b>																				
1.1 12V (55 kW)	2004.10-						GC017048	Outer Joint		25	21	54	98	59	I					
1.3 16V (70 kW)	2004.06-						GC017048	Outer Joint		25	21	54	98	59	I					
1.5 16V Cabrio (80 kW)	2004.06-						GC017048	Outer Joint		25	21	54	98	59	I					
1.5 CZT (110 kW)	2005.03-						GC017048	Outer Joint		25	21	54	98	59	I					
1.5 Di-D (50 kW)	2004.08-						GC039146	Outer Joint		25	23	53	97	61	M					
1.5 Di-D (70 kW)	2004.08-						GC039146	Outer Joint		25	23	53	97	61	M					
<b>COLT VI (Z3_A, Z2_A)</b>																				
1.1 (55 kW)	2004.10-	2012.06	MT	L	F	Hatchback Engine 3A91	GDS85058	Drive Shaft		25	33	54	98	624						
1.3 (68 kW)	2004.10-	2012.06	MT	L	F	Hatchback Engine 4A90	GDS85058	Drive Shaft		25	33	54	98	624						
1.3 (70 kW)	2004.06-	2012.06	MT	L	F	Hatchback Engine 4A90	GDS85058	Drive Shaft		25	33	54	98	624						
1.5 (80 kW)	2004.06-	2012.06				Hatchback Engine 4A91	GC039103	Outer Joint		25	23	54	98	59	M					
1.5 CZT (110 kW)	2005.03-	2012.06				Hatchback Engine 4G15T	GC039103	Outer Joint		25	23	54	98	59	M					
1.5 Di-D (50 kW)	2004.08-	2012.06			F	Hatchback Engine OM639.939	GC039146	Outer Joint		25	23	53	97	61	M					
	2004.08-	2012.06				Hatchback Engine OM639.939	GC039103	Outer Joint		25	23	54	98	59	M					
1.5 Di-D (70 kW)	2004.08-	2012.06			F	Hatchback Engine OM639.939	GC039146	Outer Joint		25	23	53	97	61	M					
	2004.08-	2012.06				Hatchback Engine OM639.939	GC039103	Outer Joint		25	23	54	98	59	M					
<b>COLT VII (Z30)</b>																				
1.1 12V (55 kW)	2009-						GC017048	Outer Joint		25	21	54	98	59	I					
1.3 (70 kW)	2009-						GC017048	Outer Joint		25	21	54	98	59	I					
1.5 (80 kW)	2008-						GC017048	Outer Joint		25	21	54	98	59	I					
<b>CORDIA</b>																				
-	1983-						GC039030	Outer Joint		25	22	50	97	57	M					
<b>CORDIA (A212)</b>																				
1.6	1982.01-	1988.01	MT/AT			Engine G32B	GC089001	Outer Joint		25	22	50	96	57	M					

		TRANSM	L/R	F/R		G-AP Ref.	PRODUCT	ABS	Technical Specifications									
									YEAR	A	B	C	H	L	P			
<b>MITSUBISHI</b>																		
<b>CORDIA (A213)</b>																		
1.8	1984.01-	1987.01	MT/AT		Engine G62B TBO	GC089001	Outer Joint		25	22	50	96	57	M				
<b>CORDIA (A21_A, AB)</b>																		
1.6 GSL (55 kW)	1982.10-	1986.12			F Coupe Engine 4G32	GC024003	Outer Joint		25	22	50	95	58	I				
	1982.10-	1986.12	MT/AT		F Coupe Engine 4G32	GC089004	Outer Joint		25	22	50	95	58	M				
1.6 Turbo (84 kW)	1982.10-	1985.05	MT/AT		F Coupe Engine 4G32T	GC039054	Outer Joint		25	23	50	96	59	M				
1.6 Turbo (85 kW)	1983.07-	1985.05	MT/AT		F Coupe Engine 4G32T	GC039054	Outer Joint		25	23	50	96	59	M				
1.8 GSL (66 kW)	1986.10-	1986.12	MT/AT		F Coupe Engine 4G37	GC039054	Outer Joint		25	23	50	96	59	M				
	1986.10-	1986.12			F Coupe Engine 4G37	GC039034	Outer Joint		25	25	50	94.5	65	M				
1.8 Turbo ECi (100 kW)	1984.10-	1986.12	MT/AT		F Coupe Engine 4G62T	GC039054	Outer Joint		25	23	50	96	59	M				
<b>CORDIA (SE SX)</b>																		
1.8	1982.01-	1984.01	MT/AT		Engine G62B	GC089001	Outer Joint		25	22	50	96	57	M				
<b>DEBONAIR (S11A)</b>																		
2.0	1986.08-	1991.04	AT		Engine 6G71	GC039026	Outer Joint		25	26	50	95	64.5	M				
<b>DEBONAIR (S12A)</b>																		
3.0	1986.07-	1992.07	AT		Engine 6G72	GC039026	Outer Joint		25	26	50	95	64.5	M				
<b>DEBONAIR (S22A)</b>																		
3.0	1992.08-	1995.08	AT		Engine 6G72	GC039012	Outer Joint		27	26	60	97	68.5	M				
<b>DEBONAIR (S27A)</b>																		
3.5	1992.08-	1995.08	AT		Engine 6G74	GC039012	Outer Joint		27	26	60	97	68.5	M				
<b>DIAMANTE</b>																		
-	1992-					GCI24042	Inner Joint		25	26	35	62.8	100					
<b>DIAMANTE (F13A)</b>																		
2.5	1991.10-	1995.01	MT&AT		Engine 6G73	GC039012	Outer Joint		27	26	60	97	68.5	M				
<b>DIAMANTE (F15A)</b>																		
2.5 4WS	1990.05-	1993.11	AT		Engine 6G73	GC039012	Outer Joint		27	26	60	97	68.5	M				
<b>DIAMANTE (F25A)</b>																		
2.5 4WD	1990.05-	1995.01	AT		Engine 6G73	GC039025	Outer Joint		27	25	60	97	68.5	M				
<b>DIAMANTE (F27A)</b>																		
3.0 4WD	1990.05-	1995.01	AT		Engine 6G72	GC039025	Outer Joint		27	25	60	97	68.5	M				
<b>ECLIPSE</b>																		
-	1996-					GC039046	Outer Joint		25	25	54	95.5	63.5	I				
2.4	1996-	1999				GC039041	Outer Joint		25	25	54	95.5	65	M				
	1996-	1999				GC039078	Outer Joint	43T	25	25	54	95.5	63.5	I				
<b>ECLIPSE (D22A)</b>																		
2.0	1989.09-	1995.06	MT/AT		Engine 4G63	GC039214	Outer Joint		25	23	54	96	59	M				
<b>ECLIPSE (D2_A)</b>																		
2.0 i 16V (110 kW)	1991.04-	1995.11			F Coupe Engine 4G63	GC039034	Outer Joint		25	25	50	94.5	65	M				
	1991.04-	1995.11	MT/AT		F Coupe Engine 4G63	GC039002	Outer Joint		25	23	54	96	60	M				
2.0 i 16V 4WD (110 kW)	1991.04-	1995.11	MT/AT		F Coupe Engine 4G63	GC039002	Outer Joint		25	23	54	96	60	M				
<b>ECLIPSE II (D3_A)</b>																		
2.0 GS 16V (107 kW)	1995.12-	1999.04			F Coupe Engine 4G63	GC039035	Outer Joint		25	23	54	95.5	61	M				
2.0 GT 16V (157 kW)	1995.12-	1999.04			F Coupe	GC039097	Outer Joint		25	25	54	96	64.5	I				
	1995.12-	1999.04			F Coupe	GC039035	Outer Joint		25	23	54	95.5	61	M				
2.4 GS 16V (105 kW)	1998.09-	1999.04			F Coupe Engine 4G61	GC039035	Outer Joint		25	23	54	95.5	61	M				
<b>EMERAUDE / GALANT / ETERNA (E52A)</b>																		
1.8	1992.05-	1996.10	MT/AT		Engine 4G91	GC039214	Outer Joint		25	23	54	96	59	M				
<b>EMERAUDE / GALANT / ETERNA (E53A)</b>																		
1.8	1992.05-	1996.10	MT/AT		Engine 6A11	GC039214	Outer Joint		25	23	54	96	59	M				
<b>EMERAUDE / GALANT / ETERNA (E54A)</b>																		
2.0	1992.05-	1996.10	MT/AT		Engine 6A12	GC039214	Outer Joint		25	23	54	96	59	M				
<b>EMERAUDE / GALANT / ETERNA (E57A)</b>																		
2.0	1992.05-	1996.10	MT/AT		Engine 4D68	GC039079	Outer Joint		25	24	54	96	59	M				
<b>EMERAUDE / GALANT / ETERNA (E64A)</b>																		
2.0	1992.05-	1996.10	MT/AT		Engine 6A12 4WS	GC039214	Outer Joint		25	23	54	96	59	M				
<b>EMERAUDE / GALANT / ETERNA (E72A)</b>																		
1.8 4WD	1992.05-	1996.10	MT/AT		Engine 4G93	GC039064	Outer Joint	43T	25	30	54	95	60.5	M				
<b>EMERAUDE / GALANT / ETERNA (E74A)</b>																		
2.0 4WD	1993.02-	1996.10	MT		Engine 6A12	GC039064	Outer Joint	43T	25	30	54	95	60.5	M				
<b>EMERAUDE / GALANT / ETERNA (E77A)</b>																		
2.0 4WD	1992.05-	1996.10	MT/AT		Engine 4D68	GC039064	Outer Joint	43T	25	30	54	95	60.5	M				









		YEAR	TRANSM	L/R	F/R		G-AP Ref.	PRODUCT	ABS	Technical Specifications								
										A	B	C	H	L	P			
<b>MITSUBISHI</b>																		
<b>EMERAUDE / GALANT / ETERNA (E84A)</b>																		
2.0 4WD	1992.05-	1996.10	MT			Engine 6A12	GC039064	Outer Joint	43T		25	30	54	95	60.5			M
<b>ETERNA</b>																		
2.0			MT/AT				GCI39003	Inner Joint			25	23	35	62.8	95.5			
	1992-		MT			E55A	GCI39010	Inner Joint			25	24	35	62.8	92.5			
	1996-		MT				GCI39028	Inner Joint			25	23	41	62.5	90.5			
<b>EXCEL</b>																		
-							GCI39001	Inner Joint			25	22	35	55	91			
	1986-	1993					GC039030	Outer Joint			25	22	50	97	57			M
<b>EXPO</b>																		
2.4	1992-	1996					GC039041	Outer Joint			25	25	54	95.5	65			M
<b>EXPO LRV</b>																		
2.4	1992-	1996					GC039041	Outer Joint			25	25	54	95.5	65			M
<b>GALAN FORTIS (CY4A)</b>																		
2.0	2007.08-		CVT&5MT			Engine 4B11	GC039178	Outer Joint			28	33	59.6	94.5	61.5			I
2.0 4WD	2007.08-		CVT			Engine 4B11	GC039178	Outer Joint			28	33	59.6	94.5	61.5			I
<b>GALANT</b>																		
-	2004-			L			GDS39119	Drive Shaft	43T		25	25	54	95.5	946			
	2004-			L/R			GC039058	Outer Joint			25	33	54	95.5	65			I
	2004-			L/R			GCI39027	Inner Joint			25	30	41	63	88			
	2004-			R			GDS39118	Drive Shaft	43T		25	25	54	95.5	642			
2.0	1992-		MT			E55A	GCI39010	Inner Joint			25	24	35	62.8	92.5			
	1996-		MT				GCI39028	Inner Joint			25	23	41	62.5	90.5			
	1997-						GCI39013	Inner Joint			25	23	41	62.5	87.5			
2.4 SOHC	1994-	1996					GC039046	Outer Joint			25	25	54	95.5	63.5			I
2.4/2.5	1994-	1998					GC039041	Outer Joint			25	25	54	95.5	65			M
	1994-	1998					GC039078	Outer Joint	43T		25	25	54	95.5	63.5			I
<b>GALANT / ETERNA</b>																		
1.6	1984-	1987	MT/AT				GCI39002	Inner Joint			25	23	35	62.8	95.5			
1.8	1984-	1987	MT/AT				GCI39002	Inner Joint			25	23	35	62.8	95.5			
<b>GALANT / ETERNA (E11A)</b>																		
1.6	1984.02-	1987.09	MT			Engine G32B	GC089001	Outer Joint			25	22	50	96	57			M
<b>GALANT / ETERNA (E12A)</b>																		
1.8	1983.08-	1989.04	MT/AT			Engine G37B	GC089001	Outer Joint			25	22	50	96	57			M
	1986.01-	1989.04	4AT			Engine G37B	GC089001	Outer Joint			25	22	50	96	57			M
<b>GALANT / ETERNA (E17A)</b>																		
2.0	1986.10-	1990.12	MT/AT			Engine 6G71	GC039026	Outer Joint			25	26	50	95	64.5			M
<b>GALANT / ETERNA (E18A)</b>																		
3.0	1989.05-	1990.11	AT			Engine 6G72	GC039026	Outer Joint			25	26	50	95	64.5			M
<b>GALANT / ETERNA (E31A)</b>																		
1.6	1987.08-	1992.09	MT/AT			Engine 4G32	GC089001	Outer Joint			25	22	50	96	57			M
<b>GALANT / ETERNA (E32A)</b>																		
1.8	1987.08-	1992.09	MT/AT			Engine 4G37 ECI	GC039214	Outer Joint			25	23	54	96	59			M
<b>GALANT / ETERNA (E33A)</b>																		
2.0	1987.08-	1992.09	MT/AT			Engine 4G63	GC039214	Outer Joint			25	23	54	96	59			M
<b>GALANT / ETERNA (E34A)</b>																		
1.8	1988.02-	1992.09	MT			Engine 4D65 TBO	GC039214	Outer Joint			25	23	54	96	59			M
<b>GALANT / ETERNA (E35A)</b>																		
1.8	1989.04-	1992.09	MT/AT			Engine 4G67	GC039214	Outer Joint			25	23	54	96	59			M
<b>GALANT III (E1_A)</b>																		
1.6 GLX (55 kW)	1984.06-	1990.04			F	Saloon Engine 4G32	GC024003	Outer Joint			25	22	50	95	58			I
	1984.06-	1990.04	MT/AT		F	Saloon Engine 4G32	GC089004	Outer Joint			25	22	50	95	58			M
1.8 Turbo-D (60 kW)	1984.06-	1990.04	MT/AT		F	Saloon Engine 4D65T	GC039054	Outer Joint			25	23	50	96	59			M
2.0 GLS (66 kW)	1986.06-	1990.04	MT/AT		F	Saloon Engine G63B	GC089002	Outer Joint			25	23	50	94.5	63.5			M
2.0 GLS (75 kW)	1984.06-	1990.04	MT/AT		F	Saloon Engine 4G63(SOHC8V)	GC089002	Outer Joint			25	23	50	94.5	63.5			M
2.0 Turbo ECI (110 kW)	1984.06-	1990.04	MT/AT		F	Saloon Engine 4G63T(SOHC8V)	GC039054	Outer Joint			25	23	50	96	59			M
	1984.06-	1990.04			F	Saloon Engine 4G63T(SOHC8V)	GC039034	Outer Joint			25	25	50	94.5	65			M
	1984.06-	1990.04	MT/AT		F	Saloon Engine 4G63T(SOHC8V)	GC089003	Outer Joint			25	25	50	95	64.5			M
2.4 GLS (82 kW)	1985.07-	1990.04	MT/AT		F	Saloon Engine G64B	GC039054	Outer Joint			25	23	50	96	59			M
	1985.07-	1990.04			F	Saloon Engine G64B	GC039034	Outer Joint			25	25	50	94.5	65			M
<b>GALANT IV</b>																		
1.8	1988.03-	1993.02	MT/AT		F	E32A	GC039085	Outer Joint			25	22	54	96	60			M



	 YEAR	TRANSM	L/R	F/R		G-AP Ref.	PRODUCT	ABS	Technical Specifications								
									A	B	C	H	L	P			
<b>MITSUBISHI GALANT IV (E3_A)</b>																	
1.8 (63 kW)	1987.11-1990.08			F	Saloon Engine 4G37	GC015003	Outer Joint		25	22	54	95	59.8	I			
	1987.11-1990.08	MT/AT		F	Saloon Engine 4G37	GC039011	Outer Joint		25	22	54	96	59	M			
	1987.11-1990.08			F	Saloon Engine 4G37	GC039035	Outer Joint		25	23	54	95.5	61	M			
1.8 (66 kW)	1987.11-1992.10			F	Saloon Engine 4G37	GC015003	Outer Joint		25	22	54	95	59.8	I			
	1987.11-1992.10	MT/AT		F	Saloon Engine 4G37	GC039011	Outer Joint		25	22	54	96	59	M			
	1987.11-1992.10			F	Saloon Engine 4G37	GC039035	Outer Joint		25	23	54	95.5	61	M			
	1987.11-1992.10	MT/AT		F	Saloon Engine 4G37	GC039002	Outer Joint		25	23	54	96	60	M			
	1988.11-1992.10			F	Hatchback Engine 4G37	GC015003	Outer Joint		25	22	54	95	59.8	I			
	1988.11-1992.10	MT/AT		F	Hatchback Engine 4G37	GC039011	Outer Joint		25	22	54	96	59	M			
	1988.11-1992.10			F	Hatchback Engine 4G37	GC039035	Outer Joint		25	23	54	95.5	61	M			
	1988.11-1992.10	MT/AT		F	Hatchback Engine 4G37	GC039002	Outer Joint		25	23	54	96	60	M			
1.8 Turbo-D (55 kW)	1987.12-1992.10			F	Saloon Engine 4D65T	GC039035	Outer Joint		25	23	54	95.5	61	M			
	1987.12-1992.10	MT/AT		F	Saloon Engine 4D65T	GC039002	Outer Joint		25	23	54	96	60	M			
	1988.11-1992.10			F	Hatchback Engine 4D65T	GC039035	Outer Joint		25	23	54	95.5	61	M			
	1988.11-1992.10	MT/AT		F	Hatchback Engine 4D65T	GC039002	Outer Joint		25	23	54	96	60	M			
2.0 (80 kW)	1987.11-1992.10			F	Saloon Engine 4G63(SOHC8V)	GC039035	Outer Joint		25	23	54	95.5	61	M			
	1987.11-1992.10	MT		F	Saloon Engine 4G63(SOHC8V)	GC039002	Outer Joint		25	23	54	96	60	M			
	1987.11-1992.10	MT		F	Saloon Engine 4G63(SOHC8V)	GC039036	Outer Joint		25	23	54	96	64.5	M			
	1989.04-1992.10			F	Hatchback Engine 4G63(SOHC8V)	GC039035	Outer Joint		25	23	54	95.5	61	M			
	1989.04-1992.10	MT		F	Hatchback Engine 4G63(SOHC8V)	GC039002	Outer Joint		25	23	54	96	60	M			
	1989.04-1992.10	MT		F	Hatchback Engine 4G63(SOHC8V)	GC039036	Outer Joint		25	23	54	96	64.5	M			
	1989.04-1992.10	MT		F	Hatchback Engine 4G63(SOHC8V)	GC039009	Outer Joint		25	30	54	95	60.5	M			
2.0 4WD (80 kW)	1988.12-1992.10			F	Saloon Engine 4G63(SOHC8V)	GC039035	Outer Joint		25	23	54	95.5	61	M			
	1988.12-1992.10	MT		F	Saloon Engine 4G63(SOHC8V)	GC039002	Outer Joint		25	23	54	96	60	M			
	1988.12-1992.10	MT		F	Saloon Engine 4G63(SOHC8V)	GC039009	Outer Joint		25	30	54	95	60.5	M			
	1988.12-1992.10			F	Saloon Engine 4G63(SOHC8V)	GC039010	Outer Joint		25	30	54	96	60	M			
	1989.04-1992.10			F	Hatchback Engine 4G63(SOHC8V)	GC039035	Outer Joint		25	23	54	95.5	61	M			
	1989.04-1992.10	MT		F	Hatchback Engine 4G63(SOHC8V)	GC039002	Outer Joint		25	23	54	96	60	M			
	1989.04-1992.10	MT		F	Hatchback Engine 4G63(SOHC8V)	GC039009	Outer Joint		25	30	54	95	60.5	M			
	1989.04-1992.10	MT		F	Hatchback Engine 4G63(SOHC8V)	GC039010	Outer Joint		25	30	54	96	60	M			
	1989.04-1992.10			F	Hatchback Engine 4G63(SOHC8V)	GC039036	Outer Joint		25	30	54	96	64.5	M			
2.0 GTi 16V (106 kW)	1987.11-1992.10	MT/AT		F	Saloon Engine 4G63	GC039036	Outer Joint		25	23	54	96	64.5	M			
	1987.11-1992.10	MT/AT		F	Saloon Engine 4G63	GC039002	Outer Joint		25	23	54	96	60	M			
	1988.11-1992.10	MT/AT		F	Hatchback Engine 4G63	GC039036	Outer Joint		25	23	54	96	64.5	M			
	1988.11-1992.10	MT/AT		F	Hatchback Engine 4G63	GC039002	Outer Joint		25	23	54	96	60	M			
2.0 GTi 16V (107 kW)	1988.11-1992.10	MT/AT		F	Hatchback Engine 4G63	GC039036	Outer Joint		25	23	54	96	64.5	M			
	1988.11-1992.10	MT/AT		F	Saloon Engine 4G63	GC039036	Outer Joint		25	23	54	96	64.5	M			
	1988.11-1992.10	MT/AT		F	Hatchback Engine 4G63	GC039002	Outer Joint		25	23	54	96	60	M			
	1988.11-1992.10	MT/AT		F	Saloon Engine 4G63	GC039002	Outer Joint		25	23	54	96	60	M			
2.0 GTi 16V 4WD (106 kW)	1988.06-1992.10			F	Saloon Engine 4G63	GC039035	Outer Joint		25	23	54	95.5	61	M			
	1988.06-1992.10	MT/AT		F	Saloon Engine 4G63	GC039036	Outer Joint		25	23	54	96	64.5	M			
	1988.06-1992.10	MT/AT		F	Saloon Engine 4G63	GC039002	Outer Joint		25	23	54	96	60	M			
	1988.06-1992.10			F	Saloon Engine 4G63	GC039010	Outer Joint		25	30	54	96	60	M			
2.0 GTi 16V 4WD CAT(110 kW)	1991.09-1992.10			F	Saloon Engine 4G63	GC039035	Outer Joint		25	23	54	95.5	61	M			
	1991.09-1992.10	MT/AT		F	Saloon Engine 4G63	GC039036	Outer Joint		25	23	54	96	64.5	M			
	1991.09-1992.10	MT/AT		F	Saloon Engine 4G63	GC039002	Outer Joint		25	23	54	96	60	M			
	1991.09-1992.10			F	Saloon Engine 4G63	GC039010	Outer Joint		25	30	54	96	60	M			
2.0 GTi 16V 4x4 (106 kW)	1989.07-1992.12			F	Hatchback Engine 4G63	GC039035	Outer Joint		25	23	54	95.5	61	M			
	1989.07-1992.12	MT/AT		F	Hatchback Engine 4G63	GC039036	Outer Joint		25	23	54	96	64.5	M			
	1989.07-1992.12	MT/AT		F	Hatchback Engine 4G63	GC039002	Outer Joint		25	23	54	96	60	M			
	1989.07-1992.12			F	Hatchback Engine 4G63	GC039010	Outer Joint		25	30	54	96	60	M			
<b>GALANT V (E5_A, E7_A, E8_A)</b>																	
1.8 (85 kW)	1994.02-1996.08			F	Hatchback Engine 4G93	GC039035	Outer Joint		25	23	54	95.5	61	M			
	1994.02-1996.08			F	Saloon Engine 4G93	GC039035	Outer Joint		25	23	54	95.5	61	M			
	1994.02-1996.08	MT/AT		F	Hatchback Engine 4G93	GC039002	Outer Joint		25	23	54	96	60	M			
	1994.02-1996.08	MT/AT		F	Saloon Engine 4G93	GC039002	Outer Joint		25	23	54	96	60	M			
1.8 GLSi (93 kW)	1992.11-1996.08	MT/AT		F	Hatchback Engine 4G93(GDI)	GC039002	Outer Joint		25	23	54	96	60	M			
	1992.11-1996.08	MT/AT		F	Saloon Engine 4G93(GDI)	GC039002	Outer Joint		25	23	54	96	60	M			
2.0 GLS TD (66 kW)	1992.11-1996.08			F	Hatchback Engine 4D68T	GC039035	Outer Joint		25	23	54	95.5	61	M			
2.0 GLSi (101 kW)	1992.11-1996.08			F	Hatchback Engine 4G63(SOHC8V)	GC039089	Outer Joint		25	24	54	95.5	61	M			
	1992.11-1996.08			F	Saloon Engine 4G63(SOHC8V)	GC039089	Outer Joint		25	24	54	95.5	61	M			
2.0 GLSi 4WD (101 kW)	1992.11-1996.08			F	Hatchback Engine 4G63(SOHC8V)	GC039035	Outer Joint		25	23	54	95.5	61	M			
	1992.11-1996.08			F	Saloon Engine 4G63(SOHC8V)	GC039035	Outer Joint		25	23	54	95.5	61	M			

		YEAR	TRANSM	L/R	F/R		G-AP Ref.	PRODUCT	ABS	Technical Specifications												
										A	B	C	H	L	P							
<b>MITSUBISHI</b>																						
<b>GALANT V (E5_A, E7_A, E8_A)</b>																						
2.0 V6-24 (110 kW)	1992.11-	1996.08			F	Hatchback Engine 6A12	GC039035	Outer Joint		25	23	54	95.5	61	M							
	1992.11-	1996.08			F	Saloon Engine 6A12	GC039035	Outer Joint		25	23	54	95.5	61	M							
	1992.11-	1996.08	MT/AT		F	Hatchback Engine 6A12	GC039016	Outer Joint		25	23	54	95.5	63.5	I							
	1992.11-	1996.08	MT/AT		F	Saloon Engine 6A12	GC039016	Outer Joint		25	23	54	95.5	63.5	I							
	1992.11-	1996.08	MT/AT		F	Hatchback Engine 6A12	GC039002	Outer Joint		25	23	54	96	60	M							
	1992.11-	1996.08	MT/AT		F	Saloon Engine 6A12	GC039002	Outer Joint		25	23	54	96	60	M							
<b>GALANT V (E5_A, E7_A, E8_A)</b>																						
2.0 GLSi 4WD (101 kW)	1992.11-	1996	MT/AT			E55A / E75A	GC039020	Outer Joint	43T	25	24	54	94.5	62	M							
<b>GALANT VI (EA_)</b>																						
2.0 (98 kW)	2000.09-	2003.10	5MT		F	Estate Engine 4G63(SOHC16V)	GC039005	Outer Joint	43T	25	33	54	95.5	65	I							
	2000.09-	2003.10		L	F	Estate Engine 4G63(SOHC16V)	GC039170	Outer Joint	43T	25	33	54	95	65	I							
	2000.09-	2003.10				Estate Engine 4G63(SOHC16V)	GCI39057	Inner Joint		25	30	41	62.5	95								
	2000.09-	2004.10	5MT		F	Saloon Engine 4G63(SOHC16V)	GC039005	Outer Joint	43T	25	33	54	95.5	65	I							
	2000.09-	2004.10		L	F	Saloon Engine 4G63(SOHC16V)	GC039170	Outer Joint	43T	25	33	54	95	65	I							
	2000.09-	2004.10				Saloon Engine 4G63(SOHC16V)	GCI39057	Inner Joint		25	30	41	62.5	95								
2.0 GDi (107 kW)	1999.10-	2004.10				Saloon Engine 4G94	GCI39057	Inner Joint		25	30	41	62.5	95								
2.4 GDi (106 kW)	2000.09-	2003.10	MT/AT		F	Estate Engine 4G64	GC039005	Outer Joint	43T	25	33	54	95.5	65	I							
	2000.09-	2004.10	MT/AT		F	Saloon Engine 4G64	GC039005	Outer Joint	43T	25	33	54	95.5	65	I							
2.4 GDi (110 kW)	1999.02-	2003.10			F	Estate Engine 4G64	GC039005	Outer Joint	43T	25	33	54	95.5	65	I							
2.5 V6 24V (118 kW)	2000.09-	2003.10	MT/AT		F	Estate Engine 6A13	GC039005	Outer Joint	43T	25	33	54	95.5	65	I							
	2000.09-	2004.10			F	Saloon Engine 6A13	GC039005	Outer Joint	43T	25	33	54	95.5	65	I							
<b>GRANDIS (NA4W)</b>																						
2.4	2003-		AT/MT			Engine 4G69	GC039161	Outer Joint		28	26	60	89	63	M							
<b>GRANDIS (NA_W)</b>																						
2.0 Di-D (100 kW)	2005.09-	2007.09				MPV Engine BSY	GC051028	Outer Joint		28	37	60	89.5	66.5	I							
2.0 Di-D (103 kW)	2007.02-					MPV Engine BWC	GC051028	Outer Joint		28	37	60	89.5	66.5	I							
2.4 (121 kW)	2004.04-	2007.09			F	MPV Engine 4G69	GC039134	Outer Joint		28	26	60	89	63	M							
	2004.04-	2007.09			F	MPV Engine 4G69	GC039135	Outer Joint		28	33	60	89	63	M							
<b>L 200 (K7_T, K6_T)</b>																						
2.4 4WD (97 kW)	1996.06-	2007.12		L	F	Pickup Engine 4G64(SOHC16V)	GDS39007	Drive Shaft		28	25	56	154	616								
	1996.06-	2007.12		L	F	Pickup Engine 4G64(SOHC16V)	GDS99232	Drive Shaft		28	25	56	154	610								
	1996.06-	2007.12		R	F	Pickup Engine 4G64(SOHC16V)	GDS39006	Drive Shaft		28		56	154	538								
	1996.06-	2007.12		R	F	Pickup Engine 4G64(SOHC16V)	GDS39034	Drive Shaft		28		56	155.5	528								
2.5 TD 4WD (73 kW)	1996.06-	2007.12	5MT	L	F	Pickup Engine 4D56TD	GDS39007	Drive Shaft		28	25	56	154	616								
	1996.06-	2007.12		L	F	Pickup Engine 4D56TD	GDS99232	Drive Shaft		28	25	56	154	610								
	1996.06-	2007.12	5MT	R	F	Pickup Engine 4D56TD	GDS39006	Drive Shaft		28		56	154	538								
	1996.06-	2007.12		R	F	Pickup Engine 4D56TD	GDS39034	Drive Shaft		28		56	155.5	528								
2.5 TD 4WD (85 kW)	1996.06-	2007.12				Pickup Engine 4D56TD	GCI39037	Inner Joint		28	33	34.7	90.5	81.5								
	2001.09-	2007.12	MT	L	F	Pickup Engine 4D56T	GDS99232	Drive Shaft		28	25	56	154	610								
	2001.09-	2007.12	MT	R	F	Pickup Engine 4D56T	GDS39034	Drive Shaft		28		56	155.5	528								
2.5 TD 4WD (98 kW)	2001.09-	2007.12				Pickup Engine 4D56T	GCI39037	Inner Joint		28	33	34.7	90.5	81.5								
	2001.08-	2007.12	MT	L	F	Pickup Engine 4D56T	GDS99232	Drive Shaft		28	25	56	154	610								
	2001.08-	2007.12	MT	R	F	Pickup Engine 4D56T	GDS39034	Drive Shaft		28		56	155.5	528								
2001.08-	2007.12				Pickup Engine 4D56T	GCI39037	Inner Joint		28	33	34.7	90.5	81.5									
<b>L 200 (KB_T, KA_T)</b>																						
2.5 Di-D (123 kW)	2007.08-		MT/AT	L	F	Pickup Engine 4D56HP	GDS39147	Drive Shaft	47T	30	28	69	98	594.5								
	2007.08-		MT/AT	R	F	Pickup Engine 4D56HP	GDS39148	Drive Shaft	47T	30		69	98	492								
	2007.08-					Pickup Engine 4D56HP	GC039166	Outer Joint	47T	30	33	69	98	66.5	I							
2.5 Di-D (94 kW)	2010.04-		MT/AT	L	F	Pickup Engine 4D56HP	GDS39147	Drive Shaft	47T	30	28	69	98	594.5								
	2010.04-		MT/AT	R	F	Pickup Engine 4D56HP	GDS39148	Drive Shaft	47T	30		69	98	492								
	2010.04-					Pickup Engine 4D56HP	GC039166	Outer Joint	47T	30	33	69	98	66.5	I							
2.5 Di-D 4WD (100 kW)	2005.11-			L	F	Pickup Engine 4D56HP	GDS39163	Drive Shaft	47T	30	28	69	98	594								
	2005.11-			R	F	Pickup Engine 4D56HP	GDS39164	Drive Shaft	47T	30		69	98	492								
	2005.11-		MT/AT	L	F	Pickup Engine 4D56HP	GDS39147	Drive Shaft	47T	30	28	69	98	594.5								
	2005.11-		MT/AT	R	F	Pickup Engine 4D56HP	GDS39148	Drive Shaft	47T	30		69	98	492								
	2005.11-					Pickup Engine 4D56HP	GCI39036	Inner Joint			33		62.5									
	2005.11-					Pickup Engine 4D56HP	GC039166	Outer Joint	47T	30	33	69	98	66.5	I							
2.5 Di-D 4WD (123 kW)	2007.10-			L	F	Pickup Engine 4D56HP	GDS39163	Drive Shaft	47T	30	28	69	98	594								
	2007.10-			R	F	Pickup Engine 4D56HP	GDS39164	Drive Shaft	47T	30		69	98	492								
	2007.10-		MT/AT	L	F	Pickup Engine 4D56HP	GDS39147	Drive Shaft	47T	30	28	69	98	594.5								
	2007.10-		MT/AT	R	F	Pickup Engine 4D56HP	GDS39148	Drive Shaft	47T	30		69	98	492								
	2007.10-			R	F	Pickup Engine 4D56HP	GCI39036	Inner Joint			33		62.5									









	 YEAR	TRANSM	L/R	F/R		G-AP Ref.	PRODUCT	ABS	Technical Specifications								
									A	B	C	H	L	P			
<b>MITSUBISHI</b>																	
<b>L 200 (KB_T, KA_T)</b>																	
2.5 Di-D 4WD (123 kW)	2007.10-				Pickup Engine 4D56HP	GC039166	Outer Joint	47T	30	33	69	98	66.5	I			
2.5 Di-D 4WD (131 kW)	2010.04-		MT/AT	L F	Pickup Engine 4D56HP	GDS39147	Drive Shaft	47T	30	28	69	98	594.5				
	2010.04-		MT/AT	R F	Pickup Engine 4D56HP	GDS39148	Drive Shaft	47T	30		69	98	492				
	2010.04-			R F	Pickup Engine 4D56HP	GCI39036	Inner Joint			33		62.5					
	2010.04-				Pickup Engine 4D56HP	GC039166	Outer Joint	47T	30	33	69	98	66.5	I			
<b>L 400 (PD_W, PC_W, PB_V, PA_W, PA_V)</b>																	
2.5 TD 4WD (64 kW)	1996.09-2005.06			L F	Box Engine 4D56T	GCI99083	Inner Joint		28	26	34.7	90.5	90.6				
<b>L 400 / SPACE GEAR (PD_W, PC_W, PA_V, PB_V, PA_W)</b>																	
2.4 4WD (94 kW)	1996.09-2005.06			L F	Bus Engine 4G64(SOHC 16V)	GCI99083	Inner Joint		28	26	34.7	90.5	90.6				
<b>L200/TRITON</b>																	
-				L		GDS39163	Drive Shaft	47T	30	28	69	98	594				
				R		GDS39164	Drive Shaft	47T	30		69	98	492				
	2008.06-			L		GDS39105	Drive Shaft		30	28	69	98	594				
	2008.06-			R		GDS39104	Drive Shaft		30		69	98	492				
<b>LANCER</b>																	
-	1983-1986					GC039030	Outer Joint		25	22	50	97	57	M			
	2001-					GC039048	Outer Joint		25	23	57	94.5	60	I			
	2002-2003					GC039082	Outer Joint		25	29	57	94.5	60	I			
	2007-				CY2A	GC015011	Outer Joint		28	30	59.5	95	57.5	I			
	2007-				CY3A/CY4A	GC039113	Outer Joint		28	33	59.5	95	61.5	I			
1.3	1987-1991		MT/AT		C61 4G13	GCI39025	Inner Joint		25	22	35	54.7	90.8				
	1992-					GCI39009	Inner Joint		25	22	35	54.7	90.8				
1.5	1987-1991		MT/AT		C62 4G15	GCI39025	Inner Joint		25	22	35	54.7	90.8				
1.6			MT		GLXI CB4A	GC039039	Outer Joint		25	23	54	96	60	I			
1.8	1987-1991		MT/AT		C64 4G65	GCI39025	Inner Joint		25	22	35	54.7	90.8				
2.0	2004-2011		MT/AT			GCI39074	Inner Joint		25	30	41	63	97				
<b>LANCER (A17_)</b>																	
1.4 GLX (50 kW)	1979.09-1983.02		MT/AT		R Saloon Engine 4G12	GC089004	Outer Joint		25	22	50	95	58	M			
1.6 (60 kW)	1979.09-1983.02		MT		R Saloon Engine 4G32GS	GC039054	Outer Joint		25	23	50	96	59	M			
1.6 (62 kW)	1981.01-1983.02		MT		R Saloon Engine 4G32GS	GC039054	Outer Joint		25	23	50	96	59	M			
<b>LANCER (CK1A, CK2A)</b>																	
1.3	1995-1997					GCI39029	Inner Joint		25	22	41	62.5	90.5				
1.5	1995-1997					GCI39029	Inner Joint		25	22	41	62.5	90.5				
<b>LANCER (CS_A)</b>																	
1.3 (60 kW)	2003.09-				Saloon Engine 4G13(16V)	GCI39057	Inner Joint		25	30	41	62.5	95				
1.6 (72 kW)	2004.12-2008.01		MT	L F	Saloon Engine 4G18	GDS39228	Drive Shaft	43T	25	25	57	94.5	616				
	2004.12-2008.01				Saloon Engine 4G18	GCI39057	Inner Joint		25	30	41	62.5	95				
	2004.12-2008.01				Saloon Engine 4G18	GC039200	Outer Joint	43T	25	30	57	94.5	60	I			
2.0 (99 kW)	2004.12-2008.01		MT	L F	Saloon Engine 4G63(DOHC16V)	GDS39217	Drive Shaft	43T	25	25	54	95	667				
	2004.12-2008.01				Saloon Engine 4G63(DOHC16V)	GCI39057	Inner Joint		25	30	41	62.5	95				
	2004.12-2008.01				Saloon Engine 4G63(DOHC16V)	GC039203	Outer Joint	43T	25	30	54	95	60	I			
2.0 16V EVO VIII (195 kW)	2004.04-2008.01		MT	L F	Saloon Engine 4G63	GDS39216	Drive Shaft	43T	27	26	60	97	559				
	2004.04-2008.01				Saloon Engine 4G63	GC039168	Outer Joint	43T	27	32	60	97	60	I			
2.0 4WD (213 kW)	2005.08-				Saloon Engine 4G63	GCI39057	Inner Joint		25	30	41	62.5	95				
<b>LANCER (CS_W)</b>																	
1.6 (72 kW)	2003.09-2008.10		MT	L F	Estate Engine 4G18	GDS39228	Drive Shaft	43T	25	25	57	94.5	616				
	2003.09-2008.10				Estate Engine 4G18	GCI39057	Inner Joint		25	30	41	62.5	95				
	2003.09-2008.10				Estate Engine 4G18	GC039200	Outer Joint	43T	25	30	57	94.5	60	I			
2.0 (99 kW)	2003.09-2007.12		MT	L F	Estate Engine 4G63(DOHC16V)	GDS39217	Drive Shaft	43T	25	25	54	95	667				
	2003.09-2007.12				Estate Engine 4G63(DOHC16V)	GCI39057	Inner Joint		25	30	41	62.5	95				
	2003.09-2007.12				Estate Engine 4G63(DOHC16V)	GC039203	Outer Joint	43T	25	30	54	95	60	I			
<b>LANCER (CY/Z_A)</b>																	
2.0 Di-D (103 kW)	2008.01-			L F	Saloon Engine BKD/BWC	GCI51034	Inner Joint		27	35	40	62	113				
2.0 EVO (221 kW)	2008.06-			L F	Saloon Engine 4B11T/C	GCI51034	Inner Joint		27	35	40	62	113				
2.0 EVO (242 kW)	2008.06-			L F	Saloon Engine 4B11FQ30	GCI51034	Inner Joint		27	35	40	62	113				
2.0 EVO (264 kW)	2008.06-			L F	Saloon Engine 4B11FQ60	GCI51034	Inner Joint		27	35	40	62	113				
<b>LANCER / COLT</b>																	
1.3	1992-				4G15,CA2A,CA1A	GCI15005	Inner Joint		25	22	35	54.7	90.8				
<b>LANCER CEDIA (CS1A)</b>																	
1.3	2000.03-2002.12		MT/AT		Engine 4G13	GC039059	Outer Joint		25	29	57	95	58	M			



		TRANSM	L/R	F/R		G-AP Ref.	PRODUCT	ABS	Technical Specifications							
									YEAR	A	B	C	H	L	P	
<b>MITSUBISHI</b>																
<b>LANCER CEDIA (CS5A)</b>																
1.8	2000.05-		CVT		Engine 4G93	GC039114	Outer Joint	43T	25	23	57	95	60.5	M		
1.8 4WD	2000.07-		CVT		Engine 4G93	GC039142	Outer Joint	43T	25	30	57	95	60.5	M		
<b>LANCER CEDIA WAGON (CS2W)</b>																
1.5	2001.05-		CVT		Engine 4G15	GC039141	Outer Joint	43T	25	22	57	95	60.5	M		
<b>LANCER CEDIA WAGON (CS5W)</b>																
1.8	2000.11-		CVT		Engine 4G93	GC039114	Outer Joint	43T	25	23	57	95	60.5	M		
	2001.05-		4AT		Engine 4G93 TBO	GC039176	Outer Joint	43T	25	29	57	95	58	M		
1.8 4WD	2000.11-		CVT		Engine 4G93	GC039142	Outer Joint	43T	25	30	57	95	60.5	M		
<b>LANCER EVOLUTION (CZ4A)</b>																
2.0	2007.08-	2007.08	5MT		Engine 4B11TBO	GC039211	Outer Joint		28	33	60	89	60	I		
	2007.08-	2007.08	6MT		Engine 4B11TBO	GC039211	Outer Joint		28	33	60	89	60	I		
<b>LANCER F II (A17_)</b>																
1.2 GLX (40 kW)	1983.03-	1984.01			F Saloon Engine 4G11	GC024003	Outer Joint		25	22	50	95	58	I		
	1983.03-	1984.01	MT/AT		F Saloon Engine 4G11	GC089004	Outer Joint		25	22	50	95	58	M		
1.4 GLX (51 kW)	1983.03-	1984.01			F Saloon Engine 4G12	GC024003	Outer Joint		25	22	50	95	58	I		
	1983.03-	1984.01	MT/AT		F Saloon Engine 4G12	GC089004	Outer Joint		25	22	50	95	58	M		
1.4 Turbo (77 kW)	1983.03-	1984.01	MT/AT		F Saloon Engine 4G12T	GC039054	Outer Joint		25	23	50	96	59	M		
<b>LANCER III (C1_A, C6_A)</b>																
1.2 (44 kW)	1986.08-	1988.04	MT/AT		F Saloon Engine 4G16	GC089004	Outer Joint		25	22	50	95	58	M		
1.2 GL (40 kW)	1984.01-	1986.10	MT/AT		F Saloon Engine 4G16	GC089004	Outer Joint		25	22	50	95	58	M		
1.5 GLX (51 kW)	1985.06-	1988.04	MT/AT		F Saloon Engine G15B	GC089004	Outer Joint		25	22	50	95	58	M		
1.5 GLX (55 kW)	1983.11-	1988.04	MT/AT		F Saloon Engine 4G15	GC089004	Outer Joint		25	22	50	95	58	M		
1.8 Diesel (43 kW)	1984.01-	1986.09	MT/AT		F Saloon Engine 4D65	GC039054	Outer Joint		25	23	50	96	59	M		
1.8 Diesel (44 kW)	1986.09-	1988.04	MT/AT		F Saloon Engine 4D65	GC039054	Outer Joint		25	23	50	96	59	M		
<b>LANCER III (C1_V, C3_V)</b>																
1.5 (51 kW)	1985.09-	1989.08	MT/AT		F Estate Engine G15B	GC089004	Outer Joint		25	22	50	95	58	M		
1.5 (55 kW)	1985.09-	1987.12	MT/AT		F Estate Engine 4G15	GC089004	Outer Joint		25	22	50	95	58	M		
1.5 (61 kW)	1988.09-	1990.12	MT/AT		F Estate Engine 4G15	GC089004	Outer Joint		25	22	50	95	58	M		
1.5 12V (66 kW)	1990.09-	1991.12	MT/AT		F Estate Engine 4G15	GC089004	Outer Joint		25	22	50	95	58	M		
1.8 4WD (61 kW)	1987.01-	1989.08	MT/AT		F Estate Engine G37B	GC039054	Outer Joint		25	23	50	96	59	M		
	1987.01-	1989.08			F Estate Engine G37B	GC024003	Outer Joint		25	22	50	95	58	I		
1.8 4WD (63 kW)	1989.03-	1990.12	MT/AT		F Estate Engine 4G37	GC039054	Outer Joint		25	23	50	96	59	M		
	1989.03-	1990.12			F Estate Engine 4G37	GC024003	Outer Joint		25	22	50	95	58	I		
1.8 4WD (66 kW)	1987.01-	1987.12			F Estate Engine 4G37	GC024003	Outer Joint		25	22	50	95	58	I		
	1987.01-	1987.12	MT/AT		F Estate Engine 4G37	GC089004	Outer Joint		25	22	50	95	58	M		
1.8 4WD (69 kW)	1990.08-	1992.06			F Estate Engine 4G37	GC024003	Outer Joint		25	22	50	95	58	I		
	1990.08-	1992.06	MT/AT		F Estate Engine 4G37	GC089004	Outer Joint		25	22	50	95	58	M		
1.8 D (43 kW)	1985.09-	1986.09	MT/AT		F Estate Engine 4D65	GC039054	Outer Joint		25	23	50	96	59	M		
1.8 D (44 kW)	1986.08-	1992.06	MT/AT		F Estate Engine 4D65	GC039054	Outer Joint		25	23	50	96	59	M		
<b>LANCER IV (C6_A)</b>																
1.3 (44 kW)	1988.04-	1992.05			F Saloon Engine 4G13	GC024003	Outer Joint		25	22	50	95	58	I		
	1988.04-	1992.05	MT/AT		F Saloon Engine 4G13	GC089004	Outer Joint		25	22	50	95	58	M		
1.3 (51 kW)	1988.08-	1992.05			F Saloon Engine G13B	GC024003	Outer Joint		25	22	50	95	58	I		
	1988.08-	1992.05	MT/AT		F Saloon Engine G13B	GC089004	Outer Joint		25	22	50	95	58	M		
1.3 12V (55 kW)	1990.07-	1992.06			F Saloon Engine 4G13	GC024003	Outer Joint		25	22	50	95	58	I		
	1990.07-	1992.06	MT/AT		F Saloon Engine 4G13	GC089004	Outer Joint		25	22	50	95	58	M		
1.5 (62 kW)	1988.04-	1992.05			F Saloon Engine 4G15	GC024003	Outer Joint		25	22	50	95	58	I		
	1988.04-	1992.05	MT/AT		F Saloon Engine 4G15	GC089004	Outer Joint		25	22	50	95	58	M		
1.5 12V (66 kW)	1989.05-	1992.05			F Saloon Engine 4G15	GC024003	Outer Joint		25	22	50	95	58	I		
	1989.05-	1992.05	MT/AT		F Saloon Engine 4G15	GC089004	Outer Joint		25	22	50	95	58	M		
1.8 GLX Diesel (44 kW)	1988.04-	1992.05	MT/AT		F Saloon Engine 4D65	GC039014	Outer Joint		25	30	50	95	60.5	M		
<b>LANCER IV (C6_A, C7_A)</b>																
1.3 12V (55 kW)	1992.06-	1994.05			F Hatchback Engine 4G13	GC024003	Outer Joint		25	22	50	95	58	I		
	1992.06-	1994.05	MT/AT		F Hatchback Engine 4G13	GC089004	Outer Joint		25	22	50	95	58	M		
1.5 (62 kW)	1988.06-	1992.05			F Hatchback Engine 4G15	GC024003	Outer Joint		25	22	50	95	58	I		
1.5 12V (66 kW)	1989.05-	1992.05			F Hatchback Engine 4G15	GC024003	Outer Joint		25	22	50	95	58	I		
	1989.05-	1992.05	MT/AT		F Hatchback Engine 4G15	GC089004	Outer Joint		25	22	50	95	58	M		
1.8 4WD (71 kW)	1989.09-	1992.06			F Hatchback Engine 4G37	GC024003	Outer Joint		25	22	50	95	58	I		
	1989.09-	1992.06	MT/AT		F Hatchback Engine 4G37	GC089004	Outer Joint		25	22	50	95	58	M		
1.8 D (44 kW)	1988.04-	1992.05	MT/AT		F Hatchback Engine 4D65	GC039014	Outer Joint		25	30	50	95	60.5	M		

		YEAR	TRANSM	L/R	F/R		G-AP Ref.	PRODUCT	ABS	Technical Specifications										
										A	B	C	H	L	P					
<b>MITSUBISHI</b>																				
<b>LANCER SEDAN</b>																				
1.6	2003-2007			L	F		GDS39024	Drive Shaft			25	25	54	95	621					
	2003-2007			R	F		GDS39023	Drive Shaft			25	25	54	95	938.5					
<b>LANCER V (CB/D_A)</b>																				
1.3 (55 kW)	1992.06-1996.12				F	Saloon Engine 4G13(12V)	GC015003	Outer Joint			25	22	54	95	59.8	I				
	1992.06-1996.12	MT/AT			F	Saloon Engine 4G13(12V)	GC039011	Outer Joint			25	22	54	96	59	M				
	1992.06-1996.12				F	Saloon Engine 4G13(12V)	GC039023	Outer Joint			25	22	54	95	60	I				
<b>LANCER V STATION WAGON (CB_W, CD_W)</b>																				
1.6 16V (83 kW)	1992.12-2003.10				F	Estate Engine 4G92	GC024009	Outer Joint			25	30	50	95	56.5	M				
1.6 16V 4WD (83 kW)	1992.12-2003.10					Estate Engine 4G92	GC024009	Outer Joint			25	30	50	95	56.5	M				
2.0 D (50 kW)	1992.12-2003.10				F	Estate Engine 4D68	GC039007	Outer Joint	43T		25	23	54	95	60	I				
	1992.12-2003.10	MT/AT			F	Estate Engine 4D68	GC039019	Outer Joint			25	24	54	94.5	62	M				
<b>LANCER VI (CJ-CP_)</b>																				
1.3 12V (55 kW)	1995.12-2003.08				F	Saloon Engine 4G13	GC039008	Outer Joint	43T		25	29	54	95	58	I				
1.6 16V (66 kW)	1995.12-2003.08					Saloon Engine 4G92	GCI39057	Inner Joint			25	30	41	62.5	95					
<b>LEGNUM (EA5W)</b>																				
2.5	1996.08-	MT/AT				Engine 6A13	GC039150	Outer Joint	43T		25	24	54	96	59	M				
<b>LIBERO / LIBERO CARGO (CB8V W)</b>																				
2.0	1992.06-1995.08	AT				Engine 4D68 TBO/4D68	GC039214	Outer Joint			25	23	54	96	59	M				
	1992.06-1995.08	MT				Engine 4D68 TBO	GC039214	Outer Joint			25	23	54	96	59	M				
<b>MAGNA</b>																				
2.6	1991.01-1992.12	AT		F		TR ELITE	GC039110	Outer Joint			27	26	60	97	69	I				
<b>MIRAGE</b>																				
-	1978-1983						GC039030	Outer Joint			25	22	50	97	57	M				
	1985-1992						GC039030	Outer Joint			25	22	50	97	57	M				
1.3	1987-1991	MT/AT				C61 4G13	GCI39025	Inner Joint			25	22	35	54.7	90.8					
1.5	1987-1991	MT/AT				C62 4G15	GCI39025	Inner Joint			25	22	35	54.7	90.8					
1.8	1987-1991	MT/AT				C64 4G65	GCI39025	Inner Joint			25	22	35	54.7	90.8					
<b>MIRAGE / LANCER</b>																				
-	1994-						GCI39023	Inner Joint			25	23	41	62.5	87.5					
1.3	1992.01-	MT/AT					GC089001	Outer Joint			25	22	50	96	57	M				
1.5	1988-1991	MT				C63A 4G61	GCI39002	Inner Joint			25	23	35	62.8	95.5					
	1988-1991	MT					GCI39005	Inner Joint			25	30	35	62.8	92.5					
1.6	1988-1991	MT				C63A 4G61	GCI39002	Inner Joint			25	23	35	62.8	95.5					
	1988-1991	MT					GCI39005	Inner Joint			25	30	35	62.8	92.5					
<b>MIRAGE / LANCER (A153)</b>																				
1.6	1978.01-1983.01	MT/AT				Engine G32B	GC089001	Outer Joint			25	22	50	96	57	M				
<b>MIRAGE / LANCER (C11A)</b>																				
1.3	1983.01-1985.01	MT				Engine G13B	GC089001	Outer Joint			25	22	50	96	57	M				
	1983.10-1985.12	AT				Engine G13B	GC089001	Outer Joint			25	22	50	96	57	M				
	1986.01-1988.01	MT/AT				Engine G13B	GC089001	Outer Joint			25	22	50	96	57	M				
<b>MIRAGE / LANCER (C12A)</b>																				
1.5	1983.01-1988.06	MT/AT				Engine G15B	GC089001	Outer Joint			25	22	50	96	57	M				
<b>MIRAGE / LANCER (C14A)</b>																				
1.8	1983.10-1988.06	MT				Engine 4D65	GC089001	Outer Joint			25	22	50	96	57	M				
<b>MIRAGE / LANCER (C18A)</b>																				
1.5	1986.04-1988.06	MT/AT				Engine G31B	GC089001	Outer Joint			25	22	50	96	57	M				
<b>MIRAGE / LANCER (C51A)</b>																				
1.3	1987.10-1991.08	MT/AT				Engine 4G13	GC089001	Outer Joint			25	22	50	96	57	M				
<b>MIRAGE / LANCER (C52A)</b>																				
1.5	1987.10-1991.08	MT/AT				Engine 4G15	GC089001	Outer Joint			25	22	50	96	57	M				
<b>MIRAGE / LANCER (C61A)</b>																				
1.3	1988.01-1991.08	MT/AT				Engine 4G13	GC089001	Outer Joint			25	22	50	96	57	M				
<b>MIRAGE / LANCER (C62A)</b>																				
1.5	1987.01-1991.08	MT/AT				Engine 4G15	GC089001	Outer Joint			25	22	50	96	57	M				
<b>MIRAGE / LANCER (C64A)</b>																				
1.8	1988.05-1991.12	MT/AT				Engine 4D65	GC089001	Outer Joint			25	22	50	96	57	M				
<b>MIRAGE / LANCER (C72A)</b>																				
1.5 4WD	1988.01-1991.08	MT/AT				Engine 4G15	GC089001	Outer Joint			25	22	50	96	57	M				
<b>MIRAGE / LANCER (C74A)</b>																				
1.8 4WD	1988.05-1991.12	MT				Engine 4D65	GC089001	Outer Joint			25	22	50	96	57	M				









		TRANSM	L/R	F/R		G-AP Ref.	PRODUCT	ABS	Technical Specifications									
									YEAR	A	B	C	H	L	P			
<b>MITSUBISHI</b>																		
<b>MIRAGE / LANCER (C82A)</b>																		
1.5 4WD	1989.09-	1991.08	MT&AT		Engine 4G15	GC089001	Outer Joint		25	22	50	96	57	M				
<b>MIRAGE / LANCER (CA4A)</b>																		
1.6	1991.08-	1994.08	MT/AT		Engine 4G92	GC039064	Outer Joint	43T	25	30	54	95	60.5	M				
<b>MIRAGE / LANCER (CB4A)</b>																		
1.6	1992.10-	1994.10	MT/AT		Engine 4G92	GC039064	Outer Joint	43T	25	30	54	95	60.5	M				
<b>MIRAGE / LANCER (CB7A)</b>																		
1.8	1991.10-	1992.10	AT		Engine 4D65	GC039214	Outer Joint		25	23	54	96	59	M				
<b>MIRAGE / LANCER (CB8A)</b>																		
2.0	1992.10-	1995.08	AT		Engine 4D68	GC039214	Outer Joint		25	23	54	96	59	M				
<b>MIRAGE / LANCER (CC3A)</b>																		
1.5 4WD	1991.08-	1995.08	MT/AT		Engine 4G91	GC039064	Outer Joint	43T	25	30	54	95	60.5	M				
<b>MIRAGE / LANCER (CC4A)</b>																		
1.6 4WD	1991.08-	1995.08	MT/AT		Engine 4G92	GC039064	Outer Joint	43T	25	30	54	95	60.5	M				
<b>MIRAGE / LANCER (CD3A)</b>																		
1.5 4WD	1991.08-	1995.08	MT/AT		Engine 4G91	GC039064	Outer Joint	43T	25	30	54	95	60.5	M				
<b>MIRAGE / LANCER (CD5A)</b>																		
1.8 4WD	1991.10-	1995.08	MT/AT		Engine 4G93	GC039064	Outer Joint	43T	25	30	54	95	60.5	M				
<b>MIRAGE / LANCER (CD7A)</b>																		
1.8 4WD	1991.10-	1992.10	MT/AT		Engine 4D65	GC039064	Outer Joint	43T	25	30	54	95	60.5	M				
<b>MIRAGE / LANCER (CB8A)</b>																		
2.0 4WD	1992.10-	1995.08	MT/AT		Engine 4D68	GC039064	Outer Joint	43T	25	30	54	95	60.5	M				
<b>MIRAGE / LANCER (CD9A)</b>																		
2.0 4WD	1992.10-	1993.12	MT/AT		Engine 4G63	GC039064	Outer Joint	43T	25	30	54	95	60.5	M				
<b>MIRAGE / LANCER (CJ1A)</b>																		
1.3	1995.10-	2000.08	MT/AT		Engine 4G13	GC039149	Outer Joint		25	22	54	96	59	M				
<b>MIRAGE / LANCER (CJ2A)</b>																		
1.5	1995.10-	2000.08	MT/AT		Engine 4G15	GC039149	Outer Joint		25	22	54	96	59	M				
<b>MIRAGE / LANCER (CK1A)</b>																		
1.3	1995.10-	2000.07	MT/AT		Engine 4G13	GC039149	Outer Joint		25	22	54	96	59	M				
<b>MIRAGE / LANCER (CK2A)</b>																		
1.5	1995.10-	2000.07	MT/AT		Engine 4G15	GC039149	Outer Joint		25	22	54	96	59	M				
<b>MIRAGE / LANCER / COLT</b>																		
1.6	1987-	1991	MT/AT		C53,C63 4G61	GC039047	Outer Joint		25	30	50	95.5	60.5	M				
<b>MIRAGE / LANCER V (CB/DA)</b>																		
2.0 D (CB8A) (50 kW)	1992.11-		MT/AT			GC039020	Outer Joint	43T	25	24	54	94.5	62	M				
<b>MIRAGE / LANCER V (CB/DA) SW</b>																		
2.0 D (CB8W) (50 kW)	1992.06-		MT/AT			GC039020	Outer Joint	43T	25	24	54	94.5	62	M				
<b>MIRAGE / LANCER VAN / WAGON (C11V)</b>																		
1.3	1985.01-	1992.03	MT/AT		Engine G13B	GC089001	Outer Joint		25	22	50	96	57	M				
<b>MIRAGE / LANCER VAN / WAGON (C12V W)</b>																		
1.5	1985.01-	1992.03	MT/AT		Engine G15B	GC089001	Outer Joint		25	22	50	96	57	M				
<b>MIRAGE / LANCER VAN / WAGON (C14V W)</b>																		
1.8	1983.01-	1988.05	MT/AT		Engine 4D65	GC089001	Outer Joint		25	22	50	96	57	M				
<b>MIRAGE LANCER</b>																		
1.3	1995.10-	2000	MT/AT		Engine 4G13	GC039233	Outer Joint		25	21	54	96	51.2	M				
1.5	1995.10-	2000	MT/AT		Engine 4G15	GC039233	Outer Joint		25	21	54	96	51.2	M				
<b>MONTERO</b>																		
-	1983-	1991				GCI39044	Inner Joint		25		62.5							
<b>OUTLANDER</b>																		
-	2006-					GC039117	Outer Joint		28	35	59.5	95	65	I				
<b>OUTLANDER I (CU_W)</b>																		
2.0 (100 kW)	2003.05-	2006.10		F	Closed Off-Road Vehicle Engine 4G63(DOHC16V)	GC039112	Outer Joint	43T	25	29	57	94.5	57	I				
2.0 4WD (100 kW)	2003.05-	2006.10			Closed Off-Road Vehicle Engine 4G63(DOHC16V)	GC039112	Outer Joint	43T	25	29	57	94.5	57	I				
	2003.05-	2006.10			Closed Off-Road Vehicle Engine 4G63(DOHC16V)	GCI99019	Inner Joint		26	29	41	50	90					
2.0 4WD (177 kW)	2003.05-	2006.10			Closed Off-Road Vehicle Engine 4G63 Turbo	GC039112	Outer Joint	43T	25	29	57	94.5	57	I				
	2003.05-	2006.10			Closed Off-Road Vehicle Engine 4G63 Turbo	GCI99019	Inner Joint		26	29	41	50	90					
2.0 4WD (93 kW)	2003.05-	2006.10			Closed Off-Road Vehicle Engine 4G63(DOHC16V)	GC039112	Outer Joint	43T	25	29	57	94.5	57	I				
	2003.05-	2006.10			Closed Off-Road Vehicle Engine 4G63(DOHC16V)	GCI99019	Inner Joint		26	29	41	50	90					
2.0 Turbo 4WD (148 kW)	2004.04-	2006.10			Closed Off-Road Vehicle Engine 4G63T(DOHC16V)	GC039112	Outer Joint	43T	25	29	57	94.5	57	I				
	2004.04-	2006.10			Closed Off-Road Vehicle Engine 4G63T(DOHC16V)	GCI99019	Inner Joint		26	29	41	50	90					



		YEAR	TRANSM	L/R	F/R		G-AP Ref.	PRODUCT	ABS	Technical Specifications										
										A	B	C	H	L	P					
<b>MITSUBISHI OUTLANDER I (CU_W)</b>																				
2.4 4WD (102 kW)	2003.05-	2006.10				Closed Off-Road Vehicle Engine 4G64(SOHC16V)	GC039112	Outer Joint	43T	25	29	57	94.5	57	I					
	2003.05-	2006.10				Closed Off-Road Vehicle Engine 4G64(SOHC16V)	GCI99019	Inner Joint		26	29	41	50	90						
2.4 4WD (118 kW)	2003.10-	2006.12				Closed Off-Road Vehicle Engine 4G69	GC039112	Outer Joint	43T	25	29	57	94.5	57	I					
	2003.10-	2006.12				Closed Off-Road Vehicle Engine 4G69	GCI99019	Inner Joint		26	29	41	50	90						
2.4 4WD (119 kW)	2003.05-	2006.10				Closed Off-Road Vehicle Engine 4G69	GC039112	Outer Joint	43T	25	29	57	94.5	57	I					
	2003.05-	2006.10				Closed Off-Road Vehicle Engine 4G69	GCI99019	Inner Joint		26	29	41	50	90						
<b>OUTLANDER II (CW_W)</b>																				
2.0 (108 kW)	2006.11-	2012.11		L	F	Closed Off-Road Vehicle Engine 4B11	GCI51034	Inner Joint		27	35	40	62	113						
2.0 Di-D (103 kW)	2007.02-	2012.11		L	F	Closed Off-Road Vehicle Engine BSY	GCI51034	Inner Joint		27	35	40	62	113						
	2007.02-	2012.11	MT	R	F	Closed Off-Road Vehicle Engine BSY	GDS51046	Drive Shaft		28	24	59.5	94.5	989						
2.4 4WD (125 kW)	2007.09-	2012.11		L	F	Closed Off-Road Vehicle Engine 4B12	GCI51034	Inner Joint		27	35	40	62	113						
<b>OUTLANDER II VAN (CW_W)</b>																				
2.0 Di-D (103 kW)	2006.12-	2012.11		L	F	Box Engine BSY	GCI51034	Inner Joint		27	35	40	62	113						
	2006.12-	2012.11	MT	R	F	Box Engine BSY	GDS51046	Drive Shaft		28	24	59.5	94.5	989						
<b>OUTLANDER III (GG_W, GF_W, ZJ)</b>																				
2.0 (110 kW)	2012.08-			L	F	Closed Off-Road Vehicle Engine 4J11	GCI51034	Inner Joint		27	35	40	62	113						
2.0 4WD (110 kW)	2012.08-			L	F	Closed Off-Road Vehicle Engine 4J11	GCI51034	Inner Joint		27	35	40	62	113						
2.0 Hybrid 4WD (89 kW)	2012.12-			L	F	Closed Off-Road Vehicle Engine 4B11	GCI51034	Inner Joint		27	35	40	62	113						
2.2 Di-D (110 kW)	2012.08-			L	F	Closed Off-Road Vehicle Engine 4N14	GCI51034	Inner Joint		27	35	40	62	113						
2.2 Di-D 4WD (110 kW)	2012.08-			L	F	Closed Off-Road Vehicle Engine 4N14	GCI51034	Inner Joint		27	35	40	62	113						
<b>OUTLANDER III VAN (GF_W, GG_W)</b>																				
2.2 Di-D 4WD (110 kW)	2013.04-			L	F	Box Engine 4N14	GCI51034	Inner Joint		27	35	40	62	113						
<b>PAJERO</b>																				
-	1990-	1996					GCI39045	Inner Joint		28	25	34.7	90.5	81.5						
3.0 V6	1992-	1996					GC099176	Outer Joint		28	27	56	154	62	M					
<b>PAJERO (L041)</b>																				
3.0	1982.01-	1986.01	MT/AT			Engine G63B	GC039003	Outer Joint		28	27	56	154.1	60	M					
<b>PAJERO (L043)</b>																				
2.5	1982.01-	1986.01	MT/AT			Engine 4D55	GC039003	Outer Joint		28	27	56	154.1	60	M					
<b>PAJERO (L146)</b>																				
3.0	1989.01-	1990.01	MT/AT			Engine 6G72	GC039003	Outer Joint		28	27	56	154.1	60	M					
<b>PAJERO (V63W)</b>																				
3.0 4WD	2000.08-		AT/F			Engine 6G72	GC039124	Outer Joint	50T	30	33	66	98	67	I					
<b>PAJERO (V65W)</b>																				
3.5 4WD	1999.06-		AT/F			Engine 6G74	GC039124	Outer Joint	50T	30	33	66	98	67	I					
<b>PAJERO (V65W/V75W)</b>																				
3.5	1999.09-		4MT/5MT			Engine 6G74	GC039124	Outer Joint	50T	30	33	66	98	67	I					
<b>PAJERO (V68W)</b>																				
3.2 4WD	1999.06-		AT/F			Engine 4M41	GC039124	Outer Joint	50T	30	33	66	98	67	I					
<b>PAJERO (V68W/V78W)</b>																				
3.2	1999.09-		4MT/5MT			Engine 4M41	GC039124	Outer Joint	50T	30	33	66	98	67	I					
<b>PAJERO (V73W)</b>																				
3.0 4WD	1999.06-		AT/F			Engine 6G72	GC039124	Outer Joint	50T	30	33	66	98	67	I					
<b>PAJERO (V75W)</b>																				
3.5 4WD	1999.06-		AT/F			Engine 6G74	GC039124	Outer Joint	50T	30	33	66	98	67	I					
<b>PAJERO (V78W)</b>																				
3.2 4WD	1999.06-		AT/F			Engine 4M41	GC039124	Outer Joint	50T	30	33	66	98	67	I					
<b>PAJERO / SHOGUN (L04_G, L14_G)</b>																				
2.5 TD (64 kW)	1990.01-	1991.12	MT		F	Closed Off-Road Vehicle Engine 4D56T	GC039027	Outer Joint		28	25	56	154.1	62	M					
2.5 TD (70 kW)	1989.11-	1990.11	MT		F	Closed Off-Road Vehicle Engine 4D56T	GC039027	Outer Joint		28	25	56	154.1	62	M					
3.0 V6 (104 kW)	1988.11-	1990.11	MT		F	Closed Off-Road Vehicle Engine 6G72(SOHC12V)	GC039001	Outer Joint		28	27	56	154.5	63	I					
<b>PAJERO / SHOGUN (V2_W, V4_W)</b>																				
2.5 TD 4WD (73 kW)	1990.12-	2000.04	MT		F	Open Off-Road Vehicle Engine 4D56TD	GC039027	Outer Joint		28	25	56	154.1	62	M					
3.0 V6 (110 kW)	1990.12-	1995.12	AT		F	Open Off-Road Vehicle Engine 6G72(SOHC12V)	GC039015	Outer Joint		27	27	60	97	68.5	M					
	1990.12-	1995.12	MT		F	Open Off-Road Vehicle Engine 6G72(SOHC12V)	GC039027	Outer Joint		28	25	56	154.1	62	M					
<b>PAJERO / SHOGUN CLASSIC (V2_W)</b>																				
2.5 TD (85 kW)	2002.07-		5MT		F	Closed Off-Road Vehicle Engine 4D56T	GC039018	Outer Joint		28	25	56	154	62	M					
<b>PAJERO / SHOGUN II (L04_G)</b>																				
2.3 TD (62 kW)	1982.12-	1986.04	MT		F	Open Off-Road Vehicle Engine 4D55T	GC039001	Outer Joint		28	27	56	154.5	63	I					
2.5 TD (62 kW)	1986.05-	1989.10	MT		F	Open Off-Road Vehicle Engine 4D56T	GC039027	Outer Joint		28	25	56	154.1	62	M					
2.5 TD (70 kW)	1989.11-	1990.11	MT		F	Open Off-Road Vehicle Engine 4D56T	GC039027	Outer Joint		28	25	56	154.1	62	M					

		YEAR	TRANSM	L/R	F/R		G-AP Ref.	PRODUCT	ABS	Technical Specifications										
										A	B	C	H	L	P					
<b>MITSUBISHI</b>																				
<b>PAJERO / SHOGUN II (L04_G)</b>																				
2.6 (76 kW)	1983.01-	1990.11	MT			F	Open Off-Road Vehicle Engine 4G54	GC039001	Outer Joint		28	27	56	154.5	63					
<b>PAJERO / SHOGUN II (V3_W, V2_W, V4_W)</b>																				
2.5 TD 4WD (73 kW)	1990.12-	1999.10	MT			F	Closed Off-Road Vehicle Engine 4D56T	GC039027	Outer Joint		28	25	56	154.1	62					M
3.0 V6 24V (133 kW)	1994.06-	1997.05					Closed Off-Road Vehicle Engine 6G72(SOHC24V)	GC039093	Outer Joint		28	26	56	155	64					M
3.0 V6 4WD (110 kW)	1990.12-	1995.12	AT			F	Closed Off-Road Vehicle Engine 6G72(SOHC12V)	GC039015	Outer Joint		27	27	60	97	68.5					M
	1990.12-	1995.12	MT			F	Closed Off-Road Vehicle Engine 6G72(SOHC12V)	GC039027	Outer Joint		28	25	56	154.1	62					M
<b>PAJERO / SHOGUN III (V6_W, V7_W)</b>																				
3.2 Di-D (118 kW)	2001.10-	2006.12				F	Open Off-Road Vehicle Engine 4M41	GC039006	Outer Joint	50T	30	33	66	98	67					I
	2001.10-	2006.12	AT	R		F	Open Off-Road Vehicle Engine 4M41	GDS39202	Drive Shaft	50T	30		66	98	529					
3.2 Di-D (121 kW)	2000.04-	2006.12				F	Open Off-Road Vehicle Engine 4M41	GC039028	Outer Joint	50T	30	36	66	98	69					I
	2000.04-	2006.12	AT	R		F	Open Off-Road Vehicle Engine 4M41	GDS39202	Drive Shaft	50T	30		66	98	529					
	2000.04-	2006.12					Open Off-Road Vehicle Engine 4M41	GC039157	Outer Joint		30	36	66	98	69					I
<b>PAJERO / SHOGUN III (V7_W, V6_W)</b>																				
3.2 Di-D (118 kW)	2000.04-	2006.12	AT	R		F	Closed Off-Road Vehicle Engine 4M41	GDS39202	Drive Shaft	50T	30		66	98	529					
3.2 Di-D (121 kW)	2000.04-	2001.10	AT	R		F	Closed Off-Road Vehicle Engine 4M41	GDS39202	Drive Shaft	50T	30		66	98	529					
<b>PAJERO / SHOGUN IV (V8_W, V9_W)</b>																				
3.8 V6 (182 kW)	2010.02-		AT	R		F	Closed Off-Road Vehicle Engine 6G75	GDS39261	Drive Shaft	50T	30		69.2	98.5	519					
3.8 V6 (184 kW)	2007.02-		AT	R		F	Closed Off-Road Vehicle Engine 6G75	GDS39261	Drive Shaft	50T	30		69.2	98.5	519					
<b>PAJERO III CANVAS TOP (V6_W, V7_W)</b>																				
3.5 V6 GDi (149 kW)	2000.04-	2006.12				F	Open Off-Road Vehicle Engine 6G74(DOHC24V)/6G74(SOHC24V)	GC039006	Outer Joint	50T	30	33	66	98	67					I
<b>PAJERO IV VAN (V90, V80, V8_V)</b>																				
3.2 Di-D (118 kW)	2006.11-		AT	R		F	Box Engine 4M41	GDS39261	Drive Shaft	50T	30		69.2	98.5	519					
<b>PICK UP</b>																				
-	1983-	1986					4WD	GCI39044	Inner Joint			25		62.5						
<b>PONY</b>																				
-	1985-	1988						GC039030	Outer Joint		25	22	50	97	57					M
<b>PRECIS</b>																				
-	1987-	1989						GC039030	Outer Joint		25	22	50	97	57					M
<b>S COUPE</b>																				
-	1990-	1993						GC039030	Outer Joint		25	22	50	97	57					M
<b>SAPPORO II (A16_A)</b>																				
2.4 (91 kW)	1987.06-	1990.08	MT/AT			F	Coupe Engine 4G64(8V)	GC039036	Outer Joint		25	23	54	96	64.5					M
	1987.06-	1990.08	MT/AT			F	Coupe Engine 4G64(8V)	GC039002	Outer Joint		25	23	54	96	60					M
<b>SHOGUN PININ (H6_W, H7_W)</b>																				
1.8 (84 kW)	2001.11-	2007.06	5MT				Closed Off-Road Vehicle Engine 4G93	GC039136	Outer Joint		25	29	54	95	57					I
	2001.11-	2007.06	MT/AT	L		F	Closed Off-Road Vehicle Engine 4G93	GDS39236	Drive Shaft	43T	25	25	54	94.5	551					
	2001.11-	2007.06					Closed Off-Road Vehicle Engine 4G93	GC039186	Outer Joint	43T	25	32	54	94.5	63.5					I
1.8 GDi (88 kW)	1999.10-	2007.06					Closed Off-Road Vehicle Engine 4G93	GC039136	Outer Joint		25	29	54	95	57					I
	1999.10-	2007.06	MT/AT	L		F	Closed Off-Road Vehicle Engine 4G93	GDS39236	Drive Shaft	43T	25	25	54	94.5	551					
	1999.10-	2007.06					Closed Off-Road Vehicle Engine 4G93	GC039186	Outer Joint	43T	25	32	54	94.5	63.5					I
2.0 GDi (95 kW)	2000.10-	2007.06					Closed Off-Road Vehicle Engine 4G94	GC039136	Outer Joint		25	29	54	95	57					I
	2000.10-	2007.06	MT/AT	L		F	Closed Off-Road Vehicle Engine 4G94	GDS39236	Drive Shaft	43T	25	25	54	94.5	551					
	2000.10-	2007.06					Closed Off-Road Vehicle Engine 4G94	GC039186	Outer Joint	43T	25	32	54	94.5	63.5					I
<b>SIGMA (F13A)</b>																				
2.5	1991.10-	1993.10	MT&AT				Engine 6G73	GC039012	Outer Joint		27	26	60	97	68.5					M
	1993.08-		MT/AT				Engine 6G73	GC039012	Outer Joint		27	26	60	97	68.5					M
<b>SIGMA (F15A)</b>																				
2.5 4WS	1990.02-	1993.09	AT				Engine 6G73	GC039012	Outer Joint		27	26	60	97	68.5					M
<b>SIGMA (F25A)</b>																				
2.5 4WD	1990.09-		AT				Engine 6G73	GC039025	Outer Joint		27	25	60	97	68.5					M
<b>SIGMA (F27A)</b>																				
3.0 4WD	1990.09-	1993.09	AT				Engine 6G72	GC039025	Outer Joint		27	25	60	97	68.5					M
<b>SIGMA (F2_A, F1_A)</b>																				
3.0 V6 (130 kW)	1990.12-	1996.07	AT			F	Saloon Engine 6G72	GC039015	Outer Joint		27	27	60	97	68.5					M
	1990.12-	1996.07				F	Saloon Engine 6G72	GC039042	Outer Joint		27	27	60	97	69					I
3.0 V6 (151 kW)	1990.12-	1996.07	AT			F	Saloon Engine 6G72(DOHC24V)	GC039015	Outer Joint		27	27	60	97	68.5					M
	1990.12-	1996.07				F	Saloon Engine 6G72(DOHC24V)	GC039042	Outer Joint		27	27	60	97	69					I
	1990.12-	1996.07				F	Saloon Engine 6G72(DOHC24V)	GC039045	Outer Joint		25	26	54	95	69					I
<b>SIGMA STATION WAGON (F0_W)</b>																				
3.0 (125 kW)	1992.06-	1996.10				F	Estate Engine 6G72(SOHC12V)	GC039042	Outer Joint		27	27	60	97	69					I









		YEAR	TRANSM	L/R	F/R		G-AP Ref.	PRODUCT	ABS	Technical Specifications						
										A	B	C	H	L	P	
<b>MITSUBISHI</b>																
<b>SPACE RUNNER (N1_W, N2_W)</b>																
1.8 (85 kW)	1996.06-	1999.08	MT/AT			F	MPV Engine 4G93	GC039036	Outer Joint		25	23	54	96	64.5	M
	1996.06-	1999.08	MT/AT			F	MPV Engine 4G93	GC039002	Outer Joint		25	23	54	96	60	M
1.8 (90 kW)	1991.10-	1999.08	MT/AT			F	MPV Engine 4G93	GC039036	Outer Joint		25	23	54	96	64.5	M
	1991.10-	1999.08	MT/AT			F	MPV Engine 4G93	GC039002	Outer Joint		25	23	54	96	60	M
<b>SPACE STAR (DG0)</b>																
1.6 16V (72 kW)	2001.01-							GC039060	Outer Joint		25	22	54	95	54	I
<b>SPACE STAR (DG_A)</b>																
1.3 16V (60 kW)	2000.09-	2004.12				F	MPV Engine 4G13	GC039102	Outer Joint	43T	25	22	54	95	54	I
	2000.09-	2004.12	MT	L		F	MPV Engine 4G13	GDS62056	Drive Shaft	43T	25		54	95	640	
	2000.09-	2004.12	MT	R		F	MPV Engine 4G13	GDS39139	Drive Shaft		25	23	54	95	816	
1.3 16V (61 kW)	1998.12-	2004.12				F	MPV Engine 4G13	GC039102	Outer Joint	43T	25	22	54	95	54	I
	1998.12-	2004.12	MT	R		F	MPV Engine 4G13	GDS39139	Drive Shaft		25	23	54	95	816	
1.3 16V (63 kW)	1998.06-	2004.12				F	MPV Engine 4G13	GC039102	Outer Joint	43T	25	22	54	95	54	I
	1998.06-	2004.12	MT	L		F	MPV Engine 4G13	GDS62056	Drive Shaft	43T	25		54	95	640	
	1998.06-	2004.12	MT	R		F	MPV Engine 4G13	GDS39139	Drive Shaft		25	23	54	95	816	
1.6 16V (72 kW)	2001.01-	2004.12				F	MPV Engine 4G18	GC039102	Outer Joint	43T	25	22	54	95	54	I
	2001.01-	2004.12	MT/AT			F	MPV Engine 4G18	GC039024	Outer Joint	43T	25	23	54	95.5	64	M
	2001.01-	2004.12	MT	L		F	MPV Engine 4G18	GDS62056	Drive Shaft	43T	25		54	95	640	
	2001.01-	2004.12	MT	R		F	MPV Engine 4G18	GDS39139	Drive Shaft		25	23	54	95	816	
	2001.01-	2004.12	AT				MPV Engine 4G18	GC039100	Outer Joint	43T	25	23	54	95.5	64	M
1.8 GDi (87 kW)	1998.06-	2004.12				F	MPV Engine 4G93	GC039024	Outer Joint	43T	25	23	54	95.5	64	M
1.8 GDi (90 kW)	1998.06-	2004.12				F	MPV Engine 4G93	GC039024	Outer Joint	43T	25	23	54	95.5	64	M
	1998.06-	2004.12			R	F	MPV Engine 4G93	GDS39224	Drive Shaft	43T	25	25	54	95.5	937	
1.8 MPI (82 kW)	2002.10-	2004.12				F	MPV Engine 4G93	GC039024	Outer Joint	43T	25	23	54	95.5	64	M
	2002.10-	2004.12	MT	L		F	MPV Engine 4G93	GDS62056	Drive Shaft	43T	25		54	95	640	
	2002.10-	2004.12	MT	R		F	MPV Engine 4G93	GDS39139	Drive Shaft		25	23	54	95	816	
1.9 Di-D (75 kW)	2001.02-	2004.12				F	MPV Engine F9Q1	GC039084	Outer Joint	43T	26	33	54	95	60	M
1.9 Di-D (85 kW)	2002.10-	2004.12				F	MPV Engine F9Q2	GC039084	Outer Joint	43T	26	33	54	95	60	M
<b>SPACE WAGON</b>																
-	1992-	1993						GCI39005	Inner Joint		25	30	35	62.8	92.5	
<b>SPACE WAGON (D0_V/W)</b>																
1.8 4WD (66 kW)	1987.10-	1988.08	MT			F	MPV Engine 4G37	GC039054	Outer Joint		25	23	50	96	59	M
1.8 GLX (66 kW)	1984.01-	1988.12	MT			F	MPV Engine 4G37	GC039054	Outer Joint		25	23	50	96	59	M
1.8 TD (55 kW)	1986.06-	1991.04	MT			F	MPV Engine 4D65T	GC089002	Outer Joint		25	23	50	94.5	63.5	M
2.0 4WD (75 kW)	1985.03-	1991.04					MPV Engine 4G63(SOHC8V)	GC039034	Outer Joint		25	25	50	94.5	65	M
	1985.03-	1991.04	MT			F	MPV Engine 4G63(SOHC8V)	GC089003	Outer Joint		25	25	50	95	64.5	M
2.0 GLX (62 kW)	1986.06-	1988.05	MT			F	MPV Engine G63B	GC089002	Outer Joint		25	23	50	94.5	63.5	M
2.0 GLX 4WD (62 kW)	1986.06-	1988.05	MT			F	MPV Engine G63B	GC089003	Outer Joint		25	25	50	95	64.5	M
2.0 GLXi (74 kW)	1988.06-	1991.04	MT			F	MPV Engine 4G63(SOHC8V)	GC089002	Outer Joint		25	23	50	94.5	63.5	M
2.0 GLXi 4WD (74 kW)	1988.06-	1991.04	MT				MPV Engine 4G63(SOHC8V)	GC089003	Outer Joint		25	25	50	95	64.5	M
<b>SPACE WAGON (N3_W, N4_W)</b>																
1.8 (90 kW)	1991.10-	1998.10	MT/AT			F	MPV Engine 4G93	GC039016	Outer Joint		25	23	54	95.5	63.5	I
1.8 4WD (90 kW)	1991.10-	1998.10				F	MPV Engine 4G93	GC024003	Outer Joint		25	22	50	95	58	I
2.0 (98 kW)	1992.10-	1998.10	MT/AT			F	MPV Engine 4G63(DOHC16V)	GC039016	Outer Joint		25	23	54	95.5	63.5	I
<b>SUMMIT</b>																
1.5	1989-	1992						GC039030	Outer Joint		25	22	50	97	57	M
<b>TREDIA</b>																
-	1983-							GC039030	Outer Joint		25	22	50	97	57	M
<b>TREDIA (A211)</b>																
1.4	1982.01-	1984.01	MT/AT				Engine G12B	GC089001	Outer Joint		25	22	50	96	57	M
<b>TREDIA (A212)</b>																
1.6	1982.01-	1984.01	AT				Engine G32B	GC089001	Outer Joint		25	22	50	96	57	M
	1984.01-	1988.01	MT/AT				Engine G32B	GC089001	Outer Joint		25	22	50	96	57	M
<b>TREDIA (A213)</b>																
1.8	1984.01-	1987.01	MT/AT				Engine G37B/G62B	GC089001	Outer Joint		25	22	50	96	57	M
<b>TREDIA (A215)</b>																
1.8	1982.01-	1984.01	AT				Engine G62B	GC089001	Outer Joint		25	22	50	96	57	M
	1984.01-	1987.01	MT				Engine G37B	GC089001	Outer Joint		25	22	50	96	57	M
<b>TREDIA (A21_)</b>																
1.4 GLX (51 kW)	1982.10-	1985.08				F	Saloon Engine 4G12	GC024003	Outer Joint		25	22	50	95	58	I
	1982.10-	1985.08	MT/AT			F	Saloon Engine 4G12	GC089004	Outer Joint		25	22	50	95	58	M



		TRANSM	L/R	F/R		G-AP Ref.	PRODUCT	ABS	Technical Specifications						
									YEAR	A	B	C	H	L	P
<b>MITSUBISHI</b>															
<b>TREDIA (A21_)</b>															
1.6 GLS (55 kW)	1982.09-	1987.10			F	Saloon Engine 4G32	GC024003	Outer Joint		25	22	50	95	58	I
	1982.09-	1987.10	MT/AT		F	Saloon Engine 4G32	GC089004	Outer Joint		25	22	50	95	58	M
1.6 Turbo (84 kW)	1982.09-	1985.05	MT		F	Saloon Engine 4G32T	GC089002	Outer Joint		25	23	50	94.5	63.5	M
1.6 Turbo (85 kW)	1982.09-	1984.07	MT		F	Saloon Engine 4G32T	GC089002	Outer Joint		25	23	50	94.5	63.5	M
1.8 GLS (66 kW)	1984.08-	1986.07	MT		F	Saloon Engine 4G37	GC039054	Outer Joint		25	23	50	96	59	M
	1984.08-	1986.07			F	Saloon Engine 4G37	GC039034	Outer Joint		25	25	50	94.5	65	M
	1984.08-	1986.07	MT		F	Saloon Engine 4G37	GC089003	Outer Joint		25	25	50	95	64.5	M
1.8 Turbo (100 kW)	1984.08-	1986.07			F	Saloon Engine G62B	GC039034	Outer Joint		25	25	50	94.5	65	M
<b>VISTA</b>															
-	1985-	1986					GC124003	Inner Joint		25	25	35	63.5	94	
<b>MOSKVICHI</b>															
<b>21412</b>															
1.5 (51 kW)	1989.05-	2001.12	MT		F	Hatchback	GC040001	Outer Joint		25	25	53	88	57.5	O
	1989.05-	2001.12			F	Hatchback	GC182006	Inner Joint			25		32		
<b>NISSAN</b>															
<b>100 NX (B13)</b>															
1.6 (66 kW)	1990.03-	1994.10			F	Coupe Engine GA16DS	GC099199	Outer Joint		25	23	55	107	62	M
2.0 GTi (105 kW)	1991.03-	1994.10			F	Coupe Engine SR20DE	GC041014	Outer Joint	42T	25	25	55	106.5	66	I
	1991.03-	1994.10	MT		F	Coupe Engine SR20DE	GC041087	Outer Joint		25	25	55	106.5	66	I
<b>AD VAN / WAGON (VB11)</b>															
1.3	1982.10-	1990.09	MT/AT			Engine E13S	GC041281	Outer Joint		21	22	48	98.5	56.5	M
<b>AD VAN / WAGON (VY10,WY10)</b>															
1.3	1990.10-	1996.08	MT/AT			Engine GA13DS	GC034024	Outer Joint		25	22	55	107	57	M
<b>AD VAN / WAGON (WEY10)</b>															
2.0	1993.08-	1996.05	4AT			Engine CD20	GC034024	Outer Joint		25	22	55	107	57	M
	1993.08-	1996.05	5MT			Engine CD20	GC034024	Outer Joint		25	22	55	107	57	M
2.0	1993.08-	1996.05	4AT			Engine CD20	GC041191	Outer Joint	42T	25	22	55	107	57	M
<b>AD VAN / WAGON MAX (V/W FY10/FGY10)</b>															
1.5	1990.10-	1996.08	MT&AT			Engine GA15DS	GC034024	Outer Joint		25	22	55	107	57	M
	1990.10-	1995.06	AT			Engine GA15DS	GC041191	Outer Joint	42T	25	22	55	107	57	M
	1990.10-	1996.05	MT			Engine GA15DS	GC041191	Outer Joint	42T	25	22	55	107	57	M
	1995.06-	1999.06	AT			Engine GA15DS	GC041033	Outer Joint		25	23	55	107	61	I
	1995.06-	1999.06	HMM			Engine GA15DS	GC041034	Outer Joint	42T	25	23	55	107	61	I
<b>AD VAN / WAGON MAX (V/WSY10,VSGY10)</b>															
1.7	1990.10-	1996.08	AT			Engine CD17	GC034024	Outer Joint		25	22	55	107	57	M
	1990.10-	1996.08	MT			Engine CD17	GC041191	Outer Joint	42T	25	22	55	107	57	M
<b>AD VAN / WAGON MAX (VFN/WFNY10)</b>															
1.5 4WD	1990.10-	1996.08	MT			Engine GA15DS E	GC034024	Outer Joint		25	22	55	107	57	M
	1990.10-	1996.05	AT			Engine GA15DS E	GC041033	Outer Joint		25	23	55	107	61	I
	1990.10-	1996.08	MT			Engine GA15DS E	GC041033	Outer Joint		25	23	55	107	61	I
	1990.10-	1996.05	MT&AT			Engine GA15DS E	GC041034	Outer Joint	42T	25	23	55	107	61	I
<b>AD VAN / WAGON MAX (VHB11)</b>															
1.5	1982.10-	1990.09	MT/AT			Engine E15S	GC041041	Outer Joint		24	22	52	105	56	M
<b>AD VAN / WAGON MAX (VSB11)</b>															
1.7	1982.10-	1990.09	MT/AT			Engine CD17	GC041041	Outer Joint		24	22	52	105	56	M
	1988.05-	1990.09	AT			Engine CD17	GC041041	Outer Joint		24	22	52	105	56	M
<b>AD VAN / WAGON MAX (VSNY10)</b>															
1.7 4WD	1990.10-	1996.08	AT			Engine CD17	GC034024	Outer Joint		25	22	55	107	57	M
	1990.10-	1993.08	MT/AT			Engine CD17	GC041033	Outer Joint		25	23	55	107	61	I
	1990.10-	1996.08	MT			Engine CD17	GC041191	Outer Joint	42T	25	22	55	107	57	M
<b>AD VAN WINGROAD (VFY11,WFY11)</b>															
1.5	1999.06-		4AT			Engine QG15DE	GC041239	Outer Joint		25	22	55	107	57	M
	1999.06-		4AT			Engine QG15DE	GC041159	Outer Joint	42T	25	22	55	107	57	M
	1999.06-		4AT			Engine QG15DE	GC041034	Outer Joint	42T	25	23	55	107	61	I
	1999.06-		5MT			Engine QG15DE	GC041034	Outer Joint	42T	25	23	55	107	61	I
<b>AD VAN WINGROAD (VY11)</b>															
1.3	1999.06-		4AT			Engine QG13DE	GC041239	Outer Joint		25	22	55	107	57	M
	1999.06-		5MT			Engine QG13DE	GC041239	Outer Joint		25	22	55	107	57	M
	1999.06-		5MT			Engine QG13DE	GC041159	Outer Joint	42T	25	22	55	107	57	M

		TRANSM	L/R	F/R		G-AP Ref.	PRODUCT	ABS	Technical Specifications								
									YEAR	A	B	C	H	L	P		
<b>NISSAN</b>																	
<b>AIMERA II (N16)</b>																	
1.5 DCi (60 kW)	2003.01-				U.K.	GC099252	Outer Joint	44T	25	23	55	100.5	60	M			
2.2 TD (81 kW)	2001-					GC041137	Outer Joint	42T	27	35	55	102	69	I			
<b>ALMERA (N15)</b>																	
1.4 (64 kW)	1995.09-2000.07			F	Saloon Engine GA14DE	GC041191	Outer Joint	42T	25	22	55	107	57	M			
	1995.09-2000.03			F	Hatchback Engine GA14DE	GC041191	Outer Joint	42T	25	22	55	107	57	M			
	1995.09-2000.03			F	Hatchback Engine GA14DE	GC041001	Outer Joint		25	22	55	107	56	I			
	1995.09-2000.07			F	Saloon Engine GA14DE	GC041001	Outer Joint		25	22	55	107	56	I			
1.4 GX,LX (55 kW)	1995.09-2000.07			F	Saloon Engine GA14DE	GC041001	Outer Joint		25	22	55	107	56	I			
1.4 S,GX,LX (55 kW)	1995.09-2000.03			F	Hatchback Engine GA14DE	GC041001	Outer Joint		25	22	55	107	56	I			
1.6 (73 kW)	1995.09-2000.03			F	Hatchback Engine GA16DE	GC099199	Outer Joint		25	23	55	107	62	M			
	1995.09-2000.07			F	Saloon Engine GA16DE	GC099199	Outer Joint		25	23	55	107	62	M			
	1995.09-2000.03	MT/AT		F	Hatchback Engine GA16DE	GC041078	Outer Joint		25	23	55	107	62	I			
	1995.09-2000.07	MT/AT		F	Saloon Engine GA16DE	GC041078	Outer Joint		25	23	55	107	62	I			
	1995.09-2000.03	MT/AT		F	Hatchback Engine GA16DE	GC041003	Outer Joint	42T	25	23	55	107	62	I			
	1995.09-2000.07	MT/AT		F	Saloon Engine GA16DE	GC041003	Outer Joint	42T	25	23	55	107	62	I			
1.6 SLX (66 kW)	1995.09-2000.07			F	Saloon Engine GA16DE	GC099199	Outer Joint		25	23	55	107	62	M			
	1995.09-2000.07	MT/AT		F	Saloon Engine GA16DE	GC041078	Outer Joint		25	23	55	107	62	I			
	1995.09-2000.07	MT/AT		F	Saloon Engine GA16DE	GC041003	Outer Joint	42T	25	23	55	107	62	I			
1.6 SR,SLX (66 kW)	1995.09-2000.03			F	Hatchback Engine GA16DE	GC099199	Outer Joint		25	23	55	107	62	M			
	1995.09-2000.03	MT/AT		F	Hatchback Engine GA16DE	GC041078	Outer Joint		25	23	55	107	62	I			
	1995.09-2000.03	MT/AT		F	Hatchback Engine GA16DE	GC041003	Outer Joint	42T	25	23	55	107	62	I			
2.0 D (55 kW)	1995.11-2000.03			F	Hatchback Engine CD20	GC099199	Outer Joint		25	23	55	107	62	M			
	1995.11-2000.07			F	Saloon Engine CD20	GC099199	Outer Joint		25	23	55	107	62	M			
	1995.11-2000.03	MT		F	Hatchback Engine CD20	GC041078	Outer Joint		25	23	55	107	62	I			
	1995.11-2000.07	MT		F	Saloon Engine CD20	GC041078	Outer Joint		25	23	55	107	62	I			
	1995.11-2000.03	MT		F	Hatchback Engine CD20	GC041003	Outer Joint	42T	25	23	55	107	62	I			
	1995.11-2000.07	MT		F	Saloon Engine CD20	GC041003	Outer Joint	42T	25	23	55	107	62	I			
2.0 GTi (105 kW)	1996.07-2000.03	MT	L/R	F	Hatchback Engine SR20DE	GC041078	Outer Joint		25	23	55	107	62	I			
	1996.07-2000.03	MT	L/R	F	Hatchback Engine SR20DE	GC041003	Outer Joint	42T	25	23	55	107	62	I			
<b>ALMERA I (N15)</b>																	
1.4 i 16V (55 kW)	1995.09-2000.07					GC041002	Outer Joint	42T	25	22	55	107	56	I			
1.4 i 16V (64 kW)	1995.09-2000.07					GC041002	Outer Joint	42T	25	22	55	107	56	I			
<b>ALMERA II (N16)</b>																	
1.5 (66 kW)	2000.03-		MT	R	F	Hatchback Engine QG15DE	GDS41269	Drive Shaft	42T	25	24	55	100.5	909			
	2000.03-		MT	L	F	Hatchback Engine QG15DE	GDS41270	Drive Shaft	42T	25	24	55	100.5	627			
	2000.07-		MT	R	F	Saloon Engine QG15DE	GDS41269	Drive Shaft	42T	25	24	55	100.5	909			
	2000.07-		MT	L	F	Saloon Engine QG15DE	GDS41270	Drive Shaft	42T	25	24	55	100.5	627			
1.5 (72 kW)	2002.09-2007.05			F	Saloon Engine QG15DE	GC041048	Outer Joint	42T	25	22	55	100.5	58.5	M			
	2002.09-2007.05			F	Saloon Engine QG15DE	GC041141	Outer Joint	44T	25	22	55	100.5	58.5	M			
	2002.09-2007.05	MT	L	F	Saloon Engine QG15DE	GDS41385	Drive Shaft	44T	25	24	55	100.5	627				
	2002.09-2007.05		L	F	Saloon Engine QG15DE	GDS41328	Drive Shaft	44T	25	24	55	100	627				
	2002.09-2007.05		L/R	F	Saloon Engine QG15DE	GC041243	Outer Joint	44T	25	21	55	100	54	M			
	2002.09-2007.05		L/R	F	Saloon Engine QG15DE	GCI41090	Inner Joint		24	21	40	51.5	93				
	2002.09-2007.05		L/R	F	Saloon Engine QG15DE	GC041264	Outer Joint		25	21	55	100	54	M			
	2002.09-2007.05	MT	R	F	Saloon Engine QG15DE	GDS41386	Drive Shaft	44T	25	24	55	100.5	909				
	2002.09-2007.05		R	F	Saloon Engine QG15DE	GDS41327	Drive Shaft	44T	25	24	55	100	908				
	2003.03-2004.10			F	Hatchback Engine QG15DE	GC041048	Outer Joint	42T	25	22	55	100.5	58.5	M			
	2003.03-2004.10			F	Hatchback Engine QG15DE	GC041141	Outer Joint	44T	25	22	55	100.5	58.5	M			
	2003.03-2004.10	MT	L	F	Hatchback Engine QG15DE	GDS41385	Drive Shaft	44T	25	24	55	100.5	627				
	2003.03-2004.10		L	F	Hatchback Engine QG15DE	GDS41328	Drive Shaft	44T	25	24	55	100	627				
	2003.03-2004.10		L/R	F	Hatchback Engine QG15DE	GC041243	Outer Joint	44T	25	21	55	100	54	M			
	2003.03-2004.10		L/R	F	Hatchback Engine QG15DE	GCI41090	Inner Joint		24	21	40	51.5	93				
	2003.03-2004.10		L/R	F	Hatchback Engine QG15DE	GC041264	Outer Joint		25	21	55	100	54	M			
	2003.03-2004.10	MT	R	F	Hatchback Engine QG15DE	GDS41386	Drive Shaft	44T	25	24	55	100.5	909				
	2003.03-2004.10		R	F	Hatchback Engine QG15DE	GDS41327	Drive Shaft	44T	25	24	55	100	908				
1.5 DCi (60 kW)	2003.01-			F	Hatchback Engine K9K722	GC041112	Outer Joint		25	23	55	96.5	63.5	M			
	2003.01-			F	Hatchback Engine K9K722	GC041052	Outer Joint	42T	25	23	55	96.5	63.5	M			
	2003.01-			F	Saloon Engine K9K722	GC041112	Outer Joint		25	23	55	96.5	63.5	M			
	2003.01-			F	Saloon Engine K9K722	GC041052	Outer Joint	42T	25	23	55	96.5	63.5	M			
1.8 (84 kW)	2000.01-			F	Hatchback Engine QG18DE	GC099199	Outer Joint		25	23	55	107	62	M			
	2000.07-			F	Saloon Engine QG18DE	GC099199	Outer Joint		25	23	55	107	62	M			









		TRANSM	L/R	F/R		G-AP Ref.	PRODUCT	ABS	Technical Specifications									
									YEAR	A	B	C	H	L	P			
<b>NISSAN</b>																		
<b>ALMERA II (N16)</b>																		
1.8 (85 kW)	2002.09-	2007.05			F	Saloon Engine QG18DE	GC041052	Outer Joint	42T	25	23	55	96.5	63.5	M			
	2002.09-	2007.05			F	Saloon Engine QG18DE	GC041137	Outer Joint	42T	27	35	55	102	69	I			
	2002.09-	2007.05			F	Hatchback Engine QG18DE	GC041052	Outer Joint	42T	25	23	55	96.5	63.5	M			
	2002.09-	2007.05			F	Hatchback Engine QG18DE	GC041137	Outer Joint	42T	27	35	55	102	69	I			
2.2 DCi (100 kW)	2003.02-	2007.05			F	Hatchback Engine YD22DDTi	GC041057	Outer Joint	44T	27	26	55	102	69	M			
	2003.02-	2007.05			F	Hatchback Engine YD22DDTi	GC041236	Outer Joint		27	26	55	102	69	M			
	2003.02-	2007.05	6MT	L/R	F	Hatchback Engine YD22DDTi	GC041255	Outer Joint	44T	27	26	55	104	69	M			
	2003.03-	2004.08			F	Saloon Engine YD22DDTi	GC041057	Outer Joint	44T	27	26	55	102	69	M			
	2003.03-	2004.08			F	Saloon Engine YD22DDTi	GC041236	Outer Joint		27	26	55	102	69	M			
	2003.03-	2004.08		L/R	F	Saloon Engine YD22DDTi	GC041255	Outer Joint	44T	27	26	55	104	69	M			
2.2 DCi (82 kW)	2002.09-	2007.05			F	Saloon Engine YD22DDT	GC041057	Outer Joint	44T	27	26	55	102	69	M			
	2002.09-	2007.05			F	Saloon Engine YD22DDT	GC041236	Outer Joint		27	26	55	102	69	M			
	2002.09-	2007.05	6MT	L/R	F	Saloon Engine YD22DDT	GC041255	Outer Joint	44T	27	26	55	104	69	M			
	2003.03-	2007.05			F	Hatchback Engine YD22DDT	GC041057	Outer Joint	44T	27	26	55	102	69	M			
	2003.03-	2007.05			F	Hatchback Engine YD22DDT	GC041236	Outer Joint		27	26	55	102	69	M			
	2003.03-	2007.05	6MT	L/R	F	Hatchback Engine YD22DDT	GC041255	Outer Joint	44T	27	26	55	104	69	M			
2.2 Di (81 kW)	2000.03-		5MT		F	Hatchback Engine YD22DDT	GC041099	Outer Joint		27	35	55	102	69	I			
	2000.03-		5MT		F	Hatchback Engine YD22DDT	GC041256	Outer Joint	42T	27	26	55	104	69	M			
	2000.07-		5MT		F	Saloon Engine YD22DDT	GC041099	Outer Joint		27	35	55	102	69	I			
	2000.07-		5MT		F	Saloon Engine YD22DDT	GC041256	Outer Joint	42T	27	26	55	104	69	M			
<b>ALMERA TINO (V10)</b>																		
1.8 (84 kW)	2000.08-		MT	L	F	MPV Engine QG18DE	GCI41110	Inner Joint		25	23	40	63	101				
	2000.08-				F	MPV Engine QG18DE	GC041044	Outer Joint	44T	27	23	56	104	60	I			
	2000.08-		MT	R	F	MPV Engine QG18DE	GDS41194	Drive Shaft	44T	27	25	56	103.5	948.5				
	2000.08-		MT	L	F	MPV Engine QG18DE	GDS41195	Drive Shaft	44T	27	25	56	103.5	661				
1.8 (85 kW)	2003.03-	2006.03			F	MPV Engine QG18DE	GC041055	Outer Joint	44T	27	23	56	102	62	I			
	2003.03-	2006.03	MT	L	F	MPV Engine QG18DE	GDS41195	Drive Shaft	44T	27	25	56	103.5	661				
	2003.03-	2006.03	MT	R	F	MPV Engine QG18DE	GDS41194	Drive Shaft	44T	27	25	56	103.5	948.5				
	2003.12-		MT	L	F	MPV Engine QG18DE	GCI41110	Inner Joint		25	23	40	63	101				
2.0 (100 kW)	2000.08-				F	MPV Engine SR20DE	GC041015	Outer Joint	44T	27	27	56	103	69	I			
2.2 DCi (100 kW)	2003.03-	2006.03			F	MPV Engine YD22DDTi	GC041038	Outer Joint	44T	27	26	56	103	69	M			
2.2 DCi (82 kW)	2003.03-	2006.03			F	MPV Engine YD22DDT	GC041038	Outer Joint	44T	27	26	56	103	69	M			
<b>ALTIMA</b>																		
-	1993-	1994	AT				GCI41008	Inner Joint		29/31	27	46	86.8	124				
	1993-	1999					GC041088	Outer Joint		27	27	56	103	69	I			
	2006-						GC041214	Outer Joint		29	35	56.1	102	59	I			
2.4	1993-	1997					GC041091	Outer Joint		27	26	56	103	69	I			
<b>ALTIMA (L31)</b>																		
2.5	2003.04-			L			GDS41296	Drive Shaft		27	29	56	102	649				
	2003.04-			R			GDS41297	Drive Shaft		27	29	56	102	980				
<b>AUSTER</b>																		
1.8 Turbo (PT12)	1985.01-	1988.12	MT			Engine CA18ET	GC041063	Outer Joint		27	25	56	103	70.5	I			
<b>AUSTER STANZA (PT12)</b>																		
1.8	1988.01-	1989.12	MT/AT			Engine CA18DT	GC041035	Outer Joint		27	25	56	101	70	M			
	1988.01-	1990.06	MT/AT			Engine CA18DE	GC041035	Outer Joint		27	25	56	101	70	M			
	1988.01-	1990.06	AT			Engine CA18I	GC041023	Outer Joint		27	23	56	103	61.5	M			
<b>AVENIR (PNW10)</b>																		
2.0 4WD	1990.10-	1995.08	AT			Engine SR20DE	GC041023	Outer Joint		27	23	56	103	61.5	M			
	1990.10-	1995.08	AT			Engine SR20DE	GC041024	Outer Joint	42T	27	23	56	103	61.5	M			
<b>AVENIR (PW10)</b>																		
2.0	1990.05-	1993.01	MT/AT			Engine SR20DE	GC041035	Outer Joint		27	25	56	101	70	M			
	1990.05-	1993.01	MT			Engine SR20DE	GC041035	Outer Joint		27	25	56	101	70	M			
<b>AVENIR (SW10)</b>																		
2.0	1993.01-	1995.08	AT			Engine CD20T	GC041035	Outer Joint		27	25	56	101	70	M			
<b>AVENIR (VENW10)</b>																		
1.6 4WD	1990.10-	1993.01	MT			Engine GA16DS	GC041023	Outer Joint		27	23	56	103	61.5	M			
<b>AVENIR (VEW10)</b>																		
1.6	1990.05-	1993.01	MT&AT			Engine GA16DS	GC041023	Outer Joint		27	23	56	103	61.5	M			
	1990.05-	1993.01	MT&AT			Engine GA16DS	GC041024	Outer Joint	42T	27	23	56	103	61.5	M			
<b>AVENIR (VSW10)</b>																		
2.0	1990.01-	1993.01	MT			Engine CD20	GC041023	Outer Joint		27	23	56	103	61.5	M			
	1990.05-	1993.01	MT			Engine CD20	GC041024	Outer Joint	42T	27	23	56	103	61.5	M			



		YEAR	TRANSM	L/R	F/R		G-AP Ref.	PRODUCT	ABS	Technical Specifications									
										A	B	C	H	L	P				
<b>NISSAN AVENIR (W10)</b>																			
1.8	1990.05-	1993.01	MT/AT			Engine SR18DI E	GC041023	Outer Joint			27	23	56	103	61.5	M			
<b>BLUEBIRD</b>																			
1.8	1983-	1987				U11 RU11 VRU11	GC041070	Outer Joint			27	23	56	104	63	M			
<b>BLUEBIRD (910)</b>																			
1.6 (60 kW)	1980.01-	1983.11			R	Saloon Engine L16	GC041176	Outer Joint			27	23	56	104	63	I			
1.8 (65 kW)	1980.01-	1983.12			R	Saloon Engine L18S	GC041176	Outer Joint			27	23	56	104	63	I			
1.8 (66 kW)	1980.01-	1984.05			R	Coupe Engine L18T	GC041176	Outer Joint			27	23	56	104	63	I			
<b>BLUEBIRD (ENU12)</b>																			
1.8 4WD	1989.10-	1991.09	MT/AT			Engine SR18DI	GC041054	Outer Joint			27	23	56	103	61.5	M			
<b>BLUEBIRD (ENU14)</b>																			
1.8 4WD	1996.01-		AT			Engine SR18DE	GC041023	Outer Joint			27	23	56	103	61.5	M			
	1996.01-		MT&AT			Engine SR18DE	GC041024	Outer Joint	42T		27	23	56	103	61.5	M			
<b>BLUEBIRD (EU11)</b>																			
2.0	1987.01-		MT			Engine LD20	GC041023	Outer Joint			27	23	56	103	61.5	M			
<b>BLUEBIRD (EU12)</b>																			
1.8	1989.01-	1991.09	MT/AT			Engine SR18DI	GC041023	Outer Joint			27	23	56	103	61.5	M			
	1989.10-	1991.09	MT&AT			Engine SR18DI	GC041023	Outer Joint			27	23	56	103	61.5	M			
<b>BLUEBIRD (EU13)</b>																			
1.8	1991.01-	1996.01	AT			Engine SR18DE	GC041054	Outer Joint			27	23	56	103	61.5	M			
<b>BLUEBIRD (HNU12)</b>																			
2.0 4WD	1989.10-	1991.09	MT/AT			Engine SR20DET	GC041054	Outer Joint			27	23	56	103	61.5	M			
<b>BLUEBIRD (HNU14)</b>																			
2.0 4WD	1996.01-		AT			Engine SR20DE	GC041023	Outer Joint			27	23	56	103	61.5	M			
	1996.01-		MT&AT			Engine SR20DE	GC041024	Outer Joint	42T		27	23	56	103	61.5	M			
<b>BLUEBIRD (HU12)</b>																			
2.0	1989.10-	1991.09	MT/AT			Engine SR20DE	GC041035	Outer Joint			27	25	56	101	70	M			
<b>BLUEBIRD (HU14)</b>																			
2.0	1996.01-		MT			Engine SR20DE	GC041024	Outer Joint	42T		27	23	56	103	61.5	M			
<b>BLUEBIRD (RNU12)</b>																			
1.8 4WD	1987.09-	1989.10	MT/AT			Engine CA18	GC041023	Outer Joint			27	23	56	103	61.5	M			
	1987.09-	1989.10	MT/AT			Engine CA18	GC041024	Outer Joint	42T		27	23	56	103	61.5	M			
<b>BLUEBIRD (RU12)</b>																			
1.8	1987.09-	1989.10	MT/AT			Engine CA18DE	GC041035	Outer Joint			27	25	56	101	70	M			
	1987.09-	1989.10	MT/AT			Engine CA18I	GC041023	Outer Joint			27	23	56	103	61.5	M			
	1987.09-	1989.10	MT/AT			Engine CA18	GC041024	Outer Joint	42T		27	23	56	103	61.5	M			
<b>BLUEBIRD (SU12)</b>																			
2.0	1987.09-	1991.09	MT/AT			Engine LD20	GC041023	Outer Joint			27	23	56	103	61.5	M			
<b>BLUEBIRD (SU13)</b>																			
2.0	1991.09-	1995.11	MT&AT			Engine CD20	GC041054	Outer Joint			27	23	56	103	61.5	M			
<b>BLUEBIRD (T72 , T12)</b>																			
1.6 (61 kW)	1986.03-	1990.06			F	Saloon Engine CA16S	GC041042	Outer Joint	44T		27	23	56	103.5	61.4	I			
	1986.03-	1990.06			F	Saloon Engine CA16S	GC041176	Outer Joint			27	23	56	104	63	I			
	1986.03-	1990.06	MT/AT		F	Saloon Engine CA16S	GC041061	Outer Joint			27	23	56	99	60	I			
	1986.03-	1990.06			F	Saloon Engine CA16S	GC041045	Outer Joint			27	23	56	103	62	I			
1.8 i 16V (95 kW)	1989.02-	1990.12	MT		F	Hatchback Engine CA18D	GC041006	Outer Joint			27	32	56	103.5	68.5	I			
	1989.02-	1990.12	MT		F	Saloon Engine CA18D	GC041006	Outer Joint			27	32	56	103.5	68.5	I			
	1989.02-	1990.12			F	Saloon Engine CA18D	GC041062	Outer Joint	44T		27	25	56	103	70.5	I			
	1989.02-	1990.12	MT		F	Saloon Engine CA18D	GC041007	Outer Joint	42T		27	32	56	103.5	68.5	I			
	1989.02-	1990.12	MT		F	Saloon Engine CA18D	GC041061	Outer Joint			27	23	56	99	60	I			
1.8 Turbo (99 kW)	1986.03-	1990.12			F	Saloon Engine CA18T	GC041045	Outer Joint			27	23	56	103	62	I			
2.0 (75 kW)	1985.12-	1987.12	MT		F	Saloon Engine CA20S	GC041061	Outer Joint			27	23	56	99	60	I			
	1985.12-	1987.12			F	Saloon Engine CA20S	GC041045	Outer Joint			27	23	56	103	62	I			
2.0 D (49 kW)	1986.03-	1990.12	MT		F	Hatchback Engine LD20	GC041006	Outer Joint			27	32	56	103.5	68.5	I			
	1986.03-	1990.12			F	Saloon Engine LD20	GC041018	Outer Joint			27	23	56	99	60	I			
	1986.03-	1990.12	MT		F	Saloon Engine LD20	GC041007	Outer Joint	42T		27	32	56	103.5	68.5	I			
	1986.03-	1990.12	MT		F	Saloon Engine LD20	GC041061	Outer Joint			27	23	56	99	60	I			
	1986.03-	1990.12	MT	L/R	F	Saloon Engine LD20	GC041006	Outer Joint			27	32	56	103.5	68.5	I			
2.0 i (77 kW)	1985.12-	1990.12	MT		F	Hatchback Engine CA20E	GC041006	Outer Joint			27	32	56	103.5	68.5	I			
	1985.12-	1990.12	MT		F	Saloon Engine CA20E	GC041006	Outer Joint			27	32	56	103.5	68.5	I			
	1985.12-	1990.12			F	Saloon Engine CA20E	GC041042	Outer Joint	44T		27	23	56	103.5	61.4	I			
	1985.12-	1990.12	MT		F	Saloon Engine CA20E	GC041007	Outer Joint	42T		27	32	56	103.5	68.5	I			
	1985.12-	1990.12	MT		F	Saloon Engine CA20E	GC041061	Outer Joint			27	23	56	99	60	I			

		YEAR	TRANSM	L/R	F/R		G-AP Ref.	PRODUCT	ABS	Technical Specifications									
										A	B	C	H	L	P				
<b>NISSAN BLUEBIRD (T72 , T12)</b>																			
2.0 i (77 kW)	1985.12-	1990.12			F	Saloon Engine CA20E	GC041045	Outer Joint			27	23	56	103	62	I			
2.0 i (85 kW)	1988.09-	1990.09	MT	L/R	F	Saloon Engine CA20E	GC041006	Outer Joint			27	32	56	103.5	68.5	I			
	1988.09-	1990.09	MT	L/R	F	Hatchback Engine CA20E	GC041006	Outer Joint			27	32	56	103.5	68.5	I			
<b>BLUEBIRD (T72, T12)</b>																			
1.6 (61 kW)	1986.03-	1990.06			F	Hatchback Engine CA16S	GC041042	Outer Joint	44T		27	23	56	103.5	61.4	I			
	1986.03-	1990.06			F	Hatchback Engine CA16S	GC041176	Outer Joint			27	23	56	104	63	I			
	1986.03-	1990.06	MT/AT		F	Hatchback Engine CA16S	GC041061	Outer Joint			27	23	56	99	60	I			
	1986.03-	1990.06			F	Hatchback Engine CA16S	GC041045	Outer Joint			27	23	56	103	62	I			
1.6 (66 kW)	1986.03-	1991.06			F	Hatchback Engine CA16S	GC041176	Outer Joint			27	23	56	104	63	I			
	1986.03-	1991.06	MT/AT		F	Hatchback Engine CA16S	GC041061	Outer Joint			27	23	56	99	60	I			
	1986.03-	1991.06			F	Hatchback Engine CA16S	GC041045	Outer Joint			27	23	56	103	62	I			
1.8 i 16V (95 kW)	1989.02-	1990.12			F	Hatchback Engine CA18D	GC041062	Outer Joint	44T		27	25	56	103	70.5	I			
	1989.02-	1990.12	MT		F	Hatchback Engine CA18D	GC041007	Outer Joint	42T		27	32	56	103.5	68.5	I			
	1989.02-	1990.12			F	Hatchback Engine CA18D	GC041176	Outer Joint			27	23	56	104	63	I			
	1989.02-	1990.12	MT		F	Hatchback Engine CA18D	GC041061	Outer Joint			27	23	56	99	60	I			
1.8 Turbo (99 kW)	1985.12-	1992.11			F	Hatchback Engine CA18T	GC041045	Outer Joint			27	23	56	103	62	I			
2.0 (75 kW)	1985.12-	1987.12	MT		F	Hatchback Engine CA20S	GC041061	Outer Joint			27	23	56	99	60	I			
	1985.12-	1987.12			F	Hatchback Engine CA20S	GC041045	Outer Joint			27	23	56	103	62	I			
2.0 D (49 kW)	1986.03-	1990.12			F	Hatchback Engine LD20	GC041018	Outer Joint			27	23	56	99	60	I			
	1986.03-	1990.12	MT		F	Hatchback Engine LD20	GC041007	Outer Joint	42T		27	32	56	103.5	68.5	I			
	1986.03-	1990.12	MT		F	Hatchback Engine LD20	GC041061	Outer Joint			27	23	56	99	60	I			
2.0 i (77 kW)	1985.12-	1990.12			F	Hatchback Engine CA20E	GC041042	Outer Joint	44T		27	23	56	103.5	61.4	I			
	1985.12-	1990.12	MT		F	Hatchback Engine CA20E	GC041007	Outer Joint	42T		27	32	56	103.5	68.5	I			
	1985.12-	1990.12			F	Hatchback Engine CA20E	GC041176	Outer Joint			27	23	56	104	63	I			
	1985.12-	1990.12	MT		F	Hatchback Engine CA20E	GC041061	Outer Joint			27	23	56	99	60	I			
	1985.12-	1990.12			F	Hatchback Engine CA20E	GC041045	Outer Joint			27	23	56	103	62	I			
<b>BLUEBIRD (U11)</b>																			
1.8	1987.01-		AT			Engine CA18S	GC041023	Outer Joint			27	23	56	103	61.5	M			
1.8 (66 kW)	1983.11-	1988.06			F	Saloon Engine CA18S	GC041042	Outer Joint	44T		27	23	56	103.5	61.4	I			
	1983.11-	1988.06			F	Saloon Engine CA18S	GC041176	Outer Joint			27	23	56	104	63	I			
	1983.11-	1988.06	MT/AT		F	Saloon Engine CA18S	GC041061	Outer Joint			27	23	56	99	60	I			
	1983.11-	1988.06			F	Saloon Engine CA18S	GC041045	Outer Joint			27	23	56	103	62	I			
1.8 (U11)	1983.01-	1987.12	MT			Engine CA18ET/CA18DET	GC041063	Outer Joint			27	25	56	103	70.5	I			
1.8 Turbo (99 kW)	1984.04-	1990.05			F	Saloon Engine CA18T	GC041045	Outer Joint			27	23	56	103	62	I			
2.0 (EU11)	1983.01-	1987.12	MT			Engine LD20	GC041063	Outer Joint			27	25	56	103	70.5	I			
2.0 (JU11)	1983.01-	1987.12	MT			Engine CA20S	GC041063	Outer Joint			27	25	56	103	70.5	I			
2.0 (PU11)	1983.01-	1987.12	MT			Engine VG20TE/VG20E	GC041063	Outer Joint			27	25	56	103	70.5	I			
2.0 D (43 kW)	1984.04-	1988.01	MT		F	Saloon Engine LD20	GC041061	Outer Joint			27	23	56	99	60	I			
2.0 i (77 kW)	1984.04-	1988.01			F	Saloon Engine CA20E	GC041042	Outer Joint	44T		27	23	56	103.5	61.4	I			
	1984.04-	1988.01			F	Saloon Engine CA20E	GC041176	Outer Joint			27	23	56	104	63	I			
	1984.04-	1988.01	MT		F	Saloon Engine CA20E	GC041061	Outer Joint			27	23	56	99	60	I			
	1984.04-	1988.01			F	Saloon Engine CA20E	GC041045	Outer Joint			27	23	56	103	62	I			
<b>BLUEBIRD (U14)</b>																			
2.0	1996.01-	2001.08	AT			Engine CD20	GC041054	Outer Joint			27	23	56	103	61.5	M			
<b>BLUEBIRD STATION WAGON (WU11)</b>																			
2.0 (75 kW)	1986.04-	1990.09			F	Estate Engine CA20S	GC041042	Outer Joint	44T		27	23	56	103.5	61.4	I			
	1986.04-	1990.09	MT		F	Estate Engine CA20S	GC041163	Outer Joint			27	25	56	103	66.5	I			
	1986.04-	1990.09			F	Estate Engine CA20S	GC041045	Outer Joint			27	23	56	103	62	I			
2.0 D (43 kW)	1984.04-	1988.01			F	Estate Engine LD20	GC041018	Outer Joint			27	23	56	99	60	I			
	1984.04-	1988.01	MT		F	Estate Engine LD20	GC041061	Outer Joint			27	23	56	99	60	I			
2.0 D (49 kW)	1986.03-	1990.12	MT		F	Estate Engine LD20	GC041018	Outer Joint			27	23	56	99	60	I			
	1986.03-	1990.12	MT		F	Estate Engine LD20	GC041176	Outer Joint			27	23	56	104	63	I			
	1986.03-	1990.12			F	Estate Engine LD20	GC041045	Outer Joint			27	23	56	103	62	I			
2.0 i (77 kW)	1984.04-	1990.12			F	Estate Engine CA20E	GC041042	Outer Joint	44T		27	23	56	103.5	61.4	I			
	1984.04-	1990.12			F	Estate Engine CA20E	GC041176	Outer Joint			27	23	56	104	63	I			
	1984.04-	1990.12	MT		F	Estate Engine CA20E	GC041061	Outer Joint			27	23	56	99	60	I			
	1984.04-	1990.12			F	Estate Engine CA20E	GC041045	Outer Joint			27	23	56	103	62	I			
<b>BLUEBIRD SYLPHY (FG10)</b>																			
1.5	2000.08-		5MT			Engine QG15DE	GC041159	Outer Joint	42T		25	22	55	107	57	M			
<b>BLUEBIRD SYLPHY (G10)</b>																			
1.5	2000.08-		4AT/F			Engine QG15DE	GC041159	Outer Joint	42T		25	22	55	107	57	M			
	2000.08-		5MT/F			Engine QG15DE	GC041159	Outer Joint	42T		25	22	55	107	57	M			









		TRANSM	L/R	F/R		G-AP Ref.	PRODUCT	ABS	Technical Specifications					
									YEAR	A	B	C	H	L
<b>NISSAN</b>														
<b>BLUEBIRD SYLPHY (G10)</b>														
1.8	2000.08-		4AT/F		Engine QG18DE	GC041034	Outer Joint	42T	25	23	55	107	61	I
2.0	2000.08-		CVT/F		Engine QR20DD	GC041034	Outer Joint	42T	25	23	55	107	61	I
<b>BLUEBIRD SYLPHY (G11E)</b>														
1.5	2005.12-	2009.05	4AT		Engine HR15DE	GC041303	Outer Joint		25	21	49	95	56	M
1.5 4WD	2005.12-	2009.05	4AT		Engine HR15DE	GC041303	Outer Joint		25	21	49	95	56	M
2.0	2005.12-	2007.05	CVT			GC041308	Outer Joint		25	23	49	95	56.5	M
<b>BLUEBIRD SYLPHY (QG10)</b>														
1.8	2000.08-		4AT		Engine QG18DE	GC041034	Outer Joint	42T	25	23	55	107	61	I
<b>BLUEBIRD SYLPHY (TG10)</b>														
2.0	2000.08-		CVT		Engine QR20DD	GC041034	Outer Joint	42T	25	23	55	107	61	I
<b>BLUEBIRD VAN / WAGON (VEU11)</b>														
2.0	1987.09-	1990.05	MT		Engine LD20	GC041023	Outer Joint		27	23	56	103	61.5	M
<b>BLUEBIRD VAN / WAGON (WU11)</b>														
1.8	1987.09-	1990.05	4AT		Engine CA18S	GC041023	Outer Joint		27	23	56	103	61.5	M
	1987.10-	1990.05	MT/AT		Engine CA18ET	GC041035	Outer Joint		27	25	56	101	70	M
<b>CALIFORNIA (B11)</b>														
1.5	1981.10-	1985.09	MT/AT		Engine E15	GC041041	Outer Joint		24	22	52	105	56	M
<b>CALIFORNIA (B12)</b>														
1.5	1985.09-	1990.01	MT/AT		Engine E15S/GA15S	GC041039	Outer Joint		25	22	52.3	107.4	55.7	M
	1987.09-	1990.01	4AT		Engine GA15S	GC041039	Outer Joint		25	22	52.3	107.4	55.7	M
1.5 4WD	1986.09-	1987.09	MT/AT		Engine E15S	GC099204	Outer Joint		25	25	52.3	106.5	62	M
	1987.09-	1990.09	MT/AT		Engine GA15	GC041023	Outer Joint		27	23	56	103	61.5	M
<b>CALIFORNIA (WSB11)</b>														
1.7	1982.10-	1985.09	MT		Engine CD17	GC041041	Outer Joint		24	22	52	105	56	M
<b>CALIFORNIA (WSB12)</b>														
1.7	1985.09-	1990.09	MT		Engine CD17	GC041039	Outer Joint		25	22	52.3	107.4	55.7	M
<b>CALIFORNIA (Y10)</b>														
1.5	1990.10-	1996.08	MT&AT		Engine GA15D	GC034024	Outer Joint		25	22	55	107	57	M
	1990.10-	1995.06	AT		Engine GA15D	GC041191	Outer Joint	42T	25	22	55	107	57	M
	1990.10-	1996.05	MT		Engine GA15D	GC041191	Outer Joint	42T	25	22	55	107	57	M
	1995.06-	1996.05	AT		Engine GA15D	GC041033	Outer Joint		25	23	55	107	61	I
	1995.06-	1996.05	AT		Engine GA15D	GC041034	Outer Joint	42T	25	23	55	107	61	I
1.5 4WD	1990.10-	1996.05	AT		Engine GA15	GC041033	Outer Joint		25	23	55	107	61	I
	1990.10-	1996.05	MT&AT		Engine GA15	GC041034	Outer Joint	42T	25	23	55	107	61	I
<b>CARAVAN HOMOY (E24)</b>														
2.7 4WD	1987.10-	2001.04	MT/AT		Engine TD27	GC041085	Outer Joint		26	27	50	148	60	M
	1988.10-	1993.05	AT		Engine TD27T	GC041085	Outer Joint		26	27	50	148	60	M
	1988.10-	1993.05	MT/AT		Engine TD27T	GC041085	Outer Joint		26	27	50	148	60	M
	1993.05-	1995.08	4AT		Engine TD27TI	GC041085	Outer Joint		26	27	50	148	60	M
	1995.08-	1997.05	4AT		Engine TD27ETI	GC041085	Outer Joint		26	27	50	148	60	M
3.2 4WD	1996.09-	2001.04	MT/AT		Engine QD32	GC041085	Outer Joint		26	27	50	148	60	M
<b>CEFIRO</b>														
2.0	1996-	1999				GC041131	Outer Joint		29	25	56	103	65.5	I
<b>CEFIRO J30</b>														
3.0	1989-	1991			Engine VG30E	GC041075	Outer Joint		27	25	56	103	70.5	I
<b>CEFIRO MAXIMA (A33)</b>														
2.0	1998.12-	2002.12	4AT		Engine VQ20DE	GC041111	Outer Joint		29	25	56	101	68	M
	1998.12-	2002.12	4AT		Engine VQ20DE	GC041185	Outer Joint	44T	29	25	56	101	68	M
	1998.12-	2002.12	5MT		Engine VQ20DE	GC041111	Outer Joint		29	25	56	101	68	M
	1998.12-	2002.12	5MT		Engine VQ20DE	GC041185	Outer Joint	44T	29	25	56	101	68	M
	1998.12-	2002.12	5MT		Engine VQ20DE	GC041187	Outer Joint	44T	29	23	56	103	62	M
	1998.12-	2002.12	5MT		Engine VQ20DE	GC041036	Outer Joint		29	27	56	101	68	M
	2001.01-	2002.12	4AT		Engine VQ20DE	GC041187	Outer Joint	44T	29	23	56	103	62	M
2.5	1998.12-	2002.12	4AT		Engine VQ25DD	GC041111	Outer Joint		29	25	56	101	68	M
	1998.12-	2002.12	4AT		Engine VQ25DD	GC041185	Outer Joint	44T	29	25	56	101	68	M
<b>CHERRY</b>														
1.6	1982-	1984				GC041065	Outer Joint		24	22	52	104	57	M
<b>CHERRY II (N10)</b>														
1.4 (59 kW)	1980.08-	1981.07	MT	F	Coupe Engine A14S	GC041059	Outer Joint		24	22	52	105	55	M
1.4 i.e. (59 kW)	1980.08-	1981.07	MT	F	Hatchback Engine A14S	GC041059	Outer Joint		24	22	52	105	55	M



		YEAR	TRANSM	L/R	F/R		G-AP Ref.	PRODUCT	ABS	Technical Specifications										
										A	B	C	H	L	P					
<b>NISSAN</b>																				
<b>CHERRY II TRAVELLER (VN10)</b>																				
1.4 (59 kW)	1980.08-	1981.07	MT			Estate Engine A14S	GC041059	Outer Joint			24	22	52	105	55	M				
<b>CHERRY III (N12)</b>																				
1.3 (44 kW)	1982.05-	1986.10	MT			Hatchback Engine E13	GC041170	Outer Joint			21	22	48	98	57	I				
1.5 (55 kW)	1983.11-	1986.10	MT			Hatchback Engine E15S	GC041060	Outer Joint			24	22	52	105	56	I				
1.7 D (40 kW)	1982.10-	1986.12	MT/AT			Hatchback Engine CD17	GC041060	Outer Joint			24	22	52	105	56	I				
<b>CUBE (Z11)</b>																				
1.4	2002.10-	2006.01	4AT			Engine CR14DE	GC041304	Outer Joint			25	29	49	95	56	I				
	2002.10-	2006.01	CVT			Engine CR14DE	GC041304	Outer Joint			25	29	49	95	56	I				
	2006.01-		AT/CVT			Engine CR14DE	GC041304	Outer Joint			25	29	49	95	56	I				
1.4 4WD	2002.10-	2006.01	4AT			Engine CR14DE	GC041304	Outer Joint			25	29	49	95	56	I				
1.5	2003.09-	2006.12	CVT			Engine HR15DE	GC041304	Outer Joint			25	29	49	95	56	I				
1.5 4WD	2005.05-	2006.01	4AT			Engine HR15DE	GC041304	Outer Joint			25	29	49	95	56	I				
<b>CUBE (Z12)</b>																				
1.6 16V (81 kW)	2010.03-		MT	L	F	Hatchback Engine HR16DE	GDS41366	Drive Shaft			25	26	49.1	95	658					
<b>CUBE Z11</b>																				
-	2002.10-						GC041224	Outer Joint			25	29	49	95	56	I				
<b>DATSUN (D21)</b>																				
2.0 4WD	1985.01-	1989.01	MT/AT			Engine Z20	GC041051	Outer Joint			27	27	50	151	71	M				
	1987.08-	1989.09	MT			Engine Z20	GC041085	Outer Joint			26	27	50	148	60	M				
	1989.09-	1993.10	MT			Engine NA20S	GC041085	Outer Joint			26	27	50	148	60	M				
2.3 4WD	1987.08-	1992.08	MT			Engine TD23	GC041085	Outer Joint			26	27	50	148	60	M				
2.7 4WD	1988.11-	1993.10	MT/AT			Engine TD27	GC041085	Outer Joint			26	27	50	148	60	M				
<b>DATSUN 140 Y (HLB310)</b>																				
1.4 (49 kW)	1979.02-	1983.06	MT		R	Estate Engine A14	GC041059	Outer Joint			24	22	52	105	55	M				
<b>DATSUN FRONTIER (D22)</b>																				
2.4 4WD	1999.06-	2002.08	4FAT			Engine KA24DE	GC041100	Outer Joint			28	25	50	150	71	I				
	1999.06-	2002.08	MT/AT			Engine KA24DE	GC041100	Outer Joint			28	25	50	150	71	I				
3.2 4WD	1997.01-	2002.08	5FMT			Engine QD32	GC041100	Outer Joint			28	25	50	150	71	I				
	1997.01-	2002.08	MT/AT			Engine QD32	GC041100	Outer Joint			28	25	50	150	71	I				
	1997.02-	2002.08	4FAT			Engine QD32	GC041100	Outer Joint			28	25	50	150	71	I				
<b>DUALIS (KJ10)</b>																				
2.0	2007-		CVT			Engine MR20DE	GC041311	Outer Joint			29	35	56	102.5	59	I				
<b>DUALIS (KNJ10)</b>																				
2.0 4WD	2007-		CVT			Engine MR20DE	GC041311	Outer Joint			29	35	56	102.5	59	I				
<b>EXA (KEN13)</b>																				
1.6 4WD	1986.10-	1990.07	MT&AT			Engine CA16DE	GC099204	Outer Joint			25	25	52.3	106.5	62	M				
<b>INTERSTAR</b>																				
1.0 DCi (73 kW)	2004.02-					Platform/Chassis Engine G9U720	GC044026	Outer Joint	51T		28	36	65	96	71	I				
2.5 DCi (107 kW)	2006.08-		MT	L	F	Platform/Chassis Engine G9U632	GDS99286	Drive Shaft	51T		28	39	65	96	700					
2.5 DCi (88 kW)	2006.08-			L	F	Platform/Chassis Engine G9U650	GDS99286	Drive Shaft	51T		28	39	65	96	700					
2.5 DCi 120 (84 kW)	2003.08-		MT	R	F	Platform/Chassis Engine G9U720	GDS50066	Drive Shaft			28	39	65	96	1142					
	2003.08-					Platform/Chassis Engine G9U720	GC044026	Outer Joint	51T		28	36	65	96	71	I				
<b>INTERSTAR (X70)</b>																				
1.0 DCi (73 kW)	2003.11-		MT	R	F	Box Engine G9U720	GDS50066	Drive Shaft			28	39	65	96	1142					
	2003.11-					Box Engine G9U720	GC044026	Outer Joint	51T		28	36	65	96	71	I				
	2003.11-					Bus Engine G9U720	GC044026	Outer Joint	51T		28	36	65	96	71	I				
1.9 DCi (60 kW)	2002.07-					Box Engine F9Q772	GC044026	Outer Joint	51T		28	36	65	96	71	I				
	2002.07-					Bus Engine F9Q772	GC044026	Outer Joint	51T		28	36	65	96	71	I				
2.2 DCi (66 kW)	2002.07-					Box Engine G9T722	GC044026	Outer Joint	51T		28	36	65	96	71	I				
	2002.07-					Bus Engine G9T722	GC044026	Outer Joint	51T		28	36	65	96	71	I				
2.5 DCi (107 kW)	2006.09-			L	F	Box Engine G9U632	GDS99286	Drive Shaft	51T		28	39	65	96	700					
2.5 DCi (74 kW)	2006.04-		MT	L	F	Box Engine G9U720	GDS99286	Drive Shaft	51T		28	39	65	96	700					
	2006.04-		MT	L	F	Bus Engine G9U650	GDS99286	Drive Shaft	51T		28	39	65	96	700					
	2006.04-		MT	R	F	Box Engine G9U720	GDS50066	Drive Shaft			28	39	65	96	1142					
2.5 DCi (84 kW)	2002.07-		MT	R	F	Bus Engine G9U720	GDS50066	Drive Shaft			28	39	65	96	1142					
	2002.07-					Box Engine G9U720	GC044026	Outer Joint	51T		28	36	65	96	71	I				
	2002.07-					Bus Engine G9U720	GC044026	Outer Joint	51T		28	36	65	96	71	I				
2.5 DCi (88 kW)	2006.09-		MT	L	F	Box Engine G9U650	GDS99286	Drive Shaft	51T		28	39	65	96	700					
	2006.09-			L	F	Bus Engine G9U650	GDS99286	Drive Shaft	51T		28	39	65	96	700					
	2006.09-		MT	R	F	Box Engine G9U650	GDS50066	Drive Shaft			28	39	65	96	1142					

		TRANSM	L/R	F/R		G-AP Ref.	PRODUCT	ABS	Technical Specifications							
									YEAR	A	B	C	H	L	P	
<b>NISSAN</b>																
<b>JUKE (F15)</b>																
1.5 DCi (81 kW)	2010.06-			L	F	Hatchback	GDS18361	Drive Shaft		29	26	56	103	693		
	2010.06-			R	F	Hatchback	GDS18414	Drive Shaft		29	26	56	103	944		
1.6	2010.11-		CVT			Engine MR16DDT	GC041309	Outer Joint		29	26	56.3	102.5	69	M	
1.6 (69 kW)	2013.01-		MT	R	F	Hatchback Engine HR16DE	GDS41428	Drive Shaft		29	26	56.2	102	938.5		
	2013.01-				F	Hatchback Engine HR16DE	GC041279	Outer Joint		29	22	56.2	102	59	M	
	2013.01-					Hatchback Engine HR16DE	GC041294	Outer Joint		29	24	56.2	102	63	M	
1.6 (86 kW)	2010.06-		MT	R	F	Hatchback Engine HR16DE	GDS41428	Drive Shaft		29	26	56.2	102	938.5		
	2010.06-				F	Hatchback Engine HR16DE	GC041279	Outer Joint		29	22	56.2	102	59	M	
	2010.06-					Hatchback Engine HR16DE	GC041294	Outer Joint		29	24	56.2	102	63	M	
1.6 DiG-T (140 kW)	2010.06-		MT	L	F	Hatchback Engine MR16DDT	GDS18362	Drive Shaft		29	26	56	103	684		
	2010.06-		MT	R	F	Hatchback Engine MR16DDT	GDS18365	Drive Shaft		29	26	56	103	950		
1.6 DiG-T 4x4 (140 kW)	2010.06-		MT	L	F	Hatchback Engine MR16DDT	GDS18362	Drive Shaft		29	26	56	103	684		
	2010.06-		MT	R	F	Hatchback Engine MR16DDT	GDS18365	Drive Shaft		29	26	56	103	950		
1.6 DiG-T NISMO RS (160 kW)	2014.08-		MT	R	F	Hatchback Engine MR16DDT	GDS18365	Drive Shaft		29	26	56	103	950		
	2014.08-				F	Hatchback Engine MR16DDT	GC041279	Outer Joint		29	22	56.2	102	59	M	
<b>KUBISTAR</b>																
1.2 (44 kW)	2003.08-				F	Box Engine D7F764	GC050004	Outer Joint	26T	21	30	52.2	85.5	59	I	
	2003.08-		MT	L	F	Box Engine D7F764	GDS99073	Drive Shaft	44T	21	29.95	57	84.5	628		
	2003.08-		MT	R	F	Box Engine D7F764	GDS99072	Drive Shaft	44T	21	23	57	84.5	720		
1.2 16V (55 kW)	2006.04-				F	Box Engine D4F712	GC050069	Outer Joint	44T	23	30	57.5	86.5	58.5	I	
	2006.04-		MT	L	F	Box Engine D4F712	GDS99073	Drive Shaft	44T	21	29.95	57	84.5	628		
	2006.04-		MT	R	F	Box Engine D4F712	GDS99072	Drive Shaft	44T	21	23	57	84.5	720		
1.5 DCi (48 kW)	2003.08-				F	Box Engine K9K704	GC050069	Outer Joint	44T	23	30	57.5	86.5	58.5	I	
	2003.08-		MT	L	F	Box Engine K9K704	GDS99073	Drive Shaft	44T	21	29.95	57	84.5	628		
	2003.08-		MT	R	F	Box Engine K9K704	GDS99072	Drive Shaft	44T	21	23	57	84.5	720		
1.5 DCi (60 kW)	2003.08-				F	Box Engine K9K722	GC050069	Outer Joint	44T	23	30	57.5	86.5	58.5	I	
	2003.08-		MT	L	F	Box Engine K9K722	GDS50411	Drive Shaft	44T	23	29.95	57.5	86.5	631		
<b>KUBISTAR (X76)</b>																
1.2 (44 kW)	2003.08-				F	MPV Engine D7F764	GC050004	Outer Joint	26T	21	30	52.2	85.5	59	I	
	2003.08-		MT	L	F	MPV Engine D7F764	GDS99073	Drive Shaft	44T	21	29.95	57	84.5	628		
	2003.08-		MT	R	F	MPV Engine D7F764	GDS99072	Drive Shaft	44T	21	23	57	84.5	720		
1.2 16V (55 kW)	2006.04-				F	MPV Engine D4F712	GC050069	Outer Joint	44T	23	30	57.5	86.5	58.5	I	
	2006.04-		MT	L	F	MPV Engine D4F712	GDS99073	Drive Shaft	44T	21	29.95	57	84.5	628		
	2006.04-		MT	R	F	MPV Engine D4F712	GDS99072	Drive Shaft	44T	21	23	57	84.5	720		
1.5 DCi (42 kW)	2003.08-				F	MPV Engine K9K710/K9K714	GC050069	Outer Joint	44T	23	30	57.5	86.5	58.5	I	
	2003.08-		MT	L	F	MPV Engine K9K710/K9K714	GDS99073	Drive Shaft	44T	21	29.95	57	84.5	628		
	2003.08-		MT	R	F	MPV Engine K9K710/K9K714	GDS99072	Drive Shaft	44T	21	23	57	84.5	720		
1.5 DCi (45 kW)	2005.08-				F	MPV Engine K9K710/K9K714	GC050069	Outer Joint	44T	23	30	57.5	86.5	58.5	I	
1.5 DCi (48 kW)	2003.08-				F	MPV Engine K9K704	GC050069	Outer Joint	44T	23	30	57.5	86.5	58.5	I	
	2003.08-		MT	L	F	MPV Engine K9K704	GDS99073	Drive Shaft	44T	21	29.95	57	84.5	628		
	2003.08-		MT	R	F	MPV Engine K9K704	GDS99072	Drive Shaft	44T	21	23	57	84.5	720		
1.5 DCi (50 kW)	2006.04-				F	MPV Engine K9K700	GC050069	Outer Joint	44T	23	30	57.5	86.5	58.5	I	
	2006.04-		MT	L	F	MPV Engine K9K700	GDS50177	Drive Shaft	21	29.95	57	84.5	625.7			
	2006.04-		MT	L	F	MPV Engine K9K700	GDS99073	Drive Shaft	44T	21	29.95	57	84.5	628		
	2006.04-		MT	R	F	MPV Engine K9K700	GDS50146	Drive Shaft	21	23	57	84.5	732.5			
	2006.04-				R	MPV Engine K9K700	GDS50250	Drive Shaft	26T	21	23	57	84.5	732.5		
	2006.04-		MT			MPV Engine K9K700	GC050052	Outer Joint	44T	23	30	57.5	86.5	58.5	I	
1.5 DCi (60 kW)	2003.08-				F	MPV Engine K9K722	GC050069	Outer Joint	44T	23	30	57.5	86.5	58.5	I	
	2003.08-		MT	L	F	MPV Engine K9K722	GDS50411	Drive Shaft	44T	23	29.95	57.5	86.5	631		
1.5 DCi (62 kW)	2006.04-				F	MPV Engine K9K276	GC050069	Outer Joint	44T	23	30	57.5	86.5	58.5	I	
	2006.04-		MT	L	F	MPV Engine K9K276	GDS50411	Drive Shaft	44T	23	29.95	57.5	86.5	631		
<b>LANGLEY</b>																
1.6 (WPB11)	1988.01-	1992.12	MT			Engine E16S	GC041083	Outer Joint		25	24	52.3	107	62	I	
<b>LANGLEY LIVERTAVILLA (BEN13)</b>																
1.6	1986.10-	1990.07	MT&AT			Engine CA16	GC099204	Outer Joint		25	25	52.3	106.5	62	M	
<b>LANGLEY LIVERTAVILLA (BSN13)</b>																
1.7	1986.10-	1990.07	MT			Engine CD17	GC041039	Outer Joint		25	22	52.3	107.4	55.7	M	
<b>LANGLEY LIVERTAVILLA (N12)</b>																
1.5	1982.05-	1986.10	MT&AT			Engine E15	GC041041	Outer Joint		24	22	52	105	56	M	
<b>LANGLEY LIVERTAVILLA (N13)</b>																
1.5	1986.10-	1990.07	MT/AT			Engine E15/GA15	GC041039	Outer Joint		25	22	52.3	107.4	55.7	M	
	1986.10-	1988.09	4AT			Engine E15	GC099204	Outer Joint		25	25	52.3	106.5	62	M	







		TRANSM	L/R	F/R		G-AP Ref.	PRODUCT	ABS	Technical Specifications						
									YEAR	A	B	C	H	L	P
<b>NISSAN</b>															
<b>LANGLEY LIVERTAVILLA (N13)</b>															
1.5	1987.01-	1988.09	MT/AT		Engine E15E	GC099204	Outer Joint		25	25	52.3	106.5	62	M	
		1988.09-	1990.07	4AT		Engine GA15	GC041039	Outer Joint		25	22	52.3	107.4	55.7	M
1.5 4WD	1988.09-	1990.07	MT/AT		Engine GA15	GC041023	Outer Joint		27	23	56	103	61.5	M	
<b>LANGLEY LIVERTAVILLA (SN12)</b>															
1.7	1983.05-	1986.10	MT		Engine CD17	GC041041	Outer Joint		24	22	52	105	56	M	
<b>LARGO (C22)</b>															
2.0 4WD	1986.11-	1993.04	MT/AT		Engine CA20/LD20T	GC041085	Outer Joint		26	27	50	148	60	M	
		1986.11-	1993.04	MT		Engine LD20	GC041085	Outer Joint		26	27	50	148	60	M
<b>LARGO (ED7)</b>															
2.4 4WD	1993.05-		4AT		Engine KA24DE	GC041023	Outer Joint		27	23	56	103	61.5	M	
		1993.05-	4AT		Engine KA24DE	GC041024	Outer Joint	42T	27	23	56	103	61.5	M	
<b>LARGO (UD7)</b>															
2.0 4WD	1993.05-		4AT		Engine CD20TI	GC041023	Outer Joint		27	23	56	103	61.5	M	
		1993.05-	4AT		Engine CD20TI	GC041024	Outer Joint	42T	27	23	56	103	61.5	M	
<b>LARGO (W30)</b>															
2.0 4WD	1993.05-	1996.10	MT/AT		Engine CD20TI	GC041023	Outer Joint		27	23	56	103	61.5	M	
		1993.05-	1999.06	MT/AT		Engine CD20TI	GC041024	Outer Joint	42T	27	23	56	103	61.5	M
2.4 4WD	1993.05-	1996.10	MT/AT		Engine KA24DE	GC041023	Outer Joint		27	23	56	103	61.5	M	
		1993.05-	1999.06	MT/AT		Engine KA24DE	GC041024	Outer Joint	42T	27	23	56	103	61.5	M
<b>LATIO (JY12)</b>															
1.8	2005.01-		MT/AT			GC041308	Outer Joint		25	23	49	95	56.5	M	
<b>LATIO (ZE11)</b>															
1.6	2005.01-		4AT		Engine HR16DE	GC041302	Outer Joint		25	22	49	95	56	M	
		2005.01-	5MT		Engine HR16DE	GC041302	Outer Joint		25	22	49	95	56	M	
<b>LAUREL</b>															
1.6	1990-			R	B13 GA13 GA16DE GA16DS	GCI41002	Inner Joint		25	23	40	63	101		
<b>LAUREL SPIRIT (B11)</b>															
1.5	1982.01-	1986.08	MT/AT		Engine E15S E	GC041041	Outer Joint		24	22	52	105	56	M	
<b>LAUREL SPIRIT (B12)</b>															
1.5	1986.08-	1987.09	MT		Engine E15E	GC041039	Outer Joint		25	22	52.3	107.4	55.7	M	
		1986.08-	1990.03	MT/AT		Engine E15S/GA15S E	GC041039	Outer Joint		25	22	52.3	107.4	55.7	M
		1986.08-	1987.09	AT		Engine E15E	GC099204	Outer Joint		25	25	52.3	106.5	62	M
		1987.09-	1990.03	4AT		Engine GA15S E	GC041039	Outer Joint		25	22	52.3	107.4	55.7	M
1.5 4WD	1987.09-	1990.03	MT/AT		Engine GA15S E	GC041023	Outer Joint		27	23	56	103	61.5	M	
<b>LAUREL SPIRIT (EB12)</b>															
1.6	1986.08-	1990.03	MT&AT		Engine CA16D	GC099204	Outer Joint		25	25	52.3	106.5	62	M	
<b>LAUREL SPIRIT (SB11)</b>															
1.7	1983.11-	1986.08	MT&AT		Engine CD17	GC041041	Outer Joint		24	22	52	105	56	M	
<b>LAUREL SPIRIT (SB12)</b>															
1.7	1986.08-	1990.03	MT		Engine CD17	GC041039	Outer Joint		25	22	52.3	107.4	55.7	M	
<b>MARCH (K11)</b>															
-				R	CG10	GC041090	Outer Joint		23	19	48	93	53.5	M	
<b>MARCH / MICRA (HK11)</b>															
1.3	1992.01-		AT		Engine CG13DE	GC041119	Outer Joint		23	22	48	92.5	56.5	M	
		1992.01-	1999.05	MT/AT/CVT		Engine CG13DE	GC041119	Outer Joint		23	22	48	92.5	56.5	M
		1992.01-	1995.12	MT/CVT		Engine CG13DE	GC041119	Outer Joint		23	22	48	92.5	56.5	M
		1992.01-	1997.05	MT/AT/CVT		Engine CG13DE	GC041156	Outer Joint	42T	23	22	48	92.5	56.5	M
		1992.01-	1995.12	MT/AT		Engine CG13DE	GC041156	Outer Joint	42T	23	22	48	92.5	56.5	M
		1992.01-		MT/CVT		Engine CG13DE	GC041156	Outer Joint	42T	23	22	48	92.5	56.5	M
<b>MARCH / MICRA (K11)</b>															
1.0	1992.01-		CVT		Engine CG10DE	GC041114	Outer Joint		23	19	48	93	53.5	M	
		1992.01-	1999.11	5MT		Engine CG10DE	GC041154	Outer Joint	42T	23	19	48	93	53.5	M
		1992.01-	1995.12	AT		Engine CG10DE	GC041154	Outer Joint	42T	23	19	48	93	53.5	M
		1992.01-	1999.11	CVT		Engine CG10DE	GC041154	Outer Joint	42T	23	19	48	93	53.5	M
		1992.01-		MT		Engine CG10DE	GC041154	Outer Joint	42T	23	19	48	93	53.5	M
		1992.01-	1999.05	MT/AT/CVT		Engine CG10DE	GC041119	Outer Joint		23	22	48	92.5	56.5	M
		1992.01-	1997.05	MT/AT/CVT		Engine CG10DE	GC041156	Outer Joint	42T	23	22	48	92.5	56.5	M
		1992.01-		4AT		Engine CG10DE	GC041114	Outer Joint		23	19	48	93	53.5	M
		1992.01-	1997.05	5MT		Engine CG10DE	GC041114	Outer Joint		23	19	48	93	53.5	M
		1992.01-	1995.12	MT&AT		Engine CG10DE	GC041114	Outer Joint		23	19	48	93	53.5	M



		TRANSM	L/R	F/R		G-AP Ref.	PRODUCT	ABS	Technical Specifications					
									YEAR	A	B	C	H	L
<b>NISSAN</b>														
<b>MARCH / MICRA (K12)</b>														
1.0	2002.02-2003.07	4AT			Engine CR10DE	GC041188	Outer Joint		25	22	49	95	56	M
	2002.02-	4AT/F			Engine CR10DE	GC041188	Outer Joint		25	22	49	95	56	M
1.2	2002.02-	4AT			Engine CR12DE	GC041188	Outer Joint		25	22	49	95	56	M
	2002.02-	4AT/F			Engine CR12DE	GC041188	Outer Joint		25	22	49	95	56	M
	2002.02-	5MT/F			Engine CR12DE	GC041188	Outer Joint		25	22	49	95	56	M
1.4	2002.02-	4AT			Engine CR14DE	GC041188	Outer Joint		25	22	49	95	56	M
	2002.02-	4AT/F			Engine CR14DE	GC041188	Outer Joint		25	22	49	95	56	M
1.4 4WD	2002.02-	4AT/F			Engine CR14DE	GC041188	Outer Joint		25	22	49	95	56	M
	2002.09-	4AT			Engine CR14DE	GC041188	Outer Joint		25	22	49	95	56	M
<b>MAXIMA</b>														
-	1992-1994					GC041149	Outer Joint	46T	29	27	56	103.5	71	I
	1992-1999					GCI41008	Inner Joint		29/31	27	46	86.8	124	
	1992-1994					GC041089	Outer Joint		29	27	56	103.5	71	I
2.0	2007-					GC041101	Outer Joint		29	25	56	103.5	70.5	I
3.0	2007-					GC041101	Outer Joint		29	25	56	103.5	70.5	I
<b>MAXIMA (J30)</b>														
3.0	1988.01-	MT/AT			Engine VG30E	GC041035	Outer Joint		27	25	56	101	70	M
	1989-1991				Engine VG30E	GC041075	Outer Joint		27	25	56	103	70.5	I
	1991.08-1994.02	AT			Engine VE30DE	GC041035	Outer Joint		27	25	56	101	70	M
<b>MAXIMA II (J30)</b>														
3.0 i (125 kW)	1988.10-1994.06	MT		F	Saloon Engine VG30E	GC099056	Outer Joint	46T	27	25	56	103	70.5	I
	1988.10-1994.06			F	Saloon Engine VG30E	GC041151	Outer Joint	46T	27	25	56	103	68	I
	1988.10-1994.06			F	Saloon Engine VG30E	GC041011	Outer Joint		27	25	56	103	66	I
<b>MAXIMA QX (A32)</b>														
2.0 (103 kW)	1995.02-2000.08	MT/AT		F	Saloon Engine VQ20DE	GC041021	Outer Joint		29	27	56	103.5	70.5	I
2.5 V6 24V (140 kW)	1995.02-2000.08	AT		F	Saloon Engine VQ25DE	GC041021	Outer Joint		29	27	56	103.5	70.5	I
3.0 (142 kW)	1995.01-2000.08	AT		F	Saloon Engine VQ30DE	GC041021	Outer Joint		29	27	56	103.5	70.5	I
<b>MAXIMA QX (A33)</b>														
2.0 V6 24V (103 kW)	2000.03-2003.11			F	Saloon Engine VQ20DE	GC041022	Outer Joint	46T	29	27	56	103.5	70.5	I
	2000.03-2003.11			F	Saloon Engine VQ20DE	GC041152	Outer Joint	44T	29	27	56	103.5	70.5	I
	2000.03-2003.11	MT		F	Saloon Engine VQ20DE	GC041037	Outer Joint	44T	29	25	56	103.5	70.5	I
	2000.03-2003.11	MT/AT	L/R	F	Saloon Engine VQ20DE	GC041314	Outer Joint	46T	29	27	56	101	68	M
	2000.03-2003.11			F	Saloon Engine VQ20DE	GC041185	Outer Joint	44T	29	25	56	101	68	M
2.5 V6 24V (154 kW)	2000.03-2003.11			F	Saloon Engine VQ25DE	GC041022	Outer Joint	46T	29	27	56	103.5	70.5	I
	2000.03-2003.11			F	Saloon Engine VQ25DE	GC041152	Outer Joint	44T	29	27	56	103.5	70.5	I
3.0 V6 24V (147 kW)	2000.03-2003.11			F	Saloon Engine VQ30DE	GC041022	Outer Joint	46T	29	27	56	103.5	70.5	I
	2000.03-2003.11			F	Saloon Engine VQ30DE	GC041037	Outer Joint	44T	29	25	56	103.5	70.5	I
	2000.03-2003.11			F	Saloon Engine VQ30DE	GC041152	Outer Joint	44T	29	27	56	103.5	70.5	I
	2000.03-2003.11			F	Saloon Engine VQ30DE	GC041185	Outer Joint	44T	29	25	56	101	68	M
<b>MAXIMA STATION WAGON</b>														
2.0 QX (103 kW)	1997.10-	MT/AT		F	Estate Engine VQ20DE	GC041021	Outer Joint		29	27	56	103.5	70.5	I
2.5 V6 24V (140 kW)	1997.10-	MT/AT		F	Estate Engine VQ25DE	GC041021	Outer Joint		29	27	56	103.5	70.5	I
3.0 QX (142 kW)	1997.10-	MT/AT		F	Estate Engine VQ30DE	GC041021	Outer Joint		29	27	56	103.5	70.5	I
<b>MICRA / MARCH (K12)</b>														
-	2002-					GCI59036	Inner Joint		26	22	40	64.5	98	
<b>MICRA C+C (K12)</b>														
-	2005-					GCI59036	Inner Joint		26	22	40	64.5	98	
1.4 16V (65 kW)	2005.08-			F	Convertible Engine CR14DE	GC041046	Outer Joint		23	21	49	83.5	56	M
	2005.08-	AT	L	F	Convertible Engine CR14DE	GDS41260	Drive Shaft		23	25	49	83.5	654	
	2005.08-	MT	L	F	Convertible Engine CR14DE	GDS41204	Drive Shaft		23	26	49	83.5	655	
	2005.08-	AT	R	F	Convertible Engine CR14DE	GDS41261	Drive Shaft		23	25	49	83.5	883	
	2005.08-	MT	R	F	Convertible Engine CR14DE	GDS41200	Drive Shaft		23	26	49	83.5	892	
1.6 160 SR (81 kW)	2005.08-			F	Convertible Engine HR16DE	GC041047	Outer Joint		23	22	49	83.5	56	M
	2005.08-	AT	L	F	Convertible Engine HR16DE	GDS41260	Drive Shaft		23	25	49	83.5	654	
	2005.08-	MT	L	F	Convertible Engine HR16DE	GDS41204	Drive Shaft		23	26	49	83.5	655	
	2005.08-			L	Convertible Engine HR16DE	GDS41451	Drive Shaft		23	26	49	83.5	642	
	2005.08-			L	Convertible Engine HR16DE	GCI41102	Inner Joint		26	21	40	64.5	95.5	
	2005.08-			L	Convertible Engine HR16DE	GC041340	Outer Joint		23	22	49	83.5	59	M
	2005.08-	AT	R	F	Convertible Engine HR16DE	GDS41261	Drive Shaft		23	25	49	83.5	883	
	2005.08-	MT	R	F	Convertible Engine HR16DE	GDS41200	Drive Shaft		23	26	49	83.5	892	
	2005.08-			R	Convertible Engine HR16DE	GDS41463	Drive Shaft		23	26	49	83.5	894	

		TRANSM	L/R	F/R		G-AP Ref.	PRODUCT	ABS	Technical Specifications						
									YEAR	A	B	C	H	L	P
<b>NISSAN</b>															
<b>MICRA I (K10)</b>															
1.0 (37 kW)	1982.12-	1989.12	MT/AT		F	Hatchback Engine MA10S	GCO41172	Outer Joint		21	19	48	94	53	I
	1982.12-	1989.12			F	Hatchback Engine MA10S	GCO41031	Outer Joint		23	19	48	93	53.5	I
1.0 (40 kW)	1982.12-	1989.05	MT/AT		F	Hatchback Engine MA10S	GCO41172	Outer Joint		21	19	48	94	53	I
	1982.12-	1989.05			F	Hatchback Engine MA10S	GCO41031	Outer Joint		23	19	48	93	53.5	I
1.2 (40 kW)	1986.07-	1992.07	MT		F	Hatchback Engine MA12S	GCO41172	Outer Joint		21	19	48	94	53	I
	1986.07-	1992.07			F	Hatchback Engine MA12S	GCO41031	Outer Joint		23	19	48	93	53.5	I
1.2 (44 kW)	1986.07-	1992.07	MT		F	Hatchback Engine MA12S	GCO41172	Outer Joint		21	19	48	94	53	I
	1986.07-	1992.07			F	Hatchback Engine MA12S	GCO41031	Outer Joint		23	19	48	93	53.5	I
<b>MICRA II (K11)</b>															
1.0 i 16V (40 kW)	1992.08-	2000.09			L	F	Hatchback Engine CG10DE	GDS41083	Drive Shaft		23	21	48	93	608.5
	1992.08-	2000.09			R	F	Hatchback Engine CG10DE	GDS41084	Drive Shaft		23	21	48	93	822.5
	1992.08-	2003.02	MT/AT				GCO41040	Outer Joint		23	19	48	93	53.5	I
1.0 i 16V (44 kW)	1992.08-	2003.02	MT/AT				GCO41040	Outer Joint		23	19	48	93	53.5	I
	2000.09-	2003.02			F	Hatchback Engine CG10DE	GCO41020	Outer Joint	42T	23	19	48	93	53.5	M
	2000.09-	2003.02	MT/AT		F	Hatchback Engine CG10DE	GCO41058	Outer Joint	42T	23	19	48	93	53.5	I
	2000.09-	2003.02	MT	L	F	Hatchback Engine CG10DE	GDS41023	Drive Shaft		23	21	48	93	612	
	2000.09-	2003.02				Hatchback Engine CG10DE	GCO41090	Outer Joint		23	19	48	93	53.5	M
1.3 i 16V (55 kW)	1992.08-	2000.09			F	Hatchback Engine CG13DE	GCI41045	Inner Joint		24	22	40	51.5	97	
	1992.08-	2000.09			L	F	Hatchback Engine CG13DE	GDS41156	Drive Shaft		23	24	48	93	594.5
	1992.08-	2000.09			R	F	Hatchback Engine CG13DE	GDS41193	Drive Shaft		23	24	48	93	840
1.5 D (42 kW)	1998.02-	2003.02			F	Hatchback Engine TD15	GCO41012	Outer Joint		23	22	48	93	56.5	I
	1998.02-	2003.02	MT/AT		F	Hatchback Engine TD15	GCO41013	Outer Joint	42T	23	22	48	93	56.5	I
<b>MICRA III</b>															
1.0	1998.04-	2002.12	MT	L	F	K11	GDS41154	Drive Shaft	42T	23	21	48	93	607	
<b>MICRA III (K12)</b>															
1.0 16V (48 kW)	2003.01-	2010.06			F	Hatchback Engine CG10DE	GCO41046	Outer Joint		23	21	49	83.5	56	M
	2003.01-	2010.06			L	F	Hatchback Engine CG10DE	GDS41204	Drive Shaft		23	26	49	83.5	655
	2003.01-	2010.06			R	F	Hatchback Engine CG10DE	GDS41200	Drive Shaft		23	26	49	83.5	892
	2003.01-						GCO41046	Outer Joint		23	21	49	83.5	56	M
1.2 16V (48 kW)	2003.01-						GCO41046	Outer Joint		23	21	49	83.5	56	M
	2007.09-	2010.06			F	Hatchback Engine CG12DE/CR12DE	GCO41046	Outer Joint		23	21	49	83.5	56	M
	2007.09-	2010.06	AT	L	F	Hatchback Engine CG12DE/CR12DE	GDS41260	Drive Shaft		23	25	49	83.5	654	
	2007.09-	2010.06	MT	L	F	Hatchback Engine CG12DE/CR12DE	GDS41204	Drive Shaft		23	26	49	83.5	655	
	2007.09-	2010.06	AT	R	F	Hatchback Engine CG12DE/CR12DE	GDS41261	Drive Shaft		23	25	49	83.5	883	
	2007.09-	2010.06	MT	R	F	Hatchback Engine CG12DE/CR12DE	GDS41200	Drive Shaft		23	26	49	83.5	892	
1.2 16V (59 kW)	2003.01-	2010.06			F	Hatchback Engine CR12DE/CG12DE	GCO41046	Outer Joint		23	21	49	83.5	56	M
	2003.01-	2010.06	AT	L	F	Hatchback Engine CR12DE/CG12DE	GDS41260	Drive Shaft		23	25	49	83.5	654	
	2003.01-	2010.06	MT	L	F	Hatchback Engine CR12DE/CG12DE	GDS41204	Drive Shaft		23	26	49	83.5	655	
	2003.01-	2010.06	AT	R	F	Hatchback Engine CR12DE/CG12DE	GDS41261	Drive Shaft		23	25	49	83.5	883	
	2003.01-	2010.06	MT	R	F	Hatchback Engine CR12DE/CG12DE	GDS41200	Drive Shaft		23	26	49	83.5	892	
	2003.01-						GCO41046	Outer Joint		23	21	49	83.5	56	M
1.4 16V (65 kW)	2003.01-	2007.09			F	Hatchback Engine CR14DE	GCO41046	Outer Joint		23	21	49	83.5	56	M
	2003.01-	2007.09	AT	L	F	Hatchback Engine CR14DE	GDS41260	Drive Shaft		23	25	49	83.5	654	
	2003.01-	2007.09	MT	L	F	Hatchback Engine CR14DE	GDS41204	Drive Shaft		23	26	49	83.5	655	
	2003.01-	2007.09	AT	R	F	Hatchback Engine CR14DE	GDS41261	Drive Shaft		23	25	49	83.5	883	
	2003.01-	2007.09	MT	R	F	Hatchback Engine CR14DE	GDS41200	Drive Shaft		23	26	49	83.5	892	
1.5 DCi (48 kW)	2003.01-	2006.03			F	Hatchback Engine K9K704	GCO41047	Outer Joint		23	22	49	83.5	56	M
	2003.01-	2006.03	MT	L	F	Hatchback Engine K9K704	GDS41204	Drive Shaft		23	26	49	83.5	655	
	2003.01-	2006.03	MT	R	F	Hatchback Engine K9K704	GDS41245	Drive Shaft		23	26	49	83.5	893	
	2003.01-						GCO41047	Outer Joint		23	22	49	83.5	56	M
1.5 DCi (50 kW)	2003.01-						GCO41047	Outer Joint		23	22	49	83.5	56	M
	2005.10-	2006.06			F	Hatchback Engine K9K708	GCO41047	Outer Joint		23	22	49	83.5	56	M
	2005.10-	2006.06	MT	L	F	Hatchback Engine K9K708	GDS41204	Drive Shaft		23	26	49	83.5	655	
1.5 DCi (60 kW)	2005.10-	2006.06	MT	R	F	Hatchback Engine K9K708	GDS41245	Drive Shaft		23	26	49	83.5	893	
	2003.01-						GCO41047	Outer Joint		23	22	49	83.5	56	M
	2003.09-	2010.06			F	Hatchback Engine K9K722	GCO41244	Outer Joint		23	23	49	83.5	59	M
	2003.09-	2010.06			F	Hatchback Engine K9K722	GCO41047	Outer Joint		23	22	49	83.5	56	M
	2003.09-	2010.06			L	F	Hatchback Engine K9K722	GDS41407	Drive Shaft		23	26	49	83.5	646
	2003.09-	2010.06	MT	L	F	Hatchback Engine K9K722	GDS41204	Drive Shaft		23	26	49	83.5	655	
	2003.09-	2010.06			R	F	Hatchback Engine K9K722	GDS41408	Drive Shaft		23	26	49	83.5	897
2003.09-	2010.06	MT	R	F	Hatchback Engine K9K722	GDS41245	Drive Shaft		23	26	49	83.5	893		









		TRANSM	L/R	F/R		G-AP Ref.	PRODUCT	ABS	Technical Specifications								
									YEAR	A	B	C	H	L	P		
<b>NISSAN</b>																	
<b>MICRA III (K12)</b>																	
1.5 DCi (63 kW)	2005.06-	2010.06			F	Hatchback Engine K9K276	GC041244	Outer Joint		23	23	49	83.5	59	M		
	2005.06-	2010.06		L	F	Hatchback Engine K9K276	GDS41407	Drive Shaft		23	26	49	83.5	646			
	2005.06-	2010.06	MT	L	F	Hatchback Engine K9K276	GDS41204	Drive Shaft		23	26	49	83.5	655			
	2005.06-	2010.06		R	F	Hatchback Engine K9K276	GDS41408	Drive Shaft		23	26	49	83.5	897			
	2005.06-	2010.06	MT	R	F	Hatchback Engine K9K276	GDS41245	Drive Shaft		23	26	49	83.5	893			
1.6 16V (81 kW)	2005-						GC041047	Outer Joint		23	22	49	83.5	56	M		
1.6 SR (81 kW)	2005.05-	2007.09			F	Hatchback Engine HR16DE	GC041047	Outer Joint		23	22	49	83.5	56	M		
	2005.05-	2007.09	AT	L	F	Hatchback Engine HR16DE	GDS41260	Drive Shaft		23	25	49	83.5	654			
	2005.05-	2007.09	MT	L	F	Hatchback Engine HR16DE	GDS41204	Drive Shaft		23	26	49	83.5	655			
	2005.05-	2007.09		L	F	Hatchback Engine HR16DE	GDS41451	Drive Shaft		23	26	49	83.5	642			
	2005.05-	2007.09		L	F	Hatchback Engine HR16DE	GCI41102	Inner Joint		26	21	40	64.5	95.5			
	2005.05-	2007.09		L	F	Hatchback Engine HR16DE	GC041340	Outer Joint		23	22	49	83.5	59	M		
	2005.05-	2007.09	AT	R	F	Hatchback Engine HR16DE	GDS41261	Drive Shaft		23	25	49	83.5	883			
	2005.05-	2007.09	MT	R	F	Hatchback Engine HR16DE	GDS41200	Drive Shaft		23	26	49	83.5	892			
2005.05-	2007.09		R	F	Hatchback Engine HR16DE	GDS41463	Drive Shaft		23	26	49	83.5	894				
<b>MICRA III C+C (K12)</b>																	
1.4 16V (65 kW)	2003.01-						GC041046	Outer Joint		23	21	49	83.5	56	M		
1.6 160 SR (81 kW)	2005.08-						GC041047	Outer Joint		23	22	49	83.5	56	M		
<b>MICRA IV (K13)</b>																	
1.2 (56 kW)	2010.05-		MT	L	F	Hatchback Engine HR12DE	GDS41437	Drive Shaft		25	26	49	95	689			
	2010.05-			L	F	Hatchback Engine HR12DE	GDS41337	Drive Shaft		25	25	49.1	94.5	699			
	2010.05-		AT			Hatchback Engine HR12DE	GC041289	Outer Joint		25	29	49.1	94.5	53	I		
1.2 (59 kW)	2010.05-		MT	L	F	Hatchback Engine HR12DE	GDS41437	Drive Shaft		25	26	49	95	689			
	2010.05-			L	F	Hatchback Engine HR12DE	GDS41337	Drive Shaft		25	25	49.1	94.5	699			
	2010.05-		AT			Hatchback Engine HR12DE	GC041289	Outer Joint		25	29	49.1	94.5	53	I		
1.2 DiG (72 kW)	2011.04-		MT	L	F	Hatchback Engine HR12DDR	GDS41437	Drive Shaft		25	26	49	95	689			
	2011.04-			L	F	Hatchback Engine HR12DDR	GDS41337	Drive Shaft		25	25	49.1	94.5	699			
	2011.04-		AT			Hatchback Engine HR12DDR	GC041289	Outer Joint		25	29	49.1	94.5	53	I		
<b>MIERA II (K11)</b>																	
1.0 i 16V (40 kW)	1992.08-	2003.02	MT/AT				GC041058	Outer Joint	42T	23	19	48	93	53.5	I		
1.0 i 16V (44 kW)	1992.08-	2003.02	MT/AT				GC041058	Outer Joint	42T	23	19	48	93	53.5	I		
<b>MISTRAL / TERRANO II (R20)</b>																	
2.7	1994.06-	1996.10	AT			Engine TD27T	GC041085	Outer Joint		26	27	50	148	60	M		
<b>MURANO (KWZ50)</b>																	
3.5	2004.09-		CVT/F			Engine VQ35DE	GC041245	Outer Joint		29	36	56	102	69.5	I		
3.5 4WD	2004.09-		CVT/F			Engine VQ35DE	GC041245	Outer Joint		29	36	56	102	69.5	I		
<b>MURANO (Z50)</b>																	
3.5 4x4 (172 kW)	2004.10-	2007.04				Closed Off-Road Vehicle	GC041232	Outer Joint		29	36	56	102.5	70	I		
<b>MURANO (Z51)</b>																	
3.5 4x4 (188 kW)	2008.10-					Closed Off-Road Vehicle Engine VQ35DE	GC041232	Outer Joint		29	36	56	102.5	70	I		
<b>NAVARA (D40)</b>																	
2.5 DCi (106 kW)	2005.07-		MT		R	Pickup Engine YD25DDTi	GC041231	Outer Joint		29	36	68	122.5	60	M		
2.5 DCi (140 kW)	2010.03-			L/R	F	Platform/Chassis Engine YD25DDTi	GDS41262	Drive Shaft		29	27	67	115	634			
2.5 DCi 4WD (126 kW)	2006.10-		AT			Pickup Engine YD25DDTi	GC041257	Outer Joint		29	26	67	115.5	62	M		
	2006.10-		MT			Pickup Engine YD25DDTi	GC041231	Outer Joint		29	36	68	122.5	60	M		
	2006.10-		MT	L/R		Pickup Engine YD25DDTi	GDS41262	Drive Shaft		29	27	67	115	634			
	2006.10-		MT		F	Pickup Engine YD25DDTi	GC041240	Outer Joint		29	27	67	115	63	M		
2.5 DCi 4WD (128 kW)	2005.07-		AT			Pickup Engine YD25DDTi	GC041257	Outer Joint		29	26	67	115.5	62	M		
	2005.07-		MT			Pickup Engine YD25DDTi	GC041231	Outer Joint		29	36	68	122.5	60	M		
	2005.07-		MT	L/R		Pickup Engine YD25DDTi	GDS41262	Drive Shaft		29	27	67	115	634			
	2005.07-		MT		F	Pickup Engine YD25DDTi	GC041240	Outer Joint		29	27	67	115	63	M		
2.5 DCi 4WD (140 kW)	2009.12-		AT			Pickup Engine YD25DDTi	GC041257	Outer Joint		29	26	67	115.5	62	M		
	2009.12-		MT	L/R		Pickup Engine YD25DDTi	GDS41262	Drive Shaft		29	27	67	115	634			
<b>NOTE (E11)</b>																	
-	2005-						GCI59036	Inner Joint		26	22	40	64.5	98			
1.4 (65 kW)	2006.03-	2007.12	AT	L	F	MPV Engine CR14DE	GC041340	Outer Joint		23	22	49	83.5	59	M		
	2006.03-	2007.12	MT	L	F	MPV Engine CR14DE	GDS41204	Drive Shaft		23	26	49	83.5	655			
	2006.03-	2007.12	MT	R	F	MPV Engine CR14DE	GDS41200	Drive Shaft		23	26	49	83.5	892			
	2006.03-	2007.12			F	MPV Engine CR14DE	GC041047	Outer Joint		23	22	49	83.5	56	M		
	2006.03-	2007.12	AT	L	F	MPV Engine CR14DE	GDS41451	Drive Shaft		23	26	49	83.5	642			
	2006.03-	2007.12	AT	L	F	MPV Engine CR14DE	GCI41102	Inner Joint		26	21	40	64.5	95.5			



		TRANSM	L/R	F/R		G-AP Ref.	PRODUCT	ABS	Technical Specifications						
									YEAR	A	B	C	H	L	P
<b>NISSAN</b>															
<b>NOTE (E11)</b>															
1.5 DCi (50 kW)	2006.03-	2007.12			F	MPV Engine K9K700	GC041244	Outer Joint	23	23	49	83.5	59	M	
	2006.03-	2007.12	5MT	L	F	MPV Engine K9K700	GDS41407	Drive Shaft	23	26	49	83.5	646		
	2006.03-	2007.12	6MT	L	F	MPV Engine K9K700	GDS41453	Drive Shaft	23	26	49	83.5	645		
	2006.03-	2007.12	6MT	L	F	MPV Engine K9K700	GCI41143	Inner Joint	26	24	40	64	106		
	2006.03-	2007.12	MT	L	F	MPV Engine K9K700	GDS41204	Drive Shaft	23	26	49	83.5	655		
	2006.03-	2007.12	5MT	R	F	MPV Engine K9K700	GDS41408	Drive Shaft	23	26	49	83.5	897		
	2006.03-	2007.12	6MT	R	F	MPV Engine K9K700	GDS41452	Drive Shaft	23	26	49	83.5	895		
	2006.03-	2007.12	6MT	R	F	MPV Engine K9K700	GCI41142	Inner Joint	26	24	33	327	93		
	2006.03-	2007.12	6MT	R	F	MPV Engine K9K700	GC041341	Outer Joint	23	24	49	83.5	63	M	
2006.03-	2007.12	MT	R	F	MPV Engine K9K700	GDS41245	Drive Shaft	23	26	49	83.5	893			
1.5 DCi (63 kW)	2008.05-				F	MPV Engine K9K276	GC041244	Outer Joint	23	23	49	83.5	59	M	
	2008.05-		5MT	L	F	MPV Engine K9K276	GDS41407	Drive Shaft	23	26	49	83.5	646		
	2008.05-		5MT	R	F	MPV Engine K9K276	GDS41408	Drive Shaft	23	26	49	83.5	897		
	2008.05-		6MT	L	F	MPV Engine K9K276	GDS41453	Drive Shaft	23	26	49	83.5	645		
	2008.05-		6MT	L	F	MPV Engine K9K276	GCI41143	Inner Joint	26	24	40	64	106		
	2008.05-		MT	L	F	MPV Engine K9K276	GDS41204	Drive Shaft	23	26	49	83.5	655		
	2008.05-		6MT	R	F	MPV Engine K9K276	GDS41452	Drive Shaft	23	26	49	83.5	895		
	2008.05-		6MT	R	F	MPV Engine K9K276	GCI41142	Inner Joint	26	24	33	327	93		
	2008.05-		6MT	R	F	MPV Engine K9K276	GC041341	Outer Joint	23	24	49	83.5	63	M	
2008.05-		MT	R	F	MPV Engine K9K276	GDS41245	Drive Shaft	23	26	49	83.5	893			
1.5 DCi (66 kW)	2010.09-				F	MPV Engine K9K276	GDS41407	Drive Shaft	23	26	49	83.5	646		
	2010.09-				R	MPV Engine K9K276	GDS41408	Drive Shaft	23	26	49	83.5	897		
	2010.09-		MT	L	F	MPV Engine K9K276	GDS41204	Drive Shaft	23	26	49	83.5	655		
	2010.09-		MT	R	F	MPV Engine K9K276	GDS41245	Drive Shaft	23	26	49	83.5	893		
1.5 DCi (76 kW)	2008.07-				F	MPV Engine K9K292	GC041244	Outer Joint	23	23	49	83.5	59	M	
	2008.07-		5MT	L	F	MPV Engine K9K292	GDS41407	Drive Shaft	23	26	49	83.5	646		
	2008.07-		5MT	R	F	MPV Engine K9K292	GDS41408	Drive Shaft	23	26	49	83.5	897		
	2008.07-		6MT	L	F	MPV Engine K9K292	GDS41453	Drive Shaft	23	26	49	83.5	645		
	2008.07-		6MT	L	F	MPV Engine K9K292	GCI41143	Inner Joint	26	24	40	64	106		
	2008.07-		MT	L	F	MPV Engine K9K292	GDS41204	Drive Shaft	23	26	49	83.5	655		
	2008.07-		6MT	R	F	MPV Engine K9K292	GDS41452	Drive Shaft	23	26	49	83.5	895		
	2008.07-		6MT	R	F	MPV Engine K9K292	GCI41142	Inner Joint	26	24	33	327	93		
	2008.07-		6MT	R	F	MPV Engine K9K292	GC041341	Outer Joint	23	24	49	83.5	63	M	
2008.07-		MT	R	F	MPV Engine K9K292	GDS41245	Drive Shaft	23	26	49	83.5	893			
1.6 (81 kW)	2006.03-	2007.12			F	MPV Engine HR16DE	GC041047	Outer Joint	23	22	49	83.5	56	M	
	2006.03-	2007.12	AT	L	F	MPV Engine HR16DE	GDS41451	Drive Shaft	23	26	49	83.5	642		
	2006.03-	2007.12	AT	L	F	MPV Engine HR16DE	GCI41102	Inner Joint	26	21	40	64.5	95.5		
	2006.03-	2007.12	AT	L	F	MPV Engine HR16DE	GC041340	Outer Joint	23	22	49	83.5	59	M	
	2006.03-	2007.12	AT	L	F	MPV Engine HR16DE	GDS41409	Drive Shaft	23	25	49	83.5	647		
	2006.03-	2007.12	MT	L	F	MPV Engine HR16DE	GDS41204	Drive Shaft	23	26	49	83.5	655		
	2006.03-	2007.12	AT	R	F	MPV Engine HR16DE	GDS41261	Drive Shaft	23	25	49	83.5	883		
	2006.03-	2007.12	MT	R	F	MPV Engine HR16DE	GDS41200	Drive Shaft	23	26	49	83.5	892		
<b>NOTE (E11E)</b>															
1.4 16V (65 kW)	2006.03-						GC041047	Outer Joint	23	22	49	83.5	56	M	
1.6 16V (81 kW)	2006.08-						GC041047	Outer Joint	23	22	49	83.5	56	M	
<b>NOTE (E12)</b>															
1.2 (59 kW)	2013.06-		MT	L	F	Hatchback Engine HR12DE	GDS41437	Drive Shaft	25	26	49	95	689		
<b>NP300</b>															
2.5 DCi (98 kW)	2008.04-					Pickup Engine YD25DDTi	GC041100	Outer Joint	28	25	50	150	71	I	
2.5 DCi 4x4 (98 kW)	2008.04-					Pickup Engine YD25DDTi	GC041100	Outer Joint	28	25	50	150	71	I	
<b>NV200</b>															
1.5 DCi (63 kW)	2010.02-		MT	R	F	Box Engine K9K400/K9K608/K9K628	GDS41466	Drive Shaft	29	26	56.2	102	914		
1.5 DCi (66 kW)	2011.04-		MT	R	F	Box Engine K9K 892	GDS41466	Drive Shaft	29	26	56.2	102	914		
<b>NV200 EVALIA</b>															
1.5 DCi (63 kW)	2010.07-		MT	R	F	Bus	GDS41466	Drive Shaft	29	26	56.2	102	914		
1.5 DCi (66 kW)	2011.04-		MT	R	F	Bus Engine K9K892	GDS41466	Drive Shaft	29	26	56.2	102	914		
<b>NV400</b>															
2.3 DCi (107 kW)	2011.11-				R	F	Box Engine M9T678/M9T680	GDS18248	Drive Shaft	31	39	70	100.5	1075	
	2011.11-				R	F	Box Engine M9T678/M9T680	GCI50046	Inner Joint	39	27	30	364	87	
	2011.11-				R	F	Box Engine M9T694/M9T696/M9T698	GDS18248	Drive Shaft	31	39	70	100.5	1075	
	2011.11-				R	F	Box Engine M9T694/M9T696/M9T698	GCI50046	Inner Joint	39	27	30	364	87	
	2011.11-				R	F	Bus Engine M9T678/M9T680	GDS18248	Drive Shaft	31	39	70	100.5	1075	

		YEAR	TRANSM	L/R	F/R		G-AP Ref.	PRODUCT	ABS	Technical Specifications										
										A	B	C	H	L	P					
<b>NISSAN NV400</b>																				
2.3 DCi (107 kW)	2011.11-				R	F	Bus Engine M9T678/M9T680	GCI50046	Inner Joint		39	27	30	364	87					
	2011.11-				R	F	Platform/Chassis Engine M9T678/M9T680	GDS18248	Drive Shaft		31	39	70	100.5	1075					
	2011.11-				R	F	Platform/Chassis Engine M9T678/M9T680	GCI50046	Inner Joint		39	27	30	364	87					
	2011.11-				R	F	Platform/Chassis Engine M9T694/M9T696/M9T698	GDS18248	Drive Shaft		31	39	70	100.5	1075					
	2011.11-				R	F	Platform/Chassis Engine M9T694/M9T696/M9T698	GCI50046	Inner Joint		39	27	30	364	87					
2.3 DCi (74 kW)	2011.11-				R	F	Box Engine M9T670/M9T672/M9T676	GDS18248	Drive Shaft		31	39	70	100.5	1075					
	2011.11-				R	F	Box Engine M9T670/M9T672/M9T676	GCI50046	Inner Joint		39	27	30	364	87					
	2011.11-				R	F	Bus Engine M9T670/M9T672/M9T676	GDS18248	Drive Shaft		31	39	70	100.5	1075					
	2011.11-				R	F	Bus Engine M9T670/M9T672/M9T676	GCI50046	Inner Joint		39	27	30	364	87					
	2011.11-				R	F	Platform/Chassis Engine M9T670/M9T672/M9T676	GDS18248	Drive Shaft		31	39	70	100.5	1075					
2.3 DCi (92 kW)	2011.11-				R	F	Box Engine M9T670/M9T672/M9T676	GDS18248	Drive Shaft		31	39	70	100.5	1075					
	2011.11-				R	F	Box Engine M9T670/M9T672/M9T676	GCI50046	Inner Joint		39	27	30	364	87					
	2011.11-				R	F	Box Engine M9T686/M9T690/M9T692/M9T696/M9T698	GDS18248	Drive Shaft		31	39	70	100.5	1075					
	2011.11-				R	F	Box Engine M9T686/M9T690/M9T692/M9T696/M9T698	GCI50046	Inner Joint		39	27	30	364	87					
	2011.11-				R	F	Bus Engine M9T670/M9T672/M9T676	GDS18248	Drive Shaft		31	39	70	100.5	1075					
	2011.11-				R	F	Bus Engine M9T670/M9T672/M9T676	GCI50046	Inner Joint		39	27	30	364	87					
	2011.11-				R	F	Platform/Chassis Engine M9T670/M9T672/M9T676	GDS18248	Drive Shaft		31	39	70	100.5	1075					
	2011.11-				R	F	Platform/Chassis Engine M9T670/M9T672/M9T676	GCI50046	Inner Joint		39	27	30	364	87					
<b>NX COUPE</b>																				
1.6	1990-				R		B13 GA13 GA16DE GA16DS	GCI41002	Inner Joint		25	23	40	63	101					
<b>NX COUPE (EB13)</b>																				
1.6	1990.01-	1993.12	MT&AT				Engine GA16DE	GC041033	Outer Joint		25	23	55	107	61	I				
	1990.01-	1993.12	MT&AT				Engine GA16DE	GC041034	Outer Joint	42T	25	23	55	107	61	I				
<b>NX COUPE (FB13)</b>																				
1.5	1990.01-	1993.12	MT&AT				Engine GA15DS	GC034024	Outer Joint		25	22	55	107	57	M				
	1990.01-	1993.12	MT&AT				Engine GA15DS	GC041191	Outer Joint	42T	25	22	55	107	57	M				
<b>PATHFINDER</b>																				
-	1996-	2004					SUV/Truck/VAN 4WD	GCI41014	Inner Joint			27		81.2						
	2005-						R51M	GC041257	Outer Joint		29	26	67	115.5	62	M				
<b>PATHFINDER (R50)</b>																				
2.7 TD 4WD (96 kW)	1997.09-	2004.12				F	Closed Off-Road Vehicle Engine TD27ETi	GC041016	Outer Joint		28	27	50	150	71	I				
3.2 TD 4WD (110 kW)	1997.09-	2004.12				F	Closed Off-Road Vehicle Engine QD32ETi	GC041016	Outer Joint		28	27	50	150	71	I				
3.3 V6 4WD (125 kW)	1997.09-	2004.12				F	Closed Off-Road Vehicle Engine VG33E	GC041016	Outer Joint		28	27	50	150	71	I				
3.5 V6 4WD (162 kW)	2000.11-	2004.12				F	Closed Off-Road Vehicle Engine VQ35	GC041016	Outer Joint		28	27	50	150	71	I				
<b>PATHFINDER (R51)</b>																				
2.5 DCi 4WD (120 kW)	2005.01-		MT	L/R			Closed Off-Road Vehicle Engine YD25DDTi	GDS41262	Drive Shaft		29	27	67	115	634					
2.5 DCi 4WD (126 kW)	2006.09-	2007.12	AT				Closed Off-Road Vehicle Engine YD25DDTi	GC041257	Outer Joint		29	26	67	115.5	62	M				
	2006.09-	2007.12	MT	L/R			Closed Off-Road Vehicle Engine YD25DDTi	GDS41262	Drive Shaft		29	27	67	115	634					
	2006.09-	2007.12	MT		F		Closed Off-Road Vehicle Engine YD25DDTi	GC041240	Outer Joint		29	27	67	115	63	M				
2.5 DCi 4WD (128 kW)	2005.02-	2006.12	AT				Closed Off-Road Vehicle Engine YD25DDTi	GC041257	Outer Joint		29	26	67	115.5	62	M				
	2005.02-	2006.12	MT	L/R			Closed Off-Road Vehicle Engine YD25DDTi	GDS41262	Drive Shaft		29	27	67	115	634					
	2005.02-	2006.12	MT		F		Closed Off-Road Vehicle Engine YD25DDTi	GC041240	Outer Joint		29	27	67	115	63	M				
2.5 DCi 4WD (140 kW)	2010.08-		AT				Closed Off-Road Vehicle Engine YD25DDTi	GC041257	Outer Joint		29	26	67	115.5	62	M				
	2010.08-		MT	L/R			Closed Off-Road Vehicle Engine YD25DDTi	GDS41262	Drive Shaft		29	27	67	115	634					
<b>PATROL GR (Y60, GR)</b>																				
2.8 TD (85 kW)	1988.09-	1997.06	MT			F	Closed Off-Road Vehicle Engine RD28T	GC041026	Outer Joint		31	27	60	160.5	57	M				
4.2 CAT (121 kW)	1988.11-	1998.02	MT			F	Closed Off-Road Vehicle Engine TB42E	GC041026	Outer Joint		31	27	60	160.5	57	M				
4.2 D (85 kW)	1988.11-	1997.06	MT			F	Closed Off-Road Vehicle Engine TD42	GC041026	Outer Joint		31	27	60	160.5	57	M				
<b>PATROL GR II (Y61)</b>																				
3.0 DTi (118 kW)	2006.08-	2007.12			L	F	Closed Off-Road Vehicle Engine ZD30DDTi	GDS41221	Drive Shaft		31		60	162.5	1115					
	2006.08-	2007.12			R	F	Closed Off-Road Vehicle Engine ZD30DDTi	GDS41179	Drive Shaft		31		60	162.5	617					
<b>PATROL HARDTOP (K160)</b>																				
2.8 (88 kW)	1980.07-	1988.08					Closed Off-Road Vehicle Engine L28	GC041241	Outer Joint		29	27	35	158	57	I				
2.8 (89 kW)	1980.07-	1988.08					Closed Off-Road Vehicle Engine L28	GC041241	Outer Joint		29	27	35	158	57	I				
3.2 D (70 kW)	1979.11-	1988.08					Closed Off-Road Vehicle Engine SD33	GC041241	Outer Joint		29	27	35	158	57	I				
3.2 TD (81 kW)	1983.07-	1988.08					Closed Off-Road Vehicle Engine SD33T	GC041241	Outer Joint		29	27	35	158	57	I				
<b>PATROL HARDTOP (K260)</b>																				
2.8 (88 kW)	1986.05-	1990.06					Closed Off-Road Vehicle Engine L28	GC041241	Outer Joint		29	27	35	158	57	I				
2.8 TD (85 kW)	1986.05-	1990.06	MT			F	Closed Off-Road Vehicle Engine RD28T	GC041026	Outer Joint		31	27	60	160.5	57	M				









		TRANSM	L/R	F/R		G-AP Ref.	PRODUCT	ABS	Technical Specifications									
									YEAR	A	B	C	H	L	P			
<b>NISSAN</b>																		
<b>PATROL HARDTOP (K260)</b>																		
3.2 D (81 kW)	1988.08-	1990.06				Closed Off-Road Vehicle Engine SD33T	GC041241	Outer Joint		29	27	35	158	57	I			
<b>PATROL II GR (Y61)</b>																		
2.8 TD (95 kW)	1997.06-	2000.05					GC041053	Outer Joint		31	28	60	162.5	66	I			
2.8 TDiC (96 kW)	1997.10-	2000.02					GC041053	Outer Joint		31	28	60	162.5	66	I			
3.0 DTi (116 kW)	2000.05-						GC041053	Outer Joint		31	28	60	162.5	66	I			
3.0 DTi (118 kW)	2000.05-						GC041053	Outer Joint		31	28	60	162.5	66	I			
3.2 D (70 kW)	1998.05-	2001.06					GC041053	Outer Joint		31	28	60	162.5	66	I			
<b>PATROL STATION WAGON (W160)</b>																		
2.8 (88 kW)	1980.07-	1988.08				Closed Off-Road Vehicle Engine L28	GC041241	Outer Joint		29	27	35	158	57	I			
3.2 D (70 kW)	1979.11-	1988.08				Closed Off-Road Vehicle Engine SD33	GC041241	Outer Joint		29	27	35	158	57	I			
3.2 TD (81 kW)	1983.07-	1988.08				Closed Off-Road Vehicle Engine SD33T	GC041241	Outer Joint		29	27	35	158	57	I			
<b>PATROL STATION WAGON (W260)</b>																		
2.8 TD (85 kW)	1989.06-	1995.11	MT		F	Closed Off-Road Vehicle Engine RD28T	GC041026	Outer Joint		31	27	60	160.5	57	M			
	1989.06-	1995.11				Closed Off-Road Vehicle Engine RD28T	GC041241	Outer Joint		29	27	35	158	57	I			
3.2 D (81 kW)	1988.08-	1990.06				Closed Off-Road Vehicle Engine SD33T	GC041241	Outer Joint		29	27	35	158	57	I			
<b>PICK UP (D21)</b>																		
2.4 i 4WD (74 kW)	1986.03-	1992.04				Pickup Engine Z24i	GC041178	Outer Joint		26	27	50	147.5	64	I			
2.5 D (61 kW)	1996.03-	1998.02			R	Pickup Engine TD25	GC041178	Outer Joint		26	27	50	147.5	64	I			
2.5 D 4WD (55 kW)	1986.03-	1991.08				Pickup Engine SD25	GC041178	Outer Joint		26	27	50	147.5	64	I			
2.5 D 4WD (59 kW)	1987.08-	1998.02				Pickup Engine TD25	GC041178	Outer Joint		26	27	50	147.5	64	I			
2.5 D 4WD (61 kW)	1996.03-	1998.02				Pickup Engine TD25	GC041178	Outer Joint		26	27	50	147.5	64	I			
<b>PICK UP (D22)</b>																		
2.4 i 4WD (98 kW)	2002.03-				F	Pickup Engine KA24DE	GC041016	Outer Joint		28	27	50	150	71	I			
<b>PICK UP FRONTIER</b>																		
-	1998-	2004				SUV/Truck/VAN 4WD	GCI41014	Inner Joint			27		81.2					
<b>PICK-UP (720)</b>																		
-	1983-	1986					GC041178	Outer Joint		26	27	50	147.5	64	I			
<b>PRAIRIE (BM / VBM10)</b>																		
1.5	1982.08-	1985.01	MT			Engine E15S	GC041041	Outer Joint		24	22	52	105	56	M			
<b>PRAIRIE (HNM10)</b>																		
2.0 4WD	1985.01-	1988.01	MT/AT			Engine CA20S	GC041035	Outer Joint		27	25	56	101	70	M			
<b>PRAIRIE (HNM11)</b>																		
2.4 4WD	1990.09-	1995.08	MT/AT			Engine KA24E	GC041023	Outer Joint		27	23	56	103	61.5	M			
	1990.09-	1995.08	MT/AT			Engine KA24E	GC041024	Outer Joint	42T	27	23	56	103	61.5	M			
<b>PRAIRIE (M10, NM10)</b>																		
1.5 S (55 kW)	1984.01-	1987.12	MT		F	MPV Engine E15S	GC041060	Outer Joint		24	22	52	105	56	I			
2.0 4x4 (68 kW)	1986.06-	1988.09				MPV Engine CA20S	GC041011	Outer Joint		27	25	56	103	66	I			
	1986.06-	1988.09	MT		F	MPV Engine CA20S	GC041163	Outer Joint		27	25	56	103	66.5	I			
<b>PRAIRIE (NM11)</b>																		
2.0	1988.09-	1995.08	MT/AT			Engine CA20S	GC041023	Outer Joint		27	23	56	103	61.5	M			
	1988.09-	1995.08	MT/AT			Engine CA20S	GC041024	Outer Joint	42T	27	23	56	103	61.5	M			
<b>PRAIRIE (PNM11)</b>																		
2.0 4WD	1995.08-	1998.11	AT			Engine SR20DE	GC041054	Outer Joint		27	23	56	103	61.5	M			
	1995.08-	1998.11	AT			Engine SR20DE	GC041024	Outer Joint	42T	27	23	56	103	61.5	M			
<b>PRAIRIE PRO (M11)</b>																		
2.0 i (72 kW)	1988.10-	1992.04			F	MPV Engine CA20E	GC041176	Outer Joint		27	23	56	104	63	I			
	1988.10-	1992.04	MT		F	MPV Engine CA20E	GC041061	Outer Joint		27	23	56	99	60	I			
2.0 i 4x4 (72 kW)	1988.10-	1992.12			F	MPV Engine CA20E	GC041042	Outer Joint	44T	27	23	56	103.5	61.4	I			
	1988.10-	1992.12				MPV Engine CA20E	GC041176	Outer Joint		27	23	56	104	63	I			
	1988.10-	1992.12	MT		F	MPV Engine CA20E	GC041061	Outer Joint		27	23	56	99	60	I			
	1988.10-	1992.12			F	MPV Engine CA20E	GC041045	Outer Joint		27	23	56	103	62	I			
2.4 i 4x4 (98 kW)	1992.04-	1994.07			F	MPV Engine KA24E	GC041042	Outer Joint	44T	27	23	56	103.5	61.4	I			
	1992.04-	1994.07	MT		F	MPV Engine KA24E	GC041061	Outer Joint		27	23	56	99	60	I			
<b>PRESEA (PR10)</b>																		
1.8	1990.06-	1995.01	MT/AT			Engine SR18DI	GC041033	Outer Joint		25	23	55	107	61	I			
	1990.06-	1995.01	MT/AT			Engine SR18DI	GC041034	Outer Joint	42T	25	23	55	107	61	I			
<b>PRESEA (PR11)</b>																		
1.8	1995.01-	1997.08	MT/AT			Engine SR18DE	GC041033	Outer Joint		25	23	55	107	61	I			
	1995.01-	1997.08	MT/AT			Engine SR18DE	GC041034	Outer Joint	42T	25	23	55	107	61	I			
<b>PRESEA (R10)</b>																		
1.5	1990.01-	1995.01	MT&AT			Engine GA15DS	GC034024	Outer Joint		25	22	55	107	57	M			



		TRANSM	L/R	F/R		G-AP Ref.	PRODUCT	ABS	Technical Specifications									
									YEAR	A	B	C	H	L	P			
<b>NISSAN PRESEA (R10)</b>																		
1.5 PRESEA (R11)	1990.01-	1995.01	MT/AT			Engine GA15DS	GC041191	Outer Joint	42T	25	22	55	107	57	M			
1.5	1995.01-	1997.08	AT			Engine GA15DE	GC034024	Outer Joint		25	22	55	107	57	M			
	1995.01-	1997.08	MT			Engine GA15DE	GC041033	Outer Joint		25	23	55	107	61	I			
	1995.01-	1997.08	MT			Engine GA15DE	GC041034	Outer Joint	42T	25	23	55	107	61	I			
	1995.01-	1997.08	AT			Engine GA15DE	GC041191	Outer Joint	42T	25	22	55	107	57	M			
<b>PRIMASTAR</b>																		
2.5 DCi (99 kW)	2001.03-						GC045015	Outer Joint		21	20	56.4	76	56	O			
<b>PRIMASTAR (X83)</b>																		
1.9 DCi (60 kW)	2002.09-			F		Box Engine F9Q762	GC018105	Outer Joint		27	26	56.5	93.5	64	M			
1.9 DCi 100 (74 kW)	2002.09-			F		Box Engine F9Q760	GC018105	Outer Joint		27	26	56.5	93.5	64	M			
2.0 (88 kW)	2003.02-			F		Box Engine F4R720	GC018105	Outer Joint		27	26	56.5	93.5	64	M			
<b>PRIMASTAR VAN (X83)</b>																		
1.9 DCi (60 kW)	2001.03-			F		Bus Engine F9Q762	GC018105	Outer Joint		27	26	56.5	93.5	64	M			
1.9 DCi 100 (74 kW)	2001.03-			F		Bus Engine F9Q760	GC018105	Outer Joint		27	26	56.5	93.5	64	M			
2.0 (88 kW)	2001.03-			F		Bus Engine F4R720/F4R722	GC018105	Outer Joint		27	26	56.5	93.5	64	M			
<b>PRIMERA</b>																		
-							GC041130	Outer Joint		27	22	56	103	56.5	M			
	1990-	1996					GC099190	Outer Joint	42T	27	22	56	103.5	61.5	I			
2.0	1992-	1996					GCI41013	Inner Joint		25	25	33	345	102.5				
<b>PRIMERA (P10)</b>																		
1.6						Engine GA16 DE	GC041029	Outer Joint		27	22	56	103.5	61.5	I			
1.6 (66 kW)	1990.06-	1996.01	MT	L	F	Hatchback Engine GA16DS	GDS41094	Drive Shaft		27	25	56	103.5	640				
	1990.06-	1996.01	MT	L	F	Saloon Engine GA16DS	GDS41094	Drive Shaft		27	25	56	103.5	640				
	1990.06-	1996.01	MT	R	F	Hatchback Engine GA16DS	GDS41004	Drive Shaft		27	25	56	103.5	922				
	1990.06-	1996.01	MT	R	F	Saloon Engine GA16DS	GDS41004	Drive Shaft		27	25	56	103.5	922				
	1990.06-	1996.01	MT	L	F	Hatchback Engine GA16DS	GDS41001	Drive Shaft	42T	27	25	56	103.5	638				
	1990.06-	1996.01	MT	L	F	Saloon Engine GA16DS	GDS41001	Drive Shaft	42T	27	25	56	103.5	638				
	1990.06-	1996.01	MT	R	F	Hatchback Engine GA16DS	GDS41005	Drive Shaft	42T	27	25	56	103.5	922				
	1990.06-	1996.01	MT	R	F	Saloon Engine GA16DS	GDS41005	Drive Shaft	42T	27	25	56	103.5	922				
	1990.06-	1996.01	MT		F	Hatchback Engine GA16DS	GC041009	Outer Joint		27	22	56	103.5	61.4	I			
	1990.06-	1996.01	MT		F	Saloon Engine GA16DS	GC041009	Outer Joint		27	22	56	103.5	61.4	I			
	1990.06-	1996.01	MT		F	Hatchback Engine GA16DS	GC041010	Outer Joint	42T	27	22	56	103.5	61.4	I			
	1990.06-	1996.01	MT		F	Saloon Engine GA16DS	GC041010	Outer Joint	42T	27	22	56	103.5	61.4	I			
	1990.06-	1996.01			F	Hatchback Engine GA16DS	GC099203	Outer Joint		27	22	56	103.5	61.4	M			
	1990.06-	1996.01			F	Saloon Engine GA16DS	GC099203	Outer Joint		27	22	56	103.5	61.4	M			
1.6 (75 kW)	1993.06-	1996.01	MT	L	F	Saloon Engine GA16DE	GDS41094	Drive Shaft		27	25	56	103.5	640				
	1993.06-	1996.01			F	Saloon Engine GA16DE	GC099203	Outer Joint		27	22	56	103.5	61.4	M			
2.0	1990.05-	1996.06	MT/AT	L			GDS41153	Drive Shaft	42T	27	25	56	103.5	623				
2.0 (105 kW)	1990.06-	1993.04		L	F	Saloon Engine SR20DE	GDS41280	Drive Shaft	42T	27	25	56	103.5	618				
	1990.06-	1993.04		R	F	Saloon Engine SR20DE	GDS41024	Drive Shaft	42T	27	25	56	103.5	940				
2.0 (110 kW)	1990.06-	1996.01	MT	L/R	F	Hatchback Engine SR20DE	GC041006	Outer Joint		27	32	56	103.5	68.5	I			
2.0 16V (85 kW)	1990.06-	1996.01	AT		F	Hatchback Engine SR20DI	GC041006	Outer Joint		27	32	56	103.5	68.5	I			
	1990.06-	1996.01	AT		F	Saloon Engine SR20DI	GC041006	Outer Joint		27	32	56	103.5	68.5	I			
	1990.06-	1996.01		L	F	Hatchback Engine SR20DI	GDS41280	Drive Shaft	42T	27	25	56	103.5	618				
	1990.06-	1996.01		L	F	Saloon Engine SR20DI	GDS41280	Drive Shaft	42T	27	25	56	103.5	618				
	1990.06-	1996.01	MT	R	F	Hatchback Engine SR20DI	GDS41130	Drive Shaft	42T	27	25	56	103.5	962.5				
	1990.06-	1996.01	MT	R	F	Saloon Engine SR20DI	GDS41130	Drive Shaft	42T	27	25	56	103.5	962.5				
	1990.06-	1996.01		R	F	Hatchback Engine SR20DI	GDS41024	Drive Shaft	42T	27	25	56	103.5	940				
	1990.06-	1996.01		R	F	Saloon Engine SR20DI	GDS41024	Drive Shaft	42T	27	25	56	103.5	940				
	1990.06-	1996.01	MT		F	Hatchback Engine SR20DI	GC041009	Outer Joint		27	22	56	103.5	61.4	I			
	1990.06-	1996.01	MT		F	Saloon Engine SR20DI	GC041009	Outer Joint		27	22	56	103.5	61.4	I			
	1990.06-	1996.01	AT		F	Hatchback Engine SR20DI	GC041007	Outer Joint	42T	27	32	56	103.5	68.5	I			
	1990.06-	1996.01	AT		F	Saloon Engine SR20DI	GC041007	Outer Joint	42T	27	32	56	103.5	68.5	I			
	1990.06-	1996.01	MT		F	Hatchback Engine SR20DI	GC041010	Outer Joint	42T	27	22	56	103.5	61.4	I			
	1990.06-	1996.01	MT		F	Saloon Engine SR20DI	GC041010	Outer Joint	42T	27	22	56	103.5	61.4	I			
	1990.06-	1996.01	MT		F	Hatchback Engine SR20DI	GC041163	Outer Joint		27	25	56	103	66.5	I			
	1990.06-	1996.01	MT		F	Saloon Engine SR20DI	GC041163	Outer Joint		27	25	56	103	66.5	I			
2.0 16V 4x4 (85 kW)	1991.04-	1996.06	AT			Hatchback Engine SR20DI	GC041006	Outer Joint		27	32	56	103.5	68.5	I			
	1991.04-	1996.06	AT			Saloon Engine SR20DI	GC041006	Outer Joint		27	32	56	103.5	68.5	I			
	1991.04-	1996.06		L	F	Hatchback Engine SR20DI	GDS41280	Drive Shaft	42T	27	25	56	103.5	618				
	1991.04-	1996.06		L	F	Saloon Engine SR20DI	GDS41280	Drive Shaft	42T	27	25	56	103.5	618				

		TRANSM	L/R	F/R		G-AP Ref.	PRODUCT	ABS	Technical Specifications								
									YEAR	A	B	C	H	L	P		
<b>NISSAN PRIMERA (P10)</b>																	
2.0 16V 4x4 (85 kW)	1991.04-1996.06	MT	R	F	Hatchback Engine SR20DI	GDS41130	Drive Shaft	42T	27	25	56	103.5	962.5				
	1991.04-1996.06	MT	R	F	Saloon Engine SR20DI	GDS41130	Drive Shaft	42T	27	25	56	103.5	962.5				
	1991.04-1996.06		R	F	Hatchback Engine SR20DI	GDS41024	Drive Shaft	42T	27	25	56	103.5	940				
	1991.04-1996.06		R	F	Saloon Engine SR20DI	GDS41024	Drive Shaft	42T	27	25	56	103.5	940				
	1991.04-1996.06	MT		F	Hatchback Engine SR20DI	GC041009	Outer Joint		27	22	56	103.5	61.4	I			
	1991.04-1996.06	MT		F	Saloon Engine SR20DI	GC041009	Outer Joint		27	22	56	103.5	61.4	I			
	1991.04-1996.06	AT		F	Hatchback Engine SR20DI	GC041007	Outer Joint	42T	27	32	56	103.5	68.5	I			
	1991.04-1996.06	AT		F	Saloon Engine SR20DI	GC041007	Outer Joint	42T	27	32	56	103.5	68.5	I			
	1991.04-1996.06	MT		F	Hatchback Engine SR20DI	GC041010	Outer Joint	42T	27	22	56	103.5	61.4	I			
	1991.04-1996.06	MT		F	Saloon Engine SR20DI	GC041010	Outer Joint	42T	27	22	56	103.5	61.4	I			
	1991.04-1996.06	MT		F	Hatchback Engine SR20DI	GC041163	Outer Joint		27	25	56	103	66.5	I			
	1991.04-1996.06	MT		F	Saloon Engine SR20DI	GC041163	Outer Joint		27	25	56	103	66.5	I			
2.0 D (55 kW)	1991.01-1996.01	AT		F	Saloon Engine CD20	GC041006	Outer Joint		27	32	56	103.5	68.5	I			
	1991.01-1996.01	AT	L/R	F	Hatchback Engine CD20	GC041006	Outer Joint		27	32	56	103.5	68.5	I			
	1991.01-1996.01		L	F	Saloon Engine CD20	GDS41280	Drive Shaft	42T	27	25	56	103.5	618				
	1991.01-1996.01	MT	R	F	Saloon Engine CD20	GDS41130	Drive Shaft	42T	27	25	56	103.5	962.5				
	1991.01-1996.01		R	F	Saloon Engine CD20	GDS41024	Drive Shaft	42T	27	25	56	103.5	940				
	1991.01-1996.01	MT		F	Saloon Engine CD20	GC041009	Outer Joint		27	22	56	103.5	61.4	I			
	1991.01-1996.01	AT		F	Saloon Engine CD20	GC041007	Outer Joint	42T	27	32	56	103.5	68.5	I			
	1991.01-1996.01	MT		F	Saloon Engine CD20	GC041010	Outer Joint	42T	27	22	56	103.5	61.4	I			
	1991.01-1996.01	MT		F	Saloon Engine CD20	GC041163	Outer Joint		27	25	56	103	66.5	I			
	1991.01-1996.01			F	Saloon Engine CD20	GC099203	Outer Joint		27	22	56	103.5	61.4	M			
2.0 GT (110 kW)	1990.06-1996.01	AT		F	Saloon Engine SR20DE	GC041006	Outer Joint		27	32	56	103.5	68.5	I			
	1990.06-1996.01		L	F	Saloon Engine SR20DE	GDS41280	Drive Shaft	42T	27	25	56	103.5	618				
	1990.06-1996.01		R	F	Saloon Engine SR20DE	GDS41024	Drive Shaft	42T	27	25	56	103.5	940				
	1990.06-1996.01	MT		F	Saloon Engine SR20DE	GC041007	Outer Joint	42T	27	32	56	103.5	68.5	I			
	1990.06-1996.01	MT		F	Saloon Engine SR20DE	GC041163	Outer Joint		27	25	56	103	66.5	I			
2.0 GT 4x4 (105 kW)	1991.03-1993.04		L	F	Saloon Engine SR20DE	GDS41280	Drive Shaft	42T	27	25	56	103.5	618				
	1991.03-1993.04		R	F	Saloon Engine SR20DE	GDS41024	Drive Shaft	42T	27	25	56	103.5	940				
<b>PRIMERA (P11)</b>																	
1.6 16V (66 kW)	1996.09-2002.07	MT		F	Hatchback Engine GA16DE	GC041030	Outer Joint	44T	27	22	56	103.5	61.5	I			
	1996.09-2002.07		L	F	Hatchback Engine GA16DE	GDS41213	Drive Shaft	44T	27	24	56	103.5	639				
	1996.09-2002.07		L	F	Hatchback Engine GA16DE	GCI41003	Inner Joint		24	23	40	51.5	107.5				
	1996.09-2002.07		L	F	Hatchback Engine GA16DE	GC041142	Outer Joint	44T	27	23	56	103.5	61.5	M			
	1996.09-2002.07	MT	R	F	Hatchback Engine GA16DE	GDS41205	Drive Shaft	44T	27	25	56	103.5	923				
	1996.09-2002.07				Hatchback Engine GA16DE	GC041195	Outer Joint	44T	27	22	56	103	57	M			
	1996.09-2001.12		L	F	Saloon Engine GA16DE	GDS41213	Drive Shaft	44T	27	24	56	103.5	639				
	1996.09-2001.12		L	F	Saloon Engine GA16DE	GCI41003	Inner Joint		24	23	40	51.5	107.5				
	1996.09-2001.12		L	F	Saloon Engine GA16DE	GC041142	Outer Joint	44T	27	23	56	103.5	61.5	M			
	1996.09-2001.12	MT	R	F	Saloon Engine GA16DE	GDS41205	Drive Shaft	44T	27	25	56	103.5	923				
	1996.09-2001.12				Saloon Engine GA16DE	GC041195	Outer Joint	44T	27	22	56	103	57	M			
	1.6 16V (73 kW)	1996.09-2002.07	MT		F	Hatchback Engine GA16DE	GC041030	Outer Joint	44T	27	22	56	103.5	61.5	I		
1996.09-2002.07			L	F	Hatchback Engine GA16DE	GDS41213	Drive Shaft	44T	27	24	56	103.5	639				
1996.09-2002.07			L	F	Hatchback Engine GA16DE	GCI41003	Inner Joint		24	23	40	51.5	107.5				
1996.09-2002.07			L	F	Hatchback Engine GA16DE	GC041142	Outer Joint	44T	27	23	56	103.5	61.5	M			
1996.09-2002.07		MT	R	F	Hatchback Engine GA16DE	GDS41205	Drive Shaft	44T	27	25	56	103.5	923				
1996.09-2002.07					Hatchback Engine GA16DE	GC041195	Outer Joint	44T	27	22	56	103	57	M			
1996.09-2002.07					Hatchback Engine GA16DE	GC041195	Outer Joint	44T	27	22	56	103	57	M			
1.6 16V (78 kW)	1996.06-2001.12		L	F	Saloon Engine QG16DE	GDS41213	Drive Shaft	44T	27	24	56	103.5	639				
	1996.06-2001.12		L	F	Saloon Engine QG16DE	GCI41003	Inner Joint		24	23	40	51.5	107.5				
	1996.06-2001.12		L	F	Saloon Engine QG16DE	GC041142	Outer Joint	44T	27	23	56	103.5	61.5	M			
	1996.06-2001.12	MT	R	F	Saloon Engine QG16DE	GDS41205	Drive Shaft	44T	27	25	56	103.5	923				
	1996.06-2001.12				Saloon Engine QG16DE	GC041195	Outer Joint	44T	27	22	56	103	57	M			
	2000.09-2002.07	MT/AT		F	Hatchback Engine QG16DE	GC041028	Outer Joint	44T	27	32	56	103	68.5	I			
	2000.09-2002.07		L	F	Hatchback Engine QG16DE	GDS41213	Drive Shaft	44T	27	24	56	103.5	639				
	2000.09-2002.07		L	F	Hatchback Engine QG16DE	GCI41003	Inner Joint		24	23	40	51.5	107.5				
	2000.09-2002.07		L	F	Hatchback Engine QG16DE	GC041142	Outer Joint	44T	27	23	56	103.5	61.5	M			
	2000.09-2002.07	MT	R	F	Hatchback Engine QG16DE	GDS41205	Drive Shaft	44T	27	25	56	103.5	923				
	2000.09-2002.07				Hatchback Engine QG16DE	GC041195	Outer Joint	44T	27	22	56	103	57	M			
1.8	1999.06-	MT/AT			Engine QG18DE	GC041300	Outer Joint	44T	27	32	56	103	68	I			
	1999.06-	MT/AT			Engine QG18DE	GC041300	Outer Joint	44T	27	32	56	103	68	I			
1.8 16V (84 kW)	1999.08-2002.07	MT/AT		F	Hatchback Engine QG18DE	GC041028	Outer Joint	44T	27	32	56	103	68.5	I			
	1999.08-2002.07	MT	R	F	Hatchback Engine QG18DE	GDS41205	Drive Shaft	44T	27	25	56	103.5	923				





		YEAR	TRANSM	L/R	F/R		G-AP Ref.	PRODUCT	ABS	Technical Specifications							
										A	B	C	H	L	P		
<b>NISSAN PRIMERA (P11)</b>																	
1.8 16V (84 kW)	1999.08-	2001.12	MT	R	F	Saloon Engine QG18DE	GDS41205	Drive Shaft	44T	27	25	56	103.5	923			
2.0					R	Engine CD20T/SR20DE	GC041096	Outer Joint		27	32	56	103	68.5	I		
2.0 16V (103 kW)	1999.08-	2002.07			F	Hatchback Engine SR20DE	GC041043	Outer Joint	44T	27	23	56	104	60	M		
	1999.08-	2002.07		L	F	Hatchback Engine SR20DE	GDS41020	Drive Shaft	44T	27	25	56	103	621			
	1999.08-	2002.07		R	F	Hatchback Engine SR20DE	GDS41021	Drive Shaft	44T	27	25	56	103	940			
	1999.08-	2001.12			F	Saloon Engine SR20DE	GC041176	Outer Joint		27	23	56	104	63	I		
	1999.08-	2001.12		L	F	Saloon Engine SR20DE	GDS41020	Drive Shaft	44T	27	25	56	103	621			
	1999.08-	2001.12		R	F	Saloon Engine SR20DE	GDS41021	Drive Shaft	44T	27	25	56	103	940			
2.0 16V (110 kW)	1996.09-	2002.07			F	Hatchback Engine SR20DE	GC041043	Outer Joint	44T	27	23	56	104	60	M		
	1996.09-	2002.07		L	F	Hatchback Engine SR20DE	GDS41020	Drive Shaft	44T	27	25	56	103	621			
	1996.09-	2002.07		R	F	Hatchback Engine SR20DE	GDS41021	Drive Shaft	44T	27	25	56	103	940			
	1996.09-	2001.12		L	F	Saloon Engine SR20DE	GDS41020	Drive Shaft	44T	27	25	56	103	621			
	1996.09-	2001.12		R	F	Saloon Engine SR20DE	GDS41021	Drive Shaft	44T	27	25	56	103	940			
2.0 16V (85 kW)	1996.09-	2002.07			F	Hatchback Engine SR20De	GC041043	Outer Joint	44T	27	23	56	104	60	M		
	1996.09-	2002.07	MT/AT		F	Hatchback Engine SR20De	GC041028	Outer Joint	44T	27	32	56	103	68.5	I		
	1996.09-	2002.07		L	F	Hatchback Engine SR20De	GDS41020	Drive Shaft	44T	27	25	56	103	621			
	1996.09-	2002.07		R	F	Hatchback Engine SR20De	GDS41021	Drive Shaft	44T	27	25	56	103	940			
	1996.09-	2001.12		L	F	Saloon Engine SR20De	GDS41020	Drive Shaft	44T	27	25	56	103	621			
	1996.09-	2001.12		R	F	Saloon Engine SR20De	GDS41021	Drive Shaft	44T	27	25	56	103	940			
2.0 16V (96 kW)	1996.09-	2002.07			F	Hatchback Engine SR20DE	GC041043	Outer Joint	44T	27	23	56	104	60	M		
	1996.09-	2002.07	MT/AT		F	Hatchback Engine SR20DE	GC041028	Outer Joint	44T	27	32	56	103	68.5	I		
	1996.09-	2002.07		L	F	Hatchback Engine SR20DE	GDS41020	Drive Shaft	44T	27	25	56	103	621			
	1996.09-	2002.07		R	F	Hatchback Engine SR20DE	GDS41021	Drive Shaft	44T	27	25	56	103	940			
	1996.09-	2001.12		L	F	Saloon Engine SR20DE	GDS41020	Drive Shaft	44T	27	25	56	103	621			
	1996.09-	2001.12		R	F	Saloon Engine SR20DE	GDS41021	Drive Shaft	44T	27	25	56	103	940			
2.0 TD (66 kW)	1996.09-	2002.07	MT/AT		F	Hatchback Engine CD20T	GC041028	Outer Joint	44T	27	32	56	103	68.5	I		
	1996.09-	2002.07	MT	R	F	Hatchback Engine CD20T	GDS41206	Drive Shaft	44T	27	25	56	103	954			
	1996.09-	2002.07		L		Hatchback Engine CD20T	GDS41081	Drive Shaft	44T	27	25	56	103	608			
	1996.09-	2001.12	MT	R	F	Saloon Engine CD20T	GDS41206	Drive Shaft	44T	27	25	56	103	954			
	1996.09-	2001.12		L		Saloon Engine CD20T	GDS41081	Drive Shaft	44T	27	25	56	103	608			
<b>PRIMERA (P12)</b>																	
1.6 (78 kW)	2002.03-				F	Saloon Engine QG16DE	GC041142	Outer Joint	44T	27	23	56	103.5	61.5	M		
	2002.07-				F	Hatchback Engine QG16DE	GC041142	Outer Joint	44T	27	23	56	103.5	61.5	M		
1.6 (80 kW)	2002.01-				F	Saloon Engine QG16DE	GC041142	Outer Joint	44T	27	23	56	103.5	61.5	M		
	2002.07-				F	Hatchback Engine QG16DE	GC041142	Outer Joint	44T	27	23	56	103.5	61.5	M		
1.8 (85 kW)	2002.03-				F	Saloon Engine QG18DE	GC041142	Outer Joint	44T	27	23	56	103.5	61.5	M		
	2002.03-		MT/AT	L	F	Saloon Engine QG18DE	GCI99179	Inner Joint		25	22	40	63	100			
	2002.03-		MT/AT	L	F	Saloon Engine QG18DE	GC041030	Outer Joint	44T	27	22	56	103.5	61.5	I		
	2002.03-		MT/AT	R	F	Saloon Engine QG18DE	GDS41392	Drive Shaft	44T	27	25	56	103.5	961			
	2002.07-				F	Hatchback Engine QG18DE	GC041142	Outer Joint	44T	27	23	56	103.5	61.5	M		
	2002.07-			L	F	Hatchback Engine QG18DE	GCI99179	Inner Joint		25	22	40	63	100			
	2002.07-			L	F	Hatchback Engine QG18DE	GC041030	Outer Joint	44T	27	22	56	103.5	61.5	I		
	2002.07-			R	F	Hatchback Engine QG18DE	GDS41392	Drive Shaft	44T	27	25	56	103.5	961			
1.9 DCi (88 kW)	2003.04-				F	Hatchback	GC041050	Outer Joint	44T	27	35	56	103	69	I		
	2003.04-				F	Saloon	GC041050	Outer Joint	44T	27	35	56	103	69	I		
2.0 (103 kW)	2002.03-				F	Saloon Engine QR20DE	GC041038	Outer Joint	44T	27	26	56	103	69	M		
	2002.07-				F	Hatchback Engine QR20DE	GC041038	Outer Joint	44T	27	26	56	103	69	M		
2.2 DCi (102 kW)	2003.03-	2006.12			F	Hatchback Engine YD22DDT	GC041038	Outer Joint	44T	27	26	56	103	69	M		
	2003.03-	2006.12			F	Saloon Engine YD22DDT	GC041038	Outer Joint	44T	27	26	56	103	69	M		
	2003.03-	2006.12	MT	L	F	Hatchback Engine YD22DDT	GDS41214	Drive Shaft	44T	27	29	56	103	613			
	2003.03-	2006.12	MT	L	F	Hatchback Engine YD22DDT	GDS41244	Drive Shaft	44T	27	39	56	103	619			
	2003.03-	2006.12	MT	L	F	Hatchback Engine YD22DDT	GCI41132	Inner Joint		39	34	39	70	114.5			
	2003.03-	2006.12	MT	L	F	Hatchback Engine YD22DDT	GCI41144	Inner Joint		29	34	39	65.5	114.5			
	2003.03-	2006.12	MT	L	F	Hatchback Engine YD22DDT	GC041335	Outer Joint		27	26	56	103	69	M		
	2003.03-	2006.12	MT	L	F	Hatchback Engine YD22DDT	GC099236	Outer Joint	44T	27	26	56	103	69	M		
	2003.03-	2006.12	MT	L	F	Saloon Engine YD22DDT	GDS41214	Drive Shaft	44T	27	29	56	103	613			
	2003.03-	2006.12	MT	L	F	Saloon Engine YD22DDT	GCI41144	Inner Joint		29	34	39	65.5	114.5			
	2003.03-	2006.12	MT	L	F	Saloon Engine YD22DDT	GC099236	Outer Joint	44T	27	26	56	103	69	M		
	2003.03-	2006.12	MT	R	F	Hatchback Engine YD22DDT	GDS41215	Drive Shaft	44T	27	29	56	103	988			
	2003.03-	2006.12	MT	R	F	Hatchback Engine YD22DDT	GDS41271	Drive Shaft	44T	27	39	56	103	984.5			
	2003.03-	2006.12	MT	R	F	Saloon Engine YD22DDT	GDS41215	Drive Shaft	44T	27	29	56	103	988			



		TRANSM	L/R	F/R		G-AP Ref.	PRODUCT	ABS	Technical Specifications						
									YEAR	A	B	C	H	L	P
<b>NISSAN PRIMERA (P12)</b>															
2.2 Di (93 kW)	2002.03-			F	Saloon Engine YD22DDT	GC041038	Outer Joint	44T	27	26	56	103	69	M	
	2002.03-		MT	L	F	Saloon Engine YD22DDT	GDS41214	Drive Shaft	44T	27	29	56	103	613	
	2002.03-		MT	L	F	Saloon Engine YD22DDT	GCI411144	Inner Joint		29	34	39	65.5	114.5	
	2002.03-		MT	L	F	Saloon Engine YD22DDT	GC099236	Outer Joint	44T	27	26	56	103	69	M
	2002.03-		MT	R	F	Saloon Engine YD22DDT	GDS41215	Drive Shaft	44T	27	29	56	103	988	
	2002.07-				F	Hatchback Engine YD22DDT	GC041038	Outer Joint	44T	27	26	56	103	69	M
	2002.07-		MT	L	F	Hatchback Engine YD22DDT	GDS41214	Drive Shaft	44T	27	29	56	103	613	
	2002.07-		MT	L	F	Hatchback Engine YD22DDT	GCI411144	Inner Joint		29	34	39	65.5	114.5	
	2002.07-		MT	L	F	Hatchback Engine YD22DDT	GC099236	Outer Joint	44T	27	26	56	103	69	M
2002.07-		MT	R	F	Hatchback Engine YD22DDT	GDS41215	Drive Shaft	44T	27	29	56	103	988		
<b>PRIMERA (WP12)</b>															
1.6 Visia (80 kW)	2002.01-			F	Estate Engine QG16DE	GC041142	Outer Joint	44T	27	23	56	103.5	61.5	M	
1.8 (85 kW)	2002.03-			F	Estate Engine QG18DE	GC041142	Outer Joint	44T	27	23	56	103.5	61.5	M	
	2002.03-			L	F	Estate Engine QG18DE	GCI99179	Inner Joint		25	22	40	63	100	
	2002.03-			L	F	Estate Engine QG18DE	GC041030	Outer Joint	44T	27	22	56	103.5	61.5	I
	2002.03-			R	F	Estate Engine QG18DE	GDS41392	Drive Shaft	44T	27	25	56	103.5	961	
1.9 DCi (88 kW)	2003.04-			F	Estate	GC041050	Outer Joint	44T	27	35	56	103	69	I	
2.0 (103 kW)	2002.03-		5MT/AT	F	Estate Engine QR20DE	GC041049	Outer Joint	44T	27	24	56	103	63	M	
2.2 DCi (102 kW)	2003.03-2006.12			F	Estate Engine YD22DDT	GC041038	Outer Joint	44T	27	26	56	103	69	M	
	2003.03-2006.12	MT	L	F	Estate Engine YD22DDT	GDS41214	Drive Shaft	44T	27	29	56	103	613		
	2003.03-2006.12	MT	L	F	Estate Engine YD22DDT	GCI411144	Inner Joint		29	34	39	65.5	114.5		
	2003.03-2006.12	MT	L	F	Estate Engine YD22DDT	GC099236	Outer Joint	44T	27	26	56	103	69	M	
	2003.03-2006.12	MT	R	F	Estate Engine YD22DDT	GDS41215	Drive Shaft	44T	27	29	56	103	988		
2.2 Di (93 kW)	2002.03-			F	Estate Engine YD22DDT	GC041038	Outer Joint	44T	27	26	56	103	69	M	
	2002.03-		MT	L	F	Estate Engine YD22DDT	GDS41214	Drive Shaft	44T	27	29	56	103	613	
	2002.03-		MT	L	F	Estate Engine YD22DDT	GCI411144	Inner Joint		29	34	39	65.5	114.5	
	2002.03-		MT	L	F	Estate Engine YD22DDT	GC099236	Outer Joint	44T	27	26	56	103	69	M
	2002.03-		MT	R	F	Estate Engine YD22DDT	GDS41215	Drive Shaft	44T	27	29	56	103	988	
<b>PRIMERA / CAMINO (HNP10)</b>															
2.0 4WD	1990.10-1995.09	MT&AT			Engine SR20DE	GC041023	Outer Joint		27	23	56	103	61.5	M	
	1990.10-1995.09	MT&AT			Engine SR20DE	GC041024	Outer Joint	42T	27	23	56	103	61.5	M	
<b>PRIMERA / CAMINO (HNP11)</b>															
2.0 4WD	1995.09-1997.11	AT			Engine SR20DE	GC041023	Outer Joint		27	23	56	103	61.5	M	
	1995.09-1997.11	AT			Engine SR20DE	GC041024	Outer Joint	42T	27	23	56	103	61.5	M	
<b>PRIMERA / CAMINO (HP11)</b>															
2.0	1995.09-1997.09	MT			Engine SR20DE	GC041024	Outer Joint	42T	27	23	56	103	61.5	M	
<b>PRIMERA / CAMINO (P10)</b>															
1.8	1990.02-1995.09	MT/AT			Engine SR18DI E	GC041023	Outer Joint		27	23	56	103	61.5	M	
2.0	1991.01-1993.12	4AT			Engine SR20DE/SR20DI	GC041017	Outer Joint		27	22	56	103	61.5	M	
<b>PRIMERA / CAMINO (P11)</b>															
1.8	1995.09-1998.09	4AT			Engine SR18DE	GC041189	Outer Joint	44T	27	23	56	103	58.5	M	
	1995.09-2001.01	5MT			Engine SR18DE	GC041189	Outer Joint	44T	27	23	56	103	58.5	M	
	1998.09-2001.01	4AT			Engine QG18DE	GC041189	Outer Joint	44T	27	23	56	103	58.5	M	
	1998.09-2001.01	CVT			Engine QG18DD	GC041189	Outer Joint	44T	27	23	56	103	58.5	M	
	1998.09-2001.01	MT/AT			Engine QG18DE	GC041189	Outer Joint	44T	27	23	56	103	58.5	M	
	2000.06-2001.01	5MT			Engine QG18DE	GC041189	Outer Joint	44T	27	23	56	103	58.5	M	
2.0	1995.09-1998.09	4AT			Engine SR20DE	GC041189	Outer Joint	44T	27	23	56	103	58.5	M	
	1995.09-2001.01	5MT			Engine SR20DE	GC041189	Outer Joint	44T	27	23	56	103	58.5	M	
	1995.09-2001.01	5MT			Engine SR20DE	GC041024	Outer Joint	42T	27	23	56	103	61.5	M	
	1997.09-1998.09	CVT			Engine SR20DE	GC041189	Outer Joint	44T	27	23	56	103	58.5	M	
	1997.09-2001.01	CVT			Engine SR20VE	GC041189	Outer Joint	44T	27	23	56	103	58.5	M	
2.0 4WD	1995.09-2001.01	4AT			Engine SR20DE	GC041189	Outer Joint	44T	27	23	56	103	58.5	M	
	1998.09-2001.01	5MT			Engine SR20DE	GC041189	Outer Joint	44T	27	23	56	103	58.5	M	
<b>PRIMERA / CAMINO (P12DDA)</b>															
2.5	2001.01-	CVT/F			Engine QR25DD	GC041184	Outer Joint	44T	27	25	56	103	68	M	
<b>PRIMERA / CAMINO (P12EDA)</b>															
1.8	2002.02-	4AT/F			Engine QG18DE	GC041282	Outer Joint	44T	27	23	56	103	58.5	I	
2.0	2001.01-	CVT/F			Engine QR20DE	GC041184	Outer Joint	44T	27	25	56	103	68	M	
	2001.08-2003.07	6MT/F			Engine SR20VE	GC041184	Outer Joint	44T	27	25	56	103	68	M	
2.0 4WD	2001.08-	4AT/F			Engine QR20DE	GC041184	Outer Joint	44T	27	25	56	103	68	M	

		YEAR	TRANSM	L/R	F/R		G-AP Ref.	PRODUCT	ABS	Technical Specifications						
										A	B	C	H	L	P	
<b>NISSAN</b>																
<b>PRIMERA II (P11)</b>																
1.6 16V (66 kW)	1996.09-	2001.12					GC041030	Outer Joint	44T	27	22	56	103.5	61.5	I	
1.6 16V (73 kW)	1996.09-	2001.12					GC041030	Outer Joint	44T	27	22	56	103.5	61.5	I	
1.6 16V (78 kW)	1996.06-	2001.12					GC041028	Outer Joint	44T	27	32	56	103	68.5	I	
1.8 16V (84 kW)	1999.08-	2001.12					GC041028	Outer Joint	44T	27	32	56	103	68.5	I	
2.0 16V (110 kW)	1996.09-	2001.12					GC041028	Outer Joint	44T	27	32	56	103	68.5	I	
2.0 16V (96 kW)	1996.09-	2001.12					GC041028	Outer Joint	44T	27	32	56	103	68.5	I	
2.0 i 16V (103 kW)	1999.08-	2001.12					GC041028	Outer Joint	44T	27	32	56	103	68.5	I	
2.0 TD (66 kW)	1996.09-	2002					GC041028	Outer Joint	44T	27	32	56	103	68.5	I	
<b>PRIMERA II (WP11), SW</b>																
1.6 16V (66 kW)	1998-	2002					GC041030	Outer Joint	44T	27	22	56	103.5	61.5	I	
1.6 16V (73 kW)	1998-	2002					GC041030	Outer Joint	44T	27	22	56	103.5	61.5	I	
1.8 16V (84 kW)	1998-	2002					GC041028	Outer Joint	44T	27	32	56	103	68.5	I	
2.0 16V (103 kW)	1998-	2002					GC041028	Outer Joint	44T	27	32	56	103	68.5	I	
2.0 16V (85 kW)	1998-	2002					GC041028	Outer Joint	44T	27	32	56	103	68.5	I	
2.0 16V (96 kW)	1998-	2002					GC041028	Outer Joint	44T	27	32	56	103	68.5	I	
2.0 TD (66 kW)	1998-	2002					GC041028	Outer Joint	44T	27	32	56	103	68.5	I	
<b>PRIMERA II / III</b>																
1.6	1996.06-	2002.02	MT			Estate W11	GC041140	Outer Joint	44T	27	23	56	103	62	I	
<b>PRIMERA II / III (P11)</b>																
1.8	1999.09-	2002.02	MT	L	F	Hatchback, Saloon	GDS41003	Drive Shaft	44T	27	25	56	103.5	645		
	1999.09-	2002.02	MT	R	F	Hatchback, Saloon	GDS41201	Drive Shaft	44T	27	25	56	103.5	917		
2.0	1996.06-	2002.02	MT/AT	L		Hatchback, Saloon	GDS41025	Drive Shaft	44T	27	25	56	103	619		
	1996.06-	2002.02	MT/AT	R		Hatchback, Saloon	GDS41002	Drive Shaft	44T	27	25	56	103	938		
2.0	1996.06-	2002.02	MT/AT	R		Hatchback, Saloon	GC041096	Outer Joint		27	32	56	103	68.5	I	
<b>PRIMERA III (P12), SW</b>																
1.9 DCi (85 kW)	2002.08-						GC041050	Outer Joint	44T	27	35	56	103	69	I	
1.9 DCi (88 kW)	2002.08-						GC041050	Outer Joint	44T	27	35	56	103	69	I	
<b>PRIMERA TRAVELLER (W10)</b>																
1.6 i (66 kW)	1990.07-	1998.03			F	Estate Engine GA16DS	GC041019	Outer Joint	42T	27	23	56	99	60	I	
	1990.07-	1998.03			F	Estate Engine GA16DS	GC041042	Outer Joint	44T	27	23	56	103.5	61.4	I	
	1990.07-	1998.03	MT		F	Estate Engine GA16DS	GC041018	Outer Joint		27	23	56	99	60	I	
	1990.07-	1998.03			F	Estate Engine GA16DS	GC041176	Outer Joint		27	23	56	104	63	I	
1.6 i (75 kW)	1994.03-	1998.03			F	Estate Engine GA16DE	GC041042	Outer Joint	44T	27	23	56	103.5	61.4	I	
	1994.03-	1998.03	MT		F	Estate Engine GA16DE	GC041018	Outer Joint		27	23	56	99	60	I	
	1994.03-	1998.03			F	Estate Engine GA16DE	GC041176	Outer Joint		27	23	56	104	63	I	
2.0 D (55 kW)	1990.07-	1995.12			F	Estate Engine CD20	GC041019	Outer Joint	42T	27	23	56	99	60	I	
	1990.07-	1995.12		L	F	Estate Engine CD20	GDS41280	Drive Shaft	42T	27	25	56	103.5	618		
	1990.07-	1995.12			F	Estate Engine CD20	GC041042	Outer Joint	44T	27	23	56	103.5	61.4	I	
	1990.07-	1995.12		R	F	Estate Engine CD20	GDS41024	Drive Shaft	42T	27	25	56	103.5	940		
	1990.07-	1995.12	MT/AT		F	Estate Engine CD20	GC041018	Outer Joint		27	23	56	99	60	I	
2.0 i (85 kW)	1990.07-	1998.03			F	Estate Engine SR20DI	GC041062	Outer Joint	44T	27	25	56	103	70.5	I	
	1990.07-	1998.03		L	F	Estate Engine SR20DI	GDS41280	Drive Shaft	42T	27	25	56	103.5	618		
	1990.07-	1998.03		R	F	Estate Engine SR20DI	GDS41024	Drive Shaft	42T	27	25	56	103.5	940		
	1990.07-	1998.03	MT		F	Estate Engine SR20DI	GC041011	Outer Joint		27	25	56	103	66	I	
<b>PRIMERA TRAVELLER (WP11)</b>																
1.6 16V (66 kW)	1998.04-	2001.12		L	F	Estate Engine GA16DE	GDS41213	Drive Shaft	44T	27	24	56	103.5	639		
	1998.04-	2001.12		L	F	Estate Engine GA16DE	GCI41003	Inner Joint		24	23	40	51.5	107.5		
	1998.04-	2001.12		L	F	Estate Engine GA16DE	GC041142	Outer Joint	44T	27	23	56	103.5	61.5	M	
	1998.04-	2001.12	MT	R	F	Estate Engine GA16DE	GDS41205	Drive Shaft	44T	27	25	56	103.5	923		
	1998.04-	2001.12				Estate Engine GA16DE	GC041195	Outer Joint	44T	27	22	56	103	57	M	
1.6 16V (73 kW)	1998.04-	2001.12		L	F	Estate Engine GA16DE	GDS41213	Drive Shaft	44T	27	24	56	103.5	639		
	1998.04-	2001.12		L	F	Estate Engine GA16DE	GCI41003	Inner Joint		24	23	40	51.5	107.5		
	1998.04-	2001.12		L	F	Estate Engine GA16DE	GC041142	Outer Joint	44T	27	23	56	103.5	61.5	M	
	1998.04-	2001.12	MT	R	F	Estate Engine GA16DE	GDS41205	Drive Shaft	44T	27	25	56	103.5	923		
	1998.04-	2001.12				Estate Engine GA16DE	GC041195	Outer Joint	44T	27	22	56	103	57	M	
	1999.08-	2001.12	MT	R	F	Estate Engine QG18DE	GDS41205	Drive Shaft	44T	27	25	56	103.5	923		
2.0 16V (103 kW)	1999.08-	2001.12		L	F	Estate Engine SR20DE	GDS41020	Drive Shaft	44T	27	25	56	103	621		
	1999.08-	2001.12		R	F	Estate Engine SR20DE	GDS41021	Drive Shaft	44T	27	25	56	103	940		
2.0 16V (85 kW)	1996.06-	2001.12		L	F	Estate Engine SR20De	GDS41020	Drive Shaft	44T	27	25	56	103	621		
	1996.06-	2001.12		R	F	Estate Engine SR20De	GDS41021	Drive Shaft	44T	27	25	56	103	940		
2.0 16V (96 kW)	1998.04-	2001.12		L	F	Estate Engine SR20DE	GDS41020	Drive Shaft	44T	27	25	56	103	621		
	1998.04-	2001.12		R	F	Estate Engine SR20DE	GDS41021	Drive Shaft	44T	27	25	56	103	940		









	YEAR	TRANSM	L/R	F/R		G-AP Ref.	PRODUCT	ABS	Technical Specifications					
									A	B	C	H	L	P
<b>NISSAN</b>														
<b>PRIMERA TRAVELLER (WP11)</b>														
2.0 TD (66 kW)	1998.04-	2001.12	MT	R	F	Estate Engine CD20T	GDS41206	Drive Shaft	44T	27	25	56	103	954
	1998.04-	2001.12		L		Estate Engine CD20T	GDS41081	Drive Shaft	44T	27	25	56	103	608
<b>PRIMERA UK (FHP10)</b>														
2.0	1990.01-		MT			Engine SR20DE	GC041005	Outer Joint		27	32	56	103	61.5 M
<b>PRIMERA UK (P10)</b>														
1.6	1990.01-		MT			Engine GA16	GC041017	Outer Joint		27	22	56	103	61.5 M
2.0	1990.01-		MT&AT			Engine CD20	GC041017	Outer Joint		27	22	56	103	61.5 M
	1990.01-		AT			Engine CD20	GC041005	Outer Joint		27	32	56	103	61.5 M
	1991.01-	1993.12	4AT			Engine CD20	GC041017	Outer Joint		27	22	56	103	61.5 M
<b>PRIMERA UK (P11)</b>														
1.6	1990.02-	1997.09	MT/AT			Engine GA16DE	GC041017	Outer Joint		27	22	56	103	61.5 M
	1990.02-	1997.09	MT/AT			Engine GA16DE	GC041186	Outer Joint	44T	27	22	56	103	61.5 M
<b>PRIMERA UK (P12E)</b>														
2.0	2001.12-		MT/AT			Engine QR20DE	GC041339	Outer Joint	44T	27	24	56	103	61.5 M
<b>PRIMERA WAGON (WHP11)</b>														
2.0	1997.09-	2001.01	CVT			Engine SR20DE	GC041306	Outer Joint		27	25	56	103	61.5 M
<b>PRIMERA WAGON / CAMINO WAGON (P12DDA)</b>														
2.5	2001.01-		CVT/F			Engine QR25DD	GC041184	Outer Joint	44T	27	25	56	103	68 M
<b>PRIMERA WAGON / CAMINO WAGON (P12EDA)</b>														
2.0	2001.08-		6MT/F			Engine SR20VE	GC041184	Outer Joint	44T	27	25	56	103	68 M
	2001.12-		CVT/F			Engine QR20DE	GC041184	Outer Joint	44T	27	25	56	103	68 M
2.0 4WD	2001.01-		4AT/F			Engine QR20DE	GC041184	Outer Joint	44T	27	25	56	103	68 M
<b>PRIMERA WAGON / CAMINO WAGON (WHNP11)</b>														
2.0 4WD	1997.09-	2001.01	MT/AT			Engine SR20DE	GC041023	Outer Joint		27	23	56	103	61.5 M
	1997.09-	2001.01	4AT			Engine SR20DE	GC041024	Outer Joint	42T	27	23	56	103	61.5 M
	1997.09-	2001.01	5MT			Engine SR20DE	GC041024	Outer Joint	42T	27	23	56	103	61.5 M
<b>PRIMERA WAGON / CAMINO WAGON (WHP11)</b>														
2.0	1996.11-		4AT			Engine SR20DE	GC041024	Outer Joint	42T	27	23	56	103	61.5 M
	1997.09-	2001.01	5MT			Engine SR20DE	GC041054	Outer Joint		27	23	56	103	61.5 M
	1997.09-	2001.01	5MT			Engine SR20DE	GC041189	Outer Joint	44T	27	23	56	103	58.5 M
<b>PRIMERA WAGON / CAMINO WAGON (WP11)</b>														
1.8	1997.09-	2001.01	MT/AT			Engine SR18DE	GC041054	Outer Joint		27	23	56	103	61.5 M
	1997.09-	2001.01	4AT			Engine SR18DE	GC041189	Outer Joint	44T	27	23	56	103	58.5 M
	1997.09-	2001.01	5MT			Engine SR18DE	GC041189	Outer Joint	44T	27	23	56	103	58.5 M
<b>PRIMERA WAGON CAMINO WAGON (WP11)</b>														
1.8	1997.09-	2001.01	5MT			Engine SR18DE	GC041338	Outer Joint		27	23	56	103	61.5 M
<b>PULSAR</b>														
1.6	1990-				R	B13 GA13 GA16DE GA16DS	GCI41002	Inner Joint		25	23	40	63	101
1.6 (WPB11)	1988.01-	1992.12	MT			Engine E16S	GC041083	Outer Joint		25	24	52.3	107	62 I
<b>PULSAR (INTL) SE MODELS</b>														
-	1985-	1987					GC041077	Outer Joint		25	23	52.3	107	62 I
<b>PULSAR / ALMERA (N13)</b>														
1.3	1986.05-	1990.07	MT/AT			Engine E13S	GC041039	Outer Joint		25	22	52.3	107.4	55.7 M
	1986.05-	1988.04	AT			Engine E13S	GC099204	Outer Joint		25	25	52.3	106.5	62 M
<b>PULSAR / ALMERA (N14)</b>														
1.3	1990.08-	1995.01	MT&AT			Engine GA13DS	GC034024	Outer Joint		25	22	55	107	57 M
	1990.08-	1995.01	MT&AT			Engine GA13DS	GC041191	Outer Joint	42T	25	22	55	107	57 M
<b>PULSAR / ALMERA (PN12)</b>														
1.3	1982.05-	1986.05	MT&AT			Engine E13S	GC041281	Outer Joint		21	22	48	98.5	56.5 M
<b>PULSAR / ALMERA (RNN14)</b>														
2.0 4WD	1990.01-	1995.01	MT/AT			Engine SR20DET	GC041033	Outer Joint		25	23	55	107	61 I
<b>PULSAR / ALMERA (SN12)</b>														
1.7	1983.05-	1986.10	MT			Engine CD17	GC041041	Outer Joint		24	22	52	105	56 M
<b>PULSAR / ALMERA (SN13)</b>														
1.7	1986.05-	1990.07	MT			Engine CD17	GC041039	Outer Joint		25	22	52.3	107.4	55.7 M
<b>PULSAR / ALMERA (SN14)</b>														
1.7	1990.08-	1995.01	MT&AT			Engine CD17	GC034024	Outer Joint		25	22	55	107	57 M
	1990.08-	1995.01	MT&AT			Engine CD17	GC041191	Outer Joint	42T	25	22	55	107	57 M
<b>PULSAR / ALMERA (SN15)</b>														
2.0	1995.01-		MT&AT			Engine CD20	GC041033	Outer Joint		25	23	55	107	61 I
	1995.01-		MT&AT			Engine CD20	GC041034	Outer Joint	42T	25	23	55	107	61 I



		TRANSM	L/R	F/R		G-AP Ref.	PRODUCT	ABS	Technical Specifications					
									YEAR	A	B	C	H	L
<b>NISSAN</b>														
<b>PULSAR / ALMERA (SNN15)</b>														
2.0 4WD	1995.01-		MT		Engine CD20	GC041033	Outer Joint		25	23	55	107	61	I
	1995.01-		MT		Engine CD20	GC041034	Outer Joint	42T	25	23	55	107	61	I
<b>PULSAR / LUCINO / ALMERA (EN13)</b>														
1.6	1986.05-	1990.07	MT&AT		Engine CA16D	GC099204	Outer Joint		25	25	52.3	106.5	62	M
<b>PULSAR / LUCINO / ALMERA (EN14)</b>														
1.6	1990.08-	1995.01	MT		Engine GA16DE	GC041033	Outer Joint		25	23	55	107	61	I
	1990.08-	1995.01	MT&AT		Engine GA16DE	GC041034	Outer Joint	42T	25	23	55	107	61	I
<b>PULSAR / LUCINO / ALMERA (EN15)</b>														
1.6	1995.01-		MT&AT		Engine GA16DE	GC041033	Outer Joint		25	23	55	107	61	I
	1995.01-		5MT		Engine GA16DE	GC041034	Outer Joint	42T	25	23	55	107	61	I
	1995.01-		MT&AT		Engine GA16DE	GC041034	Outer Joint	42T	25	23	55	107	61	I
<b>PULSAR / LUCINO / ALMERA (FN13)</b>														
1.5	1988.04-	1990.07	4AT		Engine GA15S E	GC041039	Outer Joint		25	22	52.3	107.4	55.7	M
	1988.04-	1990.07	MT/AT		Engine GA15S E	GC041039	Outer Joint		25	22	52.3	107.4	55.7	M
<b>PULSAR / LUCINO / ALMERA (FN14)</b>														
1.5	1990.08-	1995.01	MT&AT		Engine GA15DS	GC034024	Outer Joint		25	22	55	107	57	M
	1990.08-	1995.01	MT&AT		Engine GA15DS	GC041191	Outer Joint	42T	25	22	55	107	57	M
<b>PULSAR / LUCINO / ALMERA (FN15)</b>														
1.5	1995.01-	2000.08	MT&AT		Engine GA15DE	GC034024	Outer Joint		25	22	55	107	57	M
	1995.01-	2000.08	5MT		Engine GA15DE	GC041034	Outer Joint	42T	25	23	55	107	61	I
	1995.01-	2000.08	MT&AT		Engine GA15DE	GC041191	Outer Joint	42T	25	22	55	107	57	M
<b>PULSAR / LUCINO / ALMERA (FNN13)</b>														
1.5 4WD	1988.04-	1990.07	MT/AT		Engine GA15S E	GC041023	Outer Joint		27	23	56	103	61.5	M
<b>PULSAR / LUCINO / ALMERA (FNN14)</b>														
1.5 4WD	1990.08-	1995.01	MT&AT		Engine GA15DS	GC041033	Outer Joint		25	23	55	107	61	I
	1990.08-	1995.01	MT&AT		Engine GA15DS	GC041034	Outer Joint	42T	25	23	55	107	61	I
<b>PULSAR / LUCINO / ALMERA (FNN15)</b>														
1.5 4WD	1995.01-	2000.08	AT		Engine GA15DE	GC041033	Outer Joint		25	23	55	107	61	I
	1995.01-	2000.08	MT		Engine GA15DS	GC041033	Outer Joint		25	23	55	107	61	I
	1995.01-	2000.08	AT		Engine GA15DE	GC041034	Outer Joint	42T	25	23	55	107	61	I
	1995.01-	2000.08	MT		Engine GA15DS	GC041034	Outer Joint	42T	25	23	55	107	61	I
<b>PULSAR / LUCINO / ALMERA (HN12)</b>														
1.5	1981.01-	1986.01	MT/AT		Engine E15	GC041041	Outer Joint		24	22	52	105	56	M
	1982.05-	1986.10	AT		Engine E15	GC041041	Outer Joint		24	22	52	105	56	M
<b>PULSAR / LUCINO / ALMERA (HN13)</b>														
1.5	1986.05-	1988.04	MT		Engine E15S E	GC041039	Outer Joint		25	22	52.3	107.4	55.7	M
	1986.05-	1988.04	AT		Engine E15S E	GC099204	Outer Joint		25	25	52.3	106.5	62	M
<b>PULSAR / LUCINO / ALMERA (HNN13)</b>														
1.5 4WD	1986.05-	1988.04	MT/AT		Engine E15S E	GC099204	Outer Joint		25	25	52.3	106.5	62	M
<b>PULSAR SE MODEL DOHC</b>														
-	1987-	1990				GC041077	Outer Joint		25	23	52.3	107	62	I
<b>QASHQAI</b>														
-	2006-					GC041214	Outer Joint		29	35	56.1	102	59	I
<b>QASHQAI (J10, JJ10)</b>														
1.5 DCi (76 kW)	2008.07-					GC041214	Outer Joint		29	35	56.1	102	59	I
1.5 DCi (78 kW)	2007.02-					GC041214	Outer Joint		29	35	56.1	102	59	I
2.0 4WD (103 kW)	2007.02-					GC041249	Outer Joint		29	36	56	102	72	I
2.0 DCi 4WD (110 kW)	2007.02-					GC041249	Outer Joint		29	36	56	102	72	I
<b>QASHQAI / QASHQAI +2 (J10, JJ10)</b>														
1.5 DCi (76 kW)	2008.07-			F	Closed Off-Road Vehicle	GC041214	Outer Joint		29	35	56.1	102	59	I
	2008.07-		MT	L	F Closed Off-Road Vehicle	GDS41329	Drive Shaft		29	26	56.1	102	692	
1.5 DCi (78 kW)	2007.02-			F	Closed Off-Road Vehicle	GC041214	Outer Joint		29	35	56.1	102	59	I
	2007.02-		MT	L	F Closed Off-Road Vehicle	GDS41329	Drive Shaft		29	26	56.1	102	692	
1.5 DCi (81 kW)	2010.11-			F	Closed Off-Road Vehicle	GC041214	Outer Joint		29	35	56.1	102	59	I
	2010.11-		MT	L	F Closed Off-Road Vehicle	GDS41329	Drive Shaft		29	26	56.1	102	692	
1.6 (84 kW)	2007.02-		5MT		Closed Off-Road Vehicle Engine HR16DE	GC041286	Outer Joint		29	33	56	102	57.5	I
	2007.02-		MT	L	F Closed Off-Road Vehicle Engine HR16DE	GDS41329	Drive Shaft		29	26	56.1	102	692	
	2007.02-		MT	R	F Closed Off-Road Vehicle Engine HR16DE	GDS41301	Drive Shaft		29	26	56	102	940	
	2007.02-			R	F Closed Off-Road Vehicle Engine HR16DE	GCI41157	Inner Joint		26	30	33	321.5	104.5	
1.6 (86 kW)	2010.11-		5MT		F Closed Off-Road Vehicle Engine HR16DE	GC041286	Outer Joint		29	33	56	102	57.5	I
	2010.11-		MT	L	F Closed Off-Road Vehicle Engine HR16DE	GDS41329	Drive Shaft		29	26	56.1	102	692	
	2010.11-		MT	R	F Closed Off-Road Vehicle Engine HR16DE	GDS41301	Drive Shaft		29	26	56	102	940	

		TRANSM	L/R	F/R		G-AP Ref.	PRODUCT	ABS	Technical Specifications									
									YEAR	A	B	C	H	L	P			
<b>NISSAN</b>																		
<b>QASHQAI / QASHQAI +2 (J10, JJ10)</b>																		
1.6 (86 kW)	2010.11-				Closed Off-Road Vehicle Engine HR16DE	GCI41157	Inner Joint		26	30	33	321.5	104.5					
1.6 DCi (96 kW)	2011.10-			R	F	Closed Off-Road Vehicle Engine R9M	GCI41131	Inner Joint	29	29	33	482	100					
	2011.10-			R	F	Closed Off-Road Vehicle Engine R9M	GC041249	Outer Joint	29	36	56	102	72	I				
	2011.10-					Closed Off-Road Vehicle Engine R9M	GC041285	Outer Joint	48T	25	24	56	110.5	38.5	I			
	2011.10-				F	Closed Off-Road Vehicle Engine R9M	GC041285	Outer Joint	48T	25	24	56	110.5	38.5	I			
	2011.10-			R	F	Closed Off-Road Vehicle Engine R9M	GDS41441	Drive Shaft	29	29	56	102	1009					
2.0 (102 kW)	2007.02-			L	F	Closed Off-Road Vehicle Engine MR20DE	GCI41108	Inner Joint	27	33	40	107	114					
2.0 (104 kW)	2010.11-					Closed Off-Road Vehicle Engine MR20DE	GC041214	Outer Joint	29	35	56.1	102	59	I				
	2010.11-					Closed Off-Road Vehicle Engine MR20DE	GC041285	Outer Joint	48T	25	24	56	110.5	38.5	I			
	2010.11-				F	Closed Off-Road Vehicle Engine MR20DE	GC041214	Outer Joint	29	35	56.1	102	59	I				
	2010.11-				F	Closed Off-Road Vehicle Engine MR20DE	GC041285	Outer Joint	48T	25	24	56	110.5	38.5	I			
	2010.11-			L	F	Closed Off-Road Vehicle Engine MR20DE	GCI41108	Inner Joint	27	33	40	107	114					
2.0 DCi (110 kW)	2007.02-					Closed Off-Road Vehicle Engine M1D/M9R	GC041249	Outer Joint	29	36	56	102	72	I				
	2007.02-					Closed Off-Road Vehicle Engine M1D/M9R	GC041285	Outer Joint	48T	25	24	56	110.5	38.5	I			
	2007.02-				F	Closed Off-Road Vehicle Engine M1D/M9R	GC041249	Outer Joint	29	36	56	102	72	I				
	2007.02-				F	Closed Off-Road Vehicle Engine M1D/M9R	GC041285	Outer Joint	48T	25	24	56	110.5	38.5	I			
	2007.02-		AT	L	F	Closed Off-Road Vehicle Engine M1D/M9R	GDS41365	Drive Shaft	29	30	56	102	650					
	2007.02-		MT/AT	L	F	Closed Off-Road Vehicle Engine M1D/M9R	GDS41286	Drive Shaft	29	29	56	102	649					
	2007.02-		MT/AT	L	F	Closed Off-Road Vehicle Engine M1D/M9R	GCI41076	Inner Joint	29	29	39	65.5	116					
	2007.02-		MT/AT	R	F	Closed Off-Road Vehicle Engine M1D/M9R	GDS41299	Drive Shaft	29	29	56	102	979					
	2007.02-			R	F	Closed Off-Road Vehicle Engine M1D/M9R	GDS41441	Drive Shaft	29	29	56	102	1009					
	2007.02-			R	F	Closed Off-Road Vehicle Engine M1D/M9R	GCI41131	Inner Joint	29	29	33	482	100					
	2007.02-			R	F	Closed Off-Road Vehicle Engine M1D/M9R	GC041249	Outer Joint	29	36	56	102	72	I				
	2007.02-					Closed Off-Road Vehicle Engine M1D/M9R	GDS41475	Drive Shaft	29	30	56	102	971					
	<b>QUEST</b>																	
-	1993-1999					GC018075	Outer Joint		32	34	62	117.5	71.5	I				
-	1993-1999					GC035017	Outer Joint	50T	32	34	62	117.5	71.5	I				
<b>RASHEEN (RFNB14)</b>																		
1.5	1994.12-1997.01	MT&AT			Engine GA15DE	GC041033	Outer Joint		25	23	55	107	61	I				
	1994.12-1997.01	MT&AT			Engine GA15DE	GC041034	Outer Joint	42T	25	23	55	107	61	I				
<b>ROGUE</b>																		
-	2007-					GC041214	Outer Joint		29	35	56.1	102	59	I				
<b>S-CARGO (G20)</b>																		
1.5	1989.01-1990.11	AT			Engine E15S	GC041041	Outer Joint		24	22	52	105	56	M				
<b>SAFARI PATROL (Y61)</b>																		
3.0	1999.09-2002.11	4AT/F			Engine ZD30DDTI	GC041053	Outer Joint		31	28	60	162.5	66	I				
	1999.09-2002.11	5MT/F			Engine ZD30DDTI	GC041053	Outer Joint		31	28	60	162.5	66	I				
4.8	2002.11-	5MT/F			Engine TB48DE	GC041053	Outer Joint		31	28	60	162.5	66	I				
<b>SENTRA</b>																		
-	1982-1986				SN12 SB12 VSB11 WSB11	GC041065	Outer Joint		24	22	52	104	57	M				
	1992.01-1995.12	MT/AT				GC041084	Outer Joint		25	24	55	105	62	I				
	2001-2002	AT				GCI41037	Inner Joint		25	32	40	63	107					
	2001-2002	MT				GCI41028	Inner Joint		25	32	40	63	108					
	2001-2002	MT/AT				GCI41028	Inner Joint		25	32	40	63	108					
	2006-					GC041214	Outer Joint		29	35	56.1	102	59	I				
1.3	1988-				321	GC041069	Outer Joint		25	22	52.2	107	55.5	M				
1.3 2WD	1982-1990					GCI41001	Inner Joint		24	23	40	51.7	100.4					
1.4 2WD	1982-1990					GCI41001	Inner Joint		24	23	40	51.7	100.4					
1.6 (WPB11)	1988.01-1992.12	MT			Engine E16S	GC041083	Outer Joint		25	24	52.3	107	62	I				
1.6/2.4	1987-1990					GC041077	Outer Joint		25	23	52.3	107	62	I				
<b>SENTRA DOHC</b>																		
-	1987-1990					GC041077	Outer Joint		25	23	52.3	107	62	I				
<b>SENTRA HS</b>																		
-	2001-2002					GC041092	Outer Joint		25	32	55	105	62	I				
	2001-2002	MT/AT				GC041135	Outer Joint	42T	25	32	55	105	62	I				
<b>SERENA (BC24)</b>																		
2.0 4WD	2001.12-	4AT/C			Engine QR20DE	GC041184	Outer Joint	44T	27	25	56	103	68	M				
2.5	2001.12-	4AT/C			Engine QR25DE	GC041184	Outer Joint	44T	27	25	56	103	68	M				
<b>SERENA (C23)</b>																		
2.0 4WD	1991.06-1994.05	MT/AT			Engine CD20T/SR20DE	GC041023	Outer Joint		27	23	56	103	61.5	M				
	1991.06-1999.06	MT/AT			Engine CD20T/SR20DE	GC041024	Outer Joint	42T	27	23	56	103	61.5	M				









		TRANSM	L/R	F/R		G-AP Ref.	PRODUCT	ABS	Technical Specifications							
									YEAR	A	B	C	H	L	P	
<b>NISSAN</b>																
<b>SERENA (C23)</b>																
2.0 4WD	1997.01-	1999.06	5MT		Engine CD20ET	GC041023	Outer Joint		27	23	56	103	61.5	M		
	1997.01-	1999.06	5MT		Engine CD20ET	GC041024	Outer Joint	42T	27	23	56	103	61.5	M		
<b>SERENA (C23M)</b>																
1.6 16V (71 kW)	1993.02-	2001.09		R	MPV Engine GA16DE	GC041176	Outer Joint		27	23	56	104	63	I		
2.0 16V (93 kW)	1992.11-	2001.09	MT/AT	R	MPV Engine SR20DE	GC041018	Outer Joint		27	23	56	99	60	I		
	1992.11-	2001.09		R	MPV Engine SR20DE	GC041176	Outer Joint		27	23	56	104	63	I		
2.0 D (49 kW)	1992.11-	2001.09	MT/AT	R	MPV Engine LD20	GC041018	Outer Joint		27	23	56	99	60	I		
	1992.11-	2001.09		R	MPV Engine LD20	GC041176	Outer Joint		27	23	56	104	63	I		
<b>SERENA (VC24)</b>																
2.0	2001.12-		CVT/C		Engine QR20DE	GC041184	Outer Joint	44T	27	25	56	103	68	M		
<b>SPIRIT</b>																
1.6	1990-			R	B13 GA13 GA16DE GA16DS	GCI41002	Inner Joint		25	23	40	63	101			
<b>STANZA</b>																
-	1990-	1992				GC041062	Outer Joint	44T	27	25	56	103	70.5	I		
<b>STANZA (T11)</b>																
1.6 (60 kW)	1981.08-	1985.12	MT	F	Hatchback Engine CA16S	GC041060	Outer Joint		24	22	52	105	56	I		
	1981.08-	1985.12	MT	F	Saloon Engine CA16S	GC041060	Outer Joint		24	22	52	105	56	I		
	1981.08-	1985.12		F	Hatchback Engine CA16S	GC041177	Outer Joint		24	23	52	104.5	60	I		
	1981.08-	1985.12		F	Saloon Engine CA16S	GC041177	Outer Joint		24	23	52	104.5	60	I		
1.8 (65 kW)	1981.08-	1985.12	MT	F	Hatchback Engine CA18/CA18S	GC041060	Outer Joint		24	22	52	105	56	I		
	1981.08-	1985.12		F	Hatchback Engine CA18/CA18S	GC041177	Outer Joint		24	23	52	104.5	60	I		
1.8 (66 kW)	1981.08-	1985.12	MT	F	Hatchback Engine CA18S	GC041060	Outer Joint		24	22	52	105	56	I		
	1981.08-	1985.12		F	Hatchback Engine CA18S	GC041177	Outer Joint		24	23	52	104.5	60	I		
1.8 SGL (66 kW)	1983.03-	1985.12	MT	F	Saloon Engine CA18S	GC041060	Outer Joint		24	22	52	105	56	I		
	1983.03-	1985.12		F	Saloon Engine CA18S	GC041177	Outer Joint		24	23	52	104.5	60	I		
<b>STANZA (T12)</b>																
1.8 Turbo (PT12)	1985.01-	1988.12	MT		Engine CA18TE	GC041063	Outer Joint		27	25	56	103	70.5	I		
<b>SUNNY</b>																
1.3	1993-				BM10 PM10	GC099187	Outer Joint		24	23	52	104.5	60	I		
1.5	1982-	1986			HN12 HB11 VHB11 PHB11	GC041065	Outer Joint		24	22	52	104	57	M		
1.6	1982-	1986			HN12 HB11 VHB11 PHB11	GC041065	Outer Joint		24	22	52	104	57	M		
	1990-			R	B13 GA13 GA16DE GA16DS	GCI41002	Inner Joint		25	23	40	63	101			
<b>SUNNY (B11)</b>																
1.3 (44 kW)	1982.03-	1987.09	MT	F	Saloon Engine E13	GC041170	Outer Joint		21	22	48	98	57	I		
	1982.03-	1987.09			Saloon Engine E13	GC041069	Outer Joint		25	22	52.2	107	55.5	M		
	1982.08-	1990.08	MT	F	Estate Engine E13	GC041170	Outer Joint		21	22	48	98	57	I		
	1982.08-	1990.08			Estate Engine E13	GC041069	Outer Joint		25	22	52.2	107	55.5	M		
1.5 (55 kW)	1982.03-	1986.10	MT/AT	F	Coupe Engine E15S	GC041060	Outer Joint		24	22	52	105	56	I		
	1982.03-	1986.10	MT/AT	F	Saloon Engine E15S	GC041060	Outer Joint		24	22	52	105	56	I		
	1982.03-	1986.10	MT/AT	F	Estate Engine E15S	GC041060	Outer Joint		24	22	52	105	56	I		
	1982.03-	1986.10		F	Coupe Engine E15S	GC041177	Outer Joint		24	23	52	104.5	60	I		
	1982.03-	1986.10		F	Saloon Engine E15S	GC041177	Outer Joint		24	23	52	104.5	60	I		
	1982.03-	1986.10		F	Estate Engine E15S	GC041177	Outer Joint		24	23	52	104.5	60	I		
1.7 D (40 kW)	1982.03-	1986.10	MT/AT	F	Saloon Engine CD17	GC041060	Outer Joint		24	22	52	105	56	I		
	1982.03-	1986.10	MT/AT	F	Estate Engine CD17	GC041060	Outer Joint		24	22	52	105	56	I		
	1982.03-	1986.10		F	Saloon Engine CD17	GC041177	Outer Joint		24	23	52	104.5	60	I		
	1982.03-	1986.10		F	Estate Engine CD17	GC041177	Outer Joint		24	23	52	104.5	60	I		
<b>SUNNY (Y10)</b>																
1.6 i 16V (66 kW)	1992.10-	2000.03		F	Box Engine GA16DE	GC099199	Outer Joint		25	23	55	107	62	M		
1.7 D (40 kW)	1990.11-	2000.03		F	Box Engine CD17	GC041191	Outer Joint	42T	25	22	55	107	57	M		
<b>SUNNY / SENTRA (B11)</b>																
1.3	1981.10-	1985.09	MT/AT		Engine E13	GC041281	Outer Joint		21	22	48	98.5	56.5	M		
1.5	1981.01-	1986.01	MT/AT		Engine E15S/E15	GC041041	Outer Joint		24	22	52	105	56	M		
<b>SUNNY / SENTRA (B12)</b>																
1.3	1985.09-	1990.01	MT/AT		Engine E13	GC041039	Outer Joint		25	22	52.3	107.4	55.7	M		
1.5	1985.09-	1990.01	MT/AT		Engine E15S E/GA15S E	GC041039	Outer Joint		25	22	52.3	107.4	55.7	M		
	1985.09-	1987.09	MT		Engine E15T	GC099204	Outer Joint		25	25	52.3	106.5	62	M		
	1985.09-	1988.01	MT/AT		Engine E15S E	GC099204	Outer Joint		25	25	52.3	106.5	62	M		
	1985.09-	1997.09	AT		Engine E15T	GC099204	Outer Joint		25	25	52.3	106.5	62	M		
	1987.01-	1990.01	4AT		Engine GA15S E	GC041039	Outer Joint		25	22	52.3	107.4	55.7	M		



		YEAR	TRANSM	L/R	F/R		G-AP Ref.	PRODUCT	ABS	Technical Specifications						
										A	B	C	H	L	P	
<b>NISSAN</b>																
<b>SUNNY / SENTRA (B12)</b>																
1.5 4WD	1985.09-	1987.09	MT/AT			Engine E15S	GC099204	Outer Joint		25	25	52.3	106.5	62	M	
	1987.09-	1990.01	MT/AT			Engine GA15S E	GC041023	Outer Joint		27	23	56	103	61.5	M	
<b>SUNNY / SENTRA (B13)</b>																
1.3	1990.01-	1994.01	MT/AT			Engine GA13DS	GC034024	Outer Joint		25	22	55	107	57	M	
	1990.01-	1994.01	MT			Engine GA13DS	GC034024	Outer Joint		25	22	55	107	57	M	
1.5	1990.01-	1994.01	MT&AT			Engine GA15DS	GC034024	Outer Joint		25	22	55	107	57	M	
	1990.01-	1994.01	MT/AT			Engine GA15DS	GC034024	Outer Joint		25	22	55	107	57	M	
	1990.01-	1994.01	AT			Engine GA15DS	GC041191	Outer Joint	42T	25	22	55	107	57	M	
	1990.01-	1994.01	MT/AT			Engine GA15DS	GC041191	Outer Joint	42T	25	22	55	107	57	M	
1.5 4WD	1990.01-	1994.01	AT			Engine GA15DS	GC041033	Outer Joint		25	23	55	107	61	I	
	1990.01-	1994.01	MT/AT			Engine GA15DS	GC041033	Outer Joint		25	23	55	107	61	I	
	1990.01-	1994.01	MT/AT			Engine GA15DS	GC041034	Outer Joint	42T	25	23	55	107	61	I	
1.8 4WD	1990.01-	1994.01	MT&AT			Engine SR18DE	GC041033	Outer Joint		25	23	55	107	61	I	
	1990.01-	1994.01	MT&AT			Engine SR18DE	GC041034	Outer Joint	42T	25	23	55	107	61	I	
<b>SUNNY / SENTRA (B14)</b>																
1.3	1994.01-	1998.10	MT&AT			Engine GA13DE	GC034024	Outer Joint		25	22	55	107	57	M	
1.5	1994.01-	1998.10	MT&AT			Engine GA15DE	GC034024	Outer Joint		25	22	55	107	57	M	
	1994.01-	1998.10	AT			Engine GA15DE	GC041033	Outer Joint		25	23	55	107	61	I	
	1994.01-	1998.10	MT&AT			Engine GA15DE	GC041191	Outer Joint	42T	25	22	55	107	57	M	
1.5 4WD	1994.01-	1998.10	MT&AT			Engine GA15DE	GC041033	Outer Joint		25	23	55	107	61	I	
	1994.01-	1998.10	MT&AT			Engine GA15DE	GC041034	Outer Joint	42T	25	23	55	107	61	I	
<b>SUNNY / SENTRA (B15)</b>																
1.3	1998.10-		4AT			Engine QG13DE	GC041239	Outer Joint		25	22	55	107	57	M	
	1998.10-		5MT			Engine QG13DE	GC041239	Outer Joint		25	22	55	107	57	M	
	1998.10-		4AT			Engine QG13DE	GC041159	Outer Joint	42T	25	22	55	107	57	M	
	1998.10-		5MT			Engine QG13DE	GC041159	Outer Joint	42T	25	22	55	107	57	M	
1.5	1998.10-		4AT			Engine QG15DE/QG15DELEV	GC041239	Outer Joint		25	22	55	107	57	M	
	1998.10-		5MT			Engine QG15DE/QG15DELEV	GC041239	Outer Joint		25	22	55	107	57	M	
	1998.10-		4AT			Engine QG15DE/QG15DELEV	GC041159	Outer Joint	42T	25	22	55	107	57	M	
	1998.10-		5MT			Engine QG15DE/QG15DELEV	GC041159	Outer Joint	42T	25	22	55	107	57	M	
2.2	1999.09-	2002.05	4AT			Engine YD22DD	GC041118	Outer Joint		25	23	55	107	61	M	
	1999.09-	2002.05	4AT			Engine YD22DD	GC041155	Outer Joint	42T	25	23	55	107	61	M	
	1999.09-	2002.05	5MT			Engine YD22DD	GC041118	Outer Joint		25	23	55	107	61	M	
	1999.09-	2002.05	5MT			Engine YD22DD	GC041155	Outer Joint	42T	25	23	55	107	61	M	
<b>SUNNY / SENTRA (EB12)</b>																
1.6	1986.01-	1990.01	MT/AT			Engine CA16D	GC099204	Outer Joint		25	25	52.3	106.5	62	M	
	1986.08-	1990.01	AT			Engine CA16D	GC099204	Outer Joint		25	25	52.3	106.5	62	M	
<b>SUNNY / SENTRA (EB13)</b>																
1.6	1990.01-	1994.01	MT/AT			Engine GA16DE	GC041033	Outer Joint		25	23	55	107	61	I	
	1990.01-	1994.01	MT/AT			Engine GA16DE	GC041034	Outer Joint	42T	25	23	55	107	61	I	
<b>SUNNY / SENTRA (EB14)</b>																
1.6	1994.01-	1998.10	MT&AT			Engine GA16DE	GC041033	Outer Joint		25	23	55	107	61	I	
	1994.01-	1998.10	MT			Engine GA16DE	GC041034	Outer Joint	42T	25	23	55	107	61	I	
<b>SUNNY / SENTRA (SB11)</b>																
1.7	1982.01-	1985.01	AT			Engine CD17	GC041041	Outer Joint		24	22	52	105	56	M	
	1982.01-	1985.09	MT			Engine CD17	GC041041	Outer Joint		24	22	52	105	56	M	
<b>SUNNY / SENTRA (SB12)</b>																
1.7	1985.01-	1990.01	MT			Engine CD17	GC041039	Outer Joint		25	22	52.3	107.4	55.7	M	
<b>SUNNY / SENTRA (SB13)</b>																
1.7	1990.01-	1994.01	MT&AT			Engine CD17	GC034024	Outer Joint		25	22	55	107	57	M	
	1990.01-	1994.01	MT&AT			Engine CD17	GC041191	Outer Joint	42T	25	22	55	107	57	M	
<b>SUNNY / SENTRA (SB14)</b>																
2.0	1994.01-	1998.10	MT&AT			Engine CD20	GC041033	Outer Joint		25	23	55	107	61	I	
	1994.01-	1998.10	MT&AT			Engine CD20	GC041034	Outer Joint	42T	25	23	55	107	61	I	
<b>SUNNY / SENTRA (SNB13)</b>																
1.7 4WD	1990.01-	1994.01	MT/AT			Engine CD17	GC041033	Outer Joint		25	23	55	107	61	I	
<b>SUNNY / SENTRA (SNB14)</b>																
2.0 4WD	1994.01-	1998.10	MT/AT			Engine CD20	GC041033	Outer Joint		25	23	55	107	61	I	
	1994.01-	1998.10	MT/AT			Engine CD20	GC041034	Outer Joint	42T	25	23	55	107	61	I	
<b>SUNNY II (B12)</b>																
1.6 (62 kW)	1986.06-	1988.10	AT		F	Coupe Engine E16S	GC041105	Outer Joint		25	22	52.2	107	55.5	I	
	1986.06-	1988.10	AT		F	Estate Engine E16S	GC041105	Outer Joint		25	22	52.2	107	55.5	I	

		TRANSM	L/R	F/R		G-AP Ref.	PRODUCT	ABS	Technical Specifications						
									YEAR	A	B	C	H	L	P
<b>NISSAN</b>															
<b>SUNNY II (B12)</b>															
1.6 (62 kW)	1986.06-	1988.10	MT		F	Coupe Engine E16S	GC041008	Outer Joint		25	23	52.2	102	62	I
	1986.06-	1988.10	MT		F	Estate Engine E16S	GC041008	Outer Joint		25	23	52.2	102	62	I
	1986.06-	1988.10	AT			Coupe Engine E16S	GC041069	Outer Joint		25	22	52.2	107	55.5	M
	1986.06-	1988.10	AT			Estate Engine E16S	GC041069	Outer Joint		25	22	52.2	107	55.5	M
1.6 GTi 16V (81 kW)	1987.05-	1989.05			F	Coupe Engine CA16D	GC041068	Outer Joint		25	23	52.2	107	62.5	I
1.6 i (54 kW)	1986.06-	1989.05	AT		F	Coupe Engine E16i	GC041073	Outer Joint		25	22	52.2	103	56	I
	1986.06-	1989.05				Coupe Engine E16i	GC041069	Outer Joint		25	22	52.2	107	55.5	M
	1986.06-	1989.05	MT		F	Coupe Engine E16i	GC041008	Outer Joint		25	23	52.2	102	62	I
	1986.08-	1989.05	AT		F	Estate Engine E16i	GC041073	Outer Joint		25	22	52.2	103	56	I
	1986.08-	1989.05	MT		F	Estate Engine E16i	GC041008	Outer Joint		25	23	52.2	102	62	I
	1986.08-	1989.05	AT			Estate Engine E16i	GC041069	Outer Joint		25	22	52.2	107	55.5	M
1.6 i 12V (66 kW)	1988.10-	1991.06				Coupe Engine GA16i	GC041069	Outer Joint		25	22	52.2	107	55.5	M
	1988.10-	1991.06	AT		F	Coupe Engine GA16i	GC041073	Outer Joint		25	22	52.2	103	56	I
	1988.10-	1991.06	AT			Estate Engine GA16i	GC041069	Outer Joint		25	22	52.2	107	55.5	M
	1988.10-	1991.06	AT		F	Estate Engine GA16i	GC041073	Outer Joint		25	22	52.2	103	56	I
	1988.10-	1991.06	MT		F	Coupe Engine GA16i	GC041008	Outer Joint		25	23	52.2	102	62	I
	1988.10-	1991.06	MT		F	Estate Engine GA16i	GC041008	Outer Joint		25	23	52.2	102	62	I
1.6 i 4x4 (54 kW)	1986.06-	1989.05	AT		F	Estate Engine E16i	GC041073	Outer Joint		25	22	52.2	103	56	I
	1986.06-	1989.05	MT		F	Estate Engine E16i	GC041008	Outer Joint		25	23	52.2	102	62	I
1.6 SGX (70 kW)	1988.10-	1990.09	AT			Coupe	GC041069	Outer Joint		25	22	52.2	107	55.5	M
1.7 D (40 kW)	1986.01-	1991.06	MT		F	Estate Engine CD17	GC041105	Outer Joint		25	22	52.2	107	55.5	I
	1986.01-	1991.06	MT		F	Estate Engine CD17	GC041073	Outer Joint		25	22	52.2	103	56	I
<b>SUNNY II (N13)</b>															
1.0 (37 kW)	1986.07-	1990.09				Hatchback Engine E10S	GC041069	Outer Joint		25	22	52.2	107	55.5	M
1.3 (44 kW)	1986.06-	1988.10			F	Hatchback Engine E13S	GC041069	Outer Joint		25	22	52.2	107	55.5	M
	1986.06-	1988.10	MT		F	Hatchback Engine E13S	GC041105	Outer Joint		25	22	52.2	107	55.5	I
	1986.06-	1988.10	MT		F	Hatchback Engine E13S	GC041073	Outer Joint		25	22	52.2	103	56	I
	1986.07-	1991.10	MT		F	Saloon Engine E13S	GC041105	Outer Joint		25	22	52.2	107	55.5	I
	1986.07-	1991.10	MT		F	Saloon Engine E13S	GC041073	Outer Joint		25	22	52.2	103	56	I
1.4 LX (55 kW)	1988.10-	1991.08	MT		F	Saloon Engine GA14S	GC041073	Outer Joint		25	22	52.2	103	56	I
	1989.01-	1991.08				Hatchback Engine GA14S	GC041069	Outer Joint		25	22	52.2	107	55.5	M
	1989.01-	1991.08	MT		F	Hatchback Engine GA14S	GC041073	Outer Joint		25	22	52.2	103	56	I
1.6 (62 kW)	1986.06-	1988.10	AT			Saloon Engine E16S	GC041069	Outer Joint		25	22	52.2	107	55.5	M
	1986.06-	1988.10	AT			Hatchback Engine E16S	GC041069	Outer Joint		25	22	52.2	107	55.5	M
	1986.06-	1988.10	AT		F	Hatchback Engine E16S	GC041105	Outer Joint		25	22	52.2	107	55.5	I
	1986.06-	1988.10	AT		F	Saloon Engine E16S	GC041105	Outer Joint		25	22	52.2	107	55.5	I
	1986.06-	1988.10	MT		F	Hatchback Engine E16S	GC041008	Outer Joint		25	23	52.2	102	62	I
	1986.06-	1988.10	MT		F	Saloon Engine E16S	GC041008	Outer Joint		25	23	52.2	102	62	I
1.6 i (54 kW)	1986.06-	1990.10	AT			Saloon Engine E16i	GC041069	Outer Joint		25	22	52.2	107	55.5	M
	1986.06-	1990.10	AT			Hatchback Engine E16i	GC041069	Outer Joint		25	22	52.2	107	55.5	M
	1986.06-	1990.10	AT		F	Hatchback Engine E16i	GC041073	Outer Joint		25	22	52.2	103	56	I
	1986.06-	1990.10	AT		F	Saloon Engine E16i	GC041073	Outer Joint		25	22	52.2	103	56	I
	1986.06-	1990.10	MT		F	Hatchback Engine E16i	GC041008	Outer Joint		25	23	52.2	102	62	I
	1986.06-	1990.10	MT		F	Saloon Engine E16i	GC041008	Outer Joint		25	23	52.2	102	62	I
1.6 i 12V (66 kW)	1986.06-	1990.10				Hatchback Engine GA16i	GC041069	Outer Joint		25	22	52.2	107	55.5	M
	1986.06-	1990.10	AT		F	Hatchback Engine GA16i	GC041073	Outer Joint		25	22	52.2	103	56	I
	1986.06-	1990.10	MT		F	Hatchback Engine GA16i	GC041008	Outer Joint		25	23	52.2	102	62	I
	1988.10-	1991.06	AT			Saloon Engine GA16i	GC041069	Outer Joint		25	22	52.2	107	55.5	M
	1988.10-	1991.06	AT		F	Saloon Engine GA16i	GC041073	Outer Joint		25	22	52.2	103	56	I
	1988.10-	1991.06	MT		F	Saloon Engine GA16i	GC041008	Outer Joint		25	23	52.2	102	62	I
1.6 i 4x4 (54 kW)	1986.06-	1990.10	AT		F	Saloon Engine E16i	GC041073	Outer Joint		25	22	52.2	103	56	I
	1986.06-	1990.10	MT		F	Saloon Engine E16i	GC041008	Outer Joint		25	23	52.2	102	62	I
1.7 D (40 kW)	1986.06-	1989.05				Saloon Engine CD17	GC041069	Outer Joint		25	22	52.2	107	55.5	M
	1986.06-	1991.01				Hatchback Engine CD17	GC041069	Outer Joint		25	22	52.2	107	55.5	M
	1986.06-	1989.05	MT		F	Saloon Engine CD17	GC041105	Outer Joint		25	22	52.2	107	55.5	I
	1986.06-	1991.01	MT		F	Hatchback Engine CD17	GC041105	Outer Joint		25	22	52.2	107	55.5	I
	1986.06-	1989.05	MT		F	Saloon Engine CD17	GC041073	Outer Joint		25	22	52.2	103	56	I
	1986.06-	1991.01	MT		F	Hatchback Engine CD17	GC041073	Outer Joint		25	22	52.2	103	56	I
<b>SUNNY III (N14)</b>															
1.4 (60 kW)	1990.10-	1995.06			F	Saloon Engine GA14DS	GC041191	Outer Joint	42T	25	22	55	107	57	M
	1990.10-	1995.06			F	Hatchback Engine GA14DS	GC041191	Outer Joint	42T	25	22	55	107	57	M
	1990.10-	1995.06	AT		F	Hatchback Engine GA14DS	GC099199	Outer Joint		25	23	55	107	62	M









		TRANSM	L/R	F/R		G-AP Ref.	PRODUCT	ABS	Technical Specifications								
									YEAR	A	B	C	H	L	P		
<b>NISSAN</b>																	
<b>SUNNY III (N14)</b>																	
1.4 (60 kW)	1990.10-	1995.06	AT		F	Saloon Engine GA14DS	GC099199	Outer Joint		25	23	55	107	62	M		
1.4 i (55 kW)	1990.10-	1995.05	MT/AT		F	Hatchback Engine GA14DE/GA14DS	GC041001	Outer Joint		25	22	55	107	56	I		
	1990.10-	1995.05			F	Saloon Engine GA14DE/GA14DS	GC041191	Outer Joint	42T	25	22	55	107	57	M		
	1990.10-	1995.05			F	Hatchback Engine GA14DE/GA14DS	GC041191	Outer Joint	42T	25	22	55	107	57	M		
	1990.10-	1995.05			F	Hatchback Engine GA14DE/GA14DS	GC041191	Outer Joint	42T	25	22	55	107	57	M		
	1990.10-	1995.05	MT		F	Saloon Engine GA14DE/GA14DS	GC041001	Outer Joint		25	22	55	107	56	I		
	1990.10-	1995.05	MT/AT		F	Hatchback Engine GA14DE/GA14DS	GC041001	Outer Joint		25	22	55	107	56	I		
1.4 i 16V (64 kW)	1990.10-	1995.05	MT			Hatchback Engine GA14DE	GC041001	Outer Joint		25	22	55	107	56	I		
	1990.10-	1995.06	MT			Hatchback Engine GA14DE	GC041001	Outer Joint		25	22	55	107	56	I		
	1990.10-	1995.06			F	Hatchback Engine GA14DE	GC041191	Outer Joint	42T	25	22	55	107	57	M		
	1990.10-	1995.05			F	Hatchback Engine GA14DE	GC041191	Outer Joint	42T	25	22	55	107	57	M		
	1993.01-	1995.10	MT			Saloon Engine GA14DE	GC041001	Outer Joint		25	22	55	107	56	I		
1.5 (51 kW)	1990.10-	1995.05	MT/AT			Hatchback	GC041001	Outer Joint		25	22	55	107	56	I		
	1990.10-	1995.05			F	Saloon Engine GA16DEL/GA16DS	GC099199	Outer Joint		25	23	55	107	62	M		
1.6 i (66 kW)	1990.10-	1995.05			F	Hatchback Engine GA16DE/GA16DS	GC099199	Outer Joint		25	23	55	107	62	M		
	1990.10-	1995.05			F	Hatchback Engine GA16DE/GA16DS	GC099199	Outer Joint		25	23	55	107	62	M		
1.6 i 16V (75 kW)	1992.10-	1995.05	MT	L/R	F	Hatchback Engine GA16DE	GC041078	Outer Joint		25	23	55	107	62	I		
	1992.10-	1995.05	MT	L/R	F	Hatchback Engine GA16DE	GC041003	Outer Joint	42T	25	23	55	107	62	I		
	1992.10-	1995.05			F	Saloon Engine GA16DE	GC099199	Outer Joint		25	23	55	107	62	M		
	1992.10-	1995.05	MT/AT		F	Saloon Engine GA16DE	GC041078	Outer Joint		25	23	55	107	62	I		
	1992.10-	1995.05	MT/AT		F	Saloon Engine GA16DE	GC041003	Outer Joint	42T	25	23	55	107	62	I		
2.0 D (55 kW)	1990.10-	1995.05	MT/AT		F	Hatchback Engine CD20	GC041001	Outer Joint		25	22	55	107	56	I		
	1990.10-	1995.05			F	Saloon Engine CD20	GC041191	Outer Joint	42T	25	22	55	107	57	M		
	1990.10-	1995.05			F	Hatchback Engine CD20	GC041191	Outer Joint	42T	25	22	55	107	57	M		
	1990.10-	1995.05			F	Hatchback Engine CD20	GC041191	Outer Joint	42T	25	22	55	107	57	M		
	1990.10-	1995.05	MT/AT		F	Hatchback Engine CD20	GC041001	Outer Joint		25	22	55	107	56	I		
	1990.10-	1995.05	MT/AT		F	Saloon Engine CD20	GC041001	Outer Joint		25	22	55	107	56	I		
2.0 GTi 16V (105 kW)	1990.10-	1995.05			F	Hatchback Engine SR20DE	GC041014	Outer Joint	42T	25	25	55	106.5	66	I		
	1990.10-	1995.05	MT		F	Hatchback Engine SR20DE	GC041087	Outer Joint		25	25	55	106.5	66	I		
2.0 GTi-R 4x4 (162 kW)	1990.10-	1995.05			F	Hatchback Engine SR20DET	GC099199	Outer Joint		25	23	55	107	62	M		
	1990.10-	1995.05	MT/AT			Hatchback Engine SR20DET	GC041078	Outer Joint		25	23	55	107	62	I		
	1990.10-	1995.05	MT/AT			Hatchback Engine SR20DET	GC041003	Outer Joint	42T	25	23	55	107	62	I		
2.0 i 16V (105 kW)	1990.10-	1995.05			F	Hatchback Engine SR20DE	GC041014	Outer Joint	42T	25	25	55	106.5	66	I		
	1990.10-	1995.05	MT		F	Hatchback Engine SR20DE	GC041087	Outer Joint		25	25	55	106.5	66	I		
<b>SUNNY III (Y10)</b>																	
1.6 i (66 kW)	1991.06-	2000.03			F	Estate Engine GA16DE/GA16DS	GC041068	Outer Joint		25	23	52.2	107	62.5	I		
	1991.06-	2000.03			F	Estate Engine GA16DE/GA16DS	GC099199	Outer Joint		25	23	55	107	62	M		
1.6 i 16V 4x4 (75 kW)	1992.10-	2000.03	MT/AT			Estate Engine GA16DE	GC041078	Outer Joint		25	23	55	107	62	I		
	1992.10-	2000.03	MT/AT			Estate Engine GA16DE	GC041003	Outer Joint	42T	25	23	55	107	62	I		
2.0 D (55 kW)	1991.06-	2000.03			F	Estate Engine CD20	GC041191	Outer Joint	42T	25	22	55	107	57	M		
<b>TEANA (J31)</b>																	
2.3	2003.02-	2008.06	4AT/F			Engine VQ23DE	GC041251	Outer Joint		29	24	56	103	62	M		
2.5	2003.02-	2008.06	AT			QR25DE 4WD	GC041250	Outer Joint		29	25	56	101	68	M		
3.5	2003.02-	2008.06	CVT			VQ35DE	GC041250	Outer Joint		29	25	56	101	68	M		
<b>TEANA (J32)</b>																	
2.5	2008.06-		CVT			Engine VQ25DE	GC041251	Outer Joint		29	24	56	103	62	M		
2.5 4WD	2008.06-		CVT			QR25DE	GC041252	Outer Joint		29	26	56	101	68	M		
3.5	2008.06-		CVT			Engine VQ35DE	GC041222	Outer Joint		32	27	56	102.5	67.5	M		
<b>TERRANO (WD21)</b>																	
2.7 TD 4WD (73 kW)	1989.02-	1996.02				Closed Off-Road Vehicle Engine TD27T	GC041178	Outer Joint		26	27	50	147.5	64	I		
<b>TERRANO / PATHFINDER (BYD21)</b>																	
2.7 4WD	1986.08-	1989.10	MT/AT			Engine TD27T	GC041051	Outer Joint		27	27	50	151	71	M		
<b>TERRANO / PATHFINDER (D21)</b>																	
2.7 4WD	1986.01-	1989.01	MT/AT			Engine TG27E	GC041051	Outer Joint		27	27	50	151	71	M		
	1989.10-		MT/AT			Engine TD27T	GC041085	Outer Joint		26	27	50	148	60	M		
3.0 4WD	1987.10-	1989.10	MT/AT			Engine VG30E	GC041051	Outer Joint		27	27	50	151	71	M		
<b>TERRANO II (R20)</b>																	
2.4 4WD (85 kW)	1996.05-	2002.01			F	Closed Off-Road Vehicle Engine KA24E	GC041025	Outer Joint		27	32	50	150	68.5	I		
	1996.05-	2002.01			F	Closed Off-Road Vehicle Engine KA24E	GC041086	Outer Joint		27	27	50	150	71	I		
	1996.05-	2002.01	MT	L/R	F	Closed Off-Road Vehicle Engine KA24E	GDS41464	Drive Shaft		27		50	150	521			
	1996.05-	2002.01			F	Closed Off-Road Vehicle Engine KA24E	GDS41055	Drive Shaft		27		50	150	520			



		TRANSM	L/R	F/R		G-AP Ref.	PRODUCT	ABS	Technical Specifications							
									YEAR	A	B	C	H	L	P	
<b>NISSAN</b>																
<b>TERRANO II (R20)</b>																
2.7 TD 4WD (74 kW)	1993.02-	2002.01			F	Closed Off-Road Vehicle Engine TD27T	GC041086	Outer Joint	27	27	50	150	71	I		
	1993.02-	2002.01	MT	L/R	F	Closed Off-Road Vehicle Engine TD27T	GDS41464	Drive Shaft	27		50	150	521			
	1993.02-	2002.01	MT/AT		F	Closed Off-Road Vehicle Engine TD27T	GDS41055	Drive Shaft	27		50	150	520			
3.0 Di 4WD (113 kW)	2002.05-				F	Closed Off-Road Vehicle Engine ZD30	GC041025	Outer Joint	27	32	50	150	68.5	I		
	2002.05-			L/R	F	Closed Off-Road Vehicle Engine ZD30	GDS41464	Drive Shaft	27		50	150	521			
	2002.05-		MT/AT		F	Closed Off-Road Vehicle Engine ZD30	GDS41055	Drive Shaft	27		50	150	520			
<b>TERRANO VAN (R20)</b>																
3.0 Di 4WD (113 kW)	2003.04-			L/R	F	Box Engine ZD30	GDS41464	Drive Shaft	27		50	150	521			
<b>TIIDA</b>																
1.6							GC041229	Outer Joint	25	32	49.1	95	61	I		
<b>TIIDA (C11)</b>																
-	2005-						GCI59036	Inner Joint	26	22	40	64.5	98			
1.5	2004.09-		CVT			Engine HR15DE	GC041302	Outer Joint	25	22	49	95	56	M		
	2006-		4AT			Engine HR15DE	GC041303	Outer Joint	25	21	49	95	56	M		
1.5 4WD	2004.09-	2010.08	4AT			Engine HR15DE	GC041302	Outer Joint	25	22	49	95	56	M		
1.8	2005.01-		CVT			Engine MR18DE	GC041302	Outer Joint	25	22	49	95	56	M		
	2008.01-	2010.08	6MT				GC041308	Outer Joint	25	23	49	95	56.5	M		
<b>TIIDA (C11X)</b>																
1.5 DCi (78 kW)	2007.09-				F	Hatchback Engine K9K728	GC041233	Outer Joint	25	24	49.1	95	61	M		
1.6 (81 kW)	2007.09-				F	Hatchback Engine HR16DE	GC041271	Outer Joint	25	22	49	94.5	59.5	M		
	2007.09-				F	Hatchback Engine HR16DE	GC041167	Outer Joint	25	22	49	94	56	M		
1.8 (93 kW)	2007.09-				F	Hatchback Engine MR18DE	GC041271	Outer Joint	25	22	49	94.5	59.5	M		
	2007.09-				F	Hatchback Engine MR18DE	GC041234	Outer Joint	25	23	49.1	92	57	M		
	2007.09-				F	Hatchback Engine MR18DE	GC041167	Outer Joint	25	22	49	94	56	M		
	2007.09-			L/R	F	Hatchback Engine MR18DE	GC041217	Outer Joint	25	23	49.15	94.5	63	M		
<b>TIIDA (C11_)</b>																
-	2005-						GCI41117	Inner Joint	25	22	40	63	98.5			
<b>TIIDA (SC11X)</b>																
1.5 DCi (78 kW)	2007.09-				F	Saloon	GC041233	Outer Joint	25	24	49.1	95	61	M		
1.6 (81 kW)	2007.09-				F	Saloon Engine HR16DE	GC041271	Outer Joint	25	22	49	94.5	59.5	M		
	2007.09-				F	Saloon Engine HR16DE	GC041167	Outer Joint	25	22	49	94	56	M		
1.8 (93 kW)	2007.09-				F	Saloon Engine MR18DE	GC041271	Outer Joint	25	22	49	94.5	59.5	M		
	2007.09-				F	Saloon Engine MR18DE	GC041234	Outer Joint	25	23	49.1	92	57	M		
	2007.09-			L/R	F	Saloon Engine MR18DE	GC041217	Outer Joint	25	23	49.15	94.5	63	M		
<b>TIIDA LATIO (C11)</b>																
1.5 4WD	2006.12-	2010.08	4AT			Engine HR15DE	GC041302	Outer Joint	25	22	49	95	56	M		
1.8	2008.01-	2010.08	6MT				GC041308	Outer Joint	25	23	49	95	56.5	M		
<b>TIIDA LATIO (SC11)</b>																
-	2005-						GCI59036	Inner Joint	26	22	40	64.5	98			
<b>TSUBAME</b>																
-	1993-	1997	MT				GCI41015	Inner Joint	25	24	40	63	108.5			
	1993.01-	1995.12	AT				GC041113	Outer Joint	25	24	55	96	62	I		
	1993.01-	1995.12	MT				GC041113	Outer Joint	25	24	55	96	62	I		
	1993.01-	1995.12	MT/AT				GC041084	Outer Joint	25	24	55	105	62	I		
	1998-	2002					GC041092	Outer Joint	25	32	55	105	62	I		
<b>TSURU</b>																
-	1986-	1987	MT/AT				GCI41016	Inner Joint	24	24	40	51.5	102.5			
	1988-	1992	MT/AT				GCI41016	Inner Joint	24	24	40	51.5	102.5			
	1992-	2000	MT				GCI41015	Inner Joint	25	24	40	63	108.5			
	2000-	2002					GC041092	Outer Joint	25	32	55	105	62	I		
<b>TSURU / TSUBAME</b>																
-	2001-	2002	AT				GCI41028	Inner Joint	25	32	40	63	108			
	2001-	2002	MT				GCI41032	Inner Joint	25	32	40	63	108			
1.6 16V	1992-	2000	MT				GCI41034	Inner Joint	25	24	40	63	108			
<b>TSURU GS</b>																
-	1992.01-	1995.12	AT				GC041113	Outer Joint	25	24	55	96	62	I		
	1992.01-	1995.12	MT				GC041113	Outer Joint	25	24	55	96	62	I		
<b>TSURU I</b>																
All Types	1984.01-	1987.12	MT/AT				GC041095	Outer Joint	24	22	52	104.5	54.5	O		
<b>TSURU II</b>																
All Types	1988.01-	1992.12	MT/AT				GC041083	Outer Joint	25	24	52.3	107	62	I		

		TRANSM	L/R	F/R		G-AP Ref.	PRODUCT	ABS	Technical Specifications										
									YEAR	A	B	C	H	L	P				
<b>NISSAN</b>																			
<b>TSURU III</b>																			
-	2005-	2007				GCI41038	Inner Joint		25	23	40	63	105.5						
<b>TSURU III GS</b>																			
-	1992.01-	1995.12	MT/AT			GC041084	Outer Joint		25	24	55	105	62	I					
<b>VANETTE (C22)</b>																			
2.0 4WD	1988.09-	1994.04	MT/AT		Engine CA20/LD20T	GC041023	Outer Joint		27	23	56	103	61.5	M					
	1988.09-	1994.03	MT		Engine LD20	GC041023	Outer Joint		27	23	56	103	61.5	M					
	1988.11-	1994.04	5MT		Engine LD20	GC041023	Outer Joint		27	23	56	103	61.5	M					
	1988.11-	1990.08	5MT		Engine Z20	GC041023	Outer Joint		27	23	56	103	61.5	M					
	1988.11-	1990.08	MT		Engine Z20	GC041023	Outer Joint		27	23	56	103	61.5	M					
	1990.08-	1994.04	5MT		Engine NA20	GC041023	Outer Joint		27	23	56	103	61.5	M					
	1990.08-	1994.03	MT		Engine NA20	GC041023	Outer Joint		27	23	56	103	61.5	M					
<b>WINGROAD (WEY10)</b>																			
2.0	1996.05-	1999.06	4AT		Engine CD20	GC034024	Outer Joint		25	22	55	107	57	M					
	1996.05-	1999.06	5MT		Engine CD20	GC034024	Outer Joint		25	22	55	107	57	M					
2.0	1996.05-	1999.06	4AT		Engine CD20	GC041191	Outer Joint	42T	25	22	55	107	57	M					
<b>WINGROAD (WFNY10)</b>																			
1.5 4WD	1996.05-	1999.06	4AT		Engine GA15DE	GC041033	Outer Joint		25	23	55	107	61	I					
	1996.05-	1999.06	5MT		Engine GA15DE	GC041033	Outer Joint		25	23	55	107	61	I					
	1996.05-	1999.06	4AT		Engine GA15DE	GC041034	Outer Joint	42T	25	23	55	107	61	I					
	1996.05-	1999.06	5MT		Engine GA15DE	GC041034	Outer Joint	42T	25	23	55	107	61	I					
<b>WINGROAD (WFY10)</b>																			
1.5	1996.05-	1999.06	5MT		Engine GA15DE	GC034024	Outer Joint		25	22	55	107	57	M					
	1996.05-	1999.06	4AT		Engine GA15DE	GC041033	Outer Joint		25	23	55	107	61	I					
	1996.05-	1999.06	4AT		Engine GA15DE	GC041034	Outer Joint	42T	25	23	55	107	61	I					
	1996.05-	1999.06	5MT		Engine GA15DE	GC041191	Outer Joint	42T	25	22	55	107	57	M					
<b>WINGROAD (WHNY10)</b>																			
1.8 4WD	1996.10-	1999.06	4AT		Engine SR18DE	GC041033	Outer Joint		25	23	55	107	61	I					
	1996.10-	1999.06	4AT		Engine SR18DE	GC041034	Outer Joint	42T	25	23	55	107	61	I					
<b>WINGROAD (WHY11)</b>																			
1.8	1999.06-		4AT		Engine QG18DE	GC041034	Outer Joint	42T	25	23	55	107	61	I					
<b>X-TRAIL</b>																			
-	2001.01-	2002.05	AT	L	4WD	GDS41198	Drive Shaft	46T	29	29	56	103.5	650						
	2001.01-	2002.05	MT	L	4WD	GDS41199	Drive Shaft	46T	29	29	56	103.5	620						
	2001.01-	2002.05	AT	R	4WD	GDS41197	Drive Shaft	46T	29		56	103.5	552						
	2007-					GC041214	Outer Joint		29	35	56.1	102	59	I					
2.5	2002-	2007	AT			GCI41122	Inner Joint		29	26	33	390	96.5						
	2002-	2007	AT			GCI41124	Inner Joint		29	26	39	65	114						
<b>X-TRAIL (NT31)</b>																			
2.0 4WD	2009-				Engine MR20DE	GC041311	Outer Joint		29	35	56	102.5	59	I					
<b>X-TRAIL (T30)</b>																			
2.0 (103 kW)	2006.04-	2007.12			F Closed Off-Road Vehicle Engine QR20DE	GC041037	Outer Joint	44T	29	25	56	103.5	70.5	I					
	2006.04-	2007.12	MT	L	F Closed Off-Road Vehicle Engine QR20DE	GDS41127	Drive Shaft	44T	29	29	56	103.5	619						
	2006.04-	2007.12	MT	L	F Closed Off-Road Vehicle Engine QR20DE	GCI41007	Inner Joint		29	27	39	65.5	120.7						
	2006.04-	2007.12	MT	L	F Closed Off-Road Vehicle Engine QR20DE	GC041152	Outer Joint	44T	29	27	56	103.5	70.5	I					
	2006.04-	2007.12			F Closed Off-Road Vehicle Engine QR20DE	GC041185	Outer Joint	44T	29	25	56	101	68	M					
2.0 (110 kW)	2001.09-				F Closed Off-Road Vehicle Engine QR20DE	GC041037	Outer Joint	44T	29	25	56	103.5	70.5	I					
2.0 4x4 (103 kW)	2001.07-				F Closed Off-Road Vehicle Engine QR20DE	GC041037	Outer Joint	44T	29	25	56	103.5	70.5	I					
	2001.07-		MT	L	F Closed Off-Road Vehicle Engine QR20DE	GDS41127	Drive Shaft	44T	29	29	56	103.5	619						
	2001.07-		MT	L	F Closed Off-Road Vehicle Engine QR20DE	GCI41007	Inner Joint		29	27	39	65.5	120.7						
	2001.07-		MT	L	F Closed Off-Road Vehicle Engine QR20DE	GC041152	Outer Joint	44T	29	27	56	103.5	70.5	I					
	2001.07-				F Closed Off-Road Vehicle Engine QR20DE	GC041185	Outer Joint	44T	29	25	56	101	68	M					
2.0 4x4 (110 kW)	2001.09-				F Closed Off-Road Vehicle Engine QR20DE	GC041037	Outer Joint	44T	29	25	56	103.5	70.5	I					
2.0 4x4 (206 kW)	2001.06-				F Closed Off-Road Vehicle	GC041185	Outer Joint	44T	29	25	56	101	68	M					
2.2 DCi (100 kW)	2005.04-	2007.12			F Closed Off-Road Vehicle Engine YD22DDTi	GC041037	Outer Joint	44T	29	25	56	103.5	70.5	I					
	2005.04-	2007.12	MT	L	F Closed Off-Road Vehicle Engine YD22DDTi	GDS41127	Drive Shaft	44T	29	29	56	103.5	619						
	2005.04-	2007.12	MT	L	F Closed Off-Road Vehicle Engine YD22DDTi	GCI41007	Inner Joint		29	27	39	65.5	120.7						
	2005.04-	2007.12	MT	L	F Closed Off-Road Vehicle Engine YD22DDTi	GC041152	Outer Joint	44T	29	27	56	103.5	70.5	I					
	2005.04-	2007.12	MT	L	F Closed Off-Road Vehicle Engine YD22DDTi	GC041185	Outer Joint	44T	29	25	56	101	68	M					
2.2 DCi 4x4 (100 kW)	2005.12-	2007.12			F Closed Off-Road Vehicle Engine YD22DDTi	GC041037	Outer Joint	44T	29	25	56	103.5	70.5	I					
	2005.12-	2007.12	MT	L	F Closed Off-Road Vehicle Engine YD22DDTi	GDS41127	Drive Shaft	44T	29	29	56	103.5	619						
	2005.12-	2007.12	MT	L	F Closed Off-Road Vehicle Engine YD22DDTi	GCI41007	Inner Joint		29	27	39	65.5	120.7						
	2005.12-	2007.12	MT	L	F Closed Off-Road Vehicle Engine YD22DDTi	GC041152	Outer Joint	44T	29	27	56	103.5	70.5	I					









		YEAR	TRANSM	L/R	F/R		G-AP Ref.	PRODUCT	ABS	Technical Specifications						
										A	B	C	H	L	P	
<b>NISSAN</b>																
<b>X-TRAIL (T30)</b>																
2.2 DCi 4x4 (100 kW)	2005.12-	2007.12			F	Closed Off-Road Vehicle Engine YD22DDTI	GC041185	Outer Joint	44T	29	25	56	101	68	M	
2.2 Di 4x4 (84 kW)	2001.07-				F	Closed Off-Road Vehicle Engine YD22ETI	GC041037	Outer Joint	44T	29	25	56	103.5	70.5	I	
	2001.07-		MT	L	F	Closed Off-Road Vehicle Engine YD22ETI	GDS41127	Drive Shaft	44T	29	29	56	103.5	619		
	2001.07-		MT	L	F	Closed Off-Road Vehicle Engine YD22ETI	GCI41007	Inner Joint		29	27	39	65.5	120.7		
	2001.07-		MT	L	F	Closed Off-Road Vehicle Engine YD22ETI	GC041152	Outer Joint	44T	29	27	56	103.5	70.5	I	
	2001.07-				F	Closed Off-Road Vehicle Engine YD22ETI	GC041185	Outer Joint	44T	29	25	56	101	68	M	
2.5 4x4 (121 kW)	2002.12-	2007.12			F	Closed Off-Road Vehicle Engine QR25DE	GC041037	Outer Joint	44T	29	25	56	103.5	70.5	I	
	2002.12-	2007.12	MT	L	F	Closed Off-Road Vehicle Engine QR25DE	GDS41127	Drive Shaft	44T	29	29	56	103.5	619		
	2002.12-	2007.12	MT	L	F	Closed Off-Road Vehicle Engine QR25DE	GCI41007	Inner Joint		29	27	39	65.5	120.7		
	2002.12-	2007.12	MT	L	F	Closed Off-Road Vehicle Engine QR25DE	GC041152	Outer Joint	44T	29	27	56	103.5	70.5	I	
	2002.12-	2007.12			F	Closed Off-Road Vehicle Engine QR25DE	GC041185	Outer Joint	44T	29	25	56	101	68	M	
2.5 4x4 (132 kW)	2002.11-				F	Closed Off-Road Vehicle Engine QR25DE	GC041037	Outer Joint	44T	29	25	56	103.5	70.5	I	
<b>X-TRAIL (T31)</b>																
2.0	2009-		CVT			Engine MR20DE	GC041311	Outer Joint		29	35	56	102.5	59	I	
2.0 (101 kW)	2007.06-	2013.11		L	F	Closed Off-Road Vehicle Engine MR20DE	GCI41108	Inner Joint		27	33	40	107	114		
2.0 (103 kW)	2008.06-			L	F	Closed Off-Road Vehicle Engine MR20DE	GCI41108	Inner Joint		27	33	40	107	114		
2.0 (104 kW)	2007.06-					Closed Off-Road Vehicle Engine MR20DE	GC041285	Outer Joint	48T	25	24	56	110.5	38.5	I	
	2007.06-			L	F	Closed Off-Road Vehicle Engine MR20DE	GCI41108	Inner Joint		27	33	40	107	114		
2.0 DCi (110 kW)	2007.06-					Closed Off-Road Vehicle Engine M9R	GC041285	Outer Joint	48T	25	24	56	110.5	38.5	I	
	2007.06-					Closed Off-Road Vehicle Engine M9R	GC041249	Outer Joint		29	36	56	102	72	I	
2.0 DCi (127 kW)	2007.07-	2007.12				Closed Off-Road Vehicle Engine M9R760	GC041285	Outer Joint	48T	25	24	56	110.5	38.5	I	
	2007.07-	2007.12				Closed Off-Road Vehicle Engine M9R760	GC041249	Outer Joint		29	36	56	102	72	I	
2.5 4x4 (124 kW)	2007.06-					Closed Off-Road Vehicle Engine QR25DE	GC041285	Outer Joint	48T	25	24	56	110.5	38.5	I	
	2007.06-			L	F	Closed Off-Road Vehicle Engine QR25DE	GCI41108	Inner Joint		27	33	40	107	114		
<b>X-TRAIL (TNT31)</b>																
2.5	2009-		CVT			Engine QR25DE	GC041311	Outer Joint		29	35	56	102.5	59	I	
<b>XTERRA</b>																
-	2000-	2004				SUV/Truck/VAN 4WD	GCI41014	Inner Joint			27		81.2			
<b>NISSAN LCV</b>																
<b>INTERSTAR (X70)</b>																
1.9 DCi (60 kW)	2002.07-						GC044026	Outer Joint	51T	28	36	65	96	71	I	
2.2 DCi (66 kW)	2002.07-						GC044026	Outer Joint	51T	28	36	65	96	71	I	
2.5 DCi (107 kW)	2003.11-						GC044026	Outer Joint	51T	28	36	65	96	71	I	
2.5 DCi (74 kW)	2003.11-						GC044026	Outer Joint	51T	28	36	65	96	71	I	
2.5 DCi (84 kW)	2003.11-						GC044026	Outer Joint	51T	28	36	65	96	71	I	
3.0 DCi (100 kW)	2003.11-						GC044026	Outer Joint	51T	28	36	65	96	71	I	
<b>KUBISTAR (X76)</b>																
1.2 (44 kW)	2003.08-						GC050004	Outer Joint	26T	21	30	52.2	85.5	59	I	
1.2 16V (55 kW)	2006.04-						GC050069	Outer Joint	44T	23	30	57.5	86.5	58.5	I	
1.5 DCi (42 kW)	2003.08-						GC050069	Outer Joint	44T	23	30	57.5	86.5	58.5	I	
1.5 DCi (45 kW)	2005.08-						GC050069	Outer Joint	44T	23	30	57.5	86.5	58.5	I	
1.5 DCi (48 kW)	2003.08-						GC050069	Outer Joint	44T	23	30	57.5	86.5	58.5	I	
1.5 DCi (50 kW)	2006.04-						GC050069	Outer Joint	44T	23	30	57.5	86.5	58.5	I	
1.5 DCi (60 kW)	2003.08-						GC050069	Outer Joint	44T	23	30	57.5	86.5	58.5	I	
1.5 DCi (62 kW)	2006.04-						GC050069	Outer Joint	44T	23	30	57.5	86.5	58.5	I	
<b>OLDSMOBILE</b>																
<b>BRAVADA</b>																
-	1997-	2004					GC188008	Inner Joint		26	34	40	92	98		
-	1997-	2004				SUV/Truck/VAN 4WD	GC088011	Outer Joint		27	34	55.8	127.5	64	O	
<b>CUTLASS SUPREME</b>																
-	1988-	1997				Excl. A/T, 3 Speed.	GC086002	Outer Joint		33	32	73	88	55	O	
-	1988-	1997				Excl. A/T, 3 Speed.	GC086011	Outer Joint	47T	33	32	73	88	55	O	
-	1992-	1994	AT			3 Speed	GC088024	Outer Joint		33	29	73	88	54.5	O	
2.8 V6 (97 kW)	1991-	1993					GC021007	Outer Joint		27	32	61.5	120	63	I	
3.1 V6 (101 kW)	1991-	1993					GC021007	Outer Joint		27	32	61.5	120	63	I	
3.4 V6 (149 kW)	1991-	1993					GC021007	Outer Joint		27	32	61.5	120	63	I	
All Models	1991-	1993					GC021007	Outer Joint		27	32	61.5	120	63	I	
<b>EUROSPORT</b>																
All Models	1991-	1993					GC021007	Outer Joint		27	32	61.5	120	63	I	
<b>TORONADO</b>																
All Models	1979.01-	1984.12					GC088005	Outer Joint		27	34	56	109	63	O	

		YEAR	TRANSM	L/R	F/R		G-AP Ref.	PRODUCT	ABS	Technical Specifications						
										A	B	C	H	L	P	
<b>OPEL ADAM</b>																
1.2 (51 kW)	2012.10-			L	F	Hatchback Engine A12XEL	GDS44079	Drive Shaft		22	22	51	79.5	615		
	2012.10-			R	F	Hatchback Engine A12XEL	GDS44078	Drive Shaft		22	22	51	79.5	918		
	2012.10-		MT	L	F	Hatchback Engine A12XEL	GDS60023	Drive Shaft		22	22	51.2	79.5	615		
1.4 (64 kW)	2012.10-			L	F	Hatchback Engine A14XEL	GDS44079	Drive Shaft		22	22	51	79.5	615		
	2012.10-			R	F	Hatchback Engine A14XEL	GDS44078	Drive Shaft		22	22	51	79.5	918		
	2012.10-		MT	L	F	Hatchback Engine A14XEL	GDS60023	Drive Shaft		22	22	51.2	79.5	615		
1.4 (74 kW)	2012.10-			L	F	Hatchback Engine A14XER	GDS44079	Drive Shaft		22	22	51	79.5	615		
	2012.10-			R	F	Hatchback Engine A14XER	GDS44078	Drive Shaft		22	22	51	79.5	918		
	2012.10-		MT	L	F	Hatchback Engine A14XER	GDS60023	Drive Shaft		22	22	51.2	79.5	615		
1.4 LPG (64 kW)	2013.07-			L	F	Hatchback Engine A14XEL	GDS44079	Drive Shaft		22	22	51	79.5	615		
	2013.07-			R	F	Hatchback Engine A14XEL	GDS44078	Drive Shaft		22	22	51	79.5	918		
	2013.07-		MT	L	F	Hatchback Engine A14XEL	GDS60023	Drive Shaft		22	22	51.2	79.5	615		
<b>AGILA (A) (H00)</b>																
1.0 (44 kW)	2003.08-	2007.12	MT	L	F	Hatchback Engine Z10XEP	GDS57087	Drive Shaft	43T	23	22	49	78	638		
1.0 12V (43 kW)	2000.09-	2007.12	5MT		F	Hatchback Engine Z10XE	GC044001	Outer Joint	43T	23	20	49	78	61	M	
	2000.09-	2007.12	MT	L	F	Hatchback Engine Z10XE	GDS57087	Drive Shaft	43T	23	22	49	78	638		
1.2 16V (55 kW)	2000.09-	2007.12	5MT		F	Hatchback Engine Z12XE	GC044001	Outer Joint	43T	23	20	49	78	61	M	
	2000.09-	2007.12	MT	R	F	Hatchback Engine Z12XE	GDS44043	Drive Shaft	43T	23	22	49	78	853		
1.3 CDTi (51 kW)	2003.08-	2007.12			F	Hatchback Engine Z13DT	GC044080	Outer Joint	43T	25	21	49	76	66.5	M	
<b>AGILA (B) (H08)</b>																
1.0 (48 kW)	2008.04-		MT	L	F	Hatchback Engine K10B	GDS57175	Drive Shaft		25	22	49	82	635		
	2008.04-		MT	L/R	F	Hatchback Engine K10B	GC044085	Outer Joint		25	20	49	81.5	61	M	
	2008.04-		MT	R	F	Hatchback Engine K10B	GDS57221	Drive Shaft		25	22	49	81.5	882		
1.0 (50 kW)	2011.07-		MT	L	F	Hatchback Engine K10B	GDS57175	Drive Shaft		25	22	49	82	635		
1.0 LPG (48 kW)	2010.01-		MT	L	F	Hatchback Engine K10B	GDS57175	Drive Shaft		25	22	49	82	635		
	2010.01-			L	F	Hatchback Engine K10B	GDS57222	Drive Shaft		25	22	49	81.5	641		
	2010.01-			L/R	F	Hatchback Engine K10B	GC044085	Outer Joint		25	20	49	81.5	61	M	
	2010.01-			R	F	Hatchback Engine K10B	GDS57221	Drive Shaft		25	22	49	81.5	882		
1.2 (63 kW)	2008.04-		MT	L	F	Hatchback Engine K12B	GDS57175	Drive Shaft		25	22	49	82	635		
	2008.04-		MT	L/R	F	Hatchback Engine K12B	GC044085	Outer Joint		25	20	49	81.5	61	M	
	2008.04-		MT	R	F	Hatchback Engine K12B	GDS57221	Drive Shaft		25	22	49	81.5	882		
1.2 (69 kW)	2010.11-		MT	L	F	Hatchback Engine K12B	GDS57175	Drive Shaft		25	22	49	82	635		
1.2 LPG (63 kW)	2008.04-		MT	L	F	Hatchback Engine K12B	GDS57175	Drive Shaft		25	22	49	82	635		
	2008.04-		MT	L/R	F	Hatchback Engine K12B	GC044085	Outer Joint		25	20	49	81.5	61	M	
	2008.04-		MT	R	F	Hatchback Engine K12B	GDS57221	Drive Shaft		25	22	49	81.5	882		
1.3 CDTi (55 kW)	2008.04-				F	Hatchback Engine Z13DTJ/D13A	GC057100	Outer Joint		25	21	49	82.5	64	M	
	2008.04-		MT	L	F	Hatchback Engine Z13DTJ/D13A	GDS57210	Drive Shaft		25	26	49	81.5	630		
	2008.04-		MT	R	F	Hatchback Engine Z13DTJ/D13A	GDS57197	Drive Shaft		25	22	49	81.5	614		
<b>AGILA A (H00)</b>																
1.0 (44 kW)	2003.08-						GC099110	Outer Joint		23	20	49	78	61	M	
	2003.08-						GC044001	Outer Joint	43T	23	20	49	78	61	M	
1.0 12V (43 kW)	2000.09-						GC099110	Outer Joint		23	20	49	78	61	M	
	2000.09-						GC044001	Outer Joint	43T	23	20	49	78	61	M	
1.2 16V (55 kW)	2000.09-						GC099110	Outer Joint		23	20	49	78	61	M	
	2000.09-						GC044001	Outer Joint	43T	23	20	49	78	61	M	
1.2 16V Twinport (59 kW)	2004.07-						GC099110	Outer Joint		23	20	49	78	61	M	
	2004.07-						GC044001	Outer Joint	43T	23	20	49	78	61	M	
<b>AGILA B</b>																
1.0 (50 kW)	2011-					Ch-AM999999	GC044085	Outer Joint		25	20	49	81.5	61	M	
1.0 12V (48 kW)	2007.09-					Ch-AM999999	GC044085	Outer Joint		25	20	49	81.5	61	M	
1.0 LPG (48 kW)	2010-					Ch-AM999999	GC044085	Outer Joint		25	20	49	81.5	61	M	
1.2 16V (63 kW)	2007.09-						GC044085	Outer Joint		25	20	49	81.5	61	M	
1.2 16V (69 kW)	2007.09-						GC044085	Outer Joint		25	20	49	81.5	61	M	
<b>ANTARA</b>																
-	2006-						GC021047	Outer Joint		30	22		105.5	53.5	O	
	2006-						GCI88034	Inner Joint		27	34	35	68.5	111.5		
	2006-						GCI12009	Inner Joint		34	22	35	80.5	58		
2.0 CDTi 4WD	2006-	2012	AT	L			GDS88093	Drive Shaft		30	27	54	105.5	618.5		
	2006-	2012	AT	L			GCI88034	Inner Joint		27	34	35	68.5	111.5		
	2006-	2012	AT	L/R			GC022009	Outer Joint		30	34	54	105.5	64.5	O	
	2006-	2012	AT	R			GDS88094	Drive Shaft		30	27	54	105.5	542		



		TRANSM	L/R	F/R		G-AP Ref.	PRODUCT	ABS	Technical Specifications							
									YEAR	A	B	C	H	L	P	
<b>OPEL</b>																
<b>ANTARA</b>																
2.0 CDTi 4WD	2006-	2012	AT	R		GCI88035	Inner Joint		27	34	43.3	51	77			
2.0 CDTi 4x4 (110 kW)	2006.05-			L/R	Closed Off-Road Vehicle Engine Z20DMH/Z20S	GC022009	Outer Joint		30	34	54	105.5	64.5	O		
<b>ARENA (TB, TF)</b>																
1.9 D (44 kW)	1998.03-	2001.08	MT	L/R	F	Box Engine F8Q600/F8Q606	GDS44006	Drive Shaft	25	27	56.3	110.5	713.5			
2.5 D (55 kW)	1998.03-	2001.08	MT	L/R	F	Box Engine S8U758/S8U780/S8U782	GDS44006	Drive Shaft	25	27	56.3	110.5	713.5			
<b>ARENA (THB)</b>																
1.9 D (44 kW)	1998.03-	2001.08	MT	L/R	F	Bus Engine F8Q600/F8Q606	GDS44006	Drive Shaft	25	27	56.3	110.5	713.5			
2.5 D (55 kW)	1998.03-	2001.08	MT	L/R	F	Bus Engine S8U758/S8U780/S8U782	GDS44006	Drive Shaft	25	27	56.3	110.5	713.5			
<b>ASCONA</b>																
-	1981-				DIESEL	GC044047	Outer Joint		33	29	52	109	61	O		
<b>ASCONA C (81_, 86_, 87_, 88_)</b>																
1.3 N (44 kW)	1981.09-	1986.08	MT		F	Saloon Engine 13N	GC044041	Outer Joint	22	22	52	95	50	O		
	1981.09-	1986.08	MT		F	Saloon Engine 13N	GCI44004	Inner Joint	22	22	34.95	57.5	72.5			
1.3 S (55 kW)	1981.09-	1988.08	MT		F	Saloon Engine 13S	GC044041	Outer Joint	22	22	52	95	50	O		
	1981.09-	1988.08	MT		F	Saloon Engine 13S	GCI44004	Inner Joint	22	22	34.95	57.5	72.5			
1.6 (55 kW)	1981.09-	1987.09	MT		F	Saloon Engine 16N	GC044041	Outer Joint	22	22	52	95	50	O		
	1981.09-	1987.09	MT		F	Saloon Engine 16N	GCI44004	Inner Joint	22	22	34.95	57.5	72.5			
1.6 (60 kW)	1986.09-	1988.08	MT		F	Saloon Engine 16SV	GC044041	Outer Joint	22	22	52	95	50	O		
	1986.09-	1988.08	MT		F	Saloon Engine 16SV	GCI44004	Inner Joint	22	22	34.95	57.5	72.5			
1.6 D (40 kW)	1982.03-	1988.08	MT		F	Saloon Engine 16D/16DA	GCI44001	Inner Joint	34	22	35	56.2	76			
	1982.03-	1988.08	MT		F	Saloon Engine 16D/16DA	GC099205	Outer Joint	33	25	52	109	61	O		
1.6 i (55 kW)	1987.09-	1988.08	MT		F	Saloon Engine E16LZ/E16NZ	GC044041	Outer Joint	22	22	52	95	50	O		
	1987.09-	1988.08	MT		F	Saloon Engine E16LZ/E16NZ	GCI44004	Inner Joint	22	22	34.95	57.5	72.5			
1.6 i CAT (55 kW)	1986.09-	1988.08	MT		F	Saloon Engine C16LZ/C16NZ	GC044041	Outer Joint	22	22	52	95	50	O		
	1986.09-	1988.08	MT		F	Saloon Engine C16LZ/C16NZ	GCI44004	Inner Joint	22	22	34.95	57.5	72.5			
1.6 S (66 kW)	1981.09-	1986.08	MT		F	Saloon Engine 16SH	GCI44002	Inner Joint	34	25	35	56.2	85.6			
	1981.09-	1986.08	MT		F	Saloon Engine 16SH	GC099205	Outer Joint	33	25	52	109	61	O		
1.8 (62 kW)	1987.09-	1988.08	MT		F	Saloon Engine E18NV	GCI44002	Inner Joint	34	25	35	56.2	85.6			
	1987.09-	1988.08	MT		F	Saloon Engine E18NV	GC099205	Outer Joint	33	25	52	109	61	O		
1.8 E (74 kW)	1985.01-	1986.08	MT		F	Saloon Engine C18NE/S18NV	GCI44002	Inner Joint	34	25	35	56.2	85.6			
	1985.01-	1986.08	MT		F	Saloon Engine C18NE/S18NV	GC099205	Outer Joint	33	25	52	109	61	O		
1.8 i (85 kW)	1982.09-	1986.08	MT		F	Saloon Engine 18E	GCI44002	Inner Joint	34	25	35	56.2	85.6			
	1982.09-	1986.08	MT		F	Saloon Engine 18E	GC099205	Outer Joint	33	25	52	109	61	O		
2.0 i (74 kW)	1987.08-	1988.08	MT		F	Saloon Engine C20NEF	GCI44002	Inner Joint	34	25	35	56.2	85.6			
	1987.08-	1988.08	MT		F	Saloon Engine C20NEF	GC099205	Outer Joint	33	25	52	109	61	O		
2.0 i (85 kW)	1986.09-	1988.08	MT		F	Saloon Engine 20NE	GCI44002	Inner Joint	34	25	35	56.2	85.6			
	1986.09-	1988.08	MT		F	Saloon Engine 20NE	GC099205	Outer Joint	33	25	52	109	61	O		
2.0 i CAT (85 kW)	1986.09-	1988.08	MT		F	Saloon Engine C20NE	GCI44002	Inner Joint	34	25	35	56.2	85.6			
	1986.09-	1988.08	MT		F	Saloon Engine C20NE	GC099205	Outer Joint	33	25	52	109	61	O		
2.0 i GT (95 kW)	1987.03-	1988.08	MT		F	Saloon Engine 20SEH	GCI44002	Inner Joint	34	25	35	56.2	85.6			
	1987.03-	1988.08	MT		F	Saloon Engine 20SEH	GC099205	Outer Joint	33	25	52	109	61	O		
<b>ASCONA C (84_, 89_)</b>																
1.3 N (44 kW)	1981.09-	1986.08	MT		F	Hatchback Engine 13N	GC044041	Outer Joint	22	22	52	95	50	O		
	1981.09-	1986.08	MT		F	Hatchback Engine 13N	GCI44004	Inner Joint	22	22	34.95	57.5	72.5			
1.3 S (55 kW)	1981.09-	1988.08	MT		F	Hatchback Engine 13S	GC044041	Outer Joint	22	22	52	95	50	O		
	1981.09-	1988.08	MT		F	Hatchback Engine 13S	GCI44004	Inner Joint	22	22	34.95	57.5	72.5			
1.6 (55 kW)	1981.09-	1988.08	MT		F	Hatchback Engine 16N	GC044041	Outer Joint	22	22	52	95	50	O		
	1981.09-	1988.08	MT		F	Hatchback Engine 16N	GCI44004	Inner Joint	22	22	34.95	57.5	72.5			
1.6 (60 kW)	1986.09-	1988.08	MT		F	Hatchback Engine 16SV	GC044041	Outer Joint	22	22	52	95	50	O		
	1986.09-	1988.08	MT		F	Hatchback Engine 16SV	GCI44004	Inner Joint	22	22	34.95	57.5	72.5			
1.6 D (40 kW)	1982.03-	1988.08	MT		F	Hatchback Engine 16D/16DA	GCI44001	Inner Joint	34	22	35	56.2	76			
	1982.03-	1988.08	MT		F	Hatchback Engine 16D/16DA	GC099205	Outer Joint	33	25	52	109	61	O		
1.6 i (55 kW)	1987.09-	1988.08	MT		F	Hatchback Engine E16NZ	GC044041	Outer Joint	22	22	52	95	50	O		
	1987.09-	1988.08	MT		F	Hatchback Engine E16NZ	GCI44004	Inner Joint	22	22	34.95	57.5	72.5			
1.6 i CAT (55 kW)	1986.09-	1988.08	MT		F	Hatchback Engine C16LZ/C16NZ	GC044041	Outer Joint	22	22	52	95	50	O		
	1986.09-	1988.08	MT		F	Hatchback Engine C16LZ/C16NZ	GCI44004	Inner Joint	22	22	34.95	57.5	72.5			
1.6 S (66 kW)	1981.09-	1986.08	MT		F	Hatchback Engine 16SH	GCI44002	Inner Joint	34	25	35	56.2	85.6			
	1981.09-	1986.08	MT		F	Hatchback Engine 16SH	GC099205	Outer Joint	33	25	52	109	61	O		
1.8 (62 kW)	1987.09-	1988.08	MT		F	Hatchback Engine E18NV	GCI44002	Inner Joint	34	25	35	56.2	85.6			
	1987.09-	1988.08	MT		F	Hatchback Engine E18NV	GC099205	Outer Joint	33	25	52	109	61	O		
1.8 E (74 kW)	1985.01-	1986.08	MT		F	Hatchback Engine C18NE/S18NV	GCI44002	Inner Joint	34	25	35	56.2	85.6			





		TRANSM	L/R	F/R		G-AP Ref.	PRODUCT	ABS	Technical Specifications								
									YEAR	A	B	C	H	L	P		
<b>OPEL</b>																	
<b>ASCONA C (84_, 89_)</b>																	
1.8 E (74 kW)	1985.01-	1986.08	MT		F	Hatchback Engine C18NE/S18NV	GCO99205	Outer Joint		33	25	52	109	61	O		
1.8 i (85 kW)	1982.09-	1986.08	MT		F	Hatchback Engine 18E	GCI44002	Inner Joint		34	25	35	56.2	85.6			
	1982.09-	1986.08	MT		F	Hatchback Engine 18E	GCO99205	Outer Joint		33	25	52	109	61	O		
2.0 i (85 kW)	1986.09-	1988.08	MT		F	Hatchback Engine 20NE	GCI44002	Inner Joint		34	25	35	56.2	85.6			
	1986.09-	1988.08	MT		F	Hatchback Engine 20NE	GCO99205	Outer Joint		33	25	52	109	61	O		
2.0 i CAT (85 kW)	1986.09-	1988.08	MT		F	Hatchback Engine C20NE	GCI44002	Inner Joint		34	25	35	56.2	85.6			
	1986.09-	1988.08	MT		F	Hatchback Engine C20NE	GCO99205	Outer Joint		33	25	52	109	61	O		
2.0 i GT (95 kW)	1987.03-	1988.08	MT		F	Hatchback Engine 20SEH	GCI44002	Inner Joint		34	25	35	56.2	85.6			
	1987.03-	1988.08	MT		F	Hatchback Engine 20SEH	GCO99205	Outer Joint		33	25	52	109	61	O		
<b>ASTRA</b>																	
-	1993-						GCO44063	Outer Joint		22	30	52	94.5	55	I		
<b>ASTRA / VECTRA</b>																	
-							GCO99238	Outer Joint	29T	33	25	52	103.5	61	O		
<b>ASTRA F</b>																	
1.4	1991-	1998					GCI44003	Inner Joint		22	28	34.95	57.5	83.5			
1.6	1991-	1998					GCI44003	Inner Joint		22	28	34.95	57.5	83.5			
<b>ASTRA F (51_, 52_)</b>																	
1.4 (55 kW)	1991.09-	1993.09	MT	L	F	Estate Engine 14NV	GDS44002	Drive Shaft	29T	22	22	52	95	585			
	1991.09-	1993.09	MT		F	Estate Engine 14NV	GCO44051	Outer Joint	29T	22	22	52	95	50.5	O		
	1991.09-	1993.09	MT		F	Estate Engine 14NV	GCI44004	Inner Joint		22	22	34.95	57.5	72.5			
1.4 (60 kW)	1992.09-	1998.01	MT	L	F	Estate Engine 14SE	GDS44002	Drive Shaft	29T	22	22	52	95	585			
	1992.09-	1998.01	MT		F	Estate Engine 14SE	GCO44051	Outer Joint	29T	22	22	52	95	50.5	O		
	1992.09-	1998.01	MT		F	Estate Engine 14SE	GCI44004	Inner Joint		22	22	34.95	57.5	72.5			
1.4 i (44 kW)	1991.09-	1998.01	MT	L	F	Estate Engine C14NZ	GDS44002	Drive Shaft	29T	22	22	52	95	585			
	1991.09-	1998.01	MT		F	Estate Engine C14NZ	GCO44051	Outer Joint	29T	22	22	52	95	50.5	O		
	1991.09-	1998.01	MT		F	Estate Engine C14NZ	GCI44004	Inner Joint		22	22	34.95	57.5	72.5			
1.4 Si (60 kW)	1992.03-	1998.01	MT		F	Estate Engine C14SE	GCI44004	Inner Joint		22	22	34.95	57.5	72.5			
	1992.03-	1998.01	MT	L	F	Estate Engine C14SE	GDS44002	Drive Shaft	29T	22	22	52	95	585			
	1992.03-	1998.01	MT		F	Estate Engine C14SE	GCO44051	Outer Joint	29T	22	22	52	95	50.5	O		
1.6 i (52 kW)	1993.05-	1996.07	MT		F	Estate Engine X16SZ	GCI44004	Inner Joint		22	22	34.95	57.5	72.5			
1.6 i (55 kW)	1991.09-	1998.01	MT	L	F	Estate Engine C16NZ/X16SZR	GDS44002	Drive Shaft	29T	22	22	52	95	585			
	1991.09-	1998.01	MT/AT		F	Estate Engine C16NZ/X16SZR	GCO44051	Outer Joint	29T	22	22	52	95	50.5	O		
	1991.09-	1998.01	MT		F	Estate Engine C16NZ/X16SZR	GCI44004	Inner Joint		22	22	34.95	57.5	72.5			
1.6 i 16V (74 kW)	1994.08-	1998.01	MT	L	F	Estate Engine X16XEL	GDS44002	Drive Shaft	29T	22	22	52	95	585			
	1994.08-	1998.01	MT		F	Estate Engine X16XEL	GCI44004	Inner Joint		22	22	34.95	57.5	72.5			
1.6 Si (74 kW)	1992.03-	1994.12	MT	L	F	Estate Engine C16SE	GDS44002	Drive Shaft	29T	22	22	52	95	585			
	1992.03-	1994.12	MT		F	Estate Engine C16SE	GCO44051	Outer Joint	29T	22	22	52	95	50.5	O		
	1992.03-	1994.12	MT		F	Estate Engine C16SE	GCI44004	Inner Joint		22	22	34.95	57.5	72.5			
1.7 D (42 kW)	1991.12-	1992.09	MT/AT		F	Estate Engine 17D	GCO44056	Outer Joint	29T	33	25	52	109	61	O		
	1991.12-	1992.09	MT		F	Estate Engine 17D	GCI44004	Inner Joint		22	22	34.95	57.5	72.5			
1.7 D (44 kW)	1992.07-	1998.01	MT/AT		F	Estate Engine 17DR	GCO44056	Outer Joint	29T	33	25	52	109	61	O		
	1992.07-	1998.01	MT		F	Estate Engine 17DR	GCI44004	Inner Joint		22	22	34.95	57.5	72.5			
1.7 TD (50 kW)	1994.11-	1998.01	MT/AT		F	Estate Engine X17DTL	GCO44056	Outer Joint	29T	33	25	52	109	61	O		
1.7 TDS (60 kW)	1991.12-	1998.01	MT	R	F	Estate Engine 17DT(TC4EE1)/X17DT(TC4EE1)	GDS44059	Drive Shaft	29T	33	34	52	109	938			
	1991.12-	1998.01	MT/AT		F	Estate Engine 17DT(TC4EE1)/X17DT(TC4EE1)	GCO44056	Outer Joint	29T	33	25	52	109	61	O		
	1991.12-	1998.01	MT	L	F	Estate Engine 17DT(TC4EE1)/X17DT(TC4EE1)	GDS44011	Drive Shaft	29T	33	34	52	109	594.5			
	1991.12-	1998.01	MT		F	Estate Engine 17DT(TC4EE1)/X17DT(TC4EE1)	GCI44002	Inner Joint		34	25	35	56.2	85.6			
1.8 i (66 kW)	1991.09-	1998.01	MT	R	F	Estate Engine C18NZ	GDS44059	Drive Shaft	29T	33	34	52	109	938			
	1991.09-	1998.01	MT/AT		F	Estate Engine C18NZ	GCO44056	Outer Joint	29T	33	25	52	109	61	O		
	1991.09-	1998.01	MT	L	F	Estate Engine C18NZ	GDS44011	Drive Shaft	29T	33	34	52	109	594.5			
	1991.09-	1998.01	MT		F	Estate Engine C18NZ	GCI44002	Inner Joint		34	25	35	56.2	85.6			
1.8 i 16V (85 kW)	1994.07-	1998.01	MT		F	Estate Engine C18XEL/X18XE	GCI44002	Inner Joint		34	25	35	56.2	85.6			
1.8 i 16V (92 kW)	1993.06-	1998.01	MT		F	Estate Engine C18XE	GCI44002	Inner Joint		34	25	35	56.2	85.6			
2.0 i (85 kW)	1991.09-	1994.07	MT	R	F	Estate Engine C20NE	GDS44059	Drive Shaft	29T	33	34	52	109	938			
	1991.09-	1994.07	MT/AT		F	Estate Engine C20NE	GCO44056	Outer Joint	29T	33	25	52	109	61	O		
	1991.09-	1994.07	MT	L	F	Estate Engine C20NE	GDS44011	Drive Shaft	29T	33	34	52	109	594.5			
	1991.09-	1994.07	MT		F	Estate Engine C20NE	GCI44002	Inner Joint		34	25	35	56.2	85.6			
2.0 i 16V (100 kW)	1995.02-	1998.01	MT/AT		F	Estate Engine X20XEV	GCO44056	Outer Joint	29T	33	25	52	109	61	O		
2.0 i 16V (110 kW)	1993.03-	1998.01	MT	R	F	Estate Engine C20XE	GDS44059	Drive Shaft	29T	33	34	52	109	938			
	1993.03-	1998.01	MT		F	Estate Engine C20XE	GCO44056	Outer Joint	29T	33	25	52	109	61	O		
	1993.03-	1998.01	MT	L	F	Estate Engine C20XE	GDS44011	Drive Shaft	29T	33	34	52	109	594.5			



		TRANSM	L/R	F/R		G-AP Ref.	PRODUCT	ABS	Technical Specifications								
									YEAR	A	B	C	H	L	P		
<b>OPEL</b>																	
<b>ASTRA F (51_, 52_)</b>																	
2.0 i 16V (110 kW)	1993.03-	1998.01	MT		F	Estate Engine C20XE	GCI44002	Inner Joint	34	25	35	56.2	85.6				
<b>ASTRA F (53_, 54_, 58_, 59_)</b>																	
1.4 (55 kW)	1991.09-	1993.09	MT	L	F	Hatchback Engine 14NV	GDS44002	Drive Shaft	29T	22	22	52	95	585			
	1991.09-	1993.09	MT		F	Hatchback Engine 14NV	GC044051	Outer Joint	29T	22	22	52	95	50.5	O		
	1991.09-	1993.09	MT		F	Hatchback Engine 14NV	GCI44004	Inner Joint		22	22	34.95	57.5	72.5			
1.4 (60 kW)	1992.09-	1998.01	MT	L	F	Hatchback Engine 14SE	GDS44002	Drive Shaft	29T	22	22	52	95	585			
	1992.09-	1998.01	MT		F	Hatchback Engine 14SE	GC044051	Outer Joint	29T	22	22	52	95	50.5	O		
	1992.09-	1998.01	MT		F	Hatchback Engine 14SE	GCI44004	Inner Joint		22	22	34.95	57.5	72.5			
1.4 i (44 kW)	1992.03-	1998.01	MT	L	F	Hatchback Engine C14NZ	GDS44002	Drive Shaft	29T	22	22	52	95	585			
	1992.03-	1998.01	MT		F	Hatchback Engine C14NZ	GC044051	Outer Joint	29T	22	22	52	95	50.5	O		
	1992.03-	1998.01	MT		F	Hatchback Engine C14NZ	GCI44004	Inner Joint		22	22	34.95	57.5	72.5			
1.4 Si (60 kW)	1992.03-	1998.01	MT	L	F	Hatchback Engine C14SE	GDS44002	Drive Shaft	29T	22	22	52	95	585			
	1992.03-	1998.01	MT		F	Hatchback Engine C14SE	GC044051	Outer Joint	29T	22	22	52	95	50.5	O		
	1992.03-	1998.01	MT		F	Hatchback Engine C14SE	GCI44004	Inner Joint		22	22	34.95	57.5	72.5			
1.6 i (52 kW)	1993.05-	1996.07	MT		F	Hatchback Engine X16SZ	GCI44004	Inner Joint		22	22	34.95	57.5	72.5			
1.6 i (55 kW)	1991.09-	1998.01	MT	L	F	Hatchback Engine C16NZ/X16SZR	GDS44002	Drive Shaft	29T	22	22	52	95	585			
	1991.09-	1998.01	MT/AT		F	Hatchback Engine C16NZ/X16SZR	GC044051	Outer Joint	29T	22	22	52	95	50.5	O		
	1991.09-	1998.01	MT		F	Hatchback Engine C16NZ/X16SZR	GCI44004	Inner Joint		22	22	34.95	57.5	72.5			
1.6 i 16V (74 kW)	1994.08-	1998.01	MT	L	F	Hatchback Engine X16XEL	GDS44002	Drive Shaft	29T	22	22	52	95	585			
	1994.08-	1998.01	MT		F	Hatchback Engine X16XEL	GCI44004	Inner Joint		22	22	34.95	57.5	72.5			
1.6 Si (74 kW)	1992.03-	1994.12	MT	L	F	Hatchback Engine C16SE	GDS44002	Drive Shaft	29T	22	22	52	95	585			
	1992.03-	1994.12	MT		F	Hatchback Engine C16SE	GC044051	Outer Joint	29T	22	22	52	95	50.5	O		
	1992.03-	1994.12	MT		F	Hatchback Engine C16SE	GCI44004	Inner Joint		22	22	34.95	57.5	72.5			
1.7 D (42 kW)	1991.12-	1992.09	MT/AT		F	Hatchback Engine 17D	GC044056	Outer Joint	29T	33	25	52	109	61	O		
	1991.12-	1992.09	MT		F	Hatchback Engine 17D	GCI44004	Inner Joint		22	22	34.95	57.5	72.5			
1.7 D (44 kW)	1992.07-	1998.01	MT/AT		F	Hatchback Engine 17DR	GC044056	Outer Joint	29T	33	25	52	109	61	O		
	1992.07-	1998.01	MT		F	Hatchback Engine 17DR	GCI44004	Inner Joint		22	22	34.95	57.5	72.5			
1.7 TD (50 kW)	1994.11-	1998.01	MT/AT		F	Hatchback Engine X17DTL	GC044056	Outer Joint	29T	33	25	52	109	61	O		
1.7 TDS (60 kW)	1991.12-	1998.01	MT	R	F	Hatchback Engine 17DT(TC4EE1)/X17DT(TC4EE1)	GDS44059	Drive Shaft	29T	33	34	52	109	938			
	1991.12-	1998.01	MT/AT		F	Hatchback Engine 17DT(TC4EE1)/X17DT(TC4EE1)	GC044056	Outer Joint	29T	33	25	52	109	61	O		
	1991.12-	1998.01	MT	L	F	Hatchback Engine 17DT(TC4EE1)/X17DT(TC4EE1)	GDS44011	Drive Shaft	29T	33	34	52	109	594.5			
	1991.12-	1998.01	MT		F	Hatchback Engine 17DT(TC4EE1)/X17DT(TC4EE1)	GCI44002	Inner Joint		34	25	35	56.2	85.6			
1.8 i (66 kW)	1991.09-	1998.01	MT	R	F	Hatchback Engine C18NZ	GDS44059	Drive Shaft	29T	33	34	52	109	938			
	1991.09-	1998.01	MT/AT		F	Hatchback Engine C18NZ	GC044056	Outer Joint	29T	33	25	52	109	61	O		
	1991.09-	1998.01	MT	L	F	Hatchback Engine C18NZ	GDS44011	Drive Shaft	29T	33	34	52	109	594.5			
	1991.09-	1998.01	MT		F	Hatchback Engine C18NZ	GCI44002	Inner Joint		34	25	35	56.2	85.6			
1.8 i 16V (85 kW)	1994.09-	1998.01	MT		F	Hatchback Engine C18XEL/X18XE	GCI44002	Inner Joint		34	25	35	56.2	85.6			
1.8 i 16V (92 kW)	1993.06-	1994.08	MT		F	Hatchback Engine C18XE	GCI44002	Inner Joint		34	25	35	56.2	85.6			
2.0 GSi 16V (110 kW)	1991.09-	1998.01	MT	R	F	Hatchback Engine C20XE	GDS44059	Drive Shaft	29T	33	34	52	109	938			
	1991.09-	1998.01	MT		F	Hatchback Engine C20XE	GC044056	Outer Joint	29T	33	25	52	109	61	O		
	1991.09-	1998.01	MT	L	F	Hatchback Engine C20XE	GDS44011	Drive Shaft	29T	33	34	52	109	594.5			
	1991.09-	1998.01	MT		F	Hatchback Engine C20XE	GCI44002	Inner Joint		34	25	35	56.2	85.6			
2.0 i (85 kW)	1991.09-	1998.01	MT	R	F	Hatchback Engine C20NE	GDS44059	Drive Shaft	29T	33	34	52	109	938			
	1991.09-	1998.01	MT/AT		F	Hatchback Engine C20NE	GC044056	Outer Joint	29T	33	25	52	109	61	O		
	1991.09-	1998.01	MT	L	F	Hatchback Engine C20NE	GDS44011	Drive Shaft	29T	33	34	52	109	594.5			
	1991.09-	1998.01	MT		F	Hatchback Engine C20NE	GCI44002	Inner Joint		34	25	35	56.2	85.6			
2.0 i 16V (100 kW)	1995.02-	1998.01	MT/AT		F	Hatchback Engine X20XEV	GC044056	Outer Joint	29T	33	25	52	109	61	O		
<b>ASTRA F (53_B)</b>																	
1.4 Si (60 kW)	1993.05-	2001.03	MT	L	F	Convertible Engine C14SE	GDS44002	Drive Shaft	29T	22	22	52	95	585			
	1993.05-	2001.03	MT		F	Convertible Engine C14SE	GC044051	Outer Joint	29T	22	22	52	95	50.5	O		
	1993.05-	2001.03	MT		F	Convertible Engine C14SE	GCI44004	Inner Joint		22	22	34.95	57.5	72.5			
1.6 i (52 kW)	1993.03-	1996.08	MT		F	Convertible Engine X16SZ	GCI44004	Inner Joint		22	22	34.95	57.5	72.5			
1.8 i 16V (85 kW)	1994.11-	2001.03	MT		F	Convertible Engine C18XEL/X18XE	GCI44002	Inner Joint		34	25	35	56.2	85.6			
	1994.11-	2001.03		R	F	Convertible Engine C18XEL/X18XE	GDS44048	Drive Shaft		33	34	52	109	938			
	1994.11-	2001.03		R	F	Convertible Engine C18XEL/X18XE	GCI21011	Inner Joint		34	25	35	78	64			
	1994.11-	2001.03		R	F	Convertible Engine C18XEL/X18XE	GC044049	Outer Joint		33	25	52	109	61	O		
2.0 i (85 kW)	1993.03-	1994.10	MT	R	F	Convertible Engine C20NE	GDS44059	Drive Shaft	29T	33	34	52	109	938			
	1993.03-	1994.10	MT/AT		F	Convertible Engine C20NE	GC044056	Outer Joint	29T	33	25	52	109	61	O		
	1993.03-	1994.10	MT	L	F	Convertible Engine C20NE	GDS44011	Drive Shaft	29T	33	34	52	109	594.5			
	1993.03-	1994.10	MT		F	Convertible Engine C20NE	GCI44002	Inner Joint		34	25	35	56.2	85.6			





		TRANSM	L/R	F/R		G-AP Ref.	PRODUCT	ABS	Technical Specifications							
									YEAR	A	B	C	H	L	P	
<b>OPEL</b>																
<b>ASTRA F (56_, 57_)</b>																
1.4 (55 kW)	1991.09-	1993.09	MT	L	F	Saloon Engine 14NV	GDS44002	Drive Shaft	29T	22	22	52	95	585		
	1991.09-	1993.09	MT		F	Saloon Engine 14NV	GC044051	Outer Joint	29T	22	22	52	95	50.5	O	
	1991.09-	1993.09	MT		F	Saloon Engine 14NV	GCI44004	Inner Joint		22	22	34.95	57.5	72.5		
1.4 (60 kW)	1992.09-	1998.09	MT	L	F	Saloon Engine 14SE	GDS44002	Drive Shaft	29T	22	22	52	95	585		
	1992.09-	1998.09	MT		F	Saloon Engine 14SE	GC044051	Outer Joint	29T	22	22	52	95	50.5	O	
	1992.09-	1998.09	MT		F	Saloon Engine 14SE	GCI44004	Inner Joint		22	22	34.95	57.5	72.5		
1.4 i (44 kW)	1991.09-	1998.09	MT	L	F	Saloon Engine C14NZ/X14NZ	GDS44002	Drive Shaft	29T	22	22	52	95	585		
	1991.09-	1998.09	MT		F	Saloon Engine C14NZ/X14NZ	GC044051	Outer Joint	29T	22	22	52	95	50.5	O	
	1991.09-	1998.09	MT		F	Saloon Engine C14NZ/X14NZ	GCI44004	Inner Joint		22	22	34.95	57.5	72.5		
1.4 Si (60 kW)	1992.03-	1998.09	MT	L	F	Saloon Engine C14SE	GDS44002	Drive Shaft	29T	22	22	52	95	585		
	1992.03-	1998.09	MT		F	Saloon Engine C14SE	GC044051	Outer Joint	29T	22	22	52	95	50.5	O	
	1992.03-	1998.09	MT		F	Saloon Engine C14SE	GCI44004	Inner Joint		22	22	34.95	57.5	72.5		
1.6 i (52 kW)	1993.05-	1996.07	MT		F	Saloon Engine X16SZ	GCI44004	Inner Joint		22	22	34.95	57.5	72.5		
1.6 i (55 kW)	1992.03-	1998.09	MT	L	F	Saloon Engine C16NZ/X16SZR	GDS44002	Drive Shaft	29T	22	22	52	95	585		
	1992.03-	1998.09	MT/AT		F	Saloon Engine C16NZ/X16SZR	GC044051	Outer Joint	29T	22	22	52	95	50.5	O	
	1992.03-	1998.09	MT		F	Saloon Engine C16NZ/X16SZR	GCI44004	Inner Joint		22	22	34.95	57.5	72.5		
1.6 i 16V (74 kW)	1994.08-	1998.09	MT		F	Saloon Engine X16XEL	GCI44004	Inner Joint		22	22	34.95	57.5	72.5		
	1994.08-	1998.09	MT	L	F	Saloon Engine X16XEL	GDS44002	Drive Shaft	29T	22	22	52	95	585		
1.6 Si (74 kW)	1992.05-	1994.12	MT		F	Saloon Engine C16SE	GCI44004	Inner Joint		22	22	34.95	57.5	72.5		
	1992.05-	1994.12	MT	L	F	Saloon Engine C16SE	GDS44002	Drive Shaft	29T	22	22	52	95	585		
	1992.05-	1994.12	MT		F	Saloon Engine C16SE	GC044051	Outer Joint	29T	22	22	52	95	50.5	O	
1.7 D (42 kW)	1992.03-	1992.09	MT		F	Saloon Engine 17D	GCI44004	Inner Joint		22	22	34.95	57.5	72.5		
	1992.03-	1992.09	MT/AT		F	Saloon Engine 17D	GC044056	Outer Joint	29T	33	25	52	109	61	O	
1.7 D (44 kW)	1992.07-	1998.09	MT		F	Saloon Engine 17DR	GCI44004	Inner Joint		22	22	34.95	57.5	72.5		
	1992.07-	1998.09	MT/AT		F	Saloon Engine 17DR	GC044056	Outer Joint	29T	33	25	52	109	61	O	
1.7 TD (50 kW)	1994.11-	1998.09	MT/AT		F	Saloon Engine X17DTL	GC044056	Outer Joint	29T	33	25	52	109	61	O	
1.7 TDS (60 kW)	1992.03-	1998.09	MT	R	F	Saloon Engine 17DT(TC4EE1)/X17DT(TC4EE1)	GDS44059	Drive Shaft	29T	33	34	52	109	938		
	1992.03-	1998.09	MT/AT		F	Saloon Engine 17DT(TC4EE1)/X17DT(TC4EE1)	GC044056	Outer Joint	29T	33	25	52	109	61	O	
	1992.03-	1998.09	MT	L	F	Saloon Engine 17DT(TC4EE1)/X17DT(TC4EE1)	GDS44011	Drive Shaft	29T	33	34	52	109	594.5		
	1992.03-	1998.09	MT		F	Saloon Engine 17DT(TC4EE1)/X17DT(TC4EE1)	GCI44002	Inner Joint		34	25	35	56.2	85.6		
1.8 i (66 kW)	1992.03-	1998.09	MT	R	F	Saloon Engine C18NZ	GDS44059	Drive Shaft	29T	33	34	52	109	938		
	1992.03-	1998.09	MT/AT		F	Saloon Engine C18NZ	GC044056	Outer Joint	29T	33	25	52	109	61	O	
	1992.03-	1998.09	MT	L	F	Saloon Engine C18NZ	GDS44011	Drive Shaft	29T	33	34	52	109	594.5		
	1992.03-	1998.09	MT		F	Saloon Engine C18NZ	GCI44002	Inner Joint		34	25	35	56.2	85.6		
1.8 i 16V (85 kW)	1994.11-	1998.09	MT		F	Saloon Engine C18XEL/X18XE	GCI44002	Inner Joint		34	25	35	56.2	85.6		
1.8 i 16V (92 kW)	1993.06-	1994.10	MT		F	Saloon Engine C18XE	GCI44002	Inner Joint		34	25	35	56.2	85.6		
2.0 i (85 kW)	1992.03-	1998.09	MT	R	F	Saloon Engine C20NE	GDS44059	Drive Shaft	29T	33	34	52	109	938		
	1992.03-	1998.09	MT/AT		F	Saloon Engine C20NE	GC044056	Outer Joint	29T	33	25	52	109	61	O	
	1992.03-	1998.09	MT	L	F	Saloon Engine C20NE	GDS44011	Drive Shaft	29T	33	34	52	109	594.5		
	1992.03-	1998.09	MT		F	Saloon Engine C20NE	GCI44002	Inner Joint		34	25	35	56.2	85.6		
2.0 i 16V (100 kW)	1995.02-	1998.09	MT/AT		F	Saloon Engine X20XEV	GC044056	Outer Joint	29T	33	25	52	109	61	O	
<b>ASTRA F CLASSIC</b>																
1.4 i (44 kW)	1998.01-	2002.08			F	Hatchback Engine X14NZ	GC044083	Outer Joint	29T	22	29	52.1	97.5	62.5	O	
	1998.01-	2002.08			F	Saloon Engine X14NZ	GC044083	Outer Joint	29T	22	29	52.1	97.5	62.5	O	
	1998.01-	2002.08	MT		F	Hatchback Engine X14NZ	GC044007	Outer Joint	29T	22	22	52	94.5	50	O	
	1998.01-	2002.08	MT		F	Saloon Engine X14NZ	GC044007	Outer Joint	29T	22	22	52	94.5	50	O	
	1998.01-	2002.08		R	F	Hatchback Engine X14NZ	GDS60019	Drive Shaft		22	22	52	95	926		
	1998.01-	2002.08		R	F	Saloon Engine X14NZ	GDS60019	Drive Shaft		22	22	52	95	926		
	1998.01-	2005.01			F	Estate Engine X14NZ	GC044083	Outer Joint	29T	22	29	52.1	97.5	62.5	O	
	1998.01-	2005.01	MT		F	Estate Engine X14NZ	GC044007	Outer Joint	29T	22	22	52	94.5	50	O	
	1998.01-	2005.01		R	F	Estate Engine X14NZ	GDS60019	Drive Shaft		22	22	52	95	926		
	1.6 i (55 kW)	1998.01-	2002.08			F	Hatchback Engine X16SZR	GC044083	Outer Joint	29T	22	29	52.1	97.5	62.5	O
1998.01-		2002.08			F	Saloon Engine X16SZR	GC044083	Outer Joint	29T	22	29	52.1	97.5	62.5	O	
1998.01-		2002.08	AT		F	Hatchback Engine X16SZR	GC044068	Outer Joint	29T	22	30	52	94.5	55	I	
1998.01-		2002.08	MT		F	Hatchback Engine X16SZR	GC044007	Outer Joint	29T	22	22	52	94.5	50	O	
1998.01-		2002.08	MT		F	Saloon Engine X16SZR	GC044007	Outer Joint	29T	22	22	52	94.5	50	O	
1998.01-		2002.08		R	F	Hatchback Engine X16SZR	GDS60019	Drive Shaft		22	22	52	95	926		
1998.01-		2002.08		R	F	Saloon Engine X16SZR	GDS60019	Drive Shaft		22	22	52	95	926		
1998.01-		2005.01			F	Estate Engine X16SZR	GC044083	Outer Joint	29T	22	29	52.1	97.5	62.5	O	
1998.01-		2005.01	AT		F	Estate Engine X16SZR	GC044068	Outer Joint	29T	22	30	52	94.5	55	I	
1998.01-		2005.01	MT		F	Estate Engine X16SZR	GC044007	Outer Joint	29T	22	22	52	94.5	50	O	





	 <b>YEAR</b>	<b>TRANSM</b>	<b>L/R</b>	<b>F/R</b>		<b>G-AP Ref.</b>	<b>PRODUCT</b>	<b>ABS</b>	<b>Technical Specifications</b>												
									<b>A</b>	<b>B</b>	<b>C</b>	<b>H</b>	<b>L</b>	<b>P</b>							
<b>OPEL</b>																					
<b>ASTRA F CLASSIC</b>																					
1.6 i (55 kW)	1998.01-	2005.01			R	F	Estate Engine X16SZR	GDS60019	Drive Shaft		22	22	52	95	926						
1.6 i 16V (74 kW)	1998.01-	2002.08				F	Hatchback Engine X16XEL	GC044083	Outer Joint	29T	22	29	52.1	97.5	62.5	O					
	1998.01-	2002.08				F	Saloon Engine X16XEL	GC044083	Outer Joint	29T	22	29	52.1	97.5	62.5	O					
	1998.01-	2002.08	MT			F	Hatchback Engine X16XEL	GC044007	Outer Joint	29T	22	22	52	94.5	50	O					
	1998.01-	2002.08	MT			F	Saloon Engine X16XEL	GC044007	Outer Joint	29T	22	22	52	94.5	50	O					
	1998.01-	2002.08			R	F	Hatchback Engine X16XEL	GDS60019	Drive Shaft		22	22	52	95	926						
	1998.01-	2005.01				F	Estate Engine X16XEL	GC044083	Outer Joint	29T	22	29	52.1	97.5	62.5	O					
	1998.01-	2005.01	AT			F	Estate Engine X16XEL	GC044068	Outer Joint	29T	22	30	52	94.5	55	I					
	1998.01-	2005.01	MT			F	Estate Engine X16XEL	GC044007	Outer Joint	29T	22	22	52	94.5	50	O					
	1998.01-	2005.01			R	F	Estate Engine X16XEL	GDS60019	Drive Shaft		22	22	52	95	926						
<b>ASTRA F CLASSIC, SW</b>																					
1.4 i (44 kW)	1998-	2004					Ch-P2732834	GC044060	Outer Joint	29T	22	22	52	98	51	O					
1.4 i (46 kW)	1998-	2004					Ch-P2732834	GC044060	Outer Joint	29T	22	22	52	98	51	O					
1.6 i 16V (55 kW)	1998-	2004						GC044006	Outer Joint	29T	33	25	52	103.5	61	O					
1.7 TD (50 kW)	1998-	2000					Ch-P8202126	GC044060	Outer Joint	29T	22	22	52	98	51	O					
1.8 i (85 kW)	1998-	2000						GC044006	Outer Joint	29T	33	25	52	103.5	61	O					
2.0 i (100 kW)	1998-	2000					Ch-P8202126	GC044060	Outer Joint	29T	22	22	52	98	51	O					
<b>ASTRA F VAN (55_)</b>																					
1.4 i (44 kW)	1991.10-	1999.01	MT			F	Box Engine C14NZ	GCI44004	Inner Joint		22	22	34.95	57.5	72.5						
	1991.10-	1999.01	MT	L		F	Box Engine C14NZ	GDS44002	Drive Shaft	29T	22	22	52	95	585						
	1991.10-	1999.01	MT			F	Box Engine C14NZ	GC044051	Outer Joint	29T	22	22	52	95	50.5	O					
1.6 i (52 kW)	1993.02-	1996.07	MT			F	Box Engine X16SZ	GCI44004	Inner Joint		22	22	34.95	57.5	72.5						
1.6 i (55 kW)	1991.10-	1993.04	MT			F	Box Engine C16NZ	GCI44004	Inner Joint		22	22	34.95	57.5	72.5						
	1991.10-	1993.04	MT	L		F	Box Engine C16NZ	GDS44002	Drive Shaft	29T	22	22	52	95	585						
	1991.10-	1993.04	MT			F	Box Engine C16NZ	GC044051	Outer Joint	29T	22	22	52	95	50.5	O					
1.7 D (42 kW)	1991.12-	1992.09	MT			F	Box Engine 17D	GCI44004	Inner Joint		22	22	34.95	57.5	72.5						
	1991.12-	1992.09	MT/AT			F	Box Engine 17D	GC044056	Outer Joint	29T	33	25	52	109	61	O					
1.7 D (44 kW)	1992.07-	1999.01	MT			F	Box Engine 17DR	GCI44004	Inner Joint		22	22	34.95	57.5	72.5						
	1992.07-	1999.01	MT/AT			F	Box Engine 17DR	GC044056	Outer Joint	29T	33	25	52	109	61	O					
1.7 TD (50 kW)	1994.08-	1999.01	MT/AT			F	Box Engine X17DTL	GC044056	Outer Joint	29T	33	25	52	109	61	O					
<b>ASTRA G</b>																					
1.6 16V (74 kW)	2001.03-	2005.10	MT/AT			F	Convertible Engine Z16XE	GC044030	Outer Joint		33	22	52	103	50.5	O					
	2001.03-	2005.10	MT	L		F	Convertible Engine Z16XE	GCI21014	Inner Joint		22	22	35	57.5	75						
	2001.03-	2005.10	MT	L		F	Convertible Engine Z16XE	GDS60013	Drive Shaft		33	22	52	103	595						
	2001.03-	2005.10	MT	R		F	Convertible Engine Z16XE	GDS44033	Drive Shaft		33	22	52	103	950.5						
1.8 16V (92 kW)	2001.03-	2005.10				F	Convertible Engine Z18XE	GC044049	Outer Joint		33	25	52	109	61	O					
	2001.03-	2005.10	MT	R		F	Convertible Engine Z18XE	GDS60035	Drive Shaft		33	22	52	109	961						
2.0 16V Turbo (147 kW)	2002.11-	2005.10	MT	R		F	Convertible Engine Z20LET	GDS44082	Drive Shaft		33	34	55	104	663						
	2002.11-	2005.10	MT	R		F	Convertible Engine Z20LET	GDS60035	Drive Shaft		33	22	52	109	961						
2.0 OPC (141 kW)	2002.03-	2005.10	MT	L		F	Convertible Engine Z20LET	GDS44025	Drive Shaft		33	34	55	104	593						
	2002.03-	2005.10	MT	L		F	Convertible Engine Z20LET	GCI44018	Inner Joint		34	35	35	56	119.5						
	2002.03-	2005.10	MT	L		F	Convertible Engine Z20LET	GC099061	Outer Joint		33	35	55	104	67.5	I					
	2002.03-	2005.10	MT	R		F	Convertible Engine Z20LET	GDS44082	Drive Shaft		33	34	55	104	663						
2.2 16V (108 kW)	2001.03-	2005.10				F	Convertible Engine Z22SE	GC044049	Outer Joint		33	25	52	109	61	O					
	2001.03-	2005.10	MT	L		F	Convertible Engine Z22SE	GDS44044	Drive Shaft		33	34	52	103.5	595						
2.2 DTi (86 kW)	2002.09-	2005.01						GCI99188	Inner Joint		27	35	35	101	88.5						
2.2 DTi (92 kW)	2002.09-	2005.10				F	Convertible Engine Y22DTR	GC044049	Outer Joint		33	25	52	109	61	O					
	2002.09-	2005.01						GCI99188	Inner Joint		27	35	35	101	88.5						
<b>ASTRA G (F07_)</b>																					
1.6 16V (76 kW)	2000.03-	2005.05	MT/AT			F	Coupe Engine Z16XEP	GC044030	Outer Joint		33	22	52	103	50.5	O					
	2000.03-	2005.05	MT	L		F	Coupe Engine Z16XEP	GCI21014	Inner Joint		22	22	35	57.5	75						
	2000.03-	2005.05	MT	L		F	Coupe Engine Z16XEP	GDS60013	Drive Shaft		33	22	52	103	595						
	2000.03-	2005.05	MT	R		F	Coupe Engine Z16XEP	GDS44033	Drive Shaft		33	22	52	103	950.5						
1.8 16V (92 kW)	2000.09-	2005.05				F	Coupe Engine Z18XE	GC044049	Outer Joint		33	25	52	109	61	O					
	2000.09-	2005.05	MT	R		F	Coupe Engine Z18XE	GDS60035	Drive Shaft		33	22	52	109	961						
2.0 16V Turbo (140 kW)	2000.09-	2001.08	MT	L		F	Coupe Engine Z20LET	GDS44025	Drive Shaft		33	34	55	104	593						
	2000.09-	2001.08	MT	L		F	Coupe Engine Z20LET	GCI44018	Inner Joint		34	35	35	56	119.5						
	2000.09-	2001.08	MT	L		F	Coupe Engine Z20LET	GC099061	Outer Joint		33	35	55	104	67.5	I					
	2000.09-	2001.08	MT	R		F	Coupe Engine Z20LET	GDS44082	Drive Shaft		33	34	55	104	663						
2.0 16V Turbo (141 kW)	2001.08-	2005.05	MT	L		F	Coupe Engine Z20LET	GDS44025	Drive Shaft		33	34	55	104	593						
	2001.08-	2005.05	MT	L		F	Coupe Engine Z20LET	GCI44018	Inner Joint		34	35	35	56	119.5						



		YEAR	TRANSM	L/R	F/R		G-AP Ref.	PRODUCT	ABS	Technical Specifications						
										A	B	C	H	L	P	
<b>OPEL</b>																
<b>ASTRA G (F07_)</b>																
2.0 16V Turbo (141 kW)	2001.08-	2005.05	MT	L	F	Coupe Engine Z20LET	GC099061	Outer Joint		33	35	55	104	67.5	I	
	2001.08-	2005.05	MT	R	F	Coupe Engine Z20LET	GDS44082	Drive Shaft		33	34	55	104	663		
2.0 16V Turbo (147 kW)	2000.07-	2004.12	MT	L	F	Coupe Engine Z20LET	GDS44025	Drive Shaft		33	34	55	104	593		
	2000.07-	2004.12	MT	L	F	Coupe Engine Z20LET	GCI44018	Inner Joint		34	35	35	56	119.5		
	2000.07-	2004.12	MT	L	F	Coupe Engine Z20LET	GC099061	Outer Joint		33	35	55	104	67.5	I	
	2000.07-	2004.12	MT	R	F	Coupe Engine Z20LET	GDS44082	Drive Shaft		33	34	55	104	663		
	2000.07-	2004.12	MT	R	F	Coupe Engine Z20LET	GDS44082	Drive Shaft		33	34	55	104	663		
2.2 16V (108 kW)	2000.09-	2005.05			F	Coupe Engine Z22SE	GC044049	Outer Joint		33	25	52	109	61	O	
	2000.09-	2005.05	MT	L	F	Coupe Engine Z22SE	GDS44044	Drive Shaft		33	34	52	103.5	595		
2.2 DTi (92 kW)	2002.09-	2005.05			F	Coupe Engine Y22DTR	GC044049	Outer Joint		33	25	52	109	61	O	
<b>ASTRA G (F35_)</b>																
1.2 16V (55 kW)	2000.09-	2004.07	5MT		F	Estate Engine Z12XE	GC044012	Outer Joint		33	28	52	104	54.5	O	
1.4 (66 kW)	2007.09-	2009.12		L	F	Estate Engine Z14XEP	GDS60013	Drive Shaft		33	22	52	103	595		
	2007.09-	2009.12		L	F	Estate Engine Z14XEP	GCI21014	Inner Joint		22	22	35	57.5	75		
	2007.09-	2009.12		R	F	Estate Engine Z14XEP	GDS44033	Drive Shaft		33	22	52	103	950.5		
1.4 16V (66 kW)	1998.06-	2004.07	MT/AT		F	Estate Engine X14XE/Z14XE	GC044030	Outer Joint		33	22	52	103	50.5	O	
	1998.06-	2004.07	MT	L	F	Estate Engine X14XE/Z14XE	GCI21014	Inner Joint		22	22	35	57.5	75		
	1998.06-	2004.07	MT	L	F	Estate Engine X14XE/Z14XE	GDS60013	Drive Shaft		33	22	52	103	595		
	1998.06-	2004.07	MT	R	F	Estate Engine X14XE/Z14XE	GDS44033	Drive Shaft		33	22	52	103	950.5		
1.6 (62 kW)	2000.09-	2004.07	MT/AT		F	Estate Engine Z16SE	GC044030	Outer Joint		33	22	52	103	50.5	O	
	2000.09-	2004.07	MT	L	F	Estate Engine Z16SE	GCI21014	Inner Joint		22	22	35	57.5	75		
	2000.09-	2004.07	MT	L	F	Estate Engine Z16SE	GDS60013	Drive Shaft		33	22	52	103	595		
	2000.09-	2004.07	MT	R	F	Estate Engine Z16SE	GDS44033	Drive Shaft		33	22	52	103	950.5		
1.6 (76 kW)	2002.12-	2009.07	MT/AT		F	Estate Engine Z16XEP	GC044030	Outer Joint		33	22	52	103	50.5	O	
	2002.12-	2009.07	MT	L	F	Estate Engine Z16XEP	GCI21014	Inner Joint		22	22	35	57.5	75		
	2002.12-	2009.07	MT	L	F	Estate Engine Z16XEP	GDS60013	Drive Shaft		33	22	52	103	595		
	2002.12-	2009.07	MT	R	F	Estate Engine Z16XEP	GDS44033	Drive Shaft		33	22	52	103	950.5		
1.6 16V (74 kW)	1998.02-	2004.07	MT/AT		F	Estate Engine X16XEL/Z16XE	GC044030	Outer Joint		33	22	52	103	50.5	O	
	1998.02-	2004.07	MT	L	F	Estate Engine X16XEL/Z16XE	GCI21014	Inner Joint		22	22	35	57.5	75		
	1998.02-	2004.07	MT	L	F	Estate Engine X16XEL/Z16XE	GDS60013	Drive Shaft		33	22	52	103	595		
	1998.02-	2004.07	MT	R	F	Estate Engine X16XEL/Z16XE	GDS44033	Drive Shaft		33	22	52	103	950.5		
1.6 CNG (71 kW)	2003.03-	2004.07	MT	R	F	Estate Engine Z16YNG	GDS60035	Drive Shaft		33	22	52	109	961		
1.7 CDTi (59 kW)	2003.04-	2009.07	MT	R	F	Estate Engine Z17DTL	GDS60035	Drive Shaft		33	22	52	109	961		
1.7 DTi 16V (55 kW)	2000.02-	2004.07	5MT		F	Estate Engine Y17DT	GC044049	Outer Joint		33	25	52	109	61	O	
	2000.02-	2004.07	MT	R	F	Estate Engine Y17DT	GDS60035	Drive Shaft		33	22	52	109	961		
1.8 16V (92 kW)	2000.09-	2004.07			F	Estate Engine Z18XE	GC044049	Outer Joint		33	25	52	109	61	O	
	2000.09-	2004.07	MT	R	F	Estate Engine Z18XE	GDS60035	Drive Shaft		33	22	52	109	961		
2.0 16V (100 kW)	1998.02-	2004.07			F	Estate Engine X20XEV	GC044049	Outer Joint		33	25	52	109	61	O	
	1998.02-	2004.07	MT/AT		F	Estate Engine X20XEV	GC044006	Outer Joint	29T	33	25	52	103.5	61	O	
	1998.02-	2004.07	MT	L	F	Estate Engine X20XEV	GDS44044	Drive Shaft		33	34	52	103.5	595		
2.0 Di (60 kW)	1998.02-	2004.07			F	Estate Engine X20DTL/Y20DTL	GC044049	Outer Joint		33	25	52	109	61	O	
	1998.02-	2004.07	MT/AT		F	Estate Engine X20DTL/Y20DTL	GC044006	Outer Joint	29T	33	25	52	103.5	61	O	
	1998.02-	2004.07	MT	L	F	Estate Engine X20DTL/Y20DTL	GDS44044	Drive Shaft		33	34	52	103.5	595		
2.0 DTi 16V (74 kW)	1999.08-	2004.07			F	Estate Engine X20DTH/Y20DTH	GC044049	Outer Joint		33	25	52	109	61	O	
	1999.08-	2004.07	MT	L	F	Estate Engine X20DTH/Y20DTH	GDS44044	Drive Shaft		33	34	52	103.5	595		
2.0 OPC (141 kW)	2002.09-	2004.07	MT	L	F	Estate Engine Z20LET	GDS44025	Drive Shaft		33	34	55	104	593		
	2002.09-	2004.07	MT	L	F	Estate Engine Z20LET	GCI44018	Inner Joint		34	35	35	56	119.5		
	2002.09-	2004.07	MT	L	F	Estate Engine Z20LET	GC099061	Outer Joint		33	35	55	104	67.5	I	
	2002.09-	2004.07	MT	R	F	Estate Engine Z20LET	GDS44082	Drive Shaft		33	34	55	104	663		
2.0 OPC (147 kW)	2002.11-	2004.07	MT	L	F	Estate Engine Z20LET	GDS44025	Drive Shaft		33	34	55	104	593		
	2002.11-	2004.07	MT	L	F	Estate Engine Z20LET	GCI44018	Inner Joint		34	35	35	56	119.5		
	2002.11-	2004.07	MT	L	F	Estate Engine Z20LET	GC099061	Outer Joint		33	35	55	104	67.5	I	
	2002.11-	2004.07	MT	R	F	Estate Engine Z20LET	GDS44082	Drive Shaft		33	34	55	104	663		
2.2 16V (108 kW)	2001.03-	2004.07			F	Estate Engine Z22SE	GC044049	Outer Joint		33	25	52	109	61	O	
	2001.03-	2004.07	MT	L	F	Estate Engine Z22SE	GDS44044	Drive Shaft		33	34	52	103.5	595		
2.2 DTi (92 kW)	2002.09-	2004.07			F	Estate Engine Y22DTR	GC044049	Outer Joint		33	25	52	109	61	O	
<b>ASTRA G (F48_, F08_)</b>																
1.2 16V (55 kW)	2000.09-	2005.01	5MT		F	Hatchback Engine Z12XE	GC044012	Outer Joint		33	28	52	104	54.5	O	
1.4 (66 kW)	2007.09-	2009.12		L	F	Hatchback Engine Z14XEP	GDS60013	Drive Shaft		33	22	52	103	595		
	2007.09-	2009.12		L	F	Hatchback Engine Z14XEP	GCI21014	Inner Joint		22	22	35	57.5	75		
	2007.09-	2009.12		R	F	Hatchback Engine Z14XEP	GDS44033	Drive Shaft		33	22	52	103	950.5		
1.4 16V (66 kW)	1998.02-	2005.01	MT/AT		F	Hatchback Engine X14XE/Z14XE	GC044030	Outer Joint		33	22	52	103	50.5	O	





		YEAR	TRANSM	L/R	F/R		G-AP Ref.	PRODUCT	ABS	Technical Specifications						
										A	B	C	H	L	P	
<b>OPEL</b>																
<b>ASTRA G (F48_, F08_)</b>																
1.4 16V (66 kW)	1998.02-	2005.01	MT	L	F	Hatchback Engine X14XE/Z14XE	GCI21014	Inner Joint		22	22	35	57.5	75		
	1998.02-	2005.01	MT	L	F	Hatchback Engine X14XE/Z14XE	GDS60013	Drive Shaft		33	22	52	103	595		
	1998.02-	2005.01	MT	R	F	Hatchback Engine X14XE/Z14XE	GDS44033	Drive Shaft		33	22	52	103	950.5		
1.6 (62 kW)	2000.09-	2005.01	MT/AT		F	Hatchback Engine Z16SE	GC044030	Outer Joint		33	22	52	103	50.5	O	
	2000.09-	2005.01	MT	L	F	Hatchback Engine Z16SE	GCI21014	Inner Joint		22	22	35	57.5	75		
	2000.09-	2005.01	MT	L	F	Hatchback Engine Z16SE	GDS60013	Drive Shaft		33	22	52	103	595		
	2000.09-	2005.01	MT	R	F	Hatchback Engine Z16SE	GDS44033	Drive Shaft		33	22	52	103	950.5		
1.6 (76 kW)	2002.12-	2009.12	MT/AT		F	Hatchback Engine Z16XEP	GC044030	Outer Joint		33	22	52	103	50.5	O	
	2002.12-	2009.12	MT	L	F	Hatchback Engine Z16XEP	GCI21014	Inner Joint		22	22	35	57.5	75		
	2002.12-	2009.12	MT	L	F	Hatchback Engine Z16XEP	GDS60013	Drive Shaft		33	22	52	103	595		
	2002.12-	2009.12	MT	R	F	Hatchback Engine Z16XEP	GDS44033	Drive Shaft		33	22	52	103	950.5		
1.6 16V (74 kW)	1998.02-	2005.01	MT/AT		F	Hatchback Engine X16XEL/Z16XE	GC044030	Outer Joint		33	22	52	103	50.5	O	
	1998.02-	2005.01	MT	L	F	Hatchback Engine X16XEL/Z16XE	GCI21014	Inner Joint		22	22	35	57.5	75		
	1998.02-	2005.01	MT	L	F	Hatchback Engine X16XEL/Z16XE	GDS60013	Drive Shaft		33	22	52	103	595		
	1998.02-	2005.01	MT	R	F	Hatchback Engine X16XEL/Z16XE	GDS44033	Drive Shaft		33	22	52	103	950.5		
1.7 DTi 16V (55 kW)	2000.02-	2005.01	5MT		F	Hatchback Engine Y17DT	GC044049	Outer Joint		33	25	52	109	61	O	
	2000.02-	2005.01	MT	R	F	Hatchback Engine Y17DT	GDS60035	Drive Shaft		33	22	52	109	961		
1.8 16V (92 kW)	2000.09-	2005.01			F	Hatchback Engine Z18XE	GC044049	Outer Joint		33	25	52	109	61	O	
	2000.09-	2005.01	MT	R	F	Hatchback Engine Z18XE	GDS60035	Drive Shaft		33	22	52	109	961		
2.0 16V (100 kW)	1998.02-	2005.01			F	Hatchback Engine X20XE	GC044049	Outer Joint		33	25	52	109	61	O	
	1998.02-	2005.01	MT/AT		F	Hatchback Engine X20XE	GC044006	Outer Joint	29T	33	25	52	103.5	61	O	
	1998.02-	2005.01	MT	L	F	Hatchback Engine X20XE	GDS44044	Drive Shaft		33	34	52	103.5	595		
2.0 16V OPC (118 kW)	1999.11-	2002.09	MT/AT		F	Hatchback Engine X20XER	GC044006	Outer Joint	29T	33	25	52	103.5	61	O	
	1999.11-	2002.09	MT	L	F	Hatchback Engine X20XER	GDS44044	Drive Shaft		33	34	52	103.5	595		
2.0 Di (60 kW)	1998.02-	2005.01			F	Hatchback Engine X20DTL/Y20DTL	GC044049	Outer Joint		33	25	52	109	61	O	
	1998.02-	2005.01	MT/AT		F	Hatchback Engine X20DTL/Y20DTL	GC044006	Outer Joint	29T	33	25	52	103.5	61	O	
	1998.02-	2005.01	MT	L	F	Hatchback Engine X20DTL/Y20DTL	GDS44044	Drive Shaft		33	34	52	103.5	595		
2.0 DTi 16V (74 kW)	1999.08-	2005.01			F	Hatchback Engine X20DTH/Y20DTH	GC044049	Outer Joint		33	25	52	109	61	O	
	1999.08-	2005.01	MT	L	F	Hatchback Engine X20DTH/Y20DTH	GDS44044	Drive Shaft		33	34	52	103.5	595		
2.0 OPC (141 kW)	2002.09-	2005.01	MT	L	F	Hatchback Engine Z20LET	GDS44025	Drive Shaft		33	34	55	104	593		
	2002.09-	2005.01	MT	L	F	Hatchback Engine Z20LET	GCI44018	Inner Joint		34	35	35	56	119.5		
	2002.09-	2005.01	MT	L	F	Hatchback Engine Z20LET	GC099061	Outer Joint		33	35	55	104	67.5	I	
	2002.09-	2005.01	MT	R	F	Hatchback Engine Z20LET	GDS44082	Drive Shaft		33	34	55	104	663		
2.0 OPC (147 kW)	2002.11-	2005.01	MT	L	F	Hatchback Engine Z20LET	GDS44025	Drive Shaft		33	34	55	104	593		
	2002.11-	2005.01	MT	L	F	Hatchback Engine Z20LET	GCI44018	Inner Joint		34	35	35	56	119.5		
	2002.11-	2005.01	MT	L	F	Hatchback Engine Z20LET	GC099061	Outer Joint		33	35	55	104	67.5	I	
	2002.11-	2005.01	MT	R	F	Hatchback Engine Z20LET	GDS44082	Drive Shaft		33	34	55	104	663		
2.2 16V (108 kW)	2000.06-	2005.01			F	Hatchback Engine Z22SE	GC044049	Outer Joint		33	25	52	109	61	O	
	2000.06-	2005.01	MT	L	F	Hatchback Engine Z22SE	GDS44044	Drive Shaft		33	34	52	103.5	595		
2.2 DTi (92 kW)	2002.09-	2005.01			F	Hatchback Engine Y22DTR	GC044049	Outer Joint		33	25	52	109	61	O	
<b>ASTRA G (F67)</b>																
1.6 (76 kW)	2003.01-	2005.10	MT/AT		F	Convertible Engine Z16XEP	GC044030	Outer Joint		33	22	52	103	50.5	O	
	2003.01-	2005.10	MT	L	F	Convertible Engine Z16XEP	GCI21014	Inner Joint		22	22	35	57.5	75		
	2003.01-	2005.10	MT	L	F	Convertible Engine Z16XEP	GDS60013	Drive Shaft		33	22	52	103	595		
	2003.01-	2005.10	MT	R	F	Convertible Engine Z16XEP	GDS44033	Drive Shaft		33	22	52	103	950.5		
<b>ASTRA G (F69_)</b>																
1.2 16V (55 kW)	2000.09-	2005.01	5MT		F	Saloon Engine Z12XE	GC044012	Outer Joint		33	28	52	104	54.5	O	
1.4 (66 kW)	2007.09-	2009.12		L	F	Saloon Engine Z14XEP	GDS60013	Drive Shaft		33	22	52	103	595		
	2007.09-	2009.12		L	F	Saloon Engine Z14XEP	GCI21014	Inner Joint		22	22	35	57.5	75		
	2007.09-	2009.12		R	F	Saloon Engine Z14XEP	GDS44033	Drive Shaft		33	22	52	103	950.5		
1.4 16V (66 kW)	1998.09-	2005.01	MT/AT		F	Saloon Engine X14XE/Z14XE	GC044030	Outer Joint		33	22	52	103	50.5	O	
	1998.09-	2005.01	MT	L	F	Saloon Engine X14XE/Z14XE	GCI21014	Inner Joint		22	22	35	57.5	75		
	1998.09-	2005.01	MT	L	F	Saloon Engine X14XE/Z14XE	GDS60013	Drive Shaft		33	22	52	103	595		
	1998.09-	2005.01	MT	R	F	Saloon Engine X14XE/Z14XE	GDS44033	Drive Shaft		33	22	52	103	950.5		
1.6 (62 kW)	2000.09-	2005.01	MT/AT		F	Saloon Engine Z16SE	GC044030	Outer Joint		33	22	52	103	50.5	O	
	2000.09-	2005.01	MT	L	F	Saloon Engine Z16SE	GCI21014	Inner Joint		22	22	35	57.5	75		
	2000.09-	2005.01	MT	L	F	Saloon Engine Z16SE	GDS60013	Drive Shaft		33	22	52	103	595		
	2000.09-	2005.01	MT	R	F	Saloon Engine Z16SE	GDS44033	Drive Shaft		33	22	52	103	950.5		
1.6 (76 kW)	2002.12-	2005.01	MT/AT		F	Saloon Engine Z16XEP	GC044030	Outer Joint		33	22	52	103	50.5	O	
	2002.12-	2005.01	MT	L	F	Saloon Engine Z16XEP	GCI21014	Inner Joint		22	22	35	57.5	75		
	2002.12-	2005.01	MT	L	F	Saloon Engine Z16XEP	GDS60013	Drive Shaft		33	22	52	103	595		
	2002.12-	2005.01	MT	R	F	Saloon Engine Z16XEP	GDS44033	Drive Shaft		33	22	52	103	950.5		









		TRANSM	L/R	F/R		G-AP Ref.	PRODUCT	ABS	Technical Specifications							
									YEAR	A	B	C	H	L	P	
<b>OPEL</b>																
<b>ASTRA G (F69_)</b>																
1.6 (76 kW)	2002.12-	2005.01	MT	R	F	Saloon Engine Z16XEP	GDS44033	Drive Shaft		33	22	52	103	950.5		
1.6 16V (74 kW)	1998.09-	2005.01	MT/AT		F	Saloon Engine X16XEL/Z16XE	GC044030	Outer Joint		33	22	52	103	50.5	O	
	1998.09-	2005.01	MT	L	F	Saloon Engine X16XEL/Z16XE	GCI21014	Inner Joint		22	22	35	57.5	75		
	1998.09-	2005.01	MT	L	F	Saloon Engine X16XEL/Z16XE	GDS60013	Drive Shaft		33	22	52	103	595		
	1998.09-	2005.01	MT	R	F	Saloon Engine X16XEL/Z16XE	GDS44033	Drive Shaft		33	22	52	103	950.5		
1.7 CDTi (59 kW)	2003.04-	2004.05	MT	R	F	Saloon Engine Z17DTL	GDS60035	Drive Shaft		33	22	52	109	961		
1.7 DTi 16V (55 kW)	2000.02-	2005.01	MT		F	Saloon Engine Y17DT	GC044049	Outer Joint		33	25	52	109	61	O	
	2000.02-	2005.01	MT	R	F	Saloon Engine Y17DT	GDS60035	Drive Shaft		33	22	52	109	961		
1.8 16V (92 kW)	2000.06-	2005.01			F	Saloon Engine Z18XE	GC044049	Outer Joint		33	25	52	109	61	O	
	2000.06-	2005.01	MT	R	F	Saloon Engine Z18XE	GDS60035	Drive Shaft		33	22	52	109	961		
2.0 16V (100 kW)	1998.09-	2005.01			F	Saloon Engine X20XE	GC044049	Outer Joint		33	25	52	109	61	O	
	1998.09-	2005.01	MT/AT		F	Saloon Engine X20XE	GC044006	Outer Joint	29T	33	25	52	103.5	61	O	
	1998.09-	2005.01	MT	L	F	Saloon Engine X20XE	GDS44044	Drive Shaft		33	34	52	103.5	595		
2.0 Di (60 kW)	1998.09-	2005.01			F	Saloon Engine X20DTL/Y20DTL	GC044049	Outer Joint		33	25	52	109	61	O	
	1998.09-	2005.01	MT/AT		F	Saloon Engine X20DTL/Y20DTL	GC044006	Outer Joint	29T	33	25	52	103.5	61	O	
	1998.09-	2005.01	MT	L	F	Saloon Engine X20DTL/Y20DTL	GDS44044	Drive Shaft		33	34	52	103.5	595		
2.0 DTi 16V (74 kW)	1999.08-	2005.01			F	Saloon Engine X20DTH/Y20DTH	GC044049	Outer Joint		33	25	52	109	61	O	
	1999.08-	2005.01	MT	L	F	Saloon Engine X20DTH/Y20DTH	GDS44044	Drive Shaft		33	34	52	103.5	595		
2.2 16V (108 kW)	2001.03-	2005.01			F	Saloon Engine Z22SE	GC044049	Outer Joint		33	25	52	109	61	O	
	2001.03-	2005.01	MT	L	F	Saloon Engine Z22SE	GDS44044	Drive Shaft		33	34	52	103.5	595		
2.2 DTi (92 kW)	2002.09-	2005.01			F	Saloon Engine Y22DTR	GC044049	Outer Joint		33	25	52	109	61	O	
<b>ASTRA G (F70)</b>																
1.6 (62 kW)	2000.09-	2005.04	MT/AT		F	Box Engine Z16SE	GC044030	Outer Joint		33	22	52	103	50.5	O	
	2000.09-	2005.04	MT	L	F	Box Engine Z16SE	GCI21014	Inner Joint		22	22	35	57.5	75		
	2000.09-	2005.04	MT	L	F	Box Engine Z16SE	GDS60013	Drive Shaft		33	22	52	103	595		
	2000.09-	2005.04	MT	R	F	Box Engine Z16SE	GDS44033	Drive Shaft		33	22	52	103	950.5		
1.7 DTi 16V (55 kW)	2000.02-	2005.04			R	F	Box Engine Y17DT	GDS60035	Drive Shaft		33	22	52	109	961	
1.7 TD (50 kW)	1999.01-	2005.04	MT/AT		F	Box Engine X17DTL	GC044030	Outer Joint		33	22	52	103	50.5	O	
	1999.01-	2005.04	MT	L	F	Box Engine X17DTL	GCI21014	Inner Joint		22	22	35	57.5	75		
	1999.01-	2005.04	MT	L	F	Box Engine X17DTL	GDS60013	Drive Shaft		33	22	52	103	595		
	1999.01-	2005.04	MT	R	F	Box Engine X17DTL	GDS44033	Drive Shaft		33	22	52	103	950.5		
2.0 Di (60 kW)	1999.01-	2005.04			F	Box Engine X20DTL	GC044049	Outer Joint		33	25	52	109	61	O	
	1999.01-	2005.04	MT	L	F	Box Engine X20DTL	GDS44044	Drive Shaft		33	34	52	103.5	595		
<b>ASTRA G, SW</b>																
-	1998-					Excl.Italy Classic Ch.-No YG039154-/ 1G043744-	GC044033	Outer Joint		22	22	52	98	51	O	
1.4 (66 kW)	2003.09-	2005.01					GCI21014	Inner Joint		22	22	35	57.5	75		
1.4 16V (66 kW)	1998.02-	2005.01					GCI21014	Inner Joint		22	22	35	57.5	75		
1.6 (62 kW)	2000.09-	2005.01					GCI21014	Inner Joint		22	22	35	57.5	75		
1.6 16V (74 kW)	1998.02-	2005.01					GCI21014	Inner Joint		22	22	35	57.5	75		
1.6 16V (76 kW)	1998.02-	2005.01					GCI21014	Inner Joint		22	22	35	57.5	75		
1.6 i 16V (55 kW)	1998-	2000					GCI21014	Inner Joint		22	22	35	57.5	75		
1.7 CDTi (59 kW)	2000.02-	2005.01					GCI21014	Inner Joint		22	22	35	57.5	75		
1.7 DTi 16V (48 kW)	2000.02-	2005.01					GCI99026	Inner Joint		22	25	35	57	82.5		
	2000.02-	2005.01					GC044006	Outer Joint	29T	33	25	52	103.5	61	O	
1.7 DTi 16V (55 kW)	2000.02-	2005.01					GCI99026	Inner Joint		22	25	35	57	82.5		
	2000.02-	2005.01					GC044006	Outer Joint	29T	33	25	52	103.5	61	O	
1.7 TD (50 kW)	1998.02-	2000.08					GCI21014	Inner Joint		22	22	35	57.5	75		
1.8 16V (85 kW)	1998.02-	2005.01					GCI99026	Inner Joint		22	25	35	57	82.5		
1.8 16V (87 kW)	1998.02-	2005.01					GCI99026	Inner Joint		22	25	35	57	82.5		
1.8 16V (92 kW)	1998.02-	2005.01					GCI99026	Inner Joint		22	25	35	57	82.5		
2.0 16V (100 kW)	1998.02-	2005.01					GCI21011	Inner Joint		34	25	35	78	64		
	1998.02-	2005.01					GC044006	Outer Joint	29T	33	25	52	103.5	61	O	
2.0 16V OPC (118 kW)	1999.11-	2002.09					GCI21011	Inner Joint		34	25	35	78	64		
	1999.11-	2002.09					GC044006	Outer Joint	29T	33	25	52	103.5	61	O	
2.0 Di 16V (60 kW)	1998.02-	2005.01				Engine X20DTL	GC044006	Outer Joint	29T	33	25	52	103.5	61	O	
2.0 DI 16V (60 kW)	1998.02-	2005.01					GCI21011	Inner Joint		34	25	35	78	64		
2.0 DTi 16V (74 kW)	1999.08-	2005.01					GCI21011	Inner Joint		34	25	35	78	64		
	1999.08-	2005.01					GC044006	Outer Joint	29T	33	25	52	103.5	61	O	
2.2 16V (108 kW)	2001.03-	2005.01					GCI21011	Inner Joint		34	25	35	78	64		
	2001.03-	2005.01					GC044006	Outer Joint	29T	33	25	52	103.5	61	O	



		TRANSM	L/R	F/R		G-AP Ref.	PRODUCT	ABS	Technical Specifications							
									YEAR	A	B	C	H	L	P	
<b>OPEL</b>																
<b>ASTRA GTC J</b>																
1.4 (103 kW)	2011.10-	AT			Hatchback Engine A14NET	GC088047	Outer Joint		33	23	52.5	94	59.5	M		
1.4 (74 kW)	2011.10-	MT	L	F	Hatchback Engine A14XER	GDS44064	Drive Shaft		33	22	53	95	618			
	2011.10-	MT	L	F	Hatchback Engine A14XER	GCI21014	Inner Joint		22	22	35	57.5	75			
	2011.10-				Hatchback Engine A14XER	GC044088	Outer Joint		33	23	52.3	94	59.5	M		
1.7 CDTi (81 kW)	2011.10-	MT	L	F	Hatchback Engine A17DTC/A17DTE/A17DTJ	GDS21076	Drive Shaft		30	25	52.5	94	601			
	2011.10-	MT	R	F	Hatchback Engine A17DTC/A17DTE/A17DTJ	GDS21074	Drive Shaft		30	34	52.5	94	589			
	2011.10-				Hatchback Engine A17DTC/A17DTE/A17DTJ	GC099023	Outer Joint		30	26	53.8	94.5	65.5	M		
1.7 CDTi (96 kW)	2011.10-	MT	L	F	Hatchback Engine A17DTF/A17DTS	GDS21076	Drive Shaft		30	25	52.5	94	601			
	2011.10-	MT	R	F	Hatchback Engine A17DTF/A17DTS	GDS21074	Drive Shaft		30	34	52.5	94	589			
	2011.10-				Hatchback Engine A17DTF/A17DTS	GC099023	Outer Joint		30	26	53.8	94.5	65.5	M		
2.0 CDTi (121 kW)	2011.10-	MT	L	F	Hatchback Engine A20DTH	GDS21075	Drive Shaft		30	27	52.5	94	599			
	2011.10-	MT	R	F	Hatchback Engine A20DTH	GDS21036	Drive Shaft		30	27	55.4	100	602			
	2011.10-				Hatchback Engine A20DTH	GC099023	Outer Joint		30	26	53.8	94.5	65.5	M		
<b>ASTRA H</b>																
1.3 CDTi						GCI44008	Inner Joint		25	25	35	77.5	64			
	2004-		L	F		GCI44008	Inner Joint		25	25	35	77.5	64			
1.3 CDTi/1.7 CDTi						GC044054	Outer Joint		33	35	72.8	112.5	73.5	O		
1.6	2004-		L	F		GCI44008	Inner Joint		25	25	35	77.5	64			
<b>ASTRA H (L35)</b>																
1.3 CDTi (66 kW)	2005.08-		L	F	Estate Engine Z13DTH	GDS60020	Drive Shaft		33	25	52.5	94	561			
	2005.08-		L	F	Estate Engine Z13DTH	GCI44008	Inner Joint		25	25	35	77.5	64			
	2005.08-		L/R	F	Estate Engine Z13DTH	GC044028	Outer Joint		33	24	53	93.5	63.5	M		
	2005.08-		R	F	Estate Engine Z13DTH	GDS44051	Drive Shaft		33	34	53	93.5	570			
	2005.08-		R	F	Estate Engine Z13DTH	GCI44011	Inner Joint		34	25	37.5	46	55			
1.4 (66 kW)	2004.08-	MT		F	Estate Engine Z14XEP	GC044003	Outer Joint		33	22	53	95	54.5	M		
	2004.08-	MT	L	F	Estate Engine Z14XEP	GDS44028	Drive Shaft		33	22	53	95	590			
	2004.08-	MT	R	F	Estate Engine Z14XEP	GDS44030	Drive Shaft		33	22	53	95	952			
	2004.08-	MT	L	F	Estate Engine Z14XEP	GCI21014	Inner Joint		22	22	35	57.5	75			
	2004.08-	MT	R	F	Estate Engine Z14XEP	GCI21014	Inner Joint		22	22	35	57.5	75			
1.6 (77 kW)	2004.08-	MT		F	Estate Engine Z16XEP	GC044003	Outer Joint		33	22	53	95	54.5	M		
	2004.08-	MT	L	F	Estate Engine Z16XEP	GDS44028	Drive Shaft		33	22	53	95	590			
	2004.08-	MT	R	F	Estate Engine Z16XEP	GDS44030	Drive Shaft		33	22	53	95	952			
	2004.08-	MT	L	F	Estate Engine Z16XEP	GCI21014	Inner Joint		22	22	35	57.5	75			
	2004.08-	MT	R	F	Estate Engine Z16XEP	GCI21014	Inner Joint		22	22	35	57.5	75			
1.6 (85 kW)	2006.12-		L	F	Estate Engine A16XER/Z16XER	GDS44028	Drive Shaft		33	22	53	95	590			
	2006.12-		R	F	Estate Engine A16XER/Z16XER	GDS44030	Drive Shaft		33	22	53	95	952			
	2006.12-		L	F	Estate Engine A16XER/Z16XER	GCI21014	Inner Joint		22	22	35	57.5	75			
	2006.12-		R	F	Estate Engine A16XER/Z16XER	GCI21014	Inner Joint		22	22	35	57.5	75			
1.7 CDTi (59 kW)	2004.08-	MT		F	Estate Engine Z17DTL	GC044028	Outer Joint		33	24	53	93.5	63.5	M		
	2004.08-	MT	L	F	Estate Engine Z17DTL	GDS21063	Drive Shaft		33	22	53	93.5	586			
	2004.08-	MT	R	F	Estate Engine Z17DTL	GDS21055	Drive Shaft		33	22	53	93.5	950			
1.7 CDTi (74 kW)	2006.11-2008.03	MT		F	Estate Engine Z17DTH	GC044028	Outer Joint		33	24	53	93.5	63.5	M		
	2006.11-2008.03	5MT	L	F	Estate Engine Z17DTH	GDS44029	Drive Shaft		33	34	53	93.5	594			
	2006.11-2008.03	MT	L	F	Estate Engine Z17DTH	GDS44024	Drive Shaft		33	34	53	93.5	589			
	2006.11-2008.03	MT	L	F	Estate Engine Z17DTH	GDS44052	Drive Shaft		33	25	53	93.5	573			
	2006.11-2008.03	MT	L	F	Estate Engine Z17DTH	GCI44008	Inner Joint		25	25	35	77.5	64			
	2006.11-2008.03	MT	L	F	Estate Engine Z17DTH	GC044028	Outer Joint		33	24	53	93.5	63.5	M		
2006.11-2008.03	5MT/6MT	R	F	Estate Engine Z17DTH	GDS44031	Drive Shaft		33	34	53	93.5	559				
1.7 CDTi (81 kW)	2007.02-		L	F	Estate Engine A17DTJ/Z17DTJ	GDS21051	Drive Shaft		33	25	52.5	94	579			
1.7 CDTi (92 kW)	2007.02-		L	F	Estate Engine A17DTR/Z17DTR	GDS21051	Drive Shaft		33	25	52.5	94	579			
	2007.02-				Estate Engine A17DTR/Z17DTR	GC099024	Outer Joint		33	26	52.5	94	65.5	M		
1.8 (103 kW)	2005.08-	MT/AT	L	F	Estate Engine A18XER/Z18XER	GDS21063	Drive Shaft		33	22	53	93.5	586			
	2005.08-	MT/AT	R	F	Estate Engine A18XER/Z18XER	GDS21055	Drive Shaft		33	22	53	93.5	950			
1.8 (92 kW)	2004.08-	MT/AT		F	Estate Engine Z18XE	GC044028	Outer Joint		33	24	53	93.5	63.5	M		
	2004.08-	MT/AT	L	F	Estate Engine Z18XE	GDS21063	Drive Shaft		33	22	53	93.5	586			
	2004.08-	MT/AT	R	F	Estate Engine Z18XE	GDS21055	Drive Shaft		33	22	53	93.5	950			
1.9 CDTi (110 kW)	2006.11-2008.03	MT		F	Estate Engine Z19DTH	GC017051	Outer Joint		30	26	53.8	94.5	65.5	M		
	2006.11-2008.03		L	F	Estate Engine Z19DTH	GDS21071	Drive Shaft		30	25	53.8	94.5	576			
	2006.11-2008.03		R	F	Estate Engine Z19DTH	GDS21062	Drive Shaft		30	34	53.8	94.5	595			
	2006.11-2008.03				Estate Engine Z19DTH	GC099023	Outer Joint		30	26	53.8	94.5	65.5	M		
1.9 CDTi (74 kW)	2005.09-			F	Estate Engine Z19DTL	GC044027	Outer Joint		33	26	52.5	94	65.5	M		

		TRANSM	L/R	F/R		G-AP Ref.	PRODUCT	ABS	Technical Specifications								
									YEAR	A	B	C	H	L	P		
<b>OPEL</b>																	
<b>ASTRA H (L35)</b>																	
1.9 CDTi (74 kW)	2005.09-			R	F	Estate Engine Z19DTL	GDS21056	Drive Shaft	33	34	52.5	94	595				
	2005.09-		MT	L	F	Estate Engine Z19DTL	GDS21051	Drive Shaft	33	25	52.5	94	579				
	2005.09-			L	F	Estate Engine Z19DTL	GDS21073	Drive Shaft	33	25	52.5	94	578				
	2005.09-					Estate Engine Z19DTL	GC099024	Outer Joint	33	26	52.5	94	65.5	M			
1.9 CDTi (88 kW)	2006.11-2008.03				F	Estate Engine Z19DT	GC044027	Outer Joint	33	26	52.5	94	65.5	M			
	2006.11-2008.03	MT	L	F	Estate Engine Z19DT	GDS21051	Drive Shaft	33	25	52.5	94	579					
	2006.11-2008.03		L	F	Estate Engine Z19DT	GDS21073	Drive Shaft	33	25	52.5	94	578					
	2006.11-2008.03			R	F	Estate Engine Z19DT	GDS21056	Drive Shaft	33	34	52.5	94	595				
	2006.11-2008.03					Estate Engine Z19DT	GC099024	Outer Joint	33	26	52.5	94	65.5	M			
1.9 CDTi 16V (88 kW)	2004.08-		MT		F	Estate Engine Z19DTJ	GC044027	Outer Joint	33	26	52.5	94	65.5	M			
	2004.08-			R	F	Estate Engine Z19DTJ	GDS21056	Drive Shaft	33	34	52.5	94	595				
	2004.08-		MT	L	F	Estate Engine Z19DTJ	GDS21051	Drive Shaft	33	25	52.5	94	579				
	2004.08-			L	F	Estate Engine Z19DTJ	GDS21073	Drive Shaft	33	25	52.5	94	578				
	2004.08-					Estate Engine Z19DTJ	GC099024	Outer Joint	33	26	52.5	94	65.5	M			
2.0 Turbo (125 kW)	2004.08-				F	Estate Engine Z20LEL	GC044027	Outer Joint	33	26	52.5	94	65.5	M			
	2004.08-			R	F	Estate Engine Z20LEL	GDS21056	Drive Shaft	33	34	52.5	94	595				
	2004.08-					Estate Engine Z20LEL	GC099024	Outer Joint	33	26	52.5	94	65.5	M			
2.0 Turbo (147 kW)	2004.09-				F	Estate Engine Z20LER	GC044027	Outer Joint	33	26	52.5	94	65.5	M			
	2004.09-			R	F	Estate Engine Z20LER	GDS21056	Drive Shaft	33	34	52.5	94	595				
	2004.09-					Estate Engine Z20LER	GC099024	Outer Joint	33	26	52.5	94	65.5	M			
<b>ASTRA H (L48)</b>																	
1.3 CDTi (66 kW)	2005.08-			L	F	Hatchback Engine Z13DTH	GDS60020	Drive Shaft	33	25	52.5	94	561				
	2005.08-			L	F	Hatchback Engine Z13DTH	GCI44008	Inner Joint	25	25	35	77.5	64				
	2005.08-			L/R	F	Hatchback Engine Z13DTH	GC044028	Outer Joint	33	24	53	93.5	63.5	M			
	2005.08-			R	F	Hatchback Engine Z13DTH	GDS44051	Drive Shaft	33	34	53	93.5	570				
	2005.08-			R	F	Hatchback Engine Z13DTH	GCI44011	Inner Joint	34	25	37.5	46	55				
1.4 (66 kW)	2004.03-		MT		F	Hatchback Engine Z14XEP	GC044003	Outer Joint	33	22	53	95	54.5	M			
	2004.03-		MT	L	F	Hatchback Engine Z14XEP	GDS44028	Drive Shaft	33	22	53	95	590				
	2004.03-		MT	R	F	Hatchback Engine Z14XEP	GDS44030	Drive Shaft	33	22	53	95	952				
	2004.03-		MT	L	F	Hatchback Engine Z14XEP	GCI21014	Inner Joint	22	22	35	57.5	75				
	2004.03-		MT	R	F	Hatchback Engine Z14XEP	GCI21014	Inner Joint	22	22	35	57.5	75				
1.6 (77 kW)	2004.03-		MT		F	Hatchback Engine Z16XEP	GC044003	Outer Joint	33	22	53	95	54.5	M			
	2004.03-		MT	L	F	Hatchback Engine Z16XEP	GDS44028	Drive Shaft	33	22	53	95	590				
	2004.03-		MT	R	F	Hatchback Engine Z16XEP	GDS44030	Drive Shaft	33	22	53	95	952				
	2004.03-		MT	L	F	Hatchback Engine Z16XEP	GCI21014	Inner Joint	22	22	35	57.5	75				
	2004.03-		MT	R	F	Hatchback Engine Z16XEP	GCI21014	Inner Joint	22	22	35	57.5	75				
1.6 (85 kW)	2006.12-			L	F	Hatchback Engine A16XER/Z16XER	GDS44028	Drive Shaft	33	22	53	95	590				
	2006.12-			R	F	Hatchback Engine A16XER/Z16XER	GDS44030	Drive Shaft	33	22	53	95	952				
	2006.12-			L	F	Hatchback Engine A16XER/Z16XER	GCI21014	Inner Joint	22	22	35	57.5	75				
	2006.12-			R	F	Hatchback Engine A16XER/Z16XER	GCI21014	Inner Joint	22	22	35	57.5	75				
1.7 CDTi (59 kW)	2004.03-		MT		F	Hatchback Engine Z17DTL	GC044028	Outer Joint	33	24	53	93.5	63.5	M			
	2004.03-		MT	L	F	Hatchback Engine Z17DTL	GDS21063	Drive Shaft	33	22	53	93.5	586				
	2004.03-		MT	R	F	Hatchback Engine Z17DTL	GDS21055	Drive Shaft	33	22	53	93.5	950				
1.7 CDTi (74 kW)	2005.01-2008.03	MT		F	Hatchback Engine Z17DTH	GC044028	Outer Joint	33	24	53	93.5	63.5	M				
	2005.01-2008.03	5MT	L	F	Hatchback Engine Z17DTH	GDS44029	Drive Shaft	33	34	53	93.5	594					
	2005.01-2008.03	MT	L	F	Hatchback Engine Z17DTH	GDS44024	Drive Shaft	33	34	53	93.5	589					
	2005.01-2008.03	MT	L	F	Hatchback Engine Z17DTH	GDS44052	Drive Shaft	33	25	53	93.5	573					
	2005.01-2008.03	MT	L	F	Hatchback Engine Z17DTH	GCI44008	Inner Joint	25	25	35	77.5	64					
	2005.01-2008.03	MT	L	F	Hatchback Engine Z17DTH	GC044028	Outer Joint	33	24	53	93.5	63.5	M				
1.7 CDTi (81 kW)	2007.02-			L	F	Hatchback Engine A17DTJ/Z17DTJ	GDS21051	Drive Shaft	33	25	52.5	94	579				
	2007.02-			L	F	Hatchback Engine A17DTR/Z17DTR	GDS21051	Drive Shaft	33	25	52.5	94	579				
1.7 CDTi (92 kW)	2007.02-					Hatchback Engine A17DTR/Z17DTR	GC099024	Outer Joint	33	26	52.5	94	65.5	M			
	2007.02-					Hatchback Engine A17DTR/Z17DTR	GC099024	Outer Joint	33	26	52.5	94	65.5	M			
1.8 (103 kW)	2006.06-2008.03	MT/AT	L	F	Hatchback Engine A18XER/Z18XER	GDS21063	Drive Shaft	33	22	53	93.5	586					
	2006.06-2008.03	MT/AT	R	F	Hatchback Engine A18XER/Z18XER	GDS21055	Drive Shaft	33	22	53	93.5	950					
1.8 (92 kW)	2004.03-		MT/AT		F	Hatchback Engine Z18XE	GC044028	Outer Joint	33	24	53	93.5	63.5	M			
	2004.03-		MT/AT	L	F	Hatchback Engine Z18XE	GDS21063	Drive Shaft	33	22	53	93.5	586				
	2004.03-		MT/AT	R	F	Hatchback Engine Z18XE	GDS21055	Drive Shaft	33	22	53	93.5	950				
1.9 CDTi (110 kW)	2005.01-2008.03	MT		F	Hatchback Engine Z19DTH	GC017051	Outer Joint	30	26	53.8	94.5	65.5	M				
	2005.01-2008.03		L	F	Hatchback Engine Z19DTH	GDS21071	Drive Shaft	30	25	53.8	94.5	576					
	2005.01-2008.03		R	F	Hatchback Engine Z19DTH	GDS21062	Drive Shaft	30	34	53.8	94.5	595					









		TRANSM	L/R	F/R		G-AP Ref.	PRODUCT	ABS	Technical Specifications						
									YEAR	A	B	C	H	L	P
<b>OPEL</b>															
<b>ASTRA H (L48)</b>															
1.9 CDTi (110 kW)	2005.01-	2008.03				Hatchback Engine Z19DTH	GC099023	Outer Joint	30	26	53.8	94.5	65.5	M	
1.9 CDTi (74 kW)	2005.09-				F	Hatchback Engine Z19DTL	GC044027	Outer Joint	33	26	52.5	94	65.5	M	
	2005.09-			R	F	Hatchback Engine Z19DTL	GDS21056	Drive Shaft	33	34	52.5	94	595		
	2005.09-		MT	L	F	Hatchback Engine Z19DTL	GDS21051	Drive Shaft	33	25	52.5	94	579		
	2005.09-			L	F	Hatchback Engine Z19DTL	GDS21073	Drive Shaft	33	25	52.5	94	578		
	2005.09-					Hatchback Engine Z19DTL	GC099024	Outer Joint	33	26	52.5	94	65.5	M	
1.9 CDTi (88 kW)	2006.01-	2008.03			F	Hatchback Engine Z19DT	GC044027	Outer Joint	33	26	52.5	94	65.5	M	
	2006.01-	2008.03	MT	L	F	Hatchback Engine Z19DT	GDS21051	Drive Shaft	33	25	52.5	94	579		
	2006.01-	2008.03		L	F	Hatchback Engine Z19DT	GDS21073	Drive Shaft	33	25	52.5	94	578		
	2006.01-	2008.03		R	F	Hatchback Engine Z19DT	GDS21056	Drive Shaft	33	34	52.5	94	595		
	2006.01-	2008.03				Hatchback Engine Z19DT	GC099024	Outer Joint	33	26	52.5	94	65.5	M	
1.9 CDTi 16V (88 kW)	2004.06-	2007.01	MT		F	Hatchback Engine Z19DTJ	GC017051	Outer Joint	30	26	53.8	94.5	65.5	M	
	2004.06-	2007.01	MT		F	Hatchback Engine Z19DTJ	GC044027	Outer Joint	33	26	52.5	94	65.5	M	
	2004.06-	2007.01	MT	L	F	Hatchback Engine Z19DTJ	GDS21051	Drive Shaft	33	25	52.5	94	579		
	2004.06-	2007.01		L	F	Hatchback Engine Z19DTJ	GDS21073	Drive Shaft	33	25	52.5	94	578		
	2004.06-	2007.01		R	F	Hatchback Engine Z19DTJ	GDS21056	Drive Shaft	33	34	52.5	94	595		
	2004.06-	2007.01				Hatchback Engine Z19DTJ	GC099024	Outer Joint	33	26	52.5	94	65.5	M	
2.0 Turbo (125 kW)	2004.03-				F	Hatchback Engine Z20LEL	GC044027	Outer Joint	33	26	52.5	94	65.5	M	
	2004.03-			R	F	Hatchback Engine Z20LEL	GDS21056	Drive Shaft	33	34	52.5	94	595		
	2004.03-					Hatchback Engine Z20LEL	GC099024	Outer Joint	33	26	52.5	94	65.5	M	
2.0 Turbo (147 kW)	2006.11-	2008.03			F	Hatchback Engine Z20LER	GC044027	Outer Joint	33	26	52.5	94	65.5	M	
	2006.11-	2008.03		R	F	Hatchback Engine Z20LER	GDS21056	Drive Shaft	33	34	52.5	94	595		
	2006.11-	2008.03				Hatchback Engine Z20LER	GC099024	Outer Joint	33	26	52.5	94	65.5	M	
2.0 Turbo (177 kW)	2005.04-	2008.03			F	Hatchback Engine Z20LEH	GC044027	Outer Joint	33	26	52.5	94	65.5	M	
	2005.04-	2008.03	MT	L	F	Hatchback Engine Z20LEH	GDS21035	Drive Shaft	30	25	53.8	94.5	581		
	2005.04-	2008.03		R	F	Hatchback Engine Z20LEH	GDS21062	Drive Shaft	30	34	53.8	94.5	595		
	2005.04-	2008.03				Hatchback Engine Z20LEH	GC099023	Outer Joint	30	26	53.8	94.5	65.5	M	
<b>ASTRA H (L69)</b>															
1.7 CDTi (81 kW)	2007.02-		MT	L	F	Saloon Engine Z17DTJ	GDS44024	Drive Shaft	33	34	53	93.5	589		
	2007.02-			L	F	Saloon Engine Z17DTJ	GDS21051	Drive Shaft	33	25	52.5	94	579		
1.7 CDTi (92 kW)	2010.07-					Saloon Engine A17DTR/Z17DTR	GC099024	Outer Joint	33	26	52.5	94	65.5	M	
<b>ASTRA H CABRIO</b>															
1.6 (85 kW)	2006-						GC044003	Outer Joint	33	22	53	95	54.5	M	
1.6 (85 kW)	2006-						GCI21014	Inner Joint	22	22	35	57.5	75		
1.6 16V (77 kW)	2005-						GC044003	Outer Joint	33	22	53	95	54.5	M	
1.6 16V (77 kW)	2005-						GCI21014	Inner Joint	22	22	35	57.5	75		
1.6 T (132 kW)	2006-						GC044028	Outer Joint	33	24	53	93.5	63.5	M	
1.8 16V (103 kW)	2005-						GC044028	Outer Joint	33	24	53	93.5	63.5	M	
1.8 16V (92 kW)	2005-						GC044028	Outer Joint	33	24	53	93.5	63.5	M	
2.0 T (125 kW)	2005.09-						GC044027	Outer Joint	33	26	52.5	94	65.5	M	
2.0 T 16V (147 kW)	2005.09-						GC044027	Outer Joint	33	26	52.5	94	65.5	M	
<b>ASTRA H SPORP HATCH (L08)</b>															
1.3 CDTi (66 kW)	2005.04-			L	F	Hatchback Engine Z13DTH	GDS60020	Drive Shaft	33	25	52.5	94	561		
	2005.04-			L	F	Hatchback Engine Z13DTH	GCI44008	Inner Joint	25	25	35	77.5	64		
	2005.04-			L/R	F	Hatchback Engine Z13DTH	GC044028	Outer Joint	33	24	53	93.5	63.5	M	
	2005.04-			R	F	Hatchback Engine Z13DTH	GDS44051	Drive Shaft	33	34	53	93.5	570		
	2005.04-			R	F	Hatchback Engine Z13DTH	GCI44011	Inner Joint	34	25	37.5	46	55		
1.4 (66 kW)	2005.03-		MT		F	Hatchback Engine Z14XEP	GC044003	Outer Joint	33	22	53	95	54.5	M	
	2005.03-		MT	L	F	Hatchback Engine Z14XEP	GDS44028	Drive Shaft	33	22	53	95	590		
	2005.03-		MT	R	F	Hatchback Engine Z14XEP	GDS44030	Drive Shaft	33	22	53	95	952		
	2005.03-		MT	L	F	Hatchback Engine Z14XEP	GCI21014	Inner Joint	22	22	35	57.5	75		
	2005.03-		MT	R	F	Hatchback Engine Z14XEP	GCI21014	Inner Joint	22	22	35	57.5	75		
1.6 (77 kW)	2005.03-		MT		F	Hatchback Engine Z16XEP	GC044003	Outer Joint	33	22	53	95	54.5	M	
	2005.03-		MT	L	F	Hatchback Engine Z16XEP	GDS44028	Drive Shaft	33	22	53	95	590		
	2005.03-		MT	R	F	Hatchback Engine Z16XEP	GDS44030	Drive Shaft	33	22	53	95	952		
	2005.03-		MT	L	F	Hatchback Engine Z16XEP	GCI21014	Inner Joint	22	22	35	57.5	75		
	2005.03-		MT	R	F	Hatchback Engine Z16XEP	GCI21014	Inner Joint	22	22	35	57.5	75		
1.6 (85 kW)	2006.12-			L	F	Hatchback Engine Z16XER	GDS44028	Drive Shaft	33	22	53	95	590		
	2006.12-			R	F	Hatchback Engine Z16XER	GDS44030	Drive Shaft	33	22	53	95	952		
	2006.12-			L	F	Hatchback Engine Z16XER	GCI21014	Inner Joint	22	22	35	57.5	75		
	2006.12-			R	F	Hatchback Engine Z16XER	GCI21014	Inner Joint	22	22	35	57.5	75		
1.7 CDTi (59 kW)	2005.03-		MT	L	F	Hatchback Engine Z17DTL	GDS21063	Drive Shaft	33	22	53	93.5	586		
	2005.03-		MT	R	F	Hatchback Engine Z17DTL	GDS21055	Drive Shaft	33	22	53	93.5	950		



		YEAR	TRANSM	L/R	F/R		G-AP Ref.	PRODUCT	ABS	Technical Specifications						
										A	B	C	H	L	P	
<b>OPEL</b>																
<b>ASTRA H SPORP HATCH (L08)</b>																
1.7 CDTi (74 kW)	2007.04-	2008.03	MT		F	Hatchback Engine Z17DTH	GC044028	Outer Joint		33	24	53	93.5	63.5	M	
	2007.04-	2008.03	5MT	L	F	Hatchback Engine Z17DTH	GDS44029	Drive Shaft		33	34	53	93.5	594		
	2007.04-	2008.03	MT	L	F	Hatchback Engine Z17DTH	GDS44024	Drive Shaft		33	34	53	93.5	589		
	2007.04-	2008.03	MT	L	F	Hatchback Engine Z17DTH	GDS44052	Drive Shaft		33	25	53	93.5	573		
	2007.04-	2008.03	MT	L	F	Hatchback Engine Z17DTH	GCI44008	Inner Joint		25	25	35	77.5	64		
	2007.04-	2008.03	MT	L	F	Hatchback Engine Z17DTH	GC044028	Outer Joint		33	24	53	93.5	63.5	M	
	2007.04-	2008.03	5MT/6MT	R	F	Hatchback Engine Z17DTH	GDS44031	Drive Shaft		33	34	53	93.5	559		
1.7 CDTi (81 kW)	2007.02-				L	F	Hatchback Engine A17DTJ	GDS21051	Drive Shaft		33	25	52.5	94	579	
1.7 CDTi (92 kW)	2007.02-				L	F	Hatchback Engine A17DTR	GDS21051	Drive Shaft		33	25	52.5	94	579	
	2007.02-						Hatchback Engine A17DTR	GC099024	Outer Joint		33	26	52.5	94	65.5	M
1.8 (103 kW)	2006.01-		MT/AT	L	F	Hatchback Engine Z18XER	GDS21063	Drive Shaft		33	22	53	93.5	586		
	2006.01-		MT/AT	R	F	Hatchback Engine Z18XER	GDS21055	Drive Shaft		33	22	53	93.5	950		
1.8 (92 kW)	2005.03-		MT/AT		F	Hatchback Engine Z18XE	GC044028	Outer Joint		33	24	53	93.5	63.5	M	
	2005.03-		MT/AT	L	F	Hatchback Engine Z18XE	GDS21063	Drive Shaft		33	22	53	93.5	586		
	2005.03-		MT	R	F	Hatchback Engine Z18XE	GDS21055	Drive Shaft		33	22	53	93.5	950		
1.9 CDTi (110 kW)	2006.11-	2008.03	MT		F	Hatchback Engine Z19DTH	GC017051	Outer Joint		30	26	53.8	94.5	65.5	M	
	2006.11-	2008.03		L	F	Hatchback Engine Z19DTH	GDS21071	Drive Shaft		30	25	53.8	94.5	576		
	2006.11-	2008.03			R	F	Hatchback Engine Z19DTH	GDS21062	Drive Shaft		30	34	53.8	94.5	595	
	2006.11-	2008.03				Hatchback Engine Z19DTH	GC099023	Outer Joint		30	26	53.8	94.5	65.5	M	
1.9 CDTi (74 kW)	2006.01-				F	Hatchback Engine Z19DTL	GC044027	Outer Joint		33	26	52.5	94	65.5	M	
	2006.01-				R	F	Hatchback Engine Z19DTL	GDS21056	Drive Shaft		33	34	52.5	94	595	
	2006.01-		MT	L	F	Hatchback Engine Z19DTL	GDS21051	Drive Shaft		33	25	52.5	94	579		
	2006.01-			L	F	Hatchback Engine Z19DTL	GDS21073	Drive Shaft		33	25	52.5	94	578		
	2006.01-					Hatchback Engine Z19DTL	GC099024	Outer Joint		33	26	52.5	94	65.5	M	
1.9 CDTi (88 kW)	2005.09-				F	Hatchback Engine Z19DT	GC044027	Outer Joint		33	26	52.5	94	65.5	M	
	2005.09-				R	F	Hatchback Engine Z19DT	GDS21056	Drive Shaft		33	34	52.5	94	595	
	2005.09-		MT	L	F	Hatchback Engine Z19DT	GDS21051	Drive Shaft		33	25	52.5	94	579		
	2005.09-			L	F	Hatchback Engine Z19DT	GDS21073	Drive Shaft		33	25	52.5	94	578		
	2005.09-					Hatchback Engine Z19DT	GC099024	Outer Joint		33	26	52.5	94	65.5	M	
1.9 CDTi 16V (88 kW)	2005.03-				F	Hatchback Engine Z19DTJ	GC044027	Outer Joint		33	26	52.5	94	65.5	M	
	2005.03-				R	F	Hatchback Engine Z19DTJ	GDS21056	Drive Shaft		33	34	52.5	94	595	
	2005.03-		MT	L	F	Hatchback Engine Z19DTJ	GDS21051	Drive Shaft		33	25	52.5	94	579		
	2005.03-			L	F	Hatchback Engine Z19DTJ	GDS21073	Drive Shaft		33	25	52.5	94	578		
	2005.03-					Hatchback Engine Z19DTJ	GC099024	Outer Joint		33	26	52.5	94	65.5	M	
2.0 Turbo (125 kW)	2005.03-				F	Hatchback Engine Z20LEL	GC044027	Outer Joint		33	26	52.5	94	65.5	M	
	2005.03-				R	F	Hatchback Engine Z20LEL	GDS21056	Drive Shaft		33	34	52.5	94	595	
	2005.03-					Hatchback Engine Z20LEL	GC099024	Outer Joint		33	26	52.5	94	65.5	M	
2.0 Turbo (147 kW)	2005.03-				F	Hatchback Engine Z20LER	GC044027	Outer Joint		33	26	52.5	94	65.5	M	
	2005.03-				R	F	Hatchback Engine Z20LER	GDS21056	Drive Shaft		33	34	52.5	94	595	
	2005.03-					Hatchback Engine Z20LER	GC099024	Outer Joint		33	26	52.5	94	65.5	M	
2.0 Turbo (177 kW)	2005.08-				F	Hatchback Engine Z20LEH	GC044027	Outer Joint		33	26	52.5	94	65.5	M	
	2005.08-				R	F	Hatchback Engine Z20LEH	GDS21062	Drive Shaft		30	34	53.8	94.5	595	
	2005.08-		MT	L	F	Hatchback Engine Z20LEH	GDS21035	Drive Shaft		30	25	53.8	94.5	581		
	2005.08-					Hatchback Engine Z20LEH	GC099023	Outer Joint		30	26	53.8	94.5	65.5	M	
<b>ASTRA H TWINTOP (L67)</b>																
1.6 (77 kW)	2005.09-		MT		F	Convertible Engine Z16XE1/Z16XEP	GC044003	Outer Joint		33	22	53	95	54.5	M	
	2005.09-		MT	L	F	Convertible Engine Z16XE1/Z16XEP	GDS44028	Drive Shaft		33	22	53	95	590		
	2005.09-		MT	R	F	Convertible Engine Z16XE1/Z16XEP	GDS44030	Drive Shaft		33	22	53	95	952		
	2005.09-		MT	L	F	Convertible Engine Z16XE1/Z16XEP	GCI21014	Inner Joint		22	22	35	57.5	75		
	2005.09-		MT	R	F	Convertible Engine Z16XE1/Z16XEP	GCI21014	Inner Joint		22	22	35	57.5	75		
1.6 (85 kW)	2006.12-			L	F	Convertible Engine Z16XER	GDS44028	Drive Shaft		33	22	53	95	590		
	2006.12-			R	F	Convertible Engine Z16XER	GDS44030	Drive Shaft		33	22	53	95	952		
	2006.12-			L	F	Convertible Engine Z16XER	GCI21014	Inner Joint		22	22	35	57.5	75		
	2006.12-			R	F	Convertible Engine Z16XER	GCI21014	Inner Joint		22	22	35	57.5	75		
1.8 (103 kW)	2006.05-	2008.03	MT/AT	L	F	Convertible Engine A18XER/Z18XER	GDS21063	Drive Shaft		33	22	53	93.5	586		
	2006.05-	2008.03	MT/AT	R	F	Convertible Engine A18XER/Z18XER	GDS21055	Drive Shaft		33	22	53	93.5	950		
1.8 (92 kW)	2005.09-		MT/AT		F	Convertible Engine Z18XE	GC044028	Outer Joint		33	24	53	93.5	63.5	M	
	2005.09-		MT	L	F	Convertible Engine Z18XE	GDS21063	Drive Shaft		33	22	53	93.5	586		
	2005.09-		MT/AT	R	F	Convertible Engine Z18XE	GDS21055	Drive Shaft		33	22	53	93.5	950		
1.9 CDTi (110 kW)	2007.04-	2008.03	MT		F	Convertible Engine Z19DTH	GC017051	Outer Joint		30	26	53.8	94.5	65.5	M	
	2007.04-	2008.03		L	F	Convertible Engine Z19DTH	GDS21071	Drive Shaft		30	25	53.8	94.5	576		

		TRANSM	L/R	F/R		G-AP Ref.	PRODUCT	ABS	Technical Specifications							
									YEAR	A	B	C	H	L	P	
<b>OPEL</b>																
<b>ASTRA H TWINTOP (L67)</b>																
1.9 CDTi (110 kW)	2007.04-	2008.03				Convertible Engine Z19DTH	GDS21062	Drive Shaft	30	34	53.8	94.5	595			
	2007.04-	2008.03				Convertible Engine Z19DTH	GC099023	Outer Joint	30	26	53.8	94.5	65.5	M		
2.0 Turbo (125 kW)	2005.09-					Convertible Engine Z20LEL	GC044027	Outer Joint	33	26	52.5	94	65.5	M		
	2005.09-			R	F	Convertible Engine Z20LEL	GDS21056	Drive Shaft	33	34	52.5	94	595			
	2005.09-					Convertible Engine Z20LEL	GC099024	Outer Joint	33	26	52.5	94	65.5	M		
2.0 Turbo (147 kW)	2007.04-	2008.03				Convertible Engine Z20LER	GC044027	Outer Joint	33	26	52.5	94	65.5	M		
	2007.04-	2008.03		R	F	Convertible Engine Z20LER	GDS21056	Drive Shaft	33	34	52.5	94	595			
	2007.04-	2008.03				Convertible Engine Z20LER	GC099024	Outer Joint	33	26	52.5	94	65.5	M		
<b>ASTRA H VAN (L70)</b>																
1.3 CDTi (66 kW)	2005.08-			L	F	Box Engine Z13DTH	GDS60020	Drive Shaft	33	25	52.5	94	561			
	2005.08-			L	F	Box Engine Z13DTH	GCI44008	Inner Joint	25	25	35	77.5	64			
	2005.08-			L/R	F	Box Engine Z13DTH	GC044028	Outer Joint	33	24	53	93.5	63.5	M		
	2005.08-			R	F	Box Engine Z13DTH	GDS44051	Drive Shaft	33	34	53	93.5	570			
	2005.08-			R	F	Box Engine Z13DTH	GCI44011	Inner Joint	34	25	37.5	46	55			
1.7 CDTi (74 kW)	2004.03-		5MT	L	F	Box Engine Z17DTH	GDS44029	Drive Shaft	33	34	53	93.5	594			
	2004.03-			R	F	Box Engine Z17DTH	GDS44031	Drive Shaft	33	34	53	93.5	559			
	2004.03-		MT	L	F	Box Engine Z17DTH	GDS44024	Drive Shaft	33	34	53	93.5	589			
	2004.03-		MT	L	F	Box Engine Z17DTH	GDS44052	Drive Shaft	33	25	53	93.5	573			
	2004.03-		MT	L	F	Box Engine Z17DTH	GCI44008	Inner Joint	25	25	35	77.5	64			
	2004.03-		MT	L	F	Box Engine Z17DTH	GC044028	Outer Joint	33	24	53	93.5	63.5	M		
	2004.03-		MT	L	F	Box Engine Z17DTH	GC044028	Outer Joint	33	24	53	93.5	63.5	M		
1.7 CDTi (81 kW)	2007.02-			L	F	Box Engine A17DTJ/Z17DTJ	GDS21051	Drive Shaft	33	25	52.5	94	579			
1.7 CDTi (92 kW)	2007.02-			L	F	Box Engine A17DTJ/Z17DTJ	GDS21051	Drive Shaft	33	25	52.5	94	579			
	2007.02-					Box Engine A17DTJ/Z17DTJ	GC099024	Outer Joint	33	26	52.5	94	65.5	M		
1.9 CDTi (110 kW)	2004.09-			L	F	Box Engine Z19DTH	GDS21071	Drive Shaft	30	25	53.8	94.5	576			
	2004.09-			R	F	Box Engine Z19DTH	GDS21062	Drive Shaft	30	34	53.8	94.5	595			
	2004.09-					Box Engine Z19DTH	GC099023	Outer Joint	30	26	53.8	94.5	65.5	M		
1.9 CDTi (88 kW)	2005.09-		MT	L	F	Box Engine Z19DT	GDS21051	Drive Shaft	33	25	52.5	94	579			
	2005.09-					Box Engine Z19DT	GC099024	Outer Joint	33	26	52.5	94	65.5	M		
1.9 CDTi 16V (88 kW)	2004.08-			R	F	Box Engine Z19DTJ	GDS21056	Drive Shaft	33	34	52.5	94	595			
	2004.08-		MT	L	F	Box Engine Z19DTJ	GDS21051	Drive Shaft	33	25	52.5	94	579			
	2004.08-			L	F	Box Engine Z19DTJ	GDS21073	Drive Shaft	33	25	52.5	94	578			
	2004.08-					Box Engine Z19DTJ	GC099024	Outer Joint	33	26	52.5	94	65.5	M		
<b>ASTRA H, GTC, SW</b>																
1.2 (59 kW)	2006.10-						GCI21014	Inner Joint	22	22	35	57.5	75			
	2006.10-						GC044003	Outer Joint	33	22	53	95	54.5	M		
1.3 CDTi 16V (66 kW)	2005.04-			L			GCI21011	Inner Joint	34	25	35	78	64			
	2005.04-						GC044028	Outer Joint	33	24	53	93.5	63.5	M		
1.4 (55 kW)	2004-						GCI21014	Inner Joint	22	22	35	57.5	75			
	2004-						GC044003	Outer Joint	33	22	53	95	54.5	M		
1.4 16V (66 kW)	2005.03-						GCI21014	Inner Joint	22	22	35	57.5	75			
	2005.03-						GC044003	Outer Joint	33	22	53	95	54.5	M		
1.6 16V (77 kW)	2005.03-						GCI21014	Inner Joint	22	22	35	57.5	75			
	2005.03-						GC044003	Outer Joint	33	22	53	95	54.5	M		
1.6 16V (85 kW)	2005.03-						GCI21014	Inner Joint	22	22	35	57.5	75			
	2005.03-						GC044003	Outer Joint	33	22	53	95	54.5	M		
1.6 Turbo 16V (132 kW)	2007.02-						GCI99026	Inner Joint	22	25	35	57	82.5			
	2007.02-						GC044028	Outer Joint	33	24	53	93.5	63.5	M		
1.7 CDTi (59 kW)	2005.03-						GC044028	Outer Joint	33	24	53	93.5	63.5	M		
1.7 CDTi (74 kW)	2005.03-			L			GCI21011	Inner Joint	34	25	35	78	64			
	2005.03-						GC044028	Outer Joint	33	24	53	93.5	63.5	M		
1.7 CDTi (81 kW)	2007.02-						GC044027	Outer Joint	33	26	52.5	94	65.5	M		
1.7 CDTi (92 kW)	2007.02-						GC044027	Outer Joint	33	26	52.5	94	65.5	M		
1.8 16V (103 kW)	2005.03-						GCI99026	Inner Joint	22	25	35	57	82.5			
	2005.03-						GC044028	Outer Joint	33	24	53	93.5	63.5	M		
	2007-						GCI21014	Inner Joint	22	22	35	57.5	75			
	2007-						GC044003	Outer Joint	33	22	53	95	54.5	M		
1.8 16V (92 kW)	2005.03-						GCI99026	Inner Joint	22	25	35	57	82.5			
	2005.03-						GC044028	Outer Joint	33	24	53	93.5	63.5	M		









	 YEAR	TRANSM	L/R	F/R		G-AP Ref.	PRODUCT	ABS	Technical Specifications									
									A	B	C	H	L	P				
<b>OPEL</b>																		
<b>ASTRA H, GTC, SW</b>																		
1.9 CDTi (103 kW)	2006.01-					GC044027	Outer Joint		33	26	52.5	94	65.5	M				
1.9 CDTi (74 kW)	2005.03-					GC044003	Outer Joint		33	22	53	95	54.5	M				
	2006.01-					GC044027	Outer Joint		33	26	52.5	94	65.5	M				
1.9 CDTi (88 kW)	2006.01-					GC044027	Outer Joint		33	26	52.5	94	65.5	M				
2.0 Turbo (125 kW)	2005.03-					GC044027	Outer Joint		33	26	52.5	94	65.5	M				
2.0 Turbo (147 kW)	2005.03-					GC044027	Outer Joint		33	26	52.5	94	65.5	M				
<b>ASTRA J</b>																		
-	2010-					GCI88054	Inner Joint		34	23	37.5		121.5					
1.3 CDTi (70 kW)	2009.12-		AT		Hatchback Engine A13DTE	GC088047	Outer Joint		33	23	52.5	94	59.5	M				
	2012.06-		AT		Saloon Engine A13DTE	GC088047	Outer Joint		33	23	52.5	94	59.5	M				
1.4 (64 kW)	2009.12-		MT	L	F	Hatchback Engine A14XEL	GDS44064	Drive Shaft	33	22	53	95	618					
	2009.12-		MT	L	F	Hatchback Engine A14XEL	GCI21014	Inner Joint	22	22	35	57.5	75					
	2009.12-		MT	R	F	Hatchback Engine A14XEL	GDS44065	Drive Shaft	33	22	53	95	983					
	2009.12-		MT	R	F	Hatchback Engine A14XEL	GCI21014	Inner Joint	22	22	35	57.5	75					
	2009.12-		MT			Hatchback Engine A14XEL	GC044088	Outer Joint	33	23	52.3	94	59.5	M				
1.4 (74 kW)	2009.12-		MT	L	F	Hatchback Engine A14XER	GDS44064	Drive Shaft	33	22	53	95	618					
	2009.12-		MT	L	F	Hatchback Engine A14XER	GCI21014	Inner Joint	22	22	35	57.5	75					
	2009.12-		MT	R	F	Hatchback Engine A14XER	GDS44065	Drive Shaft	33	22	53	95	983					
	2009.12-		MT	R	F	Hatchback Engine A14XER	GCI21014	Inner Joint	22	22	35	57.5	75					
	2009.12-		MT			Hatchback Engine A14XER	GC044088	Outer Joint	33	23	52.3	94	59.5	M				
	2012.06-		MT	L	F	Saloon Engine A14XER	GDS44064	Drive Shaft	33	22	53	95	618					
	2012.06-		MT	L	F	Saloon Engine A14XER	GCI21014	Inner Joint	22	22	35	57.5	75					
	2012.06-		MT	R	F	Saloon Engine A14XER	GDS44065	Drive Shaft	33	22	53	95	983					
	2012.06-		MT	R	F	Saloon Engine A14XER	GCI21014	Inner Joint	22	22	35	57.5	75					
	2012.06-					Saloon Engine A14XER	GC044088	Outer Joint	33	23	52.3	94	59.5	M				
1.4 LPG (103 kW)	2012.01-		AT		Hatchback Engine A14NET	GC088047	Outer Joint		33	23	52.5	94	59.5	M				
	2014.07-		AT		Saloon Engine A14NET	GC088047	Outer Joint		33	23	52.5	94	59.5	M				
1.4 Turbo (103 kW)	2009.12-		AT		Hatchback Engine A14NET	GC088047	Outer Joint		33	23	52.5	94	59.5	M				
	2012.06-		AT		Saloon Engine A14NET	GC088047	Outer Joint		33	23	52.5	94	59.5	M				
1.6 (85 kW)	2009.12-		MT	L	F	Hatchback Engine A16XER	GCI21014	Inner Joint	22	22	35	57.5	75					
	2009.12-		AT	R	F	Hatchback Engine A16XER	GDS21072	Drive Shaft	33	22	52.3	94	957					
	2009.12-		MT	R	F	Hatchback Engine A16XER	GDS44065	Drive Shaft	33	22	53	95	983					
	2009.12-		MT	R	F	Hatchback Engine A16XER	GCI21014	Inner Joint	22	22	35	57.5	75					
	2009.12-		AT			Hatchback Engine A16XER	GC088047	Outer Joint	33	23	52.5	94	59.5	M				
	2009.12-		MT			Hatchback Engine A16XER	GC044088	Outer Joint	33	23	52.3	94	59.5	M				
	2009.12-		MT	L	F	Hatchback Engine A16XER	GDS44064	Drive Shaft	33	22	53	95	618					
	2012.06-		MT	L	F	Saloon Engine A16XER	GDS44064	Drive Shaft	33	22	53	95	618					
	2012.06-		MT	L	F	Saloon Engine A16XER	GCI21014	Inner Joint	22	22	35	57.5	75					
	2012.06-		AT	R	F	Saloon Engine A16XER	GDS21072	Drive Shaft	33	22	52.3	94	957					
	2012.06-		MT	R	F	Saloon Engine A16XER	GDS44065	Drive Shaft	33	22	53	95	983					
	2012.06-		MT	R	F	Saloon Engine A16XER	GCI21014	Inner Joint	22	22	35	57.5	75					
	2012.06-		AT			Saloon Engine A16XER	GC088047	Outer Joint	33	23	52.5	94	59.5	M				
	2012.06-		MT			Saloon Engine A16XER	GC044088	Outer Joint	33	23	52.3	94	59.5	M				
1.7 CDTi (74 kW)	2010.10-		MT	L	F	Hatchback Engine A17DTL	GDS21076	Drive Shaft	30	25	52.5	94	601					
	2010.10-		MT	R	F	Hatchback Engine A17DTL	GDS21074	Drive Shaft	30	34	52.5	94	589					
	2010.10-				Hatchback Engine A17DTL	GC099023	Outer Joint	30	26	53.8	94.5	65.5	M					
1.7 CDTi (81 kW)	2009.12-		MT	L	F	Hatchback Engine A17DTC/A17DTE/A17DTJ	GDS21076	Drive Shaft	30	25	52.5	94	601					
	2009.12-		MT	R	F	Hatchback Engine A17DTC/A17DTE/A17DTJ	GDS21074	Drive Shaft	30	34	52.5	94	589					
	2009.12-				Hatchback Engine A17DTC/A17DTE/A17DTJ	GC099023	Outer Joint	30	26	53.8	94.5	65.5	M					
	2012.06-		MT	L	F	Saloon Engine A17DTC/A17DTE/A17DTJ	GDS21076	Drive Shaft	30	25	52.5	94	601					
	2012.06-		MT	R	F	Saloon Engine A17DTC/A17DTE/A17DTJ	GDS21074	Drive Shaft	30	34	52.5	94	589					
	2012.06-					Saloon Engine A17DTC/A17DTE/A17DTJ	GC099023	Outer Joint	30	26	53.8	94.5	65.5	M				
1.7 CDTi (92 kW)	2009.12-		MT	L	F	Hatchback Engine A17DTR	GDS21076	Drive Shaft	30	25	52.5	94	601					
	2009.12-		MT	R	F	Hatchback Engine A17DTR	GDS21074	Drive Shaft	30	34	52.5	94	589					
	2009.12-				Hatchback Engine A17DTR	GC099023	Outer Joint	30	26	53.8	94.5	65.5	M					
1.7 CDTi (96 kW)	2009.12-		MT	L	F	Hatchback Engine A17DTF/A17DTS	GDS21076	Drive Shaft	30	25	52.5	94	601					
	2009.12-		MT	R	F	Hatchback Engine A17DTF/A17DTS	GDS21074	Drive Shaft	30	34	52.5	94	589					
	2009.12-				Hatchback Engine A17DTF/A17DTS	GC099023	Outer Joint	30	26	53.8	94.5	65.5	M					
	2012.06-		MT	L	F	Saloon Engine A17DTF/A17DTS	GDS21076	Drive Shaft	30	25	52.5	94	601					
	2012.06-		MT	R	F	Saloon Engine A17DTF/A17DTS	GDS21074	Drive Shaft	30	34	52.5	94	589					
	2012.06-					Saloon Engine A17DTF/A17DTS	GC099023	Outer Joint	30	26	53.8	94.5	65.5	M				



		TRANSM	L/R	F/R		G-AP Ref.	PRODUCT	ABS	Technical Specifications						
									YEAR	A	B	C	H	L	P
<b>OPEL</b>															
<b>ASTRA J</b>															
2.0 BiTurbo CDTi (143 kW)	2012.12-		MT	L	F	Hatchback Engine A20DTR	GDS21075	Drive Shaft		30	27	52.5	94	599	
	2012.12-		MT	R	F	Hatchback Engine A20DTR	GDS21036	Drive Shaft		30	27	55.4	100	602	
	2012.12-					Hatchback Engine A20DTR	GC099023	Outer Joint		30	26	53.8	94.5	65.5	M
2.0 CDTi (118 kW)	2009.12-		MT	L	F	Hatchback Engine A20DTH	GDS21075	Drive Shaft		30	27	52.5	94	599	
	2009.12-		MT	R	F	Hatchback Engine A20DTH	GDS21036	Drive Shaft		30	27	55.4	100	602	
	2009.12-					Hatchback Engine A20DTH	GC099023	Outer Joint		30	26	53.8	94.5	65.5	M
2.0 CDTi (121 kW)	2011.06-		MT	R	F	Hatchback Engine A20DTH	GDS21036	Drive Shaft		30	27	55.4	100	602	
	2011.06-					Hatchback Engine A20DTH	GC099023	Outer Joint		30	26	53.8	94.5	65.5	M
<b>ASTRA J SPORTS TOURER</b>															
1.3 CDTi (70 kW)	2010.10-		AT			Estate Engine A13DTE	GC088047	Outer Joint		33	23	52.5	94	59.5	M
1.4 (74 kW)	2010.10-		MT	L	F	Estate Engine A14XER	GDS44064	Drive Shaft		33	22	53	95	618	
	2010.10-		MT	L	F	Estate Engine A14XER	GCI21014	Inner Joint		22	22	35	57.5	75	
	2010.10-					Estate Engine A14XER	GC044088	Outer Joint		33	23	52.3	94	59.5	M
1.4 LPG (103 kW)	2012.01-		AT			Estate Engine A14NET	GC088047	Outer Joint		33	23	52.5	94	59.5	M
1.4 Turbo (103 kW)	2010.10-		AT			Estate Engine A14NET	GC088047	Outer Joint		33	23	52.5	94	59.5	M
1.6 (85 kW)	2010.10-		MT	L	F	Estate Engine A16XER	GDS44064	Drive Shaft		33	22	53	95	618	
	2010.10-		MT	L	F	Estate Engine A16XER	GCI21014	Inner Joint		22	22	35	57.5	75	
	2010.10-		AT	R	F	Estate Engine A16XER	GDS21072	Drive Shaft		33	22	52.3	94	957	
	2010.10-		MT	R	F	Estate Engine A16XER	GDS44065	Drive Shaft		33	22	53	95	983	
	2010.10-		MT	R	F	Estate Engine A16XER	GCI21014	Inner Joint		22	22	35	57.5	75	
	2010.10-		AT			Estate Engine A16XER	GC088047	Outer Joint		33	23	52.5	94	59.5	M
	2010.10-		MT			Estate Engine A16XER	GC044088	Outer Joint		33	23	52.3	94	59.5	M
	2010.10-					Estate Engine A16XER	GC044088	Outer Joint		33	23	52.3	94	59.5	M
1.6 LPG (84 kW)	2012.10-		MT	L	F	Estate Engine A16XER	GDS44064	Drive Shaft		33	22	53	95	618	
	2012.10-		MT	L	F	Estate Engine A16XER	GCI21014	Inner Joint		22	22	35	57.5	75	
	2012.10-		AT	R	F	Estate Engine A16XER	GDS21072	Drive Shaft		33	22	52.3	94	957	
	2012.10-		MT	R	F	Estate Engine A16XER	GDS44065	Drive Shaft		33	22	53	95	983	
	2012.10-		MT	R	F	Estate Engine A16XER	GCI21014	Inner Joint		22	22	35	57.5	75	
	2012.10-					Estate Engine A16XER	GC044088	Outer Joint		33	23	52.3	94	59.5	M
1.7 CDTi (74 kW)	2010.10-		MT	L	F	Estate Engine A17DTL	GDS21076	Drive Shaft		30	25	52.5	94	601	
	2010.10-		MT	R	F	Estate Engine A17DTL	GDS21074	Drive Shaft		30	34	52.5	94	589	
	2010.10-					Estate Engine A17DTL	GC099023	Outer Joint		30	26	53.8	94.5	65.5	M
1.7 CDTi (81 kW)	2010.10-		MT	L	F	Estate Engine A17DTC/A17DTE/A17DTJ	GDS21076	Drive Shaft		30	25	52.5	94	601	
	2010.10-		MT	R	F	Estate Engine A17DTC/A17DTE/A17DTJ	GDS21074	Drive Shaft		30	34	52.5	94	589	
	2010.10-					Estate Engine A17DTC/A17DTE/A17DTJ	GC099023	Outer Joint		30	26	53.8	94.5	65.5	M
1.7 CDTi (92 kW)	2010.10-		MT	L	F	Estate Engine A17DTR	GDS21076	Drive Shaft		30	25	52.5	94	601	
	2010.10-		MT	R	F	Estate Engine A17DTR	GDS21074	Drive Shaft		30	34	52.5	94	589	
	2010.10-					Estate Engine A17DTR	GC099023	Outer Joint		30	26	53.8	94.5	65.5	M
1.7 CDTi (96 kW)	2010.10-		MT	L	F	Estate Engine A17DTF/A17DTS	GDS21076	Drive Shaft		30	25	52.5	94	601	
	2010.10-		MT	R	F	Estate Engine A17DTF/A17DTS	GDS21074	Drive Shaft		30	34	52.5	94	589	
	2010.10-					Estate Engine A17DTF/A17DTS	GC099023	Outer Joint		30	26	53.8	94.5	65.5	M
2.0 BiTurbo CDTi (143 kW)	2012.12-		MT	R	F	Estate Engine A20DTR	GDS21036	Drive Shaft		30	27	55.4	100	602	
	2012.12-					Estate Engine A20DTR	GC099023	Outer Joint		30	26	53.8	94.5	65.5	M
2.0 CDTi (118 kW)	2010.10-		MT	R	F	Estate Engine A20DTH	GDS21036	Drive Shaft		30	27	55.4	100	602	
	2010.10-					Estate Engine A20DTH	GC099023	Outer Joint		30	26	53.8	94.5	65.5	M
2.0 CDTi (121 kW)	2011.08-		MT	R	F	Estate Engine A20DTH	GDS21036	Drive Shaft		30	27	55.4	100	602	
	2011.08-					Estate Engine A20DTH	GC099023	Outer Joint		30	26	53.8	94.5	65.5	M
<b>ASTRA J, GTC, SW</b>															
1.4 (103 kW)	2012-		MT				GC044028	Outer Joint		33	24	53	93.5	63.5	M
1.4 (64 kW)	2009-						GC044003	Outer Joint		33	22	53	95	54.5	M
1.4 (74 kW)	2009-						GC044003	Outer Joint		33	22	53	95	54.5	M
1.4 T (103 kW)	2009-		MT				GC044028	Outer Joint		33	24	53	93.5	63.5	M
1.4 T (88 kW)	2009-		MT				GC044028	Outer Joint		33	24	53	93.5	63.5	M
<b>ASTRA J, SW, GTC</b>															
1.6 Cabrio, Coupe (85 kW)	2009-						GC044003	Outer Joint		33	22	53	95	54.5	M
<b>CALIBRA A (85)</b>															
2.0 i (85 kW)	1990-	1991.07	MT/AT			Ch-N500000	GC044057	Outer Joint	43T	33	25	52	109	61	O
2.0 i 16V 4WD (100 kW)	1990.06-	1997.07			F	Ch-N5000000	GC044057	Outer Joint	43T	33	25	52	109	61	O
2.0 i 16V 4WD (110 kW)	1990.06-	1997.07			F	Ch-N5000000	GC044057	Outer Joint	43T	33	25	52	109	61	O
2.0 i 16V 4WD (115 kW)	1990.06-	1997.07			F	Ch-N5000000	GC044057	Outer Joint	43T	33	25	52	109	61	O
2.0 i 4WD (85 kW)	1990.06-	1997.07	MT/AT			Ch-N5000000	GC044057	Outer Joint	43T	33	25	52	109	61	O
2.5 i V6 (125 kW)	1993.04-	1997.07					GC044057	Outer Joint	43T	33	25	52	109	61	O

		TRANSM	L/R	F/R		G-AP Ref.	PRODUCT	ABS	Technical Specifications											
									YEAR	A	B	C	H	L	P					
<b>OPEL CALIBRA A (85_)</b>																				
2.0 i (85 kW)	1990.06-	1997.07	MT/AT		F	Coupe Engine C20NE	GC044057	Outer Joint	43T	33	25	52	109	61	O					
	1990.06-	1997.07	MT	L	F	Coupe Engine C20NE	GDS44014	Drive Shaft	43T	33	34	52	103.5	587						
	1990.06-	1997.07	MT	R	F	Coupe Engine C20NE	GDS44059	Drive Shaft	29T	33	34	52	109	938						
	1990.06-	1997.07	MT/AT		F	Coupe Engine C20NE	GC044056	Outer Joint	29T	33	25	52	109	61	O					
	1990.06-	1997.07	MT	L	F	Coupe Engine C20NE	GDS44011	Drive Shaft	29T	33	34	52	109	594.5						
	1990.06-	1997.07	MT		F	Coupe Engine C20NE	GCI44002	Inner Joint		34	25	35	56.2	85.6						
2.0 i 16V (100 kW)	1994.02-	1997.07	MT		F	Coupe Engine X20XEV	GC044057	Outer Joint	43T	33	25	52	109	61	O					
	1994.02-	1997.07	MT		F	Coupe Engine X20XEV	GC044056	Outer Joint	29T	33	25	52	109	61	O					
2.0 i 16V (110 kW)	1990.06-	1994.02	MT		F	Coupe Engine C20XE	GC044057	Outer Joint	43T	33	25	52	109	61	O					
	1990.06-	1994.02	MT	L	F	Coupe Engine C20XE	GDS44014	Drive Shaft	43T	33	34	52	103.5	587						
	1990.06-	1994.02	MT		F	Coupe Engine C20XE	GC044056	Outer Joint	29T	33	25	52	109	61	O					
	1990.06-	1994.02	MT		F	Coupe Engine C20XE	GCI44005	Inner Joint		34	25	35	54	47						
	1990.06-	1994.02	MT	L	F	Coupe Engine C20XE	GDS44011	Drive Shaft	29T	33	34	52	109	594.5						
	1990.06-	1994.02	MT		F	Coupe Engine C20XE	GCI44002	Inner Joint		34	25	35	56.2	85.6						
2.0 i 16V 4x4 (100 kW)	1994.02-	1997.07	MT			Coupe Engine X20XEV	GC044057	Outer Joint	43T	33	25	52	109	61	O					
	1994.02-	1997.07	MT		F	Coupe Engine X20XEV	GC044056	Outer Joint	29T	33	25	52	109	61	O					
2.0 i 16V 4x4 (110 kW)	1990.06-	1994.02	MT			Coupe Engine C20XE	GC044057	Outer Joint	43T	33	25	52	109	61	O					
	1990.06-	1994.02	MT	L	F	Coupe Engine C20XE	GDS44014	Drive Shaft	43T	33	34	52	103.5	587						
	1990.06-	1994.02	MT		F	Coupe Engine C20XE	GC044056	Outer Joint	29T	33	25	52	109	61	O					
	1990.06-	1994.02	MT		F	Coupe Engine C20XE	GCI44005	Inner Joint		34	25	35	54	47						
	1990.06-	1994.02	MT	L	F	Coupe Engine C20XE	GDS44011	Drive Shaft	29T	33	34	52	109	594.5						
	1990.06-	1994.02	MT		F	Coupe Engine C20XE	GCI44002	Inner Joint		34	25	35	56.2	85.6						
2.0 i 4x4 (85 kW)	1990.06-	1997.07	MT			Coupe Engine C20NE	GC044057	Outer Joint	43T	33	25	52	109	61	O					
	1990.06-	1997.07	MT	L	F	Coupe Engine C20NE	GDS44014	Drive Shaft	43T	33	34	52	103.5	587						
	1990.06-	1997.07	MT		F	Coupe Engine C20NE	GC044056	Outer Joint	29T	33	25	52	109	61	O					
	1990.06-	1997.07	MT		F	Coupe Engine C20NE	GCI44005	Inner Joint		34	25	35	54	47						
	1990.06-	1997.07	MT	L	F	Coupe Engine C20NE	GDS44011	Drive Shaft	29T	33	34	52	109	594.5						
	1990.06-	1997.07	MT		F	Coupe Engine C20NE	GCI44002	Inner Joint		34	25	35	56.2	85.6						
2.0 i Turbo 4x4 (150 kW)	1992.03-	1997.07	MT		F	Coupe Engine C20LET	GC044056	Outer Joint	29T	33	25	52	109	61	O					
	1992.03-	1997.07	MT		F	Coupe Engine C20LET	GCI44005	Inner Joint		34	25	35	54	47						
	1992.03-	1997.07	MT	L	F	Coupe Engine C20LET	GDS44011	Drive Shaft	29T	33	34	52	109	594.5						
	1992.03-	1997.07	MT		F	Coupe Engine C20LET	GCI44002	Inner Joint		34	25	35	56.2	85.6						
2.5 i V6 (125 kW)	1993.04-	1997.07	MT		F	Coupe Engine C25XE/X25XE	GCI44005	Inner Joint		34	25	35	54	47						
	1993.04-	1997.07	MT		F	Coupe Engine C25XE/X25XE	GCI44002	Inner Joint		34	25	35	56.2	85.6						
<b>CASCADA (W13)</b>																				
2.0 CDTi (121 kW)	2013.03-		AT			Convertible Engine A20DTH	GC099023	Outer Joint		30	26	53.8	94.5	65.5	M					
2.0 CDTi (143 kW)	2013.03-		AT			Convertible Engine A20DTR	GC099023	Outer Joint		30	26	53.8	94.5	65.5	M					
<b>CHEVY</b>																				
-							GCI44007	Inner Joint		22	28	34.95	57	96.5						
<b>COMBO</b>																				
1.3 CDTi 16V (51 kW)	2005.08-				F	Box Body / Estate Engine Z13DT	GC044020	Outer Joint	29T	22	28	52	97.5	57.5	O					
	2005.08-			L	F	Box Body / Estate Engine Z13DT	GDS44045	Drive Shaft	29T	22	22	52	97	579						
	2005.08-			L	F	Box Body / Estate Engine Z13DT	GDS44027	Drive Shaft	29T	22	22	52	98	580						
	2005.08-			R	F	Box Body / Estate Engine Z13DT	GDS44075	Drive Shaft	29T	22	22	52	97.5	926						
	2005.08-			R	F	Box Body / Estate Engine Z13DT	GDS44026	Drive Shaft	29T	22	22	52	98	930						
	2005.08-		MT/AT	R	F	Box Body / Estate Engine Z13DT	GDS99205	Drive Shaft		22	22	52	97.5	930						
	2005.08-		MT/AT	R	F	Box Body / Estate Engine Z13DT	GCI60001	Inner Joint		22	28	34.9	57.5	96.5						
	2005.08-		MT/AT	R	F	Box Body / Estate Engine Z13DT	GC044043	Outer Joint		22	28	52	97.5	57.5	O					
1.3 CDTi 16V (55 kW)	2005.10-				F	Box Body / Estate Engine Z13DTJ	GC044020	Outer Joint	29T	22	28	52	97.5	57.5	O					
	2005.10-			L	F	Box Body / Estate Engine Z13DTJ	GDS44045	Drive Shaft	29T	22	22	52	97	579						
	2005.10-			L	F	Box Body / Estate Engine Z13DTJ	GDS44027	Drive Shaft	29T	22	22	52	98	580						
	2005.10-			R	F	Box Body / Estate Engine Z13DTJ	GDS44075	Drive Shaft	29T	22	22	52	97.5	926						
	2005.10-			R	F	Box Body / Estate Engine Z13DTJ	GDS44026	Drive Shaft	29T	22	22	52	98	930						
	2005.10-		MT/AT	R	F	Box Body / Estate Engine Z13DTJ	GDS99205	Drive Shaft		22	22	52	97.5	930						
	2005.10-		MT/AT	R	F	Box Body / Estate Engine Z13DTJ	GCI60001	Inner Joint		22	28	34.9	57.5	96.5						
	2005.10-		MT/AT	R	F	Box Body / Estate Engine Z13DTJ	GC044043	Outer Joint		22	28	52	97.5	57.5	O					
1.4 16V (66 kW)	2005.08-				F	Box Body / Estate Engine Z14XEP	GC044020	Outer Joint	29T	22	28	52	97.5	57.5	O					
	2005.08-			L	F	Box Body / Estate Engine Z14XEP	GDS44045	Drive Shaft	29T	22	22	52	97	579						
	2005.08-		MT/AT	L	F	Box Body / Estate Engine Z14XEP	GDS44027	Drive Shaft	29T	22	22	52	98	580						
	2005.08-			R	F	Box Body / Estate Engine Z14XEP	GDS44075	Drive Shaft	29T	22	22	52	97.5	926						
	2005.08-		MT/AT	R	F	Box Body / Estate Engine Z14XEP	GDS44026	Drive Shaft	29T	22	22	52	98	930						









		TRANSM	L/R	F/R		G-AP Ref.	PRODUCT	ABS	Technical Specifications									
									YEAR	A	B	C	H	L	P			
<b>OPEL COMBO</b>																		
1.4 16V (66 kW)	2005.08-		MT/AT	R	F	Box Body / Estate Engine Z14XEP	GDS99205	Drive Shaft		22	22	52	97.5	930				
	2005.08-		MT/AT	R	F	Box Body / Estate Engine Z14XEP	GCI60001	Inner Joint		22	28	34.9	57.5	96.5				
	2005.08-		MT/AT	R	F	Box Body / Estate Engine Z14XEP	GC044043	Outer Joint		22	28	52	97.5	57.5	O			
1.6 (64 kW)	2001.10-				F	Box Body / Estate Engine Z16SE	GC044020	Outer Joint	29T	22	28	52	97.5	57.5	O			
	2001.10-			L	F	Box Body / Estate Engine Z16SE	GDS44045	Drive Shaft	29T	22	22	52	97	579				
	2001.10-		MT/AT	L	F	Box Body / Estate Engine Z16SE	GDS44027	Drive Shaft	29T	22	22	52	98	580				
	2001.10-			R	F	Box Body / Estate Engine Z16SE	GDS44075	Drive Shaft	29T	22	22	52	97.5	926				
	2001.10-		MT/AT	R	F	Box Body / Estate Engine Z16SE	GDS44026	Drive Shaft	29T	22	22	52	98	930				
	2001.10-		MT/AT	R	F	Box Body / Estate Engine Z16SE	GDS99205	Drive Shaft		22	22	52	97.5	930				
	2001.10-		MT/AT	R	F	Box Body / Estate Engine Z16SE	GCI60001	Inner Joint		22	28	34.9	57.5	96.5				
1.6 CNG 16V (69 kW)	2006.06-			L	F	Box Body / Estate Engine Z16YNG	GDS44045	Drive Shaft	29T	22	22	52	97	579				
	2006.06-			L	F	Box Body / Estate Engine Z16YNG	GDS44027	Drive Shaft	29T	22	22	52	98	580				
	2006.06-			R	F	Box Body / Estate Engine Z16YNG	GDS44075	Drive Shaft	29T	22	22	52	97.5	926				
	2006.06-			R	F	Box Body / Estate Engine Z16YNG	GDS44026	Drive Shaft	29T	22	22	52	98	930				
1.6 CNG 16V (71 kW)	2005.04-			L	F	Box Body / Estate Engine Z16YNG	GDS44045	Drive Shaft	29T	22	22	52	97	579				
	2005.04-		MT/AT	L	F	Box Body / Estate Engine Z16YNG	GDS44027	Drive Shaft	29T	22	22	52	98	580				
	2005.04-			R	F	Box Body / Estate Engine Z16YNG	GDS44075	Drive Shaft	29T	22	22	52	97.5	926				
	2005.04-			R	F	Box Body / Estate Engine Z16YNG	GDS44026	Drive Shaft	29T	22	22	52	98	930				
1.7 CDTi 16V (74 kW)	2004.12-		MT	L	F	Box Body / Estate Engine Z17DTH	GDS44032	Drive Shaft	29T	33	34	52	104	587.5				
	2004.12-		MT	L	F	Box Body / Estate Engine Z17DTH	GCI21034	Inner Joint		34	24	35	56.5	102				
	2004.12-		MT	L/R	F	Box Body / Estate Engine Z17DTH	GC022005	Outer Joint		33	24	52	104	64	M			
	2004.12-		MT	R	F	Box Body / Estate Engine Z17DTH	GDS60021	Drive Shaft	29T	33	34	52	104	612				
	2004.12-		MT	R	F	Box Body / Estate Engine Z17DTH	GCI60003	Inner Joint		34	24	35.5	47	70.5				
	2004.12-			R	F	Box Body / Estate Engine Z17DTH	GDS44092	Drive Shaft	29T	33	34	52	104	609				
1.7 Di 16V (48 kW)	2001.10-				F	Box Body / Estate Engine Y17DTL	GC044020	Outer Joint	29T	22	28	52	97.5	57.5	O			
	2001.10-		MT		F	Box Body / Estate Engine Y17DTL	GC044002	Outer Joint	29T	22	23	52	97.5	61	M			
	2001.10-			L	F	Box Body / Estate Engine Y17DTL	GDS44045	Drive Shaft	29T	22	22	52	97	579				
	2001.10-		MT/AT	L	F	Box Body / Estate Engine Y17DTL	GDS44027	Drive Shaft	29T	22	22	52	98	580				
	2001.10-			R	F	Box Body / Estate Engine Y17DTL	GDS44075	Drive Shaft	29T	22	22	52	97.5	926				
	2001.10-		MT/AT	R	F	Box Body / Estate Engine Y17DTL	GDS44026	Drive Shaft	29T	22	22	52	98	930				
	2001.10-		MT/AT	R	F	Box Body / Estate Engine Y17DTL	GDS99205	Drive Shaft		22	22	52	97.5	930				
	2001.10-		MT/AT	R	F	Box Body / Estate Engine Y17DTL	GCI60001	Inner Joint		22	28	34.9	57.5	96.5				
1.7 DTi 16V (55 kW)	2001.10-		MT		F	Box Body / Estate Engine Y17DT	GC044002	Outer Joint	29T	22	23	52	97.5	61	M			
	2001.10-			L	F	Box Body / Estate Engine Y17DT	GDS44045	Drive Shaft	29T	22	22	52	97	579				
	2001.10-		MT	L	F	Box Body / Estate Engine Y17DT	GDS44027	Drive Shaft	29T	22	22	52	98	580				
	2001.10-			R	F	Box Body / Estate Engine Y17DT	GDS44075	Drive Shaft	29T	22	22	52	97.5	926				
	2001.10-		MT	R	F	Box Body / Estate Engine Y17DT	GDS44026	Drive Shaft	29T	22	22	52	98	930				
	2001.10-		MT/AT	R	F	Box Body / Estate Engine Y17DT	GDS99205	Drive Shaft		22	22	52	97.5	930				
	2001.10-		MT/AT	R	F	Box Body / Estate Engine Y17DT	GCI60001	Inner Joint		22	28	34.9	57.5	96.5				
	2001.10-		MT/AT	R	F	Box Body / Estate Engine Y17DT	GC044043	Outer Joint		22	28	52	97.5	57.5	O			
<b>COMBO B</b>																		
1.4	1994-2001						GCI44003	Inner Joint		22	28	34.95	57.5	83.5				
<b>COMBO II</b>																		
1.3 CDTi 16V (51 kW)	2004-						GC044002	Outer Joint	29T	22	23	52	97.5	61	M			
1.7 Di 16V (48 kW)	2001.10-						GC044002	Outer Joint	29T	22	23	52	97.5	61	M			
1.7 DTi 16V (55 kW)	2001.10-						GC044002	Outer Joint	29T	22	23	52	97.5	61	M			
<b>COMBO TOUR</b>																		
1.3 CDTi 16V (51 kW)	2004.10-				F	MPV Engine Y13DT/Z13DT	GC044020	Outer Joint	29T	22	28	52	97.5	57.5	O			
	2004.10-				F	MPV Engine Y13DT/Z13DT	GC044002	Outer Joint	29T	22	23	52	97.5	61	M			
	2004.10-			L	F	MPV Engine Y13DT/Z13DT	GDS44045	Drive Shaft	29T	22	22	52	97	579				
	2004.10-			L	F	MPV Engine Y13DT/Z13DT	GDS44027	Drive Shaft	29T	22	22	52	98	580				
	2004.10-			R	F	MPV Engine Y13DT/Z13DT	GDS44075	Drive Shaft	29T	22	22	52	97.5	926				
	2004.10-			R	F	MPV Engine Y13DT/Z13DT	GDS44026	Drive Shaft	29T	22	22	52	98	930				
	2004.10-		MT/AT	R	F	MPV Engine Y13DT/Z13DT	GDS99205	Drive Shaft		22	22	52	97.5	930				
	2004.10-		MT/AT	R	F	MPV Engine Y13DT/Z13DT	GCI60001	Inner Joint		22	28	34.9	57.5	96.5				
1.3 CDTi 16V (55 kW)	2005.10-			L	F	MPV Engine Z13DTJ	GDS44027	Drive Shaft	29T	22	22	52	98	580				
	2005.10-			L	F	MPV Engine Z13DTJ	GDS44045	Drive Shaft	29T	22	22	52	97	579				
	2005.10-			R	F	MPV Engine Z13DTJ	GDS44075	Drive Shaft	29T	22	22	52	97.5	926				



		TRANSM	L/R	F/R		G-AP Ref.	PRODUCT	ABS	Technical Specifications							
									YEAR	A	B	C	H	L	P	
<b>OPEL COMBO TOUR</b>																
1.3 CDTi 16V (55 kW)	2005.10-			R	F	MPV Engine Z13DTJ	GDS44026	Drive Shaft	29T	22	22	52	98	930		
	2005.10-		MT/AT	R	F	MPV Engine Z13DTJ	GDS99205	Drive Shaft		22	22	52	97.5	930		
	2005.10-		MT/AT	R	F	MPV Engine Z13DTJ	GCI60001	Inner Joint		22	28	34.9	57.5	96.5		
	2005.10-		MT/AT	R	F	MPV Engine Z13DTJ	GC044043	Outer Joint		22	28	52	97.5	57.5	O	
1.4 (66 kW)	2004.10-				F	MPV Engine Z14XEP	GC044020	Outer Joint	29T	22	28	52	97.5	57.5	O	
	2004.10-			L	F	MPV Engine Z14XEP	GDS44045	Drive Shaft	29T	22	22	52	97	579		
	2004.10-		MT/AT	L	F	MPV Engine Z14XEP	GDS44027	Drive Shaft	29T	22	22	52	98	580		
	2004.10-			R	F	MPV Engine Z14XEP	GDS44075	Drive Shaft	29T	22	22	52	97.5	926		
	2004.10-		MT/AT	R	F	MPV Engine Z14XEP	GDS44026	Drive Shaft	29T	22	22	52	98	930		
	2004.10-			L	F	MPV Engine Z14XEP	GDS99069	Drive Shaft	29T	22	22	52	97.5	584		
	2004.10-			L/R	F	MPV Engine Z14XEP	GC044043	Outer Joint		22	28	52	97.5	57.5	O	
	2004.10-		MT/AT	R	F	MPV Engine Z14XEP	GDS99205	Drive Shaft		22	22	52	97.5	930		
	2004.10-		MT/AT	R	F	MPV Engine Z14XEP	GCI60001	Inner Joint		22	28	34.9	57.5	96.5		
	2004.10-		MT/AT	R	F	MPV Engine Z14XEP	GC044043	Outer Joint		22	28	52	97.5	57.5	O	
1.6 (64 kW)	2001.10-				F	MPV Engine Z16SE	GDS44020	Outer Joint	29T	22	28	52	97.5	57.5	O	
	2001.10-			L	F	MPV Engine Z16SE	GDS44045	Drive Shaft	29T	22	22	52	97	579		
	2001.10-		MT/AT	L	F	MPV Engine Z16SE	GDS44027	Drive Shaft	29T	22	22	52	98	580		
	2001.10-			R	F	MPV Engine Z16SE	GDS44075	Drive Shaft	29T	22	22	52	97.5	926		
	2001.10-		MT/AT	R	F	MPV Engine Z16SE	GDS44026	Drive Shaft	29T	22	22	52	98	930		
	2001.10-			L	F	MPV Engine Z16SE	GDS99069	Drive Shaft	29T	22	22	52	97.5	584		
	2001.10-			L/R	F	MPV Engine Z16SE	GC044043	Outer Joint		22	28	52	97.5	57.5	O	
	2001.10-		MT/AT	R	F	MPV Engine Z16SE	GDS99205	Drive Shaft		22	22	52	97.5	930		
	2001.10-		MT/AT	R	F	MPV Engine Z16SE	GCI60001	Inner Joint		22	28	34.9	57.5	96.5		
	2001.10-		MT/AT	R	F	MPV Engine Z16SE	GC044043	Outer Joint		22	28	52	97.5	57.5	O	
1.6 CNG (69 kW)	2006.06-			L	F	MPV Engine Z16YNG	GDS44027	Drive Shaft	29T	22	22	52	98	580		
	2006.06-			L	F	MPV Engine Z16YNG	GDS44045	Drive Shaft	29T	22	22	52	97	579		
	2006.06-			R	F	MPV Engine Z16YNG	GDS44075	Drive Shaft	29T	22	22	52	97.5	926		
	2006.06-			R	F	MPV Engine Z16YNG	GDS44026	Drive Shaft	29T	22	22	52	98	930		
1.6 CNG (71 kW)	2005.04-			L	F	MPV Engine Z16YNG	GDS44027	Drive Shaft	29T	22	22	52	98	580		
	2005.04-			L	F	MPV Engine Z16YNG	GDS44045	Drive Shaft	29T	22	22	52	97	579		
	2005.04-			R	F	MPV Engine Z16YNG	GDS44075	Drive Shaft	29T	22	22	52	97.5	926		
	2005.04-			R	F	MPV Engine Z16YNG	GDS44026	Drive Shaft	29T	22	22	52	98	930		
1.7 CDTi 16V (74 kW)	2004.12-		MT	L	F	MPV Engine Z17DTH	GDS44032	Drive Shaft	29T	33	34	52	104	587.5		
	2004.12-		MT	L	F	MPV Engine Z17DTH	GCI21034	Inner Joint		34	24	35	56.5	102		
	2004.12-		MT	L/R	F	MPV Engine Z17DTH	GC022005	Outer Joint		33	24	52	104	64	M	
	2004.12-		MT	R	F	MPV Engine Z17DTH	GDS60021	Drive Shaft	29T	33	34	52	104	612		
	2004.12-		MT	R	F	MPV Engine Z17DTH	GCI60003	Inner Joint		34	24	35.5	47	70.5		
	2004.12-			R	F	MPV Engine Z17DTH	GDS44092	Drive Shaft	29T	33	34	52	104	609		
1.7 Di 16V (48 kW)	2001.10-				F	MPV Engine Y17DTL	GC044020	Outer Joint	29T	22	28	52	97.5	57.5	O	
	2001.10-		MT		F	MPV Engine Y17DTL	GC044002	Outer Joint	29T	22	23	52	97.5	61	M	
	2001.10-			L	F	MPV Engine Y17DTL	GDS44045	Drive Shaft	29T	22	22	52	97	579		
	2001.10-		MT/AT	L	F	MPV Engine Y17DTL	GDS44027	Drive Shaft	29T	22	22	52	98	580		
	2001.10-			R	F	MPV Engine Y17DTL	GDS44075	Drive Shaft	29T	22	22	52	97.5	926		
	2001.10-		MT/AT	R	F	MPV Engine Y17DTL	GDS44026	Drive Shaft	29T	22	22	52	98	930		
	2001.10-		MT/AT	R	F	MPV Engine Y17DTL	GDS99205	Drive Shaft		22	22	52	97.5	930		
	2001.10-		MT/AT	R	F	MPV Engine Y17DTL	GCI60001	Inner Joint		22	28	34.9	57.5	96.5		
1.7 DTi 16V (55 kW)	2001.10-		MT		F	MPV Engine Y17DT	GC044002	Outer Joint	29T	22	23	52	97.5	61	M	
	2001.10-			L	F	MPV Engine Y17DT	GDS44045	Drive Shaft	29T	22	22	52	97	579		
	2001.10-		MT	L	F	MPV Engine Y17DT	GDS44027	Drive Shaft	29T	22	22	52	98	580		
	2001.10-			R	F	MPV Engine Y17DT	GDS44075	Drive Shaft	29T	22	22	52	97.5	926		
	2001.10-		MT	R	F	MPV Engine Y17DT	GDS44026	Drive Shaft	29T	22	22	52	98	930		
	2001.10-		MT/AT	R	F	MPV Engine Y17DT	GDS99205	Drive Shaft		22	22	52	97.5	930		
	2001.10-		MT/AT	R	F	MPV Engine Y17DT	GCI60001	Inner Joint		22	28	34.9	57.5	96.5		
	2001.10-		MT/AT	R	F	MPV Engine Y17DT	GC044043	Outer Joint		22	28	52	97.5	57.5	O	
<b>CORSA A</b>																
1.0 (33 kW)	1986.02-	1989.04	MT		F	Box Engine 10S	GC044046	Outer Joint		22	28	52.2	97.5	55	O	
1.2 (33 kW)	1986.02-	1989.04	MT		F	Box Engine 12NC/E12GV	GC044046	Outer Joint		22	28	52.2	97.5	55	O	
1.2 (40 kW)	1986.02-	1989.04	MT		F	Box Engine 12ST	GC044046	Outer Joint		22	28	52.2	97.5	55	O	

		TRANSM	L/R	F/R		G-AP Ref.	PRODUCT	ABS	Technical Specifications						
									YEAR	A	B	C	H	L	P
<b>OPEL</b>															
<b>CORSA A</b>															
1.3 (44 kW)	1986.02-	1989.04	MT		F	Box Engine 13NB	GC044046	Outer Joint		22	28	52.2	97.5	55	O
1.3 (51 kW)	1986.02-	1989.04	MT		F	Box Engine 13SB	GC044046	Outer Joint		22	28	52.2	97.5	55	O
1.5 D (37 kW)	1987.06-	1989.04	MT		F	Box Engine 15D(4EC1)	GC044046	Outer Joint		22	28	52.2	97.5	55	O
<b>CORSA A (93_, 94_, 98_, 99_)</b>															
1.0 (33 kW)	1982.09-	1993.03	MT		F	Hatchback Engine 10S	GC044046	Outer Joint		22	28	52.2	97.5	55	O
1.2 (33 kW)	1982.09-	1990.08	MT		F	Hatchback Engine 12NC/E12GV	GC044046	Outer Joint		22	28	52.2	97.5	55	O
1.2 i (33 kW)	1989.09-	1993.03	MT		F	Hatchback Engine C12NZ	GC044046	Outer Joint		22	28	52.2	97.5	55	O
1.2 N (38 kW)	1990.01-	1993.03	MT		F	Hatchback Engine 12NV	GC044046	Outer Joint		22	28	52.2	97.5	55	O
1.2 S (40 kW)	1982.09-	1990.02	MT		F	Hatchback Engine 12ST	GC044046	Outer Joint		22	28	52.2	97.5	55	O
1.3 (44 kW)	1985.09-	1989.10	MT		F	Hatchback Engine 13NB	GC044046	Outer Joint		22	28	52.2	97.5	55	O
1.3 i (44 kW)	1986.09-	1990.09	MT		F	Hatchback Engine C13N	GC044046	Outer Joint		22	28	52.2	97.5	55	O
1.3 S (51 kW)	1982.09-	1989.10	MT		F	Hatchback Engine 13SB	GC044046	Outer Joint		22	28	52.2	97.5	55	O
1.4 i (44 kW)	1990.01-	1993.03	MT		F	Hatchback Engine C14NZ	GC044046	Outer Joint		22	28	52.2	97.5	55	O
1.4 S (53 kW)	1990.01-	1993.03	MT		F	Hatchback Engine 14NV	GC044046	Outer Joint		22	28	52.2	97.5	55	O
1.4 Si (60 kW)	1991.09-	1993.03	MT		F	Hatchback Engine C14SE	GC044046	Outer Joint		22	28	52.2	97.5	55	O
1.5 D (37 kW)	1987.09-	1993.03	MT		F	Hatchback Engine 15D(4EC1)	GC044046	Outer Joint		22	28	52.2	97.5	55	O
1.6 GSi (72 kW)	1989.09-	1993.03	MT		F	Hatchback Engine C16SEI	GCI44004	Inner Joint		22	22	34.95	57.5	72.5	
1.6 GSi (74 kW)	1989.09-	1993.03	MT		F	Hatchback Engine C16SEI	GC044041	Outer Joint		22	22	52	95	50	O
	1988.05-	1992.03	MT		F	Hatchback Engine E16SE	GCI44004	Inner Joint		22	22	34.95	57.5	72.5	
1.6 GSi CAT (74 kW)	1988.05-	1992.03	MT		F	Hatchback Engine E16SE	GC044041	Outer Joint		22	22	52	95	50	O
	1992.02-	1993.03	MT		F	Hatchback Engine C16SE	GCI44004	Inner Joint		22	22	34.95	57.5	72.5	
	1992.02-	1993.03	MT		F	Hatchback Engine C16SE	GC044041	Outer Joint		22	22	52	95	50	O
<b>CORSA A TR (91_, 92_, 96_, 97_)</b>															
1.0 (33 kW)	1982.09-	1992.09	MT		F	Saloon Engine 10S	GC044046	Outer Joint		22	28	52.2	97.5	55	O
1.2 i (33 kW)	1989.09-	1993.03	MT		F	Saloon Engine C12NZ	GC044046	Outer Joint		22	28	52.2	97.5	55	O
1.2 N (33 kW)	1985.01-	1987.10	MT		F	Saloon Engine 12NC/E12GV	GC044046	Outer Joint		22	28	52.2	97.5	55	O
1.2 S (40 kW)	1982.09-	1993.03	MT		F	Saloon Engine 12ST	GC044046	Outer Joint		22	28	52.2	97.5	55	O
1.2 S (43 kW)	1982.09-	1987.10	MT		F	Saloon Engine 12S	GC044046	Outer Joint		22	28	52.2	97.5	55	O
1.3 (44 kW)	1985.09-	1987.10	MT		F	Saloon Engine 13NB/C13N	GC044046	Outer Joint		22	28	52.2	97.5	55	O
1.3 S (51 kW)	1982.09-	1987.10	MT		F	Saloon Engine 13SB	GC044046	Outer Joint		22	28	52.2	97.5	55	O
1.4 i (44 kW)	1989.10-	1993.03	MT		F	Saloon Engine C14NZ	GC044046	Outer Joint		22	28	52.2	97.5	55	O
1.4 S (53 kW)	1989.09-	1993.03	MT		F	Saloon Engine 14NV	GC044046	Outer Joint		22	28	52.2	97.5	55	O
1.5 D (37 kW)	1987.10-	1992.11	MT		F	Saloon Engine 15D(4EC1)	GC044046	Outer Joint		22	28	52.2	97.5	55	O
1.5 TD (49 kW)	1987.10-	1993.03	MT		F	Saloon Engine 15DT(T4EC1)	GCI44004	Inner Joint		22	22	34.95	57.5	72.5	
	1987.10-	1993.03	MT		F	Saloon Engine 15DT(T4EC1)	GC044041	Outer Joint		22	22	52	95	50	O
<b>CORSA B</b>															
1.0 8V	1993-	2000					GCI44003	Inner Joint		22	28	34.95	57.5	83.5	
1.2 8V	1993-	2000					GCI44003	Inner Joint		22	28	34.95	57.5	83.5	
1.4 8V	1993-	2000				Engine X17DTL	GCI44003	Inner Joint		22	28	34.95	57.5	83.5	
1.5 D	1993-	2000					GCI44003	Inner Joint		22	28	34.95	57.5	83.5	
1.6	1993-	2000		L	F		GDS44049	Drive Shaft	29T	22	22	52	98	564	
	1993-	2000		R	F		GDS44050	Drive Shaft	29T	22	22	52	95	911	
<b>CORSA B (73, 78, 79, F35)</b>															
1.5 D (37 kW)	1993.03-	2000.09	MT				GC044060	Outer Joint	29T	22	22	52	98	51	O
1.6 GSi 16V (80 kW)	1993.03-	2000.09					GC044060	Outer Joint	29T	22	22	52	98	51	O
1.6 i 16V (78 kW)	1994.09-	2000.09					GC044060	Outer Joint	29T	22	22	52	98	51	O
<b>CORSA B (73_, 78_, 79_)</b>															
1.0 i 12V (40 kW)	1996.11-	2000.09	5MT	L	F	Hatchback Engine X10XE	GDS44036	Drive Shaft	29T	22	22	52	95	565	
	1996.11-	2000.09	5MT	R	F	Hatchback Engine X10XE	GDS44037	Drive Shaft	29T	22	22	52	97	921	
1.6 GSi 16V (80 kW)	1993.03-	2000.09	MT		F	Hatchback Engine C16XE	GCI44004	Inner Joint		22	22	34.95	57.5	72.5	
1.6 i 16V (78 kW)	1994.09-	2000.09	MT		F	Hatchback Engine X16XE	GCI44004	Inner Joint		22	22	34.95	57.5	72.5	
<b>CORSA C</b>															
-							GCI44010	Inner Joint		22	27	34.9	57.5	96.5	
				L			GDS44008	Drive Shaft	29T	22	22	52	97.5	562	
				R			GDS44007	Drive Shaft	29T	22	22	52	97.5	912	
<b>CORSA C (F08, F68)</b>															
1.0 (43 kW)	2000.09-	2009.12	5MT		F	Hatchback Engine Z10XE	GC044013	Outer Joint	29T	22	28	52	98	52	O
	2000.09-	2009.12		L	F	Hatchback Engine Z10XE	GDS44027	Drive Shaft	29T	22	22	52	98	580	
	2000.09-	2009.12	MT/AT	L	F	Hatchback Engine Z10XE	GDS44045	Drive Shaft	29T	22	22	52	97	579	
	2000.09-	2009.12		R	F	Hatchback Engine Z10XE	GDS44026	Drive Shaft	29T	22	22	52	98	930	
	2000.09-	2009.12	MT/AT	R	F	Hatchback Engine Z10XE	GDS99205	Drive Shaft		22	22	52	97.5	930	









		TRANSM	L/R	F/R		G-AP Ref.	PRODUCT	ABS	Technical Specifications									
									YEAR	A	B	C	H	L	P			
<b>OPEL CORSA C (F08, F68)</b>																		
1.0 (43 kW)	2000.09-	2009.12	MT/AT	R	F	Hatchback Engine Z10XE	GCI60001	Inner Joint		22	28	34.9	57.5	96.5				
	2000.09-	2009.12	MT/AT	R	F	Hatchback Engine Z10XE	GC044043	Outer Joint		22	28	52	97.5	57.5	O			
	2000.09-	2009.12	MT/AT	R	F	Hatchback Engine Z10XE	GDS44075	Drive Shaft	29T	22	22	52	97.5	926				
1.0 (44 kW)	2003.06-	2009.12			F	Hatchback Engine Z10XEP	GC044013	Outer Joint	29T	22	28	52	98	52	O			
	2003.06-	2009.12		L	F	Hatchback Engine Z10XEP	GDS44027	Drive Shaft	29T	22	22	52	98	580				
	2003.06-	2009.12	MT/AT	L	F	Hatchback Engine Z10XEP	GDS44045	Drive Shaft	29T	22	22	52	97	579				
	2003.06-	2009.12		R	F	Hatchback Engine Z10XEP	GDS44026	Drive Shaft	29T	22	22	52	98	930				
	2003.06-	2009.12	MT/AT	R	F	Hatchback Engine Z10XEP	GDS99205	Drive Shaft		22	22	52	97.5	930				
	2003.06-	2009.12	MT/AT	R	F	Hatchback Engine Z10XEP	GCI60001	Inner Joint		22	28	34.9	57.5	96.5				
	2003.06-	2009.12	MT/AT	R	F	Hatchback Engine Z10XEP	GC044043	Outer Joint		22	28	52	97.5	57.5	O			
2003.06-	2009.12	MT/AT	R	F	Hatchback Engine Z10XEP	GDS44075	Drive Shaft	29T	22	22	52	97.5	926					
1.0 12V (43 kW)	2000.09-						GC060001	Outer Joint		22	28	52	97.5	54.5	O			
1.0 12V (44 kW)	2000.09-						GC060001	Outer Joint		22	28	52	97.5	54.5	O			
1.2 (55 kW)	2000.09-	2009.12		R	F	Hatchback Engine Z12XE	GDS99157	Drive Shaft	29T	22	22	52	97.5	930				
	2000.09-	2009.12	MT/AT		F	Hatchback Engine Z12XE	GC044013	Outer Joint	29T	22	28	52	98	52	O			
	2000.09-	2009.12		L	F	Hatchback Engine Z12XE	GDS44027	Drive Shaft	29T	22	22	52	98	580				
	2000.09-	2009.12	MT/AT	L	F	Hatchback Engine Z12XE	GDS44095	Drive Shaft	29T	22	22	52	97	566				
	2000.09-	2009.12	MT/AT	L	F	Hatchback Engine Z12XE	GDS44045	Drive Shaft	29T	22	22	52	97	579				
	2000.09-	2009.12		L	F	Hatchback Engine Z12XE	GDS99069	Drive Shaft	29T	22	22	52	97.5	584				
	2000.09-	2009.12		L/R	F	Hatchback Engine Z12XE	GC044043	Outer Joint		22	28	52	97.5	57.5	O			
	2000.09-	2009.12		R	F	Hatchback Engine Z12XE	GDS44026	Drive Shaft	29T	22	22	52	98	930				
	2000.09-	2009.12	MT/AT	R	F	Hatchback Engine Z12XE	GDS44096	Drive Shaft	29T	22	22	52	97	917				
	2000.09-	2009.12	MT/AT	R	F	Hatchback Engine Z12XE	GDS99205	Drive Shaft		22	22	52	97.5	930				
	2000.09-	2009.12	MT/AT	R	F	Hatchback Engine Z12XE	GCI60001	Inner Joint		22	28	34.9	57.5	96.5				
	2000.09-	2009.12	MT/AT	R	F	Hatchback Engine Z12XE	GC044043	Outer Joint		22	28	52	97.5	57.5	O			
	2000.09-	2009.12	MT/AT	R	F	Hatchback Engine Z12XE	GDS44075	Drive Shaft	29T	22	22	52	97.5	926				
1.2 16V (55 kW)	2000.09-						GC060001	Outer Joint		22	28	52	97.5	54.5	O			
1.2 Twinport (59 kW)	2004.07-	2009.12			F	Hatchback Engine Z12XEP	GC044013	Outer Joint	29T	22	28	52	98	52	O			
	2004.07-	2009.12			F	Hatchback Engine Z12XEP	GC017034	Outer Joint		22	21	51	79.5	54	M			
	2004.07-	2009.12		L	F	Hatchback Engine Z12XEP	GDS44027	Drive Shaft	29T	22	22	52	98	580				
	2004.07-	2009.12		L	F	Hatchback Engine Z12XEP	GDS44045	Drive Shaft	29T	22	22	52	97	579				
	2004.07-	2009.12		L	F	Hatchback Engine Z12XEP	GDS99069	Drive Shaft	29T	22	22	52	97.5	584				
	2004.07-	2009.12		L/R	F	Hatchback Engine Z12XEP	GC044043	Outer Joint		22	28	52	97.5	57.5	O			
	2004.07-	2009.12		R	F	Hatchback Engine Z12XEP	GDS44075	Drive Shaft	29T	22	22	52	97.5	926				
	2004.07-	2009.12		R	F	Hatchback Engine Z12XEP	GDS44026	Drive Shaft	29T	22	22	52	98	930				
	2004.07-	2009.12	MT/AT	R	F	Hatchback Engine Z12XEP	GDS99205	Drive Shaft		22	22	52	97.5	930				
	2004.07-	2009.12	MT/AT	R	F	Hatchback Engine Z12XEP	GCI60001	Inner Joint		22	28	34.9	57.5	96.5				
	2004.07-	2009.12	MT/AT	R	F	Hatchback Engine Z12XEP	GC044043	Outer Joint		22	28	52	97.5	57.5	O			
	2004.07-	2009.12		R	F	Hatchback Engine Z12XEP	GDS99157	Drive Shaft	29T	22	22	52	97.5	930				
	2004.07-							GC060001	Outer Joint		22	28	52	97.5	54.5	O		
1.3 CDTi (51 kW)	2003.08-	2007.01			F	Hatchback Engine Z13DT	GC044020	Outer Joint	29T	22	28	52	97.5	57.5	O			
	2003.08-	2007.01			F	Hatchback Engine Z13DT	GCI44009	Inner Joint		22	23	35	57.5	96				
	2003.08-	2007.01		L	F	Hatchback Engine Z13DT	GDS44045	Drive Shaft	29T	22	22	52	97	579				
	2003.08-	2007.01	MT/AT	L	F	Hatchback Engine Z13DT	GDS44027	Drive Shaft	29T	22	22	52	98	580				
	2003.08-	2007.01		R	F	Hatchback Engine Z13DT	GDS44075	Drive Shaft	29T	22	22	52	97.5	926				
	2003.08-	2007.01	MT/AT	R	F	Hatchback Engine Z13DT	GDS99205	Drive Shaft		22	22	52	97.5	930				
	2003.08-	2007.01	MT/AT	R	F	Hatchback Engine Z13DT	GCI60001	Inner Joint		22	28	34.9	57.5	96.5				
	2003.08-	2007.01	MT/AT	R	F	Hatchback Engine Z13DT	GC044043	Outer Joint		22	28	52	97.5	57.5	O			
2003.08-	2007.01	MT/AT	R	F	Hatchback Engine Z13DT	GDS44026	Drive Shaft	29T	22	22	52	98	930					
1.4 (66 kW)	2000.09-	2009.12			F	Hatchback Engine Z14XE	GC044013	Outer Joint	29T	22	28	52	98	52	O			
	2000.09-	2009.12			F	Hatchback Engine Z14XE	GC044020	Outer Joint	29T	22	28	52	97.5	57.5	O			
	2000.09-	2009.12		L	F	Hatchback Engine Z14XE	GDS44045	Drive Shaft	29T	22	22	52	97	579				
	2000.09-	2009.12	MT/AT	L	F	Hatchback Engine Z14XE	GDS44027	Drive Shaft	29T	22	22	52	98	580				
	2000.09-	2009.12		R	F	Hatchback Engine Z14XE	GDS44075	Drive Shaft	29T	22	22	52	97.5	926				
	2000.09-	2009.12	MT/AT	R	F	Hatchback Engine Z14XE	GDS99205	Drive Shaft		22	22	52	97.5	930				
	2000.09-	2009.12	MT/AT	R	F	Hatchback Engine Z14XE	GCI60001	Inner Joint		22	28	34.9	57.5	96.5				
	2000.09-	2009.12	MT/AT	R	F	Hatchback Engine Z14XE	GC044043	Outer Joint		22	28	52	97.5	57.5	O			
	2000.09-	2009.12	MT/AT	R	F	Hatchback Engine Z14XE	GDS44026	Drive Shaft	29T	22	22	52	98	930				
1.4 16V (66 kW)	2000.09-						GC060001	Outer Joint		22	28	52	97.5	54.5	O			
1.4 Twinport (66 kW)	2003.06-	2009.12			F	Hatchback Engine Z14XEP	GC044013	Outer Joint	29T	22	28	52	98	52	O			
	2003.06-	2009.12		L	F	Hatchback Engine Z14XEP	GDS44045	Drive Shaft	29T	22	22	52	97	579				



		TRANSM	L/R	F/R		G-AP Ref.	PRODUCT	ABS	Technical Specifications															
									YEAR	A	B	C	H	L	P									
<b>OPEL</b>																								
<b>CORSA C (F08, F68)</b>																								
1.4 Twinport (66 kW)	2003.06-	2009.12	MT/AT	L	F	Hatchback Engine Z14XEP	GDS44027	Drive Shaft	29T	22	22	52	98	580										
	2003.06-	2009.12		R	F	Hatchback Engine Z14XEP	GDS44075	Drive Shaft	29T	22	22	52	97.5	926										
	2003.06-	2009.12	MT/AT	R	F	Hatchback Engine Z14XEP	GDS99205	Drive Shaft		22	22	52	97.5	930										
	2003.06-	2009.12	MT/AT	R	F	Hatchback Engine Z14XEP	GCI60001	Inner Joint		22	28	34.9	57.5	96.5										
	2003.06-	2009.12	MT/AT	R	F	Hatchback Engine Z14XEP	GC044043	Outer Joint		22	28	52	97.5	57.5	O									
	2003.06-	2009.12	MT/AT	R	F	Hatchback Engine Z14XEP	GDS44026	Drive Shaft	29T	22	22	52	98	930										
	2003.06-						GC060001	Outer Joint		22	28	52	97.5	54.5	O									
1.7 CDTi (74 kW)	2003.06-						GC044004	Outer Joint	29T	33	24	52	104	64	M									
	2003.08-	2004.12			F	Hatchback Engine Z17DTH	GC044004	Outer Joint	29T	33	24	52	104	64	M									
	2003.08-	2004.12	MT	L	F	Hatchback Engine Z17DTH	GDS44032	Drive Shaft	29T	33	34	52	104	587.5										
	2003.08-	2004.12	MT	L	F	Hatchback Engine Z17DTH	GCI21034	Inner Joint		34	24	35	56.5	102										
	2003.08-	2004.12	MT	L/R	F	Hatchback Engine Z17DTH	GC022005	Outer Joint		33	24	52	104	64	M									
	2003.08-	2004.12	MT	R	F	Hatchback Engine Z17DTH	GDS60021	Drive Shaft	29T	33	34	52	104	612										
	2003.08-	2004.12	MT	R	F	Hatchback Engine Z17DTH	GCI60003	Inner Joint		34	24	35.5	47	70.5										
1.7 Di (48 kW)	2000.09-	2009.12			F	Hatchback Engine Y17DTL	GDS44020	Outer Joint	29T	22	28	52	97.5	57.5	O									
	2000.09-	2009.12		L	F	Hatchback Engine Y17DTL	GDS44045	Drive Shaft	29T	22	22	52	97	579										
	2000.09-	2009.12	MT/AT	L	F	Hatchback Engine Y17DTL	GDS44027	Drive Shaft	29T	22	22	52	98	580										
	2000.09-	2009.12		R	F	Hatchback Engine Y17DTL	GDS44075	Drive Shaft	29T	22	22	52	97.5	926										
	2000.09-	2009.12	MT/AT	R	F	Hatchback Engine Y17DTL	GDS99205	Drive Shaft		22	22	52	97.5	930										
	2000.09-	2009.12	MT/AT	R	F	Hatchback Engine Y17DTL	GCI60001	Inner Joint		22	28	34.9	57.5	96.5										
	2000.09-	2009.12	MT/AT	R	F	Hatchback Engine Y17DTL	GC044043	Outer Joint		22	28	52	97.5	57.5	O									
1.7 DTi (55 kW)	2000.09-	2009.12			F	Hatchback Engine Y17DT	GC044020	Outer Joint	29T	22	28	52	97.5	57.5	O									
	2000.09-	2009.12	MT		F	Hatchback Engine Y17DT	GCI44009	Inner Joint		22	23	35	57.5	96										
	2000.09-	2009.12		L	F	Hatchback Engine Y17DT	GDS44045	Drive Shaft	29T	22	22	52	97	579										
	2000.09-	2009.12	MT/AT	L	F	Hatchback Engine Y17DT	GDS44027	Drive Shaft	29T	22	22	52	98	580										
	2000.09-	2009.12		R	F	Hatchback Engine Y17DT	GDS44075	Drive Shaft	29T	22	22	52	97.5	926										
	2000.09-	2009.12	MT/AT	R	F	Hatchback Engine Y17DT	GDS99205	Drive Shaft		22	22	52	97.5	930										
	2000.09-	2009.12	MT/AT	R	F	Hatchback Engine Y17DT	GCI60001	Inner Joint		22	28	34.9	57.5	96.5										
1.8 (92 kW)	2000.09-	2009.12			F	Hatchback Engine Z18XE	GC044002	Outer Joint	29T	22	23	52	97.5	61	M									
	2000.09-	2009.12			F	Hatchback Engine Z18XE	GCI44009	Inner Joint		22	23	35	57.5	96										
	2000.09-	2009.12		L	F	Hatchback Engine Z18XE	GDS44027	Drive Shaft	29T	22	22	52	98	580										
	2000.09-	2009.12		L	F	Hatchback Engine Z18XE	GDS44045	Drive Shaft	29T	22	22	52	97	579										
	2000.09-	2009.12		R	F	Hatchback Engine Z18XE	GDS44075	Drive Shaft	29T	22	22	52	97.5	926										
	2000.09-	2009.12		R	F	Hatchback Engine Z18XE	GDS44026	Drive Shaft	29T	22	22	52	98	930										
1.8 16V (92 kW)	2000.09-					GC044002	Outer Joint	29T	22	23	52	97.5	61	M										
<b>CORSA C (F08, W5L)</b>																								
1.2 (59 kW)	2005.07-			L	F	Box Engine Z12XEP	GDS44027	Drive Shaft	29T	22	22	52	98	580										
	2005.07-			L	F	Box Engine Z12XEP	GDS44045	Drive Shaft	29T	22	22	52	97	579										
	2005.07-			R	F	Box Engine Z12XEP	GDS44075	Drive Shaft	29T	22	22	52	97.5	926										
	2005.07-			R	F	Box Engine Z12XEP	GDS44026	Drive Shaft	29T	22	22	52	98	930										
	2005.07-			L	F	Box Engine Z12XEP	GDS99069	Drive Shaft	29T	22	22	52	97.5	584										
	2005.07-		L/R	F	Box Engine Z12XEP	GC044043	Outer Joint		22	28	52	97.5	57.5	O										
	2005.07-		MT/AT	R	F	Box Engine Z12XEP	GDS99205	Drive Shaft		22	22	52	97.5	930										
	2005.07-		MT/AT	R	F	Box Engine Z12XEP	GCI60001	Inner Joint		22	28	34.9	57.5	96.5										
	2005.07-		MT/AT	R	F	Box Engine Z12XEP	GC044043	Outer Joint		22	28	52	97.5	57.5	O									
	2005.07-			R	F	Box Engine Z12XEP	GDS99157	Drive Shaft	29T	22	22	52	97.5	930										
1.2 16V (55 kW)	2000.09-		MT/AT	L	F	Box Engine Z12XE	GDS44095	Drive Shaft	29T	22	22	52	97	566										
	2000.09-			L	F	Box Engine Z12XE	GDS99069	Drive Shaft	29T	22	22	52	97.5	584										
	2000.09-			R	F	Box Engine Z12XE	GDS99157	Drive Shaft	29T	22	22	52	97.5	930										
	2000.09-		MT/AT	R	F	Box Engine Z12XE	GCI60001	Inner Joint		22	28	34.9	57.5	96.5										
	2000.09-		MT/AT	R	F	Box Engine Z12XE	GC044043	Outer Joint		22	28	52	97.5	57.5	O									
	2000.09-			L	F	Box Engine Z12XE	GC044043	Outer Joint		22	28	52	97.5	57.5	O									
1.3 CDTi 16V (51 kW)	2005.08-				F	Box Engine Z13DT	GC044020	Outer Joint	29T	22	28	52	97.5	57.5	O									
	2005.08-				F	Box Engine Z13DT	GCI44009	Inner Joint		22	23	35	57.5	96										
	2005.08-			L	F	Box Engine Z13DT	GDS44045	Drive Shaft	29T	22	22	52	97	579										
	2005.08-		MT/AT	L	F	Box Engine Z13DT	GDS44027	Drive Shaft	29T	22	22	52	98	580										
	2005.08-			R	F	Box Engine Z13DT	GDS44075	Drive Shaft	29T	22	22	52	97.5	926										

		TRANSM	L/R	F/R		G-AP Ref.	PRODUCT	ABS	Technical Specifications								
									YEAR	A	B	C	H	L	P		
<b>OPEL</b>																	
<b>CORSA C (F08, W5L)</b>																	
1.3 CDTi 16V (51 kW)	2005.08-		MT/AT	R	F	Box Engine Z13DT	GDS44026	Drive Shaft	29T	22	22	52	98	930			
	2005.08-		MT/AT	R	F	Box Engine Z13DT	GDS99205	Drive Shaft		22	22	52	97.5	930			
	2005.08-		MT/AT	R	F	Box Engine Z13DT	GCI60001	Inner Joint		22	28	34.9	57.5	96.5			
	2005.08-		MT/AT	R	F	Box Engine Z13DT	GC044043	Outer Joint		22	28	52	97.5	57.5	O		
1.7 Di 16V (48 kW)	2000.09-		MT/AT	R	F	Box Engine Y17DTL	GDS99205	Drive Shaft		22	22	52	97.5	930			
	2000.09-		MT/AT	R	F	Box Engine Y17DTL	GCI60001	Inner Joint		22	28	34.9	57.5	96.5			
	2000.09-		MT/AT	R	F	Box Engine Y17DTL	GC044043	Outer Joint		22	28	52	97.5	57.5	O		
1.7 DTi 16V (55 kW)	2000.09-		MT/AT	R	F	Box Engine Y17DT	GDS99205	Drive Shaft		22	22	52	97.5	930			
	2000.09-		MT/AT	R	F	Box Engine Y17DT	GCI60001	Inner Joint		22	28	34.9	57.5	96.5			
	2000.09-		MT/AT	R	F	Box Engine Y17DT	GC044043	Outer Joint		22	28	52	97.5	57.5	O		
<b>CORSA D</b>																	
1.0 (44 kW)	2006.07-2008.03				F	Hatchback Engine Z10XEP	GC017052	Outer Joint		22	21	51.2	79.5	54	M		
	2006.07-2008.03	MT	L	F		Hatchback Engine Z10XEP	GDS60023	Drive Shaft		22	22	51.2	79.5	615			
	2006.07-2008.03	MT	L	F		Hatchback Engine Z10XEP	GDS44079	Drive Shaft		22	22	51	79.5	615			
	2006.07-2008.03	MT	R	F		Hatchback Engine Z10XEP	GDS17044	Drive Shaft		22	22	51.2	79.5	919			
	2006.07-2008.03	MT	R	F		Hatchback Engine Z10XEP	GCI44013	Inner Joint		22	21	35	57.5	93			
	2006.07-2008.03	MT	R	F		Hatchback Engine Z10XEP	GC017052	Outer Joint		22	21	51.2	79.5	54	M		
	2006.07-2008.03	MT	R	F		Hatchback Engine Z10XEP	GDS44078	Drive Shaft		22	22	51	79.5	918			
1.0 (48 kW)	2010.01-			L	F	Hatchback Engine A10XEP	GDS44079	Drive Shaft		22	22	51	79.5	615			
	2010.01-			R	F	Hatchback Engine A10XEP	GDS44078	Drive Shaft		22	22	51	79.5	918			
	2010.01-		MT	L	F	Hatchback Engine A10XEP	GDS60023	Drive Shaft		22	22	51.2	79.5	615			
1.2 (51 kW)	2010.06-		MT	L	F	Hatchback Engine A12XEL	GDS44079	Drive Shaft		22	22	51	79.5	615			
	2010.06-		MT	R	F	Hatchback Engine A12XEL	GDS44078	Drive Shaft		22	22	51	79.5	918			
	2010.06-		MT	L	F	Hatchback Engine A12XEL	GDS60023	Drive Shaft		22	22	51.2	79.5	615			
1.2 (59 kW)	2006.07-2008.03				F	Hatchback Engine Z12XEP	GC017052	Outer Joint		22	21	51.2	79.5	54	M		
	2006.07-2008.03	MT	L	F		Hatchback Engine Z12XEP	GDS60023	Drive Shaft		22	22	51.2	79.5	615			
	2006.07-2008.03	MT	L	F		Hatchback Engine Z12XEP	GDS44079	Drive Shaft		22	22	51	79.5	615			
	2006.07-2008.03	MT	R	F		Hatchback Engine Z12XEP	GDS17044	Drive Shaft		22	22	51.2	79.5	919			
	2006.07-2008.03	MT	R	F		Hatchback Engine Z12XEP	GCI44013	Inner Joint		22	21	35	57.5	93			
	2006.07-2008.03	MT	R	F		Hatchback Engine Z12XEP	GC017052	Outer Joint		22	21	51.2	79.5	54	M		
	2006.07-2008.03	MT	R	F		Hatchback Engine Z12XEP	GDS44078	Drive Shaft		22	22	51	79.5	918			
1.2 (63 kW)	2010.06-		MT	L	F	Hatchback Engine A12XER	GDS44079	Drive Shaft		22	22	51	79.5	615			
	2010.06-		MT	R	F	Hatchback Engine A12XER	GDS44078	Drive Shaft		22	22	51	79.5	918			
	2010.06-		MT	L	F	Hatchback Engine A12XER	GDS60023	Drive Shaft		22	22	51.2	79.5	615			
1.2 LPG (59 kW)	2009.09-		MT	L	F	Hatchback Engine Z12XEP	GDS44079	Drive Shaft		22	22	51	79.5	615			
	2009.09-		MT	R	F	Hatchback Engine Z12XEP	GDS44078	Drive Shaft		22	22	51	79.5	918			
	2009.09-		MT	L	F	Hatchback Engine Z12XEP	GDS60023	Drive Shaft		22	22	51.2	79.5	615			
	2009.09-		MT	R	F	Hatchback Engine Z12XEP	GDS17044	Drive Shaft		22	22	51.2	79.5	919			
	2009.09-		MT	R	F	Hatchback Engine Z12XEP	GCI44013	Inner Joint		22	21	35	57.5	93			
	2009.09-		MT	R	F	Hatchback Engine Z12XEP	GC017052	Outer Joint		22	21	51.2	79.5	54	M		
1.2 LPG (61 kW)	2011.06-		MT	L	F	Hatchback Engine A12XER	GDS60023	Drive Shaft		22	22	51.2	79.5	615			
1.2 LPG (63 kW)	2011.08-			L	F	Hatchback Engine A12XER	GDS44079	Drive Shaft		22	22	51	79.5	615			
	2011.08-		MT	L	F	Hatchback Engine A12XER	GDS60023	Drive Shaft		22	22	51.2	79.5	615			
	2011.08-			L	F	Hatchback Engine A12XER	GDS44079	Drive Shaft		22	22	51	79.5	615			
1.3 CDTi	2006-				F	Engine Z13DTH	GCI44012	Inner Joint		25	23	34.9	56.5	118			
	2006-				F	Engine Z13DTH	GCI44014	Inner Joint		25	23	34.9	57.5	102			
	2006-			R	F	Engine Z13DTJ	GCI44017	Inner Joint		22	23	35	57.5	116			
1.3 CDTi (55 kW)	2006.07-2007.04				F	Hatchback Engine A13DTC/Z13DTJ	GC017053	Outer Joint		25	23	51	84.5	60	M		
	2006.07-2007.04	MT	L	F		Hatchback Engine A13DTC/Z13DTJ	GDS44040	Drive Shaft		25	22	51	84.5	616			
	2006.07-2007.04	MT	R	F		Hatchback Engine A13DTC/Z13DTJ	GDS44042	Drive Shaft		25	22	51	84.5	920			
	2006.07-2007.04	MT	R	F		Hatchback Engine A13DTC/Z13DTJ	GCI44017	Inner Joint		22	23	35	57.5	116			
	2006.07-2007.04	MT	R	F		Hatchback Engine A13DTC/Z13DTJ	GC017053	Outer Joint		25	23	51	84.5	60	M		
1.3 CDTi (66 kW)	2006.07-2008.03				F	Hatchback Engine Z13DTH	GC017053	Outer Joint		25	23	51	84.5	60	M		
	2006.07-2008.03	MT	L	F		Hatchback Engine Z13DTH	GCI44014	Inner Joint		25	23	34.9	57.5	102			
	2006.07-2008.03	MT	L	F		Hatchback Engine Z13DTH	GDS17070	Drive Shaft		25	25	51	84.5	576			
	2006.07-2008.03	MT	R	F		Hatchback Engine Z13DTH	GDS17071	Drive Shaft		25	25	51	84.5	952			
1.3 CDTi (70 kW)	2010.06-				F	Hatchback Engine A13DTR/A13DTE/Z13DTE	GC017053	Outer Joint		25	23	51	84.5	60	M		
1.4 (64 kW)	2009.09-				F	Hatchback Engine A14XEL	GC017052	Outer Joint		22	21	51.2	79.5	54	M		
	2009.09-			L	F	Hatchback Engine A14XEL	GDS44079	Drive Shaft		22	22	51	79.5	615			
	2009.09-			R	F	Hatchback Engine A14XEL	GDS44078	Drive Shaft		22	22	51	79.5	918			









		TRANSM	L/R	F/R		G-AP Ref.	PRODUCT	ABS	Technical Specifications									
									YEAR	A	B	C	H	L	P			
<b>OPEL CORSA D</b>																		
1.4 (64 kW)	2009.09-	MT	L	F	Hatchback Engine A14XEL	GDS60023	Drive Shaft		22	22	51.2	79.5	615					
1.4 (66 kW)	2006.07-		L	F	Hatchback Engine Z14XEP	GDS44079	Drive Shaft		22	22	51	79.5	615					
	2006.07-		R	F	Hatchback Engine Z14XEP	GDS44078	Drive Shaft		22	22	51	79.5	918					
	2006.07-		L	F	Hatchback Engine Z14XEP	GDS60023	Drive Shaft		22	22	51.2	79.5	615					
1.4 (74 kW)	2010.06-			F	Hatchback Engine A14XER	GC017052	Outer Joint		22	21	51.2	79.5	54	M				
	2010.06-	MT	L	F	Hatchback Engine A14XER	GDS44079	Drive Shaft		22	22	51	79.5	615					
	2010.06-	MT	R	F	Hatchback Engine A14XER	GDS44078	Drive Shaft		22	22	51	79.5	918					
	2010.06-	MT	L	F	Hatchback Engine A14XER	GDS60023	Drive Shaft		22	22	51.2	79.5	615					
1.4 LPG (64 kW)	2009.09-		L	F	Hatchback Engine A14XEL	GDS44079	Drive Shaft		22	22	51	79.5	615					
	2009.09-	MT	L	F	Hatchback Engine A14XEL	GDS60023	Drive Shaft		22	22	51.2	79.5	615					
1.4 LPG (66 kW)	2006.07-2008.03			F	Hatchback Engine Z14XEP	GC017052	Outer Joint		22	21	51.2	79.5	54	M				
	2006.07-2008.03	MT	L	F	Hatchback Engine Z14XEP	GDS60023	Drive Shaft		22	22	51.2	79.5	615					
	2006.07-2008.03	MT	L	F	Hatchback Engine Z14XEP	GDS44079	Drive Shaft		22	22	51	79.5	615					
	2006.07-2008.03	MT	R	F	Hatchback Engine Z14XEP	GDS44078	Drive Shaft		22	22	51	79.5	918					
1.6 Turbo (110 kW)	2007.02-	MT	L	F	Hatchback Engine A16LEL/Z16LEL	GDS60025	Drive Shaft		25	25	51	84.5	579.5					
	2007.02-	MT	R	F	Hatchback Engine A16LEL/Z16LEL	GDS60024	Drive Shaft		25	34	51	84.5	608					
	2007.02-				Hatchback Engine A16LEL/Z16LEL	GC060006	Outer Joint		25	35	51	84.5	63	I				
1.6 Turbo (141 kW)	2007.02-			Hatchback Engine A16LER/Z16LER	GC060006	Outer Joint		25	35	51	84.5	63	I					
1.6 Turbo (155 kW)	2011.06-	MT	L	F	Hatchback Engine A16LER/Z16LER	GDS60025	Drive Shaft		25	25	51	84.5	579.5					
	2011.06-	MT	R	F	Hatchback Engine A16LER/Z16LER	GDS60024	Drive Shaft		25	34	51	84.5	608					
	2011.06-				Hatchback Engine A16LER/Z16LER	GC060006	Outer Joint		25	35	51	84.5	63	I				
1.7 CDTi (96 kW)	2010.06-			Hatchback Engine A17DTS	GC060006	Outer Joint		25	35	51	84.5	63	I					
<b>CORSA D VAN</b>																		
1.0 (44 kW)	2006.07-		L	F	Box Engine A10XEP	GDS44079	Drive Shaft		22	22	51	79.5	615					
	2006.07-		R	F	Box Engine A10XEP	GDS44078	Drive Shaft		22	22	51	79.5	918					
	2006.07-	MT	L	F	Box Engine A10XEP	GDS60023	Drive Shaft		22	22	51.2	79.5	615					
	2006.07-		R	F	Box Engine A10XEP	GDS17044	Drive Shaft		22	22	51.2	79.5	919					
	2006.07-		R	F	Box Engine A10XEP	GCI44013	Inner Joint		22	21	35	57.5	93					
	2006.07-		R	F	Box Engine A10XEP	GC017052	Outer Joint		22	21	51.2	79.5	54	M				
1.0 (48 kW)	2010.01-		L	F	Box Engine A10XEP	GDS44079	Drive Shaft		22	22	51	79.5	615					
	2010.01-		R	F	Box Engine A10XEP	GDS44078	Drive Shaft		22	22	51	79.5	918					
	2010.01-	MT	L	F	Box Engine A10XEP	GDS60023	Drive Shaft		22	22	51.2	79.5	615					
1.2 (51 kW)	2010.06-		L	F	Box Engine A12XEL	GDS44079	Drive Shaft		22	22	51	79.5	615					
	2010.06-		R	F	Box Engine A12XEL	GDS44078	Drive Shaft		22	22	51	79.5	918					
	2010.06-	MT	L	F	Box Engine A12XEL	GDS60023	Drive Shaft		22	22	51.2	79.5	615					
1.2 (59 kW)	2009.07-		L	F	Box Engine Z12XEP	GDS44079	Drive Shaft		22	22	51	79.5	615					
	2009.07-		R	F	Box Engine Z12XEP	GDS44078	Drive Shaft		22	22	51	79.5	918					
	2009.07-	MT	L	F	Box Engine Z12XEP	GDS60023	Drive Shaft		22	22	51.2	79.5	615					
	2009.07-		R	F	Box Engine Z12XEP	GDS17044	Drive Shaft		22	22	51.2	79.5	919					
	2009.07-		R	F	Box Engine Z12XEP	GCI44013	Inner Joint		22	21	35	57.5	93					
	2009.07-		R	F	Box Engine Z12XEP	GC017052	Outer Joint		22	21	51.2	79.5	54	M				
1.2 (63 kW)	2010.06-		L	F	Box Engine A12XER	GDS44079	Drive Shaft		22	22	51	79.5	615					
	2010.06-		R	F	Box Engine A12XER	GDS44078	Drive Shaft		22	22	51	79.5	918					
	2010.06-	MT	L	F	Box Engine A12XER	GDS60023	Drive Shaft		22	22	51.2	79.5	615					
1.3 CDTi (55 kW)	2006.07-		L	F	Box Engine A13DTC/Z13DTJ	GDS44040	Drive Shaft		25	22	51	84.5	616					
	2006.07-		R	F	Box Engine A13DTC/Z13DTJ	GDS44042	Drive Shaft		25	22	51	84.5	920					
	2006.07-		R	F	Box Engine A13DTC/Z13DTJ	GCI44017	Inner Joint		22	23	35	57.5	116					
	2006.07-		R	F	Box Engine A13DTC/Z13DTJ	GC017053	Outer Joint		25	23	51	84.5	60	M				
1.3 CDTi (66 kW)	2006.07-		L	F	Box Engine Z13DTH	GDS17070	Drive Shaft		25	25	51	84.5	576					
	2006.07-		R	F	Box Engine Z13DTH	GDS17071	Drive Shaft		25	25	51	84.5	952					
	2006.07-		L	F	Box Engine Z13DTH	GCI44014	Inner Joint		25	23	34.9	57.5	102					
<b>INSIGNIA</b>																		
1.6 (85 kW)	2008.07-			F	Hatchback Engine A16XER	GC021038	Outer Joint		30	24	52	94	64	M				
	2008.07-			F	Saloon Engine A16XER	GC021038	Outer Joint		30	24	52	94	64	M				
1.6 SiDi (125 kW)	2013.03-	MT	R	F	Hatchback Engine A16XHT	GDS60027	Drive Shaft		30	27	52.5	94.5	619					
	2013.03-	MT	R	F	Saloon Engine A16XHT	GDS60027	Drive Shaft		30	27	52.5	94.5	619					
1.6 Turbo (132 kW)	2008.07-	MT		F	Hatchback Engine A16LET	GC017051	Outer Joint		30	26	53.8	94.5	65.5	M				
	2008.07-				Hatchback Engine A16LET	GC099023	Outer Joint		30	26	53.8	94.5	65.5	M				
	2009.01-	MT		F	Saloon Engine A16LET	GC017051	Outer Joint		30	26	53.8	94.5	65.5	M				
	2009.01-				Saloon Engine A16LET	GC099023	Outer Joint		30	26	53.8	94.5	65.5	M				
1.8 (103 kW)	2008.07-			F	Hatchback Engine A18XER	GC021038	Outer Joint		30	24	52	94	64	M				

		TRANSM	L/R	F/R		G-AP Ref.	PRODUCT	ABS	Technical Specifications								
									YEAR	A	B	C	H	L	P		
<b>OPEL INSIGNIA</b>																	
	1.8 (103 kW)	2008.07-			F	Saloon Engine A18XER	GC021038	Outer Joint		30	24	52	94	64	M		
		2008.07-	MT	L	F	Hatchback Engine A18XER	GDS21050	Drive Shaft		30	25	52	94	622			
		2008.07-	MT	R	F	Hatchback Engine A18XER	GDS21054	Drive Shaft		30	25	52	94	1008			
2.0 Biturbo CDTi (140 kW)	2008.07-				F	Hatchback Engine A20DTR	GC099367	Outer Joint		30	27	58.9	94	64.5	M		
	2008.07-				F	Saloon Engine A20DTR	GC099367	Outer Joint		30	27	58.9	94	64.5	M		
2.0 Biturbo CDTi (143 kW)	2012.01-				F	Hatchback Engine A20DTR	GC099367	Outer Joint		30	27	58.9	94	64.5	M		
	2012.01-				F	Saloon Engine A20DTR	GC099367	Outer Joint		30	27	58.9	94	64.5	M		
2.0 Biturbo CDTi 4x4 (140 kW)	2008.07-	MT	L/R	F	Saloon Engine A20DTR	GDS60027	Drive Shaft		30	27	52.5	94.5	619				
	2009.05-	MT	L/R	F	Hatchback Engine A20DTR	GDS60027	Drive Shaft		30	27	52.5	94.5	619				
2.0 Biturbo CDTi 4x4 (143 kW)	2012.01-	MT	L/R	F	Hatchback Engine A20DTR	GDS60027	Drive Shaft		30	27	52.5	94.5	619				
	2012.01-	MT	L/R	F	Saloon Engine A20DTR	GDS60027	Drive Shaft		30	27	52.5	94.5	619				
2.0 CDTi (103 kW )	2013.07-	MT	L/R	F	Hatchback Engine A20DTE	GDS60027	Drive Shaft		30	27	52.5	94.5	619				
	2013.07-	MT	L/R	F	Saloon Engine A20DTE	GDS60027	Drive Shaft		30	27	52.5	94.5	619				
2.0 CDTi (118 kW)	2008.07-	MT/AT		F	Hatchback Engine A20DTH	GC017051	Outer Joint		30	26	53.8	94.5	65.5	M			
	2008.07-	MT/AT		F	Saloon Engine A20DTH	GC017051	Outer Joint		30	26	53.8	94.5	65.5	M			
	2008.07-	MT	L/R	F	Hatchback Engine A20DTH	GDS60027	Drive Shaft		30	27	52.5	94.5	619				
	2008.07-	MT	L/R	F	Saloon Engine A20DTH	GDS60027	Drive Shaft		30	27	52.5	94.5	619				
	2008.07-				Hatchback Engine A20DTH	GC099023	Outer Joint		30	26	53.8	94.5	65.5	M			
	2008.07-				Saloon Engine A20DTH	GC099023	Outer Joint		30	26	53.8	94.5	65.5	M			
2.0 CDTi (120 kW )	2013.07-	MT	L/R	F	Hatchback Engine A20DTH	GDS60027	Drive Shaft		30	27	52.5	94.5	619				
	2013.07-	MT	L/R	F	Saloon Engine A20DTH	GDS60027	Drive Shaft		30	27	52.5	94.5	619				
2.0 CDTi (81 kW)	2008.07-	MT		F	Hatchback Engine A20DTC/A20DTL	GC017051	Outer Joint		30	26	53.8	94.5	65.5	M			
	2008.07-	MT		F	Saloon Engine A20DTC/A20DTL	GC017051	Outer Joint		30	26	53.8	94.5	65.5	M			
	2008.07-		L	F	Hatchback Engine A20DTC/A20DTL	GDS60026	Drive Shaft		30	25	52.5	94.5	631				
	2008.07-		L	F	Saloon Engine A20DTC/A20DTL	GDS60026	Drive Shaft		30	25	52.5	94.5	631				
	2008.07-		R	F	Hatchback Engine A20DTC/A20DTL	GDS60027	Drive Shaft		30	27	52.5	94.5	619				
	2008.07-		R	F	Saloon Engine A20DTC/A20DTL	GDS60027	Drive Shaft		30	27	52.5	94.5	619				
	2008.07-				Hatchback Engine A20DTC/A20DTL	GC099023	Outer Joint		30	26	53.8	94.5	65.5	M			
	2008.07-				Saloon Engine A20DTC/A20DTL	GC099023	Outer Joint		30	26	53.8	94.5	65.5	M			
2.0 CDTi (88 kW )	2012.03-	MT	L/R	F	Hatchback Engine A20DTE	GDS60027	Drive Shaft		30	27	52.5	94.5	619				
	2012.03-	MT	L/R	F	Saloon Engine A20DTE	GDS60027	Drive Shaft		30	27	52.5	94.5	619				
2.0 CDTi (96 kW)	2008.07-	MT/AT		F	Hatchback Engine A20DT/A20DTJ	GC017051	Outer Joint		30	26	53.8	94.5	65.5	M			
	2008.07-	MT/AT		F	Saloon Engine A20DT/A20DTJ	GC017051	Outer Joint		30	26	53.8	94.5	65.5	M			
	2008.07-	MT	L	F	Hatchback Engine A20DT/A20DTJ	GDS60026	Drive Shaft		30	25	52.5	94.5	631				
	2008.07-	MT	L	F	Saloon Engine A20DT/A20DTJ	GDS60026	Drive Shaft		30	25	52.5	94.5	631				
	2008.07-	MT	R	F	Hatchback Engine A20DT/A20DTJ	GDS60027	Drive Shaft		30	27	52.5	94.5	619				
	2008.07-	MT	R	F	Saloon Engine A20DT/A20DTJ	GDS60027	Drive Shaft		30	27	52.5	94.5	619				
	2008.07-				Hatchback Engine A20DT/A20DTJ	GC099023	Outer Joint		30	26	53.8	94.5	65.5	M			
	2008.07-				Saloon Engine A20DT/A20DTJ	GC099023	Outer Joint		30	26	53.8	94.5	65.5	M			
2.0 CDTi 4x4 (118 kW)	2010.06-	MT	L/R	F	Hatchback Engine A20DTH	GDS60027	Drive Shaft		30	27	52.5	94.5	619				
	2010.06-	MT	L/R	F	Saloon Engine A20DTH	GDS60027	Drive Shaft		30	27	52.5	94.5	619				
	2010.06-				Hatchback Engine A20DTH	GC099023	Outer Joint		30	26	53.8	94.5	65.5	M			
2.0 CDTi 4x4 (120 kW)	2013.07-	MT	L/R	F	Saloon Engine A20DTH	GDS60027	Drive Shaft		30	27	52.5	94.5	619				
2.0 E85 Turbo (162 kW)	2010.09-	MT	L/R	F	Hatchback Engine A20NHT	GDS60027	Drive Shaft		30	27	52.5	94.5	619				
	2010.09-				Hatchback Engine A20NHT	GC099023	Outer Joint		30	26	53.8	94.5	65.5	M			
2.0 Turbo (162 kW)	2008.07-	MT/AT		F	Hatchback Engine A20NHT	GC017051	Outer Joint		30	26	53.8	94.5	65.5	M			
	2008.07-	MT/AT		F	Saloon Engine A20NHT	GC017051	Outer Joint		30	26	53.8	94.5	65.5	M			
	2008.07-	MT	L/R	F	Hatchback Engine A20NHT	GDS60027	Drive Shaft		30	27	52.5	94.5	619				
	2008.07-	MT	L/R	F	Saloon Engine A20NHT	GDS60027	Drive Shaft		30	27	52.5	94.5	619				
	2008.07-				Hatchback Engine A20NHT	GC099023	Outer Joint		30	26	53.8	94.5	65.5	M			
	2008.07-				Saloon Engine A20NHT	GC099023	Outer Joint		30	26	53.8	94.5	65.5	M			
2.0 Turbo (184 kW)	2014.04-	MT	L/R	F	Estate Engine A20NHT	GDS60027	Drive Shaft		30	27	52.5	94.5	619				
	2014.04-	MT	L/R	F	Hatchback Engine A20NHT	GDS60027	Drive Shaft		30	27	52.5	94.5	619				
	2014.04-	MT	L/R	F	Saloon Engine A20NHT	GDS60027	Drive Shaft		30	27	52.5	94.5	619				
2.0 Turbo 4x4 (162 kW)	2008.07-	MT	L/R	F	Hatchback Engine A20NHT	GDS60027	Drive Shaft		30	27	52.5	94.5	619				
	2008.07-	MT	L/R	F	Saloon Engine A20NHT	GDS60027	Drive Shaft		30	27	52.5	94.5	619				
	2008.07-				Hatchback Engine A20NHT	GC099023	Outer Joint		30	26	53.8	94.5	65.5	M			
	2008.07-				Saloon Engine A20NHT	GC099023	Outer Joint		30	26	53.8	94.5	65.5	M			
	2008.07-	MT/AT		F	Hatchback Engine A20NHT	GC017051	Outer Joint		30	26	53.8	94.5	65.5	M			
	2008.07-	MT/AT		F	Saloon Engine A20NHT	GC017051	Outer Joint		30	26	53.8	94.5	65.5	M			
2.0 Turbo 4x4 (184 kW)	2011.09-	MT	L/R	F	Hatchback Engine A20NFT	GDS60027	Drive Shaft		30	27	52.5	94.5	619				



		YEAR	TRANSM	L/R	F/R		G-AP Ref.	PRODUCT	ABS	Technical Specifications						
										A	B	C	H	L	P	
<b>OPEL</b>																
<b>INSIGNIA</b>																
2.0 Turbo 4x4 (184 kW)	2011.09-		MT	L/R	F	Saloon Engine A20NFT	GDS60027	Drive Shaft		30	27	52.5	94.5	619		
2.0 Turbo E85 (162 kW)	2008.07-		MT	L/R	F	Saloon Engine A20NHT	GDS60027	Drive Shaft		30	27	52.5	94.5	619		
	2008.07-					Saloon Engine A20NHT	GC099023	Outer Joint		30	26	53.8	94.5	65.5	M	
2.8 V6 Turbo 4x4 (191 kW)	2008.07-				F	Hatchback Engine A28NET	GC099367	Outer Joint		30	27	58.9	94	64.5	M	
	2008.07-				F	Saloon Engine A28NET	GC099367	Outer Joint		30	27	58.9	94	64.5	M	
2.8 V6 Turbo OPC 4x4 (239 kW)	2009.07-				F	Hatchback Engine A28NER	GC099367	Outer Joint		30	27	58.9	94	64.5	M	
	2009.07-				F	Saloon Engine A28NER	GC099367	Outer Joint		30	27	58.9	94	64.5	M	
<b>INSIGNIA SPORTS TOURER</b>																
1.6 (85 kW)	2008.07-				F	Estate Engine A16XER	GC021038	Outer Joint		30	24	52	94	64	M	
1.6 SiDi (125 kW )	2013.03-		MT	R	F	Estate Engine A16XHT	GDS60027	Drive Shaft		30	27	52.5	94.5	619		
1.6 Turbo (132 kW)	2009.01-		MT		F	Estate Engine A16LET	GC017051	Outer Joint		30	26	53.8	94.5	65.5	M	
	2009.01-					Estate Engine A16LET	GC099023	Outer Joint		30	26	53.8	94.5	65.5	M	
1.8 (103 kW)	2008.07-				F	Estate Engine A18XER	GC021038	Outer Joint		30	24	52	94	64	M	
2.0 Biturbo CDTi (140 kW)	2008.07-				F	Estate Engine A20DTR	GC099367	Outer Joint		30	27	58.9	94	64.5	M	
2.0 Biturbo CDTi (143 kW)	2012.01-				F	Estate Engine A20DTR	GC099367	Outer Joint		30	27	58.9	94	64.5	M	
2.0 Biturbo CDTi 4x4 (140 kW)	2008.07-		MT	L/R	F	Estate Engine A20DTR	GDS60027	Drive Shaft		30	27	52.5	94.5	619		
2.0 Biturbo CDTi 4x4 (143 kW)	2012.01-		MT	L/R	F	Estate Engine A20DTR	GDS60027	Drive Shaft		30	27	52.5	94.5	619		
2.0 CDTi (103 kW )	2013.07-		MT	L/R	F	Estate Engine A20DTE	GDS60027	Drive Shaft		30	27	52.5	94.5	619		
2.0 CDTi (118 kW)	2008.07-		MT/AT		F	Estate Engine A20DTH	GC017051	Outer Joint		30	26	53.8	94.5	65.5	M	
	2008.07-		MT	L/R	F	Estate Engine A20DTH	GDS60027	Drive Shaft		30	27	52.5	94.5	619		
	2008.07-					Estate Engine A20DTH	GC099023	Outer Joint		30	26	53.8	94.5	65.5	M	
2.0 CDTi (120 kW )	2013.07-		MT	L/R	F	Estate Engine A20DTH	GDS60027	Drive Shaft		30	27	52.5	94.5	619		
2.0 CDTi (81 kW)	2008.07-		MT		F	Estate Engine A20DTC/A20DTL	GC017051	Outer Joint		30	26	53.8	94.5	65.5	M	
	2008.07-			L	F	Estate Engine A20DTC/A20DTL	GDS60026	Drive Shaft		30	25	52.5	94.5	631		
	2008.07-			R	F	Estate Engine A20DTC/A20DTL	GDS60027	Drive Shaft		30	27	52.5	94.5	619		
	2008.07-					Estate Engine A20DTC/A20DTL	GC099023	Outer Joint		30	26	53.8	94.5	65.5	M	
2.0 CDTi (88 kW )	2012.03-		MT	L/R	F	Estate Engine A20DTE	GDS60027	Drive Shaft		30	27	52.5	94.5	619		
2.0 CDTi (96 kW)	2008.07-		MT/AT		F	Estate Engine A20DT/A20DTJ	GC017051	Outer Joint		30	26	53.8	94.5	65.5	M	
	2008.07-		MT	L	F	Estate Engine A20DT/A20DTJ	GDS60026	Drive Shaft		30	25	52.5	94.5	631		
	2008.07-		MT	R	F	Estate Engine A20DT/A20DTJ	GDS60027	Drive Shaft		30	27	52.5	94.5	619		
	2008.07-					Estate Engine A20DT/A20DTJ	GC099023	Outer Joint		30	26	53.8	94.5	65.5	M	
2.0 CDTi 4x4 (118 kW)	2010.06-		MT	L/R	F	Estate Engine A20DTH	GDS60027	Drive Shaft		30	27	52.5	94.5	619		
2.0 CDTi 4x4 (120 kW)	2013.07-		MT	L/R	F	Saloon Engine K24B	GDS60027	Drive Shaft		30	27	52.5	94.5	619		
2.0 E85 Turbo (162 kW)	2010.09-		MT	L/R	F	Estate Engine A20NHT	GDS60027	Drive Shaft		30	27	52.5	94.5	619		
	2010.09-					Estate Engine A20NHT	GC099023	Outer Joint		30	26	53.8	94.5	65.5	M	
2.0 Turbo (162 kW)	2008.07-		MT/AT		F	Estate Engine A20NHT	GC017051	Outer Joint		30	26	53.8	94.5	65.5	M	
	2008.07-		MT	R	F	Estate Engine A20NHT	GDS60027	Drive Shaft		30	27	52.5	94.5	619		
	2008.07-					Estate Engine A20NHT	GC099023	Outer Joint		30	26	53.8	94.5	65.5	M	
2.0 Turbo 4x4 (162 kW)	2008.07-		MT/AT		F	Estate Engine A20NHT	GC017051	Outer Joint		30	26	53.8	94.5	65.5	M	
	2008.07-		MT	L/R	F	Estate Engine A20NHT	GDS60027	Drive Shaft		30	27	52.5	94.5	619		
	2008.07-				F	Estate Engine A20NHT	GC099023	Outer Joint		30	26	53.8	94.5	65.5	M	
2.0 Turbo 4x4 (184 kW)	2011.09-		MT	L/R	F	Estate Engine A20NFT	GDS60027	Drive Shaft		30	27	52.5	94.5	619		
2.8 V6 Turbo 4x4 (191 kW)	2008.10-				F	Estate Engine A28NET	GC099367	Outer Joint		30	27	58.9	94	64.5	M	
2.8 V6 Turbo OPC 4x4 (239 kW)	2009.07-				F	Estate Engine A28NER	GC099367	Outer Joint		30	27	58.9	94	64.5	M	
<b>KADETT</b>																
-	1981-					DIESEL	GC044047	Outer Joint		33	29	52	109	61	O	
<b>KADETT D (31_-34_, 41_-44_)</b>																
1.2 (39 kW)	1979.08-	1982.07	MT		F	Hatchback Engine 12N	GCI44004	Inner Joint		22	22	34.95	57.5	72.5		
	1979.08-	1982.07	MT		F	Hatchback Engine 12N	GC044041	Outer Joint		22	22	52	95	50	O	
1.2 (40 kW)	1982.08-	1984.08	MT		F	Hatchback Engine 12ST	GCI44004	Inner Joint		22	22	34.95	57.5	72.5		
	1982.08-	1984.08	MT		F	Hatchback Engine 12ST	GC044041	Outer Joint		22	22	52	95	50	O	
1.2 S (44 kW)	1979.08-	1984.08	MT		F	Hatchback Engine 12S	GCI44004	Inner Joint		22	22	34.95	57.5	72.5		
	1979.08-	1984.08	MT		F	Hatchback Engine 12S	GC044041	Outer Joint		22	22	52	95	50	O	
1.3 N (44 kW)	1979.08-	1984.08	MT		F	Hatchback Engine 13N	GCI44004	Inner Joint		22	22	34.95	57.5	72.5		
	1979.08-	1984.08	MT		F	Hatchback Engine 13N	GC044041	Outer Joint		22	22	52	95	50	O	
1.3 S (55 kW)	1979.08-	1984.08	MT		F	Hatchback Engine 13S	GCI44004	Inner Joint		22	22	34.95	57.5	72.5		
	1979.08-	1984.08	MT		F	Hatchback Engine 13S	GC044041	Outer Joint		22	22	52	95	50	O	
1.6 D (40 kW)	1982.03-	1984.08	MT		F	Hatchback Engine 16D	GCI44002	Inner Joint		34	25	35	56.2	85.6		
	1982.03-	1984.08	MT		F	Hatchback Engine 16D	GC099205	Outer Joint		33	25	52	109	61	O	
1.6 S (66 kW)	1981.09-	1984.08	MT		F	Hatchback Engine 16SH	GCI44002	Inner Joint		34	25	35	56.2	85.6		
	1981.09-	1984.08	MT		F	Hatchback Engine 16SH	GC099205	Outer Joint		33	25	52	109	61	O	





		YEAR	TRANSM	L/R	F/R		G-AP Ref.	PRODUCT	ABS	Technical Specifications						
										A	B	C	H	L	P	
<b>OPEL</b>																
<b>KADETT D (31_, 34_, 41_, 44_)</b>																
1.8 GT/E (85 kW)	1983.02-	1984.08	MT		F	Hatchback Engine 18E	GCI44002	Inner Joint		34	25	35	56.2	85.6		
	1983.02-	1984.08	MT		F	Hatchback Engine 18E	GC099205	Outer Joint		33	25	52	109	61	O	
<b>KADETT D (35_, 36_, 45_, 46_)</b>																
1.2 (39 kW)	1979.08-	1982.07	MT		F	Estate Engine 12N	GCI44004	Inner Joint		22	22	34.95	57.5	72.5		
	1979.08-	1982.07	MT		F	Estate Engine 12N	GC044041	Outer Joint		22	22	52	95	50	O	
1.2 S (44 kW)	1979.08-	1984.08	MT		F	Estate Engine 12S	GCI44004	Inner Joint		22	22	34.95	57.5	72.5		
	1979.08-	1984.08	MT		F	Estate Engine 12S	GC044041	Outer Joint		22	22	52	95	50	O	
1.3 N (44 kW)	1979.08-	1984.08	MT		F	Estate Engine 13N	GCI44004	Inner Joint		22	22	34.95	57.5	72.5		
	1979.08-	1984.08	MT		F	Estate Engine 13N	GC044041	Outer Joint		22	22	52	95	50	O	
1.3 S (55 kW)	1979.08-	1984.08	MT		F	Estate Engine 13S	GCI44004	Inner Joint		22	22	34.95	57.5	72.5		
	1979.08-	1984.08	MT		F	Estate Engine 13S	GC044041	Outer Joint		22	22	52	95	50	O	
1.6 D (40 kW)	1982.03-	1984.08	MT		F	Estate Engine 16D	GCI44002	Inner Joint		34	25	35	56.2	85.6		
	1982.03-	1984.08	MT		F	Estate Engine 16D	GC099205	Outer Joint		33	25	52	109	61	O	
1.6 S (66 kW)	1981.09-	1984.08	MT		F	Estate Engine 16SH	GCI44002	Inner Joint		34	25	35	56.2	85.6		
	1981.09-	1984.08	MT		F	Estate Engine 16SH	GC099205	Outer Joint		33	25	52	109	61	O	
<b>KADETT E (33_, 34_, 43_, 44_)</b>																
1.2 (40 kW)	1984.09-	1986.07	MT		F	Hatchback Engine 12SC	GCI44004	Inner Joint		22	22	34.95	57.5	72.5		
	1984.09-	1986.07	MT		F	Hatchback Engine 12SC	GC044041	Outer Joint		22	22	52	95	50	O	
	1984.09-	1986.07	MT		F	Hatchback Engine 12SC	GC044051	Outer Joint	29T	22	22	52	95	50.5	O	
1.3 i CAT (44 kW)	1985.09-	1991.08	MT		F	Hatchback Engine C13N	GCI44004	Inner Joint		22	22	34.95	57.5	72.5		
	1985.09-	1991.08	MT/AT		F	Hatchback Engine C13N	GC044041	Outer Joint		22	22	52	95	50	O	
	1985.09-	1991.08	MT		F	Hatchback Engine C13N	GC044051	Outer Joint	29T	22	22	52	95	50.5	O	
1.3 N (44 kW)	1984.09-	1991.08	MT		F	Hatchback Engine 13N/13NB	GCI44004	Inner Joint		22	22	34.95	57.5	72.5		
	1984.09-	1991.08	MT/AT		F	Hatchback Engine 13N/13NB	GC044041	Outer Joint		22	22	52	95	50	O	
	1984.09-	1991.08	MT		F	Hatchback Engine 13N/13NB	GC044051	Outer Joint	29T	22	22	52	95	50.5	O	
1.3 S (55 kW)	1984.09-	1987.08	MT		F	Hatchback Engine 13S	GCI44004	Inner Joint		22	22	34.95	57.5	72.5		
	1984.09-	1987.08	MT/AT		F	Hatchback Engine 13S	GC044041	Outer Joint		22	22	52	95	50	O	
	1984.09-	1987.08	MT		F	Hatchback Engine 13S	GC044051	Outer Joint	29T	22	22	52	95	50.5	O	
1.4 i (44 kW)	1990.01-	1991.08	MT		F	Hatchback Engine C14NZ	GCI44004	Inner Joint		22	22	34.95	57.5	72.5		
	1990.01-	1991.08	MT		F	Hatchback Engine C14NZ	GC044041	Outer Joint		22	22	52	95	50	O	
	1990.01-	1991.08	MT		F	Hatchback Engine C14NZ	GC044051	Outer Joint	29T	22	22	52	95	50.5	O	
1.4 S (55 kW)	1990.01-	1991.08	MT		F	Hatchback Engine 14NV	GCI44004	Inner Joint		22	22	34.95	57.5	72.5		
	1990.01-	1991.08	MT		F	Hatchback Engine 14NV	GC044041	Outer Joint		22	22	52	95	50	O	
	1990.01-	1991.08	MT		F	Hatchback Engine 14NV	GC044051	Outer Joint	29T	22	22	52	95	50.5	O	
1.6 D (40 kW)	1984.09-	1989.01	MT		F	Hatchback Engine 16D/16DA	GCI44004	Inner Joint		22	22	34.95	57.5	72.5		
	1984.09-	1989.01	MT		F	Hatchback Engine 16D/16DA	GCI44001	Inner Joint		34	22	35	56.2	76		
	1984.09-	1989.01	MT		F	Hatchback Engine 16D/16DA	GC044056	Outer Joint	29T	33	25	52	109	61	O	
	1984.09-	1989.01	MT		F	Hatchback Engine 16D/16DA	GC099205	Outer Joint		33	25	52	109	61	O	
	1984.09-	1989.01	MT		F	Hatchback Engine 16D/16DA	GC044057	Outer Joint	43T	33	25	52	109	61	O	
1.6 i (55 kW)	1986.09-	1991.08	MT		F	Hatchback Engine E16NZ	GCI44004	Inner Joint		22	22	34.95	57.5	72.5		
	1986.09-	1991.08	MT/AT		F	Hatchback Engine E16NZ	GC044041	Outer Joint		22	22	52	95	50	O	
	1986.09-	1991.08	MT		F	Hatchback Engine E16NZ	GC044051	Outer Joint	29T	22	22	52	95	50.5	O	
	1986.09-	1991.08	AT		F	Hatchback Engine E16NZ	GC044057	Outer Joint	43T	33	25	52	109	61	O	
1.6 i CAT (55 kW)	1986.09-	1991.08	MT		F	Hatchback Engine C16LZ/C16NZ	GCI44004	Inner Joint		22	22	34.95	57.5	72.5		
	1986.09-	1991.08	MT/AT		F	Hatchback Engine C16LZ/C16NZ	GC044041	Outer Joint		22	22	52	95	50	O	
	1986.09-	1991.08	MT		F	Hatchback Engine C16LZ/C16NZ	GC044051	Outer Joint	29T	22	22	52	95	50.5	O	
	1986.09-	1991.08	AT		F	Hatchback Engine C16LZ/C16NZ	GC044057	Outer Joint	43T	33	25	52	109	61	O	
1.6 S (60 kW)	1986.09-	1991.08	MT		F	Hatchback Engine 16SV	GCI44001	Inner Joint		34	22	35	56.2	76		
	1986.09-	1991.08	MT		F	Hatchback Engine 16SV	GC099205	Outer Joint		33	25	52	109	61	O	
1.6 S (66 kW)	1984.09-	1986.08	MT		F	Hatchback Engine 16SH	GCI44001	Inner Joint		34	22	35	56.2	76		
	1984.09-	1986.08	MT		F	Hatchback Engine 16SH	GC099205	Outer Joint		33	25	52	109	61	O	
1.7 D (42 kW)	1989.02-	1991.08	MT		F	Hatchback Engine 17D	GC044056	Outer Joint	29T	33	25	52	109	61	O	
	1989.02-	1991.08	MT		F	Hatchback Engine 17D	GCI44002	Inner Joint		34	25	35	56.2	85.6		
	1989.02-	1991.08	MT		F	Hatchback Engine 17D	GC099205	Outer Joint		33	25	52	109	61	O	
	1989.02-	1991.08	MT		F	Hatchback Engine 17D	GC044057	Outer Joint	43T	33	25	52	109	61	O	
1.8 E (74 kW)	1985.10-	1986.08	MT		F	Hatchback Engine C18NE	GC044056	Outer Joint	29T	33	25	52	109	61	O	
	1985.10-	1986.08	MT		F	Hatchback Engine C18NE	GCI44002	Inner Joint		34	25	35	56.2	85.6		
	1985.10-	1986.08	MT		F	Hatchback Engine C18NE	GC099205	Outer Joint		33	25	52	109	61	O	
	1985.10-	1986.08	MT		F	Hatchback Engine C18NE	GC044057	Outer Joint	43T	33	25	52	109	61	O	
1.8 GSi (85 kW)	1984.09-	1986.08	MT		F	Hatchback Engine 18E	GC044056	Outer Joint	29T	33	25	52	109	61	O	
	1984.09-	1986.08	MT		F	Hatchback Engine 18E	GCI44002	Inner Joint		34	25	35	56.2	85.6		



		TRANSM	L/R	F/R		G-AP Ref.	PRODUCT	ABS	Technical Specifications						
									YEAR	A	B	C	H	L	P
<b>OPEL</b>															
<b>KADETT E (33_, 34_, 43_, 44_)</b>															
1.8 GSi (85 kW)	1984.09-	1986.08	MT		F	Hatchback Engine 18E	GC099205	Outer Joint		33	25	52	109	61	O
	1984.09-	1986.08	MT		F	Hatchback Engine 18E	GC044057	Outer Joint	43T	33	25	52	109	61	O
1.8 i (66 kW)	1985.06-	1991.08	MT		F	Hatchback Engine S18NV/C18NZ/C18NT	GC044056	Outer Joint	29T	33	25	52	109	61	O
	1985.06-	1991.08	MT		F	Hatchback Engine S18NV/C18NZ/C18NT	GCI44002	Inner Joint		34	25	35	56.2	85.6	
	1985.06-	1991.08	MT		F	Hatchback Engine S18NV/C18NZ/C18NT	GC099205	Outer Joint		33	25	52	109	61	O
	1985.06-	1991.08	MT		F	Hatchback Engine S18NV/C18NZ/C18NT	GC044057	Outer Joint	43T	33	25	52	109	61	O
1.8 S (62 kW)	1987.09-	1991.08	MT		F	Hatchback Engine E18NV/S18NV	GC044056	Outer Joint	29T	33	25	52	109	61	O
	1987.09-	1991.08	MT		F	Hatchback Engine E18NV/S18NV	GCI44002	Inner Joint		34	25	35	56.2	85.6	
	1987.09-	1991.08	MT		F	Hatchback Engine E18NV/S18NV	GC099205	Outer Joint		33	25	52	109	61	O
	1987.09-	1991.08	MT		F	Hatchback Engine E18NV/S18NV	GC044057	Outer Joint	43T	33	25	52	109	61	O
2.0 GSi (85 kW)	1986.09-	1991.08	MT		F	Hatchback Engine 20NE	GC044056	Outer Joint	29T	33	25	52	109	61	O
	1986.09-	1991.08	MT		F	Hatchback Engine 20NE	GCI44002	Inner Joint		34	25	35	56.2	85.6	
	1986.09-	1991.08	MT		F	Hatchback Engine 20NE	GC099205	Outer Joint		33	25	52	109	61	O
	1986.09-	1991.08	MT		F	Hatchback Engine 20NE	GC044057	Outer Joint	43T	33	25	52	109	61	O
2.0 GSi (95 kW)	1986.09-	1991.08	MT		F	Hatchback Engine 20SEH	GC044056	Outer Joint	29T	33	25	52	109	61	O
	1986.09-	1991.08	MT		F	Hatchback Engine 20SEH	GCI44002	Inner Joint		34	25	35	56.2	85.6	
	1986.09-	1991.08	MT		F	Hatchback Engine 20SEH	GC099205	Outer Joint		33	25	52	109	61	O
	1986.09-	1991.08	MT		F	Hatchback Engine 20SEH	GC044057	Outer Joint	43T	33	25	52	109	61	O
2.0 GSi 16V (110 kW)	1988.03-	1991.08	MT		F	Hatchback Engine 20XEJ	GC044056	Outer Joint	29T	33	25	52	109	61	O
	1988.03-	1991.08	MT		F	Hatchback Engine 20XEJ	GCI44002	Inner Joint		34	25	35	56.2	85.6	
	1988.03-	1991.08	MT		F	Hatchback Engine 20XEJ	GC099205	Outer Joint		33	25	52	109	61	O
	1988.03-	1991.08	MT		F	Hatchback Engine 20XEJ	GC044057	Outer Joint	43T	33	25	52	109	61	O
2.0 GSi 16V CAT (110 kW)	1988.03-	1991.08	MT		F	Hatchback Engine C20XE	GC044056	Outer Joint	29T	33	25	52	109	61	O
	1988.03-	1991.08	MT		F	Hatchback Engine C20XE	GCI44002	Inner Joint		34	25	35	56.2	85.6	
	1988.03-	1991.08	MT		F	Hatchback Engine C20XE	GC099205	Outer Joint		33	25	52	109	61	O
	1988.03-	1991.08	MT		F	Hatchback Engine C20XE	GC044057	Outer Joint	43T	33	25	52	109	61	O
2.0 GSi CAT (85 kW)	1986.09-	1991.08	MT		F	Hatchback Engine C20NE	GC044056	Outer Joint	29T	33	25	52	109	61	O
	1986.09-	1991.08	MT		F	Hatchback Engine C20NE	GCI44002	Inner Joint		34	25	35	56.2	85.6	
	1986.09-	1991.08	MT		F	Hatchback Engine C20NE	GC099205	Outer Joint		33	25	52	109	61	O
	1986.09-	1991.08	MT		F	Hatchback Engine C20NE	GC044057	Outer Joint	43T	33	25	52	109	61	O
<b>KADETT E (35_, 36_, 45_, 46_)</b>															
1.2 (40 kW)	1984.09-	1986.07	MT		F	Estate Engine 12SC	GCI44004	Inner Joint		22	22	34.95	57.5	72.5	
	1984.09-	1986.07	MT		F	Estate Engine 12SC	GC044041	Outer Joint		22	22	52	95	50	O
	1984.09-	1986.07	MT		F	Estate Engine 12SC	GC044051	Outer Joint	29T	22	22	52	95	50.5	O
1.3 i CAT (44 kW)	1985.09-	1991.08	MT		F	Estate Engine C13N	GCI44004	Inner Joint		22	22	34.95	57.5	72.5	
	1985.09-	1991.08	MT/AT		F	Estate Engine C13N	GC044041	Outer Joint		22	22	52	95	50	O
	1985.09-	1991.08	MT		F	Estate Engine C13N	GC044051	Outer Joint	29T	22	22	52	95	50.5	O
1.3 N (44 kW)	1984.09-	1991.08	MT		F	Estate Engine 13N	GCI44004	Inner Joint		22	22	34.95	57.5	72.5	
	1984.09-	1991.08	MT/AT		F	Estate Engine 13N	GC044041	Outer Joint		22	22	52	95	50	O
	1984.09-	1991.08	MT		F	Estate Engine 13N	GC044051	Outer Joint	29T	22	22	52	95	50.5	O
1.3 S (55 kW)	1984.09-	1987.08	MT		F	Estate Engine 13S	GCI44004	Inner Joint		22	22	34.95	57.5	72.5	
	1984.09-	1987.08	MT/AT		F	Estate Engine 13S	GC044041	Outer Joint		22	22	52	95	50	O
	1984.09-	1987.08	MT		F	Estate Engine 13S	GC044051	Outer Joint	29T	22	22	52	95	50.5	O
1.4 i (44 kW)	1990.01-	1991.08	MT		F	Estate Engine C14NZ	GCI44004	Inner Joint		22	22	34.95	57.5	72.5	
	1990.01-	1991.08	MT		F	Estate Engine C14NZ	GC044041	Outer Joint		22	22	52	95	50	O
	1990.01-	1991.08	MT		F	Estate Engine C14NZ	GC044051	Outer Joint	29T	22	22	52	95	50.5	O
1.4 S (55 kW)	1990.01-	1991.08	MT		F	Estate Engine 14NV	GCI44004	Inner Joint		22	22	34.95	57.5	72.5	
	1990.01-	1991.08	MT		F	Estate Engine 14NV	GC044041	Outer Joint		22	22	52	95	50	O
	1990.01-	1991.08	MT		F	Estate Engine 14NV	GC044051	Outer Joint	29T	22	22	52	95	50.5	O
1.5 TD (53 kW)	1988.07-	1991.08	MT		F	Estate Engine 15DT(T4EC1)	GC099205	Outer Joint		33	25	52	109	61	O
1.6 (60 kW)	1986.09-	1991.08	MT		F	Estate Engine 16SV	GC099205	Outer Joint		33	25	52	109	61	O
	1986.09-	1991.08	MT		F	Estate Engine 16SV	GCI44001	Inner Joint		34	22	35	56.2	76	
1.6 D (40 kW)	1984.09-	1989.01	MT		F	Estate Engine 16D/16DA	GC099205	Outer Joint		33	25	52	109	61	O
	1984.09-	1989.01	MT		F	Estate Engine 16D/16DA	GCI44004	Inner Joint		22	22	34.95	57.5	72.5	
	1984.09-	1989.01	MT		F	Estate Engine 16D/16DA	GCI44001	Inner Joint		34	22	35	56.2	76	
	1984.09-	1989.01	MT		F	Estate Engine 16D/16DA	GC044056	Outer Joint	29T	33	25	52	109	61	O
	1984.09-	1989.01	MT		F	Estate Engine 16D/16DA	GC044057	Outer Joint	43T	33	25	52	109	61	O
1.6 i (55 kW)	1986.09-	1991.08	MT		F	Estate Engine E16NZ	GCI44004	Inner Joint		22	22	34.95	57.5	72.5	
	1986.09-	1991.08	MT/AT		F	Estate Engine E16NZ	GC044041	Outer Joint		22	22	52	95	50	O
	1986.09-	1991.08	MT		F	Estate Engine E16NZ	GC044051	Outer Joint	29T	22	22	52	95	50.5	O
	1986.09-	1991.08	AT		F	Estate Engine E16NZ	GC044057	Outer Joint	43T	33	25	52	109	61	O





		TRANSM	L/R	F/R		G-AP Ref.	PRODUCT	ABS	Technical Specifications					
									YEAR	A	B	C	H	L
<b>OPEL</b>														
<b>KADETT E (35_, 36_, 45_, 46_)</b>														
1.6 i CAT (55 kW)	1986.09-1991.08	MT		F	Estate Engine C16LZ/C16NZ	GCI44004	Inner Joint		22	22	34.95	57.5	72.5	
	1986.09-1991.08	MT/AT		F	Estate Engine C16LZ/C16NZ	GC044041	Outer Joint		22	22	52	95	50	O
	1986.09-1991.08	MT		F	Estate Engine C16LZ/C16NZ	GC044051	Outer Joint	29T	22	22	52	95	50.5	O
	1986.09-1991.08	AT		F	Estate Engine C16LZ/C16NZ	GC044057	Outer Joint	43T	33	25	52	109	61	O
1.6 S (66 kW)	1984.09-1986.08	MT		F	Estate Engine 16SH	GC099205	Outer Joint		33	25	52	109	61	O
	1984.09-1986.08	MT		F	Estate Engine 16SH	GCI44001	Inner Joint		34	22	35	56.2	76	
1.7 D (42 kW)	1989.02-1991.08	MT		F	Estate Engine 17D	GC099205	Outer Joint		33	25	52	109	61	O
	1989.02-1991.08	MT		F	Estate Engine 17D	GC044056	Outer Joint	29T	33	25	52	109	61	O
	1989.02-1991.08	MT		F	Estate Engine 17D	GCI44002	Inner Joint		34	25	35	56.2	85.6	
	1989.02-1991.08	MT		F	Estate Engine 17D	GC044057	Outer Joint	43T	33	25	52	109	61	O
1.8 E (74 kW)	1985.10-1986.08	MT		F	Estate Engine C18NE	GC099205	Outer Joint		33	25	52	109	61	O
	1985.10-1986.08	MT		F	Estate Engine C18NE	GC044056	Outer Joint	29T	33	25	52	109	61	O
	1985.10-1986.08	MT		F	Estate Engine C18NE	GCI44002	Inner Joint		34	25	35	56.2	85.6	
	1985.10-1986.08	MT		F	Estate Engine C18NE	GC044057	Outer Joint	43T	33	25	52	109	61	O
1.8 i (66 kW)	1985.06-1991.08	MT		F	Estate Engine C18NT/C18NZ	GC099205	Outer Joint		33	25	52	109	61	O
	1985.06-1991.08	MT		F	Estate Engine C18NT/C18NZ	GC044056	Outer Joint	29T	33	25	52	109	61	O
	1985.06-1991.08	MT		F	Estate Engine C18NT/C18NZ	GCI44002	Inner Joint		34	25	35	56.2	85.6	
	1985.06-1991.08	MT		F	Estate Engine C18NT/C18NZ	GC044057	Outer Joint	43T	33	25	52	109	61	O
1.8 i (85 kW)	1984.09-1986.08	MT		F	Estate Engine 18E	GC099205	Outer Joint		33	25	52	109	61	O
	1984.09-1986.08	MT		F	Estate Engine 18E	GC044056	Outer Joint	29T	33	25	52	109	61	O
	1984.09-1986.08	MT		F	Estate Engine 18E	GCI44002	Inner Joint		34	25	35	56.2	85.6	
	1984.09-1986.08	MT		F	Estate Engine 18E	GC044057	Outer Joint	43T	33	25	52	109	61	O
1.8 S (62 kW)	1987.09-1991.08	MT		F	Estate Engine E18NV	GC099205	Outer Joint		33	25	52	109	61	O
	1987.09-1991.08	MT		F	Estate Engine E18NV	GC044056	Outer Joint	29T	33	25	52	109	61	O
	1987.09-1991.08	MT		F	Estate Engine E18NV	GCI44002	Inner Joint		34	25	35	56.2	85.6	
	1987.09-1991.08	MT		F	Estate Engine E18NV	GC044057	Outer Joint	43T	33	25	52	109	61	O
2.0 i (85 kW)	1987.09-1991.08	MT		F	Estate Engine 20NE	GC099205	Outer Joint		33	25	52	109	61	O
	1987.09-1991.08	MT		F	Estate Engine 20NE	GC044056	Outer Joint	29T	33	25	52	109	61	O
	1987.09-1991.08	MT		F	Estate Engine 20NE	GCI44002	Inner Joint		34	25	35	56.2	85.6	
	1987.09-1991.08	MT		F	Estate Engine 20NE	GC044057	Outer Joint	43T	33	25	52	109	61	O
2.0 i CAT (85 kW)	1987.09-1991.08	MT		F	Estate Engine C20NE	GC099205	Outer Joint		33	25	52	109	61	O
	1987.09-1991.08	MT		F	Estate Engine C20NE	GC044056	Outer Joint	29T	33	25	52	109	61	O
	1987.09-1991.08	MT		F	Estate Engine C20NE	GC044057	Outer Joint	43T	33	25	52	109	61	O
	1987.09-1991.08	MT		F	Estate Engine C20NE	GCI44002	Inner Joint		34	25	35	56.2	85.6	
<b>KADETT E (37_, 47_)</b>														
1.2 (40 kW)	1984.09-1986.07	MT		F	Box Engine 12SC	GCI44004	Inner Joint		22	22	34.95	57.5	72.5	
	1984.09-1986.07	MT		F	Box Engine 12SC	GC044041	Outer Joint		22	22	52	95	50	O
	1984.09-1986.07	MT		F	Box Engine 12SC	GC044051	Outer Joint	29T	22	22	52	95	50.5	O
1.3 N (44 kW)	1984.09-1989.07	MT		F	Box Engine 13N/13NB	GCI44004	Inner Joint		22	22	34.95	57.5	72.5	
	1984.09-1989.07	MT/AT		F	Box Engine 13N/13NB	GC044041	Outer Joint		22	22	52	95	50	O
	1984.09-1989.07	MT		F	Box Engine 13N/13NB	GC044051	Outer Joint	29T	22	22	52	95	50.5	O
1.4 i (44 kW)	1990.01-1991.08	MT		F	Box Engine C14NZ	GCI44004	Inner Joint		22	22	34.95	57.5	72.5	
	1990.01-1991.08	MT		F	Box Engine C14NZ	GC044041	Outer Joint		22	22	52	95	50	O
	1990.01-1991.08	MT		F	Box Engine C14NZ	GC044051	Outer Joint	29T	22	22	52	95	50.5	O
1.6 D (40 kW)	1984.08-1988.08	MT		F	Box Engine 16D/16DA	GC044057	Outer Joint	43T	33	25	52	109	61	O
	1984.08-1988.08	MT		F	Box Engine 16D/16DA	GC099205	Outer Joint		33	25	52	109	61	O
	1984.08-1988.08	MT		F	Box Engine 16D/16DA	GCI44004	Inner Joint		22	22	34.95	57.5	72.5	
	1984.08-1988.08	MT		F	Box Engine 16D/16DA	GCI44001	Inner Joint		34	22	35	56.2	76	
	1984.08-1988.08	MT		F	Box Engine 16D/16DA	GC044056	Outer Joint	29T	33	25	52	109	61	O
1.6 i (55 kW)	1989.08-1993.09	AT		F	Box Engine C16NZ	GC044057	Outer Joint	43T	33	25	52	109	61	O
	1989.08-1993.09	MT		F	Box Engine C16NZ	GCI44004	Inner Joint		22	22	34.95	57.5	72.5	
	1989.08-1993.09	MT/AT		F	Box Engine C16NZ	GC044041	Outer Joint		22	22	52	95	50	O
	1989.08-1993.09	MT		F	Box Engine C16NZ	GC044051	Outer Joint	29T	22	22	52	95	50.5	O
1.7 D (42 kW)	1988.08-1992.09	MT		F	Box Engine 17D	GC044057	Outer Joint	43T	33	25	52	109	61	O
	1988.08-1992.09	MT		F	Box Engine 17D	GC099205	Outer Joint		33	25	52	109	61	O
	1988.08-1992.09	MT		F	Box Engine 17D	GC044056	Outer Joint	29T	33	25	52	109	61	O
	1988.08-1992.09	MT		F	Box Engine 17D	GCI44002	Inner Joint		34	25	35	56.2	85.6	
1.8 i (66 kW)	1984.08-1992.09	MT		F	Box Engine C18NT	GC044057	Outer Joint	43T	33	25	52	109	61	O
	1984.08-1992.09	MT		F	Box Engine C18NT	GC099205	Outer Joint		33	25	52	109	61	O
	1984.08-1992.09	MT		F	Box Engine C18NT	GC044056	Outer Joint	29T	33	25	52	109	61	O
	1984.08-1992.09	MT		F	Box Engine C18NT	GCI44002	Inner Joint		34	25	35	56.2	85.6	









		TRANSM	L/R	F/R		G-AP Ref.	PRODUCT	ABS	Technical Specifications										
									YEAR	A	B	C	H	L	P				
<b>OPEL</b>																			
<b>KADETT E (39_, 49_)</b>																			
1.2 (40 kW)	1984.09-	1986.07	MT		F	Saloon Engine 12SC	GCI44004	Inner Joint		22	22	34.95	57.5	72.5					
	1984.09-	1986.07	MT		F	Saloon Engine 12SC	GC044041	Outer Joint		22	22	52	95	50	O				
	1984.09-	1986.07	MT		F	Saloon Engine 12SC	GC044051	Outer Joint	29T	22	22	52	95	50.5	O				
1.3 i CAT (44 kW)	1985.09-	1991.08	MT		F	Saloon Engine C13N	GCI44004	Inner Joint		22	22	34.95	57.5	72.5					
	1985.09-	1991.08	MT/AT		F	Saloon Engine C13N	GC044041	Outer Joint		22	22	52	95	50	O				
	1985.09-	1991.08	MT		F	Saloon Engine C13N	GC044051	Outer Joint	29T	22	22	52	95	50.5	O				
1.3 N (44 kW)	1984.09-	1989.08	MT		F	Saloon Engine 13N/13NB	GCI44004	Inner Joint		22	22	34.95	57.5	72.5					
	1984.09-	1989.08	MT/AT		F	Saloon Engine 13N/13NB	GC044041	Outer Joint		22	22	52	95	50	O				
	1984.09-	1989.08	MT		F	Saloon Engine 13N/13NB	GC044051	Outer Joint	29T	22	22	52	95	50.5	O				
1.3 S (55 kW)	1984.09-	1987.08	MT		F	Saloon Engine 13S	GCI44004	Inner Joint		22	22	34.95	57.5	72.5					
	1984.09-	1987.08	MT/AT		F	Saloon Engine 13S	GC044041	Outer Joint		22	22	52	95	50	O				
	1984.09-	1987.08	MT		F	Saloon Engine 13S	GC044051	Outer Joint	29T	22	22	52	95	50.5	O				
1.4 i (44 kW)	1990.01-	1991.08	MT		F	Saloon Engine C14NZ	GCI44004	Inner Joint		22	22	34.95	57.5	72.5					
	1990.01-	1991.08	MT		F	Saloon Engine C14NZ	GC044041	Outer Joint		22	22	52	95	50	O				
	1990.01-	1991.08	MT		F	Saloon Engine C14NZ	GC044051	Outer Joint	29T	22	22	52	95	50.5	O				
1.4 S (55 kW)	1990.01-	1991.08	MT		F	Saloon Engine 14NV	GCI44004	Inner Joint		22	22	34.95	57.5	72.5					
	1990.01-	1991.08	MT		F	Saloon Engine 14NV	GC044041	Outer Joint		22	22	52	95	50	O				
	1990.01-	1991.08	MT		F	Saloon Engine 14NV	GC044051	Outer Joint	29T	22	22	52	95	50.5	O				
1.6 D (40 kW)	1984.09-	1989.01	MT		F	Saloon Engine 16D/16DA	GC044057	Outer Joint	43T	33	25	52	109	61	O				
	1984.09-	1989.01	MT		F	Saloon Engine 16D/16DA	GC099205	Outer Joint		33	25	52	109	61	O				
	1984.09-	1989.01	MT		F	Saloon Engine 16D/16DA	GCI44004	Inner Joint		22	22	34.95	57.5	72.5					
	1984.09-	1989.01	MT		F	Saloon Engine 16D/16DA	GCI44001	Inner Joint		34	22	35	56.2	76					
	1984.09-	1989.01	MT		F	Saloon Engine 16D/16DA	GC044056	Outer Joint	29T	33	25	52	109	61	O				
1.6 i (55 kW)	1986.09-	1991.08	AT		F	Saloon Engine E16NZ	GC044057	Outer Joint	43T	33	25	52	109	61	O				
	1986.09-	1991.08	MT		F	Saloon Engine E16NZ	GCI44004	Inner Joint		22	22	34.95	57.5	72.5					
	1986.09-	1991.08	MT/AT		F	Saloon Engine E16NZ	GC044041	Outer Joint		22	22	52	95	50	O				
	1986.09-	1991.08	MT		F	Saloon Engine E16NZ	GC044051	Outer Joint	29T	22	22	52	95	50.5	O				
1.6 i CAT (55 kW)	1986.09-	1991.08	AT		F	Saloon Engine C16LZ/C16NZ	GC044057	Outer Joint	43T	33	25	52	109	61	O				
	1986.09-	1991.08	MT		F	Saloon Engine C16LZ/C16NZ	GCI44004	Inner Joint		22	22	34.95	57.5	72.5					
	1986.09-	1991.08	MT/AT		F	Saloon Engine C16LZ/C16NZ	GC044041	Outer Joint		22	22	52	95	50	O				
	1986.09-	1991.08	MT		F	Saloon Engine C16LZ/C16NZ	GC044051	Outer Joint	29T	22	22	52	95	50.5	O				
1.6 S (60 kW)	1986.09-	1991.08	MT		F	Saloon Engine 16SV	GC099205	Outer Joint		33	25	52	109	61	O				
	1986.09-	1991.08	MT		F	Saloon Engine 16SV	GCI44001	Inner Joint		34	22	35	56.2	76					
1.6 S (66 kW)	1984.09-	1986.08	MT		F	Saloon Engine 16SH	GC099205	Outer Joint		33	25	52	109	61	O				
	1984.09-	1986.08	MT		F	Saloon Engine 16SH	GCI44001	Inner Joint		34	22	35	56.2	76					
1.7 D (42 kW)	1989.02-	1991.08	MT		F	Saloon Engine 17D	GC044057	Outer Joint	43T	33	25	52	109	61	O				
	1989.02-	1991.08	MT		F	Saloon Engine 17D	GC099205	Outer Joint		33	25	52	109	61	O				
	1989.02-	1991.08	MT		F	Saloon Engine 17D	GC044056	Outer Joint	29T	33	25	52	109	61	O				
	1989.02-	1991.08	MT		F	Saloon Engine 17D	GCI44002	Inner Joint		34	25	35	56.2	85.6					
1.8 (84 kW)	1987.09-	1990.08	MT		F	Saloon Engine 18E	GC044057	Outer Joint	43T	33	25	52	109	61	O				
	1987.09-	1990.08	MT		F	Saloon Engine 18E	GC099205	Outer Joint		33	25	52	109	61	O				
	1987.09-	1990.08	MT		F	Saloon Engine 18E	GC044056	Outer Joint	29T	33	25	52	109	61	O				
	1987.09-	1990.08	MT		F	Saloon Engine 18E	GCI44002	Inner Joint		34	25	35	56.2	85.6					
1.8 i (66 kW)	1990.09-	1991.08	MT		F	Saloon Engine 18SV/C18NT/C18NZ	GC044057	Outer Joint	43T	33	25	52	109	61	O				
	1990.09-	1991.08	MT		F	Saloon Engine 18SV/C18NT/C18NZ	GC099205	Outer Joint		33	25	52	109	61	O				
	1990.09-	1991.08	MT		F	Saloon Engine 18SV/C18NT/C18NZ	GC044056	Outer Joint	29T	33	25	52	109	61	O				
	1990.09-	1991.08	MT		F	Saloon Engine 18SV/C18NT/C18NZ	GCI44002	Inner Joint		34	25	35	56.2	85.6					
1.8 i (74 kW)	1985.10-	1986.08	MT		F	Saloon Engine C18NE	GC044057	Outer Joint	43T	33	25	52	109	61	O				
	1985.10-	1986.08	MT		F	Saloon Engine C18NE	GC099205	Outer Joint		33	25	52	109	61	O				
	1985.10-	1986.08	MT		F	Saloon Engine C18NE	GC044056	Outer Joint	29T	33	25	52	109	61	O				
	1985.10-	1986.08	MT		F	Saloon Engine C18NE	GCI44002	Inner Joint		34	25	35	56.2	85.6					
1.8 i (85 kW)	1984.09-	1986.08	MT		F	Saloon Engine 18E	GC044057	Outer Joint	43T	33	25	52	109	61	O				
	1984.09-	1986.08	MT		F	Saloon Engine 18E	GC099205	Outer Joint		33	25	52	109	61	O				
	1984.09-	1986.08	MT		F	Saloon Engine 18E	GC044056	Outer Joint	29T	33	25	52	109	61	O				
	1984.09-	1986.08	MT		F	Saloon Engine 18E	GCI44002	Inner Joint		34	25	35	56.2	85.6					
1.8 S (62 kW)	1987.09-	1991.08	MT		F	Saloon Engine E18NV	GC044057	Outer Joint	43T	33	25	52	109	61	O				
	1987.09-	1991.08	MT		F	Saloon Engine E18NV	GC099205	Outer Joint		33	25	52	109	61	O				
	1987.09-	1991.08	MT		F	Saloon Engine E18NV	GC044056	Outer Joint	29T	33	25	52	109	61	O				
	1987.09-	1991.08	MT		F	Saloon Engine E18NV	GCI44002	Inner Joint		34	25	35	56.2	85.6					
2.0 i (85 kW)	1987.03-	1991.08	MT		F	Saloon Engine 20NE	GC044057	Outer Joint	43T	33	25	52	109	61	O				
	1987.03-	1991.08	MT		F	Saloon Engine 20NE	GC099205	Outer Joint		33	25	52	109	61	O				



		TRANSM	L/R	F/R		G-AP Ref.	PRODUCT	ABS	Technical Specifications											
									YEAR	A	B	C	H	L	P					
<b>OPEL</b>																				
<b>KADETT E (39_, 49_)</b>																				
2.0 i (85 kW)	1987.03-	1991.08	MT		F	Saloon Engine 20NE	GC044056	Outer Joint	29T	33	25	52	109	61	O					
	1987.03-	1991.08	MT		F	Saloon Engine 20NE	GCI44002	Inner Joint		34	25	35	56.2	85.6						
2.0 i CAT (85 kW)	1987.03-	1991.08	MT		F	Saloon Engine C20NE	GC044057	Outer Joint	43T	33	25	52	109	61	O					
	1987.03-	1991.08	MT		F	Saloon Engine C20NE	GC099205	Outer Joint		33	25	52	109	61	O					
	1987.03-	1991.08	MT		F	Saloon Engine C20NE	GC044056	Outer Joint	29T	33	25	52	109	61	O					
	1987.03-	1991.08	MT		F	Saloon Engine C20NE	GCI44002	Inner Joint		34	25	35	56.2	85.6						
<b>KADETT E (43B_)</b>																				
1.3 S (55 kW)	1987.03-	1993.02	MT		F	Convertible Engine 13S	GCI44004	Inner Joint		22	22	34.95	57.5	72.5						
	1987.03-	1993.02	MT/AT		F	Convertible Engine 13S	GC044041	Outer Joint		22	22	52	95	50	O					
	1987.03-	1993.02	MT		F	Convertible Engine 13S	GC044051	Outer Joint	29T	22	22	52	95	50.5	O					
1.4 i (44 kW)	1990.01-	1991.08	MT		F	Convertible Engine C14NZ	GCI44004	Inner Joint		22	22	34.95	57.5	72.5						
	1990.01-	1991.08	MT		F	Convertible Engine C14NZ	GC044041	Outer Joint		22	22	52	95	50	O					
	1990.01-	1991.08	MT		F	Convertible Engine C14NZ	GC044051	Outer Joint	29T	22	22	52	95	50.5	O					
1.6 i (55 kW)	1986.10-	1993.02	AT		F	Convertible Engine E16NZ	GC044057	Outer Joint	43T	33	25	52	109	61	O					
	1986.10-	1993.02	MT		F	Convertible Engine E16NZ	GCI44004	Inner Joint		22	22	34.95	57.5	72.5						
	1986.10-	1993.02	MT/AT		F	Convertible Engine E16NZ	GC044041	Outer Joint		22	22	52	95	50	O					
	1986.10-	1993.02	MT		F	Convertible Engine E16NZ	GC044051	Outer Joint	29T	22	22	52	95	50.5	O					
1.6 i (60 kW)	1989.07-	1993.02	MT		F	Convertible Engine 16SV	GC099205	Outer Joint		33	25	52	109	61	O					
	1989.07-	1993.02	MT		F	Convertible Engine 16SV	GCI44001	Inner Joint		34	22	35	56.2	76						
1.6 i CAT (55 kW)	1987.10-	1993.02	AT		F	Convertible Engine C16LZ/C16NZ	GC044057	Outer Joint	43T	33	25	52	109	61	O					
	1987.10-	1993.02	MT		F	Convertible Engine C16LZ/C16NZ	GCI44004	Inner Joint		22	22	34.95	57.5	72.5						
	1987.10-	1993.02	MT/AT		F	Convertible Engine C16LZ/C16NZ	GC044041	Outer Joint		22	22	52	95	50	O					
	1987.10-	1993.02	MT		F	Convertible Engine C16LZ/C16NZ	GC044051	Outer Joint	29T	22	22	52	95	50.5	O					
2.0 i (85 kW)	1986.10-	1993.02	MT		F	Convertible Engine 20NE	GC044057	Outer Joint	43T	33	25	52	109	61	O					
	1986.10-	1993.02	MT		F	Convertible Engine 20NE	GC099205	Outer Joint		33	25	52	109	61	O					
	1986.10-	1993.02	MT		F	Convertible Engine 20NE	GC044056	Outer Joint	29T	33	25	52	109	61	O					
	1986.10-	1993.02	MT		F	Convertible Engine 20NE	GCI44002	Inner Joint		34	25	35	56.2	85.6						
2.0 i CAT (85 kW)	1986.10-	1993.02	MT		F	Convertible Engine C20NE	GC044057	Outer Joint	43T	33	25	52	109	61	O					
	1986.10-	1993.02	MT		F	Convertible Engine C20NE	GC099205	Outer Joint		33	25	52	109	61	O					
	1986.10-	1993.02	MT		F	Convertible Engine C20NE	GC044056	Outer Joint	29T	33	25	52	109	61	O					
	1986.10-	1993.02	MT		F	Convertible Engine C20NE	GCI44002	Inner Joint		34	25	35	56.2	85.6						
<b>KADETT E / ASTRA E, BELMONT</b>																				
1.6 D (40 kW)	1984.09-	1989.01	MT				GC044057	Outer Joint	43T	33	25	52	109	61	O					
1.7 D (42 kW)	1989-	1991					GC044057	Outer Joint	43T	33	25	52	109	61	O					
1.8 (85 kW)	1984-	1986				Ch-F000001	GC044057	Outer Joint	43T	33	25	52	109	61	O					
2.0 GSi 16V Kat (110 kW)	1988-	1991				Ch-F000001	GC044057	Outer Joint	43T	33	25	52	109	61	O					
2.0 i Kat (85 kW)	1987-	1991				Ch-F000001	GC044057	Outer Joint	43T	33	25	52	109	61	O					
<b>KADETT E COMBO (38_, 48_)</b>																				
1.3 N (44 kW)	1986.01-	1989.12	MT		F	Box Engine 13N	GCI44004	Inner Joint		22	22	34.95	57.5	72.5						
	1986.01-	1989.12	MT/AT		F	Box Engine 13N	GC044041	Outer Joint		22	22	52	95	50	O					
	1986.01-	1989.12	MT		F	Box Engine 13N	GC044051	Outer Joint	29T	22	22	52	95	50.5	O					
1.3 S (55 kW)	1986.01-	1989.12	MT		F	Box Engine 13S	GCI44004	Inner Joint		22	22	34.95	57.5	72.5						
	1986.01-	1989.12	MT/AT		F	Box Engine 13S	GC044041	Outer Joint		22	22	52	95	50	O					
	1986.01-	1989.12	MT		F	Box Engine 13S	GC044051	Outer Joint	29T	22	22	52	95	50.5	O					
1.4 i (44 kW)	1991.08-	1994.07	MT		F	Box Engine C14NZ	GC044041	Outer Joint		22	22	52	95	50	O					
	1991.08-	1994.07	MT		F	Box Engine C14NZ	GC044051	Outer Joint	29T	22	22	52	95	50.5	O					
1.4 S (55 kW)	1989.07-	1991.08	MT		F	Box Engine 14NV	GC044041	Outer Joint		22	22	52	95	50	O					
	1989.07-	1991.08	MT		F	Box Engine 14NV	GC044051	Outer Joint	29T	22	22	52	95	50.5	O					
1.6 (60 kW)	1986.09-	1991.12	MT		F	Box Engine 16SV	GC099205	Outer Joint		33	25	52	109	61	O					
	1986.09-	1991.12	MT		F	Box Engine 16SV	GCI44001	Inner Joint		34	22	35	56.2	76						
1.6 D (40 kW)	1986.01-	1989.12	MT		F	Box Engine 16DA	GC044057	Outer Joint	43T	33	25	52	109	61	O					
	1986.01-	1989.12	MT		F	Box Engine 16DA	GC099205	Outer Joint		33	25	52	109	61	O					
	1986.01-	1989.12	MT		F	Box Engine 16DA	GCI44001	Inner Joint		34	22	35	56.2	76						
	1986.01-	1989.12	MT		F	Box Engine 16DA	GCI44004	Inner Joint		22	22	34.95	57.5	72.5						
	1986.01-	1989.12	MT		F	Box Engine 16DA	GC044056	Outer Joint	29T	33	25	52	109	61	O					
1.6 i (55 kW)	1991.08-	1994.07	MT		F	Box Engine C16NZ	GC044041	Outer Joint		22	22	52	95	50	O					
	1991.08-	1994.07	MT		F	Box Engine C16NZ	GC044051	Outer Joint	29T	22	22	52	95	50.5	O					
1.7 D (42 kW)	1989.01-	1994.07	MT		F	Box Engine 17D	GC044057	Outer Joint	43T	33	25	52	109	61	O					
	1989.01-	1994.07	MT		F	Box Engine 17D	GC099205	Outer Joint		33	25	52	109	61	O					
	1989.01-	1994.07	MT		F	Box Engine 17D	GC044056	Outer Joint	29T	33	25	52	109	61	O					
	1989.01-	1994.07	MT		F	Box Engine 17D	GCI44002	Inner Joint		34	25	35	56.2	85.6						

		YEAR	TRANSM	L/R	F/R		G-AP Ref.	PRODUCT	ABS	Technical Specifications										
										A	B	C	H	L	P					
<b>OPEL</b>																				
<b>KADETT E COMBO (38., 48.)</b>																				
1.7 D (44 kW)	1992.07-	1994.07	MT		F	Box Engine 17DR	GCO99205	Outer Joint		33	25	52	109	61	O					
	1992.07-	1994.07	MT		F	Box Engine 17DR	GCO44056	Outer Joint	29T	33	25	52	109	61	O					
<b>KADETT E SW</b>																				
1.6 D (40 kW)	1984.09-	1989.01	MT				GCO44057	Outer Joint	43T	33	25	52	109	61	O					
1.7 D (42 kW)	1989.01-	1991					GCO44057	Outer Joint	43T	33	25	52	109	61	O					
1.8 (85 kW)	1984-	1986				Ch-F000001	GCO44057	Outer Joint	43T	33	25	52	109	61	O					
2.0 i Kat (85 kW)	1987-	1991				Ch-F000001	GCO44057	Outer Joint	43T	33	25	52	109	61	O					
<b>MERIVA</b>																				
1.3 CDTi (51 kW)	2005.04-	2010.05			F	MPV Engine Y13DT/Z13DT	GCI44009	Inner Joint		22	23	35	57.5	96						
1.3 CDTi (55 kW)	2003.09-	2010.05			F	MPV Engine Z13DTJ	GCO44002	Outer Joint	29T	22	23	52	97.5	61	M					
1.4 16V Twinport (66 kW)	2004.07-	2010.05			F	MPV Engine Z14XEP	GCO44020	Outer Joint	29T	22	28	52	97.5	57.5	O					
	2004.07-	2010.05		L	F	MPV Engine Z14XEP	GDS99069	Drive Shaft	29T	22	22	52	97.5	584						
	2004.07-	2010.05		L/R	F	MPV Engine Z14XEP	GCO44043	Outer Joint		22	28	52	97.5	57.5	O					
	2004.07-	2010.05		R	F	MPV Engine Z14XEP	GDS99157	Drive Shaft	29T	22	22	52	97.5	930						
1.6 (64 kW)	2003.05-	2010.05			F	MPV Engine Z16SE	GCO44020	Outer Joint	29T	22	28	52	97.5	57.5	O					
	2003.05-	2010.05			F	MPV Engine Z16SE	GCO44005	Outer Joint	29T	22	22	52	97.5	58.5	M					
	2003.05-	2010.05		L	F	MPV Engine Z16SE	GDS99069	Drive Shaft	29T	22	22	52	97.5	584						
	2003.05-	2010.05		L/R	F	MPV Engine Z16SE	GCO44043	Outer Joint		22	28	52	97.5	57.5	O					
	2003.05-	2010.05		R	F	MPV Engine Z16SE	GDS99157	Drive Shaft	29T	22	22	52	97.5	930						
1.6 (77 kW)	2006.01-	2010.05		R	F	MPV Engine Z16XEP	GDS99157	Drive Shaft	29T	22	22	52	97.5	930						
1.6 16V (74 kW)	2003.05-	2006.01			F	MPV Engine Z16XE	GCO44020	Outer Joint	29T	22	28	52	97.5	57.5	O					
	2003.05-	2006.01			F	MPV Engine Z16XE	GCO44005	Outer Joint	29T	22	22	52	97.5	58.5	M					
	2003.05-	2006.01		L	F	MPV Engine Z16XE	GDS99069	Drive Shaft	29T	22	22	52	97.5	584						
	2003.05-	2006.01		L/R	F	MPV Engine Z16XE	GCO44043	Outer Joint		22	28	52	97.5	57.5	O					
	2003.05-	2006.01		R	F	MPV Engine Z16XE	GDS99157	Drive Shaft	29T	22	22	52	97.5	930						
1.6 Turbo (132 kW)	2005.09-	2010.05	MT	L	F	MPV Engine Z16LET	GDS44032	Drive Shaft	29T	33	34	52	104	587.5						
	2005.09-	2010.05	MT	L	F	MPV Engine Z16LET	GCI21034	Inner Joint		34	24	35	56.5	102						
	2005.09-	2010.05	MT	L/R	F	MPV Engine Z16LET	GCO22005	Outer Joint		33	24	52	104	64	M					
	2005.09-	2010.05	MT	R	F	MPV Engine Z16LET	GDS60021	Drive Shaft	29T	33	34	52	104	612						
	2005.09-	2010.05	MT	R	F	MPV Engine Z16LET	GCI60003	Inner Joint		34	24	35.5	47	70.5						
	2005.09-	2010.05	MT	R	F	MPV Engine Z16LET	GDS44093	Drive Shaft	29T	33	34	52	104	619						
1.7 CDTi (74 kW)	2003.09-	2010.05			F	MPV Engine Z17DT/Z17DTH	GCO44004	Outer Joint	29T	33	24	52	104	64	M					
	2003.09-	2010.05	MT	L	F	MPV Engine Z17DT/Z17DTH	GDS44032	Drive Shaft	29T	33	34	52	104	587.5						
	2003.09-	2010.05	MT	L	F	MPV Engine Z17DT/Z17DTH	GCI21034	Inner Joint		34	24	35	56.5	102						
	2003.09-	2010.05		L	F	MPV Engine Z17DT/Z17DTH	GDS44094	Drive Shaft	29T	33	34	52	104	599						
	2003.09-	2010.05	MT	L/R	F	MPV Engine Z17DT/Z17DTH	GCO22005	Outer Joint		33	24	52	104	64	M					
	2003.09-	2010.05	MT	R	F	MPV Engine Z17DT/Z17DTH	GDS60021	Drive Shaft	29T	33	34	52	104	612						
	2003.09-	2010.05	MT	R	F	MPV Engine Z17DT/Z17DTH	GCI60003	Inner Joint		34	24	35.5	47	70.5						
	2003.09-	2010.05	MT	R	F	MPV Engine Z17DT/Z17DTH	GDS44093	Drive Shaft	29T	33	34	52	104	619						
1.7 CDTi (92 kW)	2006.09-	2010.05		R	F	MPV Engine A17DTR/Z17DTR	GDS44093	Drive Shaft	29T	33	34	52	104	619						
1.7 DTi (55 kW)	2003.09-	2010.05			F	MPV Engine Y17DT	GCO44002	Outer Joint	29T	22	23	52	97.5	61	M					
	2003.09-	2010.05			F	MPV Engine Y17DT	GCI44009	Inner Joint		22	23	35	57.5	96						
	2003.09-	2010.05		R	F	MPV Engine Y17DT	GDS44093	Drive Shaft	29T	33	34	52	104	619						
1.8 (92 kW)	2003.05-	2010.05			F	MPV Engine Z18XE	GCO44002	Outer Joint	29T	22	23	52	97.5	61	M					
	2003.05-	2010.05			F	MPV Engine Z18XE	GCI44009	Inner Joint		22	23	35	57.5	96						
<b>MERIVA A</b>																				
1.3 CDTi 16V (55 kW)	2003.09-						GCO44002	Outer Joint	29T	22	23	52	97.5	61	M					
1.6 (64 kW)	2003.05-						GCI21014	Inner Joint		22	22	35	57.5	75						
	2003.05-						GCO44005	Outer Joint	29T	22	22	52	97.5	58.5	M					
1.6 16V (74 kW)	2006.01-					Ch-44162552 Design: GKN	GCO44005	Outer Joint	29T	22	22	52	97.5	58.5	M					
	2006.01-						GCI21014	Inner Joint		22	22	35	57.5	75						
1.6 16V (77 kW)	2006.01-					Ch-44162552 Design: GKN	GCO44005	Outer Joint	29T	22	22	52	97.5	58.5	M					
	2006.01-						GCI21014	Inner Joint		22	22	35	57.5	75						
1.6 T (132 kW)	2007-						GCO44004	Outer Joint	29T	33	24	52	104	64	M					
1.7 DTi 16V (55 kW)	2003.09-						GCO44002	Outer Joint	29T	22	23	52	97.5	61	M					
1.8 16V (92 kW)	2003.05-						GCO44002	Outer Joint	29T	22	23	52	97.5	61	M					
<b>MERIVA B</b>																				
1.3 CDTi (55 kW)	2010.06-		MT	R	F	MPV Engine A13DTC	GDS44088	Drive Shaft		33	22	52	103.5	953						
1.3 CDTi (70 kW)	2010.06-			R	F	MPV Engine A13DTE	GDS44088	Drive Shaft		33	22	52	103.5	953						
1.7 CDTi (81 kW)	2010.06-					MPV Engine A17DTC/A17DTI	GCO99024	Outer Joint		33	26	52.5	94	65.5	M					
1.7 CDTi (96 kW)	2010.06-					MPV Engine A17DTS	GCO99024	Outer Joint		33	26	52.5	94	65.5	M					









		TRANSM	L/R	F/R		G-AP Ref.	PRODUCT	ABS	Technical Specifications								
									YEAR	A	B	C	H	L	P		
<b>OPEL MOVANO (F9)</b>																	
1.9 DTi (59 kW)	2000.09-	2001.10			Box Engine F9Q770	GC044026	Outer Joint	51T	28	36	65	96	71	I			
1.9 DTi (60 kW)	2001.10-		MT	L	F	Box Engine F9Q772/F9Q774	GDS44005	Drive Shaft	51T	28	37.1	65	96	670			
	2001.10-		MT	L	F	Box Engine F9Q772/F9Q774	GDS50246	Drive Shaft		28	37.1	65	96	644			
	2001.10-		MT	L	F	Box Engine F9Q772/F9Q774	GDS50010	Drive Shaft		28	37.1	67.1	93.5	669			
	2001.10-		MT	L	F	Box Engine F9Q772/F9Q774	GDS50058	Drive Shaft	51T	28	37.1	65	96	644			
	2001.10-		MT	R	F	Box Engine F9Q772/F9Q774	GDS44022	Drive Shaft		28	39	67.1	93.5	1147			
	2001.10-		MT	R	F	Box Engine F9Q772/F9Q774	GDS44017	Drive Shaft	51T	28	39	67.1	93.5	1147			
	2001.10-		MT	R	F	Box Engine F9Q772/F9Q774	GDS44021	Drive Shaft		28	39	65	96	1126			
	2001.10-		MT	R	F	Box Engine F9Q772/F9Q774	GDS50060	Drive Shaft	51T	28	39	65	96	1126			
	2001.10-				Box Engine F9Q772/F9Q774	GC044026	Outer Joint	51T	28	36	65	96	71	I			
2.2 DTi (66 kW)	2000.09-				Box Engine G9T720/G9T722/G9T750	GC044026	Outer Joint	51T	28	36	65	96	71	I			
2.5 CDTi (107 kW)	2003.10-		MT	L	F	Box Engine G9U632/G9U650	GDS99286	Drive Shaft	51T	28	39	65	96	700			
	2003.10-		MT	R	F	Box Engine G9U632/G9U650	GDS50066	Drive Shaft		28	39	65	96	1142			
2.5 CDTi (74 kW)	2003.10-		MT	L	F	Box Engine G9U650	GDS99286	Drive Shaft	51T	28	39	65	96	700			
	2003.10-		MT	R	F	Box Engine G9U650	GDS50066	Drive Shaft		28	39	65	96	1142			
2.5 CDTi (88 kW)	2003.10-		MT	L	F	Box Engine G9U632/G9U650	GDS99286	Drive Shaft	51T	28	39	65	96	700			
	2003.10-		MT	R	F	Box Engine G9U632/G9U650	GDS50066	Drive Shaft		28	39	65	96	1142			
2.5 D (59 kW)	1999.01-	2000.09	MT		F	Box Engine S8U770/S8U772	GC044008	Outer Joint	51T	28	27	67.1	93.5	64.5	I		
2.5 DTi (73 kW)	2003.10-				Box Engine G9U754	GC044026	Outer Joint	51T	28	36	65	96	71	I			
2.5 DTi (84 kW)	2001.10-		MT	L	F	Box Engine G9U720/G8U724/G9U754	GDS44012	Drive Shaft		28	37.1	65	96	663			
	2001.10-		MT	L	F	Box Engine G9U720/G8U724/G9U754	GDS50166	Drive Shaft	51T	28	37.1	65	96	663			
	2001.10-		MT	R	F	Box Engine G9U720/G8U724/G9U754	GDS50249	Drive Shaft		28	39	65	96	1144			
	2001.10-		MT	R	F	Box Engine G9U720/G8U724/G9U754	GDS99151	Drive Shaft	51T	28	39	65	96	1144			
	2001.10-		MT	R	F	Box Engine G9U720/G8U724/G9U754	GDS50066	Drive Shaft		28	39	65	96	1142			
	2001.10-				Box Engine G9U720/G8U724/G9U754	GC044026	Outer Joint	51T	28	36	65	96	71	I			
2.8 DTi (84 kW)	1999.01-	2001.10			Box Engine S9W700/S9W702	GC044026	Outer Joint	51T	28	36	65	96	71	I			
	1999.01-	2001.10	MT		F	Box Engine S9W700/S9W702	GC044008	Outer Joint	51T	28	27	67.1	93.5	64.5	I		
<b>MOVANO (H9)</b>																	
2.5 CDTi (107 kW)	2006.08-		MT	L	F	Dumptruck Engine G9U650/G9U632	GDS99286	Drive Shaft	51T	28	39	65	96	700			
	2006.08-		MT	R	F	Dumptruck Engine G9U650/G9U632	GDS50066	Drive Shaft		28	39	65	96	1142			
2.5 CDTi (74 kW)	2006.08-		MT	L	F	Dumptruck Engine G9U650	GDS99286	Drive Shaft	51T	28	39	65	96	700			
	2006.08-		MT	R	F	Dumptruck Engine G9U650	GDS50066	Drive Shaft		28	39	65	96	1142			
2.5 CDTi (88 kW)	2006.08-		MT	L	F	Dumptruck Engine G9U650/G9U632	GDS99286	Drive Shaft	51T	28	39	65	96	700			
	2006.08-		MT	R	F	Dumptruck Engine G9U650/G9U632	GDS50066	Drive Shaft		28	39	65	96	1142			
2.5 D (59 kW)	1999.01-	2000.09	MT		F	Dumptruck Engine S8U770/S8U772	GC044008	Outer Joint	51T	28	27	67.1	93.5	64.5	I		
2.5 DTi (73 kW)	2003.10-				Dumptruck Engine G9U754	GC044026	Outer Joint	51T	28	36	65	96	71	I			
2.5 DTi (84 kW)	2001.10-		MT	R	F	Dumptruck Engine G9U720/G9U724/G9U750/G9U754	GDS50066	Drive Shaft		28	39	65	96	1142			
	2001.10-				Dumptruck Engine G9U720/G9U724/G9U750/G9U754	GC044026	Outer Joint	51T	28	36	65	96	71	I			
2.8 DTi (84 kW)	1999.01-	2001.10			Dumptruck Engine S9W700/S9W702	GC044026	Outer Joint	51T	28	36	65	96	71	I			
	1999.01-	2001.10	MT		F	Dumptruck Engine S9W700/S9W702	GC044008	Outer Joint	51T	28	27	67.1	93.5	64.5	I		
<b>MOVANO (J9)</b>																	
1.9 DTi (59 kW)	2000.09-	2001.10			Bus Engine F9Q770	GC044026	Outer Joint	51T	28	36	65	96	71	I			
1.9 DTi (60 kW)	2001.10-		MT	L	F	Bus Engine F9Q772/F9Q774	GDS44005	Drive Shaft	51T	28	37.1	65	96	670			
	2001.10-		MT	L	F	Bus Engine F9Q772/F9Q774	GDS50246	Drive Shaft		28	37.1	65	96	644			
	2001.10-		MT	L	F	Bus Engine F9Q772/F9Q774	GDS50010	Drive Shaft		28	37.1	67.1	93.5	669			
	2001.10-		MT	L	F	Bus Engine F9Q772/F9Q774	GDS50058	Drive Shaft	51T	28	37.1	65	96	644			
	2001.10-		MT	R	F	Bus Engine F9Q772/F9Q774	GDS44022	Drive Shaft		28	39	67.1	93.5	1147			
	2001.10-		MT	R	F	Bus Engine F9Q772/F9Q774	GDS44017	Drive Shaft	51T	28	39	67.1	93.5	1147			
	2001.10-		MT	R	F	Bus Engine F9Q772/F9Q774	GDS44021	Drive Shaft		28	39	65	96	1126			
	2001.10-		MT	R	F	Bus Engine F9Q772/F9Q774	GDS50060	Drive Shaft	51T	28	39	65	96	1126			
	2001.10-				Bus Engine F9Q772/F9Q774	GC044026	Outer Joint	51T	28	36	65	96	71	I			
2.2 DTi (66 kW)	2000.09-				Bus Engine G9T720/G9T722/G9T750	GC044026	Outer Joint	51T	28	36	65	96	71	I			
2.5 CDTi (107 kW)	2006.08-		MT	L	F	Bus Engine G9U632/G9U650	GDS99286	Drive Shaft	51T	28	39	65	96	700			
	2006.08-		MT	R	F	Bus Engine G9U632/G9U650	GDS50066	Drive Shaft		28	39	65	96	1142			
2.5 CDTi (73 kW)	2003.10-	2006.12	MT	R	F	Bus	GDS50066	Drive Shaft		28	39	65	96	1142			
2.5 CDTi (74 kW)	2007.09-		MT	L	F	Bus Engine G9U650	GDS99286	Drive Shaft	51T	28	39	65	96	700			
	2007.09-		MT	R	F	Bus Engine G9U650	GDS50066	Drive Shaft		28	39	65	96	1142			
2.5 CDTi (88 kW)	2006.08-		MT	L	F	Bus Engine G9U632/G9U650	GDS99286	Drive Shaft	51T	28	39	65	96	700			
	2006.08-		MT	R	F	Bus Engine G9U632/G9U650	GDS50066	Drive Shaft		28	39	65	96	1142			
2.5 D (59 kW)	1998.07-	2000.09	MT		F	Bus Engine S8U770/S8U772	GC044008	Outer Joint	51T	28	27	67.1	93.5	64.5	I		
2.5 DTi (84 kW)	2001.10-		MT	L	F	Bus Engine G9U720/G9U724/G9U750/G9U754	GDS44012	Drive Shaft		28	37.1	65	96	663			

		TRANSM	L/R	F/R		G-AP Ref.	PRODUCT	ABS	Technical Specifications						
									YEAR	A	B	C	H	L	P
<b>OPEL</b>															
<b>MOVANO (J9)</b>															
2.5 DTi (84 kW)	2001.10-		MT	L	F	Bus Engine G9U720/G9U724/G9U750/G9U754	GDS50166	Drive Shaft	51T	28	37.1	65	96	663	
	2001.10-		MT	R	F	Bus Engine G9U720/G9U724/G9U750/G9U754	GDS50249	Drive Shaft		28	39	65	96	1144	
	2001.10-		MT	R	F	Bus Engine G9U720/G9U724/G9U750/G9U754	GDS99151	Drive Shaft	51T	28	39	65	96	1144	
	2001.10-		MT	R	F	Bus Engine G9U720/G9U724/G9U750/G9U754	GDS50066	Drive Shaft		28	39	65	96	1142	
	2001.10-					Bus Engine G9U720/G9U724/G9U750/G9U754	GC044026	Outer Joint	51T	28	36	65	96	71	I
2.8 DTi (84 kW)	1998.07-2001.10					Bus Engine S9W700/S9W702	GC044026	Outer Joint	51T	28	36	65	96	71	I
	1998.07-2001.10		MT		F	Bus Engine S9W700/S9W702	GC044008	Outer Joint	51T	28	27	67.1	93.5	64.5	I
<b>MOVANO (U9, E9)</b>															
2.2 DTi (66 kW)	2000.09-					Platform/Chassis Engine G9T720/G9T722/G9T750	GC044026	Outer Joint	51T	28	36	65	96	71	I
2.5 CDTi (107 kW)	2006.08-			L	F	Platform/Chassis Engine G9U632/G9U650	GDS99286	Drive Shaft	51T	28	39	65	96	700	
2.5 CDTi (74 kW)	2006.08-			L	F	Platform/Chassis Engine G9U650	GDS99286	Drive Shaft	51T	28	39	65	96	700	
2.5 CDTi (88 kW)	2006.08-			L	F	Platform/Chassis Engine G9U632/G9U650	GDS99286	Drive Shaft	51T	28	39	65	96	700	
2.5 D (59 kW)	1998.07-2000.09		MT		F	Platform/Chassis Engine S8U770/S8U772	GC044008	Outer Joint	51T	28	27	67.1	93.5	64.5	I
2.5 DTi (73 kW)	2003.10-					Platform/Chassis Engine G9U754	GC044026	Outer Joint	51T	28	36	65	96	71	I
2.5 DTi (84 kW)	2001.10-		MT	L	F	Platform/Chassis Engine G9U720/G9U724/G9U750/G9U754	GDS44012	Drive Shaft		28	37.1	65	96	663	
	2001.10-		MT	L	F	Platform/Chassis Engine G9U720/G9U724/G9U750/G9U754	GDS50166	Drive Shaft	51T	28	37.1	65	96	663	
	2001.10-		MT	R	F	Platform/Chassis Engine G9U720/G9U724/G9U750/G9U754	GDS50249	Drive Shaft		28	39	65	96	1144	
	2001.10-		MT	R	F	Platform/Chassis Engine G9U720/G9U724/G9U750/G9U754	GDS99151	Drive Shaft	51T	28	39	65	96	1144	
	2001.10-		MT	R	F	Platform/Chassis Engine G9U720/G9U724/G9U750/G9U754	GDS50066	Drive Shaft		28	39	65	96	1142	
	2001.10-					Platform/Chassis Engine G9U720/G9U724/G9U750/G9U754	GC044026	Outer Joint	51T	28	36	65	96	71	I
2.8 DTi (84 kW)	1998.07-2001.10					Platform/Chassis Engine S9W700/S9W702	GC044026	Outer Joint	51T	28	36	65	96	71	I
	1998.07-2001.10		MT		F	Platform/Chassis Engine S9W700/S9W702	GC044008	Outer Joint	51T	28	27	67.1	93.5	64.5	I
<b>MOVANO B</b>															
2.3 CDTi (107 kW)	2010.12-		MT	R	F	Bus Engine M9T678/M9T680	GDS18248	Drive Shaft		31	39	70	100.5	1075	
	2010.12-		MT	R	F	Bus Engine M9T678/M9T680	GCI50046	Inner Joint		39	27	30	364	87	
	2010.12-		MT	R	F	Bus Engine M9T678/M9T680	GC050132	Outer Joint		31	27	70	100.5	63.5	I
2.3 CDTi (110 kW)	2013.01-		MT/AT	R	F	Bus Engine M9T880	GDS18248	Drive Shaft		31	39	70	100.5	1075	
	2013.01-		MT/AT	R	F	Bus Engine M9T880	GCI50046	Inner Joint		39	27	30	364	87	
	2013.01-		MT/AT	R	F	Bus Engine M9T880	GC050132	Outer Joint		31	27	70	100.5	63.5	I
	2013.01-		MT/AT	R	F	Platform/Chassis Engine M9T880	GDS18248	Drive Shaft		31	39	70	100.5	1075	
	2013.01-		MT/AT	R	F	Platform/Chassis Engine M9T880	GCI50046	Inner Joint		39	27	30	364	87	
	2013.01-		MT/AT	R	F	Platform/Chassis Engine M9T880	GC050132	Outer Joint		31	27	70	100.5	63.5	I
2.3 CDTi (74 kW)	2010.05-		MT	R	F	Box Engine M9T672/M9T670/M9T676	GDS18248	Drive Shaft		31	39	70	100.5	1075	
	2010.05-		MT	R	F	Box Engine M9T672/M9T670/M9T676	GCI50046	Inner Joint		39	27	30	364	87	
	2010.05-		MT	R	F	Box Engine M9T672/M9T670/M9T676	GC050132	Outer Joint		31	27	70	100.5	63.5	I
	2010.12-		MT	R	F	Bus Engine M9T670/M9T672/M9T676	GDS18248	Drive Shaft		31	39	70	100.5	1075	
	2010.12-		MT	R	F	Bus Engine M9T670/M9T672/M9T676	GCI50046	Inner Joint		39	27	30	364	87	
	2010.12-		MT	R	F	Bus Engine M9T670/M9T672/M9T676	GC050132	Outer Joint		31	27	70	100.5	63.5	I
2.3 CDTi (92 kW)	2010.05-			R	F	Box Engine M9T672/M9T670/M9T676	GDS18248	Drive Shaft		31	39	70	100.5	1075	
	2010.05-			R	F	Box Engine M9T672/M9T670/M9T676	GCI50046	Inner Joint		39	27	30	364	87	
	2010.05-			R	F	Box Engine M9T672/M9T670/M9T676	GC050132	Outer Joint		31	27	70	100.5	63.5	I
	2010.12-			R	F	Bus Engine M9T670/M9T672/M9T676/M9T680	GDS18248	Drive Shaft		31	39	70	100.5	1075	
	2010.12-			R	F	Bus Engine M9T670/M9T672/M9T676/M9T680	GCI50046	Inner Joint		39	27	30	364	87	
<b>MOVANO B KASTEN</b>															
2.3 CDTi (110 kW)	2013.01-		MT/AT	R	F	Box Engine M9T880	GDS18248	Drive Shaft		31	39	70	100.5	1075	
	2013.01-		MT/AT	R	F	Box Engine M9T880	GCI50046	Inner Joint		39	27	30	364	87	
	2013.01-		MT/AT	R	F	Box Engine M9T880	GC050132	Outer Joint		31	27	70	100.5	63.5	I
<b>SIGNUM</b>															
1.8 (103 kW)	2005.11-2007.01				F	Hatchback Engine Z18XER	GC021038	Outer Joint		30	24	52	94	64	M
	2005.11-2007.01				F	Hatchback Engine Z18XER	GC017007	Outer Joint		30	25	52.5	105	62	O
	2005.11-2007.01		MT	L	F	Hatchback Engine Z18XER	GDS44020	Drive Shaft		30	22	52.5	105	617.5	
	2005.11-2007.01		MT	L	F	Hatchback Engine Z18XER	GCI99026	Inner Joint		22	25	35	57	82.5	
	2005.11-2007.01		MT	L	F	Hatchback Engine Z18XER	GC017007	Outer Joint		30	25	52.5	105	62	O
	2005.11-2007.01		MT	R	F	Hatchback Engine Z18XER	GDS17040	Drive Shaft		30	22	52.5	105	987	
1.8 (90 kW)	2004.07-2006.01				F	Hatchback Engine Z18XE	GC021038	Outer Joint		30	24	52	94	64	M
	2004.07-2006.01				F	Hatchback Engine Z18XE	GC017007	Outer Joint		30	25	52.5	105	62	O
	2004.07-2006.01		MT	L	F	Hatchback Engine Z18XE	GDS44020	Drive Shaft		30	22	52.5	105	617.5	
	2004.07-2006.01		MT	L/R	F	Hatchback Engine Z18XE	GCI99026	Inner Joint		22	25	35	57	82.5	
	2004.07-2006.01		MT	L/R	F	Hatchback Engine Z18XE	GC017007	Outer Joint		30	25	52.5	105	62	O
	2004.07-2006.01		MT	R	F	Hatchback Engine Z18XE	GDS17040	Drive Shaft		30	22	52.5	105	987	
1.8 16V (103 kW)	2003.05-					Ch-71009336	GC017007	Outer Joint		30	25	52.5	105	62	O



		TRANSM	L/R	F/R		G-AP Ref.	PRODUCT	ABS	Technical Specifications									
									YEAR	A	B	C	H	L	P			
<b>OPEL</b>																		
<b>SIGNUM</b>																		
1.8 16V (90 kW)	2003.05-				Ch-71009336	GC017007	Outer Joint		30	25	52.5	105	62	O				
1.9 CDTi (110 kW)	2004.04-		MT/AT		F Hatchback Engine Z19DTH	GC017051	Outer Joint		30	26	53.8	94.5	65.5	M				
	2004.04-		MT	L	F Hatchback Engine Z19DTH	GDS21032	Drive Shaft		30	27	53.8	94.5	605					
	2004.04-		AT	L/R	F Hatchback Engine Z19DTH	GDS44080	Drive Shaft		30	27	53.8	94.5	591					
	2004.04-		MT	R	F Hatchback Engine Z19DTH	GDS21032	Drive Shaft		30	27	53.8	94.5	605					
	2004.04-		MT	L/R	F Hatchback Engine Z19DTH	GCI99138	Inner Joint		27	28	35	78	83					
	2004.04-		MT	R	F Hatchback Engine Z19DTH	GDS21053	Drive Shaft		30	34	53.8	94.5	617					
	2004.04-					GCI99138	Inner Joint		27	28	35	78	83					
	2004.04-					GC017051	Outer Joint		30	26	53.8	94.5	65.5	M				
1.9 CDTi (74 kW)	2004.04-					GCI99138	Inner Joint		27	28	35	78	83					
	2004.04-					GC017051	Outer Joint		30	26	53.8	94.5	65.5	M				
	2005.08-		MT/AT		F Hatchback Engine Z19DT	GC017051	Outer Joint		30	26	53.8	94.5	65.5	M				
	2005.08-		MT	L	F Hatchback Engine Z19DT	GDS21032	Drive Shaft		30	27	53.8	94.5	605					
	2005.08-		MT	R	F Hatchback Engine Z19DT	GDS21032	Drive Shaft		30	27	53.8	94.5	605					
	2005.08-		MT	L/R	F Hatchback Engine Z19DT	GDS21092	Drive Shaft		30	25	53.8	94.5	604					
	2005.08-		MT	L/R	F Hatchback Engine Z19DT	GCI99138	Inner Joint		27	28	35	78	83					
	2005.08-		MT	R	F Hatchback Engine Z19DT	GDS21053	Drive Shaft		30	34	53.8	94.5	617					
1.9 CDTi (88 kW)	2004.04-		MT		F Hatchback Engine Z19DT	GC017051	Outer Joint		30	26	53.8	94.5	65.5	M				
	2004.04-		MT	L	F Hatchback Engine Z19DT	GDS21032	Drive Shaft		30	27	53.8	94.5	605					
	2004.04-		MT	R	F Hatchback Engine Z19DT	GDS21032	Drive Shaft		30	27	53.8	94.5	605					
	2004.04-		MT	L	F Hatchback Engine Z19DT	GDS21092	Drive Shaft		30	25	53.8	94.5	604					
	2004.04-		MT	L/R	F Hatchback Engine Z19DT	GCI99138	Inner Joint		27	28	35	78	83					
	2004.04-		MT	R	F Hatchback Engine Z19DT	GDS21053	Drive Shaft		30	34	53.8	94.5	617					
	2004.04-					GCI99138	Inner Joint		27	28	35	78	83					
	2004.04-					GC017051	Outer Joint		30	26	53.8	94.5	65.5	M				
2.0 DTi (74 kW)	2003.05-				F Hatchback Engine Y20DTH	GC017007	Outer Joint		30	25	52.5	105	62	O				
	2003.05-		MT	R	F Hatchback Engine Y20DTH	GDS21061	Drive Shaft		30	34	52.5	105	968					
2.0 DTi 16V (74 kW)	2003.05-					GC017007	Outer Joint		30	25	52.5	105	62	O				
2.0 Turbo (129 kW)	2003.05-		MT		F Hatchback Engine Z20NET	GC017051	Outer Joint		30	26	53.8	94.5	65.5	M				
	2003.05-		MT	L/R	F Hatchback Engine Z20NET	GDS21032	Drive Shaft		30	27	53.8	94.5	605					
	2003.05-		MT	L/R	F Hatchback Engine Z20NET	GCI99138	Inner Joint		27	28	35	78	83					
	2003.05-				Hatchback Engine Z20NET	GC099023	Outer Joint		30	26	53.8	94.5	65.5	M				
2.0 Turbo 16V (129 kW)	2003.05-					GCI99138	Inner Joint		27	28	35	78	83					
	2003.05-					GC017051	Outer Joint		30	26	53.8	94.5	65.5	M				
2.2 16V (114 kW)	2003.05-					GC017007	Outer Joint		30	25	52.5	105	62	O				
2.2 Direct (114 kW)	2003.05-				F Hatchback Engine Z22YH	GC017007	Outer Joint		30	25	52.5	105	62	O				
2.2 DTi (92 kW)	2003.05-		MT		F Hatchback Engine Y22DTR	GC017051	Outer Joint		30	26	53.8	94.5	65.5	M				
	2003.05-		MT	L/R	F Hatchback Engine Y22DTR	GDS21032	Drive Shaft		30	27	53.8	94.5	605					
	2003.05-		MT	L/R	F Hatchback Engine Y22DTR	GCI99138	Inner Joint		27	28	35	78	83					
	2003.05-				Hatchback Engine Y22DTR	GC099023	Outer Joint		30	26	53.8	94.5	65.5	M				
2.2 DTi 16V (86 kW)	2003.05-	2008.06			Hatchback Engine Y 22 DTR	GC099023	Outer Joint		30	26	53.8	94.5	65.5	M				
2.2 DTi 16V (92 kW)	2003.05-					GCI99138	Inner Joint		27	28	35	78	83					
	2003.05-					GC017051	Outer Joint		30	26	53.8	94.5	65.5	M				
2.8 V6 Turbo (169 kW)	2005.09-		MT		Hatchback Engine Z28NEL	GC099023	Outer Joint		30	26	53.8	94.5	65.5	M				
	2005.09-		MT			GCI99138	Inner Joint		27	28	35	78	83					
2.8 V6 Turbo (184 kW)	2005.09-		MT			GCI99138	Inner Joint		27	28	35	78	83					
	2006.11-		MT		Hatchback Engine Z28NET	GC099023	Outer Joint		30	26	53.8	94.5	65.5	M				
3.0 V6 CDTi (130 kW)	2003.05-		MT		F Hatchback Engine Y30DT	GC017051	Outer Joint		30	26	53.8	94.5	65.5	M				
	2003.05-		MT	L/R	F Hatchback Engine Y30DT	GDS21032	Drive Shaft		30	27	53.8	94.5	605					
	2003.05-		MT	L/R	F Hatchback Engine Y30DT	GCI99138	Inner Joint		27	28	35	78	83					
	2003.05-				Hatchback Engine Y30DT	GC099023	Outer Joint		30	26	53.8	94.5	65.5	M				
	2003.05-					GCI99138	Inner Joint		27	28	35	78	83					
	2003.05-					GC017051	Outer Joint		30	26	53.8	94.5	65.5	M				
3.0 V6 CDTi (135 kW)	2005.09-		MT			GCI99138	Inner Joint		27	28	35	78	83					
	2005.09-				Hatchback Engine Z30DT	GC099023	Outer Joint		30	26	53.8	94.5	65.5	M				
	2005.09-					GC017051	Outer Joint		30	26	53.8	94.5	65.5	M				
3.2 V6 (155 kW)	2003.05-		MT	L/R	F Hatchback Engine Z32SE	GCI99138	Inner Joint		27	28	35	78	83					
	2003.05-				Hatchback Engine Z32SE	GC099023	Outer Joint		30	26	53.8	94.5	65.5	M				
	2003.05-					GCI99138	Inner Joint		27	28	35	78	83					
	2003.05-					GC017051	Outer Joint		30	26	53.8	94.5	65.5	M				
	2003.05-		MT		F Hatchback Engine Z32SE	GC017051	Outer Joint		30	26	53.8	94.5	65.5	M				





		TRANSM	L/R	F/R		G-AP Ref.	PRODUCT	ABS	Technical Specifications									
									YEAR	A	B	C	H	L	P			
<b>OPEL SIGNUM</b>																		
3.2 V6 (155 kW)	2003.05-		MT	L/R	F	Hatchback Engine Z32SE	GDS21032	Drive Shaft		30	27	53.8	94.5	605				
<b>TIGRA (95_)</b>																		
1.4 16V (63 kW)	1997.08-	2000.12	MT		F	Coupe Engine X14XE	GCI44003	Inner Joint		22	28	34.95	57.5	83.5				
1.4 16V (66 kW)	1994.07-	2000.12	MT		F	Coupe Engine X14XE	GCI44003	Inner Joint		22	28	34.95	57.5	83.5				
1.6 16V (78 kW)	1994.07-	1998.08	MT		F	Coupe Engine X16XE	GCI44004	Inner Joint		22	22	34.95	57.5	72.5				
<b>TIGRA B TWINTOP</b>																		
1.8 16V (92 kW)	2004.06-						GC044002	Outer Joint	29T	22	23	52	97.5	61	M			
<b>TIGRA TWINTOP</b>																		
1.3 CDTi (51 kW)	2004.06-				F	Convertible Engine Z13DT	GC044020	Outer Joint	29T	22	28	52	97.5	57.5	O			
	2004.06-				F	Convertible Engine Z13DT	GCI44009	Inner Joint		22	23	35	57.5	96				
	2004.06-			L	F	Convertible Engine Z13DT	GDS44045	Drive Shaft	29T	22	22	52	97	579				
	2004.06-		MT/AT	L	F	Convertible Engine Z13DT	GDS44027	Drive Shaft	29T	22	22	52	98	580				
	2004.06-			R	F	Convertible Engine Z13DT	GDS44075	Drive Shaft	29T	22	22	52	97.5	926				
	2004.06-		MT/AT	R	F	Convertible Engine Z13DT	GDS44026	Drive Shaft	29T	22	22	52	98	930				
1.4 (66 kW)	2006.11-	2008.03			F	Convertible Engine Z14XEP	GC044020	Outer Joint	29T	22	28	52	97.5	57.5	O			
	2006.11-	2008.03		L	F	Convertible Engine Z14XEP	GDS44045	Drive Shaft	29T	22	22	52	97	579				
	2006.11-	2008.03	MT/AT	L	F	Convertible Engine Z14XEP	GDS44027	Drive Shaft	29T	22	22	52	98	580				
	2006.11-	2008.03		R	F	Convertible Engine Z14XEP	GDS44075	Drive Shaft	29T	22	22	52	97.5	926				
	2006.11-	2008.03	MT/AT	R	F	Convertible Engine Z14XEP	GDS44026	Drive Shaft	29T	22	22	52	98	930				
1.8 (92 kW)	2006.11-	2008.03			F	Convertible Engine Z18XE	GC044002	Outer Joint	29T	22	23	52	97.5	61	M			
	2006.11-	2008.03			F	Convertible Engine Z18XE	GCI44009	Inner Joint		22	23	35	57.5	96				
	2006.11-	2008.03		L	F	Convertible Engine Z18XE	GDS44027	Drive Shaft	29T	22	22	52	98	580				
	2006.11-	2008.03		L	F	Convertible Engine Z18XE	GDS44045	Drive Shaft	29T	22	22	52	97	579				
	2006.11-	2008.03		R	F	Convertible Engine Z18XE	GDS44075	Drive Shaft	29T	22	22	52	97.5	926				
	2006.11-	2008.03		R	F	Convertible Engine Z18XE	GDS44026	Drive Shaft	29T	22	22	52	98	930				
<b>VECTRA A (86, 87)</b>																		
1.7 D (42 kW)	1988.10-	1995.11				IWT+ATChK1000001-M1666666	GC044057	Outer Joint	43T	33	25	52	109	61	O			
1.7 D (44 kW)	1988.10-	1995.11				IWT+ATChK1000001-M1666666	GC044057	Outer Joint	43T	33	25	52	109	61	O			
1.7 TD (60 kW)	1990.03-	1995.11				Ch-K1000001-M1999999	GC044057	Outer Joint	43T	33	25	52	109	61	O			
1.8 S 4WD Kat (65 kW)	1988.09-	1990.10	MT/AT			FWChK1000001-M1999999	GC044057	Outer Joint	43T	33	25	52	109	61	O			
1.8 S 4WD Kat (66 kW)	1988.09-	1990.10	MT/AT			FWChK1000001-M1999999	GC044057	Outer Joint	43T	33	25	52	109	61	O			
2.0 GT 16V Kat 4WD (110 kW)	1989.01-	1995.11			F	MFTChK100001-M1999999	GC044057	Outer Joint	43T	33	25	52	109	61	O			
2.0 i (74 kW)	1988.09-	1989.09	MT/AT			Ch-K1000001-M1999999	GC044057	Outer Joint	43T	33	25	52	109	61	O			
2.0 i 16V 4WD (100 kW)	1994.06-	1995.11	MT		F	Ch-K1000001-M1999999	GC044057	Outer Joint	43T	33	25	52	109	61	O			
2.0 i 4WD (85 kW)	1988.09-	1992.09				m+NIChK1000001-M1999999	GC044057	Outer Joint	43T	33	25	52	109	61	O			
2.0 i 4WD (95 kW)	1988.09-	1992.09				m+NIChK1000001-M1999999	GC044057	Outer Joint	43T	33	25	52	109	61	O			
2.0 i 4WD Kat (85 kW)	1989.01-	1995.11				IWT+MChK1000001-M1999999	GC044057	Outer Joint	43T	33	25	52	109	61	O			
<b>VECTRA A (86_, 87_)</b>																		
1.4 S (55 kW)	1988.09-	1992.06	MT		F	Saloon Engine 14NV	GCI44004	Inner Joint		22	22	34.95	57.5	72.5				
	1988.09-	1992.06	MT	L	F	Saloon Engine 14NV	GDS44002	Drive Shaft	29T	22	22	52	95	585				
	1988.09-	1992.06	MT/AT		F	Saloon Engine 14NV	GC044055	Outer Joint	43T	22	22	52	95	50.5	O			
	1988.09-	1992.06	MT/AT		F	Saloon Engine 14NV	GC044051	Outer Joint	29T	22	22	52	95	50.5	O			
1.6 (60 kW)	1988.09-	1993.05	MT		F	Saloon Engine 16SV	GCI44004	Inner Joint		22	22	34.95	57.5	72.5				
	1988.09-	1993.05	MT	L	F	Saloon Engine 16SV	GDS44002	Drive Shaft	29T	22	22	52	95	585				
	1988.09-	1993.05	MT		F	Saloon Engine 16SV	GC044055	Outer Joint	43T	22	22	52	95	50.5	O			
	1988.09-	1993.05	MT		F	Saloon Engine 16SV	GC044051	Outer Joint	29T	22	22	52	95	50.5	O			
1.6 i (52 kW)	1993.09-	1995.11	MT		F	Saloon Engine X16SZ	GCI44004	Inner Joint		22	22	34.95	57.5	72.5				
	1993.09-	1995.11	MT		F	Saloon Engine X16SZ	GC044051	Outer Joint	29T	22	22	52	95	50.5	O			
1.6 i (55 kW)	1988.09-	1995.11	MT		F	Saloon Engine C16NZ2/E16NZ/C16NZ	GCI44004	Inner Joint		22	22	34.95	57.5	72.5				
	1988.09-	1995.11	MT/AT		F	Saloon Engine C16NZ2/E16NZ/C16NZ	GC044055	Outer Joint	43T	22	22	52	95	50.5	O			
	1993.09-	1995.11	MT		F	Saloon Engine 16LZ2	GCI44004	Inner Joint		22	22	34.95	57.5	72.5				
1.7 D (42 kW)	1988.10-	1992.09	MT/AT		F	Saloon Engine 17D	GC044057	Outer Joint	43T	33	25	52	109	61	O			
	1988.10-	1992.09	MT	L	F	Saloon Engine 17D	GDS44014	Drive Shaft	43T	33	34	52	103.5	587				
	1988.10-	1992.09	MT	R	F	Saloon Engine 17D	GDS44059	Drive Shaft	29T	33	34	52	109	938				
	1988.10-	1992.09	MT		F	Saloon Engine 17D	GCI44004	Inner Joint		22	22	34.95	57.5	72.5				
	1988.10-	1992.09	MT	L	F	Saloon Engine 17D	GDS44011	Drive Shaft	29T	33	34	52	109	594.5				
	1988.10-	1992.09	MT/AT		F	Saloon Engine 17D	GC044056	Outer Joint	29T	33	25	52	109	61	O			
	1988.10-	1992.09	MT		F	Saloon Engine 17D	GCI44002	Inner Joint		34	25	35	56.2	85.6				
1.7 D (44 kW)	1992.07-	1995.11	MT		F	Saloon Engine 17DR	GCI44004	Inner Joint		22	22	34.95	57.5	72.5				
	1992.07-	1995.11	MT	L	F	Saloon Engine 17DR	GDS44011	Drive Shaft	29T	33	34	52	109	594.5				
	1992.07-	1995.11			F	Saloon Engine 17DR	GC044056	Outer Joint	29T	33	25	52	109	61	O			



		TRANSM	L/R	F/R		G-AP Ref.	PRODUCT	ABS	Technical Specifications								
									YEAR	A	B	C	H	L	P		
<b>OPEL</b>																	
<b>VECTRA A (86_, 87_)</b>																	
1.7 D (44 kW)	1992.07-	1995.11	MT		F	Saloon Engine 17DR	GCI44002	Inner Joint		34	25	35	56.2	85.6			
	1992.07-	1995.11	MT	R	F	Saloon Engine 17DR	GDS44059	Drive Shaft	29T	33	34	52	109	938			
1.7 TD (60 kW)	1990.03-	1995.11	MT	L	F	Saloon Engine 17DT(TC4EE1)/X17DT(TC4EE1)	GDS44014	Drive Shaft	43T	33	34	52	103.5	587			
	1990.03-	1995.11	MT	R	F	Saloon Engine 17DT(TC4EE1)/X17DT(TC4EE1)	GDS44059	Drive Shaft	29T	33	34	52	109	938			
	1990.03-	1995.11	MT	L	F	Saloon Engine 17DT(TC4EE1)/X17DT(TC4EE1)	GDS44011	Drive Shaft	29T	33	34	52	109	594.5			
	1990.03-	1995.11	MT/AT		F	Saloon Engine 17DT(TC4EE1)/X17DT(TC4EE1)	GC044056	Outer Joint	29T	33	25	52	109	61	O		
	1990.03-	1995.11	MT		F	Saloon Engine 17DT(TC4EE1)/X17DT(TC4EE1)	GCI44002	Inner Joint		34	25	35	56.2	85.6			
	1990.03-	1995.11	MT		F	Saloon Engine 17DT(TC4EE1)/X17DT(TC4EE1)	GC044057	Outer Joint	43T	33	25	52	109	61	O		
1.8 i CAT (66 kW)	1990.03-	1995.11	MT	L	F	Saloon Engine C18NZ	GDS44014	Drive Shaft	43T	33	34	52	103.5	587			
	1990.03-	1995.11	MT	R	F	Saloon Engine C18NZ	GDS44059	Drive Shaft	29T	33	34	52	109	938			
	1990.03-	1995.11	MT	L	F	Saloon Engine C18NZ	GDS44011	Drive Shaft	29T	33	34	52	109	594.5			
	1990.03-	1995.11	MT/AT		F	Saloon Engine C18NZ	GC044056	Outer Joint	29T	33	25	52	109	61	O		
	1990.03-	1995.11	MT		F	Saloon Engine C18NZ	GCI44002	Inner Joint		34	25	35	56.2	85.6			
	1990.03-	1995.11	MT/AT		F	Saloon Engine C18NZ	GC044057	Outer Joint	43T	33	25	52	109	61	O		
1.8 S (65 kW)	1988.09-	1989.07	MT	L	F	Saloon Engine E18NVR	GDS44014	Drive Shaft	43T	33	34	52	103.5	587			
	1988.09-	1989.07	MT		F	Saloon Engine E18NVR	GCI44002	Inner Joint		34	25	35	56.2	85.6			
	1988.09-	1989.07	MT/AT		F	Saloon Engine E18NVR	GC044057	Outer Joint	43T	33	25	52	109	61	O		
1.8 S (66 kW)	1989.09-	1990.10	MT	L	F	Saloon Engine 18SV	GDS44014	Drive Shaft	43T	33	34	52	103.5	587			
	1989.09-	1990.10	MT		F	Saloon Engine 18SV	GCI44002	Inner Joint		34	25	35	56.2	85.6			
	1989.09-	1990.10	MT/AT		F	Saloon Engine 18SV	GC044057	Outer Joint	43T	33	25	52	109	61	O		
1.8 S 4x4 (65 kW)	1989.01-	1989.07	MT	L	F	Saloon Engine E18NVR	GDS44014	Drive Shaft	43T	33	34	52	103.5	587			
	1989.01-	1989.07	MT		F	Saloon Engine E18NVR	GCI44002	Inner Joint		34	25	35	56.2	85.6			
	1989.01-	1989.07	MT/AT			Saloon Engine E18NVR	GC044057	Outer Joint	43T	33	25	52	109	61	O		
2.0 (74 kW)	1988.09-	1989.09	MT	L	F	Saloon Engine C20NEF	GDS44014	Drive Shaft	43T	33	34	52	103.5	587			
	1988.09-	1989.09	MT		F	Saloon Engine C20NEF	GCI44002	Inner Joint		34	25	35	56.2	85.6			
	1988.09-	1989.09	MT		F	Saloon Engine C20NEF	GC044057	Outer Joint	43T	33	25	52	109	61	O		
2.0 16V 4x4 (110 kW)	1989.01-	1990.10	MT		F	Saloon Engine 20XEJ	GCI44002	Inner Joint		34	25	35	56.2	85.6			
	1989.01-	1990.10	MT		F	Saloon Engine 20XEJ	GCI44005	Inner Joint		34	25	35	54	47			
	1989.01-	1990.10	MT			Saloon Engine 20XEJ	GC044057	Outer Joint	43T	33	25	52	109	61	O		
2.0 GT 16V (110 kW)	1989.01-	1994.06	MT		F	Saloon Engine 20XEJ	GCI44002	Inner Joint		34	25	35	56.2	85.6			
	1989.01-	1994.06	MT	L	F	Saloon Engine 20XEJ	GDS44014	Drive Shaft	43T	33	34	52	103.5	587			
	1989.01-	1994.06	MT		F	Saloon Engine 20XEJ	GCI44005	Inner Joint		34	25	35	54	47			
	1989.01-	1994.06	MT	L	F	Saloon Engine 20XEJ	GDS44011	Drive Shaft	29T	33	34	52	109	594.5			
	1989.01-	1994.06	MT		F	Saloon Engine 20XEJ	GC044056	Outer Joint	29T	33	25	52	109	61	O		
	1989.01-	1994.06	MT		F	Saloon Engine 20XEJ	GC044057	Outer Joint	43T	33	25	52	109	61	O		
2.0 GT 16V 4x4 CAT (110 kW)	1990.02-	1995.11	MT		F	Saloon Engine C20XE	GCI44002	Inner Joint		34	25	35	56.2	85.6			
	1990.02-	1995.11	MT		F	Saloon Engine C20XE	GCI44005	Inner Joint		34	25	35	54	47			
	1990.02-	1995.11	MT		F	Saloon Engine C20XE	GC044056	Outer Joint	29T	33	25	52	109	61	O		
	1990.02-	1995.11	MT			Saloon Engine C20XE	GC044057	Outer Joint	43T	33	25	52	109	61	O		
2.0 GT 16V CAT (110 kW)	1990.02-	1995.11	MT		F	Saloon Engine C20XE	GCI44002	Inner Joint		34	25	35	56.2	85.6			
	1990.02-	1995.11	MT	L	F	Saloon Engine C20XE	GDS44014	Drive Shaft	43T	33	34	52	103.5	587			
	1990.02-	1995.11	MT		F	Saloon Engine C20XE	GCI44005	Inner Joint		34	25	35	54	47			
	1990.02-	1995.11	MT	L	F	Saloon Engine C20XE	GDS44011	Drive Shaft	29T	33	34	52	109	594.5			
	1990.02-	1995.11	MT		F	Saloon Engine C20XE	GC044056	Outer Joint	29T	33	25	52	109	61	O		
	1990.02-	1995.11	MT		F	Saloon Engine C20XE	GC044057	Outer Joint	43T	33	25	52	109	61	O		
2.0 i (85 kW)	1988.09-	1990.10	MT	L	F	Saloon Engine 20NE	GDS44014	Drive Shaft	43T	33	34	52	103.5	587			
	1988.09-	1990.10	MT		F	Saloon Engine 20NE	GCI44002	Inner Joint		34	25	35	56.2	85.6			
	1988.09-	1990.10	MT/AT		F	Saloon Engine 20NE	GC044057	Outer Joint	43T	33	25	52	109	61	O		
2.0 i (95 kW)	1988.09-	1992.09	MT	L	F	Saloon Engine 20SEH	GDS44014	Drive Shaft	43T	33	34	52	103.5	587			
	1988.09-	1992.09	MT	R	F	Saloon Engine 20SEH	GDS44059	Drive Shaft	29T	33	34	52	109	938			
	1988.09-	1992.09	MT	L	F	Saloon Engine 20SEH	GDS44011	Drive Shaft	29T	33	34	52	109	594.5			
	1988.09-	1992.09	MT		F	Saloon Engine 20SEH	GC044056	Outer Joint	29T	33	25	52	109	61	O		
	1988.09-	1992.09	MT		F	Saloon Engine 20SEH	GCI44002	Inner Joint		34	25	35	56.2	85.6			
	1988.09-	1992.09	MT		F	Saloon Engine 20SEH	GC044057	Outer Joint	43T	33	25	52	109	61	O		
2.0 i 16V (100 kW)	1994.06-	1995.11	MT		F	Saloon Engine X20XEV	GCI44005	Inner Joint		34	25	35	54	47			
	1994.06-	1995.11	MT		F	Saloon Engine X20XEV	GCI44002	Inner Joint		34	25	35	56.2	85.6			
2.0 i 16V 4x4 (100 kW)	1994.06-	1995.11	MT		F	Saloon Engine X20XEV	GCI44005	Inner Joint		34	25	35	54	47			
	1994.06-	1995.11	MT		F	Saloon Engine X20XEV	GCI44002	Inner Joint		34	25	35	56.2	85.6			
2.0 i 4x4 (85 kW)	1989.01-	1990.10	MT		F	Saloon Engine 20NE	GCI44005	Inner Joint		34	25	35	54	47			
	1989.01-	1990.10	MT		F	Saloon Engine 20NE	GCI44002	Inner Joint		34	25	35	56.2	85.6			
	1989.01-	1990.10	MT			Saloon Engine 20NE	GC044057	Outer Joint	43T	33	25	52	109	61	O		





		TRANSM	L/R	F/R		G-AP Ref.	PRODUCT	ABS	Technical Specifications								
									YEAR	A	B	C	H	L	P		
<b>OPEL</b>																	
<b>VECTRA A (86_, 87_)</b>																	
2.0 i 4x4 (95 kW)	1989.01-	1992.09	MT		F	Saloon Engine 20SEH	GCI44005	Inner Joint		34	25	35	54	47			
	1989.01-	1992.09	MT		F	Saloon Engine 20SEH	GC044056	Outer Joint	29T	33	25	52	109	61	O		
	1989.01-	1992.09	MT		F	Saloon Engine 20SEH	GCI44002	Inner Joint		34	25	35	56.2	85.6			
	1989.01-	1992.09	MT			Saloon Engine 20SEH	GC044057	Outer Joint	43T	33	25	52	109	61	O		
2.0 i 4x4 CAT (85 kW)	1989.01-	1995.11	MT		F	Saloon Engine C20NE	GCI44005	Inner Joint		34	25	35	54	47			
	1989.01-	1995.11	MT		F	Saloon Engine C20NE	GC044056	Outer Joint	29T	33	25	52	109	61	O		
	1989.01-	1995.11	MT		F	Saloon Engine C20NE	GCI44002	Inner Joint		34	25	35	56.2	85.6			
	1989.01-	1995.11	MT			Saloon Engine C20NE	GC044057	Outer Joint	43T	33	25	52	109	61	O		
2.0 i CAT (85 kW)	1988.09-	1995.11	MT	L	F	Saloon Engine C20NE	GDS44014	Drive Shaft	43T	33	34	52	103.5	587			
	1988.09-	1995.11	MT	R	F	Saloon Engine C20NE	GDS44059	Drive Shaft	29T	33	34	52	109	938			
	1988.09-	1995.11	MT	L	F	Saloon Engine C20NE	GDS44011	Drive Shaft	29T	33	34	52	109	594.5			
	1988.09-	1995.11	MT/AT		F	Saloon Engine C20NE	GC044056	Outer Joint	29T	33	25	52	109	61	O		
	1988.09-	1995.11	MT		F	Saloon Engine C20NE	GCI44002	Inner Joint		34	25	35	56.2	85.6			
	1988.09-	1995.11	MT/AT		F	Saloon Engine C20NE	GC044057	Outer Joint	43T	33	25	52	109	61	O		
2.5 V6 (125 kW)	1993.02-	1995.11	MT		F	Saloon Engine C25XE	GCI44002	Inner Joint		34	25	35	56.2	85.6			
	1993.02-	1995.11	MT		F	Saloon Engine C25XE	GCI44005	Inner Joint		34	25	35	54	47			
<b>VECTRA A (88_, 89_)</b>																	
1.4 S (55 kW)	1988.04-	1992.06	MT		F	Hatchback Engine 14NV	GCI44004	Inner Joint		22	22	34.95	57.5	72.5			
	1988.04-	1992.06	MT	L	F	Hatchback Engine 14NV	GDS44002	Drive Shaft	29T	22	22	52	95	585			
	1988.04-	1992.06	MT/AT		F	Hatchback Engine 14NV	GC044055	Outer Joint	43T	22	22	52	95	50.5	O		
	1988.04-	1992.06	MT/AT		F	Hatchback Engine 14NV	GC044051	Outer Joint	29T	22	22	52	95	50.5	O		
1.6 i (52 kW)	1993.09-	1995.11	MT		F	Hatchback Engine X16SZ	GCI44004	Inner Joint		22	22	34.95	57.5	72.5			
1.6 i (55 kW)	1993.09-	1995.11	MT		F	Hatchback Engine 16LZ2	GCI44004	Inner Joint		22	22	34.95	57.5	72.5			
1.6 i CAT (55 kW)	1988.09-	1995.11	MT		F	Hatchback Engine C16NZ/C16NZ2	GCI44004	Inner Joint		22	22	34.95	57.5	72.5			
	1988.09-	1995.11	MT	L	F	Hatchback Engine C16NZ/C16NZ2	GDS44002	Drive Shaft	29T	22	22	52	95	585			
	1988.09-	1995.11	MT/AT		F	Hatchback Engine C16NZ/C16NZ2	GC044055	Outer Joint	43T	22	22	52	95	50.5	O		
	1988.09-	1995.11	MT/AT		F	Hatchback Engine C16NZ/C16NZ2	GC044051	Outer Joint	29T	22	22	52	95	50.5	O		
1.6 S (60 kW)	1988.09-	1993.05	MT		F	Hatchback Engine 16SV	GCI44004	Inner Joint		22	22	34.95	57.5	72.5			
	1988.09-	1993.05	MT	L	F	Hatchback Engine 16SV	GDS44002	Drive Shaft	29T	22	22	52	95	585			
	1988.09-	1993.05	MT/AT		F	Hatchback Engine 16SV	GC044055	Outer Joint	43T	22	22	52	95	50.5	O		
	1988.09-	1993.05	MT/AT		F	Hatchback Engine 16SV	GC044051	Outer Joint	29T	22	22	52	95	50.5	O		
1.7 D (42 kW)	1988.09-	1992.09	MT		F	Hatchback Engine 17D	GCI44002	Inner Joint		34	25	35	56.2	85.6			
	1988.09-	1992.09	MT	L	F	Hatchback Engine 17D	GDS44014	Drive Shaft	43T	33	34	52	103.5	587			
	1988.09-	1992.09	MT	R	F	Hatchback Engine 17D	GDS44059	Drive Shaft	29T	33	34	52	109	938			
	1988.09-	1992.09	MT		F	Hatchback Engine 17D	GCI44004	Inner Joint		22	22	34.95	57.5	72.5			
	1988.09-	1992.09	MT	L	F	Hatchback Engine 17D	GDS44011	Drive Shaft	29T	33	34	52	109	594.5			
	1988.09-	1992.09	MT/AT		F	Hatchback Engine 17D	GC044056	Outer Joint	29T	33	25	52	109	61	O		
	1988.09-	1992.09	MT/AT		F	Hatchback Engine 17D	GC044057	Outer Joint	43T	33	25	52	109	61	O		
1.7 D (44 kW)	1992.07-	1995.11	MT		F	Hatchback Engine 17DR	GCI44002	Inner Joint		34	25	35	56.2	85.6			
	1992.07-	1995.11	MT	R	F	Hatchback Engine 17DR	GDS44059	Drive Shaft	29T	33	34	52	109	938			
	1992.07-	1995.11	MT		F	Hatchback Engine 17DR	GCI44004	Inner Joint		22	22	34.95	57.5	72.5			
	1992.07-	1995.11	MT	L	F	Hatchback Engine 17DR	GDS44011	Drive Shaft	29T	33	34	52	109	594.5			
	1992.07-	1995.11			F	Hatchback Engine 17DR	GC044056	Outer Joint	29T	33	25	52	109	61	O		
1.7 TD (60 kW)	1990.03-	1995.11	MT		F	Hatchback Engine X17DT(TC4EE1)/17DT(TC4EE1)	GCI44002	Inner Joint		34	25	35	56.2	85.6			
	1990.03-	1995.11	MT	L	F	Hatchback Engine X17DT(TC4EE1)/17DT(TC4EE1)	GDS44014	Drive Shaft	43T	33	34	52	103.5	587			
	1990.03-	1995.11	MT	R	F	Hatchback Engine X17DT(TC4EE1)/17DT(TC4EE1)	GDS44059	Drive Shaft	29T	33	34	52	109	938			
	1990.03-	1995.11	MT	L	F	Hatchback Engine X17DT(TC4EE1)/17DT(TC4EE1)	GDS44011	Drive Shaft	29T	33	34	52	109	594.5			
	1990.03-	1995.11	MT/AT		F	Hatchback Engine X17DT(TC4EE1)/17DT(TC4EE1)	GC044056	Outer Joint	29T	33	25	52	109	61	O		
	1990.03-	1995.11	MT		F	Hatchback Engine X17DT(TC4EE1)/17DT(TC4EE1)	GC044057	Outer Joint	43T	33	25	52	109	61	O		
1.8 i (66 kW)	1988.09-	1990.10	MT		F	Hatchback Engine 18SV	GCI44002	Inner Joint		34	25	35	56.2	85.6			
	1988.09-	1990.10	MT	L	F	Hatchback Engine 18SV	GDS44014	Drive Shaft	43T	33	34	52	103.5	587			
	1988.09-	1990.10	MT/AT		F	Hatchback Engine 18SV	GC044057	Outer Joint	43T	33	25	52	109	61	O		
1.8 i CAT (66 kW)	1990.03-	1995.11	MT		F	Hatchback Engine C18NZ	GCI44002	Inner Joint		34	25	35	56.2	85.6			
	1990.03-	1995.11	MT	L	F	Hatchback Engine C18NZ	GDS44014	Drive Shaft	43T	33	34	52	103.5	587			
	1990.03-	1995.11	MT	R	F	Hatchback Engine C18NZ	GDS44059	Drive Shaft	29T	33	34	52	109	938			
	1990.03-	1995.11	MT	L	F	Hatchback Engine C18NZ	GDS44011	Drive Shaft	29T	33	34	52	109	594.5			
	1990.03-	1995.11	MT/AT		F	Hatchback Engine C18NZ	GC044056	Outer Joint	29T	33	25	52	109	61	O		
	1990.03-	1995.11	MT/AT		F	Hatchback Engine C18NZ	GC044057	Outer Joint	43T	33	25	52	109	61	O		
1.8 S (65 kW)	1988.09-	1989.07	MT		F	Hatchback Engine E18NVR	GCI44002	Inner Joint		34	25	35	56.2	85.6			
	1988.09-	1989.07	MT	L	F	Hatchback Engine E18NVR	GDS44014	Drive Shaft	43T	33	34	52	103.5	587			
	1988.09-	1989.07	MT/AT		F	Hatchback Engine E18NVR	GC044057	Outer Joint	43T	33	25	52	109	61	O		









		TRANSM	L/R	F/R		G-AP Ref.	PRODUCT	ABS	Technical Specifications					
									YEAR	A	B	C	H	L
<b>OPEL</b>														
<b>VECTRA A (88_, 89_)</b>														
2.0 (74 kW)	1988.04-	1989.09	MT		F	Hatchback Engine C20NEF	GCI44002	Inner Joint		34	25	35	56.2	85.6
	1988.04-	1989.09	MT	L	F	Hatchback Engine C20NEF	GDS44014	Drive Shaft	43T	33	34	52	103.5	587
	1988.04-	1989.09	MT		F	Hatchback Engine C20NEF	GC044057	Outer Joint	43T	33	25	52	109	61 O
2.0 i (85 kW)	1988.09-	1990.10	MT		F	Hatchback Engine 20NE	GCI44002	Inner Joint		34	25	35	56.2	85.6
	1988.09-	1990.10	MT	L	F	Hatchback Engine 20NE	GDS44014	Drive Shaft	43T	33	34	52	103.5	587
	1988.09-	1990.10	MT/AT		F	Hatchback Engine 20NE	GC044057	Outer Joint	43T	33	25	52	109	61 O
2.0 i 16V (100 kW)	1994.06-	1995.11	MT		F	Hatchback Engine X20XE	GCI44002	Inner Joint		34	25	35	56.2	85.6
	1994.06-	1995.11	MT		F	Hatchback Engine X20XE	GCI44005	Inner Joint		34	25	35	54	47
2.0 i 16V (110 kW)	1989.02-	1990.10	MT		F	Hatchback Engine 20XEJ	GCI44002	Inner Joint		34	25	35	56.2	85.6
	1989.02-	1990.10	MT	L	F	Hatchback Engine 20XEJ	GDS44014	Drive Shaft	43T	33	34	52	103.5	587
	1989.02-	1990.10	MT		F	Hatchback Engine 20XEJ	GCI44005	Inner Joint		34	25	35	54	47
	1989.02-	1990.10	MT		F	Hatchback Engine 20XEJ	GC044057	Outer Joint	43T	33	25	52	109	61 O
2.0 i 16V CAT (110 kW)	1990.02-	1995.11	MT		F	Hatchback Engine C20XE	GCI44002	Inner Joint		34	25	35	56.2	85.6
	1990.02-	1995.11	MT	L	F	Hatchback Engine C20XE	GDS44014	Drive Shaft	43T	33	34	52	103.5	587
	1990.02-	1995.11	MT		F	Hatchback Engine C20XE	GCI44005	Inner Joint		34	25	35	54	47
	1990.02-	1995.11	MT	L	F	Hatchback Engine C20XE	GDS44011	Drive Shaft	29T	33	34	52	109	594.5
	1990.02-	1995.11	MT		F	Hatchback Engine C20XE	GC044056	Outer Joint	29T	33	25	52	109	61 O
2.0 i CAT (85 kW)	1988.09-	1995.11	MT		F	Hatchback Engine C20NE	GCI44002	Inner Joint		34	25	35	56.2	85.6
	1988.09-	1995.11	MT	L	F	Hatchback Engine C20NE	GDS44014	Drive Shaft	43T	33	34	52	103.5	587
	1988.09-	1995.11	MT	R	F	Hatchback Engine C20NE	GDS44059	Drive Shaft	29T	33	34	52	109	938
	1988.09-	1995.11	MT	L	F	Hatchback Engine C20NE	GDS44011	Drive Shaft	29T	33	34	52	109	594.5
	1988.09-	1995.11	MT/AT		F	Hatchback Engine C20NE	GC044056	Outer Joint	29T	33	25	52	109	61 O
	1988.09-	1995.11	MT/AT		F	Hatchback Engine C20NE	GC044057	Outer Joint	43T	33	25	52	109	61 O
2.0 i GT (95 kW)	1988.09-	1995.11	MT		F	Hatchback Engine 20SEH	GCI44002	Inner Joint		34	25	35	56.2	85.6
	1988.09-	1995.11	MT	L	F	Hatchback Engine 20SEH	GDS44014	Drive Shaft	43T	33	34	52	103.5	587
	1988.09-	1995.11	MT	R	F	Hatchback Engine 20SEH	GDS44059	Drive Shaft	29T	33	34	52	109	938
	1988.09-	1995.11	MT	L	F	Hatchback Engine 20SEH	GDS44011	Drive Shaft	29T	33	34	52	109	594.5
	1988.09-	1995.11	MT/AT		F	Hatchback Engine 20SEH	GC044056	Outer Joint	29T	33	25	52	109	61 O
	1988.09-	1995.11	MT/AT		F	Hatchback Engine 20SEH	GC044057	Outer Joint	43T	33	25	52	109	61 O
2.5 V6 (125 kW)	1993.02-	1995.11	MT		F	Hatchback Engine C25XE	GCI44002	Inner Joint		34	25	35	56.2	85.6
	1993.02-	1995.11	MT		F	Hatchback Engine C25XE	GCI44005	Inner Joint		34	25	35	54	47
<b>VECTRA B (31_)</b>														
1.6 i 16V (74 kW)	1996.11-	2002.07			F	Estate Engine X16XEL/Y16XE/Z16XE	GC044011	Outer Joint	29T	33	22	52	103	50.5 O
	1996.11-	2002.07	MT/AT		F	Estate Engine X16XEL/Y16XE/Z16XE	GC044007	Outer Joint	29T	22	22	52	94.5	50 O
	1996.11-	2002.07		L	F	Estate Engine X16XEL/Y16XE/Z16XE	GDS44076	Drive Shaft	29T	22	22	52	95	592
	1996.11-	2002.07		L	F	Estate Engine X16XEL/Y16XE/Z16XE	GCI21014	Inner Joint		22	22	35	57.5	75
	1996.11-	2002.07		R	F	Estate Engine X16XEL/Y16XE/Z16XE	GDS44077	Drive Shaft	29T	22	22	52	95	955
	1996.11-	2002.07		R	F	Estate Engine X16XEL/Y16XE/Z16XE	GCI21014	Inner Joint		22	22	35	57.5	75
1.8 i 16V (92 kW)	2000.09-	2003.07	MT/AT		F	Estate Engine Z18XE	GC044006	Outer Joint	29T	33	25	52	103.5	61 O
2.0 DTi 16V (74 kW)	1997.06-	2003.07	MT/AT		F	Estate Engine X20DTH/Y20DTH	GC044006	Outer Joint	29T	33	25	52	103.5	61 O
	1997.06-	2003.07	5MT	L	F	Estate Engine X20DTH/Y20DTH	GDS44038	Drive Shaft	29T	33	34	52	103.5	595
	1997.06-	2003.07	5MT	R	F	Estate Engine X20DTH/Y20DTH	GDS44039	Drive Shaft	29T	33	34	52	103.5	959
2.0 i (82 kW)	1996.11-	2002.02			F	Estate Engine 20NEJ	GC044049	Outer Joint		33	25	52	109	61 O
	1996.11-	2002.02	MT/AT		F	Estate Engine 20NEJ	GC044006	Outer Joint	29T	33	25	52	103.5	61 O
	1996.11-	2002.02	5MT	L	F	Estate Engine 20NEJ	GDS44038	Drive Shaft	29T	33	34	52	103.5	595
	1996.11-	2002.02	5MT	R	F	Estate Engine 20NEJ	GDS44039	Drive Shaft	29T	33	34	52	103.5	959
2.2 DTi 16V (92 kW)	2000.09-	2003.07			F	Estate Engine Y22DTR	GC044065	Outer Joint	29T	33	35	55	104	67.5 I
2.2 i 16V (108 kW)	2000.09-	2003.07	5MT/4AT	L	R	Estate Engine Z22SE	GDS44038	Drive Shaft	29T	33	34	52	103.5	595
	2000.09-	2003.07	5MT/4AT	R	R	Estate Engine Z22SE	GDS44039	Drive Shaft	29T	33	34	52	103.5	959
<b>VECTRA B (36), SW</b>														
1.6 i (55 kW)	1995.10-	2002.04				Ch-W1285446	GC044060	Outer Joint	29T	22	22	52	98	51 O
	1995.10-	2002.04					GCI21014	Inner Joint		22	22	35	57.5	75
1.6 i 16V (74 kW)	1995.10-	2002.04				Ch-W1285446	GC044060	Outer Joint	29T	22	22	52	98	51 O
	1995.10-	2002.04					GCI21014	Inner Joint		22	22	35	57.5	75
1.8 i 16V (85 kW)	1995.10-	2002.04					GCI21011	Inner Joint		34	25	35	78	64
	1995.10-	2002.04					GC044006	Outer Joint	29T	33	25	52	103.5	61 O
1.8 i 16V (92 kW)	1995.10-	2002.04					GCI21011	Inner Joint		34	25	35	78	64
	1995.10-	2002.04					GC044006	Outer Joint	29T	33	25	52	103.5	61 O
2.0 Di 16V (60 kW)	1996.11-	2002.04					GC044006	Outer Joint	29T	33	25	52	103.5	61 O
2.0 Di 16V (60 kW)	1996.11-	2002.04					GCI21011	Inner Joint		34	25	35	78	64



		TRANSM	L/R	F/R		G-AP Ref.	PRODUCT	ABS	Technical Specifications								
									YEAR	A	B	C	H	L	P		
<b>OPEL</b>																	
<b>VECTRA B (36), SW</b>																	
2.0 DTi 16V (74 kW)	1997.06-	2002.04				GCI21011	Inner Joint		34	25	35	78	64				
	1997.06-	2002.04				GC044006	Outer Joint	29T	33	25	52	103.5	61	O			
2.0 i 16V (100 kW)	1995.10-	2000.09				GCI21011	Inner Joint		34	25	35	78	64				
	1995.10-	2000.09				GC044006	Outer Joint	29T	33	25	52	103.5	61	O			
2.2 DTi 16V (92 kW)	2000.09-	2002.04				GC044065	Outer Joint	29T	33	35	55	104	67.5	I			
2.2 i 16V (108 kW)	2000.09-	2002.04				GCI21011	Inner Joint		34	25	35	78	64				
	2000.09-	2002.04				GC044006	Outer Joint	29T	33	25	52	103.5	61	O			
2.5 i (143 kW)	1998.05-	2000.09				GCI21011	Inner Joint		34	25	35	78	64				
	1998.05-	2000.09				GC044006	Outer Joint	29T	33	25	52	103.5	61	O			
2.5 i V6 (125 kW)	1995.10-	2000.09				GCI21011	Inner Joint		34	25	35	78	64				
	1995.10-	2000.09				GC044006	Outer Joint	29T	33	25	52	103.5	61	O			
<b>VECTRA B (36 _)</b>																	
1.6 i (55 kW)	1995.10-	2002.04			F	Saloon Engine 16LZ2	GC044011	Outer Joint	29T	33	22	52	103	50.5	O		
	1995.10-	2002.04			F	Saloon Engine X16SZR	GC044011	Outer Joint	29T	33	22	52	103	50.5	O		
	1995.10-	2002.04	MT/AT		F	Saloon Engine 16LZ2	GC044007	Outer Joint	29T	22	22	52	94.5	50	O		
	1995.10-	2002.04	MT/AT		F	Saloon Engine X16SZR	GC044007	Outer Joint	29T	22	22	52	94.5	50	O		
	1995.10-	2002.04		L	F	Saloon Engine 16LZ2	GDS44076	Drive Shaft	29T	22	22	52	95	592			
	1995.10-	2002.04		L	F	Saloon Engine X16SZR	GDS44076	Drive Shaft	29T	22	22	52	95	592			
	1995.10-	2002.04	5MT	L	F	Saloon Engine 16LZ2	GDS44038	Drive Shaft	29T	33	34	52	103.5	595			
	1995.10-	2002.04		L	F	Saloon Engine 16LZ2	GCI21014	Inner Joint		22	22	35	57.5	75			
	1995.10-	2002.04		L	F	Saloon Engine X16SZR	GCI21014	Inner Joint		22	22	35	57.5	75			
	1995.10-	2002.04		R	F	Saloon Engine 16LZ2	GDS44077	Drive Shaft	29T	22	22	52	95	955			
	1995.10-	2002.04		R	F	Saloon Engine X16SZR	GDS44077	Drive Shaft	29T	22	22	52	95	955			
	1995.10-	2002.04	5MT	R	F	Saloon Engine 16LZ2	GDS44039	Drive Shaft	29T	33	34	52	103.5	959			
	1995.10-	2002.04		R	F	Saloon Engine 16LZ2	GCI21014	Inner Joint		22	22	35	57.5	75			
	1995.10-	2002.04		R	F	Saloon Engine X16SZR	GCI21014	Inner Joint		22	22	35	57.5	75			
1.6 i 16V (74 kW)	1995.10-	2002.04			F	Saloon Engine X16XEL/Y16XE/Z16XE	GC044011	Outer Joint	29T	33	22	52	103	50.5	O		
	1995.10-	2002.04	MT/AT		F	Saloon Engine X16XEL/Y16XE/Z16XE	GC044007	Outer Joint	29T	22	22	52	94.5	50	O		
	1995.10-	2002.04		L	F	Saloon Engine X16XEL/Y16XE/Z16XE	GDS44076	Drive Shaft	29T	22	22	52	95	592			
	1995.10-	2002.04		L	F	Saloon Engine X16XEL/Y16XE/Z16XE	GCI21014	Inner Joint		22	22	35	57.5	75			
	1995.10-	2002.04		R	F	Saloon Engine X16XEL/Y16XE/Z16XE	GDS44077	Drive Shaft	29T	22	22	52	95	955			
	1995.10-	2002.04		R	F	Saloon Engine X16XEL/Y16XE/Z16XE	GCI21014	Inner Joint		22	22	35	57.5	75			
1.8 i 16V (92 kW)	2000.09-	2002.04	MT/AT		F	Saloon Engine Z18XE	GC044006	Outer Joint	29T	33	25	52	103.5	61	O		
2.0 Di 16V (60 kW)	1996.11-	2002.04	MT/AT		F	Saloon Engine X20DTL	GC044006	Outer Joint	29T	33	25	52	103.5	61	O		
	1996.11-	2002.04	5MT	L	F	Saloon Engine X20DTL	GDS44038	Drive Shaft	29T	33	34	52	103.5	595			
	1996.11-	2002.04	5MT	R	F	Saloon Engine X20DTL	GDS44039	Drive Shaft	29T	33	34	52	103.5	959			
2.0 DTi 16V (74 kW)	1997.06-	2002.04	MT/AT		F	Saloon Engine X20DTH/Y20DTH	GC044006	Outer Joint	29T	33	25	52	103.5	61	O		
	1997.06-	2002.04	5MT	L	F	Saloon Engine X20DTH/Y20DTH	GDS44038	Drive Shaft	29T	33	34	52	103.5	595			
	1997.06-	2002.04	5MT	R	F	Saloon Engine X20DTH/Y20DTH	GDS44039	Drive Shaft	29T	33	34	52	103.5	959			
2.0 i (82 kW)	1995.10-	2002.04			F	Saloon Engine 20NEJ	GC044049	Outer Joint		33	25	52	109	61	O		
	1995.10-	2002.04	MT/AT		F	Saloon Engine 20NEJ	GC044006	Outer Joint	29T	33	25	52	103.5	61	O		
	1995.10-	2002.04	5MT	L	F	Saloon Engine 20NEJ	GDS44038	Drive Shaft	29T	33	34	52	103.5	595			
	1995.10-	2002.04	5MT	R	F	Saloon Engine 20NEJ	GDS44039	Drive Shaft	29T	33	34	52	103.5	959			
2.2 DTi 16V (92 kW)	2000.09-	2002.04			F	Saloon Engine Y22DTR	GC044065	Outer Joint	29T	33	35	55	104	67.5	I		
2.2 i 16V (108 kW)	2000.09-	2002.04	5MT/4AT	L	R	Saloon Engine Z22SE	GDS44038	Drive Shaft	29T	33	34	52	103.5	595			
	2000.09-	2002.04	5MT/4AT	R	R	Saloon Engine Z22SE	GDS44039	Drive Shaft	29T	33	34	52	103.5	959			
<b>VECTRA B (38 _)</b>																	
1.6 i (55 kW)	1995.10-	2003.07			F	Hatchback Engine 16LZ2	GC044011	Outer Joint	29T	33	22	52	103	50.5	O		
	1995.10-	2003.07			F	Hatchback Engine X16SZR	GC044011	Outer Joint	29T	33	22	52	103	50.5	O		
	1995.10-	2003.07	MT/AT		F	Hatchback Engine 16LZ2	GC044007	Outer Joint	29T	22	22	52	94.5	50	O		
	1995.10-	2003.07	MT/AT		F	Hatchback Engine X16SZR	GC044007	Outer Joint	29T	22	22	52	94.5	50	O		
	1995.10-	2003.07		L	F	Hatchback Engine 16LZ2	GDS44076	Drive Shaft	29T	22	22	52	95	592			
	1995.10-	2003.07		L	F	Hatchback Engine X16SZR	GDS44076	Drive Shaft	29T	22	22	52	95	592			
	1995.10-	2003.07	5MT	L	F	Hatchback Engine 16LZ2	GDS44038	Drive Shaft	29T	33	34	52	103.5	595			
	1995.10-	2003.07		L	F	Hatchback Engine 16LZ2	GCI21014	Inner Joint		22	22	35	57.5	75			
	1995.10-	2003.07		L	F	Hatchback Engine X16SZR	GCI21014	Inner Joint		22	22	35	57.5	75			
	1995.10-	2003.07		R	F	Hatchback Engine 16LZ2	GDS44077	Drive Shaft	29T	22	22	52	95	955			
	1995.10-	2003.07		R	F	Hatchback Engine X16SZR	GDS44077	Drive Shaft	29T	22	22	52	95	955			
	1995.10-	2003.07	5MT	R	F	Hatchback Engine 16LZ2	GDS44039	Drive Shaft	29T	33	34	52	103.5	959			
	1995.10-	2003.07		R	F	Hatchback Engine 16LZ2	GCI21014	Inner Joint		22	22	35	57.5	75			
	1995.10-	2003.07		R	F	Hatchback Engine X16SZR	GCI21014	Inner Joint		22	22	35	57.5	75			

		TRANSM	L/R	F/R		G-AP Ref.	PRODUCT	ABS	Technical Specifications						
									YEAR	A	B	C	H	L	P
<b>OPEL</b>															
<b>VECTRA B (38_)</b>															
1.6 i 16V (74 kW)	1995.10-	2002.07			F	Hatchback Engine X16XEL/Y16XE/Z16XE	GC044011	Outer Joint	29T	33	22	52	103	50.5	O
	1995.10-	2002.07	MT/AT		F	Hatchback Engine X16XEL/Y16XE/Z16XE	GC044007	Outer Joint	29T	22	22	52	94.5	50	O
	1995.10-	2002.07		L	F	Hatchback Engine X16XEL/Y16XE/Z16XE	GDS44076	Drive Shaft	29T	22	22	52	95	592	
	1995.10-	2002.07		L	F	Hatchback Engine X16XEL/Y16XE/Z16XE	GCI21014	Inner Joint		22	22	35	57.5	75	
	1995.10-	2002.07		R	F	Hatchback Engine X16XEL/Y16XE/Z16XE	GDS44077	Drive Shaft	29T	22	22	52	95	955	
	1995.10-	2002.07		R	F	Hatchback Engine X16XEL/Y16XE/Z16XE	GCI21014	Inner Joint		22	22	35	57.5	75	
1.8 i 16V (92 kW)	2000.09-	2003.07	MT/AT		F	Hatchback Engine Z18XE	GC044006	Outer Joint	29T	33	25	52	103.5	61	O
2.0 DTi 16V (74 kW)	1997.06-	2003.07	MT/AT		F	Hatchback Engine X20DTH/Y20DTH	GC044006	Outer Joint	29T	33	25	52	103.5	61	O
	1997.06-	2003.07	5MT	L	F	Hatchback Engine X20DTH/Y20DTH	GDS44038	Drive Shaft	29T	33	34	52	103.5	595	
	1997.06-	2003.07	5MT	R	F	Hatchback Engine X20DTH/Y20DTH	GDS44039	Drive Shaft	29T	33	34	52	103.5	959	
2.0 i (82 kW)	1995.10-	2002.02			F	Hatchback Engine 20NEJ	GC044049	Outer Joint		33	25	52	109	61	O
	1995.10-	2002.02	MT/AT		F	Hatchback Engine 20NEJ	GC044006	Outer Joint	29T	33	25	52	103.5	61	O
	1995.10-	2002.02	5MT	L	F	Hatchback Engine 20NEJ	GDS44038	Drive Shaft	29T	33	34	52	103.5	595	
	1995.10-	2002.02	5MT	R	F	Hatchback Engine 20NEJ	GDS44039	Drive Shaft	29T	33	34	52	103.5	959	
2.2 DTi 16V (92 kW)	2000.09-	2003.07			F	Hatchback Engine Y22DTR	GC044065	Outer Joint	29T	33	35	55	104	67.5	I
2.2 i 16V (108 kW)	2000.09-	2003.07	5MT/4AT	L	F	Hatchback Engine Z22SE	GDS44038	Drive Shaft	29T	33	34	52	103.5	595	
	2000.09-	2003.07	5MT/4AT	R	F	Hatchback Engine Z22SE	GDS44039	Drive Shaft	29T	33	34	52	103.5	959	
<b>VECTRA C</b>															
1.6 (77 kW)	2006.01-				F	Estate Engine Z16XEP	GC021038	Outer Joint		30	24	52	94	64	M
	2006.01-				F	Estate Engine Z16XEP	GC017007	Outer Joint		30	25	52.5	105	62	O
	2006.01-				F	Saloon Engine Z16XEP	GC021038	Outer Joint		30	24	52	94	64	M
	2006.01-				F	Saloon Engine Z16XEP	GC017007	Outer Joint		30	25	52.5	105	62	O
	2006.01-		MT	L	F	Estate Engine Z16XEP	GDS44020	Drive Shaft		30	22	52.5	105	617.5	
	2006.01-		MT	L	F	Estate Engine Z16XEP	GCI99026	Inner Joint		22	25	35	57	82.5	
	2006.01-		MT	L	F	Estate Engine Z16XEP	GC017007	Outer Joint		30	25	52.5	105	62	O
	2006.01-		MT	L	F	Saloon Engine Z16XEP	GDS44020	Drive Shaft		30	22	52.5	105	617.5	
	2006.01-		MT	L	F	Saloon Engine Z16XEP	GCI99026	Inner Joint		22	25	35	57	82.5	
	2006.01-		MT	L	F	Saloon Engine Z16XEP	GC017007	Outer Joint		30	25	52.5	105	62	O
	2006.01-		MT	R	F	Estate Engine Z16XEP	GDS17040	Drive Shaft		30	22	52.5	105	987	
	2006.01-		MT	R	F	Saloon Engine Z16XEP	GDS17040	Drive Shaft		30	22	52.5	105	987	
	1.6 16V (74 kW)	2004.06-				F	Estate Engine Z16XE	GC021038	Outer Joint		30	24	52	94	64
2004.06-					F	Estate Engine Z16XE	GC017007	Outer Joint		30	25	52.5	105	62	O
2004.06-					F	Saloon Engine Z16XE	GC021038	Outer Joint		30	24	52	94	64	M
2004.06-					F	Saloon Engine Z16XE	GC017007	Outer Joint		30	25	52.5	105	62	O
2004.06-			MT	L	F	Estate Engine Z16XE	GDS44020	Drive Shaft		30	22	52.5	105	617.5	
2004.06-			MT	L	F	Estate Engine Z16XE	GCI99026	Inner Joint		22	25	35	57	82.5	
2004.06-			MT	L	F	Estate Engine Z16XE	GC017007	Outer Joint		30	25	52.5	105	62	O
2004.06-			MT	L	F	Saloon Engine Z16XE	GDS44020	Drive Shaft		30	22	52.5	105	617.5	
2004.06-			MT	L	F	Saloon Engine Z16XE	GCI99026	Inner Joint		22	25	35	57	82.5	
2004.06-			MT	L	F	Saloon Engine Z16XE	GC017007	Outer Joint		30	25	52.5	105	62	O
2004.06-			MT	R	F	Estate Engine Z16XE	GDS17040	Drive Shaft		30	22	52.5	105	987	
2004.06-			MT	R	F	Saloon Engine Z16XE	GDS17040	Drive Shaft		30	22	52.5	105	987	
1.6/1.8								GCI99026	Inner Joint		22	25	35	57	82.5
1.8 (103 kW)	2006.01-				F	Estate Engine Z18XER	GC017007	Outer Joint		30	25	52.5	105	62	O
	2006.01-				F	Saloon Engine Z18XER	GC017007	Outer Joint		30	25	52.5	105	62	O
	2006.01-		MT	L	F	Estate Engine Z18XER	GDS44020	Drive Shaft		30	22	52.5	105	617.5	
	2006.01-		MT	L	F	Estate Engine Z18XER	GCI99026	Inner Joint		22	25	35	57	82.5	
	2006.01-		MT	L	F	Estate Engine Z18XER	GC017007	Outer Joint		30	25	52.5	105	62	O
	2006.01-		MT	L	F	Saloon Engine Z18XER	GDS44020	Drive Shaft		30	22	52.5	105	617.5	
	2006.01-		MT	L	F	Saloon Engine Z18XER	GCI99026	Inner Joint		22	25	35	57	82.5	
	2006.01-		MT	L	F	Saloon Engine Z18XER	GC017007	Outer Joint		30	25	52.5	105	62	O
	2006.01-		MT/AT	R	F	Estate Engine Z18XER	GDS17040	Drive Shaft		30	22	52.5	105	987	
	2006.01-		MT/AT	R	F	Estate Engine Z18XER	GCI99026	Inner Joint		22	25	35	57	82.5	
	2006.01-		MT/AT	R	F	Estate Engine Z18XER	GC017007	Outer Joint		30	25	52.5	105	62	O
	2006.01-		MT/AT	R	F	Saloon Engine Z18XER	GDS17040	Drive Shaft		30	22	52.5	105	987	
	2006.01-		MT/AT	R	F	Saloon Engine Z18XER	GCI99026	Inner Joint		22	25	35	57	82.5	
	2006.01-		MT/AT	R	F	Saloon Engine Z18XER	GC017007	Outer Joint		30	25	52.5	105	62	O
	1.8 (81 kW)	2002.04-				F	Saloon Engine Z18XEL	GC017007	Outer Joint		30	25	52.5	105	62
2002.04-			MT	L	F	Saloon Engine Z18XEL	GDS44020	Drive Shaft		30	22	52.5	105	617.5	
2002.04-			MT	L	F	Saloon Engine Z18XEL	GCI99026	Inner Joint		22	25	35	57	82.5	
2002.04-			MT	L	F	Saloon Engine Z18XEL	GC017007	Outer Joint		30	25	52.5	105	62	O









		TRANSM	L/R	F/R		G-AP Ref.	PRODUCT	ABS	Technical Specifications					
									YEAR	A	B	C	H	L
<b>OPEL VECTRA C</b>	2002.04-		MT/AT	R	F	Saloon Engine Z18XEL	GDS17040	Drive Shaft	30	22	52.5	105	987	
	2002.04-		MT/AT	R	F	Saloon Engine Z18XEL	GCI99026	Inner Joint	22	25	35	57	82.5	
	2002.04-		MT/AT	R	F	Saloon Engine Z18XEL	GC017007	Outer Joint	30	25	52.5	105	62	O
1.8 (90 kW)	2003.10-				F	Estate Engine Z18XE	GC017007	Outer Joint	30	25	52.5	105	62	O
	2003.10-		MT	L	F	Estate Engine Z18XE	GDS44020	Drive Shaft	30	22	52.5	105	617.5	
	2003.10-		MT	L	F	Estate Engine Z18XE	GCI99026	Inner Joint	22	25	35	57	82.5	
	2003.10-		MT	L	F	Estate Engine Z18XE	GC017007	Outer Joint	30	25	52.5	105	62	O
	2003.10-		MT/AT	R	F	Estate Engine Z18XE	GDS17040	Drive Shaft	30	22	52.5	105	987	
	2003.10-		MT/AT	R	F	Estate Engine Z18XE	GCI99026	Inner Joint	22	25	35	57	82.5	
	2003.10-		MT/AT	R	F	Estate Engine Z18XE	GC017007	Outer Joint	30	25	52.5	105	62	O
1.8 16V (90 kW)	2002.04-				F	Saloon Engine Z18XE	GC017007	Outer Joint	30	25	52.5	105	62	O
	2002.04-		MT	L	F	Saloon Engine Z18XE	GDS44020	Drive Shaft	30	22	52.5	105	617.5	
	2002.04-		MT	L	F	Saloon Engine Z18XE	GCI99026	Inner Joint	22	25	35	57	82.5	
	2002.04-		MT	L	F	Saloon Engine Z18XE	GC017007	Outer Joint	30	25	52.5	105	62	O
	2002.04-		MT/AT	R	F	Saloon Engine Z18XE	GDS17040	Drive Shaft	30	22	52.5	105	987	
	2002.04-		MT/AT	R	F	Saloon Engine Z18XE	GCI99026	Inner Joint	22	25	35	57	82.5	
1.9 CDTi	2002-						GC017007	Outer Joint	30	25	52.5	105	62	O
1.9 CDTi (110 kW)	2004.04-		MT/AT		F	Estate Engine Z19DTH	GC017051	Outer Joint	30	26	53.8	94.5	65.5	M
	2004.04-		MT/AT		F	Saloon Engine Z19DTH	GC017051	Outer Joint	30	26	53.8	94.5	65.5	M
	2004.04-		MT	L	F	Estate Engine Z19DTH	GDS21032	Drive Shaft	30	27	53.8	94.5	605	
	2004.04-		MT	L	F	Saloon Engine Z19DTH	GDS21032	Drive Shaft	30	27	53.8	94.5	605	
	2004.04-		Semi-AT	L/R	F	Estate Engine Z19DTH	GDS44080	Drive Shaft	30	27	53.8	94.5	591	
	2004.04-		Semi-AT	L/R	F	Saloon Engine Z19DTH	GDS44080	Drive Shaft	30	27	53.8	94.5	591	
	2004.04-		MT	R	F	Estate Engine Z19DTH	GDS21032	Drive Shaft	30	27	53.8	94.5	605	
	2004.04-		MT	R	F	Saloon Engine Z19DTH	GDS21032	Drive Shaft	30	27	53.8	94.5	605	
	2004.04-		MT	L/R	F	Estate Engine Z19DTH	GCI99138	Inner Joint	27	28	35	78	83	
	2004.04-		MT	L/R	F	Saloon Engine Z19DTH	GCI99138	Inner Joint	27	28	35	78	83	
	2004.04-		MT	R	F	Estate Engine Z19DTH	GDS21053	Drive Shaft	30	34	53.8	94.5	617	
	2004.04-		MT	R	F	Saloon Engine Z19DTH	GDS21053	Drive Shaft	30	34	53.8	94.5	617	
	2004.04-					Estate Engine Z19DTH	GC099023	Outer Joint	30	26	53.8	94.5	65.5	M
1.9 CDTi (74 kW)	2005.10-		MT/AT		F	Estate Engine Z19DTL	GC017051	Outer Joint	30	26	53.8	94.5	65.5	M
	2005.10-		MT/AT		F	Saloon Engine Z19DT	GC017051	Outer Joint	30	26	53.8	94.5	65.5	M
	2005.10-		MT	L	F	Estate Engine Z19DTL	GDS21032	Drive Shaft	30	27	53.8	94.5	605	
	2005.10-		MT	L	F	Saloon Engine Z19DT	GDS21032	Drive Shaft	30	27	53.8	94.5	605	
	2005.10-		MT	R	F	Estate Engine Z19DTL	GDS21032	Drive Shaft	30	27	53.8	94.5	605	
	2005.10-		MT	R	F	Saloon Engine Z19DT	GDS21032	Drive Shaft	30	27	53.8	94.5	605	
	2005.10-		MT	L	F	Estate Engine Z19DTL	GDS21092	Drive Shaft	30	25	53.8	94.5	604	
	2005.10-		MT	L	F	Saloon Engine Z19DT	GDS21092	Drive Shaft	30	25	53.8	94.5	604	
	2005.10-		MT	L/R	F	Estate Engine Z19DTL	GCI99138	Inner Joint	27	28	35	78	83	
	2005.10-		MT	L/R	F	Saloon Engine Z19DT	GCI99138	Inner Joint	27	28	35	78	83	
	2005.10-		MT	R	F	Estate Engine Z19DTL	GDS21053	Drive Shaft	30	34	53.8	94.5	617	
1.9 CDTi (88 kW)	2004.04-		MT		F	Estate Engine Z19DT	GC017051	Outer Joint	30	26	53.8	94.5	65.5	M
	2004.04-		MT		F	Saloon Engine Z19DT	GC017051	Outer Joint	30	26	53.8	94.5	65.5	M
	2004.04-		MT	L	F	Estate Engine Z19DT	GDS21032	Drive Shaft	30	27	53.8	94.5	605	
	2004.04-		MT	L	F	Saloon Engine Z19DT	GDS21032	Drive Shaft	30	27	53.8	94.5	605	
	2004.04-		MT	R	F	Estate Engine Z19DT	GDS21032	Drive Shaft	30	27	53.8	94.5	605	
	2004.04-		MT	R	F	Saloon Engine Z19DT	GDS21032	Drive Shaft	30	27	53.8	94.5	605	
	2004.04-		MT	L	F	Estate Engine Z19DT	GDS21092	Drive Shaft	30	25	53.8	94.5	604	
	2004.04-		MT	L	F	Saloon Engine Z19DT	GDS21092	Drive Shaft	30	25	53.8	94.5	604	
	2004.04-		MT	L/R	F	Estate Engine Z19DT	GCI99138	Inner Joint	27	28	35	78	83	
	2004.04-		MT	L/R	F	Saloon Engine Z19DT	GCI99138	Inner Joint	27	28	35	78	83	
	2004.04-		MT	R	F	Estate Engine Z19DT	GDS21053	Drive Shaft	30	34	53.8	94.5	617	
	2004.04-		MT	R	F	Saloon Engine Z19DT	GDS21053	Drive Shaft	30	34	53.8	94.5	617	
2.0 16V Turbo (129 kW)	2003.05-2005.08		MT		F	Saloon Engine Z20NET	GC017051	Outer Joint	30	26	53.8	94.5	65.5	M
	2003.05-2005.08		MT	L/R	F	Saloon Engine Z20NET	GCI99138	Inner Joint	27	28	35	78	83	
	2003.05-2005.08		MT	L/R	F	Saloon Engine Z20NET	GDS21032	Drive Shaft	30	27	53.8	94.5	605	
	2003.05-2005.08					Saloon Engine Z20NET	GC099023	Outer Joint	30	26	53.8	94.5	65.5	M
2.0 DTi (74 kW)	2003.10-		MT		F	Estate Engine Y20DTH	GC017007	Outer Joint	30	25	52.5	105	62	O



	 YEAR	TRANSM	L/R	F/R		G-AP Ref.	PRODUCT	ABS	Technical Specifications									
									A	B	C	H	L	P				
<b>OPEL VECTRA C</b>																		
2.0 DTi (74 kW)	2003.10-		MT	R	F	Estate Engine Y20DTH	GDS21061	Drive Shaft	30	34	52.5	105	968					
	2003.10-		MT	R	F	Estate Engine Y20DTH	GDS60016	Drive Shaft	30	34	52.5	105	588					
2.0 DTi 16V (74 kW)	2002.04-				F	Saloon Engine Y20DTH	GC017007	Outer Joint	30	25	52.5	105	62	O				
	2002.04-		MT	R	F	Saloon Engine Y20DTH	GDS21061	Drive Shaft	30	34	52.5	105	968					
	2002.04-		MT	R	F	Saloon Engine Y20DTH	GDS60016	Drive Shaft	30	34	52.5	105	588					
2.0 Turbo (129 kW)	2003.10-		MT		F	Estate Engine Z20NET	GC017051	Outer Joint	30	26	53.8	94.5	65.5	M				
	2003.10-		MT	L/R	F	Estate Engine Z20NET	GDS21032	Drive Shaft	30	27	53.8	94.5	605					
	2003.10-		MT	L/R	F	Estate Engine Z20NET	GCI99138	Inner Joint	27	28	35	78	83					
	2003.10-					Estate Engine Z20NET	GC099023	Outer Joint	30	26	53.8	94.5	65.5	M				
2.2 16V (108 kW)	2002.04-		5MT		F	Saloon Engine Z22SE	GC017007	Outer Joint	30	25	52.5	105	62	O				
2.2 CDTi	2002-						GCI44007	Inner Joint	22	28	34.95	57	96.5					
2.2 Direct (114 kW)	2003.10-				F	Estate Engine Z22YH	GC021038	Outer Joint	30	24	52	94	64	M				
	2003.10-				F	Estate Engine Z22YH	GC017007	Outer Joint	30	25	52.5	105	62	O				
	2003.10-				F	Saloon Engine Z22YH	GC021038	Outer Joint	30	24	52	94	64	M				
	2003.10-				F	Saloon Engine Z22YH	GC017007	Outer Joint	30	25	52.5	105	62	O				
2.2 DTi (86 kW)	2003.10-	2008.06				Estate Engine Y 22 DTR	GC099023	Outer Joint	30	26	53.8	94.5	65.5	M				
2.2 DTi (92 kW)	2003.10-		MT		F	Estate Engine Y22DTR	GC017051	Outer Joint	30	26	53.8	94.5	65.5	M				
	2003.10-		MT	L/R	F	Estate Engine Y22DTR	GDS21032	Drive Shaft	30	27	53.8	94.5	605					
	2003.10-		MT	L/R	F	Estate Engine Y22DTR	GCI99138	Inner Joint	27	28	35	78	83					
	2003.10-					Estate Engine Y22DTR	GC099023	Outer Joint	30	26	53.8	94.5	65.5	M				
2.2 DTi 16V (86 kW)	2002.04-	2004.12				Saloon Engine Y22DTR	GC099023	Outer Joint	30	26	53.8	94.5	65.5	M				
2.2 DTi 16V (92 kW)	2002.04-		MT		F	Saloon Engine Y22DTR	GC017051	Outer Joint	30	26	53.8	94.5	65.5	M				
	2002.04-		MT	L/R	F	Saloon Engine Y22DTR	GDS21032	Drive Shaft	30	27	53.8	94.5	605					
	2002.04-		MT	L/R	F	Saloon Engine Y22DTR	GCI99138	Inner Joint	27	28	35	78	83					
	2002.04-					Saloon Engine Y22DTR	GC099023	Outer Joint	30	26	53.8	94.5	65.5	M				
2.8 V6 Turbo (169 kW)	2005.08-				F	Estate Engine Z28NEL	GC021030	Outer Joint	30	28	55.4	96	65	M				
2.8 V6 Turbo (188 kW)	2005.08-				F	Estate Engine Z28NET	GC021030	Outer Joint	30	28	55.4	96	65	M				
3.0 CDTi (130 kW)	2003.06-		MT		F	Saloon Engine Y30DT	GC017051	Outer Joint	30	26	53.8	94.5	65.5	M				
	2003.06-			L/R	F	Saloon Engine Y30DT	GDS21032	Drive Shaft	30	27	53.8	94.5	605					
	2003.06-			L/R	F	Saloon Engine Y30DT	GCI99138	Inner Joint	27	28	35	78	83					
	2003.06-					Saloon Engine Y30DT	GC099023	Outer Joint	30	26	53.8	94.5	65.5	M				
3.0 CDTi (135 kW)	2005.08-					Saloon Engine Z30DT	GC099023	Outer Joint	30	26	53.8	94.5	65.5	M				
3.0 V6 CDTi (130 kW)	2003.10-		MT		F	Estate Engine Y30DT	GC017051	Outer Joint	30	26	53.8	94.5	65.5	M				
	2003.10-			L/R	F	Estate Engine Y30DT	GDS21032	Drive Shaft	30	27	53.8	94.5	605					
	2003.10-			L/R	F	Estate Engine Y30DT	GCI99138	Inner Joint	27	28	35	78	83					
	2003.10-					Estate Engine Y30DT	GC099023	Outer Joint	30	26	53.8	94.5	65.5	M				
3.0 V6 CDTi (135 kW)	2005.08-					Estate Engine Z30DT	GC099023	Outer Joint	30	26	53.8	94.5	65.5	M				
3.2 V6 (155 kW)	2002.08-		MT		F	Saloon Engine Z32SE	GC017051	Outer Joint	30	26	53.8	94.5	65.5	M				
	2002.08-		MT	L/R	F	Saloon Engine Z32SE	GDS21032	Drive Shaft	30	27	53.8	94.5	605					
	2002.08-		MT	L/R	F	Saloon Engine Z32SE	GCI99138	Inner Joint	27	28	35	78	83					
	2002.08-					Saloon Engine Z32SE	GC099023	Outer Joint	30	26	53.8	94.5	65.5	M				
	2003.10-		MT		F	Estate Engine Z32SE	GC017051	Outer Joint	30	26	53.8	94.5	65.5	M				
	2003.10-		MT	L/R	F	Estate Engine Z32SE	GDS21032	Drive Shaft	30	27	53.8	94.5	605					
	2003.10-		MT	L/R	F	Estate Engine Z32SE	GCI99138	Inner Joint	27	28	35	78	83					
	2003.10-					Estate Engine Z32SE	GC099023	Outer Joint	30	26	53.8	94.5	65.5	M				
<b>VECTRA C GTS</b>																		
1.6 (74 kW)	2005.08-				F	Hatchback Engine Z16XE	GC021038	Outer Joint	30	24	52	94	64	M				
	2005.08-				F	Hatchback Engine Z16XE	GC017007	Outer Joint	30	25	52.5	105	62	O				
	2005.08-		MT	L	F	Hatchback Engine Z16XE	GDS44020	Drive Shaft	30	22	52.5	105	617.5					
	2005.08-		MT	L	F	Hatchback Engine Z16XE	GCI99026	Inner Joint	22	25	35	57	82.5					
	2005.08-		MT	L	F	Hatchback Engine Z16XE	GC017007	Outer Joint	30	25	52.5	105	62	O				
	2005.08-		MT	R	F	Hatchback Engine Z16XE	GDS17040	Drive Shaft	30	22	52.5	105	987					
1.6 (77 kW)	2006.01-				F	Hatchback Engine Z16XEP	GC021038	Outer Joint	30	24	52	94	64	M				
	2006.01-				F	Hatchback Engine Z16XEP	GC017007	Outer Joint	30	25	52.5	105	62	O				
	2006.01-		MT	L	F	Hatchback Engine Z16XEP	GDS44020	Drive Shaft	30	22	52.5	105	617.5					
	2006.01-		MT	L	F	Hatchback Engine Z16XEP	GCI99026	Inner Joint	22	25	35	57	82.5					
	2006.01-		MT	L	F	Hatchback Engine Z16XEP	GC017007	Outer Joint	30	25	52.5	105	62	O				
	2006.01-		MT	R	F	Hatchback Engine Z16XEP	GDS17040	Drive Shaft	30	22	52.5	105	987					
1.8 (103 kW)	2006.01-				F	Hatchback Engine Z18XER	GC017007	Outer Joint	30	25	52.5	105	62	O				
	2006.01-		MT	L	F	Hatchback Engine Z18XER	GDS44020	Drive Shaft	30	22	52.5	105	617.5					
	2006.01-		MT	L	F	Hatchback Engine Z18XER	GCI99026	Inner Joint	22	25	35	57	82.5					

		TRANSM	L/R	F/R		G-AP Ref.	PRODUCT	ABS	Technical Specifications									
									YEAR	A	B	C	H	L	P			
<b>OPEL</b>																		
<b>VECTRA C GTS</b>																		
1.8 (103 kW)	2006.01-		MT	L	F	Hatchback Engine Z18XER	GC017007	Outer Joint	30	25	52.5	105	62	O				
	2006.01-		MT/AT	R	F	Hatchback Engine Z18XER	GDS17040	Drive Shaft	30	22	52.5	105	987					
	2006.01-		MT/AT	R	F	Hatchback Engine Z18XER	GCI99026	Inner Joint	22	25	35	57	82.5					
	2006.01-		MT/AT	R	F	Hatchback Engine Z18XER	GC017007	Outer Joint	30	25	52.5	105	62	O				
1.8 16V (81 kW)	2002.08-2006.12			L	F	Hatchback Engine Z18XEL	GDS44020	Drive Shaft	30	22	52.5	105	617.5					
	2002.08-2006.12			L	F	Hatchback Engine Z18XEL	GCI99026	Inner Joint	22	25	35	57	82.5					
	2002.08-2006.12			L	F	Hatchback Engine Z18XEL	GC017007	Outer Joint	30	25	52.5	105	62	O				
	2002.08-2006.12		MT/AT	R	F	Hatchback Engine Z18XEL	GDS17040	Drive Shaft	30	22	52.5	105	987					
	2002.08-2006.12		MT/AT	R	F	Hatchback Engine Z18XEL	GCI99026	Inner Joint	22	25	35	57	82.5					
	2002.08-2006.12		MT/AT	R	F	Hatchback Engine Z18XEL	GC017007	Outer Joint	30	25	52.5	105	62	O				
1.8 16V (90 kW)	2002.08-				F	Hatchback Engine Z18XE	GC017007	Outer Joint	30	25	52.5	105	62	O				
	2002.08-		MT	L	F	Hatchback Engine Z18XE	GDS44020	Drive Shaft	30	22	52.5	105	617.5					
	2002.08-		MT	L	F	Hatchback Engine Z18XE	GCI99026	Inner Joint	22	25	35	57	82.5					
	2002.08-		MT	L	F	Hatchback Engine Z18XE	GC017007	Outer Joint	30	25	52.5	105	62	O				
	2002.08-		MT/AT	R	F	Hatchback Engine Z18XE	GDS17040	Drive Shaft	30	22	52.5	105	987					
	2002.08-		MT/AT	R	F	Hatchback Engine Z18XE	GCI99026	Inner Joint	22	25	35	57	82.5					
	2002.08-		MT/AT	R	F	Hatchback Engine Z18XE	GC017007	Outer Joint	30	25	52.5	105	62	O				
1.9 CDTi (110 kW)	2004.04-		MT/AT		F	Hatchback Engine Z19DTH	GC017051	Outer Joint	30	26	53.8	94.5	65.5	M				
	2004.04-		MT	L	F	Hatchback Engine Z19DTH	GDS21032	Drive Shaft	30	27	53.8	94.5	605					
	2004.04-		Semi-AT	L/R	F	Hatchback Engine Z19DTH	GDS44080	Drive Shaft	30	27	53.8	94.5	591					
	2004.04-		MT	R	F	Hatchback Engine Z19DTH	GDS21032	Drive Shaft	30	27	53.8	94.5	605					
	2004.04-		MT	L/R	F	Hatchback Engine Z19DTH	GCI99138	Inner Joint	27	28	35	78	83					
	2004.04-		MT	R	F	Hatchback Engine Z19DTH	GDS21053	Drive Shaft	30	34	53.8	94.5	617					
	2004.04-					Hatchback Engine Z19DTH	GC099023	Outer Joint	30	26	53.8	94.5	65.5	M				
1.9 CDTi (74 kW)	2005.10-		MT/AT		F	Hatchback Engine Z19DTL	GC017051	Outer Joint	30	26	53.8	94.5	65.5	M				
	2005.10-		MT	L	F	Hatchback Engine Z19DTL	GDS21032	Drive Shaft	30	27	53.8	94.5	605					
	2005.10-		MT	R	F	Hatchback Engine Z19DTL	GDS21032	Drive Shaft	30	27	53.8	94.5	605					
	2005.10-		MT	L	F	Hatchback Engine Z19DTL	GDS21092	Drive Shaft	30	25	53.8	94.5	604					
	2005.10-		MT	L/R	F	Hatchback Engine Z19DTL	GCI99138	Inner Joint	27	28	35	78	83					
	2005.10-		MT	R	F	Hatchback Engine Z19DTL	GDS21053	Drive Shaft	30	34	53.8	94.5	617					
	2005.10-					Hatchback Engine Z19DTL	GC099023	Outer Joint	30	26	53.8	94.5	65.5	M				
1.9 CDTi (88 kW)	2004.04-		MT		F	Hatchback Engine Z19DT	GC017051	Outer Joint	30	26	53.8	94.5	65.5	M				
	2004.04-		MT	L	F	Hatchback Engine Z19DT	GDS21032	Drive Shaft	30	27	53.8	94.5	605					
	2004.04-		MT	R	F	Hatchback Engine Z19DT	GDS21032	Drive Shaft	30	27	53.8	94.5	605					
	2004.04-		MT	L	F	Hatchback Engine Z19DT	GDS21092	Drive Shaft	30	25	53.8	94.5	604					
	2004.04-		MT	L/R	F	Hatchback Engine Z19DT	GCI99138	Inner Joint	27	28	35	78	83					
	2004.04-		MT	R	F	Hatchback Engine Z19DT	GDS21053	Drive Shaft	30	34	53.8	94.5	617					
2.0 16V Turbo (129 kW)	2003.03-		MT		F	Hatchback Engine Z20NET	GC017051	Outer Joint	30	26	53.8	94.5	65.5	M				
	2003.03-		MT	L/R	F	Hatchback Engine Z20NET	GDS21032	Drive Shaft	30	27	53.8	94.5	605					
	2003.03-		MT	L/R	F	Hatchback Engine Z20NET	GCI99138	Inner Joint	27	28	35	78	83					
	2003.03-					Hatchback Engine Z20NET	GC099023	Outer Joint	30	26	53.8	94.5	65.5	M				
2.0 DTi 16V (74 kW)	2002.08-		MT		F	Hatchback Engine Y20DTH	GC017007	Outer Joint	30	25	52.5	105	62	O				
	2002.08-		MT	R	F	Hatchback Engine Y20DTH	GDS21061	Drive Shaft	30	34	52.5	105	968					
	2002.08-		MT	R	F	Hatchback Engine Y20DTH	GDS60016	Drive Shaft	30	34	52.5	105	588					
2.2 16V (108 kW)	2002.08-		5MT		F	Hatchback Engine Z22SE	GC017007	Outer Joint	30	25	52.5	105	62	O				
2.2 Direct (114 kW)	2003.10-				F	Hatchback Engine Z22YH	GC021038	Outer Joint	30	24	52	94	64	M				
	2003.10-				F	Hatchback Engine Z22YH	GC017007	Outer Joint	30	25	52.5	105	62	O				
2.2 DTi 16V (86 kW)	2002.08-2008.06				F	Hatchback Engine Y22DTR	GC099023	Outer Joint	30	26	53.8	94.5	65.5	M				
2.2 DTi 16V (92 kW)	2002.08-		MT		F	Hatchback Engine Y22DTR	GC017051	Outer Joint	30	26	53.8	94.5	65.5	M				
	2002.08-		MT	L/R	F	Hatchback Engine Y22DTR	GDS21032	Drive Shaft	30	27	53.8	94.5	605					
	2002.08-		MT	L/R	F	Hatchback Engine Y22DTR	GCI99138	Inner Joint	27	28	35	78	83					
	2002.08-					Hatchback Engine Y22DTR	GC099023	Outer Joint	30	26	53.8	94.5	65.5	M				
	2002.08-					Hatchback Engine Y22DTR	GC021030	Outer Joint	30	28	55.4	96	65	M				
2.8 V6 Turbo (169 kW)	2005.08-				F	Hatchback Engine Z28NEL	GC021030	Outer Joint	30	28	55.4	96	65	M				
2.8 V6 Turbo (188 kW)	2005.08-				F	Hatchback Engine Z28NET	GC021030	Outer Joint	30	28	55.4	96	65	M				
3.0 CDTi (130 kW)	2003.06-		MT		F	Hatchback Engine Y30DT	GC017051	Outer Joint	30	26	53.8	94.5	65.5	M				
	2003.06-			L/R	F	Hatchback Engine Y30DT	GDS21032	Drive Shaft	30	27	53.8	94.5	605					
	2003.06-			L/R	F	Hatchback Engine Y30DT	GCI99138	Inner Joint	27	28	35	78	83					
	2003.06-					Hatchback Engine Y30DT	GC099023	Outer Joint	30	26	53.8	94.5	65.5	M				
	2003.06-					Hatchback Engine Y30DT	GC099023	Outer Joint	30	26	53.8	94.5	65.5	M				
3.0 CDTi (135 kW)	2005.08-				F	Hatchback Engine Z30DT	GC099023	Outer Joint	30	26	53.8	94.5	65.5	M				
3.2 V6 (155 kW)	2002.08-		MT		F	Hatchback Engine Z32SE	GC017051	Outer Joint	30	26	53.8	94.5	65.5	M				
	2002.08-		MT	L/R	F	Hatchback Engine Z32SE	GDS21032	Drive Shaft	30	27	53.8	94.5	605					
	2002.08-		MT	L/R	F	Hatchback Engine Z32SE	GCI99138	Inner Joint	27	28	35	78	83					









		TRANSM	L/R	F/R		G-AP Ref.	PRODUCT	ABS	Technical Specifications								
									YEAR	A	B	C	H	L	P		
<b>OPEL</b>																	
<b>VECTRA C GTS</b>																	
3.2 V6 (155 kW)	2002.08-				Hatchback Engine Z32SE	GC099023	Outer Joint		30	26	53.8	94.5	65.5	M			
<b>VECTRA C, SW</b>																	
1.6 16V (74 kW)	2004.05-				Ch-71009336	GC017007	Outer Joint		30	25	52.5	105	62	O			
1.6 16V (77 kW)	2004.05-				Ch-71009336	GC017007	Outer Joint		30	25	52.5	105	62	O			
1.8 (81 kW)	2002.04-				Ch-71009336	GC017007	Outer Joint		30	25	52.5	105	62	O			
1.8 16V (103 kW)	2002.04-					GC017007	Outer Joint		30	25	52.5	105	62	O			
1.8 16V (90 kW)	2002.04-					GC017007	Outer Joint		30	25	52.5	105	62	O			
1.9 CDTi (110 kW)	2004.04-	MT				GCI99138	Inner Joint		27	28	35	78	83				
	2004.04-					GC017051	Outer Joint		30	26	53.8	94.5	65.5	M			
1.9 CDTi (74 kW)	2004.04-	MT				GCI99138	Inner Joint		27	28	35	78	83				
	2004.04-					GC017051	Outer Joint		30	26	53.8	94.5	65.5	M			
1.9 CDTi (88 kW)	2004.04-	MT				GCI99138	Inner Joint		27	28	35	78	83				
	2004.04-					GC017051	Outer Joint		30	26	53.8	94.5	65.5	M			
2.0 DTi 16V (74 kW)	2002.04-	MT				GC017007	Outer Joint		30	25	52.5	105	62	O			
2.0 T 16V (129 kW)	2003.03-					GCI99138	Inner Joint		27	28	35	78	83				
	2003.03-					GC017051	Outer Joint		30	26	53.8	94.5	65.5	M			
2.2 16V (108 kW)	2002.04-					GC017007	Outer Joint		30	25	52.5	105	62	O			
2.2 Direct 16V (114 kW)	2003.10-				Ch-71009336	GC017007	Outer Joint		30	25	52.5	105	62	O			
2.2 DTi 16V (92 kW)	2002.04-					GCI99138	Inner Joint		27	28	35	78	83				
	2002.04-					GC017051	Outer Joint		30	26	53.8	94.5	65.5	M			
3.0 CDTi (130 kW)	2005.08-					GCI99138	Inner Joint		27	28	35	78	83				
	2005.08-					GC017051	Outer Joint		30	26	53.8	94.5	65.5	M			
3.2 V6 (155 kW)	2002.08-	MT				GCI99138	Inner Joint		27	28	35	78	83				
	2002.08-					GC017051	Outer Joint		30	26	53.8	94.5	65.5	M			
<b>VIVARO</b>																	
2.5 DTi (99 kW)	2003.05-					GC045015	Outer Joint		21	20	56.4	76	56	O			
<b>VIVARO (E7)</b>																	
1.9 DTi (74 kW)	2006.08-			F	Platform/Chassis Engine F9Q760	GC018105	Outer Joint		27	26	56.5	93.5	64	M			
	2006.08-		L	F	Platform/Chassis Engine F9Q760	GDS44003	Drive Shaft		27	37.1	56.5	93.5	676				
	2006.08-		R	F	Platform/Chassis Engine F9Q760	GDS44013	Drive Shaft		27	39	56.5	93.5	1020				
2.0 16V (88 kW)	2006.08-			F	Platform/Chassis Engine F4R720	GC018105	Outer Joint		27	26	56.5	93.5	64	M			
2.0 CDTi (66 kW)	2006.01-		L	F	Platform/Chassis Engine M9R782	GDS60022	Drive Shaft		27	39	56.6	94	694				
	2006.01-		R	F	Platform/Chassis Engine M9R782	GDS18271	Drive Shaft		27	39	56.6	94	1013				
2.0 CDTi (84 kW)	2006.08-		L	F	Platform/Chassis Engine M9R780	GDS60022	Drive Shaft		27	39	56.6	94	694				
	2006.08-		R	F	Platform/Chassis Engine M9R780	GDS18271	Drive Shaft		27	39	56.6	94	1013				
2.0 EcoTec (86 kW)	2006.08-			F	Platform/Chassis Engine F4R820	GC018105	Outer Joint		27	26	56.5	93.5	64	M			
	2006.08-		L	F	Platform/Chassis Engine F4R820	GDS44003	Drive Shaft		27	37.1	56.5	93.5	676				
	2006.08-		R	F	Platform/Chassis Engine F4R820	GDS44013	Drive Shaft		27	39	56.5	93.5	1020				
2.5 CDTi (107 kW)	2006.08-		R	F	Platform/Chassis Engine G9U630	GDS18301	Drive Shaft		27	39	56.6	94	1045				
	2006.08-		L	F	Platform/Chassis Engine G9U630	GDS50557	Drive Shaft		27	37.1	56.5	92	634				
	2006.08-		R	F	Platform/Chassis Engine G9U630	GDS50562	Drive Shaft		27	39	56.5	92	1056				
	2006.08-		R	F	Platform/Chassis Engine G9U630	GCI50097	Inner Joint		39	35	30	409	90				
	2006.08-		R	F	Platform/Chassis Engine G9U630	GC050080	Outer Joint		27	37	56.5	92	73	I			
2.5 CDTi (84 kW)	2006.08-		R	F	Platform/Chassis Engine G9U630	GDS18301	Drive Shaft		27	39	56.6	94	1045				
	2006.08-		L	F	Platform/Chassis Engine G9U630	GDS50557	Drive Shaft		27	37.1	56.5	92	634				
	2006.08-		R	F	Platform/Chassis Engine G9U630	GDS50562	Drive Shaft		27	39	56.5	92	1056				
	2006.08-		R	F	Platform/Chassis Engine G9U630	GCI50097	Inner Joint		39	35	30	409	90				
	2006.08-		R	F	Platform/Chassis Engine G9U630	GC050080	Outer Joint		27	37	56.5	92	73	I			
2.5 DTi (99 kW)	2006.08-		L	F	Platform/Chassis Engine G9U730	GDS50497	Drive Shaft		27	39	56.6	94	667				
	2006.08-		R	F	Platform/Chassis Engine G9U730	GDS18301	Drive Shaft		27	39	56.6	94	1045				
	2006.08-		L	F	Platform/Chassis Engine G9U730	GDS50557	Drive Shaft		27	37.1	56.5	92	634				
	2006.08-		R	F	Platform/Chassis Engine G9U730	GDS50562	Drive Shaft		27	39	56.5	92	1056				
	2006.08-		R	F	Platform/Chassis Engine G9U730	GCI50097	Inner Joint		39	35	30	409	90				
	2006.08-		R	F	Platform/Chassis Engine G9U730	GC050080	Outer Joint		27	37	56.5	92	73	I			
<b>VIVARO (F7)</b>																	
1.9 Di (60 kW)	2001.08-			F	Box Engine F9Q762	GC018105	Outer Joint		27	26	56.5	93.5	64	M			
	2001.08-		L	F	Box Engine F9Q762	GDS44003	Drive Shaft		27	37.1	56.5	93.5	676				
	2001.08-		R	F	Box Engine F9Q762	GDS44013	Drive Shaft		27	39	56.5	93.5	1020				
1.9 DTi (74 kW)	2001.08-			F	Box Engine F9Q760	GC018105	Outer Joint		27	26	56.5	93.5	64	M			
	2001.08-		L	F	Box Engine F9Q760	GDS44003	Drive Shaft		27	37.1	56.5	93.5	676				
	2001.08-		R	F	Box Engine F9Q760	GDS44013	Drive Shaft		27	39	56.5	93.5	1020				



		TRANSM	L/R	F/R		G-AP Ref.	PRODUCT	ABS	Technical Specifications							
									YEAR	A	B	C	H	L	P	
<b>OPEL VIVARO (F7)</b>																
2.0 16V (88 kW)	2001.08-			F	Box Engine F4R720	GC018105	Outer Joint		27	26	56.5	93.5	64	M		
	2001.08-		L	F	Box Engine F4R720	GDS44003	Drive Shaft		27	37.1	56.5	93.5	676			
	2001.08-		R	F	Box Engine F4R720	GDS44013	Drive Shaft		27	39	56.5	93.5	1020			
2.0 CDTi (66 kW)	2006.08-		L	F	Box Engine M9R630/M9R780/M9R782/M9R786	GDS60022	Drive Shaft		27	39	56.6	94	694			
	2006.08-		R	F	Box Engine M9R630/M9R780/M9R782/M9R786	GDS18271	Drive Shaft		27	39	56.6	94	1013			
2.0 CDTi (84 kW)	2006.08-		L	F	Box Engine M9R692/M9R780/M9R784/M9R786/M9R788	GDS60022	Drive Shaft		27	39	56.6	94	694			
	2006.08-		R	F	Box Engine M9R692/M9R780/M9R784/M9R786/M9R788	GDS18271	Drive Shaft		27	39	56.6	94	1013			
2.0 EcoTec (86 kW)	2006.08-			F	Box Engine F4R820	GC018105	Outer Joint		27	26	56.5	93.5	64	M		
	2006.08-		L	F	Box Engine F4R820	GDS44003	Drive Shaft		27	37.1	56.5	93.5	676			
	2006.08-		R	F	Box Engine F4R820	GDS44013	Drive Shaft		27	39	56.5	93.5	1020			
2.5 CDTi (107 kW)	2006.08-		R	F	Box Engine G9MB6/G9U630	GDS18301	Drive Shaft		27	39	56.6	94	1045			
	2006.08-		L	F	Box Engine G9MB6/G9U630	GDS50557	Drive Shaft		27	37.1	56.5	92	634			
	2006.08-		R	F	Box Engine G9MB6/G9U630	GDS50562	Drive Shaft		27	39	56.5	92	1056			
	2006.08-		R	F	Box Engine G9MB6/G9U630	GCI50097	Inner Joint		39	35	30	409	90			
	2006.08-		R	F	Box Engine G9MB6/G9U630	GC050080	Outer Joint		27	37	56.5	92	73	I		
2.5 CDTi (84 kW)	2006.08-		R	F	Box Engine G9U630	GDS18301	Drive Shaft		27	39	56.6	94	1045			
	2006.08-		L	F	Box Engine G9U630	GDS50557	Drive Shaft		27	37.1	56.5	92	634			
	2006.08-		R	F	Box Engine G9U630	GDS50562	Drive Shaft		27	39	56.5	92	1056			
	2006.08-		R	F	Box Engine G9U630	GCI50097	Inner Joint		39	35	30	409	90			
	2006.08-		R	F	Box Engine G9U630	GC050080	Outer Joint		27	37	56.5	92	73	I		
2.5 DTi (99 kW)	2003.05-			F	Box Engine G9U730	GC018105	Outer Joint		27	26	56.5	93.5	64	M		
	2003.05-		L	F	Box Engine G9U730	GDS50497	Drive Shaft		27	39	56.6	94	667			
	2003.05-		R	F	Box Engine G9U730	GDS18301	Drive Shaft		27	39	56.6	94	1045			
	2003.05-		L	F	Box Engine G9U730	GDS50557	Drive Shaft		27	37.1	56.5	92	634			
	2003.05-		R	F	Box Engine G9U730	GDS50562	Drive Shaft		27	39	56.5	92	1056			
	2003.05-		R	F	Box Engine G9U730	GCI50097	Inner Joint		39	35	30	409	90			
2.5 DTi (99 kW)	2003.05-		R	F	Box Engine G9U730	GC050080	Outer Joint		27	37	56.5	92	73	I		
	2003.05-			F	Box Engine G9U730	GC018105	Outer Joint		27	26	56.5	93.5	64	M		
	2003.05-		L	F	Box Engine G9U730	GDS50497	Drive Shaft		27	39	56.6	94	667			
	2003.05-		R	F	Box Engine G9U730	GDS18301	Drive Shaft		27	39	56.6	94	1045			
	2003.05-		L	F	Box Engine G9U730	GDS50557	Drive Shaft		27	37.1	56.5	92	634			
	2003.05-		R	F	Box Engine G9U730	GDS50562	Drive Shaft		27	39	56.5	92	1056			
<b>VIVARO (J7)</b>	2006.08-			F	Bus Engine F9Q762/F9Q774	GC018105	Outer Joint		27	26	56.5	93.5	64	M		
	2001.08-		L	F	Bus Engine F9Q762/F9Q774	GDS44003	Drive Shaft		27	37.1	56.5	93.5	676			
	2001.08-		R	F	Bus Engine F9Q762/F9Q774	GDS44013	Drive Shaft		27	39	56.5	93.5	1020			
	2001.08-			F	Bus Engine F9Q760	GC018105	Outer Joint		27	26	56.5	93.5	64	M		
	2001.08-		L	F	Bus Engine F9Q760	GDS44003	Drive Shaft		27	37.1	56.5	93.5	676			
	2001.08-		R	F	Bus Engine F9Q760	GDS44013	Drive Shaft		27	39	56.5	93.5	1020			
2.0 16V (88 kW)	2001.08-			F	Bus Engine F4R720	GC018105	Outer Joint		27	26	56.5	93.5	64	M		
	2001.08-		L	F	Bus Engine F4R720	GDS44003	Drive Shaft		27	37.1	56.5	93.5	676			
	2001.08-		R	F	Bus Engine F4R720	GDS44013	Drive Shaft		27	39	56.5	93.5	1020			
2.0 CDTi (66 kW)	2006.08-		L	F	Bus Engine M9R780/M9R782/M9R786	GDS60022	Drive Shaft		27	39	56.6	94	694			
	2006.08-		R	F	Bus Engine M9R780/M9R782/M9R786	GDS18271	Drive Shaft		27	39	56.6	94	1013			
2.0 CDTi (84 kW)	2006.08-		L	F	Bus Engine M9R780/M9R784/M9R786/M9R788/M9R830/M9R892	GDS60022	Drive Shaft		27	39	56.6	94	694			
	2006.08-		R	F	Bus Engine M9R780/M9R784/M9R786/M9R788/M9R830/M9R892	GDS18271	Drive Shaft		27	39	56.6	94	1013			
2.0 EcoTec (86 kW)	2006.08-			F	Bus Engine F4R820	GC018105	Outer Joint		27	26	56.5	93.5	64	M		
	2006.08-		L	F	Bus Engine F4R820	GDS44003	Drive Shaft		27	37.1	56.5	93.5	676			
	2006.08-		R	F	Bus Engine F4R820	GDS44013	Drive Shaft		27	39	56.5	93.5	1020			
2.5 CDTi (107 kW)	2006.08-		R	F	Bus Engine G9U630	GDS18301	Drive Shaft		27	39	56.6	94	1045			
	2006.08-		L	F	Bus Engine G9U630	GDS50557	Drive Shaft		27	37.1	56.5	92	634			
	2006.08-		R	F	Bus Engine G9U630	GDS50562	Drive Shaft		27	39	56.5	92	1056			
	2006.08-		R	F	Bus Engine G9U630	GCI50097	Inner Joint		39	35	30	409	90			
	2006.08-		R	F	Bus Engine G9U630	GC050080	Outer Joint		27	37	56.5	92	73	I		
2.5 CDTi (84 kW)	2006.08-		R	F	Bus Engine G9U630	GDS18301	Drive Shaft		27	39	56.6	94	1045			
	2006.08-		L	F	Bus Engine G9U630	GDS50557	Drive Shaft		27	37.1	56.5	92	634			
	2006.08-		R	F	Bus Engine G9U630	GDS50562	Drive Shaft		27	39	56.5	92	1056			
	2006.08-		R	F	Bus Engine G9U630	GCI50097	Inner Joint		39	35	30	409	90			
	2006.08-		R	F	Bus Engine G9U630	GC050080	Outer Joint		27	37	56.5	92	73	I		
2.5 DTi (99 kW)	2003.05-			F	Bus Engine G9U730	GC018105	Outer Joint		27	26	56.5	93.5	64	M		
	2003.05-		L	F	Bus Engine G9U730	GDS50497	Drive Shaft		27	39	56.6	94	667			
	2003.05-		R	F	Bus Engine G9U730	GDS18301	Drive Shaft		27	39	56.6	94	1045			
	2003.05-		L	F	Bus Engine G9U730	GDS50557	Drive Shaft		27	37.1	56.5	92	634			
	2003.05-		R	F	Bus Engine G9U730	GDS50562	Drive Shaft		27	39	56.5	92	1056			
	2003.05-		R	F	Bus Engine G9U730	GCI50097	Inner Joint		39	35	30	409	90			
2.5 DTi (99 kW)	2003.05-		R	F	Bus Engine G9U730	GC050080	Outer Joint		27	37	56.5	92	73	I		
	2003.05-			F	Bus Engine G9U730	GC018105	Outer Joint		27	26	56.5	93.5	64	M		
	2003.05-		L	F	Bus Engine G9U730	GDS50497	Drive Shaft		27	39	56.6	94	667			
	2003.05-		R	F	Bus Engine G9U730	GDS18301	Drive Shaft		27	39	56.6	94	1045			
	2003.05-		L	F	Bus Engine G9U730	GDS50557	Drive Shaft		27	37.1	56.5	92	634			
	2003.05-		R	F	Bus Engine G9U730	GDS50562	Drive Shaft		27	39	56.5	92	1056			

		TRANSM	L/R	F/R		G-AP Ref.	PRODUCT	ABS	Technical Specifications								
									YEAR	A	B	C	H	L	P		
<b>OPEL ZAFIRA</b>																	
-						GCO99064	Outer Joint		33	24	52	104	64	M			
			L			GDS88010	Drive Shaft		33	34	52	104	593				
			R			GDS88011	Drive Shaft		33	34	52	104	959				
<b>ZAFIRA A</b>																	
2.2 DTI 16v (86 kW)	2002.01-	2005.06				GCI99188	Inner Joint		27	35	35	101	88.5				
2.2 DTI 16v (92 kW)	2002.01-	2005.06				GCI99188	Inner Joint		27	35	35	101	88.5				
<b>ZAFIRA A (F75)</b>																	
1.6 16V (55 kW)	1999.04-	2005.06			Engine X16XEL	GCO44006	Outer Joint	29T	33	25	52	103.5	61	O			
	1999.04-	2005.06				GCI21014	Inner Joint		22	22	35	57.5	75				
1.6 16V (74 kW)	1999.04-	2005.06			Engine X16XEL	GCO44006	Outer Joint	29T	33	25	52	103.5	61	O			
	1999.04-	2005.06				GCI21014	Inner Joint		22	22	35	57.5	75				
1.6 CNG (71 kW)	2001.09-	2005.06				GCO44006	Outer Joint	29T	33	25	52	103.5	61	O			
1.8 16V (85 kW)	1999.04-	2005.06				GCI99026	Inner Joint		22	25	35	57	82.5				
	1999.04-	2005.06				GCO44006	Outer Joint	29T	33	25	52	103.5	61	O			
1.8 16V (92 kW)	1999.04-	2005.06				GCI99026	Inner Joint		22	25	35	57	82.5				
	1999.04-	2005.06				GCO44006	Outer Joint	29T	33	25	52	103.5	61	O			
2.0 Di 16V (60 kW)	1999.10-	2005.06				GCO44006	Outer Joint	29T	33	25	52	103.5	61	O			
2.0 Di 16V (60 kW)	1999.10-	2005.06				GCI21011	Inner Joint		34	25	35	78	64				
2.0 DTi 16V (74 kW)	2000.09-	2005.06				GCI21011	Inner Joint		34	25	35	78	64				
	2000.09-	2005.06				GCO44006	Outer Joint	29T	33	25	52	103.5	61	O			
2.2 16V (108 kW)	2000.09-	2005.06				GCI21011	Inner Joint		34	25	35	78	64				
	2000.09-	2005.06				GCO44006	Outer Joint	29T	33	25	52	103.5	61	O			
<b>ZAFIRA A (F75 )</b>																	
1.6 16V (74 kW)	1999.04-	2005.06	5MT		F	MPV Engine X16XEL/Z16XE	GCO44049	Outer Joint		33	25	52	109	61	O		
	1999.04-	2005.06	MT/AT		F	MPV Engine X16XEL/Z16XE	GCO44006	Outer Joint	29T	33	25	52	103.5	61	O		
	1999.04-	2005.06			R	F	MPV Engine X16XEL/Z16XE	GDS60035	Drive Shaft	33	22	52	109	961			
1.6 CNG (71 kW)	2001.09-	2005.06	5MT		F	MPV Engine Z16YNG	GCO44049	Outer Joint		33	25	52	109	61	O		
	2001.09-	2005.06	MT	R	F	MPV Engine Z16YNG	GDS60035	Drive Shaft	33	22	52	109	961				
1.8 16V (92 kW)	2000.09-	2005.06			F	MPV Engine Z18XE	GCO44049	Outer Joint		33	25	52	109	61	O		
	2000.09-	2005.06	MT/AT		F	MPV Engine Z18XE	GCO44006	Outer Joint	29T	33	25	52	103.5	61	O		
2.0 Di 16V (60 kW)	1999.10-	2005.06	5MT		F	MPV Engine X20DTL	GCO44049	Outer Joint		33	25	52	109	61	O		
	1999.10-	2005.06	MT/AT		F	MPV Engine X20DTL	GCO44006	Outer Joint	29T	33	25	52	103.5	61	O		
	1999.10-	2005.06	MT	L	F	MPV Engine X20DTL	GDS44044	Drive Shaft	33	34	52	103.5	595				
2.0 DTi 16V (74 kW)	2000.09-	2005.06			F	MPV Engine Y20DTH	GCO44049	Outer Joint		33	25	52	109	61	O		
	2000.09-	2005.06	MT/AT		F	MPV Engine Y20DTH	GCO44006	Outer Joint	29T	33	25	52	103.5	61	O		
	2000.09-	2005.06	MT	L	F	MPV Engine Y20DTH	GDS44044	Drive Shaft	33	34	52	103.5	595				
2.0 OPC (141 kW)	2001.09-	2005.06	MT	L	F	MPV Engine Z20LET	GDS44025	Drive Shaft	33	34	55	104	593				
	2001.09-	2005.06	MT	L	F	MPV Engine Z20LET	GCI44018	Inner Joint	34	35	35	56	119.5				
	2001.09-	2005.06	MT	L	F	MPV Engine Z20LET	GCO99061	Outer Joint	33	35	55	104	67.5	I			
	2001.09-	2005.06	MT	R	F	MPV Engine Z20LET	GDS44082	Drive Shaft	33	34	55	104	663				
2.0 OPC (147 kW)	2002.11-	2005.06	MT	L	F	MPV Engine Z20LER/Z20LET	GDS44025	Drive Shaft	33	34	55	104	593				
	2002.11-	2005.06	MT	L	F	MPV Engine Z20LER/Z20LET	GCI44018	Inner Joint	34	35	35	56	119.5				
	2002.11-	2005.06	MT	L	F	MPV Engine Z20LER/Z20LET	GCO99061	Outer Joint	33	35	55	104	67.5	I			
	2002.11-	2005.06	MT	R	F	MPV Engine Z20LER/Z20LET	GDS44082	Drive Shaft	33	34	55	104	663				
2.2 16V (108 kW)	2000.09-	2005.06	5MT		F	MPV Engine Z22SE	GCO44049	Outer Joint		33	25	52	109	61	O		
	2000.09-	2005.06	MT	L	R	MPV Engine Z22SE	GDS44044	Drive Shaft	33	34	52	103.5	595				
2.2 DTi 16V (92 kW)	2002.01-	2005.06			F	MPV Engine Y22DTR	GCO44049	Outer Joint		33	25	52	109	61	O		
<b>ZAFIRA B</b>																	
1.6 (110 kW)	2006.01-					GCO44003	Outer Joint		33	22	53	95	54.5	M			
	2006.01-					GCI21014	Inner Joint		22	22	35	57.5	75				
1.6 (69 kW)	2006.01-					GCI21014	Inner Joint		22	22	35	57.5	75				
	2006.01-					GCO44003	Outer Joint		33	22	53	95	54.5	M			
1.6 (77 kW)	2006.01-					GCI21014	Inner Joint		22	22	35	57.5	75				
	2006.01-					GCO44003	Outer Joint		33	22	53	95	54.5	M			
1.6 (85 kW)	2006.01-					GCI21014	Inner Joint		22	22	35	57.5	75				
	2006.01-					GCO44003	Outer Joint		33	22	53	95	54.5	M			
1.7 CDTi 16V (81 kW)	2008.01-					GCO44027	Outer Joint		33	26	52.5	94	65.5	M			
1.7 CDTi 16V (92 kW)	2008.01-					GCO44027	Outer Joint		33	26	52.5	94	65.5	M			
1.8 16V (103 kW)	2005.07-					GCO44028	Outer Joint		33	24	53	93.5	63.5	M			
1.9 CDTi (74 kW)	2005.07-					GCO44027	Outer Joint		33	26	52.5	94	65.5	M			
1.9 CDTi (88 kW)	2005.07-					GCO44027	Outer Joint		33	26	52.5	94	65.5	M			









		TRANSM	L/R	F/R		G-AP Ref.	PRODUCT	ABS	Technical Specifications						
									YEAR	A	B	C	H	L	P
<b>OPEL</b>															
<b>ZAFIRA B</b>															
2.0 T 16V (147 kW)	2005.07-					GC044027	Outer Joint		33	26	52.5	94	65.5	M	
2.2 (110 kW)	2005.07-					GC044028	Outer Joint		33	24	53	93.5	63.5	M	
<b>ZAFIRA B (A05)</b>															
1.6 (77 kW)	2005.07-		MT		F	MPV Engine Z16XE1/Z16XEP	GC044003	Outer Joint	33	22	53	95	54.5	M	
	2005.07-		MT	L	F	MPV Engine Z16XE1/Z16XEP	GDS44028	Drive Shaft	33	22	53	95	590		
	2005.07-		MT	R	F	MPV Engine Z16XE1/Z16XEP	GDS44030	Drive Shaft	33	22	53	95	952		
	2005.07-		MT	L	F	MPV Engine Z16XE1/Z16XEP	GCI21014	Inner Joint	22	22	35	57.5	75		
	2005.07-		MT	R	F	MPV Engine Z16XE1/Z16XEP	GCI21014	Inner Joint	22	22	35	57.5	75		
1.6 (85 kW)	2008.01-			L	F	MPV Engine A16XER/Z16XER	GDS44028	Drive Shaft	33	22	53	95	590		
	2008.01-			R	F	MPV Engine A16XER/Z16XER	GDS44030	Drive Shaft	33	22	53	95	952		
	2008.01-			L	F	MPV Engine A16XER/Z16XER	GCI21014	Inner Joint	22	22	35	57.5	75		
	2008.01-			R	F	MPV Engine A16XER/Z16XER	GCI21014	Inner Joint	22	22	35	57.5	75		
1.6 CNG (69 kW)	2006.01-		MT	L	F	MPV Engine Z16YNG	GDS44028	Drive Shaft	33	22	53	95	590		
	2006.01-		MT	R	F	MPV Engine Z16YNG	GDS44030	Drive Shaft	33	22	53	95	952		
	2006.01-		MT	L	F	MPV Engine Z16YNG	GCI21014	Inner Joint	22	22	35	57.5	75		
	2006.01-		MT	R	F	MPV Engine Z16YNG	GCI21014	Inner Joint	22	22	35	57.5	75		
1.7 CDTi (81 kW)	2008.01-			L	F	MPV Engine A17DTJ/Z17DTJ	GDS21051	Drive Shaft	33	25	52.5	94	579		
	2008.01-		MT			MPV Engine A17DTJ/Z17DTJ	GC099024	Outer Joint	33	26	52.5	94	65.5	M	
1.7 CDTi (92 kW)	2008.01-			L	F	MPV Engine A17DTR	GDS21051	Drive Shaft	33	25	52.5	94	579		
	2008.01-		MT			MPV Engine A17DTR	GC099024	Outer Joint	33	26	52.5	94	65.5	M	
1.8 (103 kW)	2005.09-	2008.03	MT	L	F	MPV Engine A18XER/Z18XER	GDS21063	Drive Shaft	33	22	53	93.5	586		
1.8 (88 kW)	2013.06-		MT	L	F	MPV Engine A 18 XEL	GDS21063	Drive Shaft	33	22	53	93.5	586		
1.9 CDTi (110 kW)	2005.07-		MT		F	MPV Engine Z19DTH	GC017051	Outer Joint	30	26	53.8	94.5	65.5	M	
	2005.07-		MT	L	F	MPV Engine Z19DTH	GDS21071	Drive Shaft	30	25	53.8	94.5	576		
	2005.07-		MT	R	F	MPV Engine Z19DTH	GDS21062	Drive Shaft	30	34	53.8	94.5	595		
	2005.07-					MPV Engine Z19DTH	GC099023	Outer Joint	30	26	53.8	94.5	65.5	M	
1.9 CDTi (74 kW)	2005.07-				F	MPV Engine Z19DTL	GC044027	Outer Joint	33	26	52.5	94	65.5	M	
	2005.07-		MT	R	F	MPV Engine Z19DTL	GDS21056	Drive Shaft	33	34	52.5	94	595		
	2005.07-		MT	L	F	MPV Engine Z19DTL	GDS21051	Drive Shaft	33	25	52.5	94	579		
	2005.07-					MPV Engine Z19DTL	GC099024	Outer Joint	33	26	52.5	94	65.5	M	
1.9 CDTi (88 kW)	2005.07-				F	MPV Engine Z19DT	GC017051	Outer Joint	30	26	53.8	94.5	65.5	M	
	2005.07-		MT	R	F	MPV Engine Z19DT	GDS21056	Drive Shaft	33	34	52.5	94	595		
	2005.07-		MT	L	F	MPV Engine Z19DT	GDS21051	Drive Shaft	33	25	52.5	94	579		
	2005.07-					MPV Engine Z19DT	GC099024	Outer Joint	33	26	52.5	94	65.5	M	
2.0 (147 kW)	2005.07-				F	MPV Engine Z20LER	GC044027	Outer Joint	33	26	52.5	94	65.5	M	
	2005.07-				R	MPV Engine Z20LER	GDS21056	Drive Shaft	33	34	52.5	94	595		
	2005.07-					MPV Engine Z20LER	GC099024	Outer Joint	33	26	52.5	94	65.5	M	
2.0 (177 kW)	2005.07-	2008.03			F	MPV Engine Z20LEH	GC044027	Outer Joint	33	26	52.5	94	65.5	M	
	2005.07-	2008.03			R	MPV Engine Z20LEH	GDS21062	Drive Shaft	30	34	53.8	94.5	595		
	2005.07-	2008.03				MPV Engine Z20LEH	GC099023	Outer Joint	30	26	53.8	94.5	65.5	M	
2.2 (110 kW)	2005.07-		MT	R	F	MPV Engine Z22YH	GDS44051	Drive Shaft	33	34	53	93.5	570		
	2005.07-		MT	R	F	MPV Engine Z22YH	GCI44011	Inner Joint	34	25	37.5	46	55		
	2005.07-		MT	R	F	MPV Engine Z22YH	GC044028	Outer Joint	33	24	53	93.5	63.5	M	
<b>ZAFIRA B VAN</b>															
1.7 CDTi (81 kW)	2008.01-			L	F	Box Engine A17DTJ/Z17DTJ	GDS21051	Drive Shaft	33	25	52.5	94	579		
	2008.01-					Box Engine A17DTJ/Z17DTJ	GC099024	Outer Joint	33	26	52.5	94	65.5	M	
1.7 CDTi (92 kW)	2008.01-			L	F	Box Engine A17DTR	GDS21051	Drive Shaft	33	25	52.5	94	579		
	2008.01-		MT			Box Engine A17DTR	GC099024	Outer Joint	33	26	52.5	94	65.5	M	
1.8 (103 kW)	2005.07-			L	F	Box Engine A18XER/Z18XER	GDS21063	Drive Shaft	33	22	53	93.5	586		
<b>ZAFIRA TOURER C (P12)</b>															
1.6 CDTi (100 kW)	2013.02-		MT	R	F	MPV Engine B 16 DTH	GDS60027	Drive Shaft	30	27	52.5	94.5	619		
1.6 CDTi (88 kW)	2014.07-		MT	L	F	MPV Engine B 16 DTH	GDS60027	Drive Shaft	30	27	52.5	94.5	619		
1.8 LPG (101 kW)	2011.10-			L	F	MPV Engine A14NET	GDS21063	Drive Shaft	33	22	53	93.5	586		
2.0 BiTurbo CDTi (143 kW)	2013.01-		MT	R	F	MPV Engine A20DTR	GDS60027	Drive Shaft	30	27	52.5	94.5	619		
2.0 CDTi (121 kW)	2011.10-		MT	L	F	MPV Engine A20DTH	GDS60027	Drive Shaft	30	27	52.5	94.5	619		
2.0 CDTi (125 kW)	2015.01-		MT	L	F	MPV Engine B 20 DTH	GDS60027	Drive Shaft	30	27	52.5	94.5	619		
2.0 CDTi (81 kW)	2011.10-			L	F	MPV Engine A20DTL	GDS60027	Drive Shaft	30	27	52.5	94.5	619		
2.0 CDTi (96 kW)	2011.10-			L	F	MPV Engine A20DT/Y20DTJ/Z20DTJ	GDS60027	Drive Shaft	30	27	52.5	94.5	619		
<b>OPEL LCV</b>															
<b>ASTRA G VAN (F70)</b>															
1.7 DTi (55 kW)	2001-	2004					GC044006	Outer Joint	29T	33	25	52	103.5	61	O

		TRANSM	L/R	F/R		G-AP Ref.	PRODUCT	ABS	Technical Specifications															
									YEAR	A	B	C	H	L	P									
<b>OPEL LCV</b>																								
<b>ASTRA G VAN (F70)</b>																								
2.0 Di 16V (60 kW)	1999.01-	2005.04				GC044006	Outer Joint	29T	33	25	52	103.5	61	O										
2.0 DTi (74 kW)	1999-	2004				GC044006	Outer Joint	29T	33	25	52	103.5	61	O										
<b>ASTRA H VAN</b>																								
1.4 16V (66 kW)	2004-					GC044003	Outer Joint		33	22	53	95	54.5	M										
1.6 16V (76 kW)	2005-					GC044003	Outer Joint		33	22	53	95	54.5	M										
1.7 CDTi (59 kW)	2005-	2006				GC044028	Outer Joint		33	24	53	93.5	63.5	M										
1.7 CDTi (74 kW)	2005-	2006				GC044028	Outer Joint		33	24	53	93.5	63.5	M										
1.7 CDTi (81 kW)	2007-					GC044027	Outer Joint		33	26	52.5	94	65.5	M										
<b>CORSA C VAN (F08, W5L)</b>																								
1.2 (59 kW)	2005.07-					GC060001	Outer Joint		22	28	52	97.5	54.5	O										
1.2 16V (55 kW)	2000.09-					GC060001	Outer Joint		22	28	52	97.5	54.5	O										
1.4 (66 kW)	2003.08-					GC060001	Outer Joint		22	28	52	97.5	54.5	O										
1.7 CDTi (74 kW)	2003.08-					GC044004	Outer Joint	29T	33	24	52	104	64	M										
<b>MOVANO I (J9)</b>																								
1.9 DTi (59 kW)	2001.10-	2010				GC044026	Outer Joint	51T	28	36	65	96	71	I										
1.9 DTi (60 kW)	2001.10-	2010				GC044026	Outer Joint	51T	28	36	65	96	71	I										
2.2 DTi (66 kW)	2000.09-	2010				GC044026	Outer Joint	51T	28	36	65	96	71	I										
2.5 CDTi (107 kW)	2006.08-	2010				GC044026	Outer Joint	51T	28	36	65	96	71	I										
2.5 CDTi (74 kW)	2006.08-	2010				GC044026	Outer Joint	51T	28	36	65	96	71	I										
2.5 CDTi (88 kW)	2006.08-	2010				GC044026	Outer Joint	51T	28	36	65	96	71	I										
2.5 DTi (73 kW)	2001.10-	2010				GC044026	Outer Joint	51T	28	36	65	96	71	I										
2.5 DTi (84 kW)	2001.10-	2010				GC044026	Outer Joint	51T	28	36	65	96	71	I										
2.8 DTi (84 kW)	1998.07-	2001.10				GC044026	Outer Joint	51T	28	36	65	96	71	I										
3.0 CDTi (100 kW)	2003.10-	2010				GC044026	Outer Joint	51T	28	36	65	96	71	I										
<b>ZAFIRA VAN</b>																								
1.7 CDTi (81 kW)	2008-					GC044027	Outer Joint		33	26	52.5	94	65.5	M										
1.7 CDTi (92 kW)	2008-					GC044027	Outer Joint		33	26	52.5	94	65.5	M										
1.8 (103 kW)	2005.07-					GC044028	Outer Joint		33	24	53	93.5	63.5	M										
<b>PERODUA</b>																								
<b>KELISA (L7_)</b>																								
1.0 DVVT (43 kW)	2002.02-			L	F	Hatchback Engine EJ-VE	GDS14035	Drive Shaft	24	23	47	84.5	581											
	2002.02-			R	F	Hatchback Engine EJ-VE	GDS14036	Drive Shaft	24	23	47	84.5	794											
<b>PEUGEOT</b>																								
<b>1007 (KM)</b>																								
1.4 (55 kW)	2005.04-						GC045056	Outer Joint	21	27	49	86	53	O										
1.4 16V (65 kW)	2005.10-						GC010077	Outer Joint	21	28	49	86	56.5	O										
1.6 16V (80 kW)	2005.04-						GC010077	Outer Joint	21	28	49	86	56.5	O										
<b>1007 (KM_)</b>																								
1.4 (54 kW)	2005.04-	2007.06			F	Hatchback Engine KFV(TU3JP)	GC045056	Outer Joint	21	27	49	86	53	O										
	2005.04-	2007.06		L	F	Hatchback Engine KFV(TU3JP)	GDS10125	Drive Shaft	21	22	48	86.5	649											
	2005.04-	2007.06		R	F	Hatchback Engine KFV(TU3JP)	GDS10124	Drive Shaft	21	22	48	86.5	840											
1.4 16V (65 kW)	2006.03-	2007.06			F	Hatchback Engine KFU(ET3J4)	GC045057	Outer Joint	21	22	48	86.5	54	I										
	2006.03-	2007.06			F	Hatchback Engine KFU(ET3J4)	GC010077	Outer Joint	21	28	49	86	56.5	O										
	2006.03-	2007.06		L	F	Hatchback Engine KFU(ET3J4)	GDS10146	Drive Shaft	21	22	48	86.5	642											
	2006.03-	2007.06		R	F	Hatchback Engine KFU(ET3J4)	GDS10144	Drive Shaft	21	22	48	86.5	843											
1.4 HDi (50 kW)	2005.04-	2007.06		L	F	Hatchback Engine 8HX(DV4TD)/8HZ(DV4TD)	GDS10419	Drive Shaft	21	22	48.5	86	643											
	2005.04-	2007.06		L	F	Hatchback Engine 8HX(DV4TD)/8HZ(DV4TD)	GDS10420	Drive Shaft	21	22	48	86.5	637											
1.6 16V (80 kW)	2005.04-	2007.06			F	Hatchback Engine NFU(TU5JP4)	GC010077	Outer Joint	21	28	49	86	56.5	O										
1.6 HDi (80 kW)	2007.07-		MT	L	F	Hatchback Engine 9HZ(DV6TED4)	GDS10364	Drive Shaft	21	24	50	85	631											
	2007.07-		MT	L	F	Hatchback Engine 9HZ(DV6TED4)	GCI10092	Inner Joint	24	22	40	69	86											
	2007.07-		MT	L	F	Hatchback Engine 9HZ(DV6TED4)	GC099301	Outer Joint	21	22	50	85	53	I										
<b>104</b>																								
0.9 (33 kW)	1979.10-	1983.10	MT	L/R	F	Hatchback Engine 108(XV5)	GDS10130	Drive Shaft	21	22	54	90	683											
1.0 (32 kW)	1983.09-	1988.06	MT	L/R	F	Hatchback Engine 108C(XV8)	GDS10130	Drive Shaft	21	22	54	90	683											
1.1 (37 kW)	1979.08-	1988.06	MT	L/R	F	Coupe Engine 109F(XW7)	GDS10130	Drive Shaft	21	22	54	90	683											
	1980.08-	1988.06	MT	L/R	F	Hatchback Engine 109F(XW7)	GDS10130	Drive Shaft	21	22	54	90	683											
1.1 (42 kW)	1976.07-	1982.08	MT	L/R	F	Hatchback Engine 109(XW3)	GDS10130	Drive Shaft	21	22	54	90	683											
	1979.08-	1983.06	MT	L/R	F	Coupe Engine 109(XW3)	GDS10130	Drive Shaft	21	22	54	90	683											
1.2 (42 kW)	1979.08-	1983.06	MT	L/R	F	Hatchback Engine 129(XZ5)	GDS10130	Drive Shaft	21	22	54	90	683											
1.4 (53 kW)	1979.08-	1983.06	MT	L/R	F	Hatchback Engine 150(XY6B)	GDS10130	Drive Shaft	21	22	54	90	683											



		TRANSM	L/R	F/R		G-AP Ref.	PRODUCT	ABS	Technical Specifications						
									YEAR	A	B	C	H	L	P
<b>PEUGEOT</b>															
<b>104</b>															
1.4 (53 kW)	1979.08-	1984.06	MT	L/R	F	Coupe Engine 150(XY6B)	GDS10130	Drive Shaft		21	22	54	90	683	
<b>106</b>															
1.4	1991.01-			R			GDS10093	Drive Shaft		21	22	56.4	76	796	
	1991.01-			L			GDS10094	Drive Shaft		21	22	56.4	76	615	
1.5	1991.01-			R			GDS10093	Drive Shaft		21	22	56.4	76	796	
	1991.01-			L			GDS10094	Drive Shaft		21	22	56.4	76	615	
1.6	1991.01-			R			GDS10093	Drive Shaft		21	22	56.4	76	796	
	1991.01-			L			GDS10094	Drive Shaft		21	22	56.4	76	615	
<b>106 II</b>															
1.6	1998.05-		MT	R	F		GDS10119	Drive Shaft	48T	21	22	50	85	812	
<b>106 II (1)</b>															
1.1 i (40 kW)	1997.01-			L	F	Hatchback Engine HDY(TU1M)	GDS45071	Drive Shaft		21	22	48	86.5	622	
	1997.01-			R	F	Hatchback Engine HDY(TU1M)	GDS45072	Drive Shaft		21	22	48	86.5	798.5	
1.1 i (44 kW)	1996.05-			L	F	Hatchback Engine HDZ(TU1M)/HFX(TU1JP)	GDS45071	Drive Shaft		21	22	48	86.5	622	
	1996.05-			R	F	Hatchback Engine HDZ(TU1M)/HFX(TU1JP)	GDS45072	Drive Shaft		21	22	48	86.5	798.5	
1.5 D (40 kW)	1996.05-			L	F	Hatchback Engine VJY(TUD5)	GDS45071	Drive Shaft		21	22	48	86.5	622	
	1996.05-			R	F	Hatchback Engine VJY(TUD5)	GDS45072	Drive Shaft		21	22	48	86.5	798.5	
1.5 D (42 kW)	1998.04-			L	F	Hatchback Engine VJX(TUD5)	GDS45071	Drive Shaft		21	22	48	86.5	622	
	1998.04-			R	F	Hatchback Engine VJX(TUD5)	GDS45072	Drive Shaft		21	22	48	86.5	798.5	
<b>107</b>															
1.0 (50 kW)	2005.06-			L	F	Hatchback Engine 1KR(384F)	GDS10232	Drive Shaft		24	23	49.5	91	650	
	2005.06-			R	F	Hatchback Engine 1KR(384F)	GDS10231	Drive Shaft		24	23	49.5	91	841	
	2005.06-			L/R	F	Hatchback Engine 1KR(384F)	GCI59069	Inner Joint		23	19	34	60	101	
	2005.06-			L/R	F	Hatchback Engine 1KR(384F)	GC099128	Outer Joint		24	19	49.5	91	46	M
	2005.06-						GCI59069	Inner Joint		23	19	34	60	101	
1.4 HDi (40 kW)	2005.06-			L	F	Hatchback Engine 8HT(DV4TD)	GDS59495	Drive Shaft		24	23	49.5	91	593	
	2005.06-			L	F	Hatchback Engine 8HT(DV4TD)	GCI59069	Inner Joint		23	19	34	60	101	
	2005.06-			L/R	F	Hatchback Engine 8HT(DV4TD)	GC045058	Outer Joint		24	20	49.5	91	46	M
	2005.06-						GCI59069	Inner Joint		23	19	34	60	101	
<b>508</b>															
1.6 HDi (82 kW)	2010.11-		MT	L	F	Estate Engine 9HR(DV6C)	GDS10343	Drive Shaft		28	37	58.6	93	672	
1.6 HDi (84 kW)	2012.02-		MT	L	F	Estate Engine 9HD(DV6CTED)	GDS10343	Drive Shaft		28	37	58.6	93	672	
2.0 HDi (103 kW)	2010.11-		MT	L	F	Estate Engine RHF(DW10BTED4)	GDS10343	Drive Shaft		28	37	58.6	93	672	
2.0 HDi (120 kW)	2010.11-		MT	L	F	Estate Engine RHH(DW10CTED4)	GDS10343	Drive Shaft		28	37	58.6	93	672	
<b>2008</b>															
1.6 HDi (68 kW)	2013.03-		6MT	L	F	Estate Engine 9HP(DV6DTEDE)	GDS10253	Drive Shaft		25	24	58.5	79	626	
	2013.03-		6MT	L	F	Estate Engine 9HP(DV6DTEDE)	GCI10057	Inner Joint		24	34	40	52.5	90	
	2013.03-		6MT	L	F	Estate Engine 9HP(DV6DTEDE)	GC010148	Outer Joint		25	34	58.5	79	55.5	I
	2013.03-		AT	L	F	Estate Engine 9HP(DV6DTEDE)	GDS45202	Drive Shaft		25	26	58.5	78.5	620	
1.6 HDi (84 kW)	2013.03-		MT	L	F	Estate Engine 9HD(DV6CTED)	GDS10253	Drive Shaft		25	24	58.5	79	626	
	2013.03-		MT	L	F	Estate Engine 9HD(DV6CTED)	GCI10057	Inner Joint		24	34	40	52.5	90	
	2013.03-		MT	L	F	Estate Engine 9HD(DV6CTED)	GC010148	Outer Joint		25	34	58.5	79	55.5	I
<b>205</b>															
-			MT/AT				GCI10005	Inner Joint		24	29	40	69	99	
			MT/AT	L			GDS99013	Drive Shaft		21	24	56	76	564	
			MT/AT	R			GDS99012	Drive Shaft		21	24	56	76	838	
1.0/1.1	1987.08-			L			GC045016	Outer Joint		21	22	56.4	76	61	O
1.8 D (44 kW)	1983.02-	1990.07			F	Box Engine A9A(XUD7)	GC010009	Outer Joint		21	22	56	79	60	I
1.9 CTi/GTi	1987.01-	1994.01	MT/AT		F		GC010065	Outer Joint	48T	25	34	58.5	80	55	I
<b>205 (741A/C)</b>															
1.4 (44 kW)	1983.02-	1987.10	MT	L/R	F	Hatchback Engine 150D(XY7)/150G(XY7)	GDS45111	Drive Shaft		21	22	56.4	76	714	
1.6 (53 kW)	1987.03-	1987.10			F	Hatchback Engine B1E(XU51C)	GC010009	Outer Joint		21	22	56	79	60	I
1.6 (55 kW)	1986.08-	1987.10			F	Hatchback Engine B1A(XU51C)	GC010009	Outer Joint		21	22	56	79	60	I
1.6 GTi (76 kW)	1984.12-	1987.10	MT	L	F	Hatchback Engine 180A(XU5J)	GDS45068	Drive Shaft		21	24	56.4	76	563	
	1984.12-	1987.10	MT	R	F	Hatchback Engine 180A(XU5J)	GDS45066	Drive Shaft		21	24	56.4	76	825.5	
1.7 Diesel (44 kW)	1983.08-	1987.10	MT		F	Hatchback Engine 161A(XUD7)	GC010009	Outer Joint		21	22	56	79	60	I
1.9 GTi (75 kW)	1987.03-	1987.10	MT	L	F	Hatchback Engine DFZ(XU9J1)	GDS10022	Drive Shaft	48T	25	24	54.8	78.5	573	
	1987.03-	1987.10	MT	L	F	Hatchback Engine DFZ(XU9J1)	GDS45134	Drive Shaft		25	24	54.8	78.5	573	
	1987.03-	1987.10	MT	R	F	Hatchback Engine DFZ(XU9J1)	GDS10177	Drive Shaft		25	24	54.8	78.5	845	
1.9 GTi (94 kW)	1986.10-	1987.10	MT	L	F	Hatchback Engine D6B(XU9JA)	GDS10022	Drive Shaft	48T	25	24	54.8	78.5	573	
	1986.10-	1987.10	MT	L	F	Hatchback Engine D6B(XU9JA)	GDS45134	Drive Shaft		25	24	54.8	78.5	573	





		YEAR	TRANSM	L/R	F/R		G-AP Ref.	PRODUCT	ABS	Technical Specifications						
										A	B	C	H	L	P	
<b>PEUGEOT</b>																
<b>205 (741A/C)</b>																
1.9 GTi (94 kW)	1986.10-	1987.10	MT	R	F	Hatchback Engine D6B(XU9JA)	GDS10177	Drive Shaft			25	24	54.8	78.5	845	
<b>205 (741B, 20D)</b>																
1.1 CJ (44 kW)	1989.10-	1994.12	MT	L	F	Convertible Engine HDZ(TU1M)	GDS45015	Drive Shaft			21	22	56.4	76	576	
	1989.10-	1994.12	MT	R	F	Convertible Engine HDZ(TU1M)	GDS45001	Drive Shaft			21	22	56.4	76	830.5	
	1989.10-	1994.12	MT	L	F	Convertible Engine HDZ(TU1M)	GDS10010	Drive Shaft			21	22	54	76	572	
	1989.10-	1994.12	MT	R	F	Convertible Engine HDZ(TU1M)	GDS10044	Drive Shaft			21	22	56.4	76	832.5	
1.4 CJ (44 kW)	1988.03-	1989.05	MT	L	F	Convertible Engine 150D(XY7)/150G(XY7)	GDS10010	Drive Shaft			21	22	54	76	572	
	1988.03-	1989.05	MT	R	F	Convertible Engine 150D(XY7)/150G(XY7)	GDS10044	Drive Shaft			21	22	56.4	76	832.5	
1.4 CJ (49 kW)	1989.03-	1994.12	MT	L	F	Convertible Engine K1D(TU3A)	GDS10010	Drive Shaft			21	22	54	76	572	
	1989.03-	1994.12	MT	R	F	Convertible Engine K1D(TU3A)	GDS10044	Drive Shaft			21	22	56.4	76	832.5	
1.4 CJ (55 kW)	1991.05-	1994.12	MT	L	F	Convertible Engine KDY(TU3M)/KDZ(TU3M)	GDS10010	Drive Shaft			21	22	54	76	572	
	1991.05-	1994.12	MT	R	F	Convertible Engine KDY(TU3M)/KDZ(TU3M)	GDS10044	Drive Shaft			21	22	56.4	76	832.5	
1.4 CJ CAT (44 kW)	1989.01-	1993.09	MT	L	F	Convertible Engine KAY(TU3CP)	GDS10010	Drive Shaft			21	22	54	76	572	
	1989.01-	1993.09	MT	R	F	Convertible Engine KAY(TU3CP)	GDS10044	Drive Shaft			21	22	56.4	76	832.5	
1.4 CT (58 kW)	1986.04-	1988.12	MT	L/R	F	Convertible Engine 150B(XY8)/150H(XY8)	GDS45111	Drive Shaft			21	22	56.4	76	714	
	1986.04-	1988.12	MT	L	F	Convertible Engine 150B(XY8)/150H(XY8)	GDS10010	Drive Shaft			21	22	54	76	572	
	1986.04-	1988.12	MT	R	F	Convertible Engine 150B(XY8)/150H(XY8)	GDS10044	Drive Shaft			21	22	56.4	76	832.5	
1.6 CJ (65 kW)	1992.08-	1994.12	AT		F	Convertible Engine BDY(XU5M3Z)	GC010009	Outer Joint			21	22	56	79	60	
1.6 CTi (76 kW)	1986.04-	1990.10	MT	L	F	Convertible Engine 180A(XU5J)/180Z(XU5J)	GDS45068	Drive Shaft			21	24	56.4	76	563	
	1986.04-	1990.10	MT	R	F	Convertible Engine 180A(XU5J)/180Z(XU5J)	GDS45066	Drive Shaft			21	24	56.4	76	825.5	
1.9 CTi (75 kW)	1987.10-	1994.12	MT	L	F	Convertible Engine DFZ(XU9J1)	GDS10022	Drive Shaft	48T		25	24	54.8	78.5	573	
	1987.10-	1994.12	MT	L	F	Convertible Engine DFZ(XU9J1)	GDS45134	Drive Shaft			25	24	54.8	78.5	573	
	1987.10-	1994.12	MT	R	F	Convertible Engine DFZ(XU9J1)	GDS10177	Drive Shaft			25	24	54.8	78.5	845	
<b>205 II (20A/C)</b>																
1.0 (33 kW)	1987.10-	1988.09	MT	L	F	Hatchback Engine TU9	GDS45015	Drive Shaft			21	22	56.4	76	576	
	1987.10-	1988.09	MT	R	F	Hatchback Engine TU9	GDS45001	Drive Shaft			21	22	56.4	76	830.5	
	1987.10-	1988.09	MT	L	F	Hatchback Engine TU9	GDS10010	Drive Shaft			21	22	54	76	572	
	1987.10-	1988.09	MT	R	F	Hatchback Engine TU9	GDS10044	Drive Shaft			21	22	56.4	76	832.5	
1.1 (36 kW)	1987.10-	1990.10	MT	L	F	Hatchback Engine 109N(XW7)	GDS45015	Drive Shaft			21	22	56.4	76	576	
	1987.10-	1990.10	MT	R	F	Hatchback Engine 109N(XW7)	GDS45001	Drive Shaft			21	22	56.4	76	830.5	
	1987.10-	1990.10	MT	L	F	Hatchback Engine 109N(XW7)	GDS10010	Drive Shaft			21	22	54	76	572	
	1987.10-	1990.10	MT	R	F	Hatchback Engine 109N(XW7)	GDS10044	Drive Shaft			21	22	56.4	76	832.5	
1.1 (40 kW)	1987.10-	1990.10	MT	L	F	Hatchback Engine H1B(TU1)	GDS45015	Drive Shaft			21	22	56.4	76	576	
	1987.10-	1990.10	MT	R	F	Hatchback Engine H1B(TU1)	GDS45001	Drive Shaft			21	22	56.4	76	830.5	
	1987.10-	1990.10	MT	L	F	Hatchback Engine H1B(TU1)	GDS10010	Drive Shaft			21	22	54	76	572	
	1987.10-	1990.10	MT	R	F	Hatchback Engine H1B(TU1)	GDS10044	Drive Shaft			21	22	56.4	76	832.5	
1.1 (44 kW)	1989.07-	1988.09	MT	L	F	Hatchback Engine HDZ(TU1M)	GDS45015	Drive Shaft			21	22	56.4	76	576	
	1989.07-	1988.09	MT	R	F	Hatchback Engine HDZ(TU1M)	GDS45001	Drive Shaft			21	22	56.4	76	830.5	
	1989.07-	1988.09	MT	L	F	Hatchback Engine HDZ(TU1M)	GDS10010	Drive Shaft			21	22	54	76	572	
	1989.07-	1988.09	MT	R	F	Hatchback Engine HDZ(TU1M)	GDS10044	Drive Shaft			21	22	56.4	76	832.5	
1.4 (44 kW)	1987.10-	1989.05	MT	L/R	F	Hatchback Engine 150D(XY7)/150G(XY7)	GDS45111	Drive Shaft			21	22	56.4	76	714	
	1987.10-	1989.05	MT	L	F	Hatchback Engine 150D(XY7)/150G(XY7)	GDS10010	Drive Shaft			21	22	54	76	572	
	1987.10-	1989.05	MT	R	F	Hatchback Engine 150D(XY7)/150G(XY7)	GDS10044	Drive Shaft			21	22	56.4	76	832.5	
1.4 (49 kW)	1987.10-	1990.10	MT	L	F	Hatchback Engine K1D(TU3A)	GDS10010	Drive Shaft			21	22	54	76	572	
	1987.10-	1990.10	MT	R	F	Hatchback Engine K1D(TU3A)	GDS10044	Drive Shaft			21	22	56.4	76	832.5	
1.4 (55 kW)	1988.07-	1988.09	MT	L	F	Hatchback Engine KDY(TU3M)/KDZ(TU3M)/KFX(TU3JP)	GDS10010	Drive Shaft			21	22	54	76	572	
	1988.07-	1988.09	MT	R	F	Hatchback Engine KDY(TU3M)/KDZ(TU3M)/KFX(TU3JP)	GDS10044	Drive Shaft			21	22	56.4	76	832.5	
1.4 (58 kW)	1988.07-	1989.05	MT	L	F	Hatchback Engine 150B(XY8)/150H(XY8)	GDS10022	Drive Shaft	48T		25	24	54.8	78.5	573	
	1988.07-	1989.05	MT	L/R	F	Hatchback Engine 150B(XY8)/150H(XY8)	GDS45111	Drive Shaft			21	22	56.4	76	714	
1.4 (62 kW)	1987.06-	1989.12	MT	L	F	Hatchback Engine K2B(TU3S)	GDS10010	Drive Shaft			21	22	54	76	572	
	1987.06-	1989.12	MT	R	F	Hatchback Engine K2B(TU3S)	GDS10044	Drive Shaft			21	22	56.4	76	832.5	
1.4 CAT (44 kW)	1987.08-	1993.09	MT	L	F	Hatchback Engine KAY(TU3CP)	GDS10010	Drive Shaft			21	22	54	76	572	
	1987.08-	1993.09	MT	R	F	Hatchback Engine KAY(TU3CP)	GDS10044	Drive Shaft			21	22	56.4	76	832.5	
1.6 (53 kW)	1987.10-	1998.09			F	Hatchback Engine B1E(XU51C)	GC010009	Outer Joint			21	22	56	79	60	
1.6 (55 kW)	1987.10-	1998.09			F	Hatchback Engine B1A(XU51C)/BAZ(XU5CP)	GC010009	Outer Joint			21	22	56	79	60	
1.6 (66 kW)	1990.08-	1992.07	AT		F	Hatchback Engine 171(XU5S)	GC010009	Outer Joint			21	22	56	79	60	
1.6 Aut. (65 kW)	1990.05-	1998.09			F	Hatchback Engine BDY(XU5M2Z)/BDY(XU5M3Z)	GC010009	Outer Joint			21	22	56	79	60	
1.6 GTi (76 kW)	1987.10-	1989.12	MT	L	F	Hatchback Engine 180A(XU5J)/180Z(XU5J)	GDS45068	Drive Shaft			21	24	56.4	76	563	
	1987.10-	1989.12	MT	R	F	Hatchback Engine 180A(XU5J)/180Z(XU5J)	GDS45066	Drive Shaft			21	24	56.4	76	825.5	
1.7 Diesel (44 kW)	1987.07-	1998.09	MT		F	Hatchback Engine 161A(XUD7)	GC010009	Outer Joint			21	22	56	79	60	
1.8 XDT (58 kW)	1990.08-	1997.05	MT		F	Hatchback Engine XUD7T	GC010009	Outer Joint			21	22	56	79	60	



		TRANSM	L/R	F/R		G-AP Ref.	PRODUCT	ABS	Technical Specifications								
									YEAR	A	B	C	H	L	P		
<b>PEUGEOT</b>																	
<b>205 II (20AC)</b>																	
1.9 Diesel (47 kW)	1987.10-	1998.09	MT/AT		F	Hatchback Engine DJZ(XUD9Y)	GC010009	Outer Joint		21	22	56	79	60	I		
1.9 GTi (75 kW)	1987.10-	1989.05	MT	L	F	Hatchback Engine D2A(XU92C)	GDS10022	Drive Shaft	48T	25	24	54.8	78.5	573			
	1987.10-	1989.05	MT	L	F	Hatchback Engine D2A(XU92C)	GDS45134	Drive Shaft		25	24	54.8	78.5	573			
	1987.10-	1989.05	MT	R	F	Hatchback Engine D2A(XU92C)	GDS10177	Drive Shaft		25	24	54.8	78.5	845			
1.9 GTi (88 kW)	1987.10-	1994.10	MT	L	F	Hatchback Engine DKZ(XU9JAZ)	GDS10022	Drive Shaft	48T	25	24	54.8	78.5	573			
	1987.10-	1994.10	MT		F	Hatchback Engine DKZ(XU9JAZ)	GC010005	Outer Joint	90T	25	23	54.8	78.5	56	I		
	1987.10-	1994.10	MT	L	F	Hatchback Engine DKZ(XU9JAZ)	GDS45134	Drive Shaft		25	24	54.8	78.5	573			
	1987.10-	1994.10	MT	R	F	Hatchback Engine DKZ(XU9JAZ)	GDS10177	Drive Shaft		25	24	54.8	78.5	845			
1.9 GTi (94 kW)	1987.10-	1998.09	MT	L	F	Hatchback Engine D6B(XU9JA)	GDS10022	Drive Shaft	48T	25	24	54.8	78.5	573			
	1987.10-	1998.09	MT		F	Hatchback Engine D6B(XU9JA)	GC010005	Outer Joint	90T	25	23	54.8	78.5	56	I		
	1987.10-	1998.09	MT	L	F	Hatchback Engine D6B(XU9JA)	GDS45134	Drive Shaft		25	24	54.8	78.5	573			
	1987.10-	1998.09	MT	R	F	Hatchback Engine D6B(XU9JA)	GDS10177	Drive Shaft		25	24	54.8	78.5	845			
1.9 GTi CAT (75 kW)	1987.10-	1994.07	MT	L	F	Hatchback Engine DFZ(XU9J1)	GDS10022	Drive Shaft	48T	25	24	54.8	78.5	573			
	1987.10-	1994.07	MT		F	Hatchback Engine DFZ(XU9J1)	GC010005	Outer Joint	90T	25	23	54.8	78.5	56	I		
	1987.10-	1994.07	MT	L	F	Hatchback Engine DFZ(XU9J1)	GDS45134	Drive Shaft		25	24	54.8	78.5	573			
	1987.10-	1994.07	MT	R	F	Hatchback Engine DFZ(XU9J1)	GDS10177	Drive Shaft		25	24	54.8	78.5	845			
<b>205 VAN</b>																	
1.7 Diesel (44 kW)	1994.03-				F	Box Engine 161A(XUD7)	GC010009	Outer Joint		21	22	56	79	60	I		
<b>206</b>																	
-							GC045010	Outer Joint		21	22	50.5	86.5	56	I		
						LADO DIREITO	GCI45019	Inner Joint		22	22	29.85	329.5	87.5			
	1999-	2004	MT				GC010100	Outer Joint		21	21	48.5	86	54	I		
1.0 16V	2002-						GC099009	Outer Joint		21	22	50	87	51	I		
1.1	1998-		MT				GC045048	Outer Joint	48T	21	22	48	86.5	54	I		
1.1/1.4	1998.10-		MT		F		GC045046	Outer Joint		21	22	50	86.5	54	I		
1.4	1998-		MT				GC045048	Outer Joint	48T	21	22	48	86.5	54	I		
	1998.09-						GCI45012	Inner Joint		22	22	29.85	329.5	87.5			
	1998.09-			L			GDS10063	Drive Shaft		21	22	48	86.5	619.5			
1.4 (55 kW)	2007.03-		AT		F	Saloon Engine KFW(TU3JP)/KFV(TU3A)	GC045012	Outer Joint		21	34	48.5	86	55.5	I		
	2007.03-		AT		F	Saloon Engine KFW(TU3JP)/KFV(TU3A)	GC010056	Outer Joint	48T	21	34	48.5	86	55.5	I		
	2007.03-		MT		F	Saloon Engine KFW(TU3JP)/KFV(TU3A)	GC045011	Outer Joint		21	22	48	86.5	54	I		
	2007.03-		MT		F	Saloon Engine KFW(TU3JP)/KFV(TU3A)	GC045033	Outer Joint	48T	21	22	48	86.5	54	I		
	2007.03-		AT	R	F	Saloon Engine KFW(TU3JP)/KFV(TU3A)	GDS45147	Drive Shaft		21	23	48.5	86	807			
	2007.03-		AT	R	F	Saloon Engine KFW(TU3JP)/KFV(TU3A)	GCI50098	Inner Joint		23	34	30	209	88			
	2007.03-		AT	R	F	Saloon Engine KFW(TU3JP)/KFV(TU3A)	GC045012	Outer Joint		21	34	48.5	86	55.5	I		
1.4 HDi Eco (50 kW)	2008.09-			L	F	Saloon Engine 8HZ(DV4TD)	GDS45031	Drive Shaft		21	22	48	86.5	604.5			
1.6 16V	1998-	2010		L/R	F	Engine TU5J4	GC045037	Outer Joint	48T	25	22	60	78.7	54	M		
1.6 16V (80 kW)	2007.03-		AT	L	F	Saloon Engine NFU(TU5JP4)	GDS10345	Drive Shaft	48T	25	26	58.5	78.5	580			
	2007.03-		MT	R	F	Saloon Engine NFU(TU5JP4)	GDS99017	Drive Shaft	48T	25	22	60	78.7	884.5			
	2007.03-		AT			Saloon Engine NFU(TU5JP4)	GC045035	Outer Joint	48T	25	34	58	79	55.5	I		
	2007.03-		MT			Saloon Engine NFU(TU5JP4)	GC099267	Outer Joint	48T	25	22	60	78.5	54	I		
	2007.03-		MT			Saloon Engine NFU(TU5JP4)	GC099309	Outer Joint		25	22	60	78.5	54	I		
1.9 D	1998.09-	2001.11	MT	L	F		GDS10136	Drive Shaft		21	24	48.5	86	611.5			
	1998.09-	2001.11	MT	L	F		GDS45064	Drive Shaft	48T	21	24	48.5	86	611.5			
	1998.09-	2001.11	MT	R	F		GDS10137	Drive Shaft		21	24	48.5	86	900			
	1998.09-	2001.11	MT	R	F		GDS45065	Drive Shaft	48T	21	24	48.5	86	900			
2.0 16V/2.0 Hdi	1999.06-		MT	L	F		GDS45115	Drive Shaft	48T	25	24	58	78.5	599			
<b>206 (2A/C)</b>																	
1.4 16V (65 kW)	2003.10-	2007.03			F	Hatchback Engine KFU(ET3J4)	GC045065	Outer Joint		21	21	48.5	86	54	I		
	2003.10-	2007.03			F	Hatchback Engine KFU(ET3J4)	GC045067	Outer Joint	48T	21	21	48.5	86	54	I		
	2003.10-	2007.03	MT		F	Hatchback Engine KFU(ET3J4)	GC045011	Outer Joint		21	22	48	86.5	54	I		
	2003.10-	2007.03	MT		F	Hatchback Engine KFU(ET3J4)	GC045033	Outer Joint	48T	21	22	48	86.5	54	I		
	2003.10-	2007.03		L	F	Hatchback Engine KFU(ET3J4)	GDS10043	Drive Shaft		21	22	48	86.5	610			
	2003.10-	2007.03		L	F	Hatchback Engine KFU(ET3J4)	GCI45011	Inner Joint		22	22	40	65.2	87.8			
	2003.10-	2007.03		R	F	Hatchback Engine KFU(ET3J4)	GDS45094	Drive Shaft		21	22	48	86.5	886			
	2003.10-	2007.03	AT	R	F	Hatchback Engine KFU(ET3J4)	GDS45147	Drive Shaft		21	23	48.5	86	807			
	2003.10-	2007.03	AT	R	F	Hatchback Engine KFU(ET3J4)	GCI50098	Inner Joint		23	34	30	209	88			
	2003.10-	2007.03	AT	R	F	Hatchback Engine KFU(ET3J4)	GC045012	Outer Joint		21	34	48.5	86	55.5	I		
	2003.10-	2007.03	AT/Semi-AT	R	F	Hatchback Engine KFU(ET3J4)	GDS10287	Drive Shaft	48T	21	26	48.5	86	809			
	2003.10-						GC045067	Outer Joint	48T	21	21	48.5	86	54	I		





		TRANSM	L/R	F/R		G-AP Ref.	PRODUCT	ABS	Technical Specifications						
									YEAR	A	B	C	H	L	P
<b>PEUGEOT</b>															
<b>206 (2A/C)</b>															
1.4 HDi (51 kW)	2002.09-	2007.02	MT	L	F	Hatchback Engine 8HX(DV4TD)	GDS45031	Drive Shaft		21	22	48	86.5	604.5	
1.4 HDi Eco (50 kW)	2001.09-		MT		F	Hatchback Engine 8HX(DV4TD)/8HZ(DV4TD)	GC045011	Outer Joint		21	22	48	86.5	54	I
	2001.09-		MT		F	Hatchback Engine 8HX(DV4TD)/8HZ(DV4TD)	GC045033	Outer Joint	48T	21	22	48	86.5	54	I
	2001.09-		MT	L	F	Hatchback Engine 8HX(DV4TD)/8HZ(DV4TD)	GDS45032	Drive Shaft	48T	21	22	48	86.5	604.5	
	2001.09-		MT	R	F	Hatchback Engine 8HX(DV4TD)/8HZ(DV4TD)	GDS45035	Drive Shaft	48T	21	22	48	86.5	886	
	2001.09-			L	F	Hatchback Engine 8HX(DV4TD)/8HZ(DV4TD)	GDS45031	Drive Shaft		21	22	48	86.5	604.5	
1.6 16V (80 kW)	2000.12-						GC099008	Outer Joint	48T	25	22	60	78.5	54	I
	2000.12-		AT	L	F	Hatchback Engine NFU(TU5JP4)	GDS10345	Drive Shaft	48T	25	26	58.5	78.5	580	
	2000.12-		MT	R	F	Hatchback Engine NFU(TU5JP4)	GDS99017	Drive Shaft	48T	25	22	60	78.7	884.5	
	2000.12-		AT			Hatchback Engine NFU(TU5JP4)	GC045035	Outer Joint	48T	25	34	58	79	55.5	I
1.6 16V (87 kW)	2000.12-					GC099008	Outer Joint	48T	25	22	60	78.5	54	I	
1.6 HDi (80 kW)	2004.04-	2007.03			F	Hatchback Engine 9HY(DV6TED4)/9HZ(DV6TED4)	GC045049	Outer Joint	48T	25	34	58	79	55.5	I
	2004.04-	2007.03		R	F	Hatchback Engine 9HY(DV6TED4)/9HZ(DV6TED4)	GDS45016	Drive Shaft	48T	25	24	60	78.7	888	
	2004.04-	2007.03				Hatchback Engine 9HY(DV6TED4)/9HZ(DV6TED4)	GC045035	Outer Joint	48T	25	34	58	79	55.5	I
1.9 D (51 kW)	1998.09-	2001.11	MT	L	F	Hatchback Engine WJZ(DW8)	GDS45009	Drive Shaft	48T	21	24	48	86.5	602	
	1998.09-	2001.11	MT	R	F	Hatchback Engine WJZ(DW8)	GDS45010	Drive Shaft	48T	21	24	48	86.5	896	
2.0 RC (130 kW)	2002.10-	2007.03			F	Hatchback Engine RFK(EW10J4S)	GC045049	Outer Joint	48T	25	34	58	79	55.5	I
	2002.10-	2007.03		R	F	Hatchback Engine RFK(EW10J4S)	GDS45016	Drive Shaft	48T	25	24	60	78.7	888	
	2002.10-	2007.03				Hatchback Engine RFK(EW10J4S)	GC045035	Outer Joint	48T	25	34	58	79	55.5	I
<b>206 (2E/K)</b>															
1.1 (44 kW)	2002.07-				F	Estate Engine HFX(TU1JP)	GC045065	Outer Joint		21	21	48.5	86	54	I
	2002.07-				F	Estate Engine HFX(TU1JP)	GC045067	Outer Joint	48T	21	21	48.5	86	54	I
	2002.07-		MT		F	Estate Engine HFX(TU1JP)	GC045011	Outer Joint		21	22	48	86.5	54	I
	2002.07-		MT		F	Estate Engine HFX(TU1JP)	GC045033	Outer Joint	48T	21	22	48	86.5	54	I
	2002.07-			L	F	Estate Engine HFX(TU1JP)	GDS10043	Drive Shaft		21	22	48	86.5	610	
	2002.07-			L	F	Estate Engine HFX(TU1JP)	GDS45027	Drive Shaft	48T	21	22	48	86.5	610	
	2002.07-			R	F	Estate Engine HFX(TU1JP)	GDS45094	Drive Shaft		21	22	48	86.5	886	
	2002.07-			R	F	Estate Engine HFX(TU1JP)	GDS45035	Drive Shaft	48T	21	22	48	86.5	886	
	2002.07-			L	F	Estate Engine HFX(TU1JP)	GCI45011	Inner Joint		22	22	40	65.2	87.8	
1.4 (55 kW)	2002.07-				F	Estate Engine KFV(TU3A)/KFW(TU3JP)	GC045065	Outer Joint		21	21	48.5	86	54	I
	2002.07-				F	Estate Engine KFV(TU3A)/KFW(TU3JP)	GC045067	Outer Joint	48T	21	21	48.5	86	54	I
	2002.07-		AT		F	Estate Engine KFV(TU3A)/KFW(TU3JP)	GC045012	Outer Joint		21	34	48.5	86	55.5	I
	2002.07-		AT		F	Estate Engine KFV(TU3A)/KFW(TU3JP)	GC010056	Outer Joint	48T	21	34	48.5	86	55.5	I
	2002.07-		MT		F	Estate Engine KFV(TU3A)/KFW(TU3JP)	GC045011	Outer Joint		21	22	48	86.5	54	I
	2002.07-		MT		F	Estate Engine KFV(TU3A)/KFW(TU3JP)	GC045033	Outer Joint	48T	21	22	48	86.5	54	I
	2002.07-			L	F	Estate Engine KFV(TU3A)/KFW(TU3JP)	GDS10043	Drive Shaft		21	22	48	86.5	610	
	2002.07-			L	F	Estate Engine KFV(TU3A)/KFW(TU3JP)	GDS45027	Drive Shaft	48T	21	22	48	86.5	610	
	2002.07-			R	F	Estate Engine KFV(TU3A)/KFW(TU3JP)	GDS45094	Drive Shaft		21	22	48	86.5	886	
	2002.07-			R	F	Estate Engine KFV(TU3A)/KFW(TU3JP)	GDS45035	Drive Shaft	48T	21	22	48	86.5	886	
	2002.07-			L	F	Estate Engine KFV(TU3A)/KFW(TU3JP)	GCI45011	Inner Joint		22	22	40	65.2	87.8	
	2002.07-		AT	R	F	Estate Engine KFV(TU3A)/KFW(TU3JP)	GDS45147	Drive Shaft		21	23	48.5	86	807	
	2002.07-		AT	R	F	Estate Engine KFV(TU3A)/KFW(TU3JP)	GCI50098	Inner Joint		23	34	30	209	88	
	2002.07-		AT	R	F	Estate Engine KFV(TU3A)/KFW(TU3JP)	GC045012	Outer Joint		21	34	48.5	86	55.5	I
	2002.07-		AT/Semi-AT	R	F	Estate Engine KFV(TU3A)/KFW(TU3JP)	GDS10287	Drive Shaft	48T	21	26	48.5	86	809	
1.4 16V (65 kW)	2003.10-	2005.03			F	Estate Engine KFU(ET3J4)	GC045065	Outer Joint		21	21	48.5	86	54	I
	2003.10-	2005.03			F	Estate Engine KFU(ET3J4)	GC045067	Outer Joint	48T	21	21	48.5	86	54	I
	2003.10-	2005.03	MT		F	Estate Engine KFU(ET3J4)	GC045011	Outer Joint		21	22	48	86.5	54	I
	2003.10-	2005.03	MT		F	Estate Engine KFU(ET3J4)	GC045033	Outer Joint	48T	21	22	48	86.5	54	I
	2003.10-	2005.03		L	F	Estate Engine KFU(ET3J4)	GDS10043	Drive Shaft		21	22	48	86.5	610	
	2003.10-	2005.03		L	F	Estate Engine KFU(ET3J4)	GCI45011	Inner Joint		22	22	40	65.2	87.8	
	2003.10-	2005.03		R	F	Estate Engine KFU(ET3J4)	GDS45094	Drive Shaft		21	22	48	86.5	886	
	2003.10-	2005.03	AT	R	F	Estate Engine KFU(ET3J4)	GDS45147	Drive Shaft		21	23	48.5	86	807	
	2003.10-	2005.03	AT	R	F	Estate Engine KFU(ET3J4)	GCI50098	Inner Joint		23	34	30	209	88	
	2003.10-	2005.03	AT	R	F	Estate Engine KFU(ET3J4)	GC045012	Outer Joint		21	34	48.5	86	55.5	I
	2003.10-	2005.03	AT/Semi-AT	R	F	Estate Engine KFU(ET3J4)	GDS10287	Drive Shaft	48T	21	26	48.5	86	809	
1.4 HDi (50 kW)	2002.07-		MT		F	Estate Engine 8HX(DV4TD)	GC045011	Outer Joint		21	22	48	86.5	54	I
	2002.07-		MT		F	Estate Engine 8HX(DV4TD)	GC045033	Outer Joint	48T	21	22	48	86.5	54	I
	2002.07-		MT	L	F	Estate Engine 8HX(DV4TD)	GDS45032	Drive Shaft	48T	21	22	48	86.5	604.5	
	2002.07-		MT	R	F	Estate Engine 8HX(DV4TD)	GDS45035	Drive Shaft	48T	21	22	48	86.5	886	
	2002.07-			L	F	Estate Engine 8HX(DV4TD)	GDS45031	Drive Shaft		21	22	48	86.5	604.5	
1.6 16V (80 kW)	2002.07-		MT		F	Estate Engine NFU(TU5JP4)	GC045045	Outer Joint		25	22	60	78.5	54	I









		TRANSM	L/R	F/R		G-AP Ref.	PRODUCT	ABS	Technical Specifications							
									YEAR	A	B	C	H	L	P	
<b>PEUGEOT</b>																
<b>206 (2E/K)</b>																
1.6 16V (80 kW)	2002.07-		MT		F	Estate Engine NFU(TU5JP4)	GCO99008	Outer Joint	48T	25	22	60	78.5	54	I	
	2002.07-		MT	L	F	Estate Engine NFU(TU5JP4)	GDS45012	Drive Shaft	48T	25	22	60	78.5	60I		
	2002.07-		MT	L	F	Estate Engine NFU(TU5JP4)	GDS45138	Drive Shaft		25	22	60	78.5	60I		
	2002.07-		MT	R	F	Estate Engine NFU(TU5JP4)	GDS45011	Drive Shaft	48T	25	22	60	78.5	880		
	2002.07-		MT	R	F	Estate Engine NFU(TU5JP4)	GDS45137	Drive Shaft		25	22	60	78.5	880		
	2002.07-		AT	L	F	Estate Engine NFU(TU5JP4)	GDS10345	Drive Shaft	48T	25	26	58.5	78.5	580		
	2002.07-		MT	R	F	Estate Engine NFU(TU5JP4)	GDS99017	Drive Shaft	48T	25	22	60	78.7	884.5		
	2002.07-		AT			Estate Engine NFU(TU5JP4)	GCO45035	Outer Joint	48T	25	34	58	79	55.5	I	
	2002.07-		MT			Estate Engine NFU(TU5JP4)	GCO99267	Outer Joint	48T	25	22	60	78.5	54	I	
1.6 HDi (80 kW)	2002.07-		MT			Estate Engine NFU(TU5JP4)	GCO99309	Outer Joint		25	22	60	78.5	54	I	
	2005.10-2007.03				F	Estate Engine 9HZ(DV6TED4)	GCO45049	Outer Joint	48T	25	34	58	79	55.5	I	
2.0 16V (100 kW)	2005.10-2007.03			R	F	Estate Engine 9HZ(DV6TED4)	GDS45016	Drive Shaft	48T	25	24	60	78.7	888		
	2005.10-2007.03					Estate Engine 9HZ(DV6TED4)	GCO45035	Outer Joint	48T	25	34	58	79	55.5	I	
	2002.07-				F	Estate Engine RFN(EW10J4)	GCO45027	Outer Joint		25	34	58	79	55.5	I	
2.0 HDi (66 kW)	2002.07-				F	Estate Engine RFN(EW10J4)	GCO45049	Outer Joint	48T	25	34	58	79	55.5	I	
	2002.07-		MT	L	F	Estate Engine RFN(EW10J4)	GDS45101	Drive Shaft	48T	25	24	58	79	592		
	2002.07-		MT	R	F	Estate Engine RFN(EW10J4)	GDS45016	Drive Shaft	48T	25	24	60	78.7	888		
	2002.07-					Estate Engine RFN(EW10J4)	GCO45035	Outer Joint	48T	25	34	58	79	55.5	I	
	2002.07-				F	Estate Engine RHY(DW10TD)	GCO45027	Outer Joint		25	34	58	79	55.5	I	
	2002.07-				F	Estate Engine RHY(DW10TD)	GCO45049	Outer Joint	48T	25	34	58	79	55.5	I	
206 CC (2D)	2002.07-		MT	L	F	Estate Engine RHY(DW10TD)	GDS45101	Drive Shaft	48T	25	24	58	79	592		
	2002.07-		MT	R	F	Estate Engine RHY(DW10TD)	GDS45016	Drive Shaft	48T	25	24	60	78.7	888		
	2002.07-		MT	L	F	Estate Engine RHY(DW10TD)	GDS99028	Drive Shaft		25	24	54.8	78.5	598.5		
	2002.07-		MT	L	F	Estate Engine RHY(DW10TD)	GCI10093	Inner Joint		24	22	40	62	90		
	2002.07-					Estate Engine RHY(DW10TD)	GCO45035	Outer Joint	48T	25	34	58	79	55.5	I	
	2002.07-					Estate Engine RHY(DW10TD)	GCO45035	Outer Joint	48T	25	34	58	79	55.5	I	
<b>1.6 16V (80 kW)</b>																
1.6 HDi (80 kW)	2000.09-		AT	L	F	Convertible Engine NFU(TU5JP4)	GDS10345	Drive Shaft	48T	25	26	58.5	78.5	580		
	2000.09-		MT	R	F	Convertible Engine NFU(TU5JP4)	GDS99017	Drive Shaft	48T	25	22	60	78.7	884.5		
	2000.09-		AT			Convertible Engine NFU(TU5JP4)	GCO45035	Outer Joint	48T	25	34	58	79	55.5	I	
2.0 S16 (100 kW)	2005.04-				F	Convertible Engine 9HZ(DV6TED4)	GCO45049	Outer Joint	48T	25	34	58	79	55.5	I	
	2005.04-			R	F	Convertible Engine 9HZ(DV6TED4)	GDS45016	Drive Shaft	48T	25	24	60	78.7	888		
	2005.04-					Convertible Engine 9HZ(DV6TED4)	GCO45035	Outer Joint	48T	25	34	58	79	55.5	I	
<b>206 VAN</b>																
1.4 HDi (50 kW)	2001.09-2009.03			L	F	Box Engine 8HX(DV4TD)/8HZ(DV4TD)	GDS45031	Drive Shaft		21	22	48	86.5	604.5		
<b>206-TRE VOLUMI</b>																
1.6 16V (80 kW)	2007.03-						GCO99008	Outer Joint	48T	25	22	60	78.5	54	I	
<b>207</b>																
1.6 HDi	2006.05-		MT		F		GCO45047	Outer Joint	48T	25	34	59	78.5	54	I	
1.6 T	2006.05-		MT		F		GCO45047	Outer Joint	48T	25	34	59	78.5	54	I	
<b>207 (WA, WC)</b>																
1.4 (53 kW)	2006.05-2007.09				F	Hatchback Engine KFV(TU3A)	GCO45057	Outer Joint		21	22	48	86.5	54	I	
	2006.05-2007.09			L	F	Hatchback Engine KFV(TU3A)	GDS99272	Drive Shaft		21	22	48	86.5	655		
	2006.05-2007.09			R	F	Hatchback Engine KFV(TU3A)	GDS99271	Drive Shaft		21	22	48	86.5	858		
	2006.05-2007.09					Hatchback Engine KFV(TU3A)	GCO45068	Outer Joint		21	22	48	86.5	54	M	
1.4 (54 kW)	2007.12-		MT			Hatchback Engine KFV(TU3A)	GCO45068	Outer Joint		21	22	48	86.5	54	M	
1.4 (55 kW)	2008.08-					Hatchback Engine KFV(TU3A)/KFW(TU3A)	GCO45068	Outer Joint		21	22	48	86.5	54	M	
1.4 16V (65 kW)	2006.05-2007.02			R	F	Hatchback Engine KFU(ET3J4)	GDS99271	Drive Shaft		21	22	48	86.5	858		
	2006.05-2007.02					Hatchback Engine KFU(ET3J4)	GCO45068	Outer Joint		21	22	48	86.5	54	M	
	2006.05-2007.02				F	Hatchback Engine KFU(ET3J4)	GCO45057	Outer Joint		21	22	48	86.5	54	I	
	2006.05-2007.02			L	F	Hatchback Engine KFU(ET3J4)	GDS99272	Drive Shaft		21	22	48	86.5	655		
1.4 16V (70 kW)	2007.06-			L	F	Hatchback Engine 8FS(EP3)/EP3/EP3C	GDS10311	Drive Shaft		21	22	48	86.5	647		
	2007.06-			R	F	Hatchback Engine 8FS(EP3)/EP3/EP3C	GDS99271	Drive Shaft		21	22	48	86.5	858		
	2007.06-		MT			Hatchback Engine 8FS(EP3)/EP3/EP3C	GCO45068	Outer Joint		21	22	48	86.5	54	M	
1.4 16V (72 kW)	2009.10-			L	F	Hatchback	GDS45200	Drive Shaft		25	22	58.5	78.5	640		
	2009.10-			L	F	Hatchback	GDS10311	Drive Shaft		21	22	48	86.5	647		
	2009.10-			R	F	Hatchback	GDS99271	Drive Shaft		21	22	48	86.5	858		
	2009.10-			R	F	Hatchback	GDS45201	Drive Shaft		25	22	58.5	79	854		
	2009.10-		MT			Hatchback	GCO45068	Outer Joint		21	22	48	86.5	54	M	
1.4 HDi (50 kW)	2006.05-2007.09				F	Hatchback Engine 8HR(DV4C)/8HZ(DV4TD)	GCO10025	Outer Joint		25	22	60	80	54	I	
	2006.05-2007.09			L	F	Hatchback Engine 8HR(DV4C)/8HZ(DV4TD)	GDS45200	Drive Shaft		25	22	58.5	78.5	640		

		TRANSM	L/R	F/R		G-AP Ref.	PRODUCT	ABS	Technical Specifications						
									YEAR	A	B	C	H	L	P
<b>PEUGEOT</b>															
<b>207 (WA_, WC_)</b>															
1.4 HDi (50 kW)	2006.05-	2007.09		L	F	Hatchback Engine 8HR(DV4C)/8HZ(DV4TD)	GDS10311	Drive Shaft		21	22	48	86.5	647	
	2006.05-	2007.09	MT	L	F	Hatchback Engine 8HR(DV4C)/8HZ(DV4TD)	GDS10292	Drive Shaft		25	22	58.5	79	645	
	2006.05-	2007.09		R	F	Hatchback Engine 8HR(DV4C)/8HZ(DV4TD)	GDS99271	Drive Shaft		21	22	48	86.5	858	
	2006.05-	2007.09		R	F	Hatchback Engine 8HR(DV4C)/8HZ(DV4TD)	GDS45201	Drive Shaft		25	22	58.5	79	854	
	2006.05-	2007.09	MT	R	F	Hatchback Engine 8HR(DV4C)/8HZ(DV4TD)	GDS10294	Drive Shaft		25	22	60	78.7	855	
	2006.05-	2007.09	MT			Hatchback Engine 8HR(DV4C)/8HZ(DV4TD)	GC045068	Outer Joint		21	22	48	86.5	54	M
1.6 (81 kW)	2008.08-		MT	L	F	Hatchback Engine N6A (TU5JP4)	GDS10292	Drive Shaft		25	22	58.5	79	645	
	2008.08-		MT	R	F	Hatchback Engine N6A (TU5JP4)	GDS10294	Drive Shaft		25	22	60	78.7	855	
1.6 16V (80 kW)	2006.05-				F	Hatchback Engine NFU(TU5JP4)	GC010025	Outer Joint		25	22	60	80	54	I
	2006.05-			L	F	Hatchback Engine NFU(TU5JP4)	GDS45194	Drive Shaft		25	26	58.5	79	621	
	2006.05-			L	F	Hatchback Engine NFU(TU5JP4)	GDS45203	Drive Shaft		25	22	58.5	79	645	
	2006.05-			R	F	Hatchback Engine NFU(TU5JP4)	GDS45193	Drive Shaft		25	26	58.5	79	759	
	2006.05-			R	F	Hatchback Engine NFU(TU5JP4)	GDS45204	Drive Shaft		25	22	58.5	79	846	
	2006.05-		MT	L	F	Hatchback Engine NFU(TU5JP4)	GDS10292	Drive Shaft		25	22	58.5	79	645	
1.6 16V RC (128 kW)	2006.05-		MT	R	F	Hatchback Engine NFU(TU5JP4)	GDS10294	Drive Shaft		25	22	60	78.7	855	
	2007.06-				F	Hatchback Engine 5FY(EP6DTS)	GC010067	Outer Joint	48W	25	34	58.5	79	55	I
1.6 16V Turbo (110 kW)	2007.06-			L	F	Hatchback Engine 5FY(EP6DTS)	GDS10250	Drive Shaft		25	24	58.5	79	634	
	2006.05-				F	Hatchback Engine 5FX(EP6DT)	GC010067	Outer Joint	48W	25	34	58.5	79	55	I
	2006.05-		MT	L	F	Hatchback Engine 5FX(EP6DT)	GDS10250	Drive Shaft		25	24	58.5	79	634	
1.6 16V Turbo (115 kW)	2006.05-		MT	R	F	Hatchback Engine 5FX(EP6DT)	GDS10249	Drive Shaft		25	24	58.5	79	864	
	2009.10-			L	F	Hatchback Engine 5FR(EP6DT)	GDS10250	Drive Shaft		25	24	58.5	79	634	
	2009.10-		MT	R	F	Hatchback Engine 5FR(EP6DT)	GDS10249	Drive Shaft		25	24	58.5	79	864	
1.6 16V VTi (88 kW)	2009.10-		6MT			Hatchback Engine 5FR(EP6DT)	GC099366	Outer Joint		25	34	58.5	79	55	I
	2007.01-	2007.09			F	Hatchback Engine 5FS(EP6C)/EP6	GC010025	Outer Joint		25	22	60	80	54	I
	2007.01-	2007.09		L	F	Hatchback Engine 5FS(EP6C)/EP6	GDS45200	Drive Shaft		25	22	58.5	78.5	640	
	2007.01-	2007.09	MT	L	F	Hatchback Engine 5FS(EP6C)/EP6	GDS10292	Drive Shaft		25	22	58.5	79	645	
1.6 HDi (66 kW)	2007.01-	2007.09		L	F	Hatchback Engine 5FS(EP6C)/EP6	GDS45202	Drive Shaft		25	26	58.5	78.5	620	
	2007.01-	2007.09		R	F	Hatchback Engine 5FS(EP6C)/EP6	GDS45201	Drive Shaft		25	22	58.5	79	854	
	2007.01-	2007.09		R	F	Hatchback Engine 5FS(EP6C)/EP6	GDS10267	Drive Shaft		25	26	58.5	79.5	766	
	2007.01-	2007.09	MT	R	F	Hatchback Engine 5FS(EP6C)/EP6	GDS10294	Drive Shaft		25	22	60	78.7	855	
	2006.05-				F	Hatchback Engine 9HX(DV6ATED4)/9HV(DV6ATED4)/9HV(DV6TED4)	GC010067	Outer Joint	48W	25	34	58.5	79	55	I
	2006.05-			L	F	Hatchback Engine 9HX(DV6ATED4)/9HV(DV6ATED4)/9HV(DV6TED4)	GDS10248	Drive Shaft		25	24	58.5	79	642	
1.6 HDi (68 kW)	2006.05-		MT	R	F	Hatchback Engine 9HX(DV6ATED4)/9HV(DV6ATED4)/9HV(DV6TED4)	GDS10249	Drive Shaft		25	24	58.5	79	864	
	2009.11-				F	Hatchback Engine 9HP(DV6DTEDE)	GC010067	Outer Joint	48W	25	34	58.5	79	55	I
	2009.11-		MT	R	F	Hatchback Engine 9HP(DV6DTEDE)	GDS10249	Drive Shaft		25	24	58.5	79	864	
1.6 HDi (80 kW)	2006.05-	2007.09			F	Hatchback Engine 9HY(DV6TED4)/9HZ(DV6TED4)	GC010067	Outer Joint	48W	25	34	58.5	79	55	I
	2006.05-	2007.09		L	F	Hatchback Engine 9HY(DV6TED4)/9HZ(DV6TED4)	GDS10142	Drive Shaft		25	24	58.5	89	648	
	2006.05-	2007.09		L	F	Hatchback Engine 9HY(DV6TED4)/9HZ(DV6TED4)	GDS10250	Drive Shaft		25	24	58.5	79	634	
	2006.05-	2007.09		R	F	Hatchback Engine 9HY(DV6TED4)/9HZ(DV6TED4)	GDS10143	Drive Shaft		25	24	58.5	89	936	
	2006.05-	2007.09	MT	R	F	Hatchback Engine 9HY(DV6TED4)/9HZ(DV6TED4)	GDS10249	Drive Shaft		25	24	58.5	79	864	
1.6 HDi (82 kW)	2009.08-			L	F	Hatchback Engine 9HR(DV6C)	GDS10253	Drive Shaft		25	24	58.5	79	626	
	2009.08-			L	F	Hatchback Engine 9HR(DV6C)	GCI10057	Inner Joint		24	34	40	52.5	90	
	2009.08-			L	F	Hatchback Engine 9HR(DV6C)	GC010148	Outer Joint		25	34	58.5	79	55.5	I
	2009.08-		MT	R	F	Hatchback Engine 9HR(DV6C)	GDS10249	Drive Shaft		25	24	58.5	79	864	
	2009.08-		6MT			Hatchback Engine 9HR(DV6C)	GC099366	Outer Joint		25	34	58.5	79	55	I
<b>207 (WK_)</b>															
1.4 (54 kW)	2007.06-				F	Estate Engine KFV(TU3A)	GC045057	Outer Joint		21	22	48	86.5	54	I
	2007.06-			L	F	Estate Engine KFV(TU3A)	GDS99272	Drive Shaft		21	22	48	86.5	655	
	2007.06-			R	F	Estate Engine KFV(TU3A)	GDS99271	Drive Shaft		21	22	48	86.5	858	
	2007.06-					Estate Engine KFV(TU3A)	GC045068	Outer Joint		21	22	48	86.5	54	M
1.4 16V (70 kW)	2007.07-			L	F	Estate Engine 8FS(EP3)/EP3/EP3C	GDS10311	Drive Shaft		21	22	48	86.5	647	
	2007.07-			R	F	Estate Engine 8FS(EP3)/EP3/EP3C	GDS99271	Drive Shaft		21	22	48	86.5	858	
	2007.07-		MT			Estate Engine 8FS(EP3)/EP3/EP3C	GC045068	Outer Joint		21	22	48	86.5	54	M
1.4 16V (72 kW)	2009.11-		MT		F	Estate	GC045068	Outer Joint		21	22	48	86.5	54	M
1.6 16V (88 kW)	2008.01-				F	Estate Engine EP6/5FS(EP6C)	GC010025	Outer Joint		25	22	60	80	54	I
	2008.01-		MT	L	F	Estate Engine EP6/5FS(EP6C)	GDS45200	Drive Shaft		25	22	58.5	78.5	640	
	2008.01-		AT	R	F	Estate Engine EP6/5FS(EP6C)	GDS10267	Drive Shaft		25	26	58.5	79.5	766	
	2008.01-		MT	R	F	Estate Engine EP6/5FS(EP6C)	GDS45201	Drive Shaft		25	22	58.5	79	854	
	2008.01-		AT	L	F	Estate Engine EP6/5FS(EP6C)	GDS45202	Drive Shaft		25	26	58.5	78.5	620	
	2008.01-		MT	L	F	Estate Engine EP6/5FS(EP6C)	GDS10292	Drive Shaft		25	22	58.5	79	645	
	2008.01-		MT	R	F	Estate Engine EP6/5FS(EP6C)	GDS10294	Drive Shaft		25	22	60	78.7	855	



		TRANSM	L/R	F/R		G-AP Ref.	PRODUCT	ABS	Technical Specifications								
									YEAR	A	B	C	H	L	P		
<b>PEUGEOT</b>																	
<b>207 (WK_)</b>																	
1.6 16V RC (128 kW)	2007.02-			F	Estate Engine 5FY(EP6DTS)	GC010067	Outer Joint	48W	25	34	58.5	79	55	I			
	2007.02-		L	F	Estate Engine 5FY(EP6DTS)	GDS10250	Drive Shaft		25	24	58.5	79	634				
1.6 HDi (66 kW)	2007.07-			F	Estate Engine 9HX(DV6ATED4)	GC010067	Outer Joint	48W	25	34	58.5	79	55	I			
	2007.07-		L	F	Estate Engine 9HX(DV6ATED4)	GDS10248	Drive Shaft		25	24	58.5	79	642				
	2007.07-		MT	R	F	Estate Engine 9HX(DV6ATED4)	GDS10249	Drive Shaft		25	24	58.5	79	864			
1.6 HDi (68 kW)	2009.11-			F	Estate Engine 9HP(DV6DTEDE)	GC010067	Outer Joint	48W	25	34	58.5	79	55	I			
	2009.11-		MT	R	F	Estate Engine 9HP(DV6DTEDE)	GDS10249	Drive Shaft		25	24	58.5	79	864			
1.6 HDi (80 kW)	2008.01-			F	Estate Engine 9HZ(DV6TED4)	GC010067	Outer Joint	48W	25	34	58.5	79	55	I			
	2008.01-		MT	R	F	Estate Engine 9HZ(DV6TED4)	GDS10249	Drive Shaft		25	24	58.5	79	864			
1.6 HDi (82 kW)	2009.08-		L	F	Estate Engine 9HR(DV6C)	GDS10253	Drive Shaft		25	24	58.5	79	626				
	2009.08-		L	F	Estate Engine 9HR(DV6C)	GCI10057	Inner Joint		24	34	40	52.5	90				
	2009.08-		L	F	Estate Engine 9HR(DV6C)	GC010148	Outer Joint		25	34	58.5	79	55.5	I			
	2009.08-		MT	R	F	Estate Engine 9HR(DV6C)	GDS10249	Drive Shaft		25	24	58.5	79	864			
	2009.08-		6MT			Estate Engine 9HR(DV6C)	GC099366	Outer Joint		25	34	58.5	79	55	I		
<b>207 CC (WD_)</b>																	
1.6 16V (88 kW)	2007.02-			F	Convertible Engine EP6/5FS(EP6C)	GC010025	Outer Joint		25	22	60	80	54	I			
	2007.02-		L	F	Convertible Engine EP6/5FS(EP6C)	GDS45200	Drive Shaft		25	22	58.5	78.5	640				
	2007.02-		R	F	Convertible Engine EP6/5FS(EP6C)	GDS45201	Drive Shaft		25	22	58.5	79	854				
	2007.02-		R	F	Convertible Engine EP6/5FS(EP6C)	GDS10267	Drive Shaft		25	26	58.5	79.5	766				
	2007.02-		MT	L	F	Convertible Engine EP6/5FS(EP6C)	GDS10292	Drive Shaft		25	22	58.5	79	645			
	2007.02-		L	F	Convertible Engine EP6/5FS(EP6C)	GDS10253	Drive Shaft		25	24	58.5	79	626				
	2007.02-		L	F	Convertible Engine EP6/5FS(EP6C)	GCI10057	Inner Joint		24	34	40	52.5	90				
	2007.02-		L	F	Convertible Engine EP6/5FS(EP6C)	GC010148	Outer Joint		25	34	58.5	79	55.5	I			
	2007.02-		MT	R	F	Convertible Engine EP6/5FS(EP6C)	GDS10294	Drive Shaft		25	22	60	78.7	855			
1.6 16V Turbo (110 kW)	2007.02-			F	Convertible Engine 5FX(EP6DT)	GC010067	Outer Joint	48W	25	34	58.5	79	55	I			
	2007.02-		L	F	Convertible Engine 5FX(EP6DT)	GDS10250	Drive Shaft		25	24	58.5	79	634				
	2007.02-		MT	R	F	Convertible Engine 5FX(EP6DT)	GDS10249	Drive Shaft		25	24	58.5	79	864			
1.6 16V Turbo (115 kW)	2009.10-		L	F	Convertible Engine 5FR(EP6DT)	GDS10250	Drive Shaft		25	24	58.5	79	634				
	2009.10-		MT	R	F	Convertible Engine 5FR(EP6DT)	GDS10249	Drive Shaft		25	24	58.5	79	864			
	2009.10-		6MT			Convertible Engine 5FR(EP6DT)	GC099366	Outer Joint		25	34	58.5	79	55	I		
1.6 HDi (80 kW)	2007.02-			F	Convertible Engine 9HZ(DV6TED4)	GC010067	Outer Joint	48W	25	34	58.5	79	55	I			
	2007.02-		MT	R	F	Convertible Engine 9HZ(DV6TED4)	GDS10249	Drive Shaft		25	24	58.5	79	864			
1.6 HDi (82 kW)	2009.08-		L	F	Convertible Engine 9HR(DV6C)	GDS10253	Drive Shaft		25	24	58.5	79	626				
	2009.08-		L	F	Convertible Engine 9HR(DV6C)	GCI10057	Inner Joint		24	34	40	52.5	90				
	2009.08-		L	F	Convertible Engine 9HR(DV6C)	GC010148	Outer Joint		25	34	58.5	79	55.5	I			
	2009.08-		MT	R	F	Convertible Engine 9HR(DV6C)	GDS10249	Drive Shaft		25	24	58.5	79	864			
	2009.08-		6MT			Convertible Engine 9HR(DV6C)	GC099366	Outer Joint		25	34	58.5	79	55	I		
<b>207 VAN</b>																	
1.4 HDi (50 kW)	2007.04-		L	F	Box Engine 8HZ(DV4TD)	GDS45200	Drive Shaft		25	22	58.5	78.5	640				
	2007.04-		L	F	Box Engine 8HZ(DV4TD)	GDS10311	Drive Shaft		21	22	48	86.5	647				
	2007.04-		R	F	Box Engine 8HZ(DV4TD)	GDS99271	Drive Shaft		21	22	48	86.5	858				
	2007.04-		R	F	Box Engine 8HZ(DV4TD)	GDS45201	Drive Shaft		25	22	58.5	79	854				
	2007.04-		MT	L	F	Box Engine 8HZ(DV4TD)	GDS10292	Drive Shaft		25	22	58.5	79	645			
	2007.04-		MT	R	F	Box Engine 8HZ(DV4TD)	GDS10294	Drive Shaft		25	22	60	78.7	855			
	2007.04-		MT			Box Engine 8HZ(DV4TD)	GC045068	Outer Joint		21	22	48	86.5	54	M		
1.6 HDi (66 kW)	2007.04-		L	F	Box Engine 9HX(DV6ATED4)	GDS10248	Drive Shaft		25	24	58.5	79	642				
	2007.04-		MT	R	F	Box Engine 9HX(DV6ATED4)	GDS10249	Drive Shaft		25	24	58.5	79	864			
<b>208</b>																	
1.0 (50 kW)	2012.03-		L	F	Hatchback	GDS10306	Drive Shaft		21	22	49	86	652				
1.2 (60 kW)	2012.03-		L	F	Hatchback	GDS10306	Drive Shaft		21	22	49	86	652				
1.4 HDi (50 kW)	2012.03-		L	F	Hatchback Engine 8HP(DV4C)/8HR(DV4C)	GDS10306	Drive Shaft		21	22	49	86	652				
1.6 (115 kW)	2012.03-		L	F	Hatchback Engine 5FV(EP6DT)/EP6CDT	GDS10253	Drive Shaft		25	24	58.5	79	626				
	2012.03-		L	F	Hatchback Engine 5FV(EP6DT)/EP6CDT	GCI10057	Inner Joint		24	34	40	52.5	90				
	2012.03-		L	F	Hatchback Engine 5FV(EP6DT)/EP6CDT	GC010148	Outer Joint		25	34	58.5	79	55.5	I			
	2012.03-				Hatchback Engine 5FV(EP6DT)/EP6CDT	GC099366	Outer Joint		25	34	58.5	79	55	I			
1.6 (88 kW)	2012.03-		L	F	Hatchback Engine 5FS(EP6C)	GDS10306	Drive Shaft		21	22	49	86	652				
1.6 GTi (147 kW)	2012.08-		L	F	Hatchback Engine 5FU(EP6CDTX)	GDS10253	Drive Shaft		25	24	58.5	79	626				
	2012.08-		L	F	Hatchback Engine 5FU(EP6CDTX)	GCI10057	Inner Joint		24	34	40	52.5	90				
	2012.08-		L	F	Hatchback Engine 5FU(EP6CDTX)	GC010148	Outer Joint		25	34	58.5	79	55.5	I			
1.6 HDi (68 kW)	2012.03-		6MT		Hatchback Engine 9HP(DV6DTEDE)	GC099366	Outer Joint		25	34	58.5	79	55	I			
1.6 HDi (84 kW)	2012.03-		L	F	Hatchback	GDS10250	Drive Shaft		25	24	58.5	79	634				





		TRANSM	L/R	F/R		G-AP Ref.	PRODUCT	ABS	Technical Specifications							
									A	B	C	H	L	P		
YEAR																
<b>PEUGEOT</b>																
<b>208</b>																
1.6 HDi (84 kW)	2012.03-				Hatchback	GC099366	Outer Joint		25	34	58.5	79	55	I		
<b>3008</b>																
1.6 HDi (80 kW)	2009.06-	6AT	L	F	MPV Engine 9HZ(DV6TED4)	GDS10380	Drive Shaft		25	37	58.5	89	635			
	2009.06-	6MT	L	F	MPV Engine 9HZ(DV6TED4)	GDS10253	Drive Shaft		25	24	58.5	79	626			
	2009.06-	6MT	L	F	MPV Engine 9HZ(DV6TED4)	GCI10057	Inner Joint		24	34	40	52.5	90			
	2009.06-	MT	L	F	MPV Engine 9HZ(DV6TED4)	GDS10210	Drive Shaft		25	37	58.5	89	638			
	2009.06-	6MT	L/R	F	MPV Engine 9HZ(DV6TED4)	GC010148	Outer Joint		25	34	58.5	79	55.5	I		
	2009.06-	6AT	R	F	MPV Engine 9HZ(DV6TED4)	GDS10363	Drive Shaft		25	37	58.5	89	935			
	2009.06-	6AT	R	F	MPV Engine 9HZ(DV6TED4)	GCI10091	Inner Joint		37	26	31.5	366	100			
	2009.06-	6AT	R	F	MPV Engine 9HZ(DV6TED4)	GC010158	Outer Joint		25	26	58.5	89	61.5	M		
	2009.06-	6MT	R	F	MPV Engine 9HZ(DV6TED4)	GDS10325	Drive Shaft		25	24	58.5	79	940			
	2009.06-	6MT	R	F	MPV Engine 9HZ(DV6TED4)	GCI10058	Inner Joint		24	34	29.8	365	88			
	2009.06-	MT	R	F	MPV Engine 9HZ(DV6TED4)	GDS10361	Drive Shaft		25	37	58.5	89	959			
	2009.06-			R	F	MPV Engine 9HZ(DV6TED4)	GDS10421	Drive Shaft		25	37	58.5	89	972		
	2009.06-					MPV Engine 9HZ(DV6TED4)	GC099366	Outer Joint		25	34	58.5	79	55	I	
1.6 HDi (82 kW)	2010.08-	6AT	L	F	MPV Engine 9HR(DV6C)	GDS10380	Drive Shaft		25	37	58.5	89	635			
	2010.08-	6MT	L	F	MPV Engine 9HR(DV6C)	GDS10253	Drive Shaft		25	24	58.5	79	626			
	2010.08-	6MT	L	F	MPV Engine 9HR(DV6C)	GDS10427	Drive Shaft		25	37	58.5	89	638			
	2010.08-	6MT	L	F	MPV Engine 9HR(DV6C)	GCI10057	Inner Joint		24	34	40	52.5	90			
	2010.08-	MT	L	F	MPV Engine 9HR(DV6C)	GDS10210	Drive Shaft		25	37	58.5	89	638			
	2010.08-	6MT	L/R	F	MPV Engine 9HR(DV6C)	GC010148	Outer Joint		25	34	58.5	79	55.5	I		
	2010.08-	6AT	R	F	MPV Engine 9HR(DV6C)	GDS10363	Drive Shaft		25	37	58.5	89	935			
	2010.08-	6AT	R	F	MPV Engine 9HR(DV6C)	GCI10091	Inner Joint		37	26	31.5	366	100			
	2010.08-	6AT	R	F	MPV Engine 9HR(DV6C)	GC010158	Outer Joint		25	26	58.5	89	61.5	M		
	2010.08-	6MT	R	F	MPV Engine 9HR(DV6C)	GDS10325	Drive Shaft		25	24	58.5	79	940			
	2010.08-	6MT	R	F	MPV Engine 9HR(DV6C)	GDS10421	Drive Shaft		25	37	58.5	89	972			
	2010.08-	6MT	R	F	MPV Engine 9HR(DV6C)	GCI10058	Inner Joint		24	34	29.8	365	88			
	2010.08-			R	F	MPV Engine 9HR(DV6C)	GDS10361	Drive Shaft		25	37	58.5	89	959		
2010.08-					MPV Engine 9HR(DV6C)	GC099366	Outer Joint		25	34	58.5	79	55	I		
1.6 HDi (84 kW)	2013.03-	MT	L	F	MPV Engine 9HD(DV6CTED)	GDS10253	Drive Shaft		25	24	58.5	79	626			
	2013.03-	MT	L	F	MPV Engine 9HD(DV6CTED)	GCI10057	Inner Joint		24	34	40	52.5	90			
	2013.03-		L	F	MPV Engine 9HD(DV6CTED)	GDS10250	Drive Shaft		25	24	58.5	79	634			
	2013.03-	MT	L/R	F	MPV Engine 9HD(DV6CTED)	GC010148	Outer Joint		25	34	58.5	79	55.5	I		
	2013.03-	MT	R	F	MPV Engine 9HD(DV6CTED)	GDS10325	Drive Shaft		25	24	58.5	79	940			
	2013.03-	MT	R	F	MPV Engine 9HD(DV6CTED)	GDS10361	Drive Shaft		25	37	58.5	89	959			
	2013.03-	MT	R	F	MPV Engine 9HD(DV6CTED)	GCI10058	Inner Joint		24	34	29.8	365	88			
1.6 THP (110 kW)	2009.06-	6MT	L	F	MPV Engine 5FX(EP6DT)	GDS10427	Drive Shaft		25	37	58.5	89	638			
	2009.06-	MT	L	F	MPV Engine 5FX(EP6DT)	GDS10210	Drive Shaft		25	37	58.5	89	638			
	2009.06-		L	F	MPV Engine 5FX(EP6DT)	GDS10253	Drive Shaft		25	24	58.5	79	626			
	2009.06-		L	F	MPV Engine 5FX(EP6DT)	GCI10057	Inner Joint		24	34	40	52.5	90			
	2009.06-		L	F	MPV Engine 5FX(EP6DT)	GC010148	Outer Joint		25	34	58.5	79	55.5	I		
	2009.06-	6MT	R	F	MPV Engine 5FX(EP6DT)	GDS10421	Drive Shaft		25	37	58.5	89	972			
	2009.06-	MT	R	F	MPV Engine 5FX(EP6DT)	GDS10361	Drive Shaft		25	37	58.5	89	959			
	2009.06-	MT	R	F	MPV Engine 5FX(EP6DT)	GCI10058	Inner Joint		24	34	29.8	365	88			
	2009.06-	MT	R	F	MPV Engine 5FX(EP6DT)	GC010148	Outer Joint		25	34	58.5	79	55.5	I		
	2009.06-	6MT			MPV Engine 5FX(EP6DT)	GC099366	Outer Joint		25	34	58.5	79	55	I		
1.6 THP (115 kW)	2009.06-	6MT	L	F	MPV Engine 5FV(EP6DT)	GDS10427	Drive Shaft		25	37	58.5	89	638			
	2009.06-	MT	L	F	MPV Engine 5FV(EP6DT)	GDS10210	Drive Shaft		25	37	58.5	89	638			
	2009.06-		L	F	MPV Engine 5FV(EP6DT)	GDS10253	Drive Shaft		25	24	58.5	79	626			
	2009.06-		L	F	MPV Engine 5FV(EP6DT)	GCI10057	Inner Joint		24	34	40	52.5	90			
	2009.06-		L	F	MPV Engine 5FV(EP6DT)	GC010148	Outer Joint		25	34	58.5	79	55.5	I		
	2009.06-	6MT	R	F	MPV Engine 5FV(EP6DT)	GDS10421	Drive Shaft		25	37	58.5	89	972			
	2009.06-	MT	R	F	MPV Engine 5FV(EP6DT)	GDS10361	Drive Shaft		25	37	58.5	89	959			
	2009.06-	MT	R	F	MPV Engine 5FV(EP6DT)	GCI10058	Inner Joint		24	34	29.8	365	88			
	2009.06-	MT	R	F	MPV Engine 5FV(EP6DT)	GC010148	Outer Joint		25	34	58.5	79	55.5	I		
	2009.06-	6MT			MPV Engine 5FV(EP6DT)	GC099366	Outer Joint		25	34	58.5	79	55	I		
1.6 VTi (88 kW)	2009.06-			F	MPV Engine 5FS(EP6C)/EP6	GC010067	Outer Joint	48W	25	34	58.5	79	55	I		
	2009.06-	MT	R	F	MPV Engine 5FS(EP6C)/EP6	GDS10251	Drive Shaft		25	24	58.5	79	935			
	2009.06-	6MT			MPV Engine 5FS(EP6C)/EP6	GC099366	Outer Joint		25	34	58.5	79	55	I		
2.0 HDi (100 kW)	2011.09-	MT	L	F	MPV	GDS10427	Drive Shaft		25	37	58.5	89	638			
	2011.09-	MT	R	F	MPV	GDS10361	Drive Shaft		25	37	58.5	89	959			



		YEAR	TRANSM	L/R	F/R		G-AP Ref.	PRODUCT	ABS	Technical Specifications											
										A	B	C	H	L	P						
<b>PEUGEOT</b>																					
<b>3008</b>																					
2.0 HDi (110 kW)	2009.06-		6AT	L	F	MPV Engine RHE(DW10CTED4)/AHX(DW10FD)	GDS10380	Drive Shaft		25	37	58.5	89	635							
	2009.06-		6MT	L	F	MPV Engine RHE(DW10CTED4)/AHX(DW10FD)	GDS10427	Drive Shaft		25	37	58.5	89	638							
	2009.06-		MT	L	F	MPV Engine RHE(DW10CTED4)/AHX(DW10FD)	GDS10253	Drive Shaft		25	24	58.5	79	626							
	2009.06-		MT	L	F	MPV Engine RHE(DW10CTED4)/AHX(DW10FD)	GCI10057	Inner Joint		24	34	40	52.5	90							
	2009.06-		MT	L	F	MPV Engine RHE(DW10CTED4)/AHX(DW10FD)	GC010148	Outer Joint		25	34	58.5	79	55.5	I						
	2009.06-		6AT	R	F	MPV Engine RHE(DW10CTED4)/AHX(DW10FD)	GDS10363	Drive Shaft		25	37	58.5	89	935							
	2009.06-		6AT	R	F	MPV Engine RHE(DW10CTED4)/AHX(DW10FD)	GCI10091	Inner Joint		37	26	31.5	366	100							
	2009.06-		6AT	R	F	MPV Engine RHE(DW10CTED4)/AHX(DW10FD)	GC010158	Outer Joint		25	26	58.5	89	61.5	M						
	2009.06-		6MT	R	F	MPV Engine RHE(DW10CTED4)/AHX(DW10FD)	GDS10325	Drive Shaft		25	24	58.5	79	940							
	2009.06-		6MT	R	F	MPV Engine RHE(DW10CTED4)/AHX(DW10FD)	GCI10058	Inner Joint		24	34	29.8	365	88							
	2009.06-		6MT	R	F	MPV Engine RHE(DW10CTED4)/AHX(DW10FD)	GC010148	Outer Joint		25	34	58.5	79	55.5	I						
	2009.06-		MT	R	F	MPV Engine RHE(DW10CTED4)/AHX(DW10FD)	GDS10361	Drive Shaft		25	37	58.5	89	959							
2.0 HDi (120 kW)	2009.06-		6AT	L	F	MPV Engine RHH(DW10CTED4)	GDS10380	Drive Shaft		25	37	58.5	89	635							
	2009.06-		6MT	L	F	MPV Engine RHH(DW10CTED4)	GDS10253	Drive Shaft		25	24	58.5	79	626							
	2009.06-		6MT	L	F	MPV Engine RHH(DW10CTED4)	GDS10427	Drive Shaft		25	37	58.5	89	638							
	2009.06-		6MT	L	F	MPV Engine RHH(DW10CTED4)	GCI10057	Inner Joint		24	34	40	52.5	90							
	2009.06-		6MT	L	F	MPV Engine RHH(DW10CTED4)	GDS10210	Drive Shaft		25	37	58.5	89	638							
	2009.06-		6MT	L/R	F	MPV Engine RHH(DW10CTED4)	GC010148	Outer Joint		25	34	58.5	79	55.5	I						
	2009.06-		6AT	R	F	MPV Engine RHH(DW10CTED4)	GDS10363	Drive Shaft		25	37	58.5	89	935							
	2009.06-		6AT	R	F	MPV Engine RHH(DW10CTED4)	GCI10091	Inner Joint		37	26	31.5	366	100							
	2009.06-		6AT	R	F	MPV Engine RHH(DW10CTED4)	GC010158	Outer Joint		25	26	58.5	89	61.5	M						
	2009.06-		6MT	R	F	MPV Engine RHH(DW10CTED4)	GDS10325	Drive Shaft		25	24	58.5	79	940							
	2009.06-		6MT	R	F	MPV Engine RHH(DW10CTED4)	GDS10421	Drive Shaft		25	37	58.5	89	972							
	2009.06-		6MT	R	F	MPV Engine RHH(DW10CTED4)	GCI10058	Inner Joint		24	34	29.8	365	88							
2.0 HDi Hybridi4 (120 kW)	2011.02-		MT	L	F	MPV Engine RHH(DW10CTED4)	GDS10250	Drive Shaft		25	24	58.5	79	634							
	2011.02-		MT	R	F	MPV Engine RHH(DW10CTED4)	GDS10361	Drive Shaft		25	37	58.5	89	959							
	2011.02-					MPV Engine RHH(DW10CTED4)	GC010155	Outer Joint		25	39	58.5	89	63.5	I						
<b>305</b>																					
-	1979-	1980				L/R		GDS45092	Drive Shaft		23	23	54	82	718						
<b>305 II (581E)</b>																					
1.5 (54 kW)	1982.10-	1986.08	AT	L	F	Estate Engine 142(XR5)	GDS10117	Drive Shaft		25	24	54.8	79	592.5							
1.9 Diesel (47 kW)	1982.10-	1988.12		L	F	Estate Engine 162(XUD9)/D9A(XUD9)	GDS10117	Drive Shaft		25	24	54.8	79	592.5							
1.9 Diesel (48 kW)	1982.10-	1988.12		L	F	Estate Engine 162(XUD9)	GDS10117	Drive Shaft		25	24	54.8	79	592.5							
<b>305 II (581M)</b>																					
1.5 (54 kW)	1982.10-	1985.08	AT	L	F	Saloon Engine 142(XR5)	GDS10117	Drive Shaft		25	24	54.8	79	592.5							
1.6 (55 kW)	1982.10-	1988.07		L	F	Saloon Engine B1A(XU51C)	GDS10117	Drive Shaft		25	24	54.8	79	592.5							
1.6 (69 kW)	1982.10-	1988.06		L	F	Saloon Engine 171(XU5S)	GDS10117	Drive Shaft		25	24	54.8	79	592.5							
1.6 (71 kW)	1982.10-	1984.06		L	F	Saloon Engine 171(XU5S)	GDS10117	Drive Shaft		25	24	54.8	79	592.5							
1.9 D (47 kW)	1982.10-	1988.07		L	F	Saloon Engine 162(XUD9)/D9A(XUD9)	GDS10117	Drive Shaft		25	24	54.8	79	592.5							
1.9 D (48 kW)	1982.10-	1988.07		L	F	Saloon Engine 162(XUD9)	GDS10117	Drive Shaft		25	24	54.8	79	592.5							
<b>306</b>																					
-								GC045008	Outer Joint		25	23	56.7	79	58.5	M					
						LADO ESQUERDO		GCI45021	Inner Joint		22	27	40	65	87.5						
						LADO ESQUERDO		GCI45020	Inner Joint		24	34	40	69	89						
1.8	1993.04-	1997.04		R				GDS45075	Drive Shaft	48T	25	24	55.7	79	884						
	1993.04-	1997.04		L				GDS45073	Drive Shaft		25	24	54.8	78.5	601						
	1993.04-	1997.04		R				GDS45074	Drive Shaft		25	24	55.7	79	884						
1.9 D	1993.06-	1997.03		R				GDS45075	Drive Shaft	48T	25	24	55.7	79	884						
	1993.06-	1997.03		L				GDS45073	Drive Shaft		25	24	54.8	78.5	601						
	1993.06-	1997.03		R				GDS45074	Drive Shaft		25	24	55.7	79	884						
2	1980.01-	1990.12	MT					GC010038	Outer Joint		25	25	60	79	61.5	O					
	1994.01-	1997.06		R				GDS45075	Drive Shaft	48T	25	24	55.7	79	884						
	1994.01-	1997.06		L				GDS45073	Drive Shaft		25	24	54.8	78.5	601						
	1994.01-	1997.06		R				GDS45074	Drive Shaft		25	24	55.7	79	884						
<b>306 (7A, 7C, N3, N5)</b>																					
1.6 (65 kW)	1993.05-	2000.10	MT	R	F	Hatchback Engine NFZ(TU5JP)	GDS45014	Drive Shaft		25	22	54.8	79	879.5							
	1993.05-	2000.10	MT	L	F	Hatchback Engine NFZ(TU5JP)	GDS45021	Drive Shaft		25	22	54.8	79	607							
	1993.05-	2000.10	MT		F	Hatchback Engine NFZ(TU5JP)	GC010004	Outer Joint	48T	25	23	54.8	78.5	56	I						
1.6 (72 kW)	2000.10-	2001.05	MT	R	F	Hatchback Engine NFT	GDS99038	Drive Shaft	29T	25	22	60	80	879							





		YEAR	TRANSM	L/R	F/R		G-AP Ref.	PRODUCT	ABS	Technical Specifications											
										A	B	C	H	L	P						
<b>PEUGEOT</b>																					
<b>306 (7A, 7C, N3, N5)</b>																					
1.6 (72 kW)	2000.10-	2001.05			R	F	Hatchback Engine NFT	GDS99136	Drive Shaft		25	22	60	80	879						
1.8 (74 kW)	1993.05-	2001.05	MT		R	F	Hatchback Engine LFZ(XU7JP)	GDS10126	Drive Shaft	29W	25	24	55.7	79	886						
	1993.05-	2001.05	MT/AT		R	F	Hatchback Engine LFZ(XU7JP)	GC045014	Outer Joint		25	22	56.7	80	59	O					
1.8 16V (81 kW)	1997.03-	2001.05	MT/AT		R	F	Hatchback Engine LFY(XU7JP4)	GC045014	Outer Joint		25	22	56.7	80	59	O					
1.9 D (47 kW)	1993.05-	2001.05	MT		R	F	Hatchback Engine DJZ(XUD9Y)	GDS10126	Drive Shaft	29W	25	24	55.7	79	886						
	1993.05-	2001.05	MT/AT		R	F	Hatchback Engine DJZ(XUD9Y)	GC045014	Outer Joint		25	22	56.7	80	59	O					
1.9 D (50 kW)	1994.06-	2001.05	MT		R	F	Hatchback Engine DJY(XUD9A)	GDS10126	Drive Shaft	29W	25	24	55.7	79	886						
	1994.06-	2001.05	MT/AT		R	F	Hatchback Engine DJY(XUD9A)	GC045014	Outer Joint		25	22	56.7	80	59	O					
1.9 D (51 kW)	1998.09-	2001.05	MT/AT		R	F	Hatchback Engine WJY(DW8B)/WJZ(DW8)	GC045014	Outer Joint		25	22	56.7	80	59	O					
2.0 HDi (66 kW)	1999.06-	2001.05	MT		R	F	Hatchback Engine RHY(DW10TD)	GDS10126	Drive Shaft	29W	25	24	55.7	79	886						
2.0 S16 (110 kW)	1994.06-	2001.05	MT		R	F	Hatchback Engine RFT(XU10J4)	GDS10126	Drive Shaft	29W	25	24	55.7	79	886						
2.0 S16 (112 kW)	1993.05-	2001.05	MT		R	F	Hatchback Engine RFY(XU10J4Z)	GDS10126	Drive Shaft	29W	25	24	55.7	79	886						
2.0 S16 (120 kW)	1996.03-	2001.05	MT		R	F	Hatchback Engine RFS(XU10J4RS)	GDS10126	Drive Shaft	29W	25	24	55.7	79	886						
2.0 XSi (89 kW)	1993.05-	2001.05	MT		R	F	Hatchback Engine RFX(XU10J2)	GDS10126	Drive Shaft	29W	25	24	55.7	79	886						
<b>306 (7B, N3, N5)</b>																					
1.6 SR (65 kW)	1994.06-	2000.10	MT		R	F	Saloon Engine NFZ(TU5JP)	GDS45014	Drive Shaft		25	22	54.8	79	879.5						
	1994.06-	2000.10	MT		L	F	Saloon Engine NFZ(TU5JP)	GDS45021	Drive Shaft		25	22	54.8	79	607						
	1994.06-	2000.10	MT			F	Saloon Engine NFZ(TU5JP)	GC010004	Outer Joint	48T	25	23	54.8	78.5	56	I					
1.8 16V (81 kW)	1997.03-	2001.05	MT/AT		R	F	Saloon Engine LFY(XU7JP4)	GC045014	Outer Joint		25	22	56.7	80	59	O					
1.8 ST (74 kW)	1994.06-	2001.05	MT		R	F	Saloon Engine LFZ(XU7JP)	GDS10126	Drive Shaft	29W	25	24	55.7	79	886						
	1994.06-	2001.05	MT/AT		R	F	Saloon Engine LFZ(XU7JP)	GC045014	Outer Joint		25	22	56.7	80	59	O					
1.9 D (51 kW)	1998.09-	2001.05	MT/AT		R	F	Saloon Engine WJY(DW8B)/WJZ(DW8)	GC045014	Outer Joint		25	22	56.7	80	59	O					
1.9 SLD (47 kW)	1994.06-	2001.05	MT		R	F	Saloon Engine DJZ(XUD9Y)	GDS10126	Drive Shaft	29W	25	24	55.7	79	886						
	1994.06-	2001.05	MT/AT		R	F	Saloon Engine DJZ(XUD9Y)	GC045014	Outer Joint		25	22	56.7	80	59	O					
1.9 SLD (50 kW)	1994.06-	2001.05	MT		R	F	Saloon Engine DJY(XUD9A)	GDS10126	Drive Shaft	29W	25	24	55.7	79	886						
	1994.06-	2001.05	MT/AT		R	F	Saloon Engine DJY(XUD9A)	GC045014	Outer Joint		25	22	56.7	80	59	O					
1.9 SRDT (66 kW)	1994.06-	2001.05	MT		R	F	Saloon Engine DHY(XUD9TE)	GDS10126	Drive Shaft	29W	25	24	55.7	79	886						
2.0 HDi (66 kW)	1999.06-	2001.05	MT		R	F	Saloon Engine RHY(DW10TD)	GDS10126	Drive Shaft	29W	25	24	55.7	79	886						
2.0 S16 (110 kW)	1994.06-	2001.05	MT		R	F	Saloon Engine RFT(XU10J4)	GDS10126	Drive Shaft	29W	25	24	55.7	79	886						
2.0 S16 (112 kW)	1994.06-	2001.05	MT		R	F	Saloon Engine RFY(XU10J4Z)	GDS10126	Drive Shaft	29W	25	24	55.7	79	886						
2.0 ST (89 kW)	1994.07-	2001.05	MT		R	F	Saloon Engine RFX(XU10J2)	GDS10126	Drive Shaft	29W	25	24	55.7	79	886						
<b>306 (7B,N3)</b>																					
1.1 (44 kW)	1993-				L			GDS45157	Drive Shaft	29T	25	22	54.5	79.5	605						
1.4 SL (55 kW)	1993-				L			GDS45157	Drive Shaft	29T	25	22	54.5	79.5	605						
<b>306 (7D, N3, N5)</b>																					
1.6 (65 kW)	1996.04-	2000.10	MT		R	F	Convertible Engine NFZ(TU5JP)	GDS45014	Drive Shaft		25	22	54.8	79	879.5						
	1996.04-	2000.10	MT		L	F	Convertible Engine NFZ(TU5JP)	GDS45021	Drive Shaft		25	22	54.8	79	607						
	1996.04-	2000.10	MT			F	Convertible Engine NFZ(TU5JP)	GC010004	Outer Joint	48T	25	23	54.8	78.5	56	I					
1.6 (72 kW)	2000.10-	2002.04	MT		R	F	Convertible Engine NFT	GDS45158	Drive Shaft	29T	25	22	54.5	79.5	875						
1.8 (74 kW)	1994.03-	2002.04	MT			F	Convertible Engine LFZ(XU7JP)	GC010024	Outer Joint	48T	25	34	55.7	79	55	I					
	1994.03-	2002.04	MT/AT			F	Convertible Engine LFZ(XU7JP)	GC045001	Outer Joint	29T	25	34	54.8	78.5	56	I					
	1994.03-	2002.04	MT/AT			F	Convertible Engine LFZ(XU7JP)	GC010003	Outer Joint	29T	25	23	54.8	78.5	56	I					
	1994.03-	2002.04	MT/AT			F	Convertible Engine LFZ(XU7JP)	GC010002	Outer Joint		25	23	54.8	78.5	56	I					
	1994.03-	2002.04	MT/AT	L		F	Convertible Engine LFZ(XU7JP)	GDS45024	Drive Shaft	29T	25	24	55.7	79	603.5						
	1994.03-	2002.04	MT/AT	L		F	Convertible Engine LFZ(XU7JP)	GDS45167	Drive Shaft		25	24	56.7	79	608						
	1994.03-	2002.04	MT	R	F	F	Convertible Engine LFZ(XU7JP)	GDS10126	Drive Shaft	29W	25	24	55.7	79	886						
	1994.03-	2002.04	MT	R	F	F	Convertible Engine LFZ(XU7JP)	GDS45070	Drive Shaft		25	24	54.8	78.5	880						
	1994.03-	2002.04	MT/AT	R	F	F	Convertible Engine LFZ(XU7JP)	GC045014	Outer Joint		25	22	56.7	80	59	O					
	1994.03-	2002.04	MT/AT	R	F	F	Convertible Engine LFZ(XU7JP)	GDS45017	Drive Shaft	29T	25	24	55.7	79	881						
1.8 16V (81 kW)	1994.03-	2002.04	MT/AT	R	F	F	Convertible Engine LFZ(XU7JP)	GDS45198	Drive Shaft		25	24	56.7	80	891						
	2000.07-	2002.04	MT/AT	L		F	Convertible Engine LFY(XU7JP4)	GDS45024	Drive Shaft	29T	25	24	55.7	79	603.5						
	2000.07-	2002.04	MT/AT	L		F	Convertible Engine LFY(XU7JP4)	GDS45167	Drive Shaft		25	24	56.7	79	608						
	2000.07-	2002.04	MT/AT	R		F	Convertible Engine LFY(XU7JP4)	GC045014	Outer Joint		25	22	56.7	80	59	O					
	2000.07-	2002.04	MT/AT	R		F	Convertible Engine LFY(XU7JP4)	GDS45017	Drive Shaft	29T	25	24	55.7	79	881						
2.0 (89 kW)	2000.07-	2002.04	MT/AT	R		F	Convertible Engine LFY(XU7JP4)	GDS45198	Drive Shaft		25	24	56.7	80	891						
	1994.03-	2002.04	MT			F	Convertible Engine RFX(XU10J2)	GC010024	Outer Joint	48T	25	34	55.7	79	55	I					
	1994.03-	2002.04	MT/AT			F	Convertible Engine RFX(XU10J2)	GC045001	Outer Joint	29T	25	34	54.8	78.5	56	I					
	1994.03-	2002.04	MT/AT			F	Convertible Engine RFX(XU10J2)	GC010003	Outer Joint	29T	25	23	54.8	78.5	56	I					
	1994.03-	2002.04	MT/AT			F	Convertible Engine RFX(XU10J2)	GC010002	Outer Joint		25	23	54.8	78.5	56	I					
	1994.03-	2002.04	MT/AT	L		F	Convertible Engine RFX(XU10J2)	GDS45008	Drive Shaft		25	24	54.8	78.5	601.5						
1994.03-	2002.04	MT	R		F	Convertible Engine RFX(XU10J2)	GDS10126	Drive Shaft	29W	25	24	55.7	79	886							





		TRANSM	L/R	F/R		G-AP Ref.	PRODUCT	ABS	Technical Specifications									
									YEAR	A	B	C	H	L	P			
<b>PEUGEOT</b>																		
<b>306 (7D, N3, N5)</b>																		
2.0 (89 kW)	1994.03-	2002.04	MT	R	F	Convertible Engine RFX(XU10J2)	GDS45070	Drive Shaft		25	24	54.8	78.5	880				
<b>306 BREAK (7E, N3, N5)</b>																		
1.4 (55 kW)	1997.03-	2002.04	MT	L	F	Estate Engine KFW(TU3JP)/KFX(TU3JP)	GDS45155	Drive Shaft	48T	25	22	54.5	79.5	609				
	1997.03-	2002.04	MT	L	F	Estate Engine KFW(TU3JP)/KFX(TU3JP)	GDS45004	Drive Shaft		21	22	56.4	76	614				
	1997.03-	2002.04	MT	L	F	Estate Engine KFW(TU3JP)/KFX(TU3JP)	GDS45138	Drive Shaft		25	22	60	78.5	601				
	1997.03-	2002.04	MT	R	F	Estate Engine KFW(TU3JP)/KFX(TU3JP)	GDS45137	Drive Shaft		25	22	60	78.5	880				
	1997.03-	2002.04	MT	R	F	Estate Engine KFW(TU3JP)/KFX(TU3JP)	GDS45156	Drive Shaft	48T	25	22	54.5	79.5	869.5				
	1997.03-	2002.04	MT	R	F	Estate Engine KFW(TU3JP)/KFX(TU3JP)	GDS45025	Drive Shaft		21	22	56.4	76	877.5				
1.6 (65 kW)	1997.03-	2000.10	MT	R	F	Estate Engine NFZ(TU5JP)	GDS45014	Drive Shaft		25	22	54.8	79	879.5				
	1997.03-	2000.10	MT	L	F	Estate Engine NFZ(TU5JP)	GDS45021	Drive Shaft		25	22	54.8	79	607				
	1997.03-	2000.10	MT		F	Estate Engine NFZ(TU5JP)	GC010004	Outer Joint	48T	25	23	54.8	78.5	56	I			
1.6 (72 kW)	2000.10-	2002.04	MT	R	F	Estate Engine NFT	GDS45158	Drive Shaft	29T	25	22	54.5	79.5	875				
1.8 (74 kW)	1997.03-	2002.04	MT/AT	L	F	Estate Engine LFZ(XU7JP)	GDS45024	Drive Shaft	29T	25	24	55.7	79	603.5				
	1997.03-	2002.04	MT/AT	L	F	Estate Engine LFZ(XU7JP)	GDS45167	Drive Shaft		25	24	56.7	79	608				
	1997.03-	2002.04	MT	R	F	Estate Engine LFZ(XU7JP)	GDS45070	Drive Shaft		25	24	54.8	78.5	880				
	1997.03-	2002.04	MT/AT	R	F	Estate Engine LFZ(XU7JP)	GC045014	Outer Joint		25	22	56.7	80	59	O			
	1997.03-	2002.04	MT/AT	R	F	Estate Engine LFZ(XU7JP)	GDS45017	Drive Shaft	29T	25	24	55.7	79	881				
	1997.03-	2002.04	MT/AT	R	F	Estate Engine LFZ(XU7JP)	GDS45198	Drive Shaft		25	24	56.7	80	891				
	1997.03-	2002.04			F	Estate Engine LFZ(XU7JP)	GC010024	Outer Joint	48T	25	34	55.7	79	55	I			
	1997.03-	2002.04	MT/AT		F	Estate Engine LFZ(XU7JP)	GC045001	Outer Joint	29T	25	34	54.8	78.5	56	I			
	1997.03-	2002.04	MT/AT		F	Estate Engine LFZ(XU7JP)	GC010002	Outer Joint		25	23	54.8	78.5	56	I			
1.8 16V (81 kW)	1997.03-	2002.04	MT/AT	L	F	Estate Engine LFY(XU7JP4)	GDS45024	Drive Shaft	29T	25	24	55.7	79	603.5				
	1997.03-	2002.04	MT/AT	L	F	Estate Engine LFY(XU7JP4)	GDS45167	Drive Shaft		25	24	56.7	79	608				
	1997.03-	2002.04	MT	R	F	Estate Engine LFY(XU7JP4)	GDS45070	Drive Shaft		25	24	54.8	78.5	880				
	1997.03-	2002.04	MT/AT	R	F	Estate Engine LFY(XU7JP4)	GC045014	Outer Joint		25	22	56.7	80	59	O			
	1997.03-	2002.04	MT/AT	R	F	Estate Engine LFY(XU7JP4)	GDS45017	Drive Shaft	29T	25	24	55.7	79	881				
	1997.03-	2002.04	MT/AT	R	F	Estate Engine LFY(XU7JP4)	GDS45198	Drive Shaft		25	24	56.7	80	891				
1.9 D (50 kW)	1997.03-	2002.04			F	Estate Engine DJY(XUD9A)	GC010024	Outer Joint	48T	25	34	55.7	79	55	I			
	1997.03-	2002.04	MT/AT		F	Estate Engine DJY(XUD9A)	GC045001	Outer Joint	29T	25	34	54.8	78.5	56	I			
	1997.03-	2002.04	MT/AT		F	Estate Engine DJY(XUD9A)	GC010002	Outer Joint		25	23	54.8	78.5	56	I			
	1997.03-	2002.04	MT/AT	L	F	Estate Engine DJY(XUD9A)	GDS45024	Drive Shaft	29T	25	24	55.7	79	603.5				
	1997.03-	2002.04	MT/AT	L	F	Estate Engine DJY(XUD9A)	GDS45167	Drive Shaft		25	24	56.7	79	608				
	1997.03-	2002.04	MT	R	F	Estate Engine DJY(XUD9A)	GDS45070	Drive Shaft		25	24	54.8	78.5	880				
	1997.03-	2002.04	MT/AT	R	F	Estate Engine DJY(XUD9A)	GC045014	Outer Joint		25	22	56.7	80	59	O			
	1997.03-	2002.04	MT/AT	R	F	Estate Engine DJY(XUD9A)	GDS45017	Drive Shaft	29T	25	24	55.7	79	881				
	1997.03-	2002.04	MT/AT	R	F	Estate Engine DJY(XUD9A)	GDS45198	Drive Shaft		25	24	56.7	80	891				
1.9 D (51 kW)	1998.09-	2002.04			F	Estate Engine WJY(DW8B)/WJZ(DW8)	GC010024	Outer Joint	48T	25	34	55.7	79	55	I			
	1998.09-	2002.04	MT/AT		F	Estate Engine WJY(DW8B)/WJZ(DW8)	GC045001	Outer Joint	29T	25	34	54.8	78.5	56	I			
	1998.09-	2002.04	MT/AT		F	Estate Engine WJY(DW8B)/WJZ(DW8)	GC010002	Outer Joint		25	23	54.8	78.5	56	I			
	1998.09-	2002.04	MT/AT	L	F	Estate Engine WJY(DW8B)/WJZ(DW8)	GDS45024	Drive Shaft	29T	25	24	55.7	79	603.5				
	1998.09-	2002.04	MT/AT	L	F	Estate Engine WJY(DW8B)/WJZ(DW8)	GDS45167	Drive Shaft		25	24	56.7	79	608				
	1998.09-	2002.04	MT	R	F	Estate Engine WJY(DW8B)/WJZ(DW8)	GDS45070	Drive Shaft		25	24	54.8	78.5	880				
	1998.09-	2002.04	MT/AT	R	F	Estate Engine WJY(DW8B)/WJZ(DW8)	GC045014	Outer Joint		25	22	56.7	80	59	O			
	1998.09-	2002.04	MT/AT	R	F	Estate Engine WJY(DW8B)/WJZ(DW8)	GDS45017	Drive Shaft	29T	25	24	55.7	79	881				
	1998.09-	2002.04	MT/AT	R	F	Estate Engine WJY(DW8B)/WJZ(DW8)	GDS45198	Drive Shaft		25	24	56.7	80	891				
1.9 D (55 kW)	1998.03-	2002.04	MT/AT		F	Estate Engine DHV(XUD9BSD)	GC045001	Outer Joint	29T	25	34	54.8	78.5	56	I			
	1998.03-	2002.04	MT/AT		F	Estate Engine DHV(XUD9BSD)	GC010002	Outer Joint		25	23	54.8	78.5	56	I			
	1998.03-	2002.04	MT	R	F	Estate Engine DHV(XUD9BSD)	GDS45070	Drive Shaft		25	24	54.8	78.5	880				
1.9 TD (66 kW)	1997.02-	2002.04			F	Estate Engine DHY(XUD9TE)	GC010024	Outer Joint	48T	25	34	55.7	79	55	I			
	1997.02-	2002.04	MT		F	Estate Engine DHY(XUD9TE)	GC045001	Outer Joint	29T	25	34	54.8	78.5	56	I			
	1997.02-	2002.04	MT		F	Estate Engine DHY(XUD9TE)	GC010002	Outer Joint		25	23	54.8	78.5	56	I			
	1997.02-	2002.04	MT	L	F	Estate Engine DHY(XUD9TE)	GDS45024	Drive Shaft	29T	25	24	55.7	79	603.5				
	1997.02-	2002.04	MT	L	F	Estate Engine DHY(XUD9TE)	GDS45008	Drive Shaft		25	24	54.8	78.5	601.5				
	1997.02-	2002.04	MT	R	F	Estate Engine DHY(XUD9TE)	GDS45017	Drive Shaft	29T	25	24	55.7	79	881				
	1997.02-	2002.04	MT	R	F	Estate Engine DHY(XUD9TE)	GDS45070	Drive Shaft		25	24	54.8	78.5	880				
2.0 HDi (66 kW)	1999.06-	2002.04	MT	L	F	Estate Engine RHY(DW10TD)	GDS45024	Drive Shaft	29T	25	24	55.7	79	603.5				
	1999.06-	2002.04	MT	L	F	Estate Engine RHY(DW10TD)	GDS45008	Drive Shaft		25	24	54.8	78.5	601.5				
	1999.06-	2002.04	MT	R	F	Estate Engine RHY(DW10TD)	GDS10126	Drive Shaft	29W	25	24	55.7	79	886				
	1999.06-	2002.04	MT	R	F	Estate Engine RHY(DW10TD)	GDS45017	Drive Shaft	29T	25	24	55.7	79	881				
	1999.06-	2002.04	MT	R	F	Estate Engine RHY(DW10TD)	GDS45070	Drive Shaft		25	24	54.8	78.5	880				



		TRANSM	L/R	F/R		G-AP Ref.	PRODUCT	ABS	Technical Specifications						
									YEAR	A	B	C	H	L	P
<b>PEUGEOT</b>															
<b>306 II</b>															
1.4	1997.04-	2002.05	MT	R		GDS45018	Drive Shaft	29T	25	22	60	80	878.5		
	1997.04-	2002.05	MT	L	F	GDS45117	Drive Shaft	29T	25	22	55	79.5	615		
1.6	1997.04-					GCO45036	Outer Joint	29T	25	22	60	80	54	I	
	1997.04-	2002.09	MT	L	F	GDS99037	Drive Shaft	29T	25	22	60	80	608		
1.8	1997.04-	2002.09	MT/AT	R		GDS45048	Drive Shaft	29T	25	24	55.7	79	881.5		
1.9 D	1997.04-	2002.05	MT	R		GDS45048	Drive Shaft	29T	25	24	55.7	79	881.5		
2.0 16V	1997.04-	2000.12				GCI10001	Inner Joint		24	34	29.8	350	89.5		
	1997.04-	2000.12				GCI10020	Inner Joint		24	34	40	62.5	99		
2.0 HDi	1999.05-	2002.05	MT	L	F	GDS45041	Drive Shaft	29T	25	24	58	78.5	600		
<b>307 (3A/C)</b>															
1.4 (55 kW)	2000.08-		MT	R	F	Hatchback Engine KFW(TU3JP)	GDS99170	Drive Shaft		25	22	60	80	910	
1.4 16V (65 kW)	2003.10-	2007.01			F	Hatchback Engine KFU(ET3J4)	GCO10025	Outer Joint		25	22	60	80	54	I
	2003.10-	2007.01	MT	L	F	Hatchback Engine KFU(ET3J4)	GDS45119	Drive Shaft		25	22	58.5	79.5	633	
	2003.10-	2007.01	MT	R	F	Hatchback Engine KFU(ET3J4)	GDS45113	Drive Shaft		25	22	58.5	79.5	915	
1.4 HDi (50 kW)	2001.10-				F	Hatchback Engine 8HX(DV4TD)/8HZ(DV4TD)	GCO10028	Outer Joint		25	34	58	89	56	I
	2001.10-		MT	L	F	Hatchback Engine 8HX(DV4TD)/8HZ(DV4TD)	GDS45126	Drive Shaft		25	24	58.5	89	630	
	2001.10-		MT	R	F	Hatchback Engine 8HX(DV4TD)/8HZ(DV4TD)	GDS45104	Drive Shaft		25	24	58	79	925	
	2001.10-		MT	L	F	Hatchback Engine 8HX(DV4TD)/8HZ(DV4TD)	GDS99019	Drive Shaft	29T	25	24	55.7	79	620	
	2001.10-		MT	R	F	Hatchback Engine 8HX(DV4TD)/8HZ(DV4TD)	GDS10229	Drive Shaft		25	24	58.5	79	935	
1.6 (81 kW)	2006.07-		AT	L	F	Hatchback	GDS10286	Drive Shaft		25	26	58.5	79	613	
	2006.07-		MT	L	F	Hatchback	GDS99019	Drive Shaft	29T	25	24	55.7	79	620	
	2006.07-		AT	R	F	Hatchback	GDS10291	Drive Shaft		25	26	58.5	79	833	
	2006.07-		MT	R	F	Hatchback	GDS10229	Drive Shaft		25	24	58.5	79	935	
	2006.07-					Hatchback	GCO10097	Outer Joint		25	30	58.5	79.5	55	I
1.6 16V (80 kW)	2000.08-		MT	R	F	Hatchback Engine NFU(TU5JP4)	GDS10229	Drive Shaft		25	24	58.5	79	935	
	2000.08-		AT	L	F	Hatchback Engine NFU(TU5JP4)	GDS10286	Drive Shaft		25	26	58.5	79	613	
	2000.08-		AT	R	F	Hatchback Engine NFU(TU5JP4)	GDS10291	Drive Shaft		25	26	58.5	79	833	
	2000.08-		MT	L	F	Hatchback Engine NFU(TU5JP4)	GDS99019	Drive Shaft	29T	25	24	55.7	79	620	
	2000.08-					Hatchback Engine NFU(TU5JP4)	GCO10097	Outer Joint		25	30	58.5	79.5	55	I
	2000.08-		AT			Hatchback Engine NFU(TU5JP4)	GCO99366	Outer Joint		25	34	58.5	79	55	I
1.6 HDi (66 kW)	2005.06-	2007.01			F	Hatchback Engine 9HV(DV6ATED4)	GCO10028	Outer Joint		25	34	58	89	56	I
	2005.06-	2007.01		L	F	Hatchback Engine 9HV(DV6ATED4)	GDS45105	Drive Shaft		25	24	58	79	625	
	2005.06-	2007.01	MT	L	F	Hatchback Engine 9HV(DV6ATED4)	GDS99019	Drive Shaft	29T	25	24	55.7	79	620	
	2005.06-	2007.01		R	F	Hatchback Engine 9HV(DV6ATED4)	GDS45104	Drive Shaft		25	24	58	79	925	
	2005.06-	2007.01	MT	R	F	Hatchback Engine 9HV(DV6ATED4)	GDS10229	Drive Shaft		25	24	58.5	79	935	
1.6 HDi (80 kW)	2005.03-	2006.05			F	Hatchback Engine 9HY(DV6TED4)/9HZ(DV6TED4)	GCO10028	Outer Joint		25	34	58	89	56	I
	2005.03-	2006.05	MT	L	F	Hatchback Engine 9HY(DV6TED4)/9HZ(DV6TED4)	GDS99019	Drive Shaft	29T	25	24	55.7	79	620	
	2005.03-	2006.05	MT	L	F	Hatchback Engine 9HY(DV6TED4)/9HZ(DV6TED4)	GDS45105	Drive Shaft		25	24	58	79	625	
	2005.03-	2006.05	MT	R	F	Hatchback Engine 9HY(DV6TED4)/9HZ(DV6TED4)	GDS10229	Drive Shaft		25	24	58.5	79	935	
	2005.03-	2006.05	MT	R	F	Hatchback Engine 9HY(DV6TED4)/9HZ(DV6TED4)	GDS45104	Drive Shaft		25	24	58	79	925	
	2005.03-	2006.05		R	F	Hatchback Engine 9HY(DV6TED4)/9HZ(DV6TED4)	GDS10173	Drive Shaft	29W	25	24	58.5	79	921	
2.0 16V (100 kW)	2000.08-		MT	R	F	Hatchback Engine RFN(EW10J4)	GDS10229	Drive Shaft		25	24	58.5	79	935	
	2000.08-		AT	L	F	Hatchback Engine RFN(EW10J4)	GDS10286	Drive Shaft		25	26	58.5	79	613	
	2000.08-		AT	R	F	Hatchback Engine RFN(EW10J4)	GDS10291	Drive Shaft		25	26	58.5	79	833	
	2000.08-		MT	L	F	Hatchback Engine RFN(EW10J4)	GDS99019	Drive Shaft	29T	25	24	55.7	79	620	
2.0 16V (103 kW)	2006.06-				F	Hatchback Engine RFJ(EW10A)	GCO10028	Outer Joint		25	34	58	89	56	I
	2006.06-			L	F	Hatchback Engine RFJ(EW10A)	GDS45105	Drive Shaft		25	24	58	79	625	
	2006.06-			R	F	Hatchback Engine RFJ(EW10A)	GDS45104	Drive Shaft		25	24	58	79	925	
	2006.06-		AT	L	F	Hatchback Engine RFJ(EW10A)	GDS10286	Drive Shaft		25	26	58.5	79	613	
	2006.06-		MT	L	F	Hatchback Engine RFJ(EW10A)	GDS99019	Drive Shaft	29T	25	24	55.7	79	620	
	2006.06-		AT	R	F	Hatchback Engine RFJ(EW10A)	GDS10291	Drive Shaft		25	26	58.5	79	833	
	2006.06-		MT	R	F	Hatchback Engine RFJ(EW10A)	GDS10229	Drive Shaft		25	24	58.5	79	935	
2.0 16V (130 kW)	2005.06-	2006.05			F	Hatchback Engine RFK(EW10J4S)	GCO10028	Outer Joint		25	34	58	89	56	I
	2005.06-	2006.05		L	F	Hatchback Engine RFK(EW10J4S)	GDS45105	Drive Shaft		25	24	58	79	625	
	2005.06-	2006.05	MT	L	F	Hatchback Engine RFK(EW10J4S)	GDS99019	Drive Shaft	29T	25	24	55.7	79	620	
	2005.06-	2006.05		R	F	Hatchback Engine RFK(EW10J4S)	GDS45104	Drive Shaft		25	24	58	79	925	
	2005.06-	2006.05	MT	R	F	Hatchback Engine RFK(EW10J4S)	GDS10229	Drive Shaft		25	24	58.5	79	935	
2.0 HDi (100 kW)	2004.04-	2006.05			F	Hatchback Engine RHR(DW10BTED4)	GCO10085	Outer Joint		25	39	59	89	63.5	I
	2004.04-	2006.05	6MT	L	F	Hatchback Engine RHR(DW10BTED4)	GDS10268	Drive Shaft		25	37	58.5	89	621	
	2004.04-	2006.05	MT	L	F	Hatchback Engine RHR(DW10BTED4)	GDS45105	Drive Shaft		25	24	58	79	625	
	2004.04-	2006.05	MT	R	F	Hatchback Engine RHR(DW10BTED4)	GDS88082	Drive Shaft		25	37	58.5	89	949	





		TRANSM	L/R	F/R		G-AP Ref.	PRODUCT	ABS	Technical Specifications						
									YEAR	A	B	C	H	L	P
<b>PEUGEOT</b>															
<b>307 (3A/C)</b>															
2.0 HDi (100 kW)	2004.04-	2006.05	MT	R	F	Hatchback Engine RHR(DW10BTED4)	GDS45104	Drive Shaft		25	24	58	79	925	
	2004.04-	2006.05		R	F	Hatchback Engine RHR(DW10BTED4)	GDS10173	Drive Shaft	29W	25	24	58.5	79	921	
2.0 HDi (66 kW)	2000.08-			R	F	Hatchback Engine RHY(DW10TD)	GDS10173	Drive Shaft	29W	25	24	58.5	79	921	
	2000.08-		MT	R	F	Hatchback Engine RHY(DW10TD)	GDS10229	Drive Shaft		25	24	58.5	79	935	
	2000.08-		MT	L	F	Hatchback Engine RHY(DW10TD)	GDS99019	Drive Shaft	29T	25	24	55.7	79	620	
2.0 HDi (79 kW)	2000.08-			R	F	Hatchback Engine RHS(DW10ATED)	GDS10173	Drive Shaft	29W	25	24	58.5	79	921	
	2000.08-		MT	R	F	Hatchback Engine RHS(DW10ATED)	GDS10229	Drive Shaft		25	24	58.5	79	935	
	2000.08-		MT	L	F	Hatchback Engine RHS(DW10ATED)	GDS99019	Drive Shaft	29T	25	24	55.7	79	620	
<b>307 (3E)</b>															
1.4 (55 kW)	2002.04-	2003.09			F	Estate Engine TU3JP	GC010025	Outer Joint		25	22	60	80	54	I
1.4 16V (65 kW)	2003.11-	2004.11			F	Estate Engine KFU(ET3J4)	GC010025	Outer Joint		25	22	60	80	54	I
	2003.11-	2004.11	MT	L	F	Estate Engine KFU(ET3J4)	GDS45119	Drive Shaft		25	22	58.5	79.5	633	
	2003.11-	2004.11	MT	R	F	Estate Engine KFU(ET3J4)	GDS99170	Drive Shaft		25	22	60	80	910	
	2003.11-	2004.11	MT	R	F	Estate Engine KFU(ET3J4)	GDS45113	Drive Shaft		25	22	58.5	79.5	915	
1.4 HDi (50 kW)	2002.03-	2004.11			F	Estate Engine 8HZ(DV4TD)	GC010028	Outer Joint		25	34	58	89	56	I
	2002.03-	2004.11	MT	L	F	Estate Engine 8HZ(DV4TD)	GDS99019	Drive Shaft	29T	25	24	55.7	79	620	
	2002.03-	2004.11	MT	L	F	Estate Engine 8HZ(DV4TD)	GDS45126	Drive Shaft		25	24	58.5	89	630	
	2002.03-	2004.11	MT	R	F	Estate Engine 8HZ(DV4TD)	GDS10229	Drive Shaft		25	24	58.5	79	935	
	2002.03-	2004.11	MT	R	F	Estate Engine 8HZ(DV4TD)	GDS45104	Drive Shaft		25	24	58	79	925	
1.6 16V (80 kW)	2002.03-	2006.05			F	Estate Engine NFU(TU5JP4)	GC010028	Outer Joint		25	34	58	89	56	I
	2002.03-	2006.05	AT	L	F	Estate Engine NFU(TU5JP4)	GDS10286	Drive Shaft		25	26	58.5	79	613	
	2002.03-	2006.05	MT	L	F	Estate Engine NFU(TU5JP4)	GDS99019	Drive Shaft	29T	25	24	55.7	79	620	
	2002.03-	2006.05	MT	L	F	Estate Engine NFU(TU5JP4)	GDS45119	Drive Shaft		25	22	58.5	79.5	633	
	2002.03-	2006.05	MT	L	F	Estate Engine NFU(TU5JP4)	GDS45126	Drive Shaft		25	24	58.5	89	630	
	2002.03-	2006.05	AT	R	F	Estate Engine NFU(TU5JP4)	GDS10291	Drive Shaft		25	26	58.5	79	833	
	2002.03-	2006.05	MT	R	F	Estate Engine NFU(TU5JP4)	GDS10229	Drive Shaft		25	24	58.5	79	935	
	2002.03-	2006.05	MT	R	F	Estate Engine NFU(TU5JP4)	GDS45104	Drive Shaft		25	24	58	79	925	
	2002.03-	2006.05	MT	R	F	Estate Engine NFU(TU5JP4)	GDS45113	Drive Shaft		25	22	58.5	79.5	915	
	2002.03-	2006.05	AT			Estate Engine NFU(TU5JP4)	GC099366	Outer Joint		25	34	58.5	79	55	I
	2002.03-	2006.05				Estate Engine NFU(TU5JP4)	GC010097	Outer Joint		25	30	58.5	79.5	55	I
	2002.03-	2006.05				Estate Engine NFU(TU5JP4)	GC010028	Outer Joint		25	34	58	89	56	I
	1.6 HDi (66 kW)	2005.06-	2007.01			F	Estate Engine 9HV(DV6ATED4)	GC010028	Outer Joint		25	34	58	89	56
2005.06-		2007.01		L	F	Estate Engine 9HV(DV6ATED4)	GDS45105	Drive Shaft		25	24	58	79	625	
2005.06-		2007.01	MT	L	F	Estate Engine 9HV(DV6ATED4)	GDS99019	Drive Shaft	29T	25	24	55.7	79	620	
2005.06-		2007.01		R	F	Estate Engine 9HV(DV6ATED4)	GDS45104	Drive Shaft		25	24	58	79	925	
2005.06-		2007.01	MT	R	F	Estate Engine 9HV(DV6ATED4)	GDS10229	Drive Shaft		25	24	58.5	79	935	
1.6 HDi (80 kW)	2004.04-	2005.05			F	Estate Engine 9HY(DV6TED4)9HZ(DV6TED4)	GC010028	Outer Joint		25	34	58	89	56	I
	2004.04-	2005.05	MT	L	F	Estate Engine 9HY(DV6TED4)9HZ(DV6TED4)	GDS99019	Drive Shaft	29T	25	24	55.7	79	620	
	2004.04-	2005.05	MT	L	F	Estate Engine 9HY(DV6TED4)9HZ(DV6TED4)	GDS45105	Drive Shaft		25	24	58	79	625	
	2004.04-	2005.05	MT	R	F	Estate Engine 9HY(DV6TED4)9HZ(DV6TED4)	GDS10229	Drive Shaft		25	24	58.5	79	935	
	2004.04-	2005.05	MT	R	F	Estate Engine 9HY(DV6TED4)9HZ(DV6TED4)	GDS45104	Drive Shaft		25	24	58	79	925	
	2004.04-	2005.05		R	F	Estate Engine 9HY(DV6TED4)9HZ(DV6TED4)	GDS10173	Drive Shaft	29W	25	24	58.5	79	921	
2.0 (100 kW)	2002.11-	2004.11			F	Estate Engine RFN(EW10J4)	GC010028	Outer Joint		25	34	58	89	56	I
	2002.11-	2004.11	AT	L	F	Estate Engine RFN(EW10J4)	GDS10286	Drive Shaft		25	26	58.5	79	613	
	2002.11-	2004.11	MT	L	F	Estate Engine RFN(EW10J4)	GDS99019	Drive Shaft	29T	25	24	55.7	79	620	
	2002.11-	2004.11	MT	L	F	Estate Engine RFN(EW10J4)	GDS45126	Drive Shaft		25	24	58.5	89	630	
	2002.11-	2004.11	AT	R	F	Estate Engine RFN(EW10J4)	GDS10291	Drive Shaft		25	26	58.5	79	833	
	2002.11-	2004.11	MT	R	F	Estate Engine RFN(EW10J4)	GDS10229	Drive Shaft		25	24	58.5	79	935	
	2002.11-	2004.11	MT	R	F	Estate Engine RFN(EW10J4)	GDS45104	Drive Shaft		25	24	58	79	925	
2.0 16V (103 kW)	2005.03-				F	Estate Engine RFJ(EW10A)	GC010028	Outer Joint		25	34	58	89	56	I
	2005.03-			L	F	Estate Engine RFJ(EW10A)	GDS45105	Drive Shaft		25	24	58	79	625	
	2005.03-			R	F	Estate Engine RFJ(EW10A)	GDS45104	Drive Shaft		25	24	58	79	925	
	2005.03-		AT	L	F	Estate Engine RFJ(EW10A)	GDS10286	Drive Shaft		25	26	58.5	79	613	
	2005.03-		MT	L	F	Estate Engine RFJ(EW10A)	GDS99019	Drive Shaft	29T	25	24	55.7	79	620	
	2005.03-		AT	R	F	Estate Engine RFJ(EW10A)	GDS10291	Drive Shaft		25	26	58.5	79	833	
	2005.03-		MT	R	F	Estate Engine RFJ(EW10A)	GDS10229	Drive Shaft		25	24	58.5	79	935	
2.0 16V (130 kW)	2006.06-	2007.01			F	Estate Engine RFK(EW10J4S)	GC010028	Outer Joint		25	34	58	89	56	I
	2006.06-	2007.01	MT	L	F	Estate Engine RFK(EW10J4S)	GDS99019	Drive Shaft	29T	25	24	55.7	79	620	
	2006.06-	2007.01	MT	R	F	Estate Engine RFK(EW10J4S)	GDS10229	Drive Shaft		25	24	58.5	79	935	
2.0 HDi (100 kW)	2006.06-	2007.01			F	Estate Engine RHR(DW10BTED4)	GC010085	Outer Joint		25	39	59	89	63.5	I
	2006.06-	2007.01	6MT	L	F	Estate Engine RHR(DW10BTED4)	GDS10268	Drive Shaft		25	37	58.5	89	621	
	2006.06-	2007.01	MT	L	F	Estate Engine RHR(DW10BTED4)	GDS45105	Drive Shaft		25	24	58	79	625	









		TRANSM	L/R	F/R		G-AP Ref.	PRODUCT	ABS	Technical Specifications								
									YEAR	A	B	C	H	L	P		
<b>PEUGEOT</b>																	
<b>307 (3E)</b>																	
2.0 HDi (100 kW)	2006.06-	2007.01	MT	R	F	Estate Engine RHR(DW10BTED4)	GDS88082	Drive Shaft		25	37	58.5	89	949			
	2006.06-	2007.01	MT	R	F	Estate Engine RHR(DW10BTED4)	GDS45104	Drive Shaft		25	24	58	79	925			
	2006.06-	2007.01		R	F	Estate Engine RHR(DW10BTED4)	GDS10173	Drive Shaft	29W	25	24	58.5	79	921			
2.0 HDi (66 kW)	2002.03-	2005.03			F	Estate Engine RHY(DW10TD)	GC010028	Outer Joint		25	34	58	89	56	I		
	2002.03-	2005.03	MT	L	F	Estate Engine RHY(DW10TD)	GDS45105	Drive Shaft		25	24	58	79	625			
	2002.03-	2005.03	MT	R	F	Estate Engine RHY(DW10TD)	GDS45104	Drive Shaft		25	24	58	79	925			
	2002.03-	2005.03		R	F	Estate Engine RHY(DW10TD)	GDS10173	Drive Shaft	29W	25	24	58.5	79	921			
2.0 HDi (79 kW)	2002.03-				F	Estate Engine RHS(DW10ATED)	GC010028	Outer Joint		25	34	58	89	56	I		
	2002.03-		MT	L	F	Estate Engine RHS(DW10ATED)	GDS45105	Drive Shaft		25	24	58	79	625			
	2002.03-		MT	R	F	Estate Engine RHS(DW10ATED)	GDS45104	Drive Shaft		25	24	58	79	925			
	2002.03-		MT	L	F	Estate Engine RHS(DW10ATED)	GDS99019	Drive Shaft	29T	25	24	55.7	79	620			
	2002.03-		MT	R	F	Estate Engine RHS(DW10ATED)	GDS10229	Drive Shaft		25	24	58.5	79	935			
<b>307 (3H)</b>																	
1.4 16V (65 kW)	2003.11-				F	Estate Engine KFU(ET3J4)	GC010025	Outer Joint		25	22	60	80	54	I		
	2003.11-		MT	L	F	Estate Engine KFU(ET3J4)	GDS45119	Drive Shaft		25	22	58.5	79.5	633			
	2003.11-		MT	R	F	Estate Engine KFU(ET3J4)	GDS45113	Drive Shaft		25	22	58.5	79.5	915			
	2003.11-		MT	R	F	Estate Engine KFU(ET3J4)	GDS99170	Drive Shaft		25	22	60	80	910			
1.4 HDi (50 kW)	2002.03-	2005.01	MT	L	F	Estate Engine 8HZ(DV4TD)	GDS99019	Drive Shaft	29T	25	24	55.7	79	620			
	2002.03-	2005.01	MT	R	F	Estate Engine 8HZ(DV4TD)	GDS10229	Drive Shaft		25	24	58.5	79	935			
1.6 16V (80 kW)	2002.03-				F	Estate Engine NFU(TU5JP4)	GC010028	Outer Joint		25	34	58	89	56	I		
	2002.03-				F	Estate Engine NFU(TU5JP4)	GC010025	Outer Joint		25	22	60	80	54	I		
	2002.03-		MT	L	F	Estate Engine NFU(TU5JP4)	GDS45119	Drive Shaft		25	22	58.5	79.5	633			
	2002.03-		MT	L	F	Estate Engine NFU(TU5JP4)	GDS45126	Drive Shaft		25	24	58.5	89	630			
	2002.03-		MT	R	F	Estate Engine NFU(TU5JP4)	GDS45104	Drive Shaft		25	24	58	79	925			
	2002.03-		MT	R	F	Estate Engine NFU(TU5JP4)	GDS45113	Drive Shaft		25	22	58.5	79.5	915			
	2002.03-		AT	L	F	Estate Engine NFU(TU5JP4)	GDS10286	Drive Shaft		25	26	58.5	79	613			
	2002.03-		MT	L	F	Estate Engine NFU(TU5JP4)	GDS99019	Drive Shaft	29T	25	24	55.7	79	620			
	2002.03-		AT	R	F	Estate Engine NFU(TU5JP4)	GDS10291	Drive Shaft		25	26	58.5	79	833			
	2002.03-		MT	R	F	Estate Engine NFU(TU5JP4)	GDS10229	Drive Shaft		25	24	58.5	79	935			
	2002.03-		AT			Estate Engine NFU(TU5JP4)	GC099366	Outer Joint		25	34	58.5	79	55	I		
2002.03-					Estate Engine NFU(TU5JP4)	GC010097	Outer Joint		25	30	58.5	79.5	55	I			
1.6 HDi (66 kW)	2006.12-				F	Estate Engine 9HV(DV6ATED4)9HX(DV6ATED4)	GC010028	Outer Joint		25	34	58	89	56	I		
	2006.12-			L	F	Estate Engine 9HV(DV6ATED4)9HX(DV6ATED4)	GDS45105	Drive Shaft		25	24	58	79	625			
	2006.12-			R	F	Estate Engine 9HV(DV6ATED4)9HX(DV6ATED4)	GDS45104	Drive Shaft		25	24	58	79	925			
1.6 HDi (80 kW)	2004.04-	2007.03			F	Estate Engine 9HY(DV6TED4)9HZ(DV6TED4)	GC010028	Outer Joint		25	34	58	89	56	I		
	2004.04-	2007.03	MT	L	F	Estate Engine 9HY(DV6TED4)9HZ(DV6TED4)	GDS99019	Drive Shaft	29T	25	24	55.7	79	620			
	2004.04-	2007.03	MT	L	F	Estate Engine 9HY(DV6TED4)9HZ(DV6TED4)	GDS45105	Drive Shaft		25	24	58	79	625			
	2004.04-	2007.03	MT	R	F	Estate Engine 9HY(DV6TED4)9HZ(DV6TED4)	GDS10229	Drive Shaft		25	24	58.5	79	935			
	2004.04-	2007.03	MT	R	F	Estate Engine 9HY(DV6TED4)9HZ(DV6TED4)	GDS45104	Drive Shaft		25	24	58	79	925			
	2004.04-	2007.03		R	F	Estate Engine 9HY(DV6TED4)9HZ(DV6TED4)	GDS10173	Drive Shaft	29W	25	24	58.5	79	921			
2.0 16V (100 kW)	2002.03-				F	Estate Engine RFN(EW10J4)	GC010028	Outer Joint		25	34	58	89	56	I		
	2002.03-		MT	L	F	Estate Engine RFN(EW10J4)	GDS45126	Drive Shaft		25	24	58.5	89	630			
	2002.03-		MT	R	F	Estate Engine RFN(EW10J4)	GDS45104	Drive Shaft		25	24	58	79	925			
	2002.03-		AT	L	F	Estate Engine RFN(EW10J4)	GDS10286	Drive Shaft		25	26	58.5	79	613			
	2002.03-		MT	L	F	Estate Engine RFN(EW10J4)	GDS99019	Drive Shaft	29T	25	24	55.7	79	620			
	2002.03-		AT	R	F	Estate Engine RFN(EW10J4)	GDS10291	Drive Shaft		25	26	58.5	79	833			
	2002.03-		MT	R	F	Estate Engine RFN(EW10J4)	GDS10229	Drive Shaft		25	24	58.5	79	935			
2.0 16V (103 kW)	2005.04-	2006.05			F	Estate Engine RFJ(EW10A)	GC010028	Outer Joint		25	34	58	89	56	I		
	2005.04-	2006.05		L	F	Estate Engine RFJ(EW10A)	GDS45105	Drive Shaft		25	24	58	79	625			
	2005.04-	2006.05	AT	L	F	Estate Engine RFJ(EW10A)	GDS10286	Drive Shaft		25	26	58.5	79	613			
	2005.04-	2006.05	MT	L	F	Estate Engine RFJ(EW10A)	GDS99019	Drive Shaft	29T	25	24	55.7	79	620			
	2005.04-	2006.05		R	F	Estate Engine RFJ(EW10A)	GDS45104	Drive Shaft		25	24	58	79	925			
	2005.04-	2006.05	AT	R	F	Estate Engine RFJ(EW10A)	GDS10291	Drive Shaft		25	26	58.5	79	833			
	2005.04-	2006.05	MT	R	F	Estate Engine RFJ(EW10A)	GDS10229	Drive Shaft		25	24	58.5	79	935			
2.0 HDi (100 kW)	2004.04-	2007.03			F	Estate Engine RHR(DW10BTED4)	GC010085	Outer Joint		25	39	59	89	63.5	I		
	2004.04-	2007.03	6MT	L	F	Estate Engine RHR(DW10BTED4)	GDS10268	Drive Shaft		25	37	58.5	89	621			
	2004.04-	2007.03	MT	L	F	Estate Engine RHR(DW10BTED4)	GDS45105	Drive Shaft		25	24	58	79	625			
	2004.04-	2007.03	MT	R	F	Estate Engine RHR(DW10BTED4)	GDS88082	Drive Shaft		25	37	58.5	89	949			
	2004.04-	2007.03	MT	R	F	Estate Engine RHR(DW10BTED4)	GDS45104	Drive Shaft		25	24	58	79	925			
	2004.04-	2007.03	R	F	F	Estate Engine RHR(DW10BTED4)	GDS10173	Drive Shaft	29W	25	24	58.5	79	921			
2.0 HDi (66 kW)	2002.03-				F	Estate Engine RHY(DW10TD)	GC010028	Outer Joint		25	34	58	89	56	I		



	 YEAR	TRANSM	L/R	F/R		G-AP Ref.	PRODUCT	ABS	Technical Specifications									
									A	B	C	H	L	P				
<b>PEUGEOT</b>																		
<b>307 (3H)</b>																		
2.0 HDi (66 kW)	2002.03-		MT	L	F	Estate Engine RHY(DW10TD)	GDS45105	Drive Shaft		25	24	58	79	625				
	2002.03-		MT	R	F	Estate Engine RHY(DW10TD)	GDS45104	Drive Shaft		25	24	58	79	925				
	2002.03-		MT	L	F	Estate Engine RHY(DW10TD)	GDS99019	Drive Shaft	29T	25	24	55.7	79	620				
	2002.03-		MT	R	F	Estate Engine RHY(DW10TD)	GDS10229	Drive Shaft		25	24	58.5	79	935				
	2002.03-				R	F	Estate Engine RHY(DW10TD)	GDS10173	Drive Shaft	29W	25	24	58.5	79	921			
2.0 HDi (79 kW)	2002.03-				F	Estate Engine RHS(DW10ATED)	GC010028	Outer Joint		25	34	58	89	56	I			
	2002.03-		MT	L	F	Estate Engine RHS(DW10ATED)	GDS45105	Drive Shaft		25	24	58	79	625				
	2002.03-		MT	R	F	Estate Engine RHS(DW10ATED)	GDS45104	Drive Shaft		25	24	58	79	925				
	2002.03-		MT	L	F	Estate Engine RHS(DW10ATED)	GDS99019	Drive Shaft	29T	25	24	55.7	79	620				
	2002.03-		MT	R	F	Estate Engine RHS(DW10ATED)	GDS10229	Drive Shaft		25	24	58.5	79	935				
	2002.03-				R	F	Estate Engine RHS(DW10ATED)	GDS10173	Drive Shaft	29W	25	24	58.5	79	921			
<b>307 CC (3B)</b>																		
1.6 16V (80 kW)	2005.02-		5MT		F	Convertible Engine NFU(TU5JP4)	GC010028	Outer Joint		25	34	58	89	56	I			
	2005.02-		5MT		F	Convertible Engine NFU(TU5JP4)	GC010025	Outer Joint		25	22	60	80	54	I			
	2005.02-			L	F	Convertible Engine NFU(TU5JP4)	GDS45119	Drive Shaft		25	22	58.5	79.5	633				
	2005.02-			L	F	Convertible Engine NFU(TU5JP4)	GDS45126	Drive Shaft		25	24	58.5	89	630				
	2005.02-			R	F	Convertible Engine NFU(TU5JP4)	GDS45104	Drive Shaft		25	24	58	79	925				
	2005.02-			R	F	Convertible Engine NFU(TU5JP4)	GDS45113	Drive Shaft		25	22	58.5	79.5	915				
	2005.02-		AT	L	F	Convertible Engine NFU(TU5JP4)	GDS10286	Drive Shaft		25	26	58.5	79	613				
	2005.02-		MT	L	F	Convertible Engine NFU(TU5JP4)	GDS99019	Drive Shaft	29T	25	24	55.7	79	620				
	2005.02-		AT	R	F	Convertible Engine NFU(TU5JP4)	GDS10291	Drive Shaft		25	26	58.5	79	833				
	2005.02-		MT	R	F	Convertible Engine NFU(TU5JP4)	GDS10229	Drive Shaft		25	24	58.5	79	935				
	2005.02-		AT			Convertible Engine NFU(TU5JP4)	GC099366	Outer Joint		25	34	58.5	79	55	I			
2005.02-					Convertible Engine NFU(TU5JP4)	GC010097	Outer Joint		25	30	58.5	79.5	55	I				
2.0 16V (100 kW)	2003.10-				F	Convertible Engine RFN(EW10J4)	GC010028	Outer Joint		25	34	58	89	56	I			
	2003.10-		MT	L	F	Convertible Engine RFN(EW10J4)	GDS45126	Drive Shaft		25	24	58.5	89	630				
	2003.10-		MT	R	F	Convertible Engine RFN(EW10J4)	GDS45104	Drive Shaft		25	24	58	79	925				
	2003.10-		AT	L	F	Convertible Engine RFN(EW10J4)	GDS10286	Drive Shaft		25	26	58.5	79	613				
	2003.10-		MT	L	F	Convertible Engine RFN(EW10J4)	GDS99019	Drive Shaft	29T	25	24	55.7	79	620				
	2003.10-		AT	R	F	Convertible Engine RFN(EW10J4)	GDS10291	Drive Shaft		25	26	58.5	79	833				
	2003.10-		MT	R	F	Convertible Engine RFN(EW10J4)	GDS10229	Drive Shaft		25	24	58.5	79	935				
2.0 16V (103 kW)	2005.03-				F	Convertible Engine RFJ(EW10A)	GC010028	Outer Joint		25	34	58	89	56	I			
	2005.03-			L	F	Convertible Engine RFJ(EW10A)	GDS45105	Drive Shaft		25	24	58	79	625				
	2005.03-			R	F	Convertible Engine RFJ(EW10A)	GDS45104	Drive Shaft		25	24	58	79	925				
	2005.03-		AT	L	F	Convertible Engine RFJ(EW10A)	GDS10286	Drive Shaft		25	26	58.5	79	613				
	2005.03-		MT	L	F	Convertible Engine RFJ(EW10A)	GDS99019	Drive Shaft	29T	25	24	55.7	79	620				
	2005.03-		AT	R	F	Convertible Engine RFJ(EW10A)	GDS10291	Drive Shaft		25	26	58.5	79	833				
	2005.03-		MT	R	F	Convertible Engine RFJ(EW10A)	GDS10229	Drive Shaft		25	24	58.5	79	935				
2.0 16V (130 kW)	2003.10-				F	Convertible Engine RFK(EW10J4S)	GC010028	Outer Joint		25	34	58	89	56	I			
	2003.10-		MT	L	F	Convertible Engine RFK(EW10J4S)	GDS45126	Drive Shaft		25	24	58.5	89	630				
	2003.10-		MT	R	F	Convertible Engine RFK(EW10J4S)	GDS45104	Drive Shaft		25	24	58	79	925				
	2003.10-		MT	L	F	Convertible Engine RFK(EW10J4S)	GDS99019	Drive Shaft	29T	25	24	55.7	79	620				
	2003.10-		MT	R	F	Convertible Engine RFK(EW10J4S)	GDS10229	Drive Shaft		25	24	58.5	79	935				
2.0 HDi (100 kW)	2005.06-				F	Convertible Engine RHR(DW10BTED4)	GC010085	Outer Joint		25	39	59	89	63.5	I			
	2005.06-		MT	L	F	Convertible Engine RHR(DW10BTED4)	GDS10268	Drive Shaft		25	37	58.5	89	621				
	2005.06-		MT	R	F	Convertible Engine RHR(DW10BTED4)	GDS88082	Drive Shaft		25	37	58.5	89	949				
<b>308 (4A_, 4C_)</b>																		
1.4 16V (70 kW)	2007.09-				F	Hatchback Engine EP3/8FS(EP3)	GC010067	Outer Joint	48W	25	34	58.5	79	55	I			
	2007.09-			L	F	Hatchback Engine EP3/8FS(EP3)	GDS10250	Drive Shaft		25	24	58.5	79	634				
	2007.09-		MT	R	F	Hatchback Engine EP3/8FS(EP3)	GDS10251	Drive Shaft		25	24	58.5	79	935				
	2007.09-		6MT			Hatchback Engine EP3/8FS(EP3)	GC010155	Outer Joint		25	39	58.5	89	63.5	I			
1.4 16V (72 kW)	2009.12-					Hatchback	GC099366	Outer Joint		25	34	58.5	79	55	I			
	2009.12-		MT	R	F	Hatchback	GDS10251	Drive Shaft		25	24	58.5	79	935				
	2009.12-		6MT			Hatchback	GC010155	Outer Joint		25	39	58.5	89	63.5	I			
1.6 16V (103 kW)	2007.09-				F	Hatchback Engine 5FT(EP6DT)	GC010067	Outer Joint	48W	25	34	58.5	79	55	I			
	2007.09-		AT	L	F	Hatchback Engine 5FT(EP6DT)	GDS10362	Drive Shaft		25	26	58.5	79	624				
	2007.09-		AT	L	F	Hatchback Engine 5FT(EP6DT)	GC199001	Inner Joint		26	34	42.5	46.5	103.5				
	2007.09-		AT	L	F	Hatchback Engine 5FT(EP6DT)	GC099366	Outer Joint		25	34	58.5	79	55	I			
	2007.09-		AT	R	F	Hatchback Engine 5FT(EP6DT)	GDS10383	Drive Shaft		25	26	58	79	842				
	2007.09-		MT	R	F	Hatchback Engine 5FT(EP6DT)	GDS10251	Drive Shaft		25	24	58.5	79	935				
1.6 16V (110 kW)	2007.09-				F	Hatchback Engine 5FX(EP6DT)	GC010067	Outer Joint	48W	25	34	58.5	79	55	I			

	 YEAR	TRANSM	L/R	F/R		G-AP Ref.	PRODUCT	ABS	Technical Specifications									
									A	B	C	H	L	P				
<b>PEUGEOT</b> <b>308 (4A_, 4C_)</b>																		
1.6 16V (110 kW)	2007.09-	AT	L	F	Hatchback Engine 5FX(EP6DT)	GDS10362	Drive Shaft		25	26	58.5	79	624					
	2007.09-	AT	L	F	Hatchback Engine 5FX(EP6DT)	GCI99001	Inner Joint		26	34	42.5	46.5	103.5					
	2007.09-	AT	L	F	Hatchback Engine 5FX(EP6DT)	GC099366	Outer Joint		25	34	58.5	79	55	I				
	2007.09-	MT	L	F	Hatchback Engine 5FX(EP6DT)	GDS10253	Drive Shaft		25	24	58.5	79	626					
	2007.09-	MT	L	F	Hatchback Engine 5FX(EP6DT)	GCI10057	Inner Joint		24	34	40	52.5	90					
	2007.09-	MT	L/R	F	Hatchback Engine 5FX(EP6DT)	GC010148	Outer Joint		25	34	58.5	79	55.5	I				
	2007.09-	AT	R	F	Hatchback Engine 5FX(EP6DT)	GDS10383	Drive Shaft		25	26	58	79	842					
	2007.09-	MT	R	F	Hatchback Engine 5FX(EP6DT)	GDS10251	Drive Shaft		25	24	58.5	79	935					
1.6 16V (115 kW)	2009.10-	MT	L	F	Hatchback Engine EP6CDT	GDS10253	Drive Shaft		25	24	58.5	79	626					
	2009.10-	MT	L	F	Hatchback Engine EP6CDT	GCI10057	Inner Joint		24	34	40	52.5	90					
	2009.10-	MT	L/R	F	Hatchback Engine EP6CDT	GC010148	Outer Joint		25	34	58.5	79	55.5	I				
	2009.10-	MT	R	F	Hatchback Engine EP6CDT	GDS10325	Drive Shaft		25	24	58.5	79	940					
	2009.10-	MT	R	F	Hatchback Engine EP6CDT	GCI10058	Inner Joint		24	34	29.8	365	88					
	2009.10-	6MT			Hatchback Engine EP6CDT	GC010155	Outer Joint		25	39	58.5	89	63.5	I				
	2009.10-	AT			Hatchback Engine EP6CDT	GC099366	Outer Joint		25	34	58.5	79	55	I				
1.6 16V (128 kW)	2008.03-			F	Hatchback Engine 5FY(EP6DTS)	GC010067	Outer Joint	48W	25	34	58.5	79	55	I				
	2008.03-	AT	L	F	Hatchback Engine 5FY(EP6DTS)	GDS10362	Drive Shaft		25	26	58.5	79	624					
	2008.03-	AT	L	F	Hatchback Engine 5FY(EP6DTS)	GCI99001	Inner Joint		26	34	42.5	46.5	103.5					
	2008.03-	AT	L	F	Hatchback Engine 5FY(EP6DTS)	GC099366	Outer Joint		25	34	58.5	79	55	I				
	2008.03-		L	F	Hatchback Engine 5FY(EP6DTS)	GDS10253	Drive Shaft		25	24	58.5	79	626					
	2008.03-		L	F	Hatchback Engine 5FY(EP6DTS)	GCI10057	Inner Joint		24	34	40	52.5	90					
	2008.03-		L	F	Hatchback Engine 5FY(EP6DTS)	GC010148	Outer Joint		25	34	58.5	79	55.5	I				
	2008.03-	AT	R	F	Hatchback Engine 5FY(EP6DTS)	GDS10383	Drive Shaft		25	26	58	79	842					
	2008.03-	MT	R	F	Hatchback Engine 5FY(EP6DTS)	GDS10325	Drive Shaft		25	24	58.5	79	940					
	2008.03-	MT	R	F	Hatchback Engine 5FY(EP6DTS)	GCI10058	Inner Joint		24	34	29.8	365	88					
1.6 16V (88 kW)	2007.09-			F	Hatchback Engine EP6	GC010067	Outer Joint	48W	25	34	58.5	79	55	I				
	2007.09-	AT	L	F	Hatchback Engine EP6	GDS10362	Drive Shaft		25	26	58.5	79	624					
	2007.09-	AT	L	F	Hatchback Engine EP6	GCI99001	Inner Joint		26	34	42.5	46.5	103.5					
	2007.09-	AT	L	F	Hatchback Engine EP6	GC099366	Outer Joint		25	34	58.5	79	55	I				
	2007.09-	MT	L	F	Hatchback Engine EP6	GDS10250	Drive Shaft		25	24	58.5	79	634					
	2007.09-	AT	R	F	Hatchback Engine EP6	GDS10383	Drive Shaft		25	26	58	79	842					
	2007.09-	MT	R	F	Hatchback Engine EP6	GDS10251	Drive Shaft		25	24	58.5	79	935					
	2007.09-	6MT			Hatchback Engine EP6	GC010155	Outer Joint		25	39	58.5	89	63.5	I				
1.6 BioFlex (80 kW)	2008.04-			R	F	Hatchback Engine NFU(TU5JP4)	GDS10251	Drive Shaft		25	24	58.5	79	935				
1.6 GTi (147 kW)	2010.07-	6MT			Hatchback Engine EP6CDTX	GC010155	Outer Joint		25	39	58.5	89	63.5	I				
	2010.07-	AT			Hatchback Engine EP6CDTX	GC099366	Outer Joint		25	34	58.5	79	55	I				
1.6 HDi (66 kW)	2007.09-			F	Hatchback	GC010067	Outer Joint	48W	25	34	58.5	79	55	I				
	2007.09-		L	F	Hatchback	GDS10250	Drive Shaft		25	24	58.5	79	634					
	2007.09-	MT	R	F	Hatchback	GDS10251	Drive Shaft		25	24	58.5	79	935					
	2007.09-	6MT			Hatchback	GC010155	Outer Joint		25	39	58.5	89	63.5	I				
1.6 HDi (68 kW)	2009.11-			R	F	Hatchback Engine 9HP(DV6DTE4)	GDS10251	Drive Shaft		25	24	58.5	79	935				
	2009.11-	6MT			Hatchback Engine 9HP(DV6DTE4)	GC010155	Outer Joint		25	39	58.5	89	63.5	I				
	2009.11-	AT			Hatchback Engine 9HP(DV6DTE4)	GC099366	Outer Joint		25	34	58.5	79	55	I				
1.6 HDi (80 kW)	2007.09-			F	Hatchback Engine 9HZ(DV6TED4)	GC010067	Outer Joint	48W	25	34	58.5	79	55	I				
	2007.09-		L	F	Hatchback Engine 9HZ(DV6TED4)	GDS10253	Drive Shaft		25	24	58.5	79	626					
	2007.09-		L	F	Hatchback Engine 9HZ(DV6TED4)	GCI10057	Inner Joint		24	34	40	52.5	90					
	2007.09-		L	F	Hatchback Engine 9HZ(DV6TED4)	GC010148	Outer Joint		25	34	58.5	79	55.5	I				
	2007.09-	MT	R	F	Hatchback Engine 9HZ(DV6TED4)	GDS10251	Drive Shaft		25	24	58.5	79	935					
	2007.09-	MT	R	F	Hatchback Engine 9HZ(DV6TED4)	GCI10058	Inner Joint		24	34	29.8	365	88					
	2007.09-	MT	R	F	Hatchback Engine 9HZ(DV6TED4)	GC010148	Outer Joint		25	34	58.5	79	55.5	I				
1.6 HDi (82 kW)	2009.12-			L	F	Hatchback Engine 9HR(DV6C)	GDS10253	Drive Shaft		25	24	58.5	79	626				
	2009.12-			L	F	Hatchback Engine 9HR(DV6C)	GCI10057	Inner Joint		24	34	40	52.5	90				
	2009.12-			L	F	Hatchback Engine 9HR(DV6C)	GC010148	Outer Joint		25	34	58.5	79	55.5	I			
	2009.12-	MT	R	F	Hatchback Engine 9HR(DV6C)	GDS10325	Drive Shaft		25	24	58.5	79	940					
	2009.12-	MT	R	F	Hatchback Engine 9HR(DV6C)	GCI10058	Inner Joint		24	34	29.8	365	88					
	2009.12-	MT	R	F	Hatchback Engine 9HR(DV6C)	GC010148	Outer Joint		25	34	58.5	79	55.5	I				
	2009.12-	6MT			Hatchback Engine 9HR(DV6C)	GC010155	Outer Joint		25	39	58.5	89	63.5	I				
1.6 HDi (84 kW)	2013.03-			L	F	Hatchback	GC099366	Outer Joint		25	34	58.5	79	55	I			
	2013.03-			L	F	Hatchback	GDS10253	Drive Shaft		25	24	58.5	79	626				









		TRANSM	L/R	F/R		G-AP Ref.	PRODUCT	ABS	Technical Specifications						
									YEAR	A	B	C	H	L	P
<b>PEUGEOT</b>															
<b>308 (4A_, 4C_)</b>															
1.6 HDi (84 kW)	2013.03-			L	F	Hatchback	GCI10057	Inner Joint		24	34	40	52.5	90	
	2013.03-			L/R	F	Hatchback	GC010148	Outer Joint		25	34	58.5	79	55.5	I
	2013.03-			R	F	Hatchback	GDS10325	Drive Shaft		25	24	58.5	79	940	
	2013.03-			R	F	Hatchback	GCI10058	Inner Joint		24	34	29.8	365	88	
2.0 HDi (100 kW)	2007.09-				F	Hatchback Engine RHR(DW10BTED4)	GC010067	Outer Joint	48W	25	34	58.5	79	55	I
	2007.09-		6MT	L	F	Hatchback Engine RHR(DW10BTED4)	GDS10427	Drive Shaft		25	37	58.5	89	638	
	2007.09-		AT	L	F	Hatchback Engine RHR(DW10BTED4)	GDS10380	Drive Shaft		25	37	58.5	89	635	
	2007.09-		MT	L	F	Hatchback Engine RHR(DW10BTED4)	GDS10210	Drive Shaft		25	37	58.5	89	638	
	2007.09-		AT	R	F	Hatchback Engine RHR(DW10BTED4)	GDS10363	Drive Shaft		25	37	58.5	89	935	
	2007.09-		AT	R	F	Hatchback Engine RHR(DW10BTED4)	GCI10091	Inner Joint		37	26	31.5	366	100	
	2007.09-		AT	R	F	Hatchback Engine RHR(DW10BTED4)	GC010158	Outer Joint		25	26	58.5	89	61.5	M
	2007.09-		MT	R	F	Hatchback Engine RHR(DW10BTED4)	GDS10361	Drive Shaft		25	37	58.5	89	959	
2.0 HDi (103 kW)	2010.07-		6MT	L	F	Hatchback Engine RHR(DW10BTED4)	GDS10427	Drive Shaft		25	37	58.5	89	638	
	2010.07-		AT	L	F	Hatchback Engine RHR(DW10BTED4)	GDS10380	Drive Shaft		25	37	58.5	89	635	
	2010.07-		MT	L	F	Hatchback Engine RHR(DW10BTED4)	GDS10210	Drive Shaft		25	37	58.5	89	638	
	2010.07-		AT	R	F	Hatchback Engine RHR(DW10BTED4)	GDS10363	Drive Shaft		25	37	58.5	89	935	
	2010.07-		AT	R	F	Hatchback Engine RHR(DW10BTED4)	GCI10091	Inner Joint		37	26	31.5	366	100	
	2010.07-		AT	R	F	Hatchback Engine RHR(DW10BTED4)	GC010158	Outer Joint		25	26	58.5	89	61.5	M
	2010.07-		MT	R	F	Hatchback Engine RHR(DW10BTED4)	GDS10361	Drive Shaft		25	37	58.5	89	959	
	2010.07-		6MT			Hatchback Engine RHR(DW10BTED4)	GC010155	Outer Joint		25	39	58.5	89	63.5	I
2.0 HDi (110 kW)	2011.10-		AT	L	F	Hatchback Engine RHE(DW10CTED4)	GDS10380	Drive Shaft		25	37	58.5	89	635	
	2011.10-		MT	L	F	Hatchback Engine RHE(DW10CTED4)	GDS10427	Drive Shaft		25	37	58.5	89	638	
	2011.10-		AT	R	F	Hatchback Engine RHE(DW10CTED4)	GDS10363	Drive Shaft		25	37	58.5	89	935	
	2011.10-		AT	R	F	Hatchback Engine RHE(DW10CTED4)	GCI10091	Inner Joint		37	26	31.5	366	100	
	2011.10-		AT	R	F	Hatchback Engine RHE(DW10CTED4)	GC010158	Outer Joint		25	26	58.5	89	61.5	M
	2011.10-		MT	R	F	Hatchback Engine RHE(DW10CTED4)	GDS10361	Drive Shaft		25	37	58.5	89	959	
	2011.10-		AT			Hatchback Engine RHE(DW10CTED4)	GC099366	Outer Joint		25	34	58.5	79	55	I
2.0 HDi (120 kW)	2012.04-		MT	L	F	Hatchback Engine RHH(DW10CTED4)	GDS10210	Drive Shaft		25	37	58.5	89	638	
	2012.04-			L	F	Hatchback Engine RHH(DW10CTED4)	GDS10380	Drive Shaft		25	37	58.5	89	635	
	2012.04-		MT	R	F	Hatchback Engine RHH(DW10CTED4)	GDS10361	Drive Shaft		25	37	58.5	89	959	
	2012.04-			R	F	Hatchback Engine RHH(DW10CTED4)	GDS10363	Drive Shaft		25	37	58.5	89	935	
	2012.04-			R	F	Hatchback Engine RHH(DW10CTED4)	GCI10091	Inner Joint		37	26	31.5	366	100	
	2012.04-			R	F	Hatchback Engine RHH(DW10CTED4)	GC010158	Outer Joint		25	26	58.5	89	61.5	M
	2012.04-		5MT			Hatchback Engine RHH(DW10CTED4)	GC010155	Outer Joint		25	39	58.5	89	63.5	I
	2012.04-		AT			Hatchback Engine RHH(DW10CTED4)	GC099366	Outer Joint		25	34	58.5	79	55	I
<b>308 CC</b>															
1.6 16V (103 kW)	2009.06-		AT	L	F	Convertible Engine 5FT(EP6DT)	GDS10362	Drive Shaft		25	26	58.5	79	624	
	2009.06-		AT	L	F	Convertible Engine 5FT(EP6DT)	GCI99001	Inner Joint		26	34	42.5	46.5	103.5	
	2009.06-		AT	L	F	Convertible Engine 5FT(EP6DT)	GC099366	Outer Joint		25	34	58.5	79	55	I
	2009.06-			L	F	Convertible Engine 5FT(EP6DT)	GDS10253	Drive Shaft		25	24	58.5	79	626	
	2009.06-			L	F	Convertible Engine 5FT(EP6DT)	GCI10057	Inner Joint		24	34	40	52.5	90	
	2009.06-			L	F	Convertible Engine 5FT(EP6DT)	GC010148	Outer Joint		25	34	58.5	79	55.5	I
	2009.06-		AT	R	F	Convertible Engine 5FT(EP6DT)	GDS10383	Drive Shaft		25	26	58	79	842	
	2009.06-		MT	R	F	Convertible Engine 5FT(EP6DT)	GDS10325	Drive Shaft		25	24	58.5	79	940	
	2009.06-		MT	R	F	Convertible Engine 5FT(EP6DT)	GCI10058	Inner Joint		24	34	29.8	365	88	
	2009.06-		MT	R	F	Convertible Engine 5FT(EP6DT)	GC010148	Outer Joint		25	34	58.5	79	55.5	I
	2009.06-		MT/6MT			Convertible Engine 5FT(EP6DT)	GC099366	Outer Joint		25	34	58.5	79	55	I
1.6 16V (110 kW)	2009.06-		AT	L	F	Convertible Engine 5FX(EP6DT)	GDS10362	Drive Shaft		25	26	58.5	79	624	
	2009.06-		AT	L	F	Convertible Engine 5FX(EP6DT)	GCI99001	Inner Joint		26	34	42.5	46.5	103.5	
	2009.06-		AT	L	F	Convertible Engine 5FX(EP6DT)	GC099366	Outer Joint		25	34	58.5	79	55	I
	2009.06-		MT	L	F	Convertible Engine 5FX(EP6DT)	GDS10253	Drive Shaft		25	24	58.5	79	626	
	2009.06-		MT	L	F	Convertible Engine 5FX(EP6DT)	GCI10057	Inner Joint		24	34	40	52.5	90	
	2009.06-		MT	L/R	F	Convertible Engine 5FX(EP6DT)	GC010148	Outer Joint		25	34	58.5	79	55.5	I
	2009.06-		AT	R	F	Convertible Engine 5FX(EP6DT)	GDS10383	Drive Shaft		25	26	58	79	842	
	2009.06-		MT	R	F	Convertible Engine 5FX(EP6DT)	GDS10325	Drive Shaft		25	24	58.5	79	940	
	2009.06-		MT	R	F	Convertible Engine 5FX(EP6DT)	GCI10058	Inner Joint		24	34	29.8	365	88	
	2009.06-		MT/6MT			Convertible Engine 5FX(EP6DT)	GC099366	Outer Joint		25	34	58.5	79	55	I
1.6 16V (115 kW)	2009.06-		MT	L	F	Convertible Engine EP6CDT	GDS10253	Drive Shaft		25	24	58.5	79	626	
	2009.06-		MT	L	F	Convertible Engine EP6CDT	GCI10057	Inner Joint		24	34	40	52.5	90	
	2009.06-		MT	L/R	F	Convertible Engine EP6CDT	GC010148	Outer Joint		25	34	58.5	79	55.5	I
	2009.06-		MT	R	F	Convertible Engine EP6CDT	GDS10325	Drive Shaft		25	24	58.5	79	940	

		TRANSM	L/R	F/R		G-AP Ref.	PRODUCT	ABS	Technical Specifications												
									YEAR	A	B	C	H	L	P						
<b>PEUGEOT</b>																					
<b>308 CC</b>																					
1.6 16V (115 kW)	2009.06-		MT	R	F	Convertible Engine EP6CDT	GCI10058	Inner Joint		24	34	29.8	365	88							
	2009.06-		MT/6MT			Convertible Engine EP6CDT	GC099366	Outer Joint		25	34	58.5	79	55	I						
1.6 16V (88 kW)	2009.06-				F	Convertible Engine EP6	GC010067	Outer Joint	48W	25	34	58.5	79	55	I						
	2009.06-		AT	L	F	Convertible Engine EP6	GDS10362	Drive Shaft		25	26	58.5	79	624							
	2009.06-		AT	L	F	Convertible Engine EP6	GCI99001	Inner Joint		26	34	42.5	46.5	103.5							
	2009.06-		AT	L	F	Convertible Engine EP6	GC099366	Outer Joint		25	34	58.5	79	55	I						
	2009.06-				L	F	Convertible Engine EP6	GDS10250	Drive Shaft		25	24	58.5	79	634						
	2009.06-		AT	R	F	Convertible Engine EP6	GDS10383	Drive Shaft		25	26	58	79	842							
	2009.06-		MT	R	F	Convertible Engine EP6	GDS10251	Drive Shaft		25	24	58.5	79	935							
1.6 HDi (82 kW)	2009.06-				L	F	Convertible Engine Engine9HR(DV6C)	GDS10253	Drive Shaft		25	24	58.5	79	626						
	2009.06-				L	F	Convertible Engine Engine9HR(DV6C)	GCI10057	Inner Joint		24	34	40	52.5	90						
	2009.06-				L	F	Convertible Engine Engine9HR(DV6C)	GC010148	Outer Joint		25	34	58.5	79	55.5	I					
	2009.06-		MT	R	F	Convertible Engine Engine9HR(DV6C)	GDS10325	Drive Shaft		25	24	58.5	79	940							
	2009.06-		MT	R	F	Convertible Engine Engine9HR(DV6C)	GCI10058	Inner Joint		24	34	29.8	365	88							
	2009.06-		MT	R	F	Convertible Engine Engine9HR(DV6C)	GC010148	Outer Joint		25	34	58.5	79	55.5	I						
1.6 HDi (84 kW)	2013.03-				L	F	Convertible	GDS10253	Drive Shaft		25	24	58.5	79	626						
	2013.03-				L	F	Convertible	GCI10057	Inner Joint		24	34	40	52.5	90						
	2013.03-				L/R	F	Convertible	GC010148	Outer Joint		25	34	58.5	79	55.5	I					
	2013.03-				R	F	Convertible	GDS10325	Drive Shaft		25	24	58.5	79	940						
	2013.03-				R	F	Convertible	GCI10058	Inner Joint		24	34	29.8	365	88						
	2013.03-		MT/6MT				Convertible	GC010155	Outer Joint		25	39	58.5	89	63.5	I					
1.6 THP (147 kW)	2010.10-		MT	L	F	Convertible Engine EP6CDTX	GDS10250	Drive Shaft		25	24	58.5	79	634							
	2010.10-		MT/6MT			Convertible Engine EP6CDTX	GC099366	Outer Joint		25	34	58.5	79	55	I						
2.0 HDi (100 kW)	2009.04-		6MT	L	F	Convertible Engine RHR(DW10BTED4)	GDS10427	Drive Shaft		25	37	58.5	89	638							
	2009.04-		AT	L	F	Convertible Engine RHR(DW10BTED4)	GDS10380	Drive Shaft		25	37	58.5	89	635							
	2009.04-		MT	L	F	Convertible Engine RHR(DW10BTED4)	GDS10210	Drive Shaft		25	37	58.5	89	638							
	2009.04-		AT	R	F	Convertible Engine RHR(DW10BTED4)	GDS10363	Drive Shaft		25	37	58.5	89	935							
	2009.04-		AT	R	F	Convertible Engine RHR(DW10BTED4)	GCI10091	Inner Joint		37	26	31.5	366	100							
	2009.04-		AT	R	F	Convertible Engine RHR(DW10BTED4)	GC010158	Outer Joint		25	26	58.5	89	61.5	M						
	2009.04-		MT	R	F	Convertible Engine RHR(DW10BTED4)	GDS10361	Drive Shaft		25	37	58.5	89	959							
2.0 HDi (103 kW)	2009.04-		MT/6MT			Convertible Engine RHR(DW10BTED4)	GC099366	Outer Joint		25	34	58.5	79	55	I						
	2009.04-		6MT	L	F	Convertible Engine RHF(DW10BTED4)	GDS10427	Drive Shaft		25	37	58.5	89	638							
	2009.04-		AT	L	F	Convertible Engine RHF(DW10BTED4)	GDS10380	Drive Shaft		25	37	58.5	89	635							
	2009.04-		MT	L	F	Convertible Engine RHF(DW10BTED4)	GDS10210	Drive Shaft		25	37	58.5	89	638							
	2009.04-		AT	R	F	Convertible Engine RHF(DW10BTED4)	GDS10363	Drive Shaft		25	37	58.5	89	935							
	2009.04-		AT	R	F	Convertible Engine RHF(DW10BTED4)	GCI10091	Inner Joint		37	26	31.5	366	100							
	2009.04-		AT	R	F	Convertible Engine RHF(DW10BTED4)	GC010158	Outer Joint		25	26	58.5	89	61.5	M						
2.0 HDi (120 kW)	2009.04-		MT	R	F	Convertible Engine RHF(DW10BTED4)	GDS10361	Drive Shaft		25	37	58.5	89	959							
	2009.04-					Convertible Engine RHF(DW10BTED4)	GC010155	Outer Joint		25	39	58.5	89	63.5	I						
	2009.06-		AT	L	F	Convertible Engine RHH(DW10CTED4)	GDS10380	Drive Shaft		25	37	58.5	89	635							
	2009.06-		MT	L	F	Convertible Engine RHH(DW10CTED4)	GDS10210	Drive Shaft		25	37	58.5	89	638							
	2009.06-		AT	R	F	Convertible Engine RHH(DW10CTED4)	GDS10363	Drive Shaft		25	37	58.5	89	935							
	2009.06-		AT	R	F	Convertible Engine RHH(DW10CTED4)	GCI10091	Inner Joint		37	26	31.5	366	100							
308 SW	2009.06-		AT	R	F	Convertible Engine RHH(DW10CTED4)	GC010158	Outer Joint		25	26	58.5	89	61.5	M						
	2009.06-		MT	R	F	Convertible Engine RHH(DW10CTED4)	GDS10361	Drive Shaft		25	37	58.5	89	959							
	2009.06-		MT/6MT			Convertible Engine RHH(DW10CTED4)	GC099366	Outer Joint		25	34	58.5	79	55	I						
	<b>1.4 16V (70 kW)</b>																				
	1.4 16V (70 kW)	2007.09-				F	Estate Engine 8FS(EP3)	GC010067	Outer Joint	48W	25	34	58.5	79	55	I					
		2007.09-				L	F	Estate Engine 8FS(EP3)	GDS10250	Drive Shaft		25	24	58.5	79	634					
2007.09-			MT	R	F	Estate Engine 8FS(EP3)	GDS10251	Drive Shaft		25	24	58.5	79	935							
2007.09-			6MT			Estate Engine 8FS(EP3)	GC010155	Outer Joint		25	39	58.5	89	63.5	I						
1.4 16V (72 kW)	2009.12-				F	Estate	GC010067	Outer Joint	48W	25	34	58.5	79	55	I						
	2009.12-		MT	R	F	Estate	GDS10251	Drive Shaft		25	24	58.5	79	935							
	2009.12-		6MT			Estate	GC010155	Outer Joint		25	39	58.5	89	63.5	I						
1.6 16V (103 kW)	2007.09-		AT	L	F	Estate Engine 5FT(EP6DT)	GDS10362	Drive Shaft		25	26	58.5	79	624							
	2007.09-		AT	L	F	Estate Engine 5FT(EP6DT)	GCI99001	Inner Joint		26	34	42.5	46.5	103.5							
	2007.09-		AT	L	F	Estate Engine 5FT(EP6DT)	GC099366	Outer Joint		25	34	58.5	79	55	I						
	2007.09-		AT	R	F	Estate Engine 5FT(EP6DT)	GDS10383	Drive Shaft		25	26	58	79	842							
	2007.09-		MT	R	F	Estate Engine 5FT(EP6DT)	GDS10251	Drive Shaft		25	24	58.5	79	935							
	2007.09-		MT/6MT			Estate Engine 5FT(EP6DT)	GC099366	Outer Joint		25	34	58.5	79	55	I						
1.6 16V (110 kW)	2007.09-				F	Estate Engine 5FX(EP6DT)	GC010067	Outer Joint	48W	25	34	58.5	79	55	I						



		TRANSM	L/R	F/R		G-AP Ref.	PRODUCT	ABS	Technical Specifications								
									YEAR	A	B	C	H	L	P		
<b>PEUGEOT</b>																	
<b>308 SW</b>																	
1.6 16V (110 kW)	2007.09-		AT	L	F	Estate Engine 5FX(EP6DT)	GDS10362	Drive Shaft		25	26	58.5	79	624			
	2007.09-		AT	L	F	Estate Engine 5FX(EP6DT)	GCI99001	Inner Joint		26	34	42.5	46.5	103.5			
	2007.09-		AT	L	F	Estate Engine 5FX(EP6DT)	GC099366	Outer Joint		25	34	58.5	79	55	I		
	2007.09-			L	F	Estate Engine 5FX(EP6DT)	GDS10253	Drive Shaft		25	24	58.5	79	626			
	2007.09-			L	F	Estate Engine 5FX(EP6DT)	GCI10057	Inner Joint		24	34	40	52.5	90			
	2007.09-			L	F	Estate Engine 5FX(EP6DT)	GC010148	Outer Joint		25	34	58.5	79	55.5	I		
	2007.09-		AT	R	F	Estate Engine 5FX(EP6DT)	GDS10383	Drive Shaft		25	26	58	79	842			
	2007.09-		MT	R	F	Estate Engine 5FX(EP6DT)	GDS10325	Drive Shaft		25	24	58.5	79	940			
	2007.09-		MT	R	F	Estate Engine 5FX(EP6DT)	GCI10058	Inner Joint		24	34	29.8	365	88			
2007.09-		MT	R	F	Estate Engine 5FX(EP6DT)	GC010148	Outer Joint		25	34	58.5	79	55.5	I			
1.6 16V (115 kW)	2009.10-		MT	L	F	Estate Engine EP6CDT	GDS10253	Drive Shaft		25	24	58.5	79	626			
	2009.10-		MT	L	F	Estate Engine EP6CDT	GCI10057	Inner Joint		24	34	40	52.5	90			
	2009.10-		MT	L/R	F	Estate Engine EP6CDT	GC010148	Outer Joint		25	34	58.5	79	55.5	I		
	2009.10-		MT	R	F	Estate Engine EP6CDT	GDS10325	Drive Shaft		25	24	58.5	79	940			
	2009.10-		MT	R	F	Estate Engine EP6CDT	GCI10058	Inner Joint		24	34	29.8	365	88			
	2009.10-		6MT			Estate Engine EP6CDT	GC010155	Outer Joint		25	39	58.5	89	63.5	I		
2009.10-		AT			Estate Engine EP6CDT	GC099366	Outer Joint		25	34	58.5	79	55	I			
1.6 16V (128 kW)	2008.03-				F	Estate Engine 5FY(EP6DTS)	GC010067	Outer Joint	48W	25	34	58.5	79	55	I		
	2008.03-		AT	L	F	Estate Engine 5FY(EP6DTS)	GDS10362	Drive Shaft		25	26	58.5	79	624			
	2008.03-		AT	L	F	Estate Engine 5FY(EP6DTS)	GCI99001	Inner Joint		26	34	42.5	46.5	103.5			
	2008.03-		AT	L	F	Estate Engine 5FY(EP6DTS)	GC099366	Outer Joint		25	34	58.5	79	55	I		
	2008.03-			L	F	Estate Engine 5FY(EP6DTS)	GDS10253	Drive Shaft		25	24	58.5	79	626			
	2008.03-			L	F	Estate Engine 5FY(EP6DTS)	GCI10057	Inner Joint		24	34	40	52.5	90			
	2008.03-			L	F	Estate Engine 5FY(EP6DTS)	GC010148	Outer Joint		25	34	58.5	79	55.5	I		
	2008.03-		AT	R	F	Estate Engine 5FY(EP6DTS)	GDS10383	Drive Shaft		25	26	58	79	842			
	2008.03-		MT	R	F	Estate Engine 5FY(EP6DTS)	GDS10325	Drive Shaft		25	24	58.5	79	940			
2008.03-		MT	R	F	Estate Engine 5FY(EP6DTS)	GCI10058	Inner Joint		24	34	29.8	365	88				
2008.03-		MT	R	F	Estate Engine 5FY(EP6DTS)	GC010148	Outer Joint		25	34	58.5	79	55.5	I			
1.6 16V (88 kW)	2007.09-				F	Estate Engine EP6	GC010067	Outer Joint	48W	25	34	58.5	79	55	I		
	2007.09-		AT	L	F	Estate Engine EP6	GDS10362	Drive Shaft		25	26	58.5	79	624			
	2007.09-		AT	L	F	Estate Engine EP6	GCI99001	Inner Joint		26	34	42.5	46.5	103.5			
	2007.09-		AT	L	F	Estate Engine EP6	GC099366	Outer Joint		25	34	58.5	79	55	I		
	2007.09-			L	F	Estate Engine EP6	GDS10250	Drive Shaft		25	24	58.5	79	634			
	2007.09-		AT	R	F	Estate Engine EP6	GDS10383	Drive Shaft		25	26	58	79	842			
	2007.09-		MT	R	F	Estate Engine EP6	GDS10251	Drive Shaft		25	24	58.5	79	935			
	2007.09-		6MT			Estate Engine EP6	GC010155	Outer Joint		25	39	58.5	89	63.5	I		
1.6 Bioflex (82 kW)	2009.03-				F	Estate Engine NFU(TU5JP4)	GC010067	Outer Joint	48W	25	34	58.5	79	55	I		
	2009.03-			L	F	Estate Engine NFU(TU5JP4)	GDS10253	Drive Shaft		25	24	58.5	79	626			
	2009.03-			L	F	Estate Engine NFU(TU5JP4)	GCI10057	Inner Joint		24	34	40	52.5	90			
	2009.03-			L	F	Estate Engine NFU(TU5JP4)	GC010148	Outer Joint		25	34	58.5	79	55.5	I		
	2009.03-			R	F	Estate Engine NFU(TU5JP4)	GDS10325	Drive Shaft		25	24	58.5	79	940			
	2009.03-			R	F	Estate Engine NFU(TU5JP4)	GCI10058	Inner Joint		24	34	29.8	365	88			
	2009.03-			R	F	Estate Engine NFU(TU5JP4)	GC010148	Outer Joint		25	34	58.5	79	55.5	I		
1.6 HDi (66 kW)	2007.09-				F	Estate Engine 9HV(DV6ATED4)/9HX(DV6ATED4)	GC010067	Outer Joint	48W	25	34	58.5	79	55	I		
	2007.09-			L	F	Estate Engine 9HV(DV6ATED4)/9HX(DV6ATED4)	GDS10250	Drive Shaft		25	24	58.5	79	634			
	2007.09-		MT	R	F	Estate Engine 9HV(DV6ATED4)/9HX(DV6ATED4)	GDS10251	Drive Shaft		25	24	58.5	79	935			
	2007.09-		6MT			Estate Engine 9HV(DV6ATED4)/9HX(DV6ATED4)	GC010155	Outer Joint		25	39	58.5	89	63.5	I		
1.6 HDi (68 kW)	2009.11-			R	F	Estate Engine 9HP(DV6DTEDE)	GDS10251	Drive Shaft		25	24	58.5	79	935			
	2009.11-		6MT			Estate Engine 9HP(DV6DTEDE)	GC010155	Outer Joint		25	39	58.5	89	63.5	I		
	2009.11-		AT			Estate Engine 9HP(DV6DTEDE)	GC099366	Outer Joint		25	34	58.5	79	55	I		
1.6 HDi (80 kW)	2007.09-				F	Estate Engine 9HZ(DV6TED4)	GC010067	Outer Joint	48W	25	34	58.5	79	55	I		
	2007.09-		MT	L	F	Estate Engine 9HZ(DV6TED4)	GDS10250	Drive Shaft		25	24	58.5	79	634			
	2007.09-		MT	R	F	Estate Engine 9HZ(DV6TED4)	GDS10251	Drive Shaft		25	24	58.5	79	935			
1.6 HDi (82 kW)	2009.12-		MT	L	F	Estate Engine 9HR(DV6C)	GDS10250	Drive Shaft		25	24	58.5	79	634			
	2009.12-		MT	R	F	Estate Engine 9HR(DV6C)	GDS10251	Drive Shaft		25	24	58.5	79	935			
	2009.12-		6MT			Estate Engine 9HR(DV6C)	GC010155	Outer Joint		25	39	58.5	89	63.5	I		
	2009.12-		AT			Estate Engine 9HR(DV6C)	GC099366	Outer Joint		25	34	58.5	79	55	I		
1.6 HDi (84 kW)	2013.03-		MT	L	F	Estate	GDS10250	Drive Shaft		25	24	58.5	79	634			
	2013.03-			R	F	Estate	GDS10251	Drive Shaft		25	24	58.5	79	935			
2.0 HDi (100 kW)	2007.09-				F	Estate Engine RHR(DW10BTED4)	GC010067	Outer Joint	48W	25	34	58.5	79	55	I		
	2007.09-		6MT	L	F	Estate Engine RHR(DW10BTED4)	GDS10427	Drive Shaft		25	37	58.5	89	638			





		YEAR	TRANSM	L/R	F/R		G-AP Ref.	PRODUCT	ABS	Technical Specifications						
										A	B	C	H	L	P	
<b>PEUGEOT</b>																
<b>308 SW</b>																
2.0 HDi (100 kW)	2007.09-		AT	L	F	Estate Engine RHR(DW10BTED4)	GDS10380	Drive Shaft		25	37	58.5	89	635		
	2007.09-		MT	L	F	Estate Engine RHR(DW10BTED4)	GDS10210	Drive Shaft		25	37	58.5	89	638		
	2007.09-		AT	R	F	Estate Engine RHR(DW10BTED4)	GDS10363	Drive Shaft		25	37	58.5	89	935		
	2007.09-		AT	R	F	Estate Engine RHR(DW10BTED4)	GCI10091	Inner Joint		37	26	31.5	366	100		
	2007.09-		AT	R	F	Estate Engine RHR(DW10BTED4)	GC010158	Outer Joint		25	26	58.5	89	61.5	M	
	2007.09-		MT	R	F	Estate Engine RHR(DW10BTED4)	GDS10361	Drive Shaft		25	37	58.5	89	959		
2.0 HDi (103 kW)	2007.09-		6MT	L	F	Estate Engine RHR(DW10BTED4)	GDS10427	Drive Shaft		25	37	58.5	89	638		
	2007.09-		AT	L	F	Estate Engine RHR(DW10BTED4)	GDS10380	Drive Shaft		25	37	58.5	89	635		
	2007.09-		MT	L	F	Estate Engine RHR(DW10BTED4)	GDS10210	Drive Shaft		25	37	58.5	89	638		
	2007.09-		AT	R	F	Estate Engine RHR(DW10BTED4)	GDS10363	Drive Shaft		25	37	58.5	89	935		
	2007.09-		AT	R	F	Estate Engine RHR(DW10BTED4)	GCI10091	Inner Joint		37	26	31.5	366	100		
	2007.09-		AT	R	F	Estate Engine RHR(DW10BTED4)	GC010158	Outer Joint		25	26	58.5	89	61.5	M	
	2007.09-		MT	R	F	Estate Engine RHR(DW10BTED4)	GDS10361	Drive Shaft		25	37	58.5	89	959		
	2007.09-					Estate Engine RHR(DW10BTED4)	GC010155	Outer Joint		25	39	58.5	89	63.5	I	
2.0 HDi (110 kW)	2011.04-		MT	L	F	Estate Engine RHE(DW10CTED4)	GDS10210	Drive Shaft		25	37	58.5	89	638		
	2011.04-			L	F	Estate Engine RHE(DW10CTED4)	GDS10380	Drive Shaft		25	37	58.5	89	635		
	2011.04-		MT	R	F	Estate Engine RHE(DW10CTED4)	GDS10361	Drive Shaft		25	37	58.5	89	959		
	2011.04-			R	F	Estate Engine RHE(DW10CTED4)	GDS10363	Drive Shaft		25	37	58.5	89	935		
	2011.04-			R	F	Estate Engine RHE(DW10CTED4)	GCI10091	Inner Joint		37	26	31.5	366	100		
	2011.04-			R	F	Estate Engine RHE(DW10CTED4)	GC010158	Outer Joint		25	26	58.5	89	61.5	M	
	2011.04-		6MT			Estate Engine RHE(DW10CTED4)	GC010155	Outer Joint		25	39	58.5	89	63.5	I	
	2011.04-		AT			Estate Engine RHE(DW10CTED4)	GC099366	Outer Joint		25	34	58.5	79	55	I	
2.0 HDi (120 kW)	2009.06-		AT	L	F	Estate Engine RHH(DW10CTED4)	GDS10380	Drive Shaft		25	37	58.5	89	635		
	2009.06-		MT	L	F	Estate Engine RHH(DW10CTED4)	GDS10210	Drive Shaft		25	37	58.5	89	638		
	2009.06-		AT	R	F	Estate Engine RHH(DW10CTED4)	GDS10363	Drive Shaft		25	37	58.5	89	935		
	2009.06-		AT	R	F	Estate Engine RHH(DW10CTED4)	GCI10091	Inner Joint		37	26	31.5	366	100		
	2009.06-		AT	R	F	Estate Engine RHH(DW10CTED4)	GC010158	Outer Joint		25	26	58.5	89	61.5	M	
	2009.06-		MT	R	F	Estate Engine RHH(DW10CTED4)	GDS10361	Drive Shaft		25	37	58.5	89	959		
	2009.06-		6MT			Estate Engine RHH(DW10CTED4)	GC010155	Outer Joint		25	39	58.5	89	63.5	I	
	2009.06-		AT			Estate Engine RHH(DW10CTED4)	GC099366	Outer Joint		25	34	58.5	79	55	I	
<b>309 (10C, 10A)</b>																
1.1 (40 kW)	1985.10-	1989.07	MT	L	F	Hatchback Engine E1	GDS45013	Drive Shaft		21	24	56.4	76	582		
	1985.10-	1989.07	MT	R	F	Hatchback Engine E1	GDS45036	Drive Shaft		21	24	56.4	76	840		
1.3 (47 kW)	1985.10-	1989.07	MT	L	F	Hatchback Engine G1A	GDS45013	Drive Shaft		21	24	56.4	76	582		
	1985.10-	1989.07	MT	R	F	Hatchback Engine G1A	GDS45036	Drive Shaft		21	24	56.4	76	840		
1.6 (76 kW)	1985.11-	1988.09	MT	L	F	Hatchback Engine 180Z(XU5J)/B6B(XU5J)	GDS45003	Drive Shaft		25	24	56.7	80	581		
1.9 (72 kW)	1986.03-	1989.07	MT	L	F	Hatchback Engine DFZ(XU9J1)	GDS45003	Drive Shaft		25	24	56.7	80	581		
1.9 (75 kW)	1985.10-	1989.07	MT	L	F	Hatchback Engine D2B(XU9S)	GDS45003	Drive Shaft		25	24	56.7	80	581		
1.9 D (47 kW)	1986.06-	1989.07	MT	L	F	Hatchback Engine 162(XUD9)/D9A(XUD9)	GDS45030	Drive Shaft		25	24	56.7	80	579		
	1986.06-	1989.07	MT	R	F	Hatchback Engine 162(XUD9)/D9A(XUD9)	GDS45029	Drive Shaft		25	24	56.7	80	845		
1.9 GTi (88 kW)	1988.07-	1989.07	MT		F	Hatchback Engine DKZ(XU9JAZ)	GC010005	Outer Joint	90T	25	23	54.8	78.5	56	I	
1.9 GTi (94 kW)	1986.10-	1989.07	MT		F	Hatchback Engine D6B(XU9JA)	GC010005	Outer Joint	90T	25	23	54.8	78.5	56	I	
<b>309 II (3C, 3A)</b>																
1.1 (44 kW)	1990.08-	1993.12	MT	R	F	Hatchback Engine HDZ(TU1M)	GDS45034	Drive Shaft		21	22	56.4	76	847.5		
	1990.08-	1993.12	MT	L	F	Hatchback Engine HDZ(TU1M)	GDS45033	Drive Shaft		21	22	56.4	76	588		
1.4 (49 kW)	1990.07-	1993.12	MT	R	F	Hatchback Engine K1D(TU3A)	GDS45034	Drive Shaft		21	22	56.4	76	847.5		
	1990.07-	1993.12	MT	L	F	Hatchback Engine K1D(TU3A)	GDS45033	Drive Shaft		21	22	56.4	76	588		
1.4 (55 kW)	1989.07-	1993.12	MT	R	F	Hatchback Engine KDY(TU3M)/KDZ(TU3M)	GDS45034	Drive Shaft		21	22	56.4	76	847.5		
	1989.07-	1993.12	MT	L	F	Hatchback Engine KDY(TU3M)/KDZ(TU3M)	GDS45033	Drive Shaft		21	22	56.4	76	588		
1.6 (65 kW)	1989.07-	1993.12	MT	L	F	Hatchback Engine BDY(XU5M2Z)/BDY(XU5M3Z)/BDZ(XU5M)	GDS45030	Drive Shaft		25	24	56.7	80	579		
	1989.07-	1993.12	MT	R	F	Hatchback Engine BDY(XU5M2Z)/BDY(XU5M3Z)/BDZ(XU5M)	GDS45029	Drive Shaft		25	24	56.7	80	845		
1.6 (68 kW)	1989.07-	1993.12	MT	L	F	Hatchback Engine B2A(XU52C/K)	GDS45030	Drive Shaft		25	24	56.7	80	579		
	1989.07-	1993.12	MT	R	F	Hatchback Engine B2A(XU52C/K)	GDS45029	Drive Shaft		25	24	56.7	80	845		
1.6 (69 kW)	1989.07-	1993.12	MT	L	F	Hatchback Engine B2A(XU52C/K)	GDS45030	Drive Shaft		25	24	56.7	80	579		
	1989.07-	1993.12	MT	R	F	Hatchback Engine B2A(XU52C/K)	GDS45029	Drive Shaft		25	24	56.7	80	845		
1.8 Diesel (44 kW)	1989.07-	1993.12	MT	L	F	Hatchback Engine 161A(XUD7)	GDS45030	Drive Shaft		25	24	56.7	80	579		
	1989.07-	1993.12	MT	R	F	Hatchback Engine 161A(XUD7)	GDS45029	Drive Shaft		25	24	56.7	80	845		
1.9 (72 kW)	1989.08-	1993.12	MT	L	F	Hatchback Engine DFZ(XU9J1)	GDS45003	Drive Shaft		25	24	56.7	80	581		
1.9 (80 kW)	1990.10-	1993.12	MT	L	F	Hatchback Engine DDZ(XU9M)	GDS45003	Drive Shaft		25	24	56.7	80	581		
1.9 Diesel (47 kW)	1989.07-	1993.12	MT	L	F	Hatchback Engine 162(XUD9)/D9A(XUD9)/DJZ(XUD9Y)	GDS45030	Drive Shaft		25	24	56.7	80	579		
	1989.07-	1993.12	MT	R	F	Hatchback Engine 162(XUD9)/D9A(XUD9)/DJZ(XUD9Y)	GDS45029	Drive Shaft		25	24	56.7	80	845		



		YEAR	TRANSM	L/R	F/R		G-AP Ref.	PRODUCT	ABS	Technical Specifications						
										A	B	C	H	L	P	
<b>PEUGEOT</b>																
<b>309 II (3C, 3A)</b>																
1.9 GTi (88 kW)	1989.07-	1993.12	MT			F Hatchback Engine DKZ(XU9JAZ)	GC010005	Outer Joint	90T	25	23	54.8	78.5	56	I	
1.9 GTi 16V (108 kW)	1990.10-	1993.12	MT			F Hatchback Engine DFW(XU9J4Z)	GC010005	Outer Joint	90T	25	23	54.8	78.5	56	I	
<b>4007 (GP_)</b>																
2.2 HDi (115 kW)	2007.07-		MT	L	F	Closed Off-Road Vehicle Engine 4HN(DW12MTED4)	GDS51047	Drive Shaft		28	24	59.5	94.5	631		
	2007.07-		MT	L/R	F	Closed Off-Road Vehicle Engine 4HN(DW12MTED4)	GC039137	Outer Joint		28	37	59.5	94.5	71.5	I	
	2007.07-		MT	R	F	Closed Off-Road Vehicle Engine 4HN(DW12MTED4)	GDS51050	Drive Shaft		28	24	59.5	94.5	993		
<b>405</b>																
							GCI45016	Inner Joint		24	24	40	69	107.5		
							GCI45017	Inner Joint		24	34	40	69	99		
							GC045019	Outer Joint		25	22	57.7	79	50	I	
							GC045020	Outer Joint		25	24	58.5	79	60	M	
							GC045028	Outer Joint		25	20	55.5	78.5	50	O	
							GC045009	Outer Joint		25	30	55.5	78.5	50	I	
						LADO ESQUERDO	GCI45021	Inner Joint		22	27	40	65	87.5		
						LADO ESQUERDO	GCI45020	Inner Joint		24	34	40	69	89		
				L			GDS45080	Drive Shaft		25	24	58.5	79	604		
				L			GDS10065	Drive Shaft		25	24	54.8	78.5	605		
				R			GDS45079	Drive Shaft		25	24	57.7	79	879		
				R			GDS45063	Drive Shaft		25	24	54.8	78.5	887		
	NULL-			L			GCI45017	Inner Joint		24	34	40	69	99		
	NULL-			L			GCI45016	Inner Joint		24	24	40	69	107.5		
	NULL-			L/R			GC045020	Outer Joint		25	24	58.5	79	60	M	
1.6	1987.05-		MT/AT				GC045031	Outer Joint		25	31	55.5	78.5	50	I	
1.9	1987.05-	1992.06	MT				GC045031	Outer Joint		25	31	55.5	78.5	50	I	
1.9 D	1987.05-		MT				GC045031	Outer Joint		25	31	55.5	78.5	50	I	
1.9 GRI-SRI-STI-SI	1992.07-			L			GDS45069	Drive Shaft		25	24	54.8	78.5	606		
1.9 TD							GC010042	Outer Joint		25	34	54.8	78.5	56	I	
2	1992.01-	1998.12	MT				GC010038	Outer Joint		25	25	60	79	61.5	O	
<b>405 (15B)</b>																
1.4 (47 kW)	1987.01-	1992.07	MT			F Saloon Engine K5A(TU3)	GC010001	Outer Joint		25	22	54.8	79	48	I	
1.6 (53 kW)	1987.07-	1992.12	MT			F Saloon Engine B1E(XU51C)	GC010005	Outer Joint	90T	25	23	54.8	78.5	56	I	
	1987.07-	1992.12	MT			F Saloon Engine B1E(XU51C)	GC010001	Outer Joint		25	22	54.8	79	48	I	
	1987.07-	1992.12	MT	L	F	F Saloon Engine B1E(XU51C)	GDS45023	Drive Shaft		25	24	60	80	608		
	1987.07-	1992.12	MT	R	F	F Saloon Engine B1E(XU51C)	GDS45022	Drive Shaft		25	24	54.8	79	880		
1.6 (55 kW)	1987.07-	1988.06	MT	R	F	F Saloon Engine B1E(XU51C)/BAZ(XU5CP)	GDS45022	Drive Shaft		25	24	54.8	79	880		
	1987.07-	1988.06	MT		F	F Saloon Engine B1E(XU51C)/BAZ(XU5CP)	GC010005	Outer Joint	90T	25	23	54.8	78.5	56	I	
	1987.07-	1988.06	MT		F	F Saloon Engine B1E(XU51C)/BAZ(XU5CP)	GC010001	Outer Joint		25	22	54.8	79	48	I	
	1987.07-	1988.06	MT	L	F	F Saloon Engine B1E(XU51C)/BAZ(XU5CP)	GDS45023	Drive Shaft		25	24	60	80	608		
1.6 (65 kW)	1987.07-	1992.12	MT	R	F	F Saloon Engine BDY(XU5M2Z)/BDZ(XU5M)	GDS45022	Drive Shaft		25	24	54.8	79	880		
	1987.07-	1992.12	MT		F	F Saloon Engine BDY(XU5M2Z)/BDZ(XU5M)	GC010005	Outer Joint	90T	25	23	54.8	78.5	56	I	
	1987.07-	1992.12	MT		F	F Saloon Engine BDY(XU5M2Z)/BDZ(XU5M)	GC010001	Outer Joint		25	22	54.8	79	48	I	
	1987.07-	1992.12	MT	L	F	F Saloon Engine BDY(XU5M2Z)/BDZ(XU5M)	GDS45023	Drive Shaft		25	24	60	80	608		
1.6 (66 kW)	1989.10-	1992.12	MT	R	F	F Saloon Engine BDZ(XU5M)	GDS45022	Drive Shaft		25	24	54.8	79	880		
	1989.10-	1992.12	MT		F	F Saloon Engine BDZ(XU5M)	GC010005	Outer Joint	90T	25	23	54.8	78.5	56	I	
	1989.10-	1992.12	MT		F	F Saloon Engine BDZ(XU5M)	GC010001	Outer Joint		25	22	54.8	79	48	I	
	1989.10-	1992.12	MT	L	F	F Saloon Engine BDZ(XU5M)	GDS45023	Drive Shaft		25	24	60	80	608		
1.6 (69 kW)	1987.01-	1992.12	MT	R	F	F Saloon Engine B2A(XU52C/K)	GDS45022	Drive Shaft		25	24	54.8	79	880		
	1987.01-	1992.12	MT		F	F Saloon Engine B2A(XU52C/K)	GC010005	Outer Joint	90T	25	23	54.8	78.5	56	I	
	1987.01-	1992.12	MT		F	F Saloon Engine B2A(XU52C/K)	GC010001	Outer Joint		25	22	54.8	79	48	I	
	1987.01-	1992.12	MT	L	F	F Saloon Engine B2A(XU52C/K)	GDS45023	Drive Shaft		25	24	60	80	608		
1.8 Turbo Diesel (66 kW)	1988.03-	1992.12	MT			F Saloon Engine A8A(XUD7TE)/AJZ(XUD7TEY)	GC010005	Outer Joint	90T	25	23	54.8	78.5	56	I	
	1988.03-	1992.12		L	F	F Saloon Engine A8A(XUD7TE)/AJZ(XUD7TEY)	GDS45160	Drive Shaft		25	24	54.8	78.5	609		
1.9 (70 kW)	1987.07-	1992.12	MT/AT	R	F	F Saloon Engine D2C(XU92C)	GDS45022	Drive Shaft		25	24	54.8	79	880		
	1987.07-	1992.12	MT		F	F Saloon Engine D2C(XU92C)	GC010005	Outer Joint	90T	25	23	54.8	78.5	56	I	
	1987.07-	1992.12	MT/AT		F	F Saloon Engine D2C(XU92C)	GC010001	Outer Joint		25	22	54.8	79	48	I	
	1987.07-	1992.12	MT/AT	L	F	F Saloon Engine D2C(XU92C)	GDS45023	Drive Shaft		25	24	60	80	608		
1.9 (80 kW)	1988.07-	1992.12	MT/AT	R	F	F Saloon Engine DDZ(XU9M)	GDS45022	Drive Shaft		25	24	54.8	79	880		
	1988.07-	1992.12	MT		F	F Saloon Engine DDZ(XU9M)	GC010005	Outer Joint	90T	25	23	54.8	78.5	56	I	
	1988.07-	1992.12	MT/AT		F	F Saloon Engine DDZ(XU9M)	GC010001	Outer Joint		25	22	54.8	79	48	I	
	1988.07-	1992.12	MT/AT	L	F	F Saloon Engine DDZ(XU9M)	GDS45023	Drive Shaft		25	24	60	80	608		
1.9 (88 kW)	1988.07-	1992.12	AT	R	F	F Saloon Engine DKZ(XU9JAZ)	GDS45022	Drive Shaft		25	24	54.8	79	880		





		TRANSM	L/R	F/R		G-AP Ref.	PRODUCT	ABS	Technical Specifications						
									YEAR	A	B	C	H	L	P
<b>PEUGEOT</b>															
<b>405 (15B)</b>															
1.9 (88 kW)	1988.07-	1992.12	AT		F	Saloon Engine DKZ(XU9JAZ)	GCO10001	Outer Joint		25	22	54.8	79	48	I
	1988.07-	1992.12	AT	L	F	Saloon Engine DKZ(XU9JAZ)	GDS45023	Drive Shaft		25	24	60	80	608	
1.9 Diesel (47 kW)	1988.07-	1992.09	MT	R	F	Saloon Engine DJZ(XUD9Y)	GDS45022	Drive Shaft		25	24	54.8	79	880	
	1988.07-	1992.09	MT		F	Saloon Engine DJZ(XUD9Y)	GCO10005	Outer Joint	90T	25	23	54.8	78.5	56	I
	1988.07-	1992.09	MT		F	Saloon Engine DJZ(XUD9Y)	GCO10001	Outer Joint		25	22	54.8	79	48	I
	1988.07-	1992.09	MT	L	F	Saloon Engine DJZ(XUD9Y)	GDS45023	Drive Shaft		25	24	60	80	608	
	1988.07-	1992.09	MT		F	Saloon Engine DJZ(XUD9Y)	GCO10005	Outer Joint	90T	25	23	54.8	78.5	56	I
1.9 Diesel (51 kW)	1988.03-	1992.12	MT	R	F	Saloon Engine D9B(XUD9A)	GDS45022	Drive Shaft		25	24	54.8	79	880	
	1988.03-	1992.12	MT		F	Saloon Engine D9B(XUD9A)	GCO10005	Outer Joint	90T	25	23	54.8	78.5	56	I
	1988.03-	1992.12	MT		F	Saloon Engine D9B(XUD9A)	GCO10001	Outer Joint		25	22	54.8	79	48	I
	1988.03-	1992.12	MT	L	F	Saloon Engine D9B(XUD9A)	GDS45023	Drive Shaft		25	24	60	80	608	
1.9 Injection (77 kW)	1987.07-	1992.12	AT	R	F	Saloon Engine DFZ(XU9J1)	GDS45022	Drive Shaft		25	24	54.8	79	880	
	1987.07-	1992.12	MT		F	Saloon Engine DFZ(XU9J1)	GCO10005	Outer Joint	90T	25	23	54.8	78.5	56	I
	1987.07-	1992.12	AT		F	Saloon Engine DFZ(XU9J1)	GCO10001	Outer Joint		25	22	54.8	79	48	I
	1987.07-	1992.12	AT	L	F	Saloon Engine DFZ(XU9J1)	GDS45023	Drive Shaft		25	24	60	80	608	
1.9 Sport MI-16 (108 kW)	1988.04-	1992.12		L	F	Saloon Engine DFW(XU9J4Z)	GDS45160	Drive Shaft		25	24	54.8	78.5	609	
1.9 Sport MI-16 (116 kW)	1987.07-	1991.11		L	F	Saloon Engine D6C(XU9J4)	GDS45160	Drive Shaft		25	24	54.8	78.5	609	
<b>405 (15E)</b>															
1.6 (53 kW)	1988.10-	1992.08	MT	R	F	Estate Engine B1E(XU51C)	GDS45022	Drive Shaft		25	24	54.8	79	880	
	1988.10-	1992.08	MT		F	Estate Engine B1E(XU51C)	GCO10005	Outer Joint	90T	25	23	54.8	78.5	56	I
	1988.10-	1992.08	MT		F	Estate Engine B1E(XU51C)	GCO10001	Outer Joint		25	22	54.8	79	48	I
	1988.10-	1992.08	MT	L	F	Estate Engine B1E(XU51C)	GDS45023	Drive Shaft		25	24	60	80	608	
1.6 (55 kW)	1988.10-	1992.08	MT	R	F	Estate Engine BAZ(XU5CP)	GDS45022	Drive Shaft		25	24	54.8	79	880	
	1988.10-	1992.08	MT		F	Estate Engine BAZ(XU5CP)	GCO10005	Outer Joint	90T	25	23	54.8	78.5	56	I
	1988.10-	1992.08	MT		F	Estate Engine BAZ(XU5CP)	GCO10001	Outer Joint		25	22	54.8	79	48	I
	1988.10-	1992.08	MT	L	F	Estate Engine BAZ(XU5CP)	GDS45023	Drive Shaft		25	24	60	80	608	
1.6 (65 kW)	1988.10-	1992.08	MT	R	F	Estate Engine BDY(XU5M2Z)/BDY(XU5M3Z)/BDZ(XU5M)	GDS45022	Drive Shaft		25	24	54.8	79	880	
	1988.10-	1992.08	MT		F	Estate Engine BDY(XU5M2Z)/BDY(XU5M3Z)/BDZ(XU5M)	GCO10005	Outer Joint	90T	25	23	54.8	78.5	56	I
	1988.10-	1992.08	MT		F	Estate Engine BDY(XU5M2Z)/BDY(XU5M3Z)/BDZ(XU5M)	GCO10001	Outer Joint		25	22	54.8	79	48	I
	1988.10-	1992.08	MT	L	F	Estate Engine BDY(XU5M2Z)/BDY(XU5M3Z)/BDZ(XU5M)	GDS45023	Drive Shaft		25	24	60	80	608	
1.6 (66 kW)	1988.10-	1992.08	MT	R	F	Estate Engine BDZ(XU5M)	GDS45022	Drive Shaft		25	24	54.8	79	880	
	1988.10-	1992.08	MT		F	Estate Engine BDZ(XU5M)	GCO10005	Outer Joint	90T	25	23	54.8	78.5	56	I
	1988.10-	1992.08	MT		F	Estate Engine BDZ(XU5M)	GCO10001	Outer Joint		25	22	54.8	79	48	I
	1988.10-	1992.08	MT	L	F	Estate Engine BDZ(XU5M)	GDS45023	Drive Shaft		25	24	60	80	608	
1.8 TD (66 kW)	1988.10-	1992.08	MT		F	Estate Engine A8A(XUD7TE)/AJZ(XUD7TEY)	GCO10005	Outer Joint	90T	25	23	54.8	78.5	56	I
	1988.10-	1992.08		L	F	Estate Engine A8A(XUD7TE)/AJZ(XUD7TEY)	GDS45160	Drive Shaft		25	24	54.8	78.5	609	
1.9 (70 kW)	1988.10-	1992.08	MT/AT	R	F	Estate Engine D2C(XU92C))	GDS45022	Drive Shaft		25	24	54.8	79	880	
	1988.10-	1992.08	MT		F	Estate Engine D2C(XU92C))	GCO10005	Outer Joint	90T	25	23	54.8	78.5	56	I
	1988.10-	1992.08	MT/AT		F	Estate Engine D2C(XU92C))	GCO10001	Outer Joint		25	22	54.8	79	48	I
	1988.10-	1992.08	MT/AT	L	F	Estate Engine D2C(XU92C))	GDS45023	Drive Shaft		25	24	60	80	608	
1.9 (77 kW)	1988.10-	1992.08	MT/AT	R	F	Estate Engine DFZ(XU9J1)	GDS45022	Drive Shaft		25	24	54.8	79	880	
	1988.10-	1992.08	MT		F	Estate Engine DFZ(XU9J1)	GCO10005	Outer Joint	90T	25	23	54.8	78.5	56	I
	1988.10-	1992.08	MT/AT		F	Estate Engine DFZ(XU9J1)	GCO10001	Outer Joint		25	22	54.8	79	48	I
	1988.10-	1992.08	MT/AT	L	F	Estate Engine DFZ(XU9J1)	GDS45023	Drive Shaft		25	24	60	80	608	
1.9 (80 kW)	1988.10-	1992.08	MT/AT	R	F	Estate Engine DDZ(XU9M)	GDS45022	Drive Shaft		25	24	54.8	79	880	
	1988.10-	1992.08	MT		F	Estate Engine DDZ(XU9M)	GCO10005	Outer Joint	90T	25	23	54.8	78.5	56	I
	1988.10-	1992.08	MT/AT		F	Estate Engine DDZ(XU9M)	GCO10001	Outer Joint		25	22	54.8	79	48	I
	1988.10-	1992.08	MT/AT	L	F	Estate Engine DDZ(XU9M)	GDS45023	Drive Shaft		25	24	60	80	608	
1.9 (88 kW)	1988.10-	1992.08	AT	R	F	Estate Engine DKZ(XU9JAZ)	GDS45022	Drive Shaft		25	24	54.8	79	880	
	1988.10-	1992.08	AT		F	Estate Engine DKZ(XU9JAZ)	GCO10001	Outer Joint		25	22	54.8	79	48	I
	1988.10-	1992.08	AT	L	F	Estate Engine DKZ(XU9JAZ)	GDS45023	Drive Shaft		25	24	60	80	608	
1.9 D (47 kW)	1988.10-	1992.08	MT	R	F	Estate Engine DJZ(XUD9Y)	GDS45022	Drive Shaft		25	24	54.8	79	880	
	1988.10-	1992.08	MT		F	Estate Engine DJZ(XUD9Y)	GCO10005	Outer Joint	90T	25	23	54.8	78.5	56	I
	1988.10-	1992.08	MT		F	Estate Engine DJZ(XUD9Y)	GCO10001	Outer Joint		25	22	54.8	79	48	I
	1988.10-	1992.08	MT	L	F	Estate Engine DJZ(XUD9Y)	GDS45023	Drive Shaft		25	24	60	80	608	
1.9 D (51 kW)	1988.10-	1992.08	MT	R	F	Estate Engine D9B(XUD9A)/DJY(XUD9A)	GDS45022	Drive Shaft		25	24	54.8	79	880	
	1988.10-	1992.08	MT		F	Estate Engine D9B(XUD9A)/DJY(XUD9A)	GCO10005	Outer Joint	90T	25	23	54.8	78.5	56	I
	1988.10-	1992.08	MT		F	Estate Engine D9B(XUD9A)/DJY(XUD9A)	GCO10001	Outer Joint		25	22	54.8	79	48	I
	1988.10-	1992.08	MT	L	F	Estate Engine D9B(XUD9A)/DJY(XUD9A)	GDS45023	Drive Shaft		25	24	60	80	608	
<b>405 II (4B)</b>															
1.4 (55 kW)	1992-				L		GDS45157	Drive Shaft	29T	25	22	54.5	79.5	605	
	1992.08-	1995.10	MT		F	Saloon Engine KDX(TU3MC)	GCO45006	Outer Joint		25	31	55	79.5	47.5	I





		TRANSM	L/R	F/R		G-AP Ref.	PRODUCT	ABS	Technical Specifications						
									YEAR	A	B	C	H	L	P
<b>PEUGEOT</b>															
<b>405 II (4B)</b>															
1.6 (65 kW)	1992.08-	1995.10	MT	R	F	Saloon Engine BDY(XU5M2Z)/BDY(XU5M3Z)/BDZ(XU5M)/BFZ(XU5JP)	GDS45022	Drive Shaft		25	24	54.8	79	880	
	1992.08-	1995.10	MT		F	Saloon Engine BDY(XU5M2Z)/BDY(XU5M3Z)/BDZ(XU5M)/BFZ(XU5JP)	GC045006	Outer Joint		25	31	55	79.5	47.5	I
	1992.08-	1995.10	MT	L	F	Saloon Engine BDY(XU5M2Z)/BDY(XU5M3Z)/BDZ(XU5M)/BFZ(XU5JP)	GDS45023	Drive Shaft		25	24	60	80	608	
1.9 D (47 kW)	1992.08-	1995.10	MT	R	F	Saloon Engine DJZ(XUD9Y)	GDS45022	Drive Shaft		25	24	54.8	79	880	
	1992.08-	1995.10	MT		F	Saloon Engine DJZ(XUD9Y)	GC045006	Outer Joint		25	31	55	79.5	47.5	I
	1992.08-	1995.10	MT	L	F	Saloon Engine DJZ(XUD9Y)	GDS45023	Drive Shaft		25	24	60	80	608	
1.9 TD (66 kW)	1992.08-	1995.10	MT	R	F	Saloon Engine DHY(XUD9TE)	GDS45153	Drive Shaft	90T	25	24	55.7	79	880	
	1992.08-	1995.10	MT		F	Saloon Engine DHY(XUD9TE)	GC045004	Outer Joint	90T	25	34	55.7	79	55	I
2.0 (89 kW)	1992.08-	1995.10	MT	R	F	Saloon Engine RFX(XU10J2)	GDS45153	Drive Shaft	90T	25	24	55.7	79	880	
	1992.08-	1995.10	MT		F	Saloon Engine RFX(XU10J2)	GC045004	Outer Joint	90T	25	34	55.7	79	55	I
2.0 16V (110 kW)	1994.06-	1995.10	MT	R	F	Saloon Engine RFT(XU10J4)	GDS45153	Drive Shaft	90T	25	24	55.7	79	880	
	1994.06-	1995.10	MT		F	Saloon Engine RFT(XU10J4)	GC045004	Outer Joint	90T	25	34	55.7	79	55	I
2.0 MI-16 (112 kW)	1992.08-	1995.10	MT	R	F	Saloon Engine RFY(XU10J4Z)	GDS45153	Drive Shaft	90T	25	24	55.7	79	880	
	1992.08-	1995.10	MT		F	Saloon Engine RFY(XU10J4Z)	GC045004	Outer Joint	90T	25	34	55.7	79	55	I
<b>405 II (4E)</b>															
1.4 (55 kW)	1992.08-	1996.10	MT		F	Estate Engine KDX(TU3MC)	GC045006	Outer Joint		25	31	55	79.5	47.5	I
1.6 (65 kW)	1992.08-	1996.10	MT	R	F	Estate Engine BDY(XU5M2Z)/BDY(XU5M3Z)/BDZ(XU5M)/BFZ(XU5JP)	GDS45022	Drive Shaft		25	24	54.8	79	880	
	1992.08-	1996.10	MT		F	Estate Engine BDY(XU5M2Z)/BDY(XU5M3Z)/BDZ(XU5M)/BFZ(XU5JP)	GC045006	Outer Joint		25	31	55	79.5	47.5	I
	1992.08-	1996.10	MT	L	F	Estate Engine BDY(XU5M2Z)/BDY(XU5M3Z)/BDZ(XU5M)/BFZ(XU5JP)	GDS45023	Drive Shaft		25	24	60	80	608	
1.9 D (47 kW)	1992.08-	1996.10	MT	R	F	Estate Engine DJZ(XUD9Y)	GDS45022	Drive Shaft		25	24	54.8	79	880	
	1992.08-	1996.10	MT		F	Estate Engine DJZ(XUD9Y)	GC045006	Outer Joint		25	31	55	79.5	47.5	I
	1992.08-	1996.10	MT	L	F	Estate Engine DJZ(XUD9Y)	GDS45023	Drive Shaft		25	24	60	80	608	
1.9 D (50 kW)	1994.06-	1996.10	MT	R	F	Estate Engine DJY(XUD9A)	GDS45022	Drive Shaft		25	24	54.8	79	880	
	1994.06-	1996.10	MT	L	F	Estate Engine DJY(XUD9A)	GDS45023	Drive Shaft		25	24	60	80	608	
1.9 TD (66 kW)	1992.08-	1996.10	MT	R	F	Estate Engine DHY(XUD9TE)	GDS45153	Drive Shaft	90T	25	24	55.7	79	880	
	1992.08-	1996.10	MT		F	Estate Engine DHY(XUD9TE)	GC045004	Outer Joint	90T	25	34	55.7	79	55	I
2.0 (89 kW)	1992.08-	1996.10	MT	R	F	Estate Engine RFX(XU10J2)	GDS45153	Drive Shaft	90T	25	24	55.7	79	880	
	1992.08-	1996.10	MT		F	Estate Engine RFX(XU10J2)	GC045004	Outer Joint	90T	25	34	55.7	79	55	I
<b>405 II (4E) BREAK</b>															
1.4 (55 kW)	1992.08-				L		GDS45157	Drive Shaft	29T	25	22	54.5	79.5	605	
<b>406</b>															
1.6/1.8/1.9TD							GCI10003	Inner Joint		24	34	40	69	99	
					R		GCI10004	Inner Joint		24	34	29.8	348	99.5	
					R			GC010036	Outer Joint		25	34	55.7	79	55
2	1992.01-	1998.12	MT				GC010038	Outer Joint		25	25	60	79	61.5	O
<b>406 (8B)</b>															
1.6 (65 kW)	1995.11-	2004.05			F	Saloon Engine BFZ(XU5JP)	GC045005	Outer Joint	29T	25	34	55.7	79	55	I
	1995.11-	2004.05			F	Saloon Engine BFZ(XU5JP)	GC045027	Outer Joint		25	34	58	79	55.5	I
	1995.11-	2004.05	MT		F	Saloon Engine BFZ(XU5JP)	GC010086	Outer Joint	48T	25	34	55.7	79	55	I
	1995.11-	2004.05		L	F	Saloon Engine BFZ(XU5JP)	GDS45159	Drive Shaft	29T	25	24	58.5	78.5	629	
	1995.11-	2004.05	MT	L	F	Saloon Engine BFZ(XU5JP)	GCI45020	Inner Joint		24	34	40	69	89	
	1995.11-	2004.05	MT	L	F	Saloon Engine BFZ(XU5JP)	GDS45152	Drive Shaft	48T	25	24	55.7	79	630	
	1995.11-	2004.05	MT	L	F	Saloon Engine BFZ(XU5JP)	GDS45151	Drive Shaft	29T	25	24	55.7	79	630	
	1995.11-	2004.05	MT	R	F	Saloon Engine BFZ(XU5JP)	GDS45020	Drive Shaft	48T	25	24	58	79	905.5	
	1995.11-	2004.05	MT	R	F	Saloon Engine BFZ(XU5JP)	GDS45002	Drive Shaft	29T	25	24	55.7	79	904.5	
1.8 (66 kW)	1997.05-	2004.05	MT		F	Saloon Engine LFX(XU7JB)	GC010086	Outer Joint	48T	25	34	55.7	79	55	I
	1997.05-	2004.05	MT/AT		F	Saloon Engine LFX(XU7JB)	GC045005	Outer Joint	29T	25	34	55.7	79	55	I
	1997.05-	2004.05	MT/AT		F	Saloon Engine LFX(XU7JB)	GC045027	Outer Joint		25	34	58	79	55.5	I
	1997.05-	2004.05	MT	L	F	Saloon Engine LFX(XU7JB)	GDS99159	Drive Shaft	48T	25	24	58	79	619	
	1997.05-	2004.05	MT	L	F	Saloon Engine LFX(XU7JB)	GCI45020	Inner Joint		24	34	40	69	89	
	1997.05-	2004.05	MT	L	F	Saloon Engine LFX(XU7JB)	GDS45152	Drive Shaft	48T	25	24	55.7	79	630	
	1997.05-	2004.05	MT	L	F	Saloon Engine LFX(XU7JB)	GDS45151	Drive Shaft	29T	25	24	55.7	79	630	
	1997.05-	2004.05	MT/AT	L	F	Saloon Engine LFX(XU7JB)	GDS45159	Drive Shaft	29T	25	24	58.5	78.5	629	
	1997.05-	2004.05	MT	R	F	Saloon Engine LFX(XU7JB)	GDS45020	Drive Shaft	48T	25	24	58	79	905.5	
1.8 16V (85 kW)	1997.05-	2004.05	MT	R	F	Saloon Engine LFX(XU7JB)	GDS45002	Drive Shaft	29T	25	24	55.7	79	904.5	
	1997.05-	2004.05				Saloon Engine LFX(XU7JB)	GC045035	Outer Joint	48T	25	34	58	79	55.5	I
	2000.10-	2004.05	MT	L	F	Saloon Engine 6FZ(EW7J4)	GDS99159	Drive Shaft	48T	25	24	58	79	619	
	2000.10-	2004.05	MT	L	F	Saloon Engine 6FZ(EW7J4)	GDS45152	Drive Shaft	48T	25	24	55.7	79	630	
	2000.10-	2004.05	MT	R	F	Saloon Engine 6FZ(EW7J4)	GDS45020	Drive Shaft	48T	25	24	58	79	905.5	
1.9 D (55 kW)	2000.10-	2004.05				Saloon Engine 6FZ(EW7J4)	GC045035	Outer Joint	48T	25	34	58	79	55.5	I
	1996.10-	2004.05			F	Saloon Engine DHW(XUD9SD)	GC045005	Outer Joint	29T	25	34	55.7	79	55	I



		TRANSM	L/R	F/R		G-AP Ref.	PRODUCT	ABS	Technical Specifications						
									YEAR	A	B	C	H	L	P
<b>PEUGEOT</b>															
<b>406 (8B)</b>															
1.9 D (55 kW)	1996.10-	2004.05			F	Saloon Engine DHW(XUD9SD)	GC045027	Outer Joint		25	34	58	79	55.5	I
	1996.10-	2004.05	MT		F	Saloon Engine DHW(XUD9SD)	GC010086	Outer Joint	48T	25	34	55.7	79	55	I
	1996.10-	2004.05		L	F	Saloon Engine DHW(XUD9SD)	GDS45159	Drive Shaft	29T	25	24	58.5	78.5	629	
	1996.10-	2004.05	MT	L	F	Saloon Engine DHW(XUD9SD)	GCI45020	Inner Joint		24	34	40	69	89	
	1996.10-	2004.05	MT	L	F	Saloon Engine DHW(XUD9SD)	GDS45152	Drive Shaft	48T	25	24	55.7	79	630	
	1996.10-	2004.05	MT	L	F	Saloon Engine DHW(XUD9SD)	GDS45151	Drive Shaft	29T	25	24	55.7	79	630	
	1996.10-	2004.05	MT	R	F	Saloon Engine DHW(XUD9SD)	GDS45020	Drive Shaft	48T	25	24	58	79	905.5	
	1996.10-	2004.05	MT	R	F	Saloon Engine DHW(XUD9SD)	GDS45002	Drive Shaft	29T	25	24	55.7	79	904.5	
1.9 TD (66 kW)	1996.01-	2004.05			F	Saloon Engine DHX(XUD9TE)	GC045003	Outer Joint	29T	25	34	58	79	55.5	I
	1996.01-	2004.05			F	Saloon Engine DHX(XUD9TE)	GC045027	Outer Joint		25	34	58	79	55.5	I
	1996.01-	2004.05	MT		F	Saloon Engine DHX(XUD9TE)	GC010086	Outer Joint	48T	25	34	55.7	79	55	I
	1996.01-	2004.05		L	F	Saloon Engine DHX(XUD9TE)	GDS45159	Drive Shaft	29T	25	24	58.5	78.5	629	
	1996.01-	2004.05	MT	L	F	Saloon Engine DHX(XUD9TE)	GDS45026	Drive Shaft	48T	25	24	55.7	79	620	
	1996.01-	2004.05	MT	L	F	Saloon Engine DHX(XUD9TE)	GDS45135	Drive Shaft		25	24	55.7	79	621	
	1996.01-	2004.05	MT	L	F	Saloon Engine DHX(XUD9TE)	GDS45007	Drive Shaft	29T	25	24	55.7	79	621	
	1996.01-	2004.05	MT	R	F	Saloon Engine DHX(XUD9TE)	GDS45020	Drive Shaft	48T	25	24	58	79	905.5	
1.9 TD (68 kW)	1996.01-	2004.05			F	Saloon Engine DHY(XUD9TE)	GC045003	Outer Joint	29T	25	34	58	79	55.5	I
	1996.01-	2004.05			F	Saloon Engine DHY(XUD9TE)	GC045027	Outer Joint		25	34	58	79	55.5	I
	1996.01-	2004.05	MT		F	Saloon Engine DHY(XUD9TE)	GC010086	Outer Joint	48T	25	34	55.7	79	55	I
	1996.01-	2004.05		L	F	Saloon Engine DHY(XUD9TE)	GDS45159	Drive Shaft	29T	25	24	58.5	78.5	629	
	1996.01-	2004.05	MT	L	F	Saloon Engine DHY(XUD9TE)	GDS45026	Drive Shaft	48T	25	24	55.7	79	620	
	1996.01-	2004.05	MT	L	F	Saloon Engine DHY(XUD9TE)	GDS45135	Drive Shaft		25	24	55.7	79	621	
	1996.01-	2004.05	MT	L	F	Saloon Engine DHY(XUD9TE)	GDS45007	Drive Shaft	29T	25	24	55.7	79	621	
	1996.01-	2004.05	MT	R	F	Saloon Engine DHY(XUD9TE)	GDS45020	Drive Shaft	48T	25	24	58	79	905.5	
2.0 16V (100 kW)	1996.01-	2004.05	MT	R	F	Saloon Engine DHY(XUD9TE)	GDS45002	Drive Shaft	29T	25	24	55.7	79	904.5	
	2000.08-	2004.06	MT	L	F	Saloon Engine RFN(EW10J4)	GDS99159	Drive Shaft	48T	25	24	58	79	619	
	2000.08-	2004.06	MT	L	F	Saloon Engine RFN(EW10J4)	GDS45026	Drive Shaft	48T	25	24	55.7	79	620	
	2000.08-	2004.06	MT	R	F	Saloon Engine RFN(EW10J4)	GDS45020	Drive Shaft	48T	25	24	58	79	905.5	
	2000.08-	2004.06				Saloon Engine RFN(EW10J4)	GC045035	Outer Joint	48T	25	34	58	79	55.5	I
	1995.11-	2004.05			F	Saloon Engine RFV(XU10J4R)	GC045003	Outer Joint	29T	25	34	58	79	55.5	I
	1995.11-	2004.05			F	Saloon Engine RFV(XU10J4R)	GC045027	Outer Joint		25	34	58	79	55.5	I
	1995.11-	2004.05	MT		F	Saloon Engine RFV(XU10J4R)	GC010086	Outer Joint	48T	25	34	55.7	79	55	I
2.0 16V (97 kW)	1995.11-	2004.05	MT	L	F	Saloon Engine RFV(XU10J4R)	GDS99159	Drive Shaft	48T	25	24	58	79	619	
	1995.11-	2004.05	MT	L	F	Saloon Engine RFV(XU10J4R)	GDS45026	Drive Shaft	48T	25	24	55.7	79	620	
	1995.11-	2004.05	MT	L	F	Saloon Engine RFV(XU10J4R)	GDS45135	Drive Shaft		25	24	55.7	79	621	
	1995.11-	2004.05	MT	L	F	Saloon Engine RFV(XU10J4R)	GDS45007	Drive Shaft	29T	25	24	55.7	79	621	
	1995.11-	2004.05	MT	R	F	Saloon Engine RFV(XU10J4R)	GDS45020	Drive Shaft	48T	25	24	58	79	905.5	
	1995.11-	2004.05	MT	R	F	Saloon Engine RFV(XU10J4R)	GDS45002	Drive Shaft	29T	25	24	55.7	79	904.5	
	1995.11-	2004.05				Saloon Engine RFV(XU10J4R)	GC045035	Outer Joint	48T	25	34	58	79	55.5	I
	1995.11-	2004.05				Saloon Engine RFV(XU10J4R)	GC045035	Outer Joint	48T	25	34	58	79	55.5	I
2.0 16V HPI (103 kW)	2001.05-	2004.05		L	F	Saloon Engine RLZ(EW10D)	GDS45026	Drive Shaft	48T	25	24	55.7	79	620	
	2001.05-	2004.05	MT	L	F	Saloon Engine RLZ(EW10D)	GDS99159	Drive Shaft	48T	25	24	58	79	619	
	2001.05-	2004.05		R	F	Saloon Engine RLZ(EW10D)	GDS45020	Drive Shaft	48T	25	24	58	79	905.5	
	2001.05-	2004.05				Saloon Engine RLZ(EW10D)	GC045035	Outer Joint	48T	25	34	58	79	55.5	I
2.0 HDi (66 kW)	1999.02-	2004.05			F	Saloon Engine RHY(DW10TD)	GC045052	Outer Joint	48T	25	39	59	89	63.5	I
	1999.02-	2004.05	MT		F	Saloon Engine RHY(DW10TD)	GC010086	Outer Joint	48T	25	34	55.7	79	55	I
	1999.02-	2004.05	MT	L	F	Saloon Engine RHY(DW10TD)	GDS99159	Drive Shaft	48T	25	24	58	79	619	
	1999.02-	2004.05	MT	L	F	Saloon Engine RHY(DW10TD)	GDS45007	Drive Shaft	29T	25	24	55.7	79	621	
	1999.02-	2004.05	MT	L	F	Saloon Engine RHY(DW10TD)	GDS45026	Drive Shaft	48T	25	24	55.7	79	620	
	1999.02-	2004.05	MT	L	F	Saloon Engine RHY(DW10TD)	GDS45135	Drive Shaft		25	24	55.7	79	621	
	1999.02-	2004.05	MT	R	F	Saloon Engine RHY(DW10TD)	GDS45020	Drive Shaft	48T	25	24	58	79	905.5	
	1999.02-	2004.05	MT	R	F	Saloon Engine RHY(DW10TD)	GDS45002	Drive Shaft	29T	25	24	55.7	79	904.5	
	1999.02-	2004.05	MT/AT			Saloon Engine RHY(DW10TD)	GC010127	Outer Joint	29T	25	39	59	89	63.5	I
	1999.02-	2004.05				Saloon Engine RHY(DW10TD)	GC045035	Outer Joint	48T	25	34	58	79	55.5	I
2.0 HDi (79 kW)	2001.08-	2004.05			F	Saloon Engine RHS(DW10ATED)/RHZ(DW10ATED)	GC045052	Outer Joint	48T	25	39	59	89	63.5	I
	2001.08-	2004.05	MT	L	F	Saloon Engine RHS(DW10ATED)/RHZ(DW10ATED)	GDS99165	Drive Shaft	48T	25	37	59	89	620.5	
	2001.08-	2004.05	MT	L	F	Saloon Engine RHS(DW10ATED)/RHZ(DW10ATED)	GDS10162	Drive Shaft	48T	25	37	59	89	625	
	2001.08-	2004.05	MT	R	F	Saloon Engine RHS(DW10ATED)/RHZ(DW10ATED)	GDS45108	Drive Shaft	48T	25	37	59	89	928	
	2001.08-	2004.05				Saloon Engine RHS(DW10ATED)/RHZ(DW10ATED)	GC045035	Outer Joint	48T	25	34	58	79	55.5	I
2.0 HDi (80 kW)	1998.06-	2001.08				Saloon Engine RHZ(DW10ATED)	GC010127	Outer Joint	29T	25	39	59	89	63.5	I
2.0 Turbo (108 kW)	1996.04-	2004.05			F	Saloon Engine RGX(XU10J2TE)	GC045052	Outer Joint	48T	25	39	59	89	63.5	I





		YEAR	TRANSM	L/R	F/R		G-AP Ref.	PRODUCT	ABS	Technical Specifications										
										A	B	C	H	L	P					
<b>PEUGEOT</b>																				
<b>406 (8B)</b>																				
2.0 Turbo (108 kW)	1996.04-	2004.05	MT		F	Saloon Engine RGX(XU10J2TE)	GC010086	Outer Joint	48T	25	34	55.7	79	55	I					
	1996.04-	2004.05	MT	L	F	Saloon Engine RGX(XU10J2TE)	GDS99165	Drive Shaft	48T	25	37	59	89	620.5						
	1996.04-	2004.05	MT	L	F	Saloon Engine RGX(XU10J2TE)	GDS45007	Drive Shaft	29T	25	24	55.7	79	621						
	1996.04-	2004.05	MT	L	F	Saloon Engine RGX(XU10J2TE)	GDS45026	Drive Shaft	48T	25	24	55.7	79	620						
	1996.04-	2004.05	MT	L	F	Saloon Engine RGX(XU10J2TE)	GDS45135	Drive Shaft		25	24	55.7	79	621						
	1996.04-	2004.05	MT	R	F	Saloon Engine RGX(XU10J2TE)	GDS45020	Drive Shaft	48T	25	24	58	79	905.5						
	1996.04-	2004.05	MT	R	F	Saloon Engine RGX(XU10J2TE)	GDS45002	Drive Shaft	29T	25	24	55.7	79	904.5						
	1996.04-	2004.05	MT			Saloon Engine RGX(XU10J2TE)	GC010127	Outer Joint	29T	25	39	59	89	63.5	I					
2.1 TD 12V (80 kW)	1996.01-	2004.05			F	Saloon Engine P8C(XUD11BTE)	GC045052	Outer Joint	48T	25	39	59	89	63.5	I					
	1996.01-	2004.05	MT	L	F	Saloon Engine P8C(XUD11BTE)	GDS10162	Drive Shaft	48T	25	37	59	89	625						
	1996.01-	2004.05	MT	L	F	Saloon Engine P8C(XUD11BTE)	GDS45106	Drive Shaft	29T	25	37	59	89	628						
	1996.01-	2004.05	MT	R	F	Saloon Engine P8C(XUD11BTE)	GDS45108	Drive Shaft	48T	25	37	59	89	928						
	1996.01-	2004.05	MT	R	F	Saloon Engine P8C(XUD11BTE)	GDS99003	Drive Shaft	29T	25	37	59	89	928						
	1996.01-	2004.05	MT			Saloon Engine P8C(XUD11BTE)	GC010127	Outer Joint	29T	25	39	59	89	63.5	I					
2.2 (116 kW)	2000.07-	2004.05			F	Saloon Engine 3FZ(EW12J4)	GC045052	Outer Joint	48T	25	39	59	89	63.5	I					
	2000.07-	2004.05	MT	L	F	Saloon Engine 3FZ(EW12J4)	GDS99165	Drive Shaft	48T	25	37	59	89	620.5						
	2000.07-	2004.05	MT	L	F	Saloon Engine 3FZ(EW12J4)	GDS10162	Drive Shaft	48T	25	37	59	89	625						
	2000.07-	2004.05	MT	R	F	Saloon Engine 3FZ(EW12J4)	GDS45108	Drive Shaft	48T	25	37	59	89	928						
2.2 HDi (98 kW)	2000.03-	2004.05			F	Saloon Engine 4HX(DW12TED4/FAP)	GC045052	Outer Joint	48T	25	39	59	89	63.5	I					
	2000.03-	2004.05	MT	L	F	Saloon Engine 4HX(DW12TED4/FAP)	GDS99165	Drive Shaft	48T	25	37	59	89	620.5						
	2000.03-	2004.05	MT	L	F	Saloon Engine 4HX(DW12TED4/FAP)	GDS10162	Drive Shaft	48T	25	37	59	89	625						
	2000.03-	2004.05	MT	R	F	Saloon Engine 4HX(DW12TED4/FAP)	GDS45108	Drive Shaft	48T	25	37	59	89	928						
3.0 24V (140 kW)	1996.10-	2004.05	MT	L	F	Saloon Engine XFZ(ES9J4)	GDS99165	Drive Shaft	48T	25	37	59	89	620.5						
	1996.10-	2004.05	MT	L	F	Saloon Engine XFZ(ES9J4)	GDS10162	Drive Shaft	48T	25	37	59	89	625						
	1996.10-	2004.05	MT	L	F	Saloon Engine XFZ(ES9J4)	GDS45106	Drive Shaft	29T	25	37	59	89	628						
	1996.10-	2004.05	MT	R	F	Saloon Engine XFZ(ES9J4)	GDS45108	Drive Shaft	48T	25	37	59	89	928						
	1996.10-	2004.05	MT	R	F	Saloon Engine XFZ(ES9J4)	GDS99003	Drive Shaft	29T	25	37	59	89	928						
	1996.10-	2004.05				Saloon Engine XFZ(ES9J4)	GC010127	Outer Joint	29T	25	39	59	89	63.5	I					
3.0 V6 (152 kW)	2000.03-	2004.05			F	Saloon Engine XFX(ES9J4S)	GC045052	Outer Joint	48T	25	39	59	89	63.5	I					
	2000.03-	2004.05	MT	L	F	Saloon Engine XFX(ES9J4S)	GDS99165	Drive Shaft	48T	25	37	59	89	620.5						
	2000.03-	2004.05	MT	L	F	Saloon Engine XFX(ES9J4S)	GDS10162	Drive Shaft	48T	25	37	59	89	625						
	2000.03-	2004.05	MT	R	F	Saloon Engine XFX(ES9J4S)	GDS45108	Drive Shaft	48T	25	37	59	89	928						
<b>406 (8B), 406 (8E/F), BREAK</b>																				
1.6 (65 kW)	1995.11-	2004.05					GC045005	Outer Joint	29T	25	34	55.7	79	55	I					
1.8 (66 kW)	1997.05-	2004.05					GC045005	Outer Joint	29T	25	34	55.7	79	55	I					
1.8 16V HPI (81 kW)	1995.11-	2000.10					GC045005	Outer Joint	29T	25	34	55.7	79	55	I					
1.9 D (55 kW)	1996.10-	2004.05					GC045005	Outer Joint	29T	25	34	55.7	79	55	I					
2.0 16V (100 kW)	2000.08-	2004.05					GC045005	Outer Joint	29T	25	34	55.7	79	55	I					
2.0 16V HPI (103 kW)	2001.05-	2004.05					GC045005	Outer Joint	29T	25	34	55.7	79	55	I					
<b>406 (8C)</b>																				
2.0 16V (100 kW)	2000.10-	2004.12	MT	L	F	Coupe Engine RFN(EW10J4)	GDS99159	Drive Shaft	48T	25	24	58	79	619						
	2000.10-	2004.12	MT	L	F	Coupe Engine RFN(EW10J4)	GDS45026	Drive Shaft	48T	25	24	55.7	79	620						
	2000.10-	2004.12	MT	R	F	Coupe Engine RFN(EW10J4)	GDS45020	Drive Shaft	48T	25	24	58	79	905.5						
	2000.10-	2004.12				Coupe Engine RFN(EW10J4)	GC045035	Outer Joint	48T	25	34	58	79	55.5	I					
2.0 16V (97 kW)	1997.03-	2004.12			F	Coupe Engine RFV(XU10J4R)	GC045027	Outer Joint		25	34	58	79	55.5	I					
	1997.03-	2004.12	MT		F	Coupe Engine RFV(XU10J4R)	GC045003	Outer Joint	29T	25	34	58	79	55.5	I					
	1997.03-	2004.12	MT		F	Coupe Engine RFV(XU10J4R)	GC010086	Outer Joint	48T	25	34	55.7	79	55	I					
	1997.03-	2004.12	MT	L	F	Coupe Engine RFV(XU10J4R)	GDS99159	Drive Shaft	48T	25	24	58	79	619						
	1997.03-	2004.12	MT	L	F	Coupe Engine RFV(XU10J4R)	GDS45007	Drive Shaft	29T	25	24	55.7	79	621						
	1997.03-	2004.12	MT	L	F	Coupe Engine RFV(XU10J4R)	GDS45026	Drive Shaft	48T	25	24	55.7	79	620						
	1997.03-	2004.12	MT	L	F	Coupe Engine RFV(XU10J4R)	GDS45135	Drive Shaft		25	24	55.7	79	621						
	1997.03-	2004.12	MT	R	F	Coupe Engine RFV(XU10J4R)	GDS45020	Drive Shaft	48T	25	24	58	79	905.5						
	1997.03-	2004.12	MT	R	F	Coupe Engine RFV(XU10J4R)	GDS45002	Drive Shaft	29T	25	24	55.7	79	904.5						
	1997.03-	2004.12	AT			Coupe Engine RFV(XU10J4R)	GC010127	Outer Joint	29T	25	39	59	89	63.5	I					
1997.03-	2004.12				Coupe Engine RFV(XU10J4R)	GC045035	Outer Joint	48T	25	34	58	79	55.5	I						
2.0 16V (99 kW)	1999.04-	2004.09	MT	L	F	Coupe Engine RFV(XU10J4R)	GDS99159	Drive Shaft	48T	25	24	58	79	619						
	1999.04-	2004.09				Coupe Engine RFV(XU10J4R)	GC045035	Outer Joint	48T	25	34	58	79	55.5	I					
2.2 (116 kW)	2002.03-	2004.12			F	Coupe Engine 3FZ(EW12J4)	GC045052	Outer Joint	48T	25	39	59	89	63.5	I					
	2002.03-	2004.12	MT	L	F	Coupe Engine 3FZ(EW12J4)	GDS99165	Drive Shaft	48T	25	37	59	89	620.5						
	2002.03-	2004.12	MT	L	F	Coupe Engine 3FZ(EW12J4)	GDS10162	Drive Shaft	48T	25	37	59	89	625						
	2002.03-	2004.12	MT	R	F	Coupe Engine 3FZ(EW12J4)	GDS45108	Drive Shaft	48T	25	37	59	89	928						





		TRANSM	L/R	F/R		G-AP Ref.	PRODUCT	ABS	Technical Specifications											
									YEAR	A	B	C	H	L	P					
<b>PEUGEOT</b>																				
<b>406 (8C)</b>																				
2.2 HDi (98 kW)	2000.03-	2004.12			F	Coupe Engine 4HX(DW12TED4/FAP)	GC045052	Outer Joint	48T	25	39	59	89	63.5	I					
	2000.03-	2004.12	MT	L	F	Coupe Engine 4HX(DW12TED4/FAP)	GDS99165	Drive Shaft	48T	25	37	59	89	620.5						
	2000.03-	2004.12	MT	L	F	Coupe Engine 4HX(DW12TED4/FAP)	GDS10162	Drive Shaft	48T	25	37	59	89	625						
	2000.03-	2004.12	MT	R	F	Coupe Engine 4HX(DW12TED4/FAP)	GDS45108	Drive Shaft	48T	25	37	59	89	928						
3.0 V6 (152 kW)	2000.03-	2004.12			F	Coupe Engine XFX(ES9J4S)	GC045052	Outer Joint	48T	25	39	59	89	63.5	I					
	2000.03-	2004.12	MT	L	F	Coupe Engine XFX(ES9J4S)	GDS99165	Drive Shaft	48T	25	37	59	89	620.5						
	2000.03-	2004.12	MT	L	F	Coupe Engine XFX(ES9J4S)	GDS10162	Drive Shaft	48T	25	37	59	89	625						
	2000.03-	2004.12	MT	R	F	Coupe Engine XFX(ES9J4S)	GDS45108	Drive Shaft	48T	25	37	59	89	928						
3.0 V6 24V (140 kW)	1997.03-	2004.12	AT	L	F	Coupe Engine XFZ(ES9J4)	GDS45044	Drive Shaft	29T	25	37	59	89	592						
	1997.03-	2004.12	MT	L	F	Coupe Engine XFZ(ES9J4)	GDS99165	Drive Shaft	48T	25	37	59	89	620.5						
	1997.03-	2004.12	MT	L	F	Coupe Engine XFZ(ES9J4)	GDS10162	Drive Shaft	48T	25	37	59	89	625						
	1997.03-	2004.12	MT	L	F	Coupe Engine XFZ(ES9J4)	GDS45106	Drive Shaft	29T	25	37	59	89	628						
	1997.03-	2004.12	AT	R	F	Coupe Engine XFZ(ES9J4)	GDS10153	Drive Shaft	29T	25	37	59	89	902						
	1997.03-	2004.12	MT	R	F	Coupe Engine XFZ(ES9J4)	GDS45108	Drive Shaft	48T	25	37	59	89	928						
	1997.03-	2004.12	MT	R	F	Coupe Engine XFZ(ES9J4)	GDS99003	Drive Shaft	29T	25	37	59	89	928						
1997.03-	2004.12				Coupe Engine XFZ(ES9J4)	GC010127	Outer Joint	29T	25	39	59	89	63.5	I						
<b>406 (8E/F)</b>																				
1.8 (66 kW)	1997.05-	2004.10			F	Estate Engine LFX(XU7JB)	GC045005	Outer Joint	29T	25	34	55.7	79	55	I					
	1997.05-	2004.10			F	Estate Engine LFX(XU7JB)	GC045027	Outer Joint		25	34	58	79	55.5	I					
	1997.05-	2004.10	MT		F	Estate Engine LFX(XU7JB)	GC010086	Outer Joint	48T	25	34	55.7	79	55	I					
	1997.05-	2004.10		L	F	Estate Engine LFX(XU7JB)	GDS45159	Drive Shaft	29T	25	24	58.5	78.5	629						
	1997.05-	2004.10	MT	L	F	Estate Engine LFX(XU7JB)	GCI45020	Inner Joint		24	34	40	69	89						
	1997.05-	2004.10	MT	L	F	Estate Engine LFX(XU7JB)	GDS45152	Drive Shaft	48T	25	24	55.7	79	630						
	1997.05-	2004.10	MT	L	F	Estate Engine LFX(XU7JB)	GDS45151	Drive Shaft	29T	25	24	55.7	79	630						
	1997.05-	2004.10	MT	R	F	Estate Engine LFX(XU7JB)	GDS45020	Drive Shaft	48T	25	24	58	79	905.5						
1.8 16V (85 kW)	2000.10-	2004.10	MT	L	F	Estate Engine 6FZ(EW7J4)	GDS99159	Drive Shaft	48T	25	24	58	79	619						
	2000.10-	2004.10	MT	L	F	Estate Engine 6FZ(EW7J4)	GDS45152	Drive Shaft	48T	25	24	55.7	79	630						
	2000.10-	2004.10	MT	R	F	Estate Engine 6FZ(EW7J4)	GDS45020	Drive Shaft	48T	25	24	58	79	905.5						
	2000.10-	2004.10				Estate Engine 6FZ(EW7J4)	GC045035	Outer Joint	48T	25	34	58	79	55.5	I					
1.9 D (55 kW)	1996.10-	2004.10			F	Estate Engine DHW(XUD9SD)	GC045005	Outer Joint	29T	25	34	55.7	79	55	I					
	1996.10-	2004.10			F	Estate Engine DHW(XUD9SD)	GC045027	Outer Joint		25	34	58	79	55.5	I					
	1996.10-	2004.10	MT		F	Estate Engine DHW(XUD9SD)	GC010086	Outer Joint	48T	25	34	55.7	79	55	I					
	1996.10-	2004.10		L	F	Estate Engine DHW(XUD9SD)	GDS45159	Drive Shaft	29T	25	24	58.5	78.5	629						
	1996.10-	2004.10	MT	L	F	Estate Engine DHW(XUD9SD)	GCI45020	Inner Joint		24	34	40	69	89						
	1996.10-	2004.10	MT	L	F	Estate Engine DHW(XUD9SD)	GDS45152	Drive Shaft	48T	25	24	55.7	79	630						
	1996.10-	2004.10	MT	L	F	Estate Engine DHW(XUD9SD)	GDS45151	Drive Shaft	29T	25	24	55.7	79	630						
	1996.10-	2004.10	MT	R	F	Estate Engine DHW(XUD9SD)	GDS45020	Drive Shaft	48T	25	24	58	79	905.5						
1.9 TD (66 kW)	1996.10-	2004.10			F	Estate Engine DHX(XUD9TE)	GC045003	Outer Joint	29T	25	34	58	79	55.5	I					
	1996.10-	2004.10			F	Estate Engine DHX(XUD9TE)	GC045027	Outer Joint		25	34	58	79	55.5	I					
	1996.10-	2004.10	MT		F	Estate Engine DHX(XUD9TE)	GC010086	Outer Joint	48T	25	34	55.7	79	55	I					
	1996.10-	2004.10		L	F	Estate Engine DHX(XUD9TE)	GDS45159	Drive Shaft	29T	25	24	58.5	78.5	629						
	1996.10-	2004.10	MT	L	F	Estate Engine DHX(XUD9TE)	GDS45007	Drive Shaft	29T	25	24	55.7	79	621						
	1996.10-	2004.10	MT	L	F	Estate Engine DHX(XUD9TE)	GDS45026	Drive Shaft	48T	25	24	55.7	79	620						
	1996.10-	2004.10	MT	L	F	Estate Engine DHX(XUD9TE)	GDS45135	Drive Shaft		25	24	55.7	79	621						
	1996.10-	2004.10	MT	R	F	Estate Engine DHX(XUD9TE)	GDS45020	Drive Shaft	48T	25	24	58	79	905.5						
2.0 16V (100 kW)	2000.10-	2004.10	MT	L	F	Estate Engine RFN(EW10J4)	GDS99159	Drive Shaft	48T	25	24	58	79	619						
	2000.10-	2004.10	MT	L	F	Estate Engine RFN(EW10J4)	GDS45026	Drive Shaft	48T	25	24	55.7	79	620						
	2000.10-	2004.10	MT	R	F	Estate Engine RFN(EW10J4)	GDS45020	Drive Shaft	48T	25	24	58	79	905.5						
	2000.10-	2004.10				Estate Engine RFN(EW10J4)	GC045035	Outer Joint	48T	25	34	58	79	55.5	I					
2.0 16V (97 kW)	1996.10-	2004.10			F	Estate Engine RFV(XU10J4R)	GC045003	Outer Joint	29T	25	34	58	79	55.5	I					
	1996.10-	2004.10			F	Estate Engine RFV(XU10J4R)	GC045027	Outer Joint		25	34	58	79	55.5	I					
	1996.10-	2004.10	MT		F	Estate Engine RFV(XU10J4R)	GC010086	Outer Joint	48T	25	34	55.7	79	55	I					
	1996.10-	2004.10	MT	L	F	Estate Engine RFV(XU10J4R)	GDS99159	Drive Shaft	48T	25	24	58	79	619						
	1996.10-	2004.10	MT	L	F	Estate Engine RFV(XU10J4R)	GDS45007	Drive Shaft	29T	25	24	55.7	79	621						
	1996.10-	2004.10	MT	L	F	Estate Engine RFV(XU10J4R)	GDS45026	Drive Shaft	48T	25	24	55.7	79	620						
	1996.10-	2004.10	MT	L	F	Estate Engine RFV(XU10J4R)	GDS45135	Drive Shaft		25	24	55.7	79	621						
	1996.10-	2004.10	MT	R	F	Estate Engine RFV(XU10J4R)	GDS45020	Drive Shaft	48T	25	24	58	79	905.5						
1996.10-	2004.10	MT	R	F	Estate Engine RFV(XU10J4R)	GDS45002	Drive Shaft	29T	25	24	55.7	79	904.5							



		TRANSM	L/R	F/R		G-AP Ref.	PRODUCT	ABS	Technical Specifications								
									YEAR	A	B	C	H	L	P		
<b>PEUGEOT</b>																	
<b>406 (8E/F)</b>																	
2.0 16V (97 kW)	1996.10-	2004.10			Estate Engine RFV(XU10J4R)	GCO45035	Outer Joint	48T	25	34	58	79	55.5	I			
2.0 16V HPI (103 kW)	2001.05-	2004.10		L	F	Estate Engine RLZ(EW10D)	GDS45026	Drive Shaft	48T	25	24	55.7	79	620			
	2001.05-	2004.10	MT	L	F	Estate Engine RLZ(EW10D)	GDS99159	Drive Shaft	48T	25	24	58	79	619			
	2001.05-	2004.10		R	F	Estate Engine RLZ(EW10D)	GDS45020	Drive Shaft	48T	25	24	58	79	905.5			
	2001.05-	2004.10				Estate Engine RLZ(EW10D)	GCO45035	Outer Joint	48T	25	34	58	79	55.5	I		
2.0 HDi (66 kW)	1999.02-	2004.10	MT		F	Estate Engine RHY(DW10TD)	GCO10086	Outer Joint	48T	25	34	55.7	79	55	I		
	1999.02-	2004.10	MT	L	F	Estate Engine RHY(DW10TD)	GDS99159	Drive Shaft	48T	25	24	58	79	619			
	1999.02-	2004.10	MT	L	F	Estate Engine RHY(DW10TD)	GDS45007	Drive Shaft	29T	25	24	55.7	79	621			
	1999.02-	2004.10	MT	L	F	Estate Engine RHY(DW10TD)	GDS45135	Drive Shaft		25	24	55.7	79	621			
	1999.02-	2004.10	MT	L	F	Estate Engine RHY(DW10TD)	GDS45026	Drive Shaft	48T	25	24	55.7	79	620			
	1999.02-	2004.10	MT	R	F	Estate Engine RHY(DW10TD)	GDS45020	Drive Shaft	48T	25	24	58	79	905.5			
	1999.02-	2004.10	MT	R	F	Estate Engine RHY(DW10TD)	GDS45002	Drive Shaft	29T	25	24	55.7	79	904.5			
	1999.02-	2004.10	MT/AT			Estate Engine RHY(DW10TD)	GCO10127	Outer Joint	29T	25	39	59	89	63.5	I		
	1999.02-	2004.10			F	Estate Engine RHY(DW10TD)	GCO45052	Outer Joint	48T	25	39	59	89	63.5	I		
2.0 HDi (79 kW)	2001.08-	2004.10			F	Estate Engine RHS(DW10ATED)/RHZ(DW10ATED)	GCO45052	Outer Joint	48T	25	39	59	89	63.5	I		
	2001.08-	2004.10	MT	L	F	Estate Engine RHS(DW10ATED)/RHZ(DW10ATED)	GDS99165	Drive Shaft	48T	25	37	59	89	620.5			
	2001.08-	2004.10	MT	L	F	Estate Engine RHS(DW10ATED)/RHZ(DW10ATED)	GDS10162	Drive Shaft	48T	25	37	59	89	625			
	2001.08-	2004.10	MT	R	F	Estate Engine RHS(DW10ATED)/RHZ(DW10ATED)	GDS45108	Drive Shaft	48T	25	37	59	89	928			
2.0 HDi (80 kW)	1999.02-	2004.04			F	Estate Engine RHZ(DW10ATED)	GCO45052	Outer Joint	48T	25	39	59	89	63.5	I		
	1999.02-	2004.04	MT		F	Estate Engine RHZ(DW10ATED)	GCO10086	Outer Joint	48T	25	34	55.7	79	55	I		
	1999.02-	2004.04	MT	L	F	Estate Engine RHZ(DW10ATED)	GDS99165	Drive Shaft	48T	25	37	59	89	620.5			
	1999.02-	2004.04	MT	L	F	Estate Engine RHZ(DW10ATED)	GDS45007	Drive Shaft	29T	25	24	55.7	79	621			
	1999.02-	2004.04	MT	L	F	Estate Engine RHZ(DW10ATED)	GDS45135	Drive Shaft		25	24	55.7	79	621			
	1999.02-	2004.04	MT	L	F	Estate Engine RHZ(DW10ATED)	GDS45026	Drive Shaft	48T	25	24	55.7	79	620			
	1999.02-	2004.04	MT	R	F	Estate Engine RHZ(DW10ATED)	GDS45020	Drive Shaft	48T	25	24	58	79	905.5			
	1999.02-	2004.04	MT	R	F	Estate Engine RHZ(DW10ATED)	GDS45002	Drive Shaft	29T	25	24	55.7	79	904.5			
	1999.02-	2004.04	MT			Estate Engine RHZ(DW10ATED)	GCO10127	Outer Joint	29T	25	39	59	89	63.5	I		
	1999.02-	2004.04			F	Estate Engine RHZ(DW10ATED)	GCO45035	Outer Joint	48T	25	34	58	79	55.5	I		
2.0 Turbo (108 kW)	1996.10-	2004.10			F	Estate Engine RGX(XU10J2TE)	GCO45052	Outer Joint	48T	25	39	59	89	63.5	I		
	1996.10-	2004.10	MT		F	Estate Engine RGX(XU10J2TE)	GCO10086	Outer Joint	48T	25	34	55.7	79	55	I		
	1996.10-	2004.10	MT	L	F	Estate Engine RGX(XU10J2TE)	GDS99165	Drive Shaft	48T	25	37	59	89	620.5			
	1996.10-	2004.10	MT	L	F	Estate Engine RGX(XU10J2TE)	GDS45007	Drive Shaft	29T	25	24	55.7	79	621			
	1996.10-	2004.10	MT	L	F	Estate Engine RGX(XU10J2TE)	GDS45135	Drive Shaft		25	24	55.7	79	621			
	1996.10-	2004.10	MT	L	F	Estate Engine RGX(XU10J2TE)	GDS45026	Drive Shaft	48T	25	24	55.7	79	620			
	1996.10-	2004.10	MT	R	F	Estate Engine RGX(XU10J2TE)	GDS45020	Drive Shaft	48T	25	24	58	79	905.5			
	1996.10-	2004.10	MT	R	F	Estate Engine RGX(XU10J2TE)	GDS45002	Drive Shaft	29T	25	24	55.7	79	904.5			
1996.10-	2004.10	MT			Estate Engine RGX(XU10J2TE)	GCO10127	Outer Joint	29T	25	39	59	89	63.5	I			
2.1 TD 12V (80 kW)	1996.10-	2004.10			F	Estate Engine P8C(XUD11BTE)	GCO45052	Outer Joint	48T	25	39	59	89	63.5	I		
	1996.10-	2004.10	MT	L	F	Estate Engine P8C(XUD11BTE)	GDS10162	Drive Shaft	48T	25	37	59	89	625			
	1996.10-	2004.10	MT	L	F	Estate Engine P8C(XUD11BTE)	GDS45106	Drive Shaft	29T	25	37	59	89	628			
	1996.10-	2004.10	MT	R	F	Estate Engine P8C(XUD11BTE)	GDS99003	Drive Shaft	29T	25	37	59	89	928			
	1996.10-	2004.10	MT	R	F	Estate Engine P8C(XUD11BTE)	GDS45108	Drive Shaft	48T	25	37	59	89	928			
2.2 (116 kW)	2000.07-	2004.10			F	Estate Engine 3FZ(EW12J4)	GCO45052	Outer Joint	48T	25	39	59	89	63.5	I		
2000.07-	2004.10	MT	L	F	Estate Engine 3FZ(EW12J4)	GDS99165	Drive Shaft	48T	25	37	59	89	620.5				
2000.07-	2004.10	MT	L	F	Estate Engine 3FZ(EW12J4)	GDS10162	Drive Shaft	48T	25	37	59	89	625				
2000.07-	2004.10	MT	R	F	Estate Engine 3FZ(EW12J4)	GDS45108	Drive Shaft	48T	25	37	59	89	928				
2.2 HDi (98 kW)	2000.03-	2004.10			F	Estate Engine 4HX(DW12TED4/FAP)	GCO45052	Outer Joint	48T	25	39	59	89	63.5	I		
	2000.03-	2004.10	MT	L	F	Estate Engine 4HX(DW12TED4/FAP)	GDS99165	Drive Shaft	48T	25	37	59	89	620.5			
	2000.03-	2004.10	MT	L	F	Estate Engine 4HX(DW12TED4/FAP)	GDS10162	Drive Shaft	48T	25	37	59	89	625			
	2000.03-	2004.10	MT	R	F	Estate Engine 4HX(DW12TED4/FAP)	GDS45108	Drive Shaft	48T	25	37	59	89	928			
3.0 24V (140 kW)	1996.10-	2004.10	MT	L	F	Estate Engine XFZ(ES9J4)	GDS99165	Drive Shaft	48T	25	37	59	89	620.5			
	1996.10-	2004.10	MT	L	F	Estate Engine XFZ(ES9J4)	GDS10162	Drive Shaft	48T	25	37	59	89	625			
	1996.10-	2004.10	MT	L	F	Estate Engine XFZ(ES9J4)	GDS45106	Drive Shaft	29T	25	37	59	89	628			
	1996.10-	2004.10		L	F	Estate Engine XFZ(ES9J4)	GCO10127	Outer Joint	29T	25	39	59	89	63.5	I		
	1996.10-	2004.10	MT	R	F	Estate Engine XFZ(ES9J4)	GDS99003	Drive Shaft	29T	25	37	59	89	928			
	1996.10-	2004.10	MT	R	F	Estate Engine XFZ(ES9J4)	GDS45108	Drive Shaft	48T	25	37	59	89	928			
3.0 V6 (152 kW)	2000.03-	2004.10			F	Estate Engine XFX(ES9J4S)	GCO45052	Outer Joint	48T	25	39	59	89	63.5	I		
	2000.03-	2004.10	MT	L	F	Estate Engine XFX(ES9J4S)	GDS99165	Drive Shaft	48T	25	37	59	89	620.5			
	2000.03-	2004.10	MT	L	F	Estate Engine XFX(ES9J4S)	GDS10162	Drive Shaft	48T	25	37	59	89	625			





		TRANSM	L/R	F/R		G-AP Ref.	PRODUCT	ABS	Technical Specifications					
									YEAR	A	B	C	H	L
<b>PEUGEOT</b>														
<b>406 (8E/F)</b>														
3.0 V6 (152 kW)	2000.03-	2004.10	MT	R	F	Estate Engine XFX(ES9J4S)	GDS45108	Drive Shaft	48T	25	37	59	89	928
<b>406 / 406 BREAK</b>														
1.9 TD (66/68 kW)	1996.01-	2004.05	MT	R		gear BE3/BE4, - 03.99	GDS45136	Drive Shaft		25	24	55.7	79	904.5
2.0 16V (97 kW)	1995.11-	2004.05	MT	R		gear BE3R/BE4R, - 03.99	GDS45136	Drive Shaft		25	24	55.7	79	904.5
2.0 HDi 90 (66 kW)	1999.02-	2004.05	MT	R		gear BE3R/BE4R, - 03.99	GDS45136	Drive Shaft		25	24	55.7	79	904.5
2.0 Turbo (108 kW)	1996.04-	2004.05	MT	R		gear BE3R/BE4R, - 03.99	GDS45136	Drive Shaft		25	24	55.7	79	904.5
<b>406 I</b>														
2.0 HDi	1998.12-	1999.03	MT		F		GC099003	Outer Joint	29T	25	39	59	89	63.5 I
2.0 Turbo	1996.07-	1999.03	MT		F		GC099003	Outer Joint	29T	25	39	59	89	63.5 I
2.1 TD	1996.07-	1998.11	MT		F		GC099003	Outer Joint	29T	25	39	59	89	63.5 I
3.0 V6	1997.01-	1999.06	MT		F		GC099003	Outer Joint	29T	25	39	59	89	63.5 I
	1997.06-	1999.06	AT		F		GC099003	Outer Joint	29T	25	39	59	89	63.5 I
<b>406 II</b>														
2	1999.03-	2000.04	AT		F		GC099003	Outer Joint	29T	25	39	59	89	63.5 I
2.0 HDi	1999.03-		MT	R	F		GDS45116	Drive Shaft	48T	25	37	59	89	935
2.2	2000.07-		MT	R	F		GDS45116	Drive Shaft	48T	25	37	59	89	935
2.2 HDi	2000.10-		MT	R	F		GDS45116	Drive Shaft	48T	25	37	59	89	935
3.0 V6	1999.03-	2000.04	AT		F		GC099003	Outer Joint	29T	25	39	59	89	63.5 I
	1999.03-		MT	R	F		GDS45116	Drive Shaft	48T	25	37	59	89	935
<b>407 (6C), COUPE</b>														
2.0 HDi (100 kW)	2005.10-						GC010051	Outer Joint		28	39	58.6	94	63 I
2.0 HDi (120 kW)	2009.06-						GC010051	Outer Joint		28	39	58.6	94	63 I
2.2 16V (120 kW)	2005.10-						GC010051	Outer Joint		28	39	58.6	94	63 I
2.7 HDi (150 kW)	2005.10-						GC010051	Outer Joint		28	39	58.6	94	63 I
3.0 V6 (155 kW)	2005.10-						GC010051	Outer Joint		28	39	58.6	94	63 I
<b>407 (6C_)</b>														
2.0 HDi (100 kW)	2005.10-				F	Coupe Engine RHR(DW10BTED4)	GC010051	Outer Joint		28	39	58.6	94	63 I
	2005.10-			L	F	Coupe Engine RHR(DW10BTED4)	GDS45133	Drive Shaft		28	37	58.6	94	653
	2005.10-			R	F	Coupe Engine RHR(DW10BTED4)	GDS99214	Drive Shaft		28	37	58.6	94	978
	2005.10-			R	F	Coupe Engine RHR(DW10BTED4)	GCI10041	Inner Joint		37	39	32	399	95.5
	2005.10-			R	F	Coupe Engine RHR(DW10BTED4)	GC010159	Outer Joint		28	39	58.6	94	63 I
<b>407 (6D), 407 (6E) SW</b>														
2.0 HDi (103 kW)	2008.08-						GC010051	Outer Joint		28	39	58.6	94	63 I
2.0 HDi 135 FAP (100 kW)	2004.05-						GC010051	Outer Joint		28	39	58.6	94	63 I
2.2 16V (120 kW)	2005.09-						GC010051	Outer Joint		28	39	58.6	94	63 I
2.2 HDi 170 (125 kW)	2006.05-						GC010051	Outer Joint		28	39	58.6	94	63 I
2.7 HDi (150 kW)	2005.10-						GC010051	Outer Joint		28	39	58.6	94	63 I
3.0 (155 kW)	2004.05-						GC010051	Outer Joint		28	39	58.6	94	63 I
<b>407 (6D_)</b>														
1.6 HDi (80 kW)	2004.05-				F	Saloon Engine 9HY(DV6TED4)/9HZ(DV6TED4)	GC010052	Outer Joint		28	34	58.5	92	55 I
	2004.05-			L	F	Saloon Engine 9HY(DV6TED4)/9HZ(DV6TED4)	GDS10310	Drive Shaft		28	24	59	91	670
	2004.05-			R	F	Saloon Engine 9HY(DV6TED4)/9HZ(DV6TED4)	GDS10265	Drive Shaft		28	24	59	91	951
	2004.05-			L	F	Saloon Engine 9HY(DV6TED4)/9HZ(DV6TED4)	GCI45018	Inner Joint		24	34	40	62	88
	2004.05-		MT	R	F	Saloon Engine 9HY(DV6TED4)/9HZ(DV6TED4)	GDS10239	Drive Shaft		28	24	58.5	92	958
1.8 (85 kW)	2004.05-				F	Saloon Engine 6FZ(EW7J4)	GC010052	Outer Joint		28	34	58.5	92	55 I
	2004.05-			L	F	Saloon Engine 6FZ(EW7J4)	GDS10279	Drive Shaft		28	24	59	91	715
	2004.05-			L	F	Saloon Engine 6FZ(EW7J4)	GDS10266	Drive Shaft		28	24	59	91	678
	2004.05-			R	F	Saloon Engine 6FZ(EW7J4)	GDS10265	Drive Shaft		28	24	59	91	951
	2004.05-		MT	R	F	Saloon Engine 6FZ(EW7J4)	GDS10239	Drive Shaft		28	24	58.5	92	958
1.8 16V (92 kW)	2005.10-	2007.04			F	Saloon Engine 6FY(EW7A)	GC010052	Outer Joint		28	34	58.5	92	55 I
	2005.10-	2007.04		L	F	Saloon Engine 6FY(EW7A)	GDS10310	Drive Shaft		28	24	59	91	670
	2005.10-	2007.04		L	F	Saloon Engine 6FY(EW7A)	GCI45018	Inner Joint		24	34	40	62	88
	2005.10-	2007.04		R	F	Saloon Engine 6FY(EW7A)	GDS10265	Drive Shaft		28	24	59	91	951
	2005.10-	2007.04	MT	R	F	Saloon Engine 6FY(EW7A)	GDS10239	Drive Shaft		28	24	58.5	92	958
2.0 (100 kW)	2004.05-				F	Saloon Engine RFN(EW10J4)	GC010052	Outer Joint		28	34	58.5	92	55 I
	2004.05-			L	F	Saloon Engine RFN(EW10J4)	GDS10310	Drive Shaft		28	24	59	91	670
	2004.05-			R	F	Saloon Engine RFN(EW10J4)	GDS10265	Drive Shaft		28	24	59	91	951
	2004.05-		AT	L	F	Saloon Engine RFN(EW10J4)	GDS10285	Drive Shaft		28	26	58.5	92	661
	2004.05-			L	F	Saloon Engine RFN(EW10J4)	GCI45018	Inner Joint		24	34	40	62	88
	2004.05-		AT	R	F	Saloon Engine RFN(EW10J4)	GDS10283	Drive Shaft		28	26	58.5	92	866
	2004.05-		MT	R	F	Saloon Engine RFN(EW10J4)	GDS10239	Drive Shaft		28	24	58.5	92	958









		TRANSM	L/R	F/R		G-AP Ref.	PRODUCT	ABS	Technical Specifications												
									YEAR	A	B	C	H	L	P						
<b>PEUGEOT</b>																					
<b>407 (6D_)</b>																					
2.0 16V (103 kW)	2005.10-	2007.04			F	Saloon Engine RFJ(EW10A)	GCO10052	Outer Joint		28	34	58.5	92	55	I						
	2005.10-	2007.04		L	F	Saloon Engine RFJ(EW10A)	GDS10310	Drive Shaft		28	24	59	91	670							
	2005.10-	2007.04	AT	L	F	Saloon Engine RFJ(EW10A)	GDS10285	Drive Shaft		28	26	58.5	92	661							
	2005.10-	2007.04		L	F	Saloon Engine RFJ(EW10A)	GCI45018	Inner Joint		24	34	40	62	88							
	2005.10-	2007.04		R	F	Saloon Engine RFJ(EW10A)	GDS10265	Drive Shaft		28	24	59	91	951							
	2005.10-	2007.04	AT	R	F	Saloon Engine RFJ(EW10A)	GDS10283	Drive Shaft		28	26	58.5	92	866							
	2005.10-	2007.04	MT	R	F	Saloon Engine RFJ(EW10A)	GDS10239	Drive Shaft		28	24	58.5	92	958							
2.0 Bioflex (103 kW)	2007.09-		AT	L	F	Saloon Engine RFJ(EW10A)	GDS10285	Drive Shaft		28	26	58.5	92	661							
	2007.09-		AT	R	F	Saloon Engine RFJ(EW10A)	GDS10283	Drive Shaft		28	26	58.5	92	866							
	2007.09-		MT	R	F	Saloon Engine RFJ(EW10A)	GDS10239	Drive Shaft		28	24	58.5	92	958							
2.0 HDi (100 kW)	2004.05-				F	Saloon Engine RHR(DW10BTED4)	GCO10051	Outer Joint		28	39	58.6	94	63	I						
	2004.05-		AT	L	F	Saloon Engine RHR(DW10BTED4)	GDS10385	Drive Shaft		28	37	58.6	93	615							
	2004.05-		MT	L	F	Saloon Engine RHR(DW10BTED4)	GDS45133	Drive Shaft		28	37	58.6	94	653							
	2004.05-		MT	R	F	Saloon Engine RHR(DW10BTED4)	GDS99214	Drive Shaft		28	37	58.6	94	978							
	2004.05-		MT	R	F	Saloon Engine RHR(DW10BTED4)	GCI10041	Inner Joint		37	39	32	399	95.5							
	2004.05-		MT	R	F	Saloon Engine RHR(DW10BTED4)	GCO10159	Outer Joint		28	39	58.6	94	63	I						
2.0 HDi (103 kW)	2008.08-		MT	L	F	Saloon Engine RHF(DW10BTED4)/RHR(DW10BTED4)	GDS45133	Drive Shaft		28	37	58.6	94	653							
	2008.08-		MT	R	F	Saloon Engine RHF(DW10BTED4)/RHR(DW10BTED4)	GDS99214	Drive Shaft		28	37	58.6	94	978							
	2008.08-		MT	R	F	Saloon Engine RHF(DW10BTED4)/RHR(DW10BTED4)	GCI10041	Inner Joint		37	39	32	399	95.5							
	2008.08-		MT	R	F	Saloon Engine RHF(DW10BTED4)/RHR(DW10BTED4)	GCO10159	Outer Joint		28	39	58.6	94	63	I						
2.2 HDi (125 kW)	2006.06-	2008.03			F	Saloon Engine 4HT(DW12BTED4)	GCO10051	Outer Joint		28	39	58.6	94	63	I						
<b>407 (6E_)</b>																					
1.6 HDi (80 kW)	2004.05-				F	Estate Engine 9HY(DV6TED4)/9HZ(DV6TED4)	GCO10052	Outer Joint		28	34	58.5	92	55	I						
	2004.05-			L	F	Estate Engine 9HY(DV6TED4)/9HZ(DV6TED4)	GDS10310	Drive Shaft		28	24	59	91	670							
	2004.05-			R	F	Estate Engine 9HY(DV6TED4)/9HZ(DV6TED4)	GDS10265	Drive Shaft		28	24	59	91	951							
	2004.05-			L	F	Estate Engine 9HY(DV6TED4)/9HZ(DV6TED4)	GCI45018	Inner Joint		24	34	40	62	88							
	2004.05-		MT	R	F	Estate Engine 9HY(DV6TED4)/9HZ(DV6TED4)	GDS10239	Drive Shaft		28	24	58.5	92	958							
	2004.05-				F	Estate Engine 6FZ(EW7J4)	GCO10052	Outer Joint		28	34	58.5	92	55	I						
1.8 (85 kW)	2004.05-			L	F	Estate Engine 6FZ(EW7J4)	GDS10279	Drive Shaft		28	24	59	91	715							
	2004.05-			L	F	Estate Engine 6FZ(EW7J4)	GDS10266	Drive Shaft		28	24	59	91	678							
	2004.05-			R	F	Estate Engine 6FZ(EW7J4)	GDS10265	Drive Shaft		28	24	59	91	951							
	2004.05-		MT	R	F	Estate Engine 6FZ(EW7J4)	GDS10239	Drive Shaft		28	24	58.5	92	958							
	2004.05-				F	Estate Engine 6FY(EW7A)	GCO10052	Outer Joint		28	34	58.5	92	55	I						
1.8 16V (92 kW)	2005.10-	2007.04		L	F	Estate Engine 6FY(EW7A)	GDS10310	Drive Shaft		28	24	59	91	670							
	2005.10-	2007.04		L	F	Estate Engine 6FY(EW7A)	GCI45018	Inner Joint		24	34	40	62	88							
	2005.10-	2007.04		R	F	Estate Engine 6FY(EW7A)	GDS10265	Drive Shaft		28	24	59	91	951							
	2005.10-	2007.04	MT	R	F	Estate Engine 6FY(EW7A)	GDS10239	Drive Shaft		28	24	58.5	92	958							
	2005.10-	2007.04			F	Estate Engine RFN(EW10J4)	GCO10052	Outer Joint		28	34	58.5	92	55	I						
2.0 (100 kW)	2004.05-			L	F	Estate Engine RFN(EW10J4)	GDS10310	Drive Shaft		28	24	59	91	670							
	2004.05-			R	F	Estate Engine RFN(EW10J4)	GDS10265	Drive Shaft		28	24	59	91	951							
	2004.05-		AT	L	F	Estate Engine RFN(EW10J4)	GDS10285	Drive Shaft		28	26	58.5	92	661							
	2004.05-			L	F	Estate Engine RFN(EW10J4)	GCI45018	Inner Joint		24	34	40	62	88							
	2004.05-		AT	R	F	Estate Engine RFN(EW10J4)	GDS10283	Drive Shaft		28	26	58.5	92	866							
	2004.05-				F	Estate Engine RFJ(EW10A)	GCO10052	Outer Joint		28	34	58.5	92	55	I						
2.0 16V (103 kW)	2005.10-	2007.04		L	F	Estate Engine RFJ(EW10A)	GDS10310	Drive Shaft		28	24	59	91	670							
	2005.10-	2007.04	AT	L	F	Estate Engine RFJ(EW10A)	GDS10285	Drive Shaft		28	26	58.5	92	661							
	2005.10-	2007.04		L	F	Estate Engine RFJ(EW10A)	GCI45018	Inner Joint		24	34	40	62	88							
	2005.10-	2007.04		R	F	Estate Engine RFJ(EW10A)	GDS10265	Drive Shaft		28	24	59	91	951							
	2005.10-	2007.04	AT	R	F	Estate Engine RFJ(EW10A)	GDS10283	Drive Shaft		28	26	58.5	92	866							
	2004.05-				F	Estate Engine RHR(DW10BTED4)	GCO10051	Outer Joint		28	39	58.6	94	63	I						
	2004.05-			L	F	Estate Engine RHR(DW10BTED4)	GDS45133	Drive Shaft		28	37	58.6	94	653							
2.0 HDi (100 kW)	2004.05-		MT	R	F	Estate Engine RHR(DW10BTED4)	GDS99214	Drive Shaft		28	37	58.6	94	978							
	2004.05-		MT	R	F	Estate Engine RHR(DW10BTED4)	GCI10041	Inner Joint		37	39	32	399	95.5							
	2004.05-		MT	R	F	Estate Engine RHR(DW10BTED4)	GCO10159	Outer Joint		28	39	58.6	94	63	I						
	2008.08-			L	F	Estate Engine RHR(DW10BTED4)	GDS45133	Drive Shaft		28	37	58.6	94	653							
	2008.08-			R	F	Estate Engine RHR(DW10BTED4)	GDS99214	Drive Shaft		28	37	58.6	94	978							
2.0 HDi (103 kW)	2008.08-			R	F	Estate Engine RHR(DW10BTED4)	GCI10041	Inner Joint		37	39	32	399	95.5							
	2008.08-			R	F	Estate Engine RHR(DW10BTED4)	GCO10159	Outer Joint		28	39	58.6	94	63	I						
	2006.06-	2008.03			F	Estate Engine 4HT(DW12BTED4)	GCO10051	Outer Joint		28	39	58.6	94	63	I						
	<b>5008</b>																				
1.6 16V (115 kW)	2009.09-		MT	L	F	MPV Engine EP6CDT	GDS10253	Drive Shaft		25	24	58.5	79	626							



		TRANSM	L/R	F/R		G-AP Ref.	PRODUCT	ABS	Technical Specifications							
									YEAR	A	B	C	H	L	P	
<b>PEUGEOT</b>																
<b>5008</b>																
1.6 16V (115 kW)	2009.09-		MT	L	F	MPV Engine EP6CDT	GCI10057	Inner Joint		24	34	40	52.5	90		
	2009.09-		MT	L/R	F	MPV Engine EP6CDT	GC010148	Outer Joint		25	34	58.5	79	55.5	I	
	2009.09-		MT	R	F	MPV Engine EP6CDT	GDS10325	Drive Shaft		25	24	58.5	79	940		
	2009.09-		MT	R	F	MPV Engine EP6CDT	GCI10058	Inner Joint		24	34	29.8	365	88		
	2009.09-		6MT			MPV Engine EP6CDT	GC099366	Outer Joint		25	34	58.5	79	55	I	
1.6 16V (88 kW)	2009.09-				F	MPV Engine EP6/5FS(EP6C)	GC010067	Outer Joint	48W	25	34	58.5	79	55	I	
	2009.09-		MT	R	F	MPV Engine EP6/5FS(EP6C)	GDS10251	Drive Shaft		25	24	58.5	79	935		
	2009.09-		6MT			MPV Engine EP6/5FS(EP6C)	GC099366	Outer Joint		25	34	58.5	79	55	I	
1.6 HDi (80 kW)	2009.09-		AT	L	F	MPV Engine 9HZ(DV6TED4)	GDS10250	Drive Shaft		25	24	58.5	79	634		
	2009.09-		MT	L	F	MPV Engine 9HZ(DV6TED4)	GDS10253	Drive Shaft		25	24	58.5	79	626		
	2009.09-		MT	L	F	MPV Engine 9HZ(DV6TED4)	GCI10057	Inner Joint		24	34	40	52.5	90		
	2009.09-		MT	L/R	F	MPV Engine 9HZ(DV6TED4)	GC010148	Outer Joint		25	34	58.5	79	55.5	I	
	2009.09-		MT	R	F	MPV Engine 9HZ(DV6TED4)	GDS10325	Drive Shaft		25	24	58.5	79	940		
	2009.09-		MT	R	F	MPV Engine 9HZ(DV6TED4)	GCI10058	Inner Joint		24	34	29.8	365	88		
1.6 HDi (82 kW)	2009.09-		6MT			MPV Engine 9HZ(DV6TED4)	GC099366	Outer Joint		25	34	58.5	79	55	I	
	2010.08-		AT	L	F	MPV Engine 9HR(DV6C)	GDS10250	Drive Shaft		25	24	58.5	79	634		
	2010.08-		MT	L	F	MPV Engine 9HR(DV6C)	GDS10253	Drive Shaft		25	24	58.5	79	626		
	2010.08-		MT	L	F	MPV Engine 9HR(DV6C)	GCI10057	Inner Joint		24	34	40	52.5	90		
	2010.08-		MT	L/R	F	MPV Engine 9HR(DV6C)	GC010148	Outer Joint		25	34	58.5	79	55.5	I	
	2010.08-		MT	R	F	MPV Engine 9HR(DV6C)	GDS10325	Drive Shaft		25	24	58.5	79	940		
1.6 HDi (84 kW)	2010.08-		MT	R	F	MPV Engine 9HR(DV6C)	GCI10058	Inner Joint		24	34	29.8	365	88		
	2010.08-		6MT			MPV Engine 9HR(DV6C)	GC010155	Outer Joint		25	39	58.5	89	63.5	I	
	2010.08-		MT/6MT			MPV Engine 9HR(DV6C)	GC099366	Outer Joint		25	34	58.5	79	55	I	
	2013.03-					MPV Engine 9HD(DV6CTED)	GC099366	Outer Joint		25	34	58.5	79	55	I	
	2.0 HDi (100 kW)	2012.02-		6MT	L	F	MPV Engine AHV (DW10FD)/RHD(DW10CTED4)	GDS10427	Drive Shaft		25	37	58.5	89	638	
		2012.02-		MT	L	F	MPV Engine AHV (DW10FD)/RHD(DW10CTED4)	GDS10210	Drive Shaft		25	37	58.5	89	638	
2012.02-			6MT	R	F	MPV Engine AHV (DW10FD)/RHD(DW10CTED4)	GDS10421	Drive Shaft		25	37	58.5	89	972		
2012.02-			MT	R	F	MPV Engine AHV (DW10FD)/RHD(DW10CTED4)	GDS10361	Drive Shaft		25	37	58.5	89	959		
2.0 HDi (110 kW)	2009.06-		6MT	L	F	MPV Engine RHE(DW10CTED4)	GDS10427	Drive Shaft		25	37	58.5	89	638		
	2009.06-		AT	L	F	MPV Engine RHE(DW10CTED4)	GDS10380	Drive Shaft		25	37	58.5	89	635		
	2009.06-		MT	L	F	MPV Engine RHE(DW10CTED4)	GDS10210	Drive Shaft		25	37	58.5	89	638		
	2009.06-		AT	R	F	MPV Engine RHE(DW10CTED4)	GDS10363	Drive Shaft		25	37	58.5	89	935		
	2009.06-		AT	R	F	MPV Engine RHE(DW10CTED4)	GCI10091	Inner Joint		37	26	31.5	366	100		
	2009.06-		AT	R	F	MPV Engine RHE(DW10CTED4)	GC010158	Outer Joint		25	26	58.5	89	61.5	M	
	2009.06-		MT	R	F	MPV Engine RHE(DW10CTED4)	GDS10361	Drive Shaft		25	37	58.5	89	959		
	2009.06-		6MT			MPV Engine RHE(DW10CTED4)	GC099366	Outer Joint		25	34	58.5	79	55	I	
	2009.06-		6MT			MPV Engine RHE(DW10CTED4)	GC099366	Outer Joint		25	34	58.5	79	55	I	
2.0 HDi (120 kW)	2009.09-		6MT	L	F	MPV Engine RHH(DW10CTED4)	GDS10427	Drive Shaft		25	37	58.5	89	638		
	2009.09-		AT	L	F	MPV Engine RHH(DW10CTED4)	GDS10380	Drive Shaft		25	37	58.5	89	635		
	2009.09-		MT	L	F	MPV Engine RHH(DW10CTED4)	GDS10210	Drive Shaft		25	37	58.5	89	638		
	2009.09-		AT	R	F	MPV Engine RHH(DW10CTED4)	GDS10363	Drive Shaft		25	37	58.5	89	935		
	2009.09-		AT	R	F	MPV Engine RHH(DW10CTED4)	GCI10091	Inner Joint		37	26	31.5	366	100		
	2009.09-		AT	R	F	MPV Engine RHH(DW10CTED4)	GC010158	Outer Joint		25	26	58.5	89	61.5	M	
	2009.09-		MT	R	F	MPV Engine RHH(DW10CTED4)	GDS10361	Drive Shaft		25	37	58.5	89	959		
	2009.09-		MT	R	F	MPV Engine RHH(DW10CTED4)	GDS10361	Drive Shaft		25	37	58.5	89	959		
	2009.09-		MT			MPV Engine RHH(DW10CTED4)	GC010155	Outer Joint		25	39	58.5	89	63.5	I	
<b>504</b>																
-						GDS45093	Drive Shaft		27	27	54	90.5	700			
<b>508</b>																
1.6 BlueHDi (88 kW)	2014.03-		MT	L	F	Saloon Engine BHZ (DV6FC)	GDS10343	Drive Shaft		28	37	58.6	93	672		
1.6 HDi (82 kW)	2010.11-		MT	L	F	Saloon Engine 9HR(DV6C)	GDS10343	Drive Shaft		28	37	58.6	93	672		
1.6 HDi (84 kW)	2012.02-		MT	L	F	Saloon Engine 9HD(DV6CTED)	GDS10343	Drive Shaft		28	37	58.6	93	672		
2.0 HDi (103 kW)	2010.11-		MT	L	F	Saloon Engine RHF(DW10BTED4)	GDS10343	Drive Shaft		28	37	58.6	93	672		
2.0 HDi (120 kW)	2010.11-		MT	L	F	Saloon Engine RHH(DW10CTED4)	GDS10343	Drive Shaft		28	37	58.6	93	672		
2.0 HDi Hybrid4 (147 kW)	2010.11-		MT	L	F	Saloon	GDS10343	Drive Shaft		28	37	58.6	93	672		
2.0 HDi Hybrid4 AWC (120 kW)	2010.11-		MT	L	F	Saloon Engine RHC(DW10CTED4)	GDS10343	Drive Shaft		28	37	58.6	93	672		
<b>508 SW</b>																
1.6 BlueHDi (88 kW)	2014.03-		MT	L	F	Estate Engine BHZ (DV6FC)	GDS10343	Drive Shaft		28	37	58.6	93	672		
<b>605 (6B)</b>																
2.0 (79 kW)	1990.02-	1999.09	MT		F	Saloon	GC010006	Outer Joint		28	23	59	88.5	55	I	
	1990.02-	1999.09	MT		F	Saloon	GC010007	Outer Joint	48T	28	23	58	88.5	55	I	
	1990.02-	1999.09	MT		F	Saloon	GC010021	Outer Joint	29T	28	23	58	88.5	55	I	
	1990.02-	1999.09	MT/AT	L	F	Saloon	GDS10113	Drive Shaft		28	24	58	88.5	651		

		TRANSM	L/R	F/R		G-AP Ref.	PRODUCT	ABS	Technical Specifications								
									YEAR	A	B	C	H	L	P		
<b>PEUGEOT</b>																	
<b>605 (6B)</b>																	
2.0 (79 kW)	1990.02-	1999.09	MT/AT	R	F	Saloon	GDS10114	Drive Shaft		28	24	58	88.5	942.5			
	1990.02-	1999.09		L	F	Saloon	GDS10083	Drive Shaft	48T	28	24	58	88.5	651			
	1990.02-	1999.09		R	F	Saloon	GDS10084	Drive Shaft	48T	28	24	58	88.5	942.5			
2.0 (89 kW)	1989.06-	1999.09		L	F	Saloon Engine RFZ(XU10J2Z)	GDS10071	Drive Shaft	48T	28	37	58	89	641.5			
	1989.06-	1999.09		R	F	Saloon Engine RFZ(XU10J2Z)	GDS10070	Drive Shaft	48T	28	37	58	89	939			
	1989.06-	1999.09	MT		F	Saloon Engine RFZ(XU10J2Z)	GC010006	Outer Joint		28	23	59	88.5	55	I		
	1989.06-	1999.09	MT		F	Saloon Engine RFZ(XU10J2Z)	GC010007	Outer Joint	48T	28	23	58	88.5	55	I		
	1989.06-	1999.09	MT		F	Saloon Engine RFZ(XU10J2Z)	GC010021	Outer Joint	29T	28	23	58	88.5	55	I		
	1989.06-	1999.09	MT/AT	L	F	Saloon Engine RFZ(XU10J2Z)	GDS10113	Drive Shaft		28	24	58	88.5	651			
	1989.06-	1999.09	MT/AT	R	F	Saloon Engine RFZ(XU10J2Z)	GDS10114	Drive Shaft		28	24	58	88.5	942.5			
	1989.06-	1999.09			F	Saloon Engine RFZ(XU10J2Z)	GC010047	Outer Joint		28	27	58	89	63	I		
	1989.06-	1999.09		R	F	Saloon Engine RFZ(XU10J2Z)	GDS10190	Drive Shaft	29T	28	37	58	88	935			
2.0 16V (97 kW)	1994.07-	1999.09	MT/AT	L	F	Saloon Engine RFV(XU10J4R)	GDS10113	Drive Shaft		28	24	58	88.5	651			
	1994.07-	1999.09	MT/AT	R	F	Saloon Engine RFV(XU10J4R)	GDS10114	Drive Shaft		28	24	58	88.5	942.5			
2.0 Turbo (104 kW)	1992.07-	1999.09		L	F	Saloon Engine RGY(XU10J2TE)	GDS10071	Drive Shaft	48T	28	37	58	89	641.5			
	1992.07-	1999.09		R	F	Saloon Engine RGY(XU10J2TE)	GDS10070	Drive Shaft	48T	28	37	58	89	939			
	1992.07-	1999.09	MT/AT	L	F	Saloon Engine RGY(XU10J2TE)	GDS10113	Drive Shaft		28	24	58	88.5	651			
	1992.07-	1999.09	MT/AT	R	F	Saloon Engine RGY(XU10J2TE)	GDS10114	Drive Shaft		28	24	58	88.5	942.5			
	1992.07-	1999.09			F	Saloon Engine RGY(XU10J2TE)	GC010047	Outer Joint		28	27	58	89	63	I		
	1992.07-	1999.09		R	F	Saloon Engine RGY(XU10J2TE)	GDS10190	Drive Shaft	29T	28	37	58	88	935			
2.0 Turbo (108 kW)	1991.07-	1999.09		L	F	Saloon Engine RGX(XU10J2TE)	GDS10191	Drive Shaft	29T	28	37	58	88	642			
	1991.07-	1999.09		R	F	Saloon Engine RGX(XU10J2TE)	GDS10071	Drive Shaft	48T	28	37	58	89	641.5			
	1991.07-	1999.09			F	Saloon Engine RGX(XU10J2TE)	GC010047	Outer Joint		28	27	58	89	63	I		
	1991.07-	1999.09		R	F	Saloon Engine RGX(XU10J2TE)	GDS10190	Drive Shaft	29T	28	37	58	88	935			
2.1 D (60 kW)	1989.06-	1995.07			F	Saloon Engine P9A(XUD11A)	GDS10191	Drive Shaft	29T	28	37	58	88	642			
	1989.06-	1995.07	MT/AT	L	F	Saloon Engine P9A(XUD11A)	GC010054	Outer Joint	48T	28	23	59	88.5	55	I		
	1989.06-	1995.07	MT/AT	R	F	Saloon Engine P9A(XUD11A)	GDS10113	Drive Shaft		28	24	58	88.5	651			
	1989.06-	1995.07	MT/AT		F	Saloon Engine P9A(XUD11A)	GDS10114	Drive Shaft		28	24	58	88.5	942.5			
	1989.06-	1995.07		L	F	Saloon Engine P9A(XUD11A)	GDS10083	Drive Shaft	48T	28	24	58	88.5	651			
2.1 TD 12V (80 kW)	1994.08-	1999.09			F	Saloon Engine P8C(XUD11BTE)	GDS10084	Drive Shaft	48T	28	24	58	88.5	942.5			
	1994.08-	1999.09			F	Saloon Engine P8C(XUD11BTE)	GC010029	Outer Joint	29T	28	27	58	89	63	I		
2.1 Turbo Diesel (80 kW)	1989.06-	1999.09		L	F	Saloon Engine PHZ(XUD11ATE)	GC010008	Outer Joint	48T	28	27	58	89	63	I		
	1989.06-	1999.09		R	F	Saloon Engine PHZ(XUD11ATE)	GDS10071	Drive Shaft	48T	28	37	58	89	641.5			
	1989.06-	1999.09			F	Saloon Engine PHZ(XUD11ATE)	GDS10070	Drive Shaft	48T	28	37	58	89	939			
	1989.06-	1999.09			F	Saloon Engine PHZ(XUD11ATE)	GC010029	Outer Joint	29T	28	27	58	89	63	I		
	1989.06-	1999.09			F	Saloon Engine PHZ(XUD11ATE)	GC010047	Outer Joint		28	27	58	89	63	I		
	1989.06-	1999.09			F	Saloon Engine PHZ(XUD11ATE)	GC010008	Outer Joint	48T	28	27	58	89	63	I		
3.0 (123 kW)	1989.06-	1999.09		R	F	Saloon Engine PHZ(XUD11ATE)	GDS10190	Drive Shaft	29T	28	37	58	88	935			
	1989.06-	1999.09		L	F	Saloon Engine PHZ(XUD11ATE)	GDS10191	Drive Shaft	29T	28	37	58	88	642			
	1989.08-	1994.06		L	F	Saloon	GC010029	Outer Joint	29T	28	27	58	89	63	I		
	1989.08-	1994.06		R	F	Saloon	GDS10071	Drive Shaft	48T	28	37	58	89	641.5			
	1989.08-	1994.06			F	Saloon	GDS10070	Drive Shaft	48T	28	37	58	89	939			
	1989.08-	1994.06			F	Saloon	GC010029	Outer Joint	29T	28	27	58	89	63	I		
	1989.08-	1994.06		R	F	Saloon	GC010047	Outer Joint		28	27	58	89	63	I		
	1989.08-	1994.06			F	Saloon	GC010008	Outer Joint	48T	28	27	58	89	63	I		
	1989.08-	1994.06		L	F	Saloon	GDS10190	Drive Shaft	29T	28	37	58	88	935			
	1989.08-	1994.06		L	F	Saloon	GDS10191	Drive Shaft	29T	28	37	58	88	642			
	1989.10-	1999.09			F	Saloon Engine UFZ(ZPJ)	GC010029	Outer Joint	29T	28	27	58	89	63	I		
	1989.10-	1999.09			F	Saloon Engine UFZ(ZPJ)	GC010047	Outer Joint		28	27	58	89	63	I		
3.0 (147 kW)	1989.10-	1999.09			F	Saloon Engine UFZ(ZPJ)	GC010008	Outer Joint	48T	28	27	58	89	63	I		
	1989.10-	1999.09		R	F	Saloon Engine UFZ(ZPJ)	GDS10190	Drive Shaft	29T	28	37	58	88	935			
	1989.10-	1999.09		L	F	Saloon Engine UFZ(ZPJ)	GDS10191	Drive Shaft	29T	28	37	58	88	642			
	1989.10-	1999.09		L	F	Saloon Engine UFZ(ZPJ)	GDS10071	Drive Shaft	48T	28	37	58	89	641.5			
	1989.10-	1999.09		R	F	Saloon Engine UFZ(ZPJ)	GDS10070	Drive Shaft	48T	28	37	58	89	939			
	1989.08-	1994.06		L	F	Saloon	GDS10071	Drive Shaft	48T	28	37	58	89	641.5			
	1989.08-	1994.06		R	F	Saloon	GDS10070	Drive Shaft	48T	28	37	58	89	939			
	1989.08-	1994.06			F	Saloon	GC010029	Outer Joint	29T	28	27	58	89	63	I		
1989.08-	1994.06			F	Saloon	GC010047	Outer Joint		28	27	58	89	63	I			
1989.08-	1994.06			F	Saloon	GC010008	Outer Joint	48T	28	27	58	89	63	I			
1989.08-	1994.06		R	F	Saloon	GDS10190	Drive Shaft	29T	28	37	58	88	935				









		TRANSM	L/R	F/R		G-AP Ref.	PRODUCT	ABS	Technical Specifications					
									YEAR	A	B	C	H	L
<b>PEUGEOT</b>														
<b>605 (6B)</b>														
3.0 (147 kW)	1989.08-	1994.06		L	F	Saloon	GDS10191	Drive Shaft	29T	28	37	58	88	642
3.0 SV 24 (147 kW)	1989.08-	1999.09		L	F	Saloon Engine UKZ(ZPJ4/Z)	GDS10071	Drive Shaft	48T	28	37	58	89	641.5
	1989.08-	1999.09		R	F	Saloon Engine UKZ(ZPJ4/Z)	GDS10070	Drive Shaft	48T	28	37	58	89	939
	1989.08-	1999.09			F	Saloon Engine UKZ(ZPJ4/Z)	GC010029	Outer Joint	29T	28	27	58	89	63
	1989.08-	1999.09			F	Saloon Engine UKZ(ZPJ4/Z)	GC010047	Outer Joint		28	27	58	89	63
	1989.08-	1999.09			F	Saloon Engine UKZ(ZPJ4/Z)	GC010008	Outer Joint	48T	28	27	58	89	63
	1989.08-	1999.09		R	F	Saloon Engine UKZ(ZPJ4/Z)	GDS10190	Drive Shaft	29T	28	37	58	88	935
	1989.08-	1999.09		L	F	Saloon Engine UKZ(ZPJ4/Z)	GDS10191	Drive Shaft	29T	28	37	58	88	642
<b>607 (9D, 9U)</b>														
2.0 (100 kW)	2001.04-	2004.11	MT	R	F	Saloon Engine RFN(EW10J4)	GDS10221	Drive Shaft	48T	28	37	58	89	948
2.0 HDi (79 kW)	2001.03-	2004.07	MT	R	F	Saloon Engine RHS(DW10ATED)	GDS10221	Drive Shaft	48T	28	37	58	89	948
2.0 HDi (80 kW)	2001.04-	2005.10	MT	R	F	Saloon Engine RHZ(DW10ATED)	GDS10221	Drive Shaft	48T	28	37	58	89	948
2.2 16V (116 kW)	2000.02-		MT	R	F	Saloon Engine 3FZ(EW12J4)	GDS10221	Drive Shaft	48T	28	37	58	89	948
2.2 16V (120 kW)	2005.09-		MT				GC010051	Outer Joint		28	39	58.6	94	63
2.2 HDi (125 kW)	2006.05-		MT	R	F	Saloon Engine 4HT(DW12BTED4)	GDS10221	Drive Shaft	48T	28	37	58	89	948
2.2 HDi (98 kW)	2000.02-			R	F	Saloon Engine 4HX(DW12TED4/FAP)	GDS45165	Drive Shaft	48T	28	37	58	89	960
	2000.02-			L	F	Saloon Engine 4HX(DW12TED4/FAP)	GDS45166	Drive Shaft	48T	28	37	58	88	648
	2000.02-		MT	R	F	Saloon Engine 4HX(DW12TED4/FAP)	GDS10221	Drive Shaft	48T	28	37	58	89	948
2.7 HDi 24V (150 kW)	2004.12-		AT	R	F	Saloon Engine DT17TED4	GDS10396	Drive Shaft		28	37	58.6	94	925
3.0 V6 24V (152 kW)	2000.02-		AT	R	F	Saloon Engine XFX(ES9J4S)	GDS10396	Drive Shaft		28	37	58.6	94	925
3.0 V6 24V (155 kW)	2005.10-		AT	R	F	Saloon Engine XFX(ES9A)	GDS10396	Drive Shaft		28	37	58.6	94	925
<b>806 (221)</b>														
1.8 (73 kW)	1995.07-	2002.08			F	MPV Engine LFW(XU7JP)	GC010018	Outer Joint	48T	27	34	61	82	55
	1995.07-	2002.08	MT	L	F	MPV Engine LFW(XU7JP)	GDS10052	Drive Shaft		27	24	61	82	648
	1995.07-	2002.08	MT	L	F	MPV Engine LFW(XU7JP)	GDS10082	Drive Shaft	48T	27	24	59	82	648
	1995.07-	2002.08	MT	R	F	MPV Engine LFW(XU7JP)	GDS10120	Drive Shaft		27	24	59	82	928
	1995.07-	2002.08	MT	R	F	MPV Engine LFW(XU7JP)	GDS10012	Drive Shaft	48T	27	24	64	80.5	928
1.9 TD (66 kW)	1995.07-	2002.08			F	MPV Engine DHX(XUD9TE)	GC010015	Outer Joint	48T	27	39	59	82	63
	1995.07-	2002.08	MT	L	F	MPV Engine DHX(XUD9TE)	GDS10016	Drive Shaft	48T	27	37	59	82	641
	1995.07-	2002.08	MT	L	F	MPV Engine DHX(XUD9TE)	GDS10072	Drive Shaft		27	37	59	82	641
	1995.07-	2002.08	MT	R	F	MPV Engine DHX(XUD9TE)	GDS10155	Drive Shaft		27	37	59	82	947
	1995.07-	2002.08	MT	R	F	MPV Engine DHX(XUD9TE)	GDS10014	Drive Shaft	48T	27	37	59	82	947
	1995.07-	2002.08					GC010015	Outer Joint	48T	27	39	59	82	63
1.9 TD (68 kW)	1995.07-	2002.08					GC010015	Outer Joint	48T	27	39	59	82	63
	1997.05-	2002.08			F	MPV Engine DHY(XUD9TE)	GC010014	Outer Joint		27	39	59	82	63
	1997.05-	2002.08			F	MPV Engine DHY(XUD9TE)	GC010015	Outer Joint	48T	27	39	59	82	63
	1997.05-	2002.08	MT	L	F	MPV Engine DHY(XUD9TE)	GDS10016	Drive Shaft	48T	27	37	59	82	641
	1997.05-	2002.08	MT	L	F	MPV Engine DHY(XUD9TE)	GDS10072	Drive Shaft		27	37	59	82	641
	1997.05-	2002.08	MT	R	F	MPV Engine DHY(XUD9TE)	GDS10155	Drive Shaft		27	37	59	82	947
	1997.05-	2002.08	MT	R	F	MPV Engine DHY(XUD9TE)	GDS10014	Drive Shaft	48T	27	37	59	82	947
2.0 (89 kW)	1994.06-	2002.08			F	MPV Engine RFU(XU10J2)	GC010059	Outer Joint	48T	27	34	59	82	55
	1994.06-	2002.08			F	MPV Engine RFU(XU10J2)	GC010016	Outer Joint		27	34	59	82	55
	1994.06-	2002.08			F	MPV Engine RFU(XU10J2)	GC010018	Outer Joint	48T	27	34	61	82	55
	1994.06-	2002.08	MT	L	F	MPV Engine RFU(XU10J2)	GDS10052	Drive Shaft		27	24	61	82	648
	1994.06-	2002.08	MT	L	F	MPV Engine RFU(XU10J2)	GDS10082	Drive Shaft	48T	27	24	59	82	648
	1994.06-	2002.08	MT	R	F	MPV Engine RFU(XU10J2)	GDS10120	Drive Shaft		27	24	59	82	928
	1994.06-	2002.08	MT	R	F	MPV Engine RFU(XU10J2)	GDS10012	Drive Shaft	48T	27	24	64	80.5	928
2.0 16V (100 kW)	2000.09-	2002.08			F	MPV Engine RFN(EW10J4)	GC010018	Outer Joint	48T	27	34	61	82	55
2.0 HDi (80 kW)	1999.08-	2002.08			F	MPV Engine RHZ(DW10ATED)	GC010015	Outer Joint	48T	27	39	59	82	63
	1999.08-	2002.08	MT	L	F	MPV Engine RHZ(DW10ATED)	GDS10016	Drive Shaft	48T	27	37	59	82	641
	1999.08-	2002.08	MT	L	F	MPV Engine RHZ(DW10ATED)	GDS10072	Drive Shaft		27	37	59	82	641
	1999.08-	2002.08	MT	R	F	MPV Engine RHZ(DW10ATED)	GDS10155	Drive Shaft		27	37	59	82	947
	1999.08-	2002.08	MT	R	F	MPV Engine RHZ(DW10ATED)	GDS10014	Drive Shaft	48T	27	37	59	82	947
	1999.08-	2002.08		R	F	MPV Engine RHZ(DW10ATED)	GDS10237	Drive Shaft	48T	27	37	59	82	953
2.0 HDi 16V (80 kW)	1999.08-	2002.05			F	MPV Engine RHW(DW10ATED4)	GC010015	Outer Joint	48T	27	39	59	82	63
2.0 T (108 kW)	1994.06-	2002.08					GC010015	Outer Joint	48T	27	39	59	82	63
2.0 Turbo (108 kW)	1994.06-	2002.08	MT	R	F	MPV Engine RGX(XU10J2TE)	GDS10014	Drive Shaft	48T	27	37	59	82	947
	1994.06-	2002.08			F	MPV Engine RGX(XU10J2TE)	GC010014	Outer Joint		27	39	59	82	63
	1994.06-	2002.08			F	MPV Engine RGX(XU10J2TE)	GC010015	Outer Joint	48T	27	39	59	82	63
	1994.06-	2002.08	MT	L	F	MPV Engine RGX(XU10J2TE)	GDS10016	Drive Shaft	48T	27	37	59	82	641

		TRANSM	L/R	F/R		G-AP Ref.	PRODUCT	ABS	Technical Specifications													
									YEAR	A	B	C	H	L	P							
<b>PEUGEOT</b>																						
<b>806 (221)</b>																						
2.0 Turbo (108 kW)	1994.06-	2002.08	MT	L	F	MPV Engine RGX(XU10J2TE)	GDS10072	Drive Shaft		27	37	59	82	641								
	1994.06-	2002.08	MT	R	F	MPV Engine RGX(XU10J2TE)	GDS10155	Drive Shaft		27	37	59	82	947								
<b>807 (E)</b>																						
2.0 (100 kW)	2002.06-		MT	L	F	MPV Engine RFN(EW10J4)	GDS10422	Drive Shaft		27	24	58	81.5	659								
	2002.06-		AT	R	F	MPV Engine RFN(EW10J4)	GDS10425	Drive Shaft		27	26	59	82	855								
2.0 16V (103 kW)	2005.10-		MT	L	F	MPV Engine RFJ(EW10A)	GDS10422	Drive Shaft		27	24	58	81.5	659								
	2005.10-		AT	R	F	MPV Engine RFJ(EW10A)	GDS10425	Drive Shaft		27	26	59	82	855								
2.0 HDi (100 kW)	2006.06-						GCO17044	Outer Joint		27	28	58	81.5	62	M							
2.0 HDi (120 kW)	2009.06-		MT	L	F	MPV Engine RHH(DW10CTED4)	GDS10424	Drive Shaft		27	37	61.3	84	637								
2.0 HDi (79 kW)	2002.06-				F	MPV Engine RHM(DW10ATED4)/RHT(DW10ATED4)/RHW(DW10ATED4)	GCO17044	Outer Joint		27	28	58	81.5	62	M							
	2002.06-			L	F	MPV Engine RHM(DW10ATED4)/RHT(DW10ATED4)/RHW(DW10ATED4)	GDS10423	Drive Shaft		27	26	58	81.5	635								
	2002.06-		MT	R	F	MPV Engine RHM(DW10ATED4)/RHT(DW10ATED4)/RHW(DW10ATED4)	GDS18291	Drive Shaft		27	37	58	81	977								
	2002.06-				R	F	MPV Engine RHM(DW10ATED4)/RHT(DW10ATED4)/RHW(DW10ATED4)	GDS10425	Drive Shaft		27	26	59	82	855							
	2002.06-						GCO17044	Outer Joint		27	28	58	81.5	62	M							
2.0 HDi (80 kW)	2004.04-	2006.05			F	MPV Engine RHW(DW10ATED4)	GCO17044	Outer Joint		27	28	58	81.5	62	M							
	2004.04-	2006.05	MT	R	F	MPV Engine RHW(DW10ATED4)	GDS18291	Drive Shaft		27	37	58	81	977								
	2004.04-	2006.05					GCO17044	Outer Joint		27	28	58	81.5	62	M							
2.0 HDi (88 kW)	2006.11-						GCO17044	Outer Joint		27	28	58	81.5	62	M							
2.2 (116 kW)	2002.06-			R	F	MPV Engine 3FZ(EW12J4)	GDS18291	Drive Shaft		27	37	58	81	977								
2.2 HDi (125 kW)	2006.06-		MT	L	F	MPV Engine 4HT(DW12BTED4)	GDS10424	Drive Shaft		27	37	61.3	84	637								
	2006.06-		MT	R	F	MPV Engine 4HT(DW12BTED4)	GDS18291	Drive Shaft		27	37	58	81	977								
2.2 HDi (94 kW)	2002.06-				F	MPV Engine 4HX(DW12TED4/FAP)	GCO10052	Outer Joint		28	34	58.5	92	55	I							
	2002.06-		MT	R	F	MPV Engine 4HX(DW12TED4/FAP)	GDS18291	Drive Shaft		27	37	58	81	977								
<b>BIPPER</b>																						
1.4 HDi	2007-			L	F		GCI17029	Inner Joint		22	22	40	58.5	101								
<b>BIPPER (AA_)</b>																						
1.4 (54 kW)	2008.02-			L/R	F	Box Engine KFV(TU3A)	GCO17070	Outer Joint		22	22	51	79	57.5	M							
1.4 HDi (50 kW)	2008.02-		MT	L	F	Box Engine 8HS(DV4TD)	GDS17151	Drive Shaft		25	22	51	84	656								
	2008.02-		MT	L	F	Box Engine 8HS(DV4TD)	GCI17029	Inner Joint		22	22	40	58.5	101								
	2008.02-		MT	L	F	Box Engine 8HS(DV4TD)	GCO17067	Outer Joint		25	22	51	84	57.5	M							
	2008.02-		MT	R	F	Box Engine 8HS(DV4TD)	GDS17052	Drive Shaft		25	22	51	84	879								
	2008.02-		MT	R	F	Box Engine 8HS(DV4TD)	GCI17030	Inner Joint		22	22	43.1	96.5	99								
	2008.02-		MT	R	F	Box Engine 8HS(DV4TD)	GCO17068	Outer Joint		25	22	51	84	57.5	M							
<b>BIPPER TEPEE</b>																						
1.4 (54 kW)	2008.04-			L/R	F	Estate Engine KFV(TU3A)	GCO17070	Outer Joint		22	22	51	79	57.5	M							
1.4 HDi (50 kW)	2008.04-		MT	L	F	Estate Engine 8HS(DV4TD)	GDS17151	Drive Shaft		25	22	51	84	656								
	2008.04-		MT	L	F	Estate Engine 8HS(DV4TD)	GCI17029	Inner Joint		22	22	40	58.5	101								
	2008.04-		MT	L	F	Estate Engine 8HS(DV4TD)	GCO17067	Outer Joint		25	22	51	84	57.5	M							
	2008.04-		MT	R	F	Estate Engine 8HS(DV4TD)	GDS17052	Drive Shaft		25	22	51	84	879								
	2008.04-		MT	R	F	Estate Engine 8HS(DV4TD)	GCI17030	Inner Joint		22	22	43.1	96.5	99								
	2008.04-		MT	R	F	Estate Engine 8HS(DV4TD)	GCO17068	Outer Joint		25	22	51	84	57.5	M							
<b>BOXER</b>																						
2.2 HDi (74 kW)	2006.04-		5MT/6MT		F	Box Engine 4HV(P22DTE)	GCO17045	Outer Joint		35	29	71.5	127	71	M							
	2006.04-		5MT/6MT		F	Box Engine 4HV(P22DTE)	GCO17055	Outer Joint		35	27	71.5	127	66.5	I							
	2006.04-		5MT/6MT		F	Box Engine 4HV(P22DTE)	GCI17020	Inner Joint		41	29	34.85	403	109								
	2006.04-		5MT/6MT		F	Box Engine 4HV(P22DTE)	GCI10038	Inner Joint		41	27	34.85	403	102								
	2006.04-		5MT/6MT		F	Bus Engine 4HV(P22DTE)	GCO17045	Outer Joint		35	29	71.5	127	71	M							
	2006.04-		5MT/6MT		F	Bus Engine 4HV(P22DTE)	GCO17055	Outer Joint		35	27	71.5	127	66.5	I							
	2006.04-		5MT/6MT		F	Bus Engine 4HV(P22DTE)	GCI17020	Inner Joint		41	29	34.85	403	109								
	2006.04-		5MT/6MT		F	Bus Engine 4HV(P22DTE)	GCI10038	Inner Joint		41	27	34.85	403	102								
	2006.04-		5MT/6MT		F	Platform/Chassis Engine 4HV(P22DTE)	GCO17045	Outer Joint		35	29	71.5	127	71	M							
	2006.04-		5MT/6MT		F	Platform/Chassis Engine 4HV(P22DTE)	GCO17055	Outer Joint		35	27	71.5	127	66.5	I							
	2006.04-		5MT/6MT		F	Platform/Chassis Engine 4HV(P22DTE)	GCI17020	Inner Joint		41	29	34.85	403	109								
	2006.04-		5MT/6MT		F	Platform/Chassis Engine 4HV(P22DTE)	GCI10038	Inner Joint		41	27	34.85	403	102								
	2006.04-		5MT/6MT	L	F	Box Engine 4HV(P22DTE)	GCI17042	Inner Joint		41	27	43	70	102								
	2006.04-		5MT/6MT	L	F	Box Engine 4HV(P22DTE)	GCI17028	Inner Joint		41	29	43	69.5	109.5								
	2006.04-		5MT/6MT	L	F	Bus Engine 4HV(P22DTE)	GCI17042	Inner Joint		41	27	43	70	102								
	2006.04-		5MT/6MT	L	F	Bus Engine 4HV(P22DTE)	GCI17028	Inner Joint		41	29	43	69.5	109.5								
	2006.04-		5MT/6MT	L	F	Platform/Chassis Engine 4HV(P22DTE)	GCI17042	Inner Joint		41	27	43	70	102								
	2006.04-		5MT/6MT	L	F	Platform/Chassis Engine 4HV(P22DTE)	GCI17028	Inner Joint		41	29	43	69.5	109.5								
	2006.04-		5MT/6MT	L	F	Box Engine 4HV(P22DTE)	GDS45176	Drive Shaft		35	41	71.5	127	808								



		TRANSM	L/R	F/R		G-AP Ref.	PRODUCT	ABS	Technical Specifications									
									YEAR	A	B	C	H	L	P			
<b>PEUGEOT BOXER</b>																		
2.2 HDi (74 kW)	2006.04-			L	F	Bus Engine 4HV(P22DTE)	GDS45176	Drive Shaft		35	41	71.5	127	808				
	2006.04-			L	F	Platform/Chassis Engine 4HV(P22DTE)	GDS45176	Drive Shaft		35	41	71.5	127	808				
	2006.04-			R	F	Box Engine 4HV(P22DTE)	GDS17050	Drive Shaft		35	41	71.5	127	1140				
	2006.04-			R	F	Bus Engine 4HV(P22DTE)	GDS17050	Drive Shaft		35	41	71.5	127	1140				
	2006.04-			R	F	Platform/Chassis Engine 4HV(P22DTE)	GDS17050	Drive Shaft		35	41	71.5	127	1140				
2.2 HDi (88 kW)	2006.04-		5MT/6MT		F	Box Engine 4HU(P22DTE)	GC017045	Outer Joint		35	29	71.5	127	71	M			
	2006.04-		5MT/6MT		F	Box Engine 4HU(P22DTE)	GC017055	Outer Joint		35	27	71.5	127	66.5	I			
	2006.04-		5MT/6MT		F	Box Engine 4HU(P22DTE)	GCI17020	Inner Joint		41	29	34.85	403	109				
	2006.04-		5MT/6MT		F	Box Engine 4HU(P22DTE)	GCI10038	Inner Joint		41	27	34.85	403	102				
	2006.04-		5MT/6MT		F	Bus Engine 4HU(P22DTE)	GC017045	Outer Joint		35	29	71.5	127	71	M			
	2006.04-		5MT/6MT		F	Bus Engine 4HU(P22DTE)	GC017055	Outer Joint		35	27	71.5	127	66.5	I			
	2006.04-		5MT/6MT		F	Bus Engine 4HU(P22DTE)	GCI17020	Inner Joint		41	29	34.85	403	109				
	2006.04-		5MT/6MT		F	Bus Engine 4HU(P22DTE)	GCI10038	Inner Joint		41	27	34.85	403	102				
	2006.04-		5MT/6MT	L	F	Box Engine 4HU(P22DTE)	GCI17042	Inner Joint		41	27	43	70	102				
	2006.04-		5MT/6MT	L	F	Box Engine 4HU(P22DTE)	GCI17028	Inner Joint		41	29	43	69.5	109.5				
	2006.04-		5MT/6MT	L	F	Bus Engine 4HU(P22DTE)	GCI17042	Inner Joint		41	27	43	70	102				
	2006.04-		5MT/6MT	L	F	Bus Engine 4HU(P22DTE)	GCI17028	Inner Joint		41	29	43	69.5	109.5				
	2006.04-		5MT/6MT	L	F	Platform/Chassis Engine 4HU(P22DTE)	GCI17042	Inner Joint		41	27	43	70	102				
	2006.04-		5MT/6MT	L	F	Platform/Chassis Engine 4HU(P22DTE)	GCI17028	Inner Joint		41	29	43	69.5	109.5				
	2006.04-		5MT/6MT	L	F	Box Engine 4HU(P22DTE)	GDS45176	Drive Shaft		35	41	71.5	127	808				
	2006.04-				L	F	Bus Engine 4HU(P22DTE)	GDS45176	Drive Shaft		35	41	71.5	127	808			
	2006.04-				L	F	Platform/Chassis Engine 4HU(P22DTE)	GDS45176	Drive Shaft		35	41	71.5	127	808			
	2006.04-				R	F	Box Engine 4HU(P22DTE)	GDS17050	Drive Shaft		35	41	71.5	127	1140			
	2006.04-				R	F	Bus Engine 4HU(P22DTE)	GDS17050	Drive Shaft		35	41	71.5	127	1140			
	2006.04-				R	F	Platform/Chassis Engine 4HU(P22DTE)	GDS17050	Drive Shaft		35	41	71.5	127	1140			
	3.0 HDi (115 kW)	2006.07-			L	F	Box	GDS45175	Drive Shaft		35	31	71.5	127	749.5			
		2006.07-			L	F	Box	GCI17022	Inner Joint		31	29	44.95	77	109.5			
		2006.07-		L/R	F	F	Box	GC017060	Outer Joint		35	29	71.5	127	71	I		
		2006.07-			R	F	Box	GDS45174	Drive Shaft		35	31	71.5	127	1199			
		2006.07-			R	F	Box	GCI17021	Inner Joint		31	29	34.85	530	109			
3.0 HDi (116 kW)	2006.04-		6MT		F	Box Engine F1CE0481D(F30DT)	GC017060	Outer Joint		35	29	71.5	127	71	I			
	2006.04-		6MT		F	Box Engine F1CE0481D(F30DT)	GCI17021	Inner Joint		31	29	34.85	530	109				
	2006.04-		6MT		F	Box Engine F1CE0481D(F30DT)	GCI17022	Inner Joint		31	29	44.95	77	109.5				
	2006.04-		6MT		F	Bus Engine F1CE0481D(F30DT)	GC017060	Outer Joint		35	29	71.5	127	71	I			
	2006.04-		6MT		F	Bus Engine F1CE0481D(F30DT)	GCI17021	Inner Joint		31	29	34.85	530	109				
	2006.04-		6MT		F	Bus Engine F1CE0481D(F30DT)	GCI17022	Inner Joint		31	29	44.95	77	109.5				
	2006.04-			L	F	Box Engine F1CE0481D(F30DT)	GDS45175	Drive Shaft		35	31	71.5	127	749.5				
	2006.04-			L	F	Box Engine F1CE0481D(F30DT)	GCI17022	Inner Joint		31	29	44.95	77	109.5				
	2006.04-			L	F	Platform/Chassis Engine F1CE0481D(F30DT)	GDS45175	Drive Shaft		35	31	71.5	127	749.5				
	2006.04-			L	F	Platform/Chassis Engine F1CE0481D(F30DT)	GCI17022	Inner Joint		31	29	44.95	77	109.5				
	2006.04-			L/R	F	Box Engine F1CE0481D(F30DT)	GC017060	Outer Joint		35	29	71.5	127	71	I			
	2006.04-			L/R	F	Platform/Chassis Engine F1CE0481D(F30DT)	GC017060	Outer Joint		35	29	71.5	127	71	I			
	2006.04-			R	F	Box Engine F1CE0481D(F30DT)	GDS45174	Drive Shaft		35	31	71.5	127	1199				
	2006.04-			R	F	Box Engine F1CE0481D(F30DT)	GCI17021	Inner Joint		31	29	34.85	530	109				
	2006.04-			R	F	Bus Engine F1CE0481D(F30DT)	GDS45174	Drive Shaft		35	31	71.5	127	1199				
	2006.04-			R	F	Bus Engine F1CE0481D(F30DT)	GCI17021	Inner Joint		31	29	34.85	530	109				
	2006.04-			R	F	Bus Engine F1CE0481D(F30DT)	GC017060	Outer Joint		35	29	71.5	127	71	I			
	2006.04-			R	F	Platform/Chassis Engine F1CE0481D(F30DT)	GDS45174	Drive Shaft		35	31	71.5	127	1199				
	2006.04-			R	F	Platform/Chassis Engine F1CE0481D(F30DT)	GCI17021	Inner Joint		31	29	34.85	530	109				
	<b>BOXER (230L)</b>																	
1.9 D (50 kW)	1999.07-	2002.04	MT		F	Box Engine DJY(XUD9A)	GC010011	Outer Joint	54T	35	45	70	117	73	I			
	1999.07-	2002.04	MT		F	Box Engine DJY(XUD9A)	GC010013	Outer Joint	54T	28	39	63	112.5	63	I			
	1999.07-	2002.04	MT		F	Box Engine DJY(XUD9A)	GC010050	Outer Joint		35	45	70	117	73	I			
	1999.07-	2002.04	MT		F	Box Engine DJY(XUD9A)	GC010012	Outer Joint		28	39	63	112.5	63	I			
	1999.07-	2002.04	MT	L	F	Box Engine DJY(XUD9A)	GDS10033	Drive Shaft	54T	35	41	70	117	762				
	1999.07-	2002.04	MT	L	F	Box Engine DJY(XUD9A)	GDS10105	Drive Shaft		28	37	63	112.5	771				
	1999.07-	2002.04	MT	L	F	Box Engine DJY(XUD9A)	GDS10067	Drive Shaft		35	41	70	117	762				





		YEAR	TRANSM	L/R	F/R		G-AP Ref.	PRODUCT	ABS	Technical Specifications										
										A	B	C	H	L	P					
<b>PEUGEOT BOXER (230L)</b>																				
1.9 D (50 kW)	1999.07-	2002.04	MT	L	F	Box Engine DJY(XUD9A)	GDS10035	Drive Shaft	54T	28	41	63	112.5	757.5						
	1999.07-	2002.04	MT	L	F	Box Engine DJY(XUD9A)	GDS10102	Drive Shaft		28	41	63	112.5	757.5						
	1999.07-	2002.04	MT	L	F	Box Engine DJY(XUD9A)	GDS10037	Drive Shaft	54T	28	37	63	112.5	771						
	1999.07-	2002.04	MT	R	F	Box Engine DJY(XUD9A)	GDS10103	Drive Shaft		28	41	63	112.5	1079						
	1999.07-	2002.04	MT	R	F	Box Engine DJY(XUD9A)	GDS10104	Drive Shaft	54T	28	37	63	112.5	1072						
	1999.07-	2002.04	MT	R	F	Box Engine DJY(XUD9A)	GDS10032	Drive Shaft	54T	35	41	70	117	1085						
	1999.07-	2002.04	MT	R	F	Box Engine DJY(XUD9A)	GDS10069	Drive Shaft		28	37	63	112.5	1072						
	1999.07-	2002.04	MT	R	F	Box Engine DJY(XUD9A)	GDS10066	Drive Shaft		35	41	70	117	1085						
	1999.07-	2002.04	MT	R	F	Box Engine DJY(XUD9A)	GDS10036	Drive Shaft	54T	28	41	63	112.5	1079						
1.9 D (51 kW)	1994.03-	2002.04	MT		F	Box Engine D9B(XUD9AU)	GC010011	Outer Joint	54T	35	45	70	117	73	I					
	1994.03-	2002.04	MT		F	Box Engine D9B(XUD9AU)	GC010013	Outer Joint	54T	28	39	63	112.5	63	I					
	1994.03-	2002.04	MT		F	Box Engine D9B(XUD9AU)	GC010050	Outer Joint		35	45	70	117	73	I					
	1994.03-	2002.04	MT		F	Box Engine D9B(XUD9AU)	GC010012	Outer Joint		28	39	63	112.5	63	I					
	1994.03-	2002.04	MT	L	F	Box Engine D9B(XUD9AU)	GDS10033	Drive Shaft	54T	35	41	70	117	762						
	1994.03-	2002.04	MT	L	F	Box Engine D9B(XUD9AU)	GDS10105	Drive Shaft		28	37	63	112.5	771						
	1994.03-	2002.04	MT	L	F	Box Engine D9B(XUD9AU)	GDS10067	Drive Shaft		35	41	70	117	762						
	1994.03-	2002.04	MT	L	F	Box Engine D9B(XUD9AU)	GDS10035	Drive Shaft	54T	28	41	63	112.5	757.5						
	1994.03-	2002.04	MT	L	F	Box Engine D9B(XUD9AU)	GDS10102	Drive Shaft		28	41	63	112.5	757.5						
	1994.03-	2002.04	MT	L	F	Box Engine D9B(XUD9AU)	GDS10037	Drive Shaft	54T	28	37	63	112.5	771						
	1994.03-	2002.04	MT	R	F	Box Engine D9B(XUD9AU)	GDS10103	Drive Shaft		28	41	63	112.5	1079						
	1994.03-	2002.04	MT	R	F	Box Engine D9B(XUD9AU)	GDS10104	Drive Shaft	54T	28	37	63	112.5	1072						
	1994.03-	2002.04	MT	R	F	Box Engine D9B(XUD9AU)	GDS10032	Drive Shaft	54T	35	41	70	117	1085						
	1994.03-	2002.04	MT	R	F	Box Engine D9B(XUD9AU)	GDS10069	Drive Shaft		28	37	63	112.5	1072						
	1994.03-	2002.04	MT	R	F	Box Engine D9B(XUD9AU)	GDS10066	Drive Shaft		35	41	70	117	1085						
	1994.03-	2002.04	MT	R	F	Box Engine D9B(XUD9AU)	GDS10036	Drive Shaft	54T	28	41	63	112.5	1079						
1.9 TD (68 kW)	1994.03-	2002.04	MT		F	Box Engine D8C(XUD9UTF)	GC010011	Outer Joint	54T	35	45	70	117	73	I					
	1994.03-	2002.04	MT		F	Box Engine D8C(XUD9UTF)	GC010013	Outer Joint	54T	28	39	63	112.5	63	I					
	1994.03-	2002.04	MT		F	Box Engine D8C(XUD9UTF)	GC010050	Outer Joint		35	45	70	117	73	I					
	1994.03-	2002.04	MT		F	Box Engine D8C(XUD9UTF)	GC010012	Outer Joint		28	39	63	112.5	63	I					
	1994.03-	2002.04	MT	L	F	Box Engine D8C(XUD9UTF)	GDS10033	Drive Shaft	54T	35	41	70	117	762						
	1994.03-	2002.04	MT	L	F	Box Engine D8C(XUD9UTF)	GDS10105	Drive Shaft		28	37	63	112.5	771						
	1994.03-	2002.04	MT	L	F	Box Engine D8C(XUD9UTF)	GDS10067	Drive Shaft		35	41	70	117	762						
	1994.03-	2002.04	MT	L	F	Box Engine D8C(XUD9UTF)	GDS10035	Drive Shaft	54T	28	41	63	112.5	757.5						
	1994.03-	2002.04	MT	L	F	Box Engine D8C(XUD9UTF)	GDS10102	Drive Shaft		28	41	63	112.5	757.5						
	1994.03-	2002.04	MT	L	F	Box Engine D8C(XUD9UTF)	GDS10037	Drive Shaft	54T	28	37	63	112.5	771						
	1994.03-	2002.04	MT	R	F	Box Engine D8C(XUD9UTF)	GDS10103	Drive Shaft		28	41	63	112.5	1079						
	1994.03-	2002.04	MT	R	F	Box Engine D8C(XUD9UTF)	GDS10104	Drive Shaft	54T	28	37	63	112.5	1072						
	1994.03-	2002.04	MT	R	F	Box Engine D8C(XUD9UTF)	GDS10032	Drive Shaft	54T	35	41	70	117	1085						
	1994.03-	2002.04	MT	R	F	Box Engine D8C(XUD9UTF)	GDS10069	Drive Shaft		28	37	63	112.5	1072						
	1994.03-	2002.04	MT	R	F	Box Engine D8C(XUD9UTF)	GDS10066	Drive Shaft		35	41	70	117	1085						
	1994.03-	2002.04	MT	R	F	Box Engine D8C(XUD9UTF)	GDS10036	Drive Shaft	54T	28	41	63	112.5	1079						
2.0 i (80 kW)	1994.06-	2002.04	MT		F	Box Engine RFW(XU10J2)	GC010011	Outer Joint	54T	35	45	70	117	73	I					
	1994.06-	2002.04	MT		F	Box Engine RFW(XU10J2)	GC010013	Outer Joint	54T	28	39	63	112.5	63	I					
	1994.06-	2002.04	MT		F	Box Engine RFW(XU10J2)	GC010050	Outer Joint		35	45	70	117	73	I					
	1994.06-	2002.04	MT		F	Box Engine RFW(XU10J2)	GC010012	Outer Joint		28	39	63	112.5	63	I					
	1994.06-	2002.04	MT	L	F	Box Engine RFW(XU10J2)	GDS10033	Drive Shaft	54T	35	41	70	117	762						
	1994.06-	2002.04	MT	L	F	Box Engine RFW(XU10J2)	GDS10105	Drive Shaft		28	37	63	112.5	771						
	1994.06-	2002.04	MT	L	F	Box Engine RFW(XU10J2)	GDS10067	Drive Shaft		35	41	70	117	762						
	1994.06-	2002.04	MT	L	F	Box Engine RFW(XU10J2)	GDS10035	Drive Shaft	54T	28	41	63	112.5	757.5						
	1994.06-	2002.04	MT	L	F	Box Engine RFW(XU10J2)	GDS10102	Drive Shaft		28	41	63	112.5	757.5						
	1994.06-	2002.04	MT	L	F	Box Engine RFW(XU10J2)	GDS10037	Drive Shaft	54T	28	37	63	112.5	771						
	1994.06-	2002.04	MT	R	F	Box Engine RFW(XU10J2)	GDS10103	Drive Shaft		28	41	63	112.5	1079						
	1994.06-	2002.04	MT	R	F	Box Engine RFW(XU10J2)	GDS10104	Drive Shaft	54T	28	37	63	112.5	1072						
	1994.06-	2002.04	MT	R	F	Box Engine RFW(XU10J2)	GDS10032	Drive Shaft	54T	35	41	70	117	1085						
	1994.06-	2002.04	MT	R	F	Box Engine RFW(XU10J2)	GDS10069	Drive Shaft		28	37	63	112.5	1072						
	1994.06-	2002.04	MT	R	F	Box Engine RFW(XU10J2)	GDS10066	Drive Shaft		35	41	70	117	1085						
	1994.06-	2002.04	MT	R	F	Box Engine RFW(XU10J2)	GDS10036	Drive Shaft	54T	28	41	63	112.5	1079						
2.5 D (63 kW)	1994.03-	2002.04	MT		F	Box Engine T9A(DJ5)	GC010011	Outer Joint	54T	35	45	70	117	73	I					
	1994.03-	2002.04	MT		F	Box Engine T9A(DJ5)	GC010013	Outer Joint	54T	28	39	63	112.5	63	I					
	1994.03-	2002.04	MT		F	Box Engine T9A(DJ5)	GC010050	Outer Joint		35	45	70	117	73	I					
	1994.03-	2002.04	MT		F	Box Engine T9A(DJ5)	GC010012	Outer Joint		28	39	63	112.5	63	I					



		TRANSM	L/R	F/R		G-AP Ref.	PRODUCT	ABS	Technical Specifications								
									YEAR	A	B	C	H	L	P		
<b>PEUGEOT BOXER (230L)</b>																	
2.5 D (63 kW)	1994.03-	2002.04	MT	L	F	Box Engine T9A(DJ5)	GDS10033	Drive Shaft	54T	35	41	70	117	762			
	1994.03-	2002.04	MT	L	F	Box Engine T9A(DJ5)	GDS10105	Drive Shaft		28	37	63	112.5	771			
	1994.03-	2002.04	MT	L	F	Box Engine T9A(DJ5)	GDS10067	Drive Shaft		35	41	70	117	762			
	1994.03-	2002.04	MT	L	F	Box Engine T9A(DJ5)	GDS10035	Drive Shaft	54T	28	41	63	112.5	757.5			
	1994.03-	2002.04	MT	L	F	Box Engine T9A(DJ5)	GDS10102	Drive Shaft		28	41	63	112.5	757.5			
	1994.03-	2002.04	MT	L	F	Box Engine T9A(DJ5)	GDS10037	Drive Shaft	54T	28	37	63	112.5	771			
	1994.03-	2002.04	MT	R	F	Box Engine T9A(DJ5)	GDS10103	Drive Shaft		28	41	63	112.5	1079			
	1994.03-	2002.04	MT	R	F	Box Engine T9A(DJ5)	GDS10104	Drive Shaft	54T	28	37	63	112.5	1072			
	1994.03-	2002.04	MT	R	F	Box Engine T9A(DJ5)	GDS10032	Drive Shaft	54T	35	41	70	117	1085			
	1994.03-	2002.04	MT	R	F	Box Engine T9A(DJ5)	GDS10069	Drive Shaft		28	37	63	112.5	1072			
	1994.03-	2002.04	MT	R	F	Box Engine T9A(DJ5)	GDS10066	Drive Shaft		35	41	70	117	1085			
	1994.03-	2002.04	MT	R	F	Box Engine T9A(DJ5)	GDS10036	Drive Shaft	54T	28	41	63	112.5	1079			
2.5 D 4x4 (63 kW)	1999.07-	2002.04	MT		F	Box Engine T9A(DJ5)	GCO10011	Outer Joint	54T	35	45	70	117	73	I		
	1999.07-	2002.04	MT		F	Box Engine T9A(DJ5)	GCO10013	Outer Joint	54T	28	39	63	112.5	63	I		
	1999.07-	2002.04	MT		F	Box Engine T9A(DJ5)	GCO10050	Outer Joint		35	45	70	117	73	I		
	1999.07-	2002.04	MT		F	Box Engine T9A(DJ5)	GCO10012	Outer Joint		28	39	63	112.5	63	I		
	1999.07-	2002.04	MT	L	F	Box Engine T9A(DJ5)	GDS10033	Drive Shaft	54T	35	41	70	117	762			
	1999.07-	2002.04	MT	L	F	Box Engine T9A(DJ5)	GDS10105	Drive Shaft		28	37	63	112.5	771			
	1999.07-	2002.04	MT	L	F	Box Engine T9A(DJ5)	GDS10067	Drive Shaft		35	41	70	117	762			
	1999.07-	2002.04	MT	L	F	Box Engine T9A(DJ5)	GDS10035	Drive Shaft	54T	28	41	63	112.5	757.5			
	1999.07-	2002.04	MT	L	F	Box Engine T9A(DJ5)	GDS10102	Drive Shaft		28	41	63	112.5	757.5			
	1999.07-	2002.04	MT	L	F	Box Engine T9A(DJ5)	GDS10037	Drive Shaft	54T	28	37	63	112.5	771			
	1999.07-	2002.04	MT	R	F	Box Engine T9A(DJ5)	GDS10103	Drive Shaft		28	41	63	112.5	1079			
	1999.07-	2002.04	MT	R	F	Box Engine T9A(DJ5)	GDS10104	Drive Shaft	54T	28	37	63	112.5	1072			
	1999.07-	2002.04	MT	R	F	Box Engine T9A(DJ5)	GDS10032	Drive Shaft	54T	35	41	70	117	1085			
	1999.07-	2002.04	MT	R	F	Box Engine T9A(DJ5)	GDS10069	Drive Shaft		28	37	63	112.5	1072			
	1999.07-	2002.04	MT	R	F	Box Engine T9A(DJ5)	GDS10066	Drive Shaft		35	41	70	117	1085			
	1999.07-	2002.04	MT	R	F	Box Engine T9A(DJ5)	GDS10036	Drive Shaft	54T	28	41	63	112.5	1079			
	2.5 TD (76 kW)	1994.03-	2002.04	MT		F	Box Engine T8A(DJ5T)	GCO10011	Outer Joint	54T	35	45	70	117	73	I	
		1994.03-	2002.04	MT		F	Box Engine T8A(DJ5T)	GCO10013	Outer Joint	54T	28	39	63	112.5	63	I	
1994.03-		2002.04	MT		F	Box Engine T8A(DJ5T)	GCO10050	Outer Joint		35	45	70	117	73	I		
1994.03-		2002.04	MT		F	Box Engine T8A(DJ5T)	GCO10012	Outer Joint		28	39	63	112.5	63	I		
1994.03-		2002.04	MT	L	F	Box Engine T8A(DJ5T)	GDS10033	Drive Shaft	54T	35	41	70	117	762			
1994.03-		2002.04	MT	L	F	Box Engine T8A(DJ5T)	GDS10105	Drive Shaft		28	37	63	112.5	771			
1994.03-		2002.04	MT	L	F	Box Engine T8A(DJ5T)	GDS10067	Drive Shaft		35	41	70	117	762			
1994.03-		2002.04	MT	L	F	Box Engine T8A(DJ5T)	GDS10035	Drive Shaft	54T	28	41	63	112.5	757.5			
1994.03-		2002.04	MT	L	F	Box Engine T8A(DJ5T)	GDS10102	Drive Shaft		28	41	63	112.5	757.5			
1994.03-		2002.04	MT	L	F	Box Engine T8A(DJ5T)	GDS10037	Drive Shaft	54T	28	37	63	112.5	771			
1994.03-		2002.04	MT	R	F	Box Engine T8A(DJ5T)	GDS10103	Drive Shaft		28	41	63	112.5	1079			
1994.03-		2002.04	MT	R	F	Box Engine T8A(DJ5T)	GDS10104	Drive Shaft	54T	28	37	63	112.5	1072			
1994.03-		2002.04	MT	R	F	Box Engine T8A(DJ5T)	GDS10032	Drive Shaft	54T	35	41	70	117	1085			
1994.03-		2002.04	MT	R	F	Box Engine T8A(DJ5T)	GDS10069	Drive Shaft		28	37	63	112.5	1072			
1994.03-		2002.04	MT	R	F	Box Engine T8A(DJ5T)	GDS10066	Drive Shaft		35	41	70	117	1085			
1994.03-		2002.04	MT	R	F	Box Engine T8A(DJ5T)	GDS10036	Drive Shaft	54T	28	41	63	112.5	1079			
2.5 TDi (79 kW)		1997.01-	2002.04	MT		F	Box Engine THX(DJ5TED)	GCO10011	Outer Joint	54T	35	45	70	117	73	I	
		1997.01-	2002.04	MT		F	Box Engine THX(DJ5TED)	GCO10013	Outer Joint	54T	28	39	63	112.5	63	I	
	1997.01-	2002.04	MT		F	Box Engine THX(DJ5TED)	GCO10050	Outer Joint		35	45	70	117	73	I		
	1997.01-	2002.04	MT		F	Box Engine THX(DJ5TED)	GCO10012	Outer Joint		28	39	63	112.5	63	I		
	1997.01-	2002.04	MT	L	F	Box Engine THX(DJ5TED)	GDS10033	Drive Shaft	54T	35	41	70	117	762			
	1997.01-	2002.04	MT	L	F	Box Engine THX(DJ5TED)	GDS10105	Drive Shaft		28	37	63	112.5	771			
	1997.01-	2002.04	MT	L	F	Box Engine THX(DJ5TED)	GDS10067	Drive Shaft		35	41	70	117	762			
	1997.01-	2002.04	MT	L	F	Box Engine THX(DJ5TED)	GDS10035	Drive Shaft	54T	28	41	63	112.5	757.5			
	1997.01-	2002.04	MT	L	F	Box Engine THX(DJ5TED)	GDS10102	Drive Shaft		28	41	63	112.5	757.5			
	1997.01-	2002.04	MT	L	F	Box Engine THX(DJ5TED)	GDS10037	Drive Shaft	54T	28	37	63	112.5	771			
	1997.01-	2002.04	MT	R	F	Box Engine THX(DJ5TED)	GDS10103	Drive Shaft		28	41	63	112.5	1079			
	1997.01-	2002.04	MT	R	F	Box Engine THX(DJ5TED)	GDS10104	Drive Shaft	54T	28	37	63	112.5	1072			
	1997.01-	2002.04	MT	R	F	Box Engine THX(DJ5TED)	GDS10032	Drive Shaft	54T	35	41	70	117	1085			
	1997.01-	2002.04	MT	R	F	Box Engine THX(DJ5TED)	GDS10069	Drive Shaft		28	37	63	112.5	1072			
	1997.01-	2002.04	MT	R	F	Box Engine THX(DJ5TED)	GDS10066	Drive Shaft		35	41	70	117	1085			
	1997.01-	2002.04	MT	R	F	Box Engine THX(DJ5TED)	GDS10036	Drive Shaft	54T	28	41	63	112.5	1079			
	2.5 TDi 4x4 (79 kW)	1999.07-	2002.04	MT		F	Box Engine THX(DJ5TED)	GCO10011	Outer Joint	54T	35	45	70	117	73	I	





		TRANSM	L/R	F/R		G-AP Ref.	PRODUCT	ABS	Technical Specifications							
									YEAR	A	B	C	H	L	P	
<b>PEUGEOT BOXER (230L)</b>																
2.5 TDi 4x4 (79 kW)	1999.07-	2002.04	MT		F	Box Engine THX(DJ5TED)	GC010013	Outer Joint	54T	28	39	63	112.5	63	I	
	1999.07-	2002.04	MT		F	Box Engine THX(DJ5TED)	GC010050	Outer Joint		35	45	70	117	73	I	
	1999.07-	2002.04	MT		F	Box Engine THX(DJ5TED)	GC010012	Outer Joint		28	39	63	112.5	63	I	
	1999.07-	2002.04	MT	L	F	Box Engine THX(DJ5TED)	GDS10033	Drive Shaft	54T	35	41	70	117	762		
	1999.07-	2002.04	MT	L	F	Box Engine THX(DJ5TED)	GDS10105	Drive Shaft		28	37	63	112.5	771		
	1999.07-	2002.04	MT	L	F	Box Engine THX(DJ5TED)	GDS10067	Drive Shaft		35	41	70	117	762		
	1999.07-	2002.04	MT	L	F	Box Engine THX(DJ5TED)	GDS10035	Drive Shaft	54T	28	41	63	112.5	757.5		
	1999.07-	2002.04	MT	L	F	Box Engine THX(DJ5TED)	GDS10102	Drive Shaft		28	41	63	112.5	757.5		
	1999.07-	2002.04	MT	L	F	Box Engine THX(DJ5TED)	GDS10037	Drive Shaft	54T	28	37	63	112.5	771		
	1999.07-	2002.04	MT	R	F	Box Engine THX(DJ5TED)	GDS10103	Drive Shaft		28	41	63	112.5	1079		
	1999.07-	2002.04	MT	R	F	Box Engine THX(DJ5TED)	GDS10104	Drive Shaft	54T	28	37	63	112.5	1072		
	1999.07-	2002.04	MT	R	F	Box Engine THX(DJ5TED)	GDS10032	Drive Shaft	54T	35	41	70	117	1085		
	1999.07-	2002.04	MT	R	F	Box Engine THX(DJ5TED)	GDS10069	Drive Shaft		28	37	63	112.5	1072		
	1999.07-	2002.04	MT	R	F	Box Engine THX(DJ5TED)	GDS10066	Drive Shaft		35	41	70	117	1085		
1999.07-	2002.04	MT	R	F	Box Engine THX(DJ5TED)	GDS10036	Drive Shaft	54T	28	41	63	112.5	1079			
2.8 HDi (94 kW)	2000.11-	2002.04	MT	R	F	Box Engine 8140.43S(F28DTCR)	GDS10032	Drive Shaft	54T	35	41	70	117	1085		
	2000.11-	2002.04	MT	R	F	Box Engine 8140.43S(F28DTCR)	GDS10066	Drive Shaft		35	41	70	117	1085		
	2000.11-	2002.04	MT		F	Box Engine 8140.43S(F28DTCR)	GC010011	Outer Joint	54T	35	45	70	117	73	I	
	2000.11-	2002.04	MT		F	Box Engine 8140.43S(F28DTCR)	GC010050	Outer Joint		35	45	70	117	73	I	
	2000.11-	2002.04	MT	L	F	Box Engine 8140.43S(F28DTCR)	GDS10033	Drive Shaft	54T	35	41	70	117	762		
	2000.11-	2002.04	MT	L	F	Box Engine 8140.43S(F28DTCR)	GDS10067	Drive Shaft		35	41	70	117	762		
<b>BOXER (230P)</b>																
1.9 D (51 kW)	1994.03-	2002.04	MT		F	Bus Engine D9B(XUD9AU)	GC010011	Outer Joint	54T	35	45	70	117	73	I	
	1994.03-	2002.04	MT		F	Bus Engine D9B(XUD9AU)	GC010013	Outer Joint	54T	28	39	63	112.5	63	I	
	1994.03-	2002.04	MT		F	Bus Engine D9B(XUD9AU)	GC010050	Outer Joint		35	45	70	117	73	I	
	1994.03-	2002.04	MT		F	Bus Engine D9B(XUD9AU)	GC010012	Outer Joint		28	39	63	112.5	63	I	
	1994.03-	2002.04	MT	L	F	Bus Engine D9B(XUD9AU)	GDS10033	Drive Shaft	54T	35	41	70	117	762		
	1994.03-	2002.04	MT	L	F	Bus Engine D9B(XUD9AU)	GDS10105	Drive Shaft		28	37	63	112.5	771		
	1994.03-	2002.04	MT	L	F	Bus Engine D9B(XUD9AU)	GDS10067	Drive Shaft		35	41	70	117	762		
	1994.03-	2002.04	MT	L	F	Bus Engine D9B(XUD9AU)	GDS10035	Drive Shaft	54T	28	41	63	112.5	757.5		
	1994.03-	2002.04	MT	L	F	Bus Engine D9B(XUD9AU)	GDS10102	Drive Shaft		28	41	63	112.5	757.5		
	1994.03-	2002.04	MT	L	F	Bus Engine D9B(XUD9AU)	GDS10037	Drive Shaft	54T	28	37	63	112.5	771		
	1994.03-	2002.04	MT	R	F	Bus Engine D9B(XUD9AU)	GDS10103	Drive Shaft		28	41	63	112.5	1079		
	1994.03-	2002.04	MT	R	F	Bus Engine D9B(XUD9AU)	GDS10104	Drive Shaft	54T	28	37	63	112.5	1072		
	1994.03-	2002.04	MT	R	F	Bus Engine D9B(XUD9AU)	GDS10032	Drive Shaft	54T	35	41	70	117	1085		
	1994.03-	2002.04	MT	R	F	Bus Engine D9B(XUD9AU)	GDS10069	Drive Shaft		28	37	63	112.5	1072		
	1994.03-	2002.04	MT	R	F	Bus Engine D9B(XUD9AU)	GDS10066	Drive Shaft		35	41	70	117	1085		
	1994.03-	2002.04	MT	R	F	Bus Engine D9B(XUD9AU)	GDS10036	Drive Shaft	54T	28	41	63	112.5	1079		
1.9 TD (66 kW)	1994.08-	2002.04	MT		F	Bus Engine DHY(XUD9TE)	GC010011	Outer Joint	54T	35	45	70	117	73	I	
	1994.08-	2002.04	MT		F	Bus Engine DHY(XUD9TE)	GC010013	Outer Joint	54T	28	39	63	112.5	63	I	
	1994.08-	2002.04	MT		F	Bus Engine DHY(XUD9TE)	GC010050	Outer Joint		35	45	70	117	73	I	
	1994.08-	2002.04	MT		F	Bus Engine DHY(XUD9TE)	GC010012	Outer Joint		28	39	63	112.5	63	I	
	1994.08-	2002.04	MT	L	F	Bus Engine DHY(XUD9TE)	GDS10033	Drive Shaft	54T	35	41	70	117	762		
	1994.08-	2002.04	MT	L	F	Bus Engine DHY(XUD9TE)	GDS10105	Drive Shaft		28	37	63	112.5	771		
	1994.08-	2002.04	MT	L	F	Bus Engine DHY(XUD9TE)	GDS10067	Drive Shaft		35	41	70	117	762		
	1994.08-	2002.04	MT	L	F	Bus Engine DHY(XUD9TE)	GDS10035	Drive Shaft	54T	28	41	63	112.5	757.5		
	1994.08-	2002.04	MT	L	F	Bus Engine DHY(XUD9TE)	GDS10102	Drive Shaft		28	41	63	112.5	757.5		
	1994.08-	2002.04	MT	L	F	Bus Engine DHY(XUD9TE)	GDS10037	Drive Shaft	54T	28	37	63	112.5	771		
	1994.08-	2002.04	MT	R	F	Bus Engine DHY(XUD9TE)	GDS10103	Drive Shaft		28	41	63	112.5	1079		
	1994.08-	2002.04	MT	R	F	Bus Engine DHY(XUD9TE)	GDS10104	Drive Shaft	54T	28	37	63	112.5	1072		
	1994.08-	2002.04	MT	R	F	Bus Engine DHY(XUD9TE)	GDS10032	Drive Shaft	54T	35	41	70	117	1085		
	1994.08-	2002.04	MT	R	F	Bus Engine DHY(XUD9TE)	GDS10069	Drive Shaft		28	37	63	112.5	1072		
	1994.08-	2002.04	MT	R	F	Bus Engine DHY(XUD9TE)	GDS10066	Drive Shaft		35	41	70	117	1085		
	1994.08-	2002.04	MT	R	F	Bus Engine DHY(XUD9TE)	GDS10036	Drive Shaft	54T	28	41	63	112.5	1079		
1.9 TD (68 kW)	1994.03-	2002.04	MT		F	Bus Engine D8C(XUD9UTF)	GC010011	Outer Joint	54T	35	45	70	117	73	I	
	1994.03-	2002.04	MT		F	Bus Engine D8C(XUD9UTF)	GC010013	Outer Joint	54T	28	39	63	112.5	63	I	
	1994.03-	2002.04	MT		F	Bus Engine D8C(XUD9UTF)	GC010050	Outer Joint		35	45	70	117	73	I	
	1994.03-	2002.04	MT		F	Bus Engine D8C(XUD9UTF)	GC010012	Outer Joint		28	39	63	112.5	63	I	
	1994.03-	2002.04	MT	L	F	Bus Engine D8C(XUD9UTF)	GDS10033	Drive Shaft	54T	35	41	70	117	762		
	1994.03-	2002.04	MT	L	F	Bus Engine D8C(XUD9UTF)	GDS10105	Drive Shaft		28	37	63	112.5	771		
1994.03-	2002.04	MT	L	F	Bus Engine D8C(XUD9UTF)	GDS10067	Drive Shaft		35	41	70	117	762			





		TRANSM	L/R	F/R		G-AP Ref.	PRODUCT	ABS	Technical Specifications							
									YEAR	A	B	C	H	L	P	
<b>PEUGEOT BOXER (230P)</b>																
1.9 TD (68 kW)	1994.03-	2002.04	MT	L	F	Bus Engine D8C(XUD9UTF)	GDS10035	Drive Shaft	54T	28	41	63	112.5	757.5		
	1994.03-	2002.04	MT	L	F	Bus Engine D8C(XUD9UTF)	GDS10102	Drive Shaft		28	41	63	112.5	757.5		
	1994.03-	2002.04	MT	L	F	Bus Engine D8C(XUD9UTF)	GDS10037	Drive Shaft	54T	28	37	63	112.5	771		
	1994.03-	2002.04	MT	R	F	Bus Engine D8C(XUD9UTF)	GDS10103	Drive Shaft		28	41	63	112.5	1079		
	1994.03-	2002.04	MT	R	F	Bus Engine D8C(XUD9UTF)	GDS10104	Drive Shaft	54T	28	37	63	112.5	1072		
	1994.03-	2002.04	MT	R	F	Bus Engine D8C(XUD9UTF)	GDS10032	Drive Shaft	54T	35	41	70	117	1085		
	1994.03-	2002.04	MT	R	F	Bus Engine D8C(XUD9UTF)	GDS10069	Drive Shaft		28	37	63	112.5	1072		
	1994.03-	2002.04	MT	R	F	Bus Engine D8C(XUD9UTF)	GDS10066	Drive Shaft		35	41	70	117	1085		
	1994.03-	2002.04	MT	R	F	Bus Engine D8C(XUD9UTF)	GDS10036	Drive Shaft	54T	28	41	63	112.5	1079		
1.9 TD 4x4 (68 kW)	1996.07-	2002.04	MT		F	Bus Engine D8C(XUD9UTF)	GC010011	Outer Joint	54T	35	45	70	117	73	I	
	1996.07-	2002.04	MT		F	Bus Engine D8C(XUD9UTF)	GC010013	Outer Joint	54T	28	39	63	112.5	63	I	
	1996.07-	2002.04	MT		F	Bus Engine D8C(XUD9UTF)	GC010050	Outer Joint		35	45	70	117	73	I	
	1996.07-	2002.04	MT		F	Bus Engine D8C(XUD9UTF)	GC010012	Outer Joint		28	39	63	112.5	63	I	
	1996.07-	2002.04	MT	L	F	Bus Engine D8C(XUD9UTF)	GDS10033	Drive Shaft	54T	35	41	70	117	762		
	1996.07-	2002.04	MT	L	F	Bus Engine D8C(XUD9UTF)	GDS10105	Drive Shaft		28	37	63	112.5	771		
	1996.07-	2002.04	MT	L	F	Bus Engine D8C(XUD9UTF)	GDS10067	Drive Shaft		35	41	70	117	762		
	1996.07-	2002.04	MT	L	F	Bus Engine D8C(XUD9UTF)	GDS10035	Drive Shaft	54T	28	41	63	112.5	757.5		
	1996.07-	2002.04	MT	L	F	Bus Engine D8C(XUD9UTF)	GDS10102	Drive Shaft		28	41	63	112.5	757.5		
	1996.07-	2002.04	MT	L	F	Bus Engine D8C(XUD9UTF)	GDS10037	Drive Shaft	54T	28	37	63	112.5	771		
	1996.07-	2002.04	MT	R	F	Bus Engine D8C(XUD9UTF)	GDS10103	Drive Shaft		28	41	63	112.5	1079		
	1996.07-	2002.04	MT	R	F	Bus Engine D8C(XUD9UTF)	GDS10104	Drive Shaft	54T	28	37	63	112.5	1072		
	1996.07-	2002.04	MT	R	F	Bus Engine D8C(XUD9UTF)	GDS10032	Drive Shaft	54T	35	41	70	117	1085		
	1996.07-	2002.04	MT	R	F	Bus Engine D8C(XUD9UTF)	GDS10069	Drive Shaft		28	37	63	112.5	1072		
	1996.07-	2002.04	MT	R	F	Bus Engine D8C(XUD9UTF)	GDS10066	Drive Shaft		35	41	70	117	1085		
	1996.07-	2002.04	MT	R	F	Bus Engine D8C(XUD9UTF)	GDS10036	Drive Shaft	54T	28	41	63	112.5	1079		
2.0 i (80 kW)	1994.03-	2002.04	MT		F	Bus Engine RFW(XU10J2)	GC010011	Outer Joint	54T	35	45	70	117	73	I	
	1994.03-	2002.04	MT		F	Bus Engine RFW(XU10J2)	GC010013	Outer Joint	54T	28	39	63	112.5	63	I	
	1994.03-	2002.04	MT		F	Bus Engine RFW(XU10J2)	GC010050	Outer Joint		35	45	70	117	73	I	
	1994.03-	2002.04	MT		F	Bus Engine RFW(XU10J2)	GC010012	Outer Joint		28	39	63	112.5	63	I	
	1994.03-	2002.04	MT	L	F	Bus Engine RFW(XU10J2)	GDS10033	Drive Shaft	54T	35	41	70	117	762		
	1994.03-	2002.04	MT	L	F	Bus Engine RFW(XU10J2)	GDS10105	Drive Shaft		28	37	63	112.5	771		
	1994.03-	2002.04	MT	L	F	Bus Engine RFW(XU10J2)	GDS10067	Drive Shaft		35	41	70	117	762		
	1994.03-	2002.04	MT	L	F	Bus Engine RFW(XU10J2)	GDS10035	Drive Shaft	54T	28	41	63	112.5	757.5		
	1994.03-	2002.04	MT	L	F	Bus Engine RFW(XU10J2)	GDS10102	Drive Shaft		28	41	63	112.5	757.5		
	1994.03-	2002.04	MT	L	F	Bus Engine RFW(XU10J2)	GDS10037	Drive Shaft	54T	28	37	63	112.5	771		
	1994.03-	2002.04	MT	R	F	Bus Engine RFW(XU10J2)	GDS10103	Drive Shaft		28	41	63	112.5	1079		
	1994.03-	2002.04	MT	R	F	Bus Engine RFW(XU10J2)	GDS10104	Drive Shaft	54T	28	37	63	112.5	1072		
	1994.03-	2002.04	MT	R	F	Bus Engine RFW(XU10J2)	GDS10032	Drive Shaft	54T	35	41	70	117	1085		
	1994.03-	2002.04	MT	R	F	Bus Engine RFW(XU10J2)	GDS10069	Drive Shaft		28	37	63	112.5	1072		
	1994.03-	2002.04	MT	R	F	Bus Engine RFW(XU10J2)	GDS10066	Drive Shaft		35	41	70	117	1085		
	1994.03-	2002.04	MT	R	F	Bus Engine RFW(XU10J2)	GDS10036	Drive Shaft	54T	28	41	63	112.5	1079		
2.0 i 4x4 (80 kW)	1996.08-	2002.04	MT		F	Bus Engine RFW(XU10J2)	GC010011	Outer Joint	54T	35	45	70	117	73	I	
	1996.08-	2002.04	MT		F	Bus Engine RFW(XU10J2)	GC010013	Outer Joint	54T	28	39	63	112.5	63	I	
	1996.08-	2002.04	MT		F	Bus Engine RFW(XU10J2)	GC010050	Outer Joint		35	45	70	117	73	I	
	1996.08-	2002.04	MT		F	Bus Engine RFW(XU10J2)	GC010012	Outer Joint		28	39	63	112.5	63	I	
	1996.08-	2002.04	MT	L	F	Bus Engine RFW(XU10J2)	GDS10033	Drive Shaft	54T	35	41	70	117	762		
	1996.08-	2002.04	MT	L	F	Bus Engine RFW(XU10J2)	GDS10105	Drive Shaft		28	37	63	112.5	771		
	1996.08-	2002.04	MT	L	F	Bus Engine RFW(XU10J2)	GDS10067	Drive Shaft		35	41	70	117	762		
	1996.08-	2002.04	MT	L	F	Bus Engine RFW(XU10J2)	GDS10035	Drive Shaft	54T	28	41	63	112.5	757.5		
	1996.08-	2002.04	MT	L	F	Bus Engine RFW(XU10J2)	GDS10102	Drive Shaft		28	41	63	112.5	757.5		
	1996.08-	2002.04	MT	L	F	Bus Engine RFW(XU10J2)	GDS10037	Drive Shaft	54T	28	37	63	112.5	771		
	1996.08-	2002.04	MT	R	F	Bus Engine RFW(XU10J2)	GDS10103	Drive Shaft		28	41	63	112.5	1079		
	1996.08-	2002.04	MT	R	F	Bus Engine RFW(XU10J2)	GDS10104	Drive Shaft	54T	28	37	63	112.5	1072		
	1996.08-	2002.04	MT	R	F	Bus Engine RFW(XU10J2)	GDS10032	Drive Shaft	54T	35	41	70	117	1085		
	1996.08-	2002.04	MT	R	F	Bus Engine RFW(XU10J2)	GDS10069	Drive Shaft		28	37	63	112.5	1072		
	1996.08-	2002.04	MT	R	F	Bus Engine RFW(XU10J2)	GDS10066	Drive Shaft		35	41	70	117	1085		
	1996.08-	2002.04	MT	R	F	Bus Engine RFW(XU10J2)	GDS10036	Drive Shaft	54T	28	41	63	112.5	1079		
2.5 D (63 kW)	1994.08-	2002.04	MT		F	Bus Engine T9A(DJ5)	GC010011	Outer Joint	54T	35	45	70	117	73	I	
	1994.08-	2002.04	MT		F	Bus Engine T9A(DJ5)	GC010013	Outer Joint	54T	28	39	63	112.5	63	I	
	1994.08-	2002.04	MT		F	Bus Engine T9A(DJ5)	GC010050	Outer Joint		35	45	70	117	73	I	
	1994.08-	2002.04	MT		F	Bus Engine T9A(DJ5)	GC010012	Outer Joint		28	39	63	112.5	63	I	



		TRANSM	L/R	F/R		G-AP Ref.	PRODUCT	ABS	Technical Specifications									
									YEAR	A	B	C	H	L	P			
<b>PEUGEOT BOXER (230P)</b>																		
2.5 D (63 kW)	1994.08-	2002.04	MT	L	F	Bus Engine T9A(DJ5)	GDS10033	Drive Shaft	54T	35	41	70	117	762				
	1994.08-	2002.04	MT	L	F	Bus Engine T9A(DJ5)	GDS10105	Drive Shaft		28	37	63	112.5	771				
	1994.08-	2002.04	MT	L	F	Bus Engine T9A(DJ5)	GDS10067	Drive Shaft		35	41	70	117	762				
	1994.08-	2002.04	MT	L	F	Bus Engine T9A(DJ5)	GDS10035	Drive Shaft	54T	28	41	63	112.5	757.5				
	1994.08-	2002.04	MT	L	F	Bus Engine T9A(DJ5)	GDS10102	Drive Shaft		28	41	63	112.5	757.5				
	1994.08-	2002.04	MT	L	F	Bus Engine T9A(DJ5)	GDS10037	Drive Shaft	54T	28	37	63	112.5	771				
	1994.08-	2002.04	MT	R	F	Bus Engine T9A(DJ5)	GDS10103	Drive Shaft		28	41	63	112.5	1079				
	1994.08-	2002.04	MT	R	F	Bus Engine T9A(DJ5)	GDS10104	Drive Shaft	54T	28	37	63	112.5	1072				
	1994.08-	2002.04	MT	R	F	Bus Engine T9A(DJ5)	GDS10032	Drive Shaft	54T	35	41	70	117	1085				
	1994.08-	2002.04	MT	R	F	Bus Engine T9A(DJ5)	GDS10069	Drive Shaft		28	37	63	112.5	1072				
	1994.08-	2002.04	MT	R	F	Bus Engine T9A(DJ5)	GDS10066	Drive Shaft		35	41	70	117	1085				
	1994.08-	2002.04	MT	R	F	Bus Engine T9A(DJ5)	GDS10036	Drive Shaft	54T	28	41	63	112.5	1079				
2.5 D 4x4 (63 kW)	1996.07-	2002.04	MT		F	Bus Engine T9A(DJ5)	GCO10011	Outer Joint	54T	35	45	70	117	73	I			
	1996.07-	2002.04	MT		F	Bus Engine T9A(DJ5)	GCO10013	Outer Joint	54T	28	39	63	112.5	63	I			
	1996.07-	2002.04	MT		F	Bus Engine T9A(DJ5)	GCO10050	Outer Joint		35	45	70	117	73	I			
	1996.07-	2002.04	MT		F	Bus Engine T9A(DJ5)	GCO10012	Outer Joint		28	39	63	112.5	63	I			
	1996.07-	2002.04	MT	L	F	Bus Engine T9A(DJ5)	GDS10033	Drive Shaft	54T	35	41	70	117	762				
	1996.07-	2002.04	MT	L	F	Bus Engine T9A(DJ5)	GDS10105	Drive Shaft		28	37	63	112.5	771				
	1996.07-	2002.04	MT	L	F	Bus Engine T9A(DJ5)	GDS10067	Drive Shaft		35	41	70	117	762				
	1996.07-	2002.04	MT	L	F	Bus Engine T9A(DJ5)	GDS10035	Drive Shaft	54T	28	41	63	112.5	757.5				
	1996.07-	2002.04	MT	L	F	Bus Engine T9A(DJ5)	GDS10102	Drive Shaft		28	41	63	112.5	757.5				
	1996.07-	2002.04	MT	L	F	Bus Engine T9A(DJ5)	GDS10037	Drive Shaft	54T	28	37	63	112.5	771				
	1996.07-	2002.04	MT	R	F	Bus Engine T9A(DJ5)	GDS10103	Drive Shaft		28	41	63	112.5	1079				
	1996.07-	2002.04	MT	R	F	Bus Engine T9A(DJ5)	GDS10104	Drive Shaft	54T	28	37	63	112.5	1072				
	1996.07-	2002.04	MT	R	F	Bus Engine T9A(DJ5)	GDS10032	Drive Shaft	54T	35	41	70	117	1085				
	1996.07-	2002.04	MT	R	F	Bus Engine T9A(DJ5)	GDS10069	Drive Shaft		28	37	63	112.5	1072				
	1996.07-	2002.04	MT	R	F	Bus Engine T9A(DJ5)	GDS10066	Drive Shaft		35	41	70	117	1085				
	1996.07-	2002.04	MT	R	F	Bus Engine T9A(DJ5)	GDS10036	Drive Shaft	54T	28	41	63	112.5	1079				
	2.5 TD (76 kW)	1994.07-	2002.04	MT		F	Bus Engine T8A(DJ5T)	GCO10011	Outer Joint	54T	35	45	70	117	73	I		
		1994.07-	2002.04	MT		F	Bus Engine T8A(DJ5T)	GCO10013	Outer Joint	54T	28	39	63	112.5	63	I		
1994.07-		2002.04	MT		F	Bus Engine T8A(DJ5T)	GCO10050	Outer Joint		35	45	70	117	73	I			
1994.07-		2002.04	MT		F	Bus Engine T8A(DJ5T)	GCO10012	Outer Joint		28	39	63	112.5	63	I			
1994.07-		2002.04	MT	L	F	Bus Engine T8A(DJ5T)	GDS10033	Drive Shaft	54T	35	41	70	117	762				
1994.07-		2002.04	MT	L	F	Bus Engine T8A(DJ5T)	GDS10105	Drive Shaft		28	37	63	112.5	771				
1994.07-		2002.04	MT	L	F	Bus Engine T8A(DJ5T)	GDS10067	Drive Shaft		35	41	70	117	762				
1994.07-		2002.04	MT	L	F	Bus Engine T8A(DJ5T)	GDS10035	Drive Shaft	54T	28	41	63	112.5	757.5				
1994.07-		2002.04	MT	L	F	Bus Engine T8A(DJ5T)	GDS10102	Drive Shaft		28	41	63	112.5	757.5				
1994.07-		2002.04	MT	L	F	Bus Engine T8A(DJ5T)	GDS10037	Drive Shaft	54T	28	37	63	112.5	771				
1994.07-		2002.04	MT	R	F	Bus Engine T8A(DJ5T)	GDS10103	Drive Shaft		28	41	63	112.5	1079				
1994.07-		2002.04	MT	R	F	Bus Engine T8A(DJ5T)	GDS10104	Drive Shaft	54T	28	37	63	112.5	1072				
1994.07-		2002.04	MT	R	F	Bus Engine T8A(DJ5T)	GDS10032	Drive Shaft	54T	35	41	70	117	1085				
1994.07-		2002.04	MT	R	F	Bus Engine T8A(DJ5T)	GDS10069	Drive Shaft		28	37	63	112.5	1072				
1994.07-		2002.04	MT	R	F	Bus Engine T8A(DJ5T)	GDS10066	Drive Shaft		35	41	70	117	1085				
1994.07-		2002.04	MT	R	F	Bus Engine T8A(DJ5T)	GDS10036	Drive Shaft	54T	28	41	63	112.5	1079				
2.5 TD 4x4 (76 kW)		1996.07-	2002.04	MT		F	Bus Engine T8A(DJ5T)	GCO10011	Outer Joint	54T	35	45	70	117	73	I		
		1996.07-	2002.04	MT		F	Bus Engine T8A(DJ5T)	GCO10013	Outer Joint	54T	28	39	63	112.5	63	I		
	1996.07-	2002.04	MT		F	Bus Engine T8A(DJ5T)	GCO10050	Outer Joint		35	45	70	117	73	I			
	1996.07-	2002.04	MT		F	Bus Engine T8A(DJ5T)	GCO10012	Outer Joint		28	39	63	112.5	63	I			
	1996.07-	2002.04	MT	L	F	Bus Engine T8A(DJ5T)	GDS10033	Drive Shaft	54T	35	41	70	117	762				
	1996.07-	2002.04	MT	L	F	Bus Engine T8A(DJ5T)	GDS10105	Drive Shaft		28	37	63	112.5	771				
	1996.07-	2002.04	MT	L	F	Bus Engine T8A(DJ5T)	GDS10067	Drive Shaft		35	41	70	117	762				
	1996.07-	2002.04	MT	L	F	Bus Engine T8A(DJ5T)	GDS10035	Drive Shaft	54T	28	41	63	112.5	757.5				
	1996.07-	2002.04	MT	L	F	Bus Engine T8A(DJ5T)	GDS10102	Drive Shaft		28	41	63	112.5	757.5				
	1996.07-	2002.04	MT	L	F	Bus Engine T8A(DJ5T)	GDS10037	Drive Shaft	54T	28	37	63	112.5	771				
	1996.07-	2002.04	MT	R	F	Bus Engine T8A(DJ5T)	GDS10103	Drive Shaft		28	41	63	112.5	1079				
	1996.07-	2002.04	MT	R	F	Bus Engine T8A(DJ5T)	GDS10104	Drive Shaft	54T	28	37	63	112.5	1072				
	1996.07-	2002.04	MT	R	F	Bus Engine T8A(DJ5T)	GDS10032	Drive Shaft	54T	35	41	70	117	1085				
	1996.07-	2002.04	MT	R	F	Bus Engine T8A(DJ5T)	GDS10069	Drive Shaft		28	37	63	112.5	1072				
	1996.07-	2002.04	MT	R	F	Bus Engine T8A(DJ5T)	GDS10066	Drive Shaft		35	41	70	117	1085				
	1996.07-	2002.04	MT	R	F	Bus Engine T8A(DJ5T)	GDS10036	Drive Shaft	54T	28	41	63	112.5	1079				
	2.5 TDi (79 kW)	1997.01-	2002.04	MT		F	Bus Engine THX(DJ5TED)	GCO10011	Outer Joint	54T	35	45	70	117	73	I		





		TRANSM	L/R	F/R		G-AP Ref.	PRODUCT	ABS	Technical Specifications								
									YEAR	A	B	C	H	L	P		
<b>PEUGEOT BOXER (230P)</b>																	
2.5 TDi (79 kW)	1997.01-	2002.04	MT		F	Bus Engine THX(DJ5TED)	GC010013	Outer Joint	54T	28	39	63	112.5	63	I		
	1997.01-	2002.04	MT		F	Bus Engine THX(DJ5TED)	GC010050	Outer Joint		35	45	70	117	73	I		
	1997.01-	2002.04	MT		F	Bus Engine THX(DJ5TED)	GC010012	Outer Joint		28	39	63	112.5	63	I		
	1997.01-	2002.04	MT	L	F	Bus Engine THX(DJ5TED)	GDS10033	Drive Shaft	54T	35	41	70	117	762			
	1997.01-	2002.04	MT	L	F	Bus Engine THX(DJ5TED)	GDS10105	Drive Shaft		28	37	63	112.5	771			
	1997.01-	2002.04	MT	L	F	Bus Engine THX(DJ5TED)	GDS10067	Drive Shaft		35	41	70	117	762			
	1997.01-	2002.04	MT	L	F	Bus Engine THX(DJ5TED)	GDS10035	Drive Shaft	54T	28	41	63	112.5	757.5			
	1997.01-	2002.04	MT	L	F	Bus Engine THX(DJ5TED)	GDS10102	Drive Shaft		28	41	63	112.5	757.5			
	1997.01-	2002.04	MT	L	F	Bus Engine THX(DJ5TED)	GDS10037	Drive Shaft	54T	28	37	63	112.5	771			
	1997.01-	2002.04	MT	R	F	Bus Engine THX(DJ5TED)	GDS10103	Drive Shaft		28	41	63	112.5	1079			
	1997.01-	2002.04	MT	R	F	Bus Engine THX(DJ5TED)	GDS10104	Drive Shaft	54T	28	37	63	112.5	1072			
	1997.01-	2002.04	MT	R	F	Bus Engine THX(DJ5TED)	GDS10032	Drive Shaft	54T	35	41	70	117	1085			
	1997.01-	2002.04	MT	R	F	Bus Engine THX(DJ5TED)	GDS10069	Drive Shaft		28	37	63	112.5	1072			
	1997.01-	2002.04	MT	R	F	Bus Engine THX(DJ5TED)	GDS10066	Drive Shaft		35	41	70	117	1085			
	1997.01-	2002.04	MT	R	F	Bus Engine THX(DJ5TED)	GDS10036	Drive Shaft	54T	28	41	63	112.5	1079			
2.5 TDi 4x4 (79 kW)	1997.01-	2002.04	MT		F	Bus Engine THX(DJ5TED)	GC010011	Outer Joint	54T	35	45	70	117	73	I		
	1997.01-	2002.04	MT		F	Bus Engine THX(DJ5TED)	GC010013	Outer Joint	54T	28	39	63	112.5	63	I		
	1997.01-	2002.04	MT		F	Bus Engine THX(DJ5TED)	GC010012	Outer Joint		28	39	63	112.5	63	I		
	1997.01-	2002.04	MT	L	F	Bus Engine THX(DJ5TED)	GDS10033	Drive Shaft	54T	35	41	70	117	762			
	1997.01-	2002.04	MT	L	F	Bus Engine THX(DJ5TED)	GDS10105	Drive Shaft		28	37	63	112.5	771			
	1997.01-	2002.04	MT	L	F	Bus Engine THX(DJ5TED)	GDS10067	Drive Shaft		35	41	70	117	762			
	1997.01-	2002.04	MT	L	F	Bus Engine THX(DJ5TED)	GDS10035	Drive Shaft	54T	28	41	63	112.5	757.5			
	1997.01-	2002.04	MT	L	F	Bus Engine THX(DJ5TED)	GDS10102	Drive Shaft		28	41	63	112.5	757.5			
	1997.01-	2002.04	MT	L	F	Bus Engine THX(DJ5TED)	GDS10037	Drive Shaft	54T	28	37	63	112.5	771			
	1997.01-	2002.04	MT	R	F	Bus Engine THX(DJ5TED)	GDS10103	Drive Shaft		28	41	63	112.5	1079			
	1997.01-	2002.04	MT	R	F	Bus Engine THX(DJ5TED)	GDS10104	Drive Shaft	54T	28	37	63	112.5	1072			
	1997.01-	2002.04	MT	R	F	Bus Engine THX(DJ5TED)	GDS10032	Drive Shaft	54T	35	41	70	117	1085			
	1997.01-	2002.04	MT	R	F	Bus Engine THX(DJ5TED)	GDS10069	Drive Shaft		28	37	63	112.5	1072			
	1997.01-	2002.04	MT	R	F	Bus Engine THX(DJ5TED)	GDS10066	Drive Shaft		35	41	70	117	1085			
	1997.01-	2002.04	MT	R	F	Bus Engine THX(DJ5TED)	GDS10036	Drive Shaft	54T	28	41	63	112.5	1079			
2.8 HDi (94 kW)	2000.11-	2002.04	MT		F	Bus Engine 8140.43S(F28DTCR)	GC010011	Outer Joint	54T	35	45	70	117	73	I		
	2000.11-	2002.04	MT		F	Bus Engine 8140.43S(F28DTCR)	GC010050	Outer Joint		35	45	70	117	73	I		
	2000.11-	2002.04	MT	L	F	Bus Engine 8140.43S(F28DTCR)	GDS10033	Drive Shaft	54T	35	41	70	117	762			
	2000.11-	2002.04	MT	L	F	Bus Engine 8140.43S(F28DTCR)	GDS10067	Drive Shaft		35	41	70	117	762			
	2000.11-	2002.04	MT	R	F	Bus Engine 8140.43S(F28DTCR)	GDS10032	Drive Shaft	54T	35	41	70	117	1085			
	2000.11-	2002.04	MT	R	F	Bus Engine 8140.43S(F28DTCR)	GDS10066	Drive Shaft		35	41	70	117	1085			
<b>BOXER (244)</b>																	
2.0 (81 kW)	2002.04-		MT		F	Box Engine RFL(XU10J2U)	GC010011	Outer Joint	54T	35	45	70	117	73	I		
	2002.04-		MT		F	Box Engine RFL(XU10J2U)	GC010013	Outer Joint	54T	28	39	63	112.5	63	I		
2.0 HDi (62 kW)	2002.04-		MT		F	Box Engine RHV(DW10TD)/RHV(DW10UTD)	GC010013	Outer Joint	54T	28	39	63	112.5	63	I		
	2002.04-		MT		F	Platform/Chassis Engine RHV(DW10TD)/RHV(DW10UTD)	GC010013	Outer Joint	54T	28	39	63	112.5	63	I		
2.8 HDi (94 kW)	2002.04-		MT		F	Box Engine 8140.43S(F28DTCR)	GC010011	Outer Joint	54T	35	45	70	117	73	I		
	2002.04-		MT		F	Box Engine 8140.43S(F28DTCR)	GC010013	Outer Joint	54T	28	39	63	112.5	63	I		
	2002.04-		MT		F	Platform/Chassis Engine 8140.43S(F28DTCR)	GC010011	Outer Joint	54T	35	45	70	117	73	I		
	2002.04-		MT		F	Platform/Chassis Engine 8140.43S(F28DTCR)	GC010013	Outer Joint	54T	28	39	63	112.5	63	I		
2.8 HDi 4x4 (94 kW)	2002.04-		MT		F	Box Engine 8140.43S(F28DTCR)	GC010013	Outer Joint	54T	28	39	63	112.5	63	I		
	2002.04-		MT		F	Platform/Chassis Engine 8140.43S(F28DTCR)	GC010013	Outer Joint	54T	28	39	63	112.5	63	I		
<b>BOXER (244, Z_)</b>																	
2.0 (81 kW)	2002.04-		MT		F	Bus Engine RFL(XU10J2U)	GC010011	Outer Joint	54T	35	45	70	117	73	I		
	2002.04-		MT		F	Bus Engine RFL(XU10J2U)	GC010013	Outer Joint	54T	28	39	63	112.5	63	I		
2.0 HDi (62 kW)	2002.04-		MT		F	Bus Engine RHV(DW10TD)/RHV(DW10UTD)	GC010013	Outer Joint	54T	28	39	63	112.5	63	I		
2.8 HDi (94 kW)	2002.04-		MT		F	Bus Engine 8140.43S(F28DTCR)	GC010011	Outer Joint	54T	35	45	70	117	73	I		
	2002.04-		MT		F	Bus Engine 8140.43S(F28DTCR)	GC010013	Outer Joint	54T	28	39	63	112.5	63	I		
2.8 HDi 4x4 (94 kW)	2002.04-		MT		F	Bus Engine 8140.43S(F28DTCR)	GC010013	Outer Joint	54T	28	39	63	112.5	63	I		
<b>BOXER (ZCT_)</b>																	
1.9 TD (66 kW)	1998.12-	2002.04	MT		F	Platform/Chassis Engine DHY(XUD9TE)	GC010011	Outer Joint	54T	35	45	70	117	73	I		
	1998.12-	2002.04	MT		F	Platform/Chassis Engine DHY(XUD9TE)	GC010013	Outer Joint	54T	28	39	63	112.5	63	I		
	1998.12-	2002.04	MT		F	Platform/Chassis Engine DHY(XUD9TE)	GC010050	Outer Joint		35	45	70	117	73	I		
	1998.12-	2002.04	MT		F	Platform/Chassis Engine DHY(XUD9TE)	GC010012	Outer Joint		28	39	63	112.5	63	I		
	1998.12-	2002.04	MT	L	F	Platform/Chassis Engine DHY(XUD9TE)	GDS10033	Drive Shaft	54T	35	41	70	117	762			





		TRANSM	L/R	F/R		G-AP Ref.	PRODUCT	ABS	Technical Specifications									
									YEAR	A	B	C	H	L	P			
<b>PEUGEOT BOXER (ZCT_)</b>																		
1.9 TD (66 kW)	1998.12-	2002.04	MT	L	F	Platform/Chassis Engine DHY(XUD9TE)	GDS10105	Drive Shaft		28	37	63	112.5	771				
	1998.12-	2002.04	MT	L	F	Platform/Chassis Engine DHY(XUD9TE)	GDS10067	Drive Shaft		35	41	70	117	762				
	1998.12-	2002.04	MT	L	F	Platform/Chassis Engine DHY(XUD9TE)	GDS10035	Drive Shaft	54T	28	41	63	112.5	757.5				
	1998.12-	2002.04	MT	L	F	Platform/Chassis Engine DHY(XUD9TE)	GDS10102	Drive Shaft		28	41	63	112.5	757.5				
	1998.12-	2002.04	MT	L	F	Platform/Chassis Engine DHY(XUD9TE)	GDS10037	Drive Shaft	54T	28	37	63	112.5	771				
	1998.12-	2002.04	MT	R	F	Platform/Chassis Engine DHY(XUD9TE)	GDS10103	Drive Shaft		28	41	63	112.5	1079				
	1998.12-	2002.04	MT	R	F	Platform/Chassis Engine DHY(XUD9TE)	GDS10104	Drive Shaft	54T	28	37	63	112.5	1072				
	1998.12-	2002.04	MT	R	F	Platform/Chassis Engine DHY(XUD9TE)	GDS10032	Drive Shaft	54T	35	41	70	117	1085				
	1998.12-	2002.04	MT	R	F	Platform/Chassis Engine DHY(XUD9TE)	GDS10069	Drive Shaft		28	37	63	112.5	1072				
	1998.12-	2002.04	MT	R	F	Platform/Chassis Engine DHY(XUD9TE)	GDS10066	Drive Shaft		35	41	70	117	1085				
1.9 TD (68 kW)	1996.07-	2002.04	MT		F	Platform/Chassis Engine D8C(XUD9UTF)	GC010011	Outer Joint	54T	35	45	70	117	73	I			
	1996.07-	2002.04	MT		F	Platform/Chassis Engine D8C(XUD9UTF)	GC010013	Outer Joint	54T	28	39	63	112.5	63	I			
	1996.07-	2002.04	MT		F	Platform/Chassis Engine D8C(XUD9UTF)	GC010050	Outer Joint		35	45	70	117	73	I			
	1996.07-	2002.04	MT		F	Platform/Chassis Engine D8C(XUD9UTF)	GC010012	Outer Joint		28	39	63	112.5	63	I			
	1996.07-	2002.04	MT	L	F	Platform/Chassis Engine D8C(XUD9UTF)	GDS10033	Drive Shaft	54T	35	41	70	117	762				
	1996.07-	2002.04	MT	L	F	Platform/Chassis Engine D8C(XUD9UTF)	GDS10105	Drive Shaft		28	37	63	112.5	771				
	1996.07-	2002.04	MT	L	F	Platform/Chassis Engine D8C(XUD9UTF)	GDS10067	Drive Shaft		35	41	70	117	762				
	1996.07-	2002.04	MT	L	F	Platform/Chassis Engine D8C(XUD9UTF)	GDS10035	Drive Shaft	54T	28	41	63	112.5	757.5				
	1996.07-	2002.04	MT	L	F	Platform/Chassis Engine D8C(XUD9UTF)	GDS10102	Drive Shaft		28	41	63	112.5	757.5				
	1996.07-	2002.04	MT	L	F	Platform/Chassis Engine D8C(XUD9UTF)	GDS10037	Drive Shaft	54T	28	37	63	112.5	771				
	1996.07-	2002.04	MT	R	F	Platform/Chassis Engine D8C(XUD9UTF)	GDS10103	Drive Shaft		28	41	63	112.5	1079				
	1996.07-	2002.04	MT	R	F	Platform/Chassis Engine D8C(XUD9UTF)	GDS10104	Drive Shaft	54T	28	37	63	112.5	1072				
	1996.07-	2002.04	MT	R	F	Platform/Chassis Engine D8C(XUD9UTF)	GDS10032	Drive Shaft	54T	35	41	70	117	1085				
	1996.07-	2002.04	MT	R	F	Platform/Chassis Engine D8C(XUD9UTF)	GDS10069	Drive Shaft		28	37	63	112.5	1072				
	1996.07-	2002.04	MT	R	F	Platform/Chassis Engine D8C(XUD9UTF)	GDS10066	Drive Shaft		35	41	70	117	1085				
	2.0 i (80 kW)	1994.06-	2002.04	MT	L	F	Platform/Chassis Engine RFW(XU10J2)	GDS10102	Drive Shaft		28	41	63	112.5	757.5			
1994.06-		2002.04	MT	L	F	Platform/Chassis Engine RFW(XU10J2)	GDS10037	Drive Shaft	54T	28	37	63	112.5	771				
1994.06-		2002.04	MT	R	F	Platform/Chassis Engine RFW(XU10J2)	GDS10103	Drive Shaft		28	41	63	112.5	1079				
1994.06-		2002.04	MT	R	F	Platform/Chassis Engine RFW(XU10J2)	GDS10104	Drive Shaft	54T	28	37	63	112.5	1072				
1994.06-		2002.04	MT	R	F	Platform/Chassis Engine RFW(XU10J2)	GDS10032	Drive Shaft	54T	35	41	70	117	1085				
1994.06-		2002.04	MT	R	F	Platform/Chassis Engine RFW(XU10J2)	GDS10069	Drive Shaft		28	37	63	112.5	1072				
1994.06-		2002.04	MT	R	F	Platform/Chassis Engine RFW(XU10J2)	GDS10066	Drive Shaft		35	41	70	117	1085				
1994.06-		2002.04	MT	R	F	Platform/Chassis Engine RFW(XU10J2)	GDS10036	Drive Shaft	54T	28	41	63	112.5	1079				
1994.06-		2002.04	MT		F	Platform/Chassis Engine RFW(XU10J2)	GC010011	Outer Joint	54T	35	45	70	117	73	I			
1994.06-		2002.04	MT		F	Platform/Chassis Engine RFW(XU10J2)	GC010013	Outer Joint	54T	28	39	63	112.5	63	I			
1994.06-		2002.04	MT		F	Platform/Chassis Engine RFW(XU10J2)	GC010050	Outer Joint		35	45	70	117	73	I			
1994.06-		2002.04	MT		F	Platform/Chassis Engine RFW(XU10J2)	GC010012	Outer Joint		28	39	63	112.5	63	I			
1994.06-		2002.04	MT	L	F	Platform/Chassis Engine RFW(XU10J2)	GDS10033	Drive Shaft	54T	35	41	70	117	762				
1994.06-		2002.04	MT	L	F	Platform/Chassis Engine RFW(XU10J2)	GDS10105	Drive Shaft		28	37	63	112.5	771				
1994.06-		2002.04	MT	L	F	Platform/Chassis Engine RFW(XU10J2)	GDS10067	Drive Shaft		35	41	70	117	762				
1994.06-		2002.04	MT	L	F	Platform/Chassis Engine RFW(XU10J2)	GDS10035	Drive Shaft	54T	28	41	63	112.5	757.5				
2.5 D (63 kW)		1994.03-	2002.04	MT		F	Platform/Chassis Engine T9A(DJ5)	GC010011	Outer Joint	54T	35	45	70	117	73	I		
		1994.03-	2002.04	MT		F	Platform/Chassis Engine T9A(DJ5)	GC010013	Outer Joint	54T	28	39	63	112.5	63	I		
	1994.03-	2002.04	MT		F	Platform/Chassis Engine T9A(DJ5)	GC010050	Outer Joint		35	45	70	117	73	I			
	1994.03-	2002.04	MT		F	Platform/Chassis Engine T9A(DJ5)	GC010012	Outer Joint		28	39	63	112.5	63	I			
	1994.03-	2002.04	MT	L	F	Platform/Chassis Engine T9A(DJ5)	GDS10033	Drive Shaft	54T	35	41	70	117	762				
	1994.03-	2002.04	MT	L	F	Platform/Chassis Engine T9A(DJ5)	GDS10105	Drive Shaft		28	37	63	112.5	771				
	1994.03-	2002.04	MT	L	F	Platform/Chassis Engine T9A(DJ5)	GDS10067	Drive Shaft		35	41	70	117	762				
	1994.03-	2002.04	MT	L	F	Platform/Chassis Engine T9A(DJ5)	GDS10035	Drive Shaft	54T	28	41	63	112.5	757.5				
	1994.03-	2002.04	MT	L	F	Platform/Chassis Engine T9A(DJ5)	GDS10102	Drive Shaft		28	41	63	112.5	757.5				
	1994.03-	2002.04	MT	L	F	Platform/Chassis Engine T9A(DJ5)	GDS10037	Drive Shaft	54T	28	37	63	112.5	771				
	1994.03-	2002.04	MT	R	F	Platform/Chassis Engine T9A(DJ5)	GDS10103	Drive Shaft		28	41	63	112.5	1079				
	1994.03-	2002.04	MT	R	F	Platform/Chassis Engine T9A(DJ5)	GDS10104	Drive Shaft	54T	28	37	63	112.5	1072				
	1994.03-	2002.04	MT	R	F	Platform/Chassis Engine T9A(DJ5)	GDS10032	Drive Shaft	54T	35	41	70	117	1085				
	1994.03-	2002.04	MT	R	F	Platform/Chassis Engine T9A(DJ5)	GDS10069	Drive Shaft		28	37	63	112.5	1072				
1994.03-	2002.04	MT	R	F	Platform/Chassis Engine T9A(DJ5)	GDS10066	Drive Shaft		35	41	70	117	1085					
2.5 D 4x4 (63 kW)	1999.07-	2002.04	MT		F	Platform/Chassis Engine T9A(DJ5)	GC010011	Outer Joint	54T	35	45	70	117	73	I			
	1999.07-	2002.04	MT		F	Platform/Chassis Engine T9A(DJ5)	GC010013	Outer Joint	54T	28	39	63	112.5	63	I			



		TRANSM	L/R	F/R		G-AP Ref.	PRODUCT	ABS	Technical Specifications							
									YEAR	A	B	C	H	L	P	
<b>PEUGEOT BOXER (ZCT_)</b>																
2.5 D 4x4 (63 kW)	1999.07-	2002.04	MT		F	Platform/Chassis Engine T9A(DJ5)	GC010050	Outer Joint		35	45	70	117	73	I	
	1999.07-	2002.04	MT		F	Platform/Chassis Engine T9A(DJ5)	GC010012	Outer Joint		28	39	63	112.5	63	I	
	1999.07-	2002.04	MT	L	F	Platform/Chassis Engine T9A(DJ5)	GDS10033	Drive Shaft	54T	35	41	70	117	762		
	1999.07-	2002.04	MT	L	F	Platform/Chassis Engine T9A(DJ5)	GDS10105	Drive Shaft		28	37	63	112.5	771		
	1999.07-	2002.04	MT	L	F	Platform/Chassis Engine T9A(DJ5)	GDS10067	Drive Shaft		35	41	70	117	762		
	1999.07-	2002.04	MT	L	F	Platform/Chassis Engine T9A(DJ5)	GDS10035	Drive Shaft	54T	28	41	63	112.5	757.5		
	1999.07-	2002.04	MT	L	F	Platform/Chassis Engine T9A(DJ5)	GDS10102	Drive Shaft		28	41	63	112.5	757.5		
	1999.07-	2002.04	MT	L	F	Platform/Chassis Engine T9A(DJ5)	GDS10037	Drive Shaft	54T	28	37	63	112.5	771		
	1999.07-	2002.04	MT	R	F	Platform/Chassis Engine T9A(DJ5)	GDS10103	Drive Shaft		28	41	63	112.5	1079		
	1999.07-	2002.04	MT	R	F	Platform/Chassis Engine T9A(DJ5)	GDS10104	Drive Shaft	54T	28	37	63	112.5	1072		
	1999.07-	2002.04	MT	R	F	Platform/Chassis Engine T9A(DJ5)	GDS10032	Drive Shaft	54T	35	41	70	117	1085		
	1999.07-	2002.04	MT	R	F	Platform/Chassis Engine T9A(DJ5)	GDS10069	Drive Shaft		28	37	63	112.5	1072		
	1999.07-	2002.04	MT	R	F	Platform/Chassis Engine T9A(DJ5)	GDS10066	Drive Shaft		35	41	70	117	1085		
2.5 TD (76 kW)	1999.07-	2002.04	MT	R	F	Platform/Chassis Engine T9A(DJ5)	GDS10036	Drive Shaft	54T	28	41	63	112.5	1079		
	1994.03-	2002.04	MT		F	Platform/Chassis Engine T8A(DJ5T)	GC010011	Outer Joint	54T	35	45	70	117	73	I	
	1994.03-	2002.04	MT		F	Platform/Chassis Engine T8A(DJ5T)	GC010013	Outer Joint	54T	28	39	63	112.5	63	I	
	1994.03-	2002.04	MT		F	Platform/Chassis Engine T8A(DJ5T)	GC010050	Outer Joint		35	45	70	117	73	I	
	1994.03-	2002.04	MT		F	Platform/Chassis Engine T8A(DJ5T)	GC010012	Outer Joint		28	39	63	112.5	63	I	
	1994.03-	2002.04	MT	L	F	Platform/Chassis Engine T8A(DJ5T)	GDS10033	Drive Shaft	54T	35	41	70	117	762		
	1994.03-	2002.04	MT	L	F	Platform/Chassis Engine T8A(DJ5T)	GDS10105	Drive Shaft		28	37	63	112.5	771		
	1994.03-	2002.04	MT	L	F	Platform/Chassis Engine T8A(DJ5T)	GDS10067	Drive Shaft		35	41	70	117	762		
	1994.03-	2002.04	MT	L	F	Platform/Chassis Engine T8A(DJ5T)	GDS10035	Drive Shaft	54T	28	41	63	112.5	757.5		
	1994.03-	2002.04	MT	L	F	Platform/Chassis Engine T8A(DJ5T)	GDS10102	Drive Shaft		28	41	63	112.5	757.5		
	1994.03-	2002.04	MT	L	F	Platform/Chassis Engine T8A(DJ5T)	GDS10037	Drive Shaft	54T	28	37	63	112.5	771		
	1994.03-	2002.04	MT	R	F	Platform/Chassis Engine T8A(DJ5T)	GDS10103	Drive Shaft		28	41	63	112.5	1079		
	1994.03-	2002.04	MT	R	F	Platform/Chassis Engine T8A(DJ5T)	GDS10104	Drive Shaft	54T	28	37	63	112.5	1072		
2.5 TDi (79 kW)	1994.03-	2002.04	MT	R	F	Platform/Chassis Engine T8A(DJ5T)	GDS10032	Drive Shaft	54T	35	41	70	117	1085		
	1994.03-	2002.04	MT	R	F	Platform/Chassis Engine T8A(DJ5T)	GDS10069	Drive Shaft		28	37	63	112.5	1072		
	1994.03-	2002.04	MT	R	F	Platform/Chassis Engine T8A(DJ5T)	GDS10066	Drive Shaft		35	41	70	117	1085		
	1994.03-	2002.04	MT	R	F	Platform/Chassis Engine T8A(DJ5T)	GDS10036	Drive Shaft	54T	28	41	63	112.5	1079		
	1997.01-	2002.04	MT		F	Platform/Chassis Engine THX(DJ5TED)	GC010011	Outer Joint	54T	35	45	70	117	73	I	
	1997.01-	2002.04	MT		F	Platform/Chassis Engine THX(DJ5TED)	GC010013	Outer Joint	54T	28	39	63	112.5	63	I	
	1997.01-	2002.04	MT		F	Platform/Chassis Engine THX(DJ5TED)	GC010050	Outer Joint		35	45	70	117	73	I	
	1997.01-	2002.04	MT		F	Platform/Chassis Engine THX(DJ5TED)	GC010012	Outer Joint		28	39	63	112.5	63	I	
	1997.01-	2002.04	MT	L	F	Platform/Chassis Engine THX(DJ5TED)	GDS10033	Drive Shaft	54T	35	41	70	117	762		
	1997.01-	2002.04	MT	L	F	Platform/Chassis Engine THX(DJ5TED)	GDS10105	Drive Shaft		28	37	63	112.5	771		
	1997.01-	2002.04	MT	L	F	Platform/Chassis Engine THX(DJ5TED)	GDS10067	Drive Shaft		35	41	70	117	762		
	1997.01-	2002.04	MT	L	F	Platform/Chassis Engine THX(DJ5TED)	GDS10035	Drive Shaft	54T	28	41	63	112.5	757.5		
	1997.01-	2002.04	MT	L	F	Platform/Chassis Engine THX(DJ5TED)	GDS10102	Drive Shaft		28	41	63	112.5	757.5		
2.5 TDi 4x4 (79 kW)	1997.01-	2002.04	MT	L	F	Platform/Chassis Engine THX(DJ5TED)	GDS10037	Drive Shaft	54T	28	37	63	112.5	771		
	1997.01-	2002.04	MT	R	F	Platform/Chassis Engine THX(DJ5TED)	GDS10103	Drive Shaft		28	41	63	112.5	1079		
	1997.01-	2002.04	MT	R	F	Platform/Chassis Engine THX(DJ5TED)	GDS10104	Drive Shaft	54T	28	37	63	112.5	1072		
	1997.01-	2002.04	MT	R	F	Platform/Chassis Engine THX(DJ5TED)	GDS10032	Drive Shaft	54T	35	41	70	117	1085		
	1997.01-	2002.04	MT	R	F	Platform/Chassis Engine THX(DJ5TED)	GDS10069	Drive Shaft		28	37	63	112.5	1072		
	1997.01-	2002.04	MT	R	F	Platform/Chassis Engine THX(DJ5TED)	GDS10066	Drive Shaft		35	41	70	117	1085		
	1997.01-	2002.04	MT	R	F	Platform/Chassis Engine THX(DJ5TED)	GDS10036	Drive Shaft	54T	28	41	63	112.5	1079		
	1999.07-	2002.04	MT		F	Platform/Chassis Engine THX(DJ5TED)	GC010011	Outer Joint	54T	35	45	70	117	73	I	
	1999.07-	2002.04	MT		F	Platform/Chassis Engine THX(DJ5TED)	GC010013	Outer Joint	54T	28	39	63	112.5	63	I	
	1999.07-	2002.04	MT		F	Platform/Chassis Engine THX(DJ5TED)	GC010050	Outer Joint		35	45	70	117	73	I	
	1999.07-	2002.04	MT		F	Platform/Chassis Engine THX(DJ5TED)	GC010012	Outer Joint		28	39	63	112.5	63	I	
	1999.07-	2002.04	MT	L	F	Platform/Chassis Engine THX(DJ5TED)	GDS10033	Drive Shaft	54T	35	41	70	117	762		
	1999.07-	2002.04	MT	L	F	Platform/Chassis Engine THX(DJ5TED)	GDS10105	Drive Shaft		28	37	63	112.5	771		
1999.07-	2002.04	MT	L	F	Platform/Chassis Engine THX(DJ5TED)	GDS10067	Drive Shaft		35	41	70	117	762			
1999.07-	2002.04	MT	L	F	Platform/Chassis Engine THX(DJ5TED)	GDS10035	Drive Shaft	54T	28	41	63	112.5	757.5			
1999.07-	2002.04	MT	L	F	Platform/Chassis Engine THX(DJ5TED)	GDS10102	Drive Shaft		28	41	63	112.5	757.5			
1999.07-	2002.04	MT	L	F	Platform/Chassis Engine THX(DJ5TED)	GDS10037	Drive Shaft	54T	28	37	63	112.5	771			
1999.07-	2002.04	MT	R	F	Platform/Chassis Engine THX(DJ5TED)	GDS10103	Drive Shaft		28	41	63	112.5	1079			
1999.07-	2002.04	MT	R	F	Platform/Chassis Engine THX(DJ5TED)	GDS10104	Drive Shaft	54T	28	37	63	112.5	1072			
1999.07-	2002.04	MT	R	F	Platform/Chassis Engine THX(DJ5TED)	GDS10032	Drive Shaft	54T	35	41	70	117	1085			
1999.07-	2002.04	MT	R	F	Platform/Chassis Engine THX(DJ5TED)	GDS10069	Drive Shaft		28	37	63	112.5	1072			
1999.07-	2002.04	MT	R	F	Platform/Chassis Engine THX(DJ5TED)	GDS10066	Drive Shaft		35	41	70	117	1085			





		YEAR	TRANSM	L/R	F/R		G-AP Ref.	PRODUCT	ABS	Technical Specifications											
										A	B	C	H	L	P						
<b>PEUGEOT BOXER (ZCT_)</b>																					
2.5 TDi 4x4 (79 kW)	1999.07-	2002.04	MT	R	F	Platform/Chassis Engine THX(DJ5TED)	GDS10036	Drive Shaft	54T		28	41	63	112.5	1079						
2.8 HDi (94 kW)	2000.11-	2002.04	MT		F	Platform/Chassis Engine 8140.43S(F28DTCR)	GC010011	Outer Joint	54T		35	45	70	117	73	I					
	2000.11-	2002.04	MT		F	Platform/Chassis Engine 8140.43S(F28DTCR)	GC010050	Outer Joint			35	45	70	117	73	I					
	2000.11-	2002.04	MT	L	F	Platform/Chassis Engine 8140.43S(F28DTCR)	GDS10033	Drive Shaft	54T		35	41	70	117	762						
	2000.11-	2002.04	MT	L	F	Platform/Chassis Engine 8140.43S(F28DTCR)	GDS10067	Drive Shaft			35	41	70	117	762						
	2000.11-	2002.04	MT	R	F	Platform/Chassis Engine 8140.43S(F28DTCR)	GDS10032	Drive Shaft	54T		35	41	70	117	1085						
	2000.11-	2002.04	MT	R	F	Platform/Chassis Engine 8140.43S(F28DTCR)	GDS10066	Drive Shaft			35	41	70	117	1085						
<b>BOXER I-II</b>																					
2.5 D	1994-	2006		L	F		GDS10033	Drive Shaft	54T		35	41	70	117	762						
2.8 HDI	1994-	2006		L	F		GDS10033	Drive Shaft	54T		35	41	70	117	762						
<b>BOXER III</b>																					
2.2 HDi	2006-			L	F		GDS17053	Drive Shaft			35	41	71.5	127	806						
	2006-			L	F		GCI17028	Inner Joint			41	29	43	69.5	109.5						
	2006-			R	F		GDS17050	Drive Shaft			35	41	71.5	127	1140						
	2006-			R	F		GCI17020	Inner Joint			41	29	34.85	403	109						
	2006-			R/L	F		GC017045	Outer Joint			35	29	71.5	127	71	M					
<b>EXPERT</b>																					
1.6 HDi (66 kW)	2007.01-			L	F	Platform/Chassis Engine 9HU(DV6UTED4)	GDS45133	Drive Shaft			28	37	58.6	94	653						
	2007.01-		MT	R	F	Platform/Chassis Engine 9HU(DV6UTED4)	GDS10239	Drive Shaft			28	24	58.5	92	958						
	2007.01-					Platform/Chassis Engine 9HU(DV6UTED4)	GC010124	Outer Joint			28	34	58.5	92	55	I					
2.0 HDi (100 kW)	2007.01-				F	Platform/Chassis Engine RHR(DW10BTED4)	GC010098	Outer Joint			28	39	58.6	93	63	I					
	2007.01-		MT	L	F	Platform/Chassis Engine RHR(DW10BTED4)	GDS45133	Drive Shaft			28	37	58.6	94	653						
	2007.01-			R	F	Platform/Chassis Engine RHR(DW10BTED4)	GDS99214	Drive Shaft			28	37	58.6	94	978						
	2007.01-			R	F	Platform/Chassis Engine RHR(DW10BTED4)	GCI10041	Inner Joint			37	39	32	399	95.5						
	2007.01-			R	F	Platform/Chassis Engine RHR(DW10BTED4)	GC010159	Outer Joint			28	39	58.6	94	63	I					
	2007.01-			R		Platform/Chassis Engine RHR(DW10BTED4)	GDS10244	Drive Shaft			28	37	58.6	93	979						
2.0 HDi (88 kW)	2007.01-				F	Platform/Chassis Engine RHK(DW10UTED4)	GC010098	Outer Joint			28	39	58.6	93	63	I					
	2007.01-		MT	L	F	Platform/Chassis Engine RHK(DW10UTED4)	GDS45133	Drive Shaft			28	37	58.6	94	653						
	2007.01-			R	F	Platform/Chassis Engine RHK(DW10UTED4)	GDS99214	Drive Shaft			28	37	58.6	94	978						
	2007.01-			R	F	Platform/Chassis Engine RHK(DW10UTED4)	GCI10041	Inner Joint			37	39	32	399	95.5						
	2007.01-			R	F	Platform/Chassis Engine RHK(DW10UTED4)	GC010159	Outer Joint			28	39	58.6	94	63	I					
	2007.01-			R		Platform/Chassis Engine RHK(DW10UTED4)	GDS10244	Drive Shaft			28	37	58.6	93	979						
<b>EXPERT (224)</b>																					
2.0 HDi (69 kW)	2000.10-	2003.11			F	MPV Engine RHX(DW10BTED)	GC010015	Outer Joint	48T		27	39	59	82	63	I					
2.0 HDi (80 kW)	2000.07-			R	F	MPV Engine RHZ(DW10ATED)	GDS10237	Drive Shaft	48T		27	37	59	82	953						
	2004.03-	2007.01			F	MPV Engine RHW(DW10ATED4)	GC010015	Outer Joint	48T		27	39	59	82	63	I					
<b>EXPERT (VF3A_, VF3U_, VF3X_)</b>																					
1.6 HDi (66 kW)	2007.01-			L	F	Box Engine 9HU(DV6UTED4)	GDS45133	Drive Shaft			28	37	58.6	94	653						
	2007.01-		MT	R	F	Box Engine 9HU(DV6UTED4)	GDS10239	Drive Shaft			28	24	58.5	92	958						
	2007.01-					Box Engine 9HU(DV6UTED4)	GC010124	Outer Joint			28	34	58.5	92	55	I					
1.6 HDi 8V (66 kW)	2007.01-				Box Engine 9HH(DV6DUM)/9HM(DV6UC)	GC010124	Outer Joint			28	34	58.5	92	55	I						
2.0 16V (103 kW)	2007.01-				Box Engine RFH(EW10A)/RFJ(EW10A)	GC010124	Outer Joint			28	34	58.5	92	55	I						
2.0 HDi (100 kW)	2007.01-				F	Box Engine RHR(DW10BTED4)	GC010098	Outer Joint			28	39	58.6	93	63	I					
	2007.01-		MT	L	F	Box Engine RHR(DW10BTED4)	GDS45133	Drive Shaft			28	37	58.6	94	653						
	2007.01-			R	F	Box Engine RHR(DW10BTED4)	GDS99214	Drive Shaft			28	37	58.6	94	978						
	2007.01-			R	F	Box Engine RHR(DW10BTED4)	GCI10041	Inner Joint			37	39	32	399	95.5						
	2007.01-			R	F	Box Engine RHR(DW10BTED4)	GC010159	Outer Joint			28	39	58.6	94	63	I					
	2007.01-			R		Box Engine RHR(DW10BTED4)	GDS10244	Drive Shaft			28	37	58.6	93	979						
2.0 HDi (120 kW)	2009.09-		MT	L	F	Box Engine RHH(DW10CTED4)	GDS45133	Drive Shaft			28	37	58.6	94	653						
	2009.09-			R	F	Box Engine RHH(DW10CTED4)	GDS99214	Drive Shaft			28	37	58.6	94	978						
	2009.09-			R	F	Box Engine RHH(DW10CTED4)	GCI10041	Inner Joint			37	39	32	399	95.5						
	2009.09-			R	F	Box Engine RHH(DW10CTED4)	GC010159	Outer Joint			28	39	58.6	94	63	I					
2.0 HDi (72 kW)	2011.03-		MT	L	F	Box	GDS45133	Drive Shaft			28	37	58.6	94	653						
	2011.03-			R	F	Box	GDS99214	Drive Shaft			28	37	58.6	94	978						
	2011.03-			R	F	Box	GCI10041	Inner Joint			37	39	32	399	95.5						
	2011.03-			R	F	Box	GC010159	Outer Joint			28	39	58.6	94	63	I					
2.0 HDi (88 kW)	2007.01-				F	Box Engine RHK(DW10UTED4)	GC010098	Outer Joint			28	39	58.6	93	63	I					
	2007.01-		MT	L	F	Box Engine RHK(DW10UTED4)	GDS45133	Drive Shaft			28	37	58.6	94	653						
	2007.01-			R	F	Box Engine RHK(DW10UTED4)	GDS99214	Drive Shaft			28	37	58.6	94	978						
	2007.01-			R	F	Box Engine RHK(DW10UTED4)	GCI10041	Inner Joint			37	39	32	399	95.5						
2007.01-			R	F	Box Engine RHK(DW10UTED4)	GC010159	Outer Joint			28	39	58.6	94	63	I						









		YEAR	TRANSM	L/R	F/R		G-AP Ref.	PRODUCT	ABS	Technical Specifications						
										A	B	C	H	L	P	
<b>PEUGEOT</b>																
<b>EXPERT (VF3A_, VF3U_, VF3X_)</b>																
2.0 HDi (88 kW)	2007.01-					Box Engine RHK(DW10UTED4)	GDS10244	Drive Shaft			28	37	58.6	93	979	
2.0 HDi (94 kW)	2011.03-		MT	L	F	Box	GDS45133	Drive Shaft			28	37	58.6	94	653	
	2011.03-			R	F	Box	GDS99214	Drive Shaft			28	37	58.6	94	978	
	2011.03-			R	F	Box	GCI10041	Inner Joint			37	39	32	399	95.5	
	2011.03-			R	F	Box	GC010159	Outer Joint			28	39	58.6	94	63	I
<b>EXPERT TEPEE</b>																
1.6 HDi	2006-			L	F		GDS10238	Drive Shaft			28	24	58.5	92	669	
	2006-			L	F		GC010095	Outer Joint			28	34	58.5	92	55	I
	2006-			L	F		GCI99158	Inner Joint			24	34	40	62	89	
	2006-						GDS10239	Drive Shaft			28	24	58.5	92	958	
	2006-						GC010095	Outer Joint			28	34	58.5	92	55	I
<b>EXPERT TEPEE (VF3V_)</b>																
1.6 HDi (66 kW)	2007.01-			L	F	MPV Engine 9HU(DV6HUTED4)	GDS45133	Drive Shaft			28	37	58.6	94	653	
	2007.01-		MT	R	F	MPV Engine 9HU(DV6HUTED4)	GDS10239	Drive Shaft			28	24	58.5	92	958	
	2007.01-					MPV Engine 9HU(DV6HUTED4)	GC010124	Outer Joint			28	34	58.5	92	55	I
1.6 HDi 8V (66 kW)	2007.01-				MPV Engine 9HH(DV6DUM)/9HM(DV6UC)	GC010124	Outer Joint			28	34	58.5	92	55	I	
2.0 16V (103 kW)	2007.01-				MPV Engine RFH(EW10A)/RFJ(EW10A)	GC010124	Outer Joint			28	34	58.5	92	55	I	
2.0 HDi (100 kW)	2007.01-				F	MPV Engine RHR(DW10BTED4)	GC010098	Outer Joint			28	39	58.6	93	63	I
	2007.01-		MT	L	F	MPV Engine RHR(DW10BTED4)	GDS45133	Drive Shaft			28	37	58.6	94	653	
	2007.01-			R	F	MPV Engine RHR(DW10BTED4)	GDS99214	Drive Shaft			28	37	58.6	94	978	
	2007.01-			R	F	MPV Engine RHR(DW10BTED4)	GCI10041	Inner Joint			37	39	32	399	95.5	
	2007.01-			R	F	MPV Engine RHR(DW10BTED4)	GC010159	Outer Joint			28	39	58.6	94	63	I
	2007.01-			R		MPV Engine RHR(DW10BTED4)	GDS10244	Drive Shaft			28	37	58.6	93	979	
	2007.01-			R		MPV Engine RHR(DW10BTED4)	GDS45133	Drive Shaft			28	37	58.6	94	653	
2.0 HDi (120 kW)	2009.09-		MT	L	F	MPV Engine RHH(DW10CTED4)	GDS45133	Drive Shaft			28	37	58.6	94	653	
	2009.09-			R	F	MPV Engine RHH(DW10CTED4)	GDS99214	Drive Shaft			28	37	58.6	94	978	
	2009.09-			R	F	MPV Engine RHH(DW10CTED4)	GCI10041	Inner Joint			37	39	32	399	95.5	
	2009.09-			R	F	MPV Engine RHH(DW10CTED4)	GC010159	Outer Joint			28	39	58.6	94	63	I
2.0 HDi (72 kW)	2011.03-		MT	L	F	MPV	GDS45133	Drive Shaft			28	37	58.6	94	653	
	2011.03-			R	F	MPV	GDS99214	Drive Shaft			28	37	58.6	94	978	
	2011.03-			R	F	MPV	GCI10041	Inner Joint			37	39	32	399	95.5	
	2011.03-			R	F	MPV	GC010159	Outer Joint			28	39	58.6	94	63	I
2.0 HDi (88 kW)	2007.01-				F	MPV Engine RHK(DW10UTED4)	GC010098	Outer Joint			28	39	58.6	93	63	I
	2007.01-		MT	L	F	MPV Engine RHK(DW10UTED4)	GDS45133	Drive Shaft			28	37	58.6	94	653	
	2007.01-			R	F	MPV Engine RHK(DW10UTED4)	GDS99214	Drive Shaft			28	37	58.6	94	978	
	2007.01-			R	F	MPV Engine RHK(DW10UTED4)	GCI10041	Inner Joint			37	39	32	399	95.5	
	2007.01-			R	F	MPV Engine RHK(DW10UTED4)	GC010159	Outer Joint			28	39	58.6	94	63	I
	2007.01-			R		MPV Engine RHK(DW10UTED4)	GDS10244	Drive Shaft			28	37	58.6	93	979	
2.0 HDi (94 kW)	2011.03-		MT	L	F	MPV Engine AHZ(DW10CD)	GDS45133	Drive Shaft			28	37	58.6	94	653	
	2011.03-			R	F	MPV Engine AHZ(DW10CD)	GDS99214	Drive Shaft			28	37	58.6	94	978	
	2011.03-			R	F	MPV Engine AHZ(DW10CD)	GCI10041	Inner Joint			37	39	32	399	95.5	
	2011.03-			R	F	MPV Engine AHZ(DW10CD)	GC010159	Outer Joint			28	39	58.6	94	63	I
2.0 HDi 4x4 (88 kW)	2007.01-		MT	L	F	MPV Engine RHK(DW10UTED4)	GDS45133	Drive Shaft			28	37	58.6	94	653	
	2007.01-			R	F	MPV Engine RHK(DW10UTED4)	GDS99214	Drive Shaft			28	37	58.6	94	978	
	2007.01-			R	F	MPV Engine RHK(DW10UTED4)	GCI10041	Inner Joint			37	39	32	399	95.5	
	2007.01-			R	F	MPV Engine RHK(DW10UTED4)	GC010159	Outer Joint			28	39	58.6	94	63	I
	2007.01-			R		MPV Engine RHK(DW10UTED4)	GDS10244	Drive Shaft			28	37	58.6	93	979	
<b>EXPERT VAN (222)</b>																
2.0 (100 kW)	2002.09-				F	Box Engine RFN(EW10J4)	GC010018	Outer Joint	48T		27	34	61	82	55	I
<b>J10 PREMIER</b>																
2.3 D	2010-			L/R	F		GC010109	Outer Joint	72T		30	30	74.45	120.3	63	M
	2010-			L/R	F		GCI45031	Inner Joint			34	30	61.3	47.5	75	
	2010-			R	F		GDS10270	Drive Shaft	72T		30	34	74.45	120.3	771.5	
<b>J5</b>																
-							GC010104	Outer Joint	54T		28	27	63	112.5	63	I
<b>J5 (280L)</b>																
1.8 (51 kW)	1983.01-	1988.11	MT/AT	R	F	Box Engine 169B(XM7T)	GDS10068	Drive Shaft			28	25	63	112.5	1068	
	1983.01-	1988.11			F	Box Engine 169B(XM7T)	GC010010	Outer Joint			28	27	63	112.5	63	I
	1983.01-	1988.11	MT/AT	L	F	Box Engine 169B(XM7T)	GDS10034	Drive Shaft			28	25	63	112.5	701	
2.0 (55 kW)	1986.01-	1988.11	MT/AT	R	F	Platform/Chassis Engine 170B(XN1T)	GDS10068	Drive Shaft			28	25	63	112.5	1068	
	1986.01-	1988.11			F	Platform/Chassis Engine 170B(XN1T)	GC010010	Outer Joint			28	27	63	112.5	63	I
	1986.01-	1988.11	MT/AT	L	F	Platform/Chassis Engine 170B(XN1T)	GDS10034	Drive Shaft			28	25	63	112.5	701	



		TRANSM	L/R	F/R		G-AP Ref.	PRODUCT	ABS	Technical Specifications					
									YEAR	A	B	C	H	L
<b>PEUGEOT</b>														
<b>J5 (280L)</b>														
2.0 (55 kW)	1987.09-1990.08			F	Box Engine XN1T	GC010010	Outer Joint		28	27	63	112.5	63	I
2.0 (58 kW)	1981.09-1990.08			F	Box Engine XN1P	GC010010	Outer Joint		28	27	63	112.5	63	I
	1983.01-1988.11	MT/AT	R	F	Platform/Chassis Engine 170(XN1T)	GDS10068	Drive Shaft		28	25	63	112.5	1068	
	1983.01-1988.11			F	Platform/Chassis Engine 170(XN1T)	GC010010	Outer Joint		28	27	63	112.5	63	I
	1983.01-1988.11	MT/AT	L	F	Platform/Chassis Engine 170(XN1T)	GDS10034	Drive Shaft		28	25	63	112.5	701	
2.5 D (54 kW)	1981.09-1990.09	MT/AT	R	F	Platform/Chassis Engine CRD93(U25/661)	GDS10068	Drive Shaft		28	25	63	112.5	1068	
	1981.09-1990.08			F	Box Engine CRD93	GC010010	Outer Joint		28	27	63	112.5	63	I
	1981.09-1990.09			F	Platform/Chassis Engine CRD93(U25/661)	GC010010	Outer Joint		28	27	63	112.5	63	I
	1981.09-1990.09	MT/AT	L	F	Platform/Chassis Engine CRD93(U25/661)	GDS10034	Drive Shaft		28	25	63	112.5	701	
2.5 DT (70 kW)	1981.09-1990.08			F	Box Engine CRD93L/CRD93LS(U25/673)	GC010010	Outer Joint		28	27	63	112.5	63	I
<b>J5 (280P)</b>														
2.0 (55 kW)	1981.09-1990.09	MT/AT	R	F	Bus Engine 170B(XN1T)	GDS10068	Drive Shaft		28	25	63	112.5	1068	
	1981.09-1990.09			F	Bus Engine 170B(XN1T)	GC010010	Outer Joint		28	27	63	112.5	63	I
	1981.09-1990.09	MT/AT	L	F	Bus Engine 170B(XN1T)	GDS10034	Drive Shaft		28	25	63	112.5	701	
2.0 (58 kW)	1983.01-1990.09	MT/AT	R	F	Bus Engine 170(XN1T)	GDS10068	Drive Shaft		28	25	63	112.5	1068	
	1983.01-1990.09			F	Bus Engine 170(XN1T)	GC010010	Outer Joint		28	27	63	112.5	63	I
	1983.01-1990.09	MT/AT	L	F	Bus Engine 170(XN1T)	GDS10034	Drive Shaft		28	25	63	112.5	701	
2.5 D (54 kW)	1981.09-1990.09	MT/AT	R	F	Bus Engine CRD93(U25/661)	GDS10068	Drive Shaft		28	25	63	112.5	1068	
	1981.09-1990.09			F	Bus Engine CRD93(U25/661)	GC010010	Outer Joint		28	27	63	112.5	63	I
	1981.09-1990.09	MT/AT	L	F	Bus Engine CRD93(U25/661)	GDS10034	Drive Shaft		28	25	63	112.5	701	
<b>J5 (290L)</b>														
1.8 (51 kW)	1990.09-1994.01			F	Box Engine 169B(XM7T)	GC010010	Outer Joint		28	27	63	112.5	63	I
1.9 D (51 kW)	1990.10-1994.03	MT/AT	R	F	Box Engine D9B(XUD9A)	GDS10068	Drive Shaft		28	25	63	112.5	1068	
	1990.10-1994.02	MT/AT	R	F	Platform/Chassis Engine D9B(XUD9A)	GDS10068	Drive Shaft		28	25	63	112.5	1068	
	1990.10-1994.03		R	F	Box Engine D9B(XUD9A)	GDS10013	Drive Shaft		28	25	63	112.5	1072	
	1990.10-1994.02		R	F	Platform/Chassis Engine D9B(XUD9A)	GDS10013	Drive Shaft		28	25	63	112.5	1072	
	1990.10-1994.03	MT/AT	L	F	Box Engine D9B(XUD9A)	GDS10034	Drive Shaft		28	25	63	112.5	701	
	1990.10-1994.02	MT/AT	L	F	Platform/Chassis Engine D9B(XUD9A)	GDS10034	Drive Shaft		28	25	63	112.5	701	
2.0 (62 kW)	1990.09-1994.01			F	Box Engine XN1TA/170D(XN1TACP)	GC010010	Outer Joint		28	27	63	112.5	63	I
	1990.10-1994.02	MT/AT	R	F	Platform/Chassis Engine 170D(XN1TACP)	GDS10068	Drive Shaft		28	25	63	112.5	1068	
	1990.10-1994.02			F	Platform/Chassis Engine 170D(XN1TACP)	GC010010	Outer Joint		28	27	63	112.5	63	I
	1990.10-1994.02	MT/AT	L	F	Platform/Chassis Engine 170D(XN1TACP)	GDS10034	Drive Shaft		28	25	63	112.5	701	
2.5 D (54 kW)	1990.09-1994.01			F	Box Engine CRD93	GC010010	Outer Joint		28	27	63	112.5	63	I
	1990.10-1994.02	MT/AT	R	F	Platform/Chassis Engine CRD93(U25/661)	GDS10068	Drive Shaft		28	25	63	112.5	1068	
	1990.10-1994.02			F	Platform/Chassis Engine CRD93(U25/661)	GC010010	Outer Joint		28	27	63	112.5	63	I
	1990.10-1994.02	MT/AT	L	F	Platform/Chassis Engine CRD93(U25/661)	GDS10034	Drive Shaft		28	25	63	112.5	701	
2.5 D 4x4 (54 kW)	1990.10-1994.03	MT/AT	R	F	Box Engine CRD93(U25/661)	GDS10068	Drive Shaft		28	25	63	112.5	1068	
	1990.10-1994.02	MT/AT	R	F	Platform/Chassis Engine CRD93(U25/661)	GDS10068	Drive Shaft		28	25	63	112.5	1068	
	1990.10-1994.03				Box Engine CRD93(U25/661)	GC010010	Outer Joint		28	27	63	112.5	63	I
	1990.10-1994.02				Platform/Chassis Engine CRD93(U25/661)	GC010010	Outer Joint		28	27	63	112.5	63	I
	1990.10-1994.03	MT/AT	L		Box Engine CRD93(U25/661)	GDS10034	Drive Shaft		28	25	63	112.5	701	
	1990.10-1994.02	MT/AT	L		Platform/Chassis Engine CRD93(U25/661)	GDS10034	Drive Shaft		28	25	63	112.5	701	
2.5 DT (70 kW)	1990.09-1994.01			F	Box Engine CRD93L	GC010010	Outer Joint		28	27	63	112.5	63	I
2.5 TD (70 kW)	1990.10-1994.02	MT/AT	R	F	Platform/Chassis Engine CRD93LS(U25/673)	GDS10068	Drive Shaft		28	25	63	112.5	1068	
	1990.10-1994.02			F	Platform/Chassis Engine CRD93LS(U25/673)	GC010010	Outer Joint		28	27	63	112.5	63	I
	1990.10-1994.02	MT/AT	L	F	Platform/Chassis Engine CRD93LS(U25/673)	GDS10034	Drive Shaft		28	25	63	112.5	701	
2.5 TD 4x4 (70 kW)	1990.10-1994.03	MT/AT	R	F	Box Engine CRD93LS(U25/673)	GDS10068	Drive Shaft		28	25	63	112.5	1068	
	1990.10-1994.02	MT/AT	R	F	Platform/Chassis Engine CRD93LS(U25/673)	GDS10068	Drive Shaft		28	25	63	112.5	1068	
	1990.10-1994.03				Box Engine CRD93LS(U25/673)	GC010010	Outer Joint		28	27	63	112.5	63	I
	1990.10-1994.02				Platform/Chassis Engine CRD93LS(U25/673)	GC010010	Outer Joint		28	27	63	112.5	63	I
	1990.10-1994.03	MT/AT	L		Box Engine CRD93LS(U25/673)	GDS10034	Drive Shaft		28	25	63	112.5	701	
	1990.10-1994.02	MT/AT	L		Platform/Chassis Engine CRD93LS(U25/673)	GDS10034	Drive Shaft		28	25	63	112.5	701	
<b>J5 (290P)</b>														
1.9 D (51 kW)	1990.10-1994.02	MT/AT	R	F	Bus Engine D9B(XUD9A)	GDS10068	Drive Shaft		28	25	63	112.5	1068	
	1990.10-1994.02		R	F	Bus Engine D9B(XUD9A)	GDS10013	Drive Shaft		28	25	63	112.5	1072	
	1990.10-1994.02	MT/AT	L	F	Bus Engine D9B(XUD9A)	GDS10034	Drive Shaft		28	25	63	112.5	701	
2.0 (62 kW)	1990.10-1994.02	MT/AT	R	F	Bus Engine 170D(XN1TACP)	GDS10068	Drive Shaft		28	25	63	112.5	1068	
	1990.10-1994.02			F	Bus Engine 170D(XN1TACP)	GC010010	Outer Joint		28	27	63	112.5	63	I
	1990.10-1994.02	MT/AT	L	F	Bus Engine 170D(XN1TACP)	GDS10034	Drive Shaft		28	25	63	112.5	701	
2.5 D (54 kW)	1990.10-1994.02	MT/AT	R	F	Bus Engine CRD93(U25/661)	GDS10068	Drive Shaft		28	25	63	112.5	1068	
	1990.10-1994.02			F	Bus Engine CRD93(U25/661)	GC010010	Outer Joint		28	27	63	112.5	63	I

		TRANSM	L/R	F/R		G-AP Ref.	PRODUCT	ABS	Technical Specifications							
									YEAR	A	B	C	H	L	P	
<b>PEUGEOT</b>																
<b>J5 (290P)</b>																
2.5 D (54 kW)	1990.10-	1994.02	MT/AT	L	F	Bus Engine CRD93(U25/661)	GDS10034	Drive Shaft		28	25	63	112.5	701		
2.5 D 4x4 (54 kW)	1990.10-	1994.02	MT/AT	R	F	Bus Engine CRD93(U25/661)	GDS10068	Drive Shaft		28	25	63	112.5	1068		
	1990.10-	1994.02				Bus Engine CRD93(U25/661)	GC010010	Outer Joint		28	27	63	112.5	63	I	
	1990.10-	1994.02	MT/AT	L		Bus Engine CRD93(U25/661)	GDS10034	Drive Shaft		28	25	63	112.5	701		
2.5 TD (70 kW)	1990.10-	1994.02	MT/AT	R	F	Bus Engine CRD93LS(U25/673)	GDS10068	Drive Shaft		28	25	63	112.5	1068		
	1990.10-	1994.02			F	Bus Engine CRD93LS(U25/673)	GC010010	Outer Joint		28	27	63	112.5	63	I	
	1990.10-	1994.02	MT/AT	L	F	Bus Engine CRD93LS(U25/673)	GDS10034	Drive Shaft		28	25	63	112.5	701		
2.5 TD 4x4 (70 kW)	1990.10-	1994.02	MT/AT	R	F	Bus Engine CRD93LS(U25/673)	GDS10068	Drive Shaft		28	25	63	112.5	1068		
	1990.10-	1994.02				Bus Engine CRD93LS(U25/673)	GC010010	Outer Joint		28	27	63	112.5	63	I	
	1990.10-	1994.02	MT/AT	L		Bus Engine CRD93LS(U25/673)	GDS10034	Drive Shaft		28	25	63	112.5	701		
<b>J9</b>																
-	1994-						GC099002	Outer Joint		30	27	74.45	120.3	63	I	
1.6 (44 kW)	1980.03-	1987.06	MT/AT	L/R	F	Box Engine XC7P	GDS45005	Drive Shaft		30	30	75	120	690		
2.0 (57 kW)	1980.03-	1987.06	MT/AT	L/R	F	Box Engine XN1P	GDS45005	Drive Shaft		30	30	75	120	690		
	1980.03-	1987.06	MT/AT	L/R	F	Bus Engine XN1P	GDS45005	Drive Shaft		30	30	75	120	690		
	1980.03-	1987.06	MT/AT	L/R	F	Platform/Chassis Engine XN1P	GDS45005	Drive Shaft		30	30	75	120	690		
2.1 D (41 kW)	1980.03-	1987.06	MT/AT	L/R	F	Box Engine XDPX90	GDS45005	Drive Shaft		30	30	75	120	690		
2.5 D (53 kW)	1982.07-	1987.06	MT/AT	L/R	F	Box Engine XD3P	GDS45005	Drive Shaft		30	30	75	120	690		
	1982.07-	1987.06	MT/AT	L/R	F	Platform/Chassis Engine XD3P	GDS45005	Drive Shaft		30	30	75	120	690		
	1982.08-	1987.06	MT/AT	L/R	F	Bus Engine XD3P	GDS45005	Drive Shaft		30	30	75	120	690		
<b>J9 PREMIER</b>																
2.8 D	2007-	2010		L	F		GDS45188	Drive Shaft	72T	30	30	74.45	120.3	668		
	2007-	2010		L	F		GCI10081	Inner Joint		30	30	54.5	47.5	81.5		
	2007-	2010		L/R	F		GC010061	Outer Joint	72T	30	27	74.45	120.3	63	I	
	2007-	2010		L/R	F		GCI10027	Inner Joint		30	30	54.5	47.5	78.5		
	2007-	2010		L/R	F		GC010149	Outer Joint		30	27	74.45	120.3	63	I	
	2007-	2010		R	F		GDS45189	Drive Shaft	72T	30	30	74.45	120.3	718		
2007-	2010		R	F		GCI10037	Inner Joint		30	30	54.5	47.5	78.5			
<b>PARTNER</b>																
1.6 (66 kW)	2008.04-		MT	L	F	Box Engine NFR(TU5JP4B)	GDS45105	Drive Shaft		25	24	58	79	625		
	2008.04-		MT	R	F	Box Engine NFR(TU5JP4B)	GDS45104	Drive Shaft		25	24	58	79	925		
	2008.04-		MT	L	F	Box Engine NFR(TU5JP4B)	GDS99019	Drive Shaft	29T	25	24	55.7	79	620		
	2008.04-		MT	R	F	Box Engine NFR(TU5JP4B)	GDS10229	Drive Shaft		25	24	58.5	79	935		
	2008.04-					Box Engine NFR(TU5JP4B)	GC099366	Outer Joint		25	34	58.5	79	55	I	
1.6 (72 kW)	2010.11-			L	F	Box	GDS10255	Drive Shaft		25	24	58.5	79	616		
	2010.11-			R	F	Box	GDS10254	Drive Shaft		25	24	58.5	79	939		
	2010.11-		MT	L	F	Box	GDS99019	Drive Shaft	29T	25	24	55.7	79	620		
	2010.11-		MT	R	F	Box	GDS10229	Drive Shaft		25	24	58.5	79	935		
	2010.11-					Box	GC099366	Outer Joint		25	34	58.5	79	55	I	
1.6 (80 kW)	2008.04-		MT	L	F	Box Engine NFU(TU5JP4)	GDS45105	Drive Shaft		25	24	58	79	625		
	2008.04-		MT	R	F	Box Engine NFU(TU5JP4)	GDS45104	Drive Shaft		25	24	58	79	925		
	2008.04-		MT	L	F	Box Engine NFU(TU5JP4)	GDS99019	Drive Shaft	29T	25	24	55.7	79	620		
	2008.04-		MT	R	F	Box Engine NFU(TU5JP4)	GDS10229	Drive Shaft		25	24	58.5	79	935		
	2008.04-					Box Engine NFU(TU5JP4)	GC099366	Outer Joint		25	34	58.5	79	55	I	
1.6 (88 kW)	2010.04-		MT	L	F	Box	GDS99019	Drive Shaft	29T	25	24	55.7	79	620		
	2010.04-		MT	R	F	Box	GDS10229	Drive Shaft		25	24	58.5	79	935		
	2010.04-					Box	GC099366	Outer Joint		25	34	58.5	79	55	I	
1.6 HDi (55 kW)	2008.04-		MT	L	F	Box Engine 9HT(DV6BTED4)	GDS45105	Drive Shaft		25	24	58	79	625		
	2008.04-		MT	R	F	Box Engine 9HT(DV6BTED4)	GDS45104	Drive Shaft		25	24	58	79	925		
	2008.04-		MT	L	F	Box Engine 9HT(DV6BTED4)	GDS99019	Drive Shaft	29T	25	24	55.7	79	620		
	2008.04-		MT	R	F	Box Engine 9HT(DV6BTED4)	GDS10229	Drive Shaft		25	24	58.5	79	935		
	2008.04-					Box Engine 9HT(DV6BTED4)	GC099366	Outer Joint		25	34	58.5	79	55	I	
1.6 HDi (66 kW)	2008.04-		MT	L	F	Box Engine 9HX(DV6ATED4)	GDS45105	Drive Shaft		25	24	58	79	625		
	2008.04-		MT	R	F	Box Engine 9HX(DV6ATED4)	GDS45104	Drive Shaft		25	24	58	79	925		
	2008.04-		MT	L	F	Box Engine 9HX(DV6ATED4)	GDS99019	Drive Shaft	29T	25	24	55.7	79	620		
	2008.04-		MT	R	F	Box Engine 9HX(DV6ATED4)	GDS10229	Drive Shaft		25	24	58.5	79	935		
	2008.04-					Box Engine 9HX(DV6ATED4)	GC099366	Outer Joint		25	34	58.5	79	55	I	
1.6 HDi (68 kW)	2010.04-		MT	L	F	Box Engine 9HP(DV6DTED)	GDS99019	Drive Shaft	29T	25	24	55.7	79	620		
	2010.04-		MT	R	F	Box Engine 9HP(DV6DTED)	GDS10229	Drive Shaft		25	24	58.5	79	935		
	2010.04-		MT			Box Engine 9HP(DV6DTED)	GC099366	Outer Joint		25	34	58.5	79	55	I	
1.6 HDi (80 kW)	2008.04-		MT	L	F	Box Engine 9HZ(DV6TED4)	GDS45105	Drive Shaft		25	24	58	79	625		









		TRANSM	L/R	F/R		G-AP Ref.	PRODUCT	ABS	Technical Specifications						
									YEAR	A	B	C	H	L	P
<b>PEUGEOT PARTNER</b>															
1.6 HDi (80 kW)	2008.04-		MT	R	F	Box Engine 9HZ(DV6TED4)	GDS45104	Drive Shaft		25	24	58	79	925	
	2008.04-		MT	L	F	Box Engine 9HZ(DV6TED4)	GDS99019	Drive Shaft	29T	25	24	55.7	79	620	
	2008.04-		MT	R	F	Box Engine 9HZ(DV6TED4)	GDS10229	Drive Shaft		25	24	58.5	79	935	
	2008.04-					Box Engine 9HZ(DV6TED4)	GC099366	Outer Joint		25	34	58.5	79	55	I
1.6 HDi (82 kW)	2010.08-		MT	L	F	Box	GDS99019	Drive Shaft	29T	25	24	55.7	79	620	
	2010.08-		MT	R	F	Box	GDS10229	Drive Shaft		25	24	58.5	79	935	
	2010.08-					Box	GC099366	Outer Joint		25	34	58.5	79	55	I
1.6 HDi (84 kW)	2013.03-			L	F	Box Engine 9HL(DV6C)	GDS10255	Drive Shaft		25	24	58.5	79	616	
	2013.03-			R	F	Box Engine 9HL(DV6C)	GDS10254	Drive Shaft		25	24	58.5	79	939	
	2013.03-		MT	L	F	Box Engine 9HL(DV6C)	GDS99019	Drive Shaft	29T	25	24	55.7	79	620	
	2013.03-		MT	R	F	Box Engine 9HL(DV6C)	GDS10229	Drive Shaft		25	24	58.5	79	935	
1.8	1980.01-	1990.12	MT				GC010038	Outer Joint		25	25	60	79	61.5	O
1.8/1.9 Diesel				L			GDS10080	Drive Shaft	29W	25	24	55.7	79	597	
1.8/1.9 Diesel BE3							GC010049	Outer Joint		25	34	55.7	79	55	I
				R			GDS10078	Drive Shaft	29W	25	24	55.7	79	872	
<b>PARTNER (5)</b>															
2.0 HDi 4x4 (66 kW)	2004.04-			R	F	Box Engine RHY(DW10TD)	GDS99196	Drive Shaft	48W	25	24	58.5	79	869	
<b>PARTNER COMBISPACE (5F)</b>															
1.1 (44 kW)	1996.06-		MT	R	F	MPV Engine HDZ(TU1M)	GDS10015	Drive Shaft		25	22	56.7	79	868	
1.4 (55 kW)	1996.06-		MT	R	F	MPV Engine KFW(TU3JP)/KFX(TU3JP)/TU32	GDS10015	Drive Shaft		25	22	56.7	79	868	
1.6 16V (80 kW)	2001.07-				F	MPV Engine NFU(TU5JP4)	GC010076	Outer Joint	29W	25	34	58.5	79	55	I
	2001.07-		MT	L	F	MPV Engine NFU(TU5JP4)	GDS10025	Drive Shaft	29T	25	24	54.8	78.5	593	
	2001.07-		MT	R	F	MPV Engine NFU(TU5JP4)	GDS10167	Drive Shaft		25	24	55.7	79	868	
	2001.07-		MT	R	F	MPV Engine NFU(TU5JP4)	GDS10023	Drive Shaft	29T	25	24	55.7	79	868	
	2001.07-			L	F	MPV Engine NFU(TU5JP4)	GDS99195	Drive Shaft	48W	25	24	58.5	79	585	
	2001.07-			R	F	MPV Engine NFU(TU5JP4)	GDS99196	Drive Shaft	48W	25	24	58.5	79	869	
1.6 HDi (55 kW)	2006.02-				F	MPV Engine 9HW(DV6BTED4)	GC010067	Outer Joint	48W	25	34	58.5	79	55	I
	2006.02-			L	F	MPV Engine 9HW(DV6BTED4)	GDS99195	Drive Shaft	48W	25	24	58.5	79	585	
	2006.02-			R	F	MPV Engine 9HW(DV6BTED4)	GDS99196	Drive Shaft	48W	25	24	58.5	79	869	
	2006.02-					MPV Engine 9HW(DV6BTED4)	GC099293	Outer Joint	48W	25	34	58.5	79	55	I
1.6 HDi (66 kW)	2005.10-			L	F	MPV Engine 9HX(DV6ATED4)	GDS99195	Drive Shaft	48W	25	24	58.5	79	585	
	2005.10-			R	F	MPV Engine 9HX(DV6ATED4)	GDS99196	Drive Shaft	48W	25	24	58.5	79	869	
	2005.10-		MT			MPV Engine 9HX(DV6ATED4)	GC099293	Outer Joint	48W	25	34	58.5	79	55	I
	2005.10-				F	MPV Engine 9HX(DV6ATED4)	GC010067	Outer Joint	48W	25	34	58.5	79	55	I
1.8 (66 kW)	1997.05-				F	MPV Engine LFX(XU7JB)	GC010020	Outer Joint	29T	25	34	58	78.5	55	I
1.9 D (50 kW)	1996.06-				F	MPV Engine DJY(XUD9A)	GC010020	Outer Joint	29T	25	34	58	78.5	55	I
1.9 D (51 kW)	2001.06-	2005.10			F	MPV Engine WJY(DW8B)/WJZ(DW8)	GC010076	Outer Joint	29W	25	34	58.5	79	55	I
	2001.06-	2005.10	MT	L	F	MPV Engine WJY(DW8B)/WJZ(DW8)	GDS99025	Drive Shaft	29W	25	24	55.7	79	597	
	2001.06-	2005.10	MT	L	F	MPV Engine WJY(DW8B)/WJZ(DW8)	GDS10025	Drive Shaft	29T	25	24	54.8	78.5	593	
	2001.06-	2005.10	MT	R	F	MPV Engine WJY(DW8B)/WJZ(DW8)	GDS10167	Drive Shaft		25	24	55.7	79	868	
	2001.06-	2005.10	MT	R	F	MPV Engine WJY(DW8B)/WJZ(DW8)	GDS10023	Drive Shaft	29T	25	24	55.7	79	868	
	2001.06-	2005.10		R	F	MPV Engine WJY(DW8B)/WJZ(DW8)	GDS99196	Drive Shaft	48W	25	24	58.5	79	869	
	2001.06-	2005.10				MPV Engine WJY(DW8B)/WJZ(DW8)	GC099293	Outer Joint	48W	25	34	58.5	79	55	I
1.9 D 4x4 (51 kW)	2004.04-	2005.08		L	F	MPV Engine WJY(DW8B)	GDS99025	Drive Shaft	29W	25	24	55.7	79	597	
	2004.04-	2005.08		R	F	MPV Engine WJY(DW8B)	GDS99196	Drive Shaft	48W	25	24	58.5	79	869	
	2004.04-	2005.08	MT			MPV Engine WJY(DW8B)	GC099293	Outer Joint	48W	25	34	58.5	79	55	I
2.0 HDi (66 kW)	2000.02-			L	F	MPV Engine RHY(DW10TD)	GDS99195	Drive Shaft	48W	25	24	58.5	79	585	
	2000.02-			R	F	MPV Engine RHY(DW10TD)	GDS99196	Drive Shaft	48W	25	24	58.5	79	869	
	2000.02-		MT			MPV Engine RHY(DW10TD)	GC099293	Outer Joint	48W	25	34	58.5	79	55	I
2.0 HDi 4x4 (66 kW)	2004.04-	2005.08		L	F	MPV Engine RHY(DW10TD)	GDS99025	Drive Shaft	29W	25	24	55.7	79	597	
	2004.04-	2005.08		R	F	MPV Engine RHY(DW10TD)	GDS99196	Drive Shaft	48W	25	24	58.5	79	869	
	2004.04-	2005.08	MT			MPV Engine RHY(DW10TD)	GC099293	Outer Joint	48W	25	34	58.5	79	55	I
<b>PARTNER MPV</b>															
1.6 16V	2002.10-		MT	L			GDS10050	Drive Shaft		25	24	55.7	79	583	
1.9 D	2001.06-		MT	L			GDS10050	Drive Shaft		25	24	55.7	79	583	
<b>PARTNER TEPEE</b>															
1.6 (66 kW)	2008.04-		MT	L	F	MPV Engine NFR(TU5JP4B)	GDS10255	Drive Shaft		25	24	58.5	79	616	
	2008.04-		MT	R	F	MPV Engine NFR(TU5JP4B)	GDS10254	Drive Shaft		25	24	58.5	79	939	
	2008.04-		MT	L	F	MPV Engine NFR(TU5JP4B)	GDS99019	Drive Shaft	29T	25	24	55.7	79	620	
	2008.04-		MT	R	F	MPV Engine NFR(TU5JP4B)	GDS10229	Drive Shaft		25	24	58.5	79	935	
	2008.04-					MPV Engine NFR(TU5JP4B)	GC099366	Outer Joint		25	34	58.5	79	55	I



	 YEAR	TRANSM	L/R	F/R		G-AP Ref.	PRODUCT	ABS	Technical Specifications									
									A	B	C	H	L	P				
<b>PEUGEOT PARTNER TEPEE</b>																		
1.6 (72 kW)	2010.08-		MT	L	F	MPV Engine 5FK (EP6CB)	GDS99019	Drive Shaft	29T	25	24	55.7	79	620				
	2010.08-		MT	R	F	MPV Engine 5FK (EP6CB)	GDS10229	Drive Shaft		25	24	58.5	79	935				
	2010.08-					MPV Engine 5FK (EP6CB)	GC099366	Outer Joint		25	34	58.5	79	55	I			
1.6 (80 kW)	2008.04-		MT	L	F	MPV Engine NFU(TU5JP4)	GDS10255	Drive Shaft		25	24	58.5	79	616				
	2008.04-		MT	R	F	MPV Engine NFU(TU5JP4)	GDS10254	Drive Shaft		25	24	58.5	79	939				
	2008.04-		MT	L	F	MPV Engine NFU(TU5JP4)	GDS99019	Drive Shaft	29T	25	24	55.7	79	620				
	2008.04-		MT	R	F	MPV Engine NFU(TU5JP4)	GDS10229	Drive Shaft		25	24	58.5	79	935				
	2008.04-					MPV Engine NFU(TU5JP4)	GC099366	Outer Joint		25	34	58.5	79	55	I			
1.6 (81 kW)	2008.09-		MT	L	F	MPV Engine NFU(TU5JP4)	GDS99019	Drive Shaft	29T	25	24	55.7	79	620				
	2008.09-		MT	R	F	MPV Engine NFU(TU5JP4)	GDS10229	Drive Shaft		25	24	58.5	79	935				
1.6 (88 kW)	2010.04-		MT	L	F	MPV Engine 5FS(EP6C)	GDS99019	Drive Shaft	29T	25	24	55.7	79	620				
	2010.04-		MT	R	F	MPV Engine 5FS(EP6C)	GDS10229	Drive Shaft		25	24	58.5	79	935				
	2010.04-					MPV Engine 5FS(EP6C)	GC099366	Outer Joint		25	34	58.5	79	55	I			
1.6 HDi (55 kW)	2008.04-		MT	L	F	MPV Engine 9HT(DV6BTED4)	GDS10255	Drive Shaft		25	24	58.5	79	616				
	2008.04-		MT	R	F	MPV Engine 9HT(DV6BTED4)	GDS10254	Drive Shaft		25	24	58.5	79	939				
	2008.04-		MT	L	F	MPV Engine 9HT(DV6BTED4)	GDS99019	Drive Shaft	29T	25	24	55.7	79	620				
	2008.04-		MT	R	F	MPV Engine 9HT(DV6BTED4)	GDS10229	Drive Shaft		25	24	58.5	79	935				
	2008.04-					MPV Engine 9HT(DV6BTED4)	GC099366	Outer Joint		25	34	58.5	79	55	I			
1.6 HDi (66 kW)	2008.04-		MT	L	F	MPV Engine 9HX(DV6ATED4)/9HV(DV6TED4)	GDS10255	Drive Shaft		25	24	58.5	79	616				
	2008.04-		MT	R	F	MPV Engine 9HX(DV6ATED4)/9HV(DV6TED4)	GDS10254	Drive Shaft		25	24	58.5	79	939				
	2008.04-		MT	L	F	MPV Engine 9HX(DV6ATED4)/9HV(DV6TED4)	GDS99019	Drive Shaft	29T	25	24	55.7	79	620				
	2008.04-		MT	R	F	MPV Engine 9HX(DV6ATED4)/9HV(DV6TED4)	GDS10229	Drive Shaft		25	24	58.5	79	935				
	2008.04-					MPV Engine 9HX(DV6ATED4)/9HV(DV6TED4)	GC099366	Outer Joint		25	34	58.5	79	55	I			
1.6 HDi (68 kW)	2010.04-		MT	L	F	MPV Engine 9HP(DV6TED)	GDS99019	Drive Shaft	29T	25	24	55.7	79	620				
	2010.04-		MT	R	F	MPV Engine 9HP(DV6TED)	GDS10229	Drive Shaft		25	24	58.5	79	935				
	2010.04-		MT			MPV Engine 9HP(DV6TED)	GC099366	Outer Joint		25	34	58.5	79	55	I			
1.6 HDi (80 kW)	2008.04-		MT	L	F	MPV Engine 9HZ(DV6ATED4)	GDS10255	Drive Shaft		25	24	58.5	79	616				
	2008.04-		MT	R	F	MPV Engine 9HZ(DV6ATED4)	GDS10254	Drive Shaft		25	24	58.5	79	939				
	2008.04-		MT	L	F	MPV Engine 9HZ(DV6ATED4)	GDS99019	Drive Shaft	29T	25	24	55.7	79	620				
	2008.04-		MT	R	F	MPV Engine 9HZ(DV6ATED4)	GDS10229	Drive Shaft		25	24	58.5	79	935				
	2008.04-					MPV Engine 9HZ(DV6ATED4)	GC099366	Outer Joint		25	34	58.5	79	55	I			
1.6 HDi (82 kW)	2010.08-		MT	L	F	MPV Engine 9HL(DV6C)	GDS99019	Drive Shaft	29T	25	24	55.7	79	620				
	2010.08-		MT	R	F	MPV Engine 9HL(DV6C)	GDS10229	Drive Shaft		25	24	58.5	79	935				
	2010.08-					MPV Engine 9HL(DV6C)	GC099366	Outer Joint		25	34	58.5	79	55	I			
1.6 HDi (84 kW)	2013.03-		MT	L	F	MPV Engine 9HL(DV6C)	GDS99019	Drive Shaft	29T	25	24	55.7	79	620				
	2013.03-		MT	R	F	MPV Engine 9HL(DV6C)	GDS10229	Drive Shaft		25	24	58.5	79	935				
<b>PARTNER VAN (5)</b>																		
1.1 (44 kW)	1996.06-		MT	R	F	Box Engine HDZ(TU1M)	GDS10015	Drive Shaft		25	22	56.7	79	868				
1.4 (55 kW)	1996.06-		MT	R	F	Box Engine KFX(TU3JP)/TU32	GDS10015	Drive Shaft		25	22	56.7	79	868				
1.6 HDi (55 kW)	2006.02-				F	Box Engine 9HW(DV6BTED4)	GC010067	Outer Joint	48W	25	34	58.5	79	55	I			
	2006.02-			L	F	Box Engine 9HW(DV6BTED4)	GDS99195	Drive Shaft	48W	25	24	58.5	79	585				
	2006.02-			R	F	Box Engine 9HW(DV6BTED4)	GDS99196	Drive Shaft	48W	25	24	58.5	79	869				
	2006.02-		MT			Box Engine 9HW(DV6BTED4)	GC099293	Outer Joint	48W	25	34	58.5	79	55	I			
1.6 HDi (66 kW)	2006.02-				F	Box Engine 9HX(DV6ATED4)	GC010067	Outer Joint	48W	25	34	58.5	79	55	I			
	2006.02-			L	F	Box Engine 9HX(DV6ATED4)	GDS99195	Drive Shaft	48W	25	24	58.5	79	585				
	2006.02-			R	F	Box Engine 9HX(DV6ATED4)	GDS99196	Drive Shaft	48W	25	24	58.5	79	869				
	2006.02-		MT			Box Engine 9HX(DV6ATED4)	GC099293	Outer Joint	48W	25	34	58.5	79	55	I			
1.9 D (51 kW)	1996.06-				F	Box Engine DJY(XUD9A)	GC010020	Outer Joint	29T	25	34	58	78.5	55	I			
1.9 D 4x4 (51 kW)	2004.04-					Box Engine WJY(DW8B)	GC010076	Outer Joint	29W	25	34	58.5	79	55	I			
	2004.04-			L	F	Box Engine WJY(DW8B)	GDS99025	Drive Shaft	29W	25	24	55.7	79	597				
	2004.04-			R	F	Box Engine WJY(DW8B)	GDS99196	Drive Shaft	48W	25	24	58.5	79	869				
	2004.04-					Box Engine WJY(DW8B)	GC099293	Outer Joint	48W	25	34	58.5	79	55	I			
2.0 HDi (66 kW)	2000.04-			L	F	Box Engine RHY(DW10TD)	GDS99195	Drive Shaft	48W	25	24	58.5	79	585				
	2000.04-			R	F	Box Engine RHY(DW10TD)	GDS99196	Drive Shaft	48W	25	24	58.5	79	869				
	2000.04-					Box Engine RHY(DW10TD)	GC099293	Outer Joint	48W	25	34	58.5	79	55	I			
<b>RCZ</b>																		
1.6 16V (115 kW)	2010.03-		6MT			Coupe Engine EP6CDT	GC099366	Outer Joint		25	34	58.5	79	55	I			
1.6 16V (147 kW)	2010.06-		6MT			Coupe Engine EP6CDTX	GC099366	Outer Joint		25	34	58.5	79	55	I			
2.0 HDi (120 kW)	2010.03-		6MT			Coupe Engine RHH(DW10CTED4)	GC010155	Outer Joint		25	39	58.5	89	63.5	I			

		YEAR	TRANSM	L/R	F/R		G-AP Ref.	PRODUCT	ABS	Technical Specifications						
										A	B	C	H	L	P	
<b>PEUGEOT LCV</b>																
<b>BIPPER (AA)</b>																
1.3 HDi (55 kW)	2010-	2012.05					GC017028	Outer Joint			25	24	51	84.5	62	M
1.4 (54 kW)	2008.02-			L			GC017070	Outer Joint			22	22	51	79	57.5	M
<b>BOXER</b>																
2.2 HDi (110 kW)	2011-						GC017060	Outer Joint			35	29	71.5	127	71	I
	2011.03-			R			GCI17021	Inner Joint			31	29	34.85	530	109	
2.2 HDi (74 kW)	2006.04-			L			GCI17042	Inner Joint			41	27	43	70	102	
	2006.04-			R			GCI10038	Inner Joint			41	27	34.85	403	102	
	2006.04-						GC017055	Outer Joint			35	27	71.5	127	66.5	I
2.2 HDi (88 kW)	2006.04-			L			GCI17028	Inner Joint			41	29	43	69.5	109.5	
	2006.04-						GC017055	Outer Joint			35	27	71.5	127	66.5	I
	2006.04-						GC017054	Outer Joint			35	29	71.5	127	71	M
2.2 HDi (96 kW)	2006.04-						GC017055	Outer Joint			35	27	71.5	127	66.5	I
	2006.04-						GC017054	Outer Joint			35	29	71.5	127	71	M
	2011.03-			L			GCI17028	Inner Joint			41	29	43	69.5	109.5	
3.0 HDi (107 kW)	2010.04-			R			GCI17021	Inner Joint			31	29	34.85	530	109	
3.0 HDi (116 kW)	2006.04-			R			GCI17021	Inner Joint			31	29	34.85	530	109	
	2006.04-						GC017060	Outer Joint			35	29	71.5	127	71	I
	2006.04-						GC017061	Outer Joint	54T		35	29	71.5	127	71	I
3.0 HDi (130 kW)	2011.03-			R			GCI17021	Inner Joint			31	29	34.85	530	109	
<b>PIAGGIO</b>																
<b>PORTER</b>																
1.3 i 16V 4x4 (48 kW)	1998.05-					Platform/Chassis	GC075007	Outer Joint			24	20	44	125.5	53	O
	1998.05-					Box	GC075007	Outer Joint			24	20	44	125.5	53	O
<b>PLYMOUTH</b>																
<b>ACCLAIM</b>																
-	1989-	1990				Saginaw	GC089010	Outer Joint			26	29	54	99.5	62.5	O
	1989-	1995					GC089008	Outer Joint			26	28	54	98	58	I
	1991-						GCI89026	Inner Joint			25	32	40	71	124	
<b>COLT VISTA</b>																
2.4	1992-	1994	AT				GC039041	Outer Joint			25	25	54	95.5	65	M
<b>NEON</b>																
-	1995-	1999	AT				GCI15003	Inner Joint			25	28	28	172.5	103	
	2000-						GC089033	Outer Joint	46T		26	22	57.7	92.5	58	M
<b>RELIANT</b>																
-	1986-	1989				SAGINAW	GC089010	Outer Joint			26	29	54	99.5	62.5	O
<b>SUNDANCE</b>																
-	1987-	1992				Saginaw	GC089010	Outer Joint			26	29	54	99.5	62.5	O
<b>VOYAGER</b>																
-	1991-	1995					GCI89026	Inner Joint			25	32	40	71	124	
	1996-	2000				SUV/Truck/VAN	GCI89021	Inner Joint			25	32	28	173	107	
<b>VOYAGER / GRAND VOYAGER</b>																
3.3 Flex-Fuel (116 kW)	1998.01-	2001.03	MT	L	F	MPV Engine EGM	GDS51021	Drive Shaft	43T		26	23	49	78.8	632	
<b>VOYAGER VAN</b>																
-	1996-	1997		L		Truck 2WD	GDS89004	Drive Shaft	47T		26	25	54	98.5	638	
	1996-	1997		L		Truck 4WD	GDS89004	Drive Shaft	47T		26	25	54	98.5	638	
<b>PLYMOUTH TRUCK</b>																
<b>VOYAGER VAN</b>																
-	1996-	1997		R		Truck 2WD	GDS89005	Drive Shaft	47T		26	25	54	98.5	1030	
	1996-	1997					GCI89011	Inner Joint			25	32	40	71.5	107	
<b>PONTIAC</b>																
<b>GRAND PRIX</b>																
-	1988-	1996				Excl. A/T, 3 Speed.	GC086002	Outer Joint			33	32	73	88	55	O
	1988-	1993	AT			3 Speed	GC088024	Outer Joint			33	29	73	88	54.5	O
	1988-	1996				Excl. A/T, 3 Speed.	GC086011	Outer Joint	47T		33	32	73	88	55	O
<b>SUNBIRD (J-BODY)</b>																
-	1982-						GC086001	Outer Joint			33	29	47.6	108	63	O
	1992-	1995				LD Driveline&Brakes	GC021018	Outer Joint	48T		33	29	47.6	108	63	O









		TRANSM	L/R	F/R		G-AP Ref.	PRODUCT	ABS	Technical Specifications					
									YEAR	A	B	C	H	L
<b>PORSCHE</b>														
<b>911</b>														
3.0 SC (150 kW)	1980.08-	1983.07	MT	L/R	R	Coupe Engine 930.10	GDS48003	Drive Shaft				32.2	494	
	1980.08-	1983.07	MT		R	Coupe Engine 930.10	GCI48004	Inner Joint		25		32		
	1982.08-	1983.07	MT		R	Convertible Engine 930.10	GCI48001	Inner Joint		28		40		
3.1 Carrera Speedster (160 kW)	1986.08-	1989.08	MT	L/R	R	Convertible Engine 930.25	GDS48001	Drive Shaft	28		53	98	601	
3.1 Carrera Speedster (170 kW)	1986.08-	1989.08	MT	L/R	R	Convertible Engine 930.20	GDS48001	Drive Shaft	28		53	98	601	
3.1 SC Carrera (152 kW)	1984.10-	1989.08	MT	L/R	R	Convertible Engine 930.21	GDS48001	Drive Shaft	28		53	98	601	
3.1 SC Carrera (170 kW)	1983.08-	1984.08	MT	L/R	R	Convertible Engine 930.20	GDS48001	Drive Shaft	28		53	98	601	
3.2 (160 kW)	1986.08-	1989.08	MT	L/R	R	Coupe Engine 930.25	GDS48001	Drive Shaft	28		53	98	601	
3.2 SC Carrera (152 kW)	1984.02-	1987.06	MT	L/R	R	Coupe Engine 930.21	GDS48001	Drive Shaft	28		53	98	601	
3.2 SC Carrera (170 kW)	1983.08-	1989.08	MT	L/R	R	Coupe Engine 930.20/930.26	GDS48001	Drive Shaft	28		53	98	601	
3.3 SC Turbo (221 kW)	1977.09-	1987.06	MT		R	Coupe Engine 930.60/930.66	GCI48001	Inner Joint		28		40		
<b>944</b>														
2.5 Turbo (162 kW)	1985.08-	1988.07	MT		R	Coupe Engine M44.50/M44.51	GCI48004	Inner Joint		25		32		
2.5 Turbo (184 kW)	1987.09-	1991.07	MT		R	Coupe Engine M44.52	GCI48004	Inner Joint		25		32		
<b>BOXSTER (986)</b>														
S 3.2 (185 kW)	1999.08-	2002.07	MT	L/R	R	Convertible Engine M96.21	GDS48002	Drive Shaft	48W	28		61	94	680
<b>BOXSTER (987)</b>														
2.7 (176 kW)	2004.11-			L	F	Convertible Engine M96.25	GDS99069	Drive Shaft	29T	22	22	52	97.5	584
	2004.11-			L/R	F	Convertible Engine M96.25	GCI44043	Outer Joint		22	28	52	97.5	57.5 O
<b>CAYENNE (955)</b>														
3.0 TDi (176 kW)	2009.02-		AT	L/R	F	Closed Off-Road Vehicle Engine M05.9D	GDS99213	Drive Shaft		30		64	103.5	523
	2009.02-		MT/AT	L/R	R	Closed Off-Road Vehicle Engine M05.9D	GDS35086	Drive Shaft		30		64.3	103.5	724
	2009.02-		MT/AT	L/R	R	Closed Off-Road Vehicle Engine M05.9D	GDS61236	Drive Shaft		30		64	103.5	734
	2009.02-		MT/AT	L/R	R	Closed Off-Road Vehicle Engine M05.9D	GCI61064	Inner Joint		30	28	64	103.5	64
	2009.02-		MT/AT	L/R	R	Closed Off-Road Vehicle Engine M05.9D	GCI61066	Inner Joint			28		28	
3.2 (184 kW)	2003.08-			L/R	F	Closed Off-Road Vehicle Engine M02.2Y	GDS99213	Drive Shaft		30		64	103.5	523
	2003.08-			L/R	R	Closed Off-Road Vehicle Engine M02.2Y	GDS35086	Drive Shaft		30		64.3	103.5	724
	2003.08-			L/R	R	Closed Off-Road Vehicle Engine M02.2Y	GDS61236	Drive Shaft		30		64	103.5	734
	2003.08-			L/R	R	Closed Off-Road Vehicle Engine M02.2Y	GCI61064	Inner Joint		30	28	64	103.5	64
	2003.08-			L/R	R	Closed Off-Road Vehicle Engine M02.2Y	GCI61066	Inner Joint			28		28	
3.6 (213 kW)	2006.12-			L/R	F	Closed Off-Road Vehicle Engine M55.01	GDS99213	Drive Shaft		30		64	103.5	523
	2006.12-			L/R	R	Closed Off-Road Vehicle Engine M55.01	GDS35086	Drive Shaft		30		64.3	103.5	724
	2006.12-			L/R	R	Closed Off-Road Vehicle Engine M55.01	GDS61236	Drive Shaft		30		64	103.5	734
	2006.12-			L/R	R	Closed Off-Road Vehicle Engine M55.01	GCI61064	Inner Joint		30	28	64	103.5	64
	2006.12-			L/R	R	Closed Off-Road Vehicle Engine M55.01	GCI61066	Inner Joint			28		28	
4.5 Turbo (331 kW)	2002.09-			L/R	F	Closed Off-Road Vehicle Engine M48.50	GDS99213	Drive Shaft		30		64	103.5	523
	2002.09-			L/R	R	Closed Off-Road Vehicle Engine M48.50	GDS61236	Drive Shaft		30		64	103.5	734
	2002.09-			L/R	R	Closed Off-Road Vehicle Engine M48.50	GCI61064	Inner Joint		30	28	64	103.5	64
	2002.09-			L/R	R	Closed Off-Road Vehicle Engine M48.50	GCI61066	Inner Joint			28		28	
4.5 Turbo S (368 kW)	2004.01-		AT	L/R	F	Closed Off-Road Vehicle Engine M48.50S	GDS99213	Drive Shaft		30		64	103.5	523
	2004.01-		AT	L/R	R	Closed Off-Road Vehicle Engine M48.50S	GDS35086	Drive Shaft		30		64.3	103.5	724
	2004.01-			L/R	R	Closed Off-Road Vehicle Engine M48.50S	GDS61236	Drive Shaft		30		64	103.5	734
	2004.01-			L/R	R	Closed Off-Road Vehicle Engine M48.50S	GCI61064	Inner Joint		30	28	64	103.5	64
	2004.01-			L/R	R	Closed Off-Road Vehicle Engine M48.50S	GCI61066	Inner Joint			28		28	
4.5 Turbo S (383 kW)	2006.02-		AT	L/R	F	Closed Off-Road Vehicle	GDS99213	Drive Shaft		30		64	103.5	523
	2006.02-		AT	L/R	R	Closed Off-Road Vehicle	GDS35086	Drive Shaft		30		64.3	103.5	724
	2006.02-			L/R	R	Closed Off-Road Vehicle	GDS61236	Drive Shaft		30		64	103.5	734
	2006.02-			L/R	R	Closed Off-Road Vehicle	GCI61064	Inner Joint		30	28	64	103.5	64
	2006.02-			L/R	R	Closed Off-Road Vehicle	GCI61066	Inner Joint			28		28	
4.8 GTS (298 kW)	2007.12-			L/R	F	Closed Off-Road Vehicle Engine M48.01	GDS99213	Drive Shaft		30		64	103.5	523
	2007.12-				F	Closed Off-Road Vehicle Engine M48.01	GDS99213	Drive Shaft		30		64	103.5	523
	2007.12-		MT	L/R	R	Closed Off-Road Vehicle Engine M48.01	GDS35086	Drive Shaft		30		64.3	103.5	724
	2007.12-			L/R	R	Closed Off-Road Vehicle Engine M48.01	GDS61236	Drive Shaft		30		64	103.5	734
	2007.12-			L/R	R	Closed Off-Road Vehicle Engine M48.01	GCI61064	Inner Joint		30	28	64	103.5	64
	2007.12-			L/R	R	Closed Off-Road Vehicle Engine M48.01	GCI61066	Inner Joint			28		28	
4.8 Turbo S (368 kW)	2006.12-			L/R	F	Closed Off-Road Vehicle Engine M48.51	GDS99213	Drive Shaft		30		64	103.5	523
	2006.12-				F	Closed Off-Road Vehicle Engine M48.51	GDS99213	Drive Shaft		30		64	103.5	523
	2006.12-			L/R	R	Closed Off-Road Vehicle Engine M48.51	GDS35086	Drive Shaft		30		64.3	103.5	724
	2006.12-			L/R	R	Closed Off-Road Vehicle Engine M48.51	GDS61236	Drive Shaft		30		64	103.5	734
	2006.12-			L/R	R	Closed Off-Road Vehicle Engine M48.51	GCI61064	Inner Joint		30	28	64	103.5	64
	2006.12-			L/R	R	Closed Off-Road Vehicle Engine M48.51	GCI61066	Inner Joint			28		28	

		YEAR	TRANSM	L/R	F/R		G-AP Ref.	PRODUCT	ABS	Technical Specifications						
										A	B	C	H	L	P	
<b>PORSCHE</b>																
<b>CAYENNE (955)</b>																
4.8 Turbo S (397 kW)	2007.02-			L/R	F	Closed Off-Road Vehicle	GDS99213	Drive Shaft	30		64	103.5	523			
	2007.02-			L/R	R	Closed Off-Road Vehicle	GDS35086	Drive Shaft	30		64.3	103.5	724			
4.8 Turbo S (404 kW)	2008.08-		AT	L/R	F	Closed Off-Road Vehicle	GDS99213	Drive Shaft	30		64	103.5	523			
	2008.08-		MT/AT	L/R	R	Closed Off-Road Vehicle	GDS35086	Drive Shaft	30		64.3	103.5	724			
	2008.08-		MT/AT	L/R	R	Closed Off-Road Vehicle	GDS61236	Drive Shaft	30		64	103.5	734			
	2008.08-		MT/AT	L/R	R	Closed Off-Road Vehicle	GCI61064	Inner Joint	30	28	64	103.5	64			
	2008.08-		MT/AT	L/R	R	Closed Off-Road Vehicle	GCI61066	Inner Joint		28		28				
S 4.5 (250 kW)	2002.09-		MT/AT	L/R	F	Closed Off-Road Vehicle Engine M48.00	GDS99213	Drive Shaft	30		64	103.5	523			
	2002.09-		AT	L/R	R	Closed Off-Road Vehicle Engine M48.00	GDS61236	Drive Shaft	30		64	103.5	734			
	2002.09-		AT	L/R	R	Closed Off-Road Vehicle Engine M48.00	GCI61064	Inner Joint	30	28	64	103.5	64			
	2002.09-		AT	L/R	R	Closed Off-Road Vehicle Engine M48.00	GCI61066	Inner Joint		28		28				
	2002.09-		MT	L/R	R	Closed Off-Road Vehicle Engine M48.00	GDS35086	Drive Shaft	30		64.3	103.5	724			
S 4.8 (283 kW)	2006.12-			L/R	F	Closed Off-Road Vehicle Engine M48.01	GDS99213	Drive Shaft	30		64	103.5	523			
	2006.12-		MT	L/R	R	Closed Off-Road Vehicle Engine M48.01	GDS35086	Drive Shaft	30		64.3	103.5	724			
	2006.12-			L/R	R	Closed Off-Road Vehicle Engine M48.01	GDS61236	Drive Shaft	30		64	103.5	734			
	2006.12-			L/R	R	Closed Off-Road Vehicle Engine M48.01	GCI61064	Inner Joint	30	28	64	103.5	64			
	2006.12-			L/R	R	Closed Off-Road Vehicle Engine M48.01	GCI61066	Inner Joint		28		28				
<b>PROTON</b>																
<b>PERSONA (CM3)</b>																
1.3	2007.01-		MT/AT				GC039234	Outer Joint	25	22	54	96	51.2	M		
<b>PERSONA (CM6)</b>																
1.6	2007.01-		MT/AT				GC039234	Outer Joint	25	22	54	96	51.2	M		
<b>PREDANA</b>																
All Models	1992.01-						GC039020	Outer Joint	43T	25	24	54	94.5	62	M	
<b>PROTON</b>																
1.3 12V MPI	1991.01-	1996.08			F		GC039085	Outer Joint	25	22	54	96	60	M		
1.5 12V MPI	1991.01-	1996.08			F		GC039085	Outer Joint	25	22	54	96	60	M		
<b>SAGA</b>																
-				L/R			GDS24001	Drive Shaft	25	25	50	95	581.2			
	NULL-			L/R			GCI39001	Inner Joint	25	22	35	55	91			
1.3				L			GDS49006	Drive Shaft	25	24	54	94.5	605			
				R			GDS49005	Drive Shaft	25	24	54	94.5	927			
<b>SAGA (BT3)</b>																
1.3	2008.08-		4AT			Engine S4P13	GC039234	Outer Joint	25	22	54	96	51.2	M		
	2008.08-		5MT			Engine S4P13	GC039234	Outer Joint	25	22	54	96	51.2	M		
<b>SATRIA (C9_M)</b>																
1.3 (55 kW)	1996.03-				F	Hatchback Engine G13B	GC039023	Outer Joint	25	22	54	95	60	I		
1.5 (64 kW)	1996.09-				F	Hatchback Engine G15B	GC039023	Outer Joint	25	22	54	95	60	I		
1.5 (66 kW)	1996.03-				F	Hatchback Engine 4G15M	GC039023	Outer Joint	25	22	54	95	60	I		
1.6 (83 kW)	1996.03-				F	Hatchback Engine 4G92	GC039023	Outer Joint	25	22	54	95	60	I		
1.6 Sprint (70 kW)	1996.03-				F	Hatchback Engine 4G92	GC039023	Outer Joint	25	22	54	95	60	I		
<b>WIRA</b>																
1.3 (55 kW)	2000.08-				F	Hatchback Engine 4G13	GC039040	Outer Joint	25	30	54	95	61	M		
	2000.08-				F	Saloon Engine 4G13	GC039040	Outer Joint	25	30	54	95	61	M		
1.5 (64 kW)	2000.08-				F	Hatchback Engine 4G15M	GC039040	Outer Joint	25	30	54	95	61	M		
	2000.08-				F	Saloon Engine 4G15	GC039040	Outer Joint	25	30	54	95	61	M		
<b>WIRA (C9_C, C9_S)</b>																
1.3 GLSi (55 kW)	1994.01-				F	Hatchback Engine 4G13	GC039023	Outer Joint	25	22	54	95	60	I		
1.5 GLi/GLSi (66 kW)	1994.01-				F	Hatchback Engine 4G15	GC039040	Outer Joint	25	30	54	95	61	M		
	1994.01-				F	Hatchback Engine 4G15	GC039023	Outer Joint	25	22	54	95	60	I		
1.6 GLXi (83 kW)	1994.01-				F	Hatchback Engine 4G92	GC039040	Outer Joint	25	30	54	95	61	M		
<b>WIRA (C9_S)</b>																
1.3 (55 kW)	1994.01-				F	Saloon	GC039023	Outer Joint	25	22	54	95	60	I		
1.5 GLi/GLSi (66 kW)	1994.01-				F	Saloon Engine 4G15	GC039040	Outer Joint	25	30	54	95	61	M		
	1994.01-				F	Saloon Engine 4G15	GC039023	Outer Joint	25	22	54	95	60	I		
1.6 GLXi (83 kW)	1994.01-				F	Saloon Engine 4G92	GC039040	Outer Joint	25	30	54	95	61	M		
<b>RENAULT</b>																
<b>11 (B/C37_)</b>																
1.1 (35 kW)	1983.03-	1986.06	MT	R	F	Hatchback Engine C1E715/C1E720	GDS50012	Drive Shaft	21	23	46.4	81.5	726			
	1983.03-	1986.06	MT	L	F	Hatchback Engine C1E715/C1E720	GDS50013	Drive Shaft	21	29.95	46.4	81.5	633.5			



		YEAR	TRANSM	L/R	F/R		G-AP Ref.	PRODUCT	ABS	Technical Specifications						
										A	B	C	H	L	P	
<b>RENAULT</b>																
<b>11 (B/C37_)</b>																
1.2 (40 kW)	1984.10-	1988.12	MT	R	F	Hatchback Engine C1G700/C1G710	GDS50012	Drive Shaft		21	23	46.4	81.5	726		
	1984.10-	1988.12	MT	L	F	Hatchback Engine C1G700/C1G710	GDS50013	Drive Shaft		21	29.95	46.4	81.5	633.5		
	1984.10-	1988.12		L	F	Hatchback Engine C1G700/C1G710	GDS50041	Drive Shaft		21	29.95	46.2	82	639		
1.4 (44 kW)	1983.03-	1988.12	MT	R	F	Hatchback Engine C1J715/C2J730	GDS50012	Drive Shaft		21	23	46.4	81.5	726		
	1983.03-	1988.12	MT	L	F	Hatchback Engine C1J715/C2J730	GDS50013	Drive Shaft		21	29.95	46.4	81.5	633.5		
1.4 (49 kW)	1983.03-	1988.12	MT	R	F	Hatchback Engine C2J720/C2J766/C2J767/C2J768	GDS50012	Drive Shaft		21	23	46.4	81.5	726		
	1983.03-	1988.12	MT	L	F	Hatchback Engine C2J720/C2J766/C2J767/C2J768	GDS50013	Drive Shaft		21	29.95	46.4	81.5	633.5		
1.4 (50 kW)	1983.03-	1985.12	MT	R	F	Hatchback Engine C2J718/C2J757	GDS50012	Drive Shaft		21	23	46.4	81.5	726		
	1983.03-	1985.12	MT	L	F	Hatchback Engine C2J718/C2J757	GDS50013	Drive Shaft		21	29.95	46.4	81.5	633.5		
1.4 (53 kW)	1983.05-	1985.12	MT	R	F	Hatchback Engine C2J717/C2J755	GDS50012	Drive Shaft		21	23	46.4	81.5	726		
	1983.05-	1985.12	MT	L	F	Hatchback Engine C2J717/C2J755	GDS50013	Drive Shaft		21	29.95	46.4	81.5	633.5		
1.6 D (40 kW)	1983.08-	1988.12	MT&3AT	R	F	Hatchback Engine F8M700/F8M720/F8M730	GDS50012	Drive Shaft		21	23	46.4	81.5	726		
	1983.08-	1988.12	MT	L	F	Hatchback Engine F8M700/F8M720/F8M730	GDS50013	Drive Shaft		21	29.95	46.4	81.5	633.5		
1.7 (54 kW)	1986.10-	1988.12	MT	L	F	Hatchback Engine F2N730	GDS50013	Drive Shaft		21	29.95	46.4	81.5	633.5		
1.7 (55 kW)	1984.10-	1988.12	MT	L	F	Hatchback Engine F3N718	GDS50013	Drive Shaft		21	29.95	46.4	81.5	633.5		
1.7 (59 kW)	1983.10-	1987.12	MT	L	F	Hatchback Engine F2N700/F2N704	GDS50013	Drive Shaft		21	29.95	46.4	81.5	633.5		
1.7 (64 kW)	1987.06-	1988.12	MT	L	F	Hatchback Engine F2N732/F2N742	GDS50013	Drive Shaft		21	29.95	46.4	81.5	633.5		
1.7 (65 kW)	1986.10-	1988.12	MT	L	F	Hatchback Engine F2N708/F2N710/F2N798	GDS50013	Drive Shaft		21	29.95	46.4	81.5	633.5		
<b>12</b>																
-	1980.01-	1987.07	MT				GC050081	Outer Joint		20	30	48	107	57.5	O	
	1988.01-	1988.12	MT				GC050110	Outer Joint		20	30	48	107	57.5	I	
1.3 (37 kW)	1975.07-	1980.04	MT/AT			Saloon Engine 810-02	GC050081	Outer Joint		20	30	48	107	57.5	O	
1.3 (40 kW)	1969.10-	1980.08	MT/AT			Saloon Engine 810-02/97	GC050081	Outer Joint		20	30	48	107	57.5	O	
1.3 TS (44 kW)	1972.08-	1980.08	MT/AT			Saloon Engine 810-05/810-06	GC050081	Outer Joint		20	30	48	107	57.5	O	
<b>15 (130_)</b>																
1.3 (44 kW)	1972.03-	1980.10	MT			Hatchback Engine 810.05	GC050081	Outer Joint		20	30	48	107	57.5	O	
1.6 (66 kW)	1972.03-	1980.10	MT			Hatchback Engine 807.10	GC050081	Outer Joint		20	30	48	107	57.5	O	
<b>17</b>																
1.6 (66 kW)	1972.03-	1980.10	MT			Coupe Engine 807.10	GC050081	Outer Joint		20	30	48	107	57.5	O	
1.6 GorDini (79 kW)	1974.03-	1980.10	MT			Coupe Engine 844.12	GC050081	Outer Joint		20	30	48	107	57.5	O	
<b>18</b>																
1.4/1.6						Motor	GC050016	Outer Joint		23	30	56.3	80.5	58	O	
1.4/1.6/2.1	1982.08-	1984		L/R			GDS50145	Drive Shaft		23	23	56.3	80	685		
<b>18 (134_)</b>																
1.4 (47 kW)	1978.04-	1986.07	MT	L/R	F	Saloon Engine 847720/847722	GDS50016	Drive Shaft		20	23	48	107	673		
1.6 (54 kW)	1982.04-	1986.07	MT/AT	L/R	F	Saloon Engine 841717/A2M723	GDS50016	Drive Shaft		20	23	48	107	673		
1.6 (58 kW)	1978.04-	1982.09	MT/AT	L/R	F	Saloon Engine 841725/841726	GDS50016	Drive Shaft		20	23	48	107	673		
1.6 Turbo (80 kW)	1980.10-	1982.09			F	Saloon Engine 807727	GC050007	Outer Joint		23	25	56.3	80.5	56	O	
2.0 (77 kW)	1982.05-	1986.07			F	Saloon Engine J6R716	GC050007	Outer Joint		23	25	56.3	80.5	56	O	
2.1 Diesel (49 kW)	1981.11-	1986.07	MT	L/R	F	Saloon Engine 852710/J8S711	GDS50016	Drive Shaft		20	23	48	107	673		
2.1 Diesel (53 kW)	1981.11-	1986.07	MT	L/R	F	Saloon Engine J8S711	GDS50016	Drive Shaft		20	23	48	107	673		
<b>18 GTL</b>																
-							GDS99132	Drive Shaft		20	23	48	107	666.5		
	NULL-						GCI50059	Inner Joint		23	22	36.3	41	64.5		
<b>18 GTX</b>																
-							GDS50165	Drive Shaft		23	23	56.3	80.5	687		
<b>18 VARIABLE (135_)</b>																
1.4 (47 kW)	1979.05-	1986.07	MT	L/R	F	Estate Engine 847720/847722	GDS50016	Drive Shaft		20	23	48	107	673		
1.6 (54 kW)	1982.01-	1986.07	MT/AT	L/R	F	Estate Engine 841717/A2M723	GDS50016	Drive Shaft		20	23	48	107	673		
1.6 (58 kW)	1979.05-	1982.09	MT/AT	L/R	F	Estate Engine 841725/841726	GDS50016	Drive Shaft		20	23	48	107	673		
2.0 (77 kW)	1981.10-	1986.07			F	Estate Engine J6R716	GC050007	Outer Joint		23	25	56.3	80.5	56	O	
2.1 Diesel (49 kW)	1980.11-	1986.07	MT	L/R	F	Estate Engine 852710/J8S711	GDS50016	Drive Shaft		20	23	48	107	673		
<b>19</b>																
1.6							GC099070	Outer Joint		21	25	46.3	79	58	O	
<b>19 (B/C53_)</b>																
1.4 (43 kW)	1989.01-	1989.12	MT	L	F	Hatchback Engine C2J772	GDS50036	Drive Shaft		21	29.95	46.4	81.5	652		
	1989.01-	1989.12	MT	R	F	Hatchback Engine C2J772	GDS50037	Drive Shaft		21	23	46.2	82	718		
	1989.01-	1989.12	MT	L	F	Hatchback Engine C2J772	GDS50001	Drive Shaft		21	29.95	49.8	83.5	639.5		
	1989.01-	1989.12	MT&3AT	R	F	Hatchback Engine C2J772	GDS50002	Drive Shaft		21	23	49.8	83.5	734		
1.4 (59 kW)	1988.01-	1992.12	MT	L	F	Hatchback Engine E6J700/E6J701	GDS50036	Drive Shaft		21	29.95	46.4	81.5	652		
	1988.01-	1992.12	MT	R	F	Hatchback Engine E6J700/E6J701	GDS50037	Drive Shaft		21	23	46.2	82	718		





		TRANSM	L/R	F/R		G-AP Ref.	PRODUCT	ABS	Technical Specifications								
									YEAR	A	B	C	H	L	P		
<b>RENAULT</b>																	
<b>19 (B/C53_)</b>																	
1.4 (59 kW)	1988.01-	1992.12	MT	L	F	Hatchback Engine E6J700/E6J701	GDS50001	Drive Shaft	21	29.95	49.8	83.5	639.5				
	1988.01-	1992.12	MT&3AT	R	F	Hatchback Engine E6J700/E6J701	GDS50002	Drive Shaft	21	23	49.8	83.5	734				
1.4 CAT (43 kW)	1989.01-	1992.04	MT	L	F	Hatchback Engine C3J710	GDS50036	Drive Shaft	21	29.95	46.4	81.5	652				
	1989.01-	1992.04	MT	R	F	Hatchback Engine C3J710	GDS50037	Drive Shaft	21	23	46.2	82	718				
	1989.01-	1992.04	MT	L	F	Hatchback Engine C3J710	GDS50001	Drive Shaft	21	29.95	49.8	83.5	639.5				
	1989.01-	1992.04	MT&3AT	R	F	Hatchback Engine C3J710	GDS50002	Drive Shaft	21	23	49.8	83.5	734				
	1989.01-	1992.04	MT&3AT	R	F	Hatchback Engine C3J710	GDS50002	Drive Shaft	21	23	49.8	83.5	734				
1.7 (54 kW)	1988.09-	1992.04	MT	L	F	Hatchback Engine F3N740/F3N741	GDS50036	Drive Shaft	21	29.95	46.4	81.5	652				
	1988.09-	1992.04	MT	R	F	Hatchback Engine F3N740/F3N741	GDS50037	Drive Shaft	21	23	46.2	82	718				
	1988.09-	1992.04	MT	L	F	Hatchback Engine F3N740/F3N741	GDS50001	Drive Shaft	21	29.95	49.8	83.5	639.5				
	1988.09-	1992.04	MT&3AT	R	F	Hatchback Engine F3N740/F3N741	GDS50002	Drive Shaft	21	23	49.8	83.5	734				
1.7 (66 kW)	1988.09-	1992.04	MT	L	F	Hatchback Engine F3N742/F3N743	GDS50036	Drive Shaft	21	29.95	46.4	81.5	652				
	1988.09-	1992.04	MT	R	F	Hatchback Engine F3N742/F3N743	GDS50037	Drive Shaft	21	23	46.2	82	718				
	1988.09-	1992.04	MT	L	F	Hatchback Engine F3N742/F3N743	GDS50001	Drive Shaft	21	29.95	49.8	83.5	639.5				
	1988.09-	1992.04	MT&3AT	R	F	Hatchback Engine F3N742/F3N743	GDS50002	Drive Shaft	21	23	49.8	83.5	734				
1.8 16V (99 kW)	1989.06-	1992.04	MT/AT		F	Hatchback Engine F7P704	GC050008	Outer Joint	21	25	56.2	83.5	58				O
1.9 D (47 kW)	1988.09-	1992.04	MT	L	F	Hatchback Engine F8Q706/F8Q742	GDS50001	Drive Shaft	21	29.95	49.8	83.5	639.5				
	1988.09-	1992.04	MT	R	F	Hatchback Engine F8Q706/F8Q742	GDS50002	Drive Shaft	21	23	49.8	83.5	734				
<b>19 (D53_)</b>																	
1.7 (55 kW)	1991.07-	1992.04	MT	L	F	Convertible Engine F2N724	GDS50036	Drive Shaft	21	29.95	46.4	81.5	652				
	1991.07-	1992.04	MT	R	F	Convertible Engine F2N724	GDS50037	Drive Shaft	21	23	46.2	82	718				
	1991.07-	1992.04	MT	L	F	Convertible Engine F2N724	GDS50001	Drive Shaft	21	29.95	49.8	83.5	639.5				
	1991.07-	1992.04	MT&3AT	R	F	Convertible Engine F2N724	GDS50002	Drive Shaft	21	23	49.8	83.5	734				
1.7 (70 kW)	1991.07-	1992.04	MT	L	F	Convertible Engine F3N742/F3N743	GDS50036	Drive Shaft	21	29.95	46.4	81.5	652				
	1991.07-	1992.04	MT	R	F	Convertible Engine F3N742/F3N743	GDS50037	Drive Shaft	21	23	46.2	82	718				
	1991.07-	1992.04	MT	L	F	Convertible Engine F3N742/F3N743	GDS50001	Drive Shaft	21	29.95	49.8	83.5	639.5				
	1991.07-	1992.04	MT&3AT	R	F	Convertible Engine F3N742/F3N743	GDS50002	Drive Shaft	21	23	49.8	83.5	734				
1.8 16V (101 kW)	1991.07-	1992.04	MT/AT		F	Convertible Engine F7P704	GC050008	Outer Joint	21	25	56.2	83.5	58				O
<b>19 (L53_)</b>																	
1.4 (43 kW)	1988.07-	1992.04	MT	L	F	Saloon Engine C2J772/C3J710	GDS50036	Drive Shaft	21	29.95	46.4	81.5	652				
	1988.07-	1992.04	MT	R	F	Saloon Engine C2J772/C3J710	GDS50037	Drive Shaft	21	23	46.2	82	718				
	1988.07-	1992.04	MT	L	F	Saloon Engine C2J772/C3J710	GDS50001	Drive Shaft	21	29.95	49.8	83.5	639.5				
	1988.07-	1992.04	MT&3AT	R	F	Saloon Engine C2J772/C3J710	GDS50002	Drive Shaft	21	23	49.8	83.5	734				
1.7 (54 kW)	1989.10-	1992.04	MT	L	F	Saloon Engine F3N740/F3N741	GDS50036	Drive Shaft	21	29.95	46.4	81.5	652				
	1989.10-	1992.04	MT	R	F	Saloon Engine F3N740/F3N741	GDS50037	Drive Shaft	21	23	46.2	82	718				
	1989.10-	1992.04	MT	L	F	Saloon Engine F3N740/F3N741	GDS50001	Drive Shaft	21	29.95	49.8	83.5	639.5				
	1989.10-	1992.04	MT&3AT	R	F	Saloon Engine F3N740/F3N741	GDS50002	Drive Shaft	21	23	49.8	83.5	734				
1.7 (66 kW)	1988.07-	1992.04	MT	L	F	Saloon Engine F3N742/F3N743	GDS50036	Drive Shaft	21	29.95	46.4	81.5	652				
	1988.07-	1992.04	MT	R	F	Saloon Engine F3N742/F3N743	GDS50037	Drive Shaft	21	23	46.2	82	718				
	1988.07-	1992.04	MT	L	F	Saloon Engine F3N742/F3N743	GDS50001	Drive Shaft	21	29.95	49.8	83.5	639.5				
	1988.07-	1992.04	MT&3AT	R	F	Saloon Engine F3N742/F3N743	GDS50002	Drive Shaft	21	23	49.8	83.5	734				
1.8 16V (99 kW)	1989.10-	1992.04	MT/AT		F	Saloon Engine F7P704	GC050008	Outer Joint	21	25	56.2	83.5	58				O
1.9 D (47 kW)	1989.10-	1992.04	MT	L	F	Saloon Engine F8Q706/F8Q742	GDS50001	Drive Shaft	21	29.95	49.8	83.5	639.5				
	1989.10-	1992.04	MT	R	F	Saloon Engine F8Q706/F8Q742	GDS50002	Drive Shaft	21	23	49.8	83.5	734				
<b>19 II (B/C53_)</b>																	
1.4 (43 kW)	1992.04-	1995.12	MT	L	F	Hatchback Engine C3J710	GDS50036	Drive Shaft	21	29.95	46.4	81.5	652				
	1992.04-	1995.12	MT	R	F	Hatchback Engine C3J710	GDS50037	Drive Shaft	21	23	46.2	82	718				
	1992.04-	1995.12	MT	L	F	Hatchback Engine C3J710	GDS50001	Drive Shaft	21	29.95	49.8	83.5	639.5				
	1992.04-	1995.12	MT&3AT	R	F	Hatchback Engine C3J710	GDS50002	Drive Shaft	21	23	49.8	83.5	734				
1.4 (55 kW)	1992.01-	1995.12	MT	L	F	Hatchback Engine E7J742	GDS50036	Drive Shaft	21	29.95	46.4	81.5	652				
	1992.01-	1995.12	MT	R	F	Hatchback Engine E7J742	GDS50037	Drive Shaft	21	23	46.2	82	718				
	1992.01-	1995.12	MT	L	F	Hatchback Engine E7J742	GDS50001	Drive Shaft	21	29.95	49.8	83.5	639.5				
	1992.01-	1995.12	MT&3AT	R	F	Hatchback Engine E7J742	GDS50002	Drive Shaft	21	23	49.8	83.5	734				
1.4 (59 kW)	1992.01-	1995.12	MT	R	F	Hatchback Engine E6J700/E7J706	GDS50037	Drive Shaft	21	23	46.2	82	718				
	1992.01-	1995.12	MT	L	F	Hatchback Engine E6J700/E7J706	GDS50001	Drive Shaft	21	29.95	49.8	83.5	639.5				
	1992.01-	1995.12	MT&3AT	R	F	Hatchback Engine E6J700/E7J706	GDS50002	Drive Shaft	21	23	49.8	83.5	734				
	1992.01-	1995.12	MT	L	F	Hatchback Engine E6J700/E7J706	GDS50036	Drive Shaft	21	29.95	46.4	81.5	652				
1.7 (54 kW)	1992.04-	1995.12	MT	L	F	Hatchback Engine F3N740/F3N741	GDS50036	Drive Shaft	21	29.95	46.4	81.5	652				
	1992.04-	1995.12	MT	R	F	Hatchback Engine F3N740/F3N741	GDS50037	Drive Shaft	21	23	46.2	82	718				
	1992.04-	1995.12	MT	L	F	Hatchback Engine F3N740/F3N741	GDS50001	Drive Shaft	21	29.95	49.8	83.5	639.5				
	1992.04-	1995.12	MT&3AT	R	F	Hatchback Engine F3N740/F3N741	GDS50002	Drive Shaft	21	23	49.8	83.5	734				
1.7 (66 kW)	1992.04-	1995.12	MT	L	F	Hatchback Engine F3N743	GDS50036	Drive Shaft	21	29.95	46.4	81.5	652				



		TRANSM	L/R	F/R		G-AP Ref.	PRODUCT	ABS	Technical Specifications								
									YEAR	A	B	C	H	L	P		
<b>RENAULT</b>																	
<b>19 II (B/C53_)</b>																	
1.7 (66 kW)	1992.04-	1995.12	MT	R	F	Hatchback Engine F3N743	GDS50037	Drive Shaft	21	23	46.2	82	718				
	1992.04-	1995.12	MT/3AT		F	Hatchback Engine F3N743	GC050008	Outer Joint	21	25	56.2	83.5	58	O			
	1992.04-	1995.12	MT	L	F	Hatchback Engine F3N743	GDS50001	Drive Shaft	21	29.95	49.8	83.5	639.5				
	1992.04-	1995.12	MT&3AT	R	F	Hatchback Engine F3N743	GDS50002	Drive Shaft	21	23	49.8	83.5	734				
1.8 (65 kW)	1992.04-	1995.12	MT	L	F	Hatchback Engine F3P706/F3P707/F3P708/F3P760	GDS50036	Drive Shaft	21	29.95	46.4	81.5	652				
	1992.04-	1995.12	MT	R	F	Hatchback Engine F3P706/F3P707/F3P708/F3P760	GDS50037	Drive Shaft	21	23	46.2	82	718				
	1992.04-	1995.12	MT/3AT		F	Hatchback Engine F3P706/F3P707/F3P708/F3P760	GC050008	Outer Joint	21	25	56.2	83.5	58	O			
	1992.04-	1995.12	MT	L	F	Hatchback Engine F3P706/F3P707/F3P708/F3P760	GDS50001	Drive Shaft	21	29.95	49.8	83.5	639.5				
	1992.04-	1995.12	MT&3AT	R	F	Hatchback Engine F3P706/F3P707/F3P708/F3P760	GDS50002	Drive Shaft	21	23	49.8	83.5	734				
	1992.04-	1995.12	MT	L	F	Hatchback Engine F3P706/F3P760	GDS50036	Drive Shaft	21	29.95	46.4	81.5	652				
1.8 (66 kW)	1992.04-	1995.12	MT	R	F	Hatchback Engine F3P706/F3P760	GDS50037	Drive Shaft	21	23	46.2	82	718				
	1992.04-	1995.12	MT	L	F	Hatchback Engine F3P706/F3P760	GDS50001	Drive Shaft	21	29.95	49.8	83.5	639.5				
	1992.04-	1995.12	MT&3AT	R	F	Hatchback Engine F3P706/F3P760	GDS50002	Drive Shaft	21	23	49.8	83.5	734				
	1992.04-	1995.12	MT	L	F	Hatchback Engine F3P706/F3P760	GDS50036	Drive Shaft	21	29.95	46.4	81.5	652				
1.8 (79 kW)	1994.05-	1995.12	MT	L	F	Hatchback Engine F3P682/F3P765	GDS50036	Drive Shaft	21	29.95	46.4	81.5	652				
	1994.05-	1995.12	MT	R	F	Hatchback Engine F3P682/F3P765	GDS50037	Drive Shaft	21	23	46.2	82	718				
	1994.05-	1995.12	MT/3AT		F	Hatchback Engine F3P682/F3P765	GC050008	Outer Joint	21	25	56.2	83.5	58	O			
	1994.05-	1995.12	MT	L	F	Hatchback Engine F3P682/F3P765	GDS50001	Drive Shaft	21	29.95	49.8	83.5	639.5				
	1994.05-	1995.12	MT&3AT	R	F	Hatchback Engine F3P682/F3P765	GDS50002	Drive Shaft	21	23	49.8	83.5	734				
	1992.04-	1994.05	MT	L	F	Hatchback Engine F3P700	GDS50036	Drive Shaft	21	29.95	46.4	81.5	652				
1.8 (81 kW)	1992.04-	1994.05	MT	R	F	Hatchback Engine F3P700	GDS50037	Drive Shaft	21	23	46.2	82	718				
	1992.04-	1994.05	MT/3AT		F	Hatchback Engine F3P700	GC050008	Outer Joint	21	25	56.2	83.5	58	O			
	1992.04-	1994.05	MT	L	F	Hatchback Engine F3P700	GDS50001	Drive Shaft	21	29.95	49.8	83.5	639.5				
	1992.04-	1994.05	MT&3AT	R	F	Hatchback Engine F3P700	GDS50002	Drive Shaft	21	23	49.8	83.5	734				
	1992.04-	1994.05	MT	L	F	Hatchback Engine F3P700	GDS50036	Drive Shaft	21	29.95	46.4	81.5	652				
1.8 16V (99 kW)	1992.04-	1995.12	MT/AT		F	Hatchback Engine F7P704	GC050008	Outer Joint	21	25	56.2	83.5	58	O			
1.9 D (47 kW)	1992.04-	1995.12	MT	L	F	Hatchback Engine F8Q742	GDS50001	Drive Shaft	21	29.95	49.8	83.5	639.5				
	1992.04-	1995.12	MT	R	F	Hatchback Engine F8Q742	GDS50002	Drive Shaft	21	23	49.8	83.5	734				
1.9 DT (66 kW)	1992.04-	1995.12	MT		F	Hatchback Engine F8Q744	GC050008	Outer Joint	21	25	56.2	83.5	58	O			
	1992.04-	1995.12	MT	L	F	Hatchback Engine F8Q744	GDS50001	Drive Shaft	21	29.95	49.8	83.5	639.5				
	1992.04-	1995.12	MT	R	F	Hatchback Engine F8Q744	GDS50002	Drive Shaft	21	23	49.8	83.5	734				
<b>19 II (D53_, 853_)</b>																	
1.7 (66 kW)	1992.04-	1993.09	MT&3AT	R	F	Convertible Engine F3N742/F3N743	GDS50002	Drive Shaft	21	23	49.8	83.5	734				
	1992.04-	1993.09	MT	L	F	Convertible Engine F3N742/F3N743	GDS50036	Drive Shaft	21	29.95	46.4	81.5	652				
	1992.04-	1993.09	MT	R	F	Convertible Engine F3N742/F3N743	GDS50037	Drive Shaft	21	23	46.2	82	718				
	1992.04-	1993.09	MT	L	F	Convertible Engine F3N742/F3N743	GDS50001	Drive Shaft	21	29.95	49.8	83.5	639.5				
1.8 (65 kW)	1992.04-	1996.06	MT&3AT	R	F	Convertible Engine F3P704/F3P705/F3P706/F3P707/F3P708/F3P760	GDS50002	Drive Shaft	21	23	49.8	83.5	734				
	1992.04-	1996.06	MT	L	F	Convertible Engine F3P704/F3P705/F3P706/F3P707/F3P708/F3P760	GDS50036	Drive Shaft	21	29.95	46.4	81.5	652				
	1992.04-	1996.06	MT	R	F	Convertible Engine F3P704/F3P705/F3P706/F3P707/F3P708/F3P760	GDS50037	Drive Shaft	21	23	46.2	82	718				
	1992.04-	1996.06	MT	L	F	Convertible Engine F3P704/F3P705/F3P706/F3P707/F3P708/F3P760	GDS50001	Drive Shaft	21	29.95	49.8	83.5	639.5				
	1992.04-	1996.06	MT	L	F	Convertible Engine F3P704/F3P705/F3P706/F3P707/F3P708/F3P760	GDS50002	Drive Shaft	21	23	49.8	83.5	734				
1.8 (66 kW)	1993.09-	1996.06	MT&3AT	R	F	Convertible Engine F3P706/F3P760	GDS50002	Drive Shaft	21	23	49.8	83.5	734				
	1993.09-	1996.06	MT	L	F	Convertible Engine F3P706/F3P760	GDS50036	Drive Shaft	21	29.95	46.4	81.5	652				
	1993.09-	1996.06	MT	R	F	Convertible Engine F3P706/F3P760	GDS50037	Drive Shaft	21	23	46.2	82	718				
	1993.09-	1996.06	MT/3AT		F	Convertible Engine F3P706/F3P760	GC050008	Outer Joint	21	25	56.2	83.5	58	O			
	1993.09-	1996.06	MT	L	F	Convertible Engine F3P706/F3P760	GDS50001	Drive Shaft	21	29.95	49.8	83.5	639.5				
	1993.09-	1996.06	MT&3AT	R	F	Convertible Engine F3P682/F3P764/F3P765	GDS50002	Drive Shaft	21	23	49.8	83.5	734				
1.8 (79 kW)	1994.07-	1996.06	MT	L	F	Convertible Engine F3P682/F3P764/F3P765	GDS50036	Drive Shaft	21	29.95	46.4	81.5	652				
	1994.07-	1996.06	MT	R	F	Convertible Engine F3P682/F3P764/F3P765	GDS50037	Drive Shaft	21	23	46.2	82	718				
	1994.07-	1996.06	MT/3AT		F	Convertible Engine F3P682/F3P764/F3P765	GC050008	Outer Joint	21	25	56.2	83.5	58	O			
	1994.07-	1996.06	MT	L	F	Convertible Engine F3P682/F3P764/F3P765	GDS50001	Drive Shaft	21	29.95	49.8	83.5	639.5				
	1994.07-	1996.06	MT	R	F	Convertible Engine F3P682/F3P764/F3P765	GDS50037	Drive Shaft	21	23	46.2	82	718				
1.8 16V (99 kW)	1992.04-	1996.06	MT/AT		F	Convertible Engine F7P704	GC050008	Outer Joint	21	25	56.2	83.5	58	O			
<b>19 II (L53_)</b>																	
1.4 (43 kW)	1992.04-	1995.12	MT&3AT	R	F	Saloon Engine C3J710	GDS50002	Drive Shaft	21	23	49.8	83.5	734				
	1992.04-	1995.12	MT	L	F	Saloon Engine C3J710	GDS50036	Drive Shaft	21	29.95	46.4	81.5	652				
	1992.04-	1995.12	MT	R	F	Saloon Engine C3J710	GDS50037	Drive Shaft	21	23	46.2	82	718				
	1992.04-	1995.12	MT	L	F	Saloon Engine C3J710	GDS50001	Drive Shaft	21	29.95	49.8	83.5	639.5				
1.4 (55 kW)	1993.11-	1995.12	MT&3AT	R	F	Saloon Engine E7J742	GDS50002	Drive Shaft	21	23	49.8	83.5	734				
	1993.11-	1995.12	MT	L	F	Saloon Engine E7J742	GDS50036	Drive Shaft	21	29.95	46.4	81.5	652				
	1993.11-	1995.12	MT	R	F	Saloon Engine E7J742	GDS50037	Drive Shaft	21	23	46.2	82	718				
	1993.11-	1995.12	MT	L	F	Saloon Engine E7J742	GDS50001	Drive Shaft	21	29.95	49.8	83.5	639.5				
1.7 (54 kW)	1992.04-	1995.12	MT&3AT	R	F	Saloon Engine F3N740/F3N741	GDS50002	Drive Shaft	21	23	49.8	83.5	734				
	1992.04-	1995.12	MT	L	F	Saloon Engine F3N740/F3N741	GDS50036	Drive Shaft	21	29.95	46.4	81.5	652				
	1992.04-	1995.12	MT	R	F	Saloon Engine F3N740/F3N741	GDS50037	Drive Shaft	21	23	46.2	82	718				





		YEAR	TRANSM	L/R	F/R		G-AP Ref.	PRODUCT	ABS	Technical Specifications									
										A	B	C	H	L	P				
<b>RENAULT</b>																			
<b>19 II (L53_)</b>																			
1.7 (54 kW)	1992.04-	1995.12	MT	L	F	Saloon Engine F3N740/F3N741	GDS50001	Drive Shaft		21	29.95	49.8	83.5	639.5					
1.8 (65 kW)	1992.04-	1995.12	MT&3AT	R	F	Saloon Engine F3P704/F3P705/F3P706/F3P707/F3P708/F3P760	GDS50002	Drive Shaft		21	23	49.8	83.5	734					
	1992.04-	1995.12	MT	L	F	Saloon Engine F3P704/F3P705/F3P706/F3P707/F3P708/F3P760	GDS50036	Drive Shaft		21	29.95	46.4	81.5	652					
	1992.04-	1995.12	MT	R	F	Saloon Engine F3P704/F3P705/F3P706/F3P707/F3P708/F3P760	GDS50037	Drive Shaft		21	23	46.2	82	718					
	1992.04-	1995.12	MT/3AT		F	Saloon Engine F3P704/F3P705/F3P706/F3P707/F3P708/F3P760	GC050008	Outer Joint		21	25	56.2	83.5	58	O				
	1992.04-	1995.12	MT	L	F	Saloon Engine F3P704/F3P705/F3P706/F3P707/F3P708/F3P760	GDS50001	Drive Shaft		21	29.95	49.8	83.5	639.5					
1.8 (66 kW)	1992.04-	1995.12	MT&3AT	R	F	Saloon Engine F3P706/F3P760	GDS50002	Drive Shaft		21	23	49.8	83.5	734					
	1992.04-	1995.12	MT	L	F	Saloon Engine F3P706/F3P760	GDS50036	Drive Shaft		21	29.95	46.4	81.5	652					
	1992.04-	1995.12	MT	R	F	Saloon Engine F3P706/F3P760	GDS50037	Drive Shaft		21	23	46.2	82	718					
	1992.04-	1995.12	MT/3AT		F	Saloon Engine F3P706/F3P760	GC050008	Outer Joint		21	25	56.2	83.5	58	O				
	1992.04-	1995.12	MT	L	F	Saloon Engine F3P706/F3P760	GDS50001	Drive Shaft		21	29.95	49.8	83.5	639.5					
1.8 (79 kW)	1994.05-	1995.12	MT&3AT	R	F	Saloon Engine F3P682	GDS50002	Drive Shaft		21	23	49.8	83.5	734					
	1994.05-	1995.12	MT	L	F	Saloon Engine F3P682	GDS50036	Drive Shaft		21	29.95	46.4	81.5	652					
	1994.05-	1995.12	MT	R	F	Saloon Engine F3P682	GDS50037	Drive Shaft		21	23	46.2	82	718					
	1994.05-	1995.12	MT/3AT		F	Saloon Engine F3P682	GC050008	Outer Joint		21	25	56.2	83.5	58	O				
	1994.05-	1995.12	MT	L	F	Saloon Engine F3P682	GDS50001	Drive Shaft		21	29.95	49.8	83.5	639.5					
1.8 (81 kW)	1992.04-	1994.05	MT&3AT	R	F	Saloon Engine F3P700	GDS50002	Drive Shaft		21	23	49.8	83.5	734					
	1992.04-	1994.05	MT	L	F	Saloon Engine F3P700	GDS50036	Drive Shaft		21	29.95	46.4	81.5	652					
	1992.04-	1994.05	MT	R	F	Saloon Engine F3P700	GDS50037	Drive Shaft		21	23	46.2	82	718					
	1992.04-	1994.05	MT/3AT		F	Saloon Engine F3P700	GC050008	Outer Joint		21	25	56.2	83.5	58	O				
	1992.04-	1994.05	MT	L	F	Saloon Engine F3P700	GDS50001	Drive Shaft		21	29.95	49.8	83.5	639.5					
1.8 16V (99 kW)	1992.04-	1995.12	MT/AT		F	Saloon Engine F7P704	GC050008	Outer Joint		21	25	56.2	83.5	58	O				
1.9 D (47 kW)	1992.04-	1995.12	MT	R	F	Saloon Engine F8Q742	GDS50002	Drive Shaft		21	23	49.8	83.5	734					
	1992.04-	1995.12	MT	L	F	Saloon Engine F8Q742	GDS50001	Drive Shaft		21	29.95	49.8	83.5	639.5					
1.9 DT (66 kW)	1992.04-	1995.12	MT	R	F	Saloon Engine F8Q744	GDS50002	Drive Shaft		21	23	49.8	83.5	734					
	1992.04-	1995.12	MT		F	Saloon Engine F8Q744	GC050008	Outer Joint		21	25	56.2	83.5	58	O				
	1992.04-	1995.12	MT	L	F	Saloon Engine F8Q744	GDS50001	Drive Shaft		21	29.95	49.8	83.5	639.5					
<b>19 II (S53_)</b>																			
1.9 DT (68 kW)	1992.03-	1995.12	MT		F	Box Engine F8Q740	GC050008	Outer Joint		21	25	56.2	83.5	58	O				
	1992.03-	1995.12	MT	L	F	Box Engine F8Q740	GDS50001	Drive Shaft		21	29.95	49.8	83.5	639.5					
	1992.03-	1995.12	MT	R	F	Box Engine F8Q740	GDS50002	Drive Shaft		21	23	49.8	83.5	734					
<b>20 (127_)</b>																			
2.0 (76 kW)	1980.10-	1983.12			F	Hatchback Engine 829702/829703	GC050027	Outer Joint		23	25	56.3	109	56	O				
	1980.10-	1983.12	MT	L/R	F	Hatchback Engine 829702/829703	GDS50030	Drive Shaft		23	23	56.3	80.5	697					
2.1 TD (63 kW)	1982.01-	1983.12	MT/AT		F	Hatchback Engine J8S702	GC050007	Outer Joint		23	25	56.3	80.5	56	O				
2.2 (85 kW)	1980.10-	1983.12	MT/AT		F	Hatchback Engine 851700	GC050007	Outer Joint		23	25	56.3	80.5	56	O				
	1980.10-	1983.12	MT	L/R	F	Hatchback Engine 851700	GDS50030	Drive Shaft		23	23	56.3	80.5	697					
<b>21</b>																			
-							GCI50059	Inner Joint		23	22	36.3	41	64.5					
<b>21 (B48_)</b>																			
1.7 (54 kW)	1989.09-	1992.10	MT	L	F	Hatchback Engine F3N726	GDS50033	Drive Shaft		21	29.95	46.3	84	648					
	1989.09-	1992.10	MT	R	F	Hatchback Engine F3N726	GDS50138	Drive Shaft		21	23	46.2	82	741					
	1989.09-	1992.10			F	Hatchback Engine F3N726	GC050001	Outer Joint		23	24	56.3	80	58	I				
1.7 (66 kW)	1989.09-	1994.06	MT	L	F	Hatchback Engine F3N722/F3N723	GDS50033	Drive Shaft		21	29.95	46.3	84	648					
	1989.09-	1994.06	MT	R	F	Hatchback Engine F3N722/F3N723	GDS50138	Drive Shaft		21	23	46.2	82	741					
	1989.09-	1994.06			F	Hatchback Engine F3N722/F3N723	GC050001	Outer Joint		23	24	56.3	80	58	I				
1.9 D (47 kW)	1989.09-	1994.01	MT	L	F	Hatchback Engine F8Q710	GDS50033	Drive Shaft		21	29.95	46.3	84	648					
	1989.09-	1994.01	MT	R	F	Hatchback Engine F8Q710	GDS50138	Drive Shaft		21	23	46.2	82	741					
	1989.09-	1994.01			F	Hatchback Engine F8Q710	GC050001	Outer Joint		23	24	56.3	80	58	I				
2.0 (99 kW)	1990.02-	1992.10	MT/AT	L/R	F	Hatchback Engine J7R740	GDS50007	Drive Shaft		23	23	57.5	83.5	698.5					
	1990.02-	1992.10			F	Hatchback Engine J7R740	GC050001	Outer Joint		23	24	56.3	80	58	I				
2.0 4x4 (99 kW)	1990.09-	1992.10	MT/AT	L/R	F	Hatchback Engine J7R740	GDS50007	Drive Shaft		23	23	57.5	83.5	698.5					
	1990.09-	1992.10				Hatchback Engine J7R740	GC050001	Outer Joint		23	24	56.3	80	58	I				
2.1 D (51 kW)	1992.04-	1994.06			F	Hatchback Engine J8S784	GC050001	Outer Joint		23	24	56.3	80	58	I				
2.1 D (53 kW)	1989.09-	1992.12			F	Hatchback Engine J8S600,J8S740	GC050001	Outer Joint		23	24	56.3	80	58	I				
2.1 Turbo-D (65 kW)	1989.09-	1994.06	MT	L/R	F	Hatchback Engine J8S714/J8S786/J8S788	GDS50007	Drive Shaft		23	23	57.5	83.5	698.5					
	1989.09-	1994.06			F	Hatchback Engine J8S714/J8S786/J8S788	GC050001	Outer Joint		23	24	56.3	80	58	I				
2.2 (79 kW)	1989.09-	1994.06	MT/AT	L/R	F	Hatchback Engine J7T754/J7T755	GDS50007	Drive Shaft		23	23	57.5	83.5	698.5					
	1989.09-	1994.06			F	Hatchback Engine J7T754/J7T755	GC050001	Outer Joint		23	24	56.3	80	58	I				
2.2 4x4 (79 kW)	1990.07-	1994.06	MT/AT	L/R	F	Hatchback Engine J7T754/J7T755	GDS50007	Drive Shaft		23	23	57.5	83.5	698.5					
	1990.07-	1994.06				Hatchback Engine J7T754/J7T755	GC050001	Outer Joint		23	24	56.3	80	58	I				





		TRANSM	L/R	F/R		G-AP Ref.	PRODUCT	ABS	Technical Specifications					
									YEAR	A	B	C	H	L
<b>RENAULT</b>														
<b>21 (L48_)</b>														
1.7 (54 kW)	1986.07-1994.02	MT	L	F	Saloon Engine F2N750/F3N726	GDS50033	Drive Shaft		21	29.95	46.3	84	648	
	1986.07-1994.02	MT	R	F	Saloon Engine F2N750/F3N726	GDS50138	Drive Shaft		21	23	46.2	82	741	
	1986.07-1994.02			F	Saloon Engine F2N750/F3N726	GC050001	Outer Joint		23	24	56.3	80	58	
1.7 (55 kW)	1986.03-1987.12	MT	L	F	Saloon Engine F2N712	GDS50033	Drive Shaft		21	29.95	46.3	84	648	
	1986.03-1987.12	MT	R	F	Saloon Engine F2N712	GDS50138	Drive Shaft		21	23	46.2	82	741	
	1986.03-1987.12			F	Saloon Engine F2N712	GC050001	Outer Joint		23	24	56.3	80	58	
1.7 (64 kW)	1987.06-1989.04	MT	L	F	Saloon Engine F2N752	GDS50033	Drive Shaft		21	29.95	46.3	84	648	
	1987.06-1989.04	MT	R	F	Saloon Engine F2N752	GDS50138	Drive Shaft		21	23	46.2	82	741	
	1987.06-1989.04			F	Saloon Engine F2N752	GC050001	Outer Joint		23	24	56.3	80	58	
1.7 (65 kW)	1986.03-1993.03	MT	L	F	Saloon Engine F2N710	GDS50033	Drive Shaft		21	29.95	46.3	84	648	
	1986.03-1993.03	MT	R	F	Saloon Engine F2N710	GDS50138	Drive Shaft		21	23	46.2	82	741	
	1986.03-1993.03			F	Saloon Engine F2N710	GC050001	Outer Joint		23	24	56.3	80	58	
1.7 (66 kW)	1989.09-1994.02	MT	L	F	Saloon Engine F3N722/F3N723	GDS50033	Drive Shaft		21	29.95	46.3	84	648	
	1989.09-1994.02	MT	R	F	Saloon Engine F3N722/F3N723	GDS50138	Drive Shaft		21	23	46.2	82	741	
	1989.09-1994.02			F	Saloon Engine F3N722/F3N723	GC050001	Outer Joint		23	24	56.3	80	58	
1.7 (69 kW)	1986.03-1994.02	MT	L	F	Saloon Engine F3N722/F3N723	GDS50033	Drive Shaft		21	29.95	46.3	84	648	
	1986.03-1994.02	MT	R	F	Saloon Engine F3N722/F3N723	GDS50138	Drive Shaft		21	23	46.2	82	741	
	1986.03-1994.02			F	Saloon Engine F3N722/F3N723	GC050001	Outer Joint		23	24	56.3	80	58	
1.9 D (47 kW)	1989.08-1993.10	MT	L	F	Saloon Engine F8Q710	GDS50033	Drive Shaft		21	29.95	46.3	84	648	
	1989.08-1993.10	MT	R	F	Saloon Engine F8Q710	GDS50138	Drive Shaft		21	23	46.2	82	741	
	1989.08-1993.10			F	Saloon Engine F8Q710	GC050001	Outer Joint		23	24	56.3	80	58	
2.0 (78 kW)	1991.05-1993.10	MT/AT	L/R	F	Saloon Engine J6R758	GDS50007	Drive Shaft		23	23	57.5	83.5	698.5	
	1991.05-1993.10			F	Saloon Engine J6R758	GC050001	Outer Joint		23	24	56.3	80	58	
2.0 (85 kW)	1986.03-1988.12	MT/AT	L/R	F	Saloon Engine J7R750/J7R751	GDS50007	Drive Shaft		23	23	57.5	83.5	698.5	
2.0 (88 kW)	1986.03-1993.12	MT/AT	L/R	F	Saloon Engine J7R746/J7R747	GDS50007	Drive Shaft		23	23	57.5	83.5	698.5	
2.0 (99 kW)	1990.02-1994.06	MT/AT	L/R	F	Saloon Engine J7R740	GDS50007	Drive Shaft		23	23	57.5	83.5	698.5	
2.0 4x4 (99 kW)	1989.12-1994.02	MT/AT	L/R	F	Saloon Engine J7R740	GDS50007	Drive Shaft		23	23	57.5	83.5	698.5	
2.0 Turbo (129 kW)	1987.04-1990.03			F	Saloon Engine J7R752	GC050007	Outer Joint		23	25	56.3	80.5	56   O	
2.0 Turbo 4x4 (129 kW)	1989.08-1993.10				Saloon Engine J7R752	GC050007	Outer Joint		23	25	56.3	80.5	56   O	
2.1 D (48 kW)	1986.03-1989.12	MT	L/R	F	Saloon Engine J8S704	GDS50007	Drive Shaft		23	23	57.5	83.5	698.5	
2.1 D (51 kW)	1992.10-1994.06			F	Saloon Engine J8S784	GC050001	Outer Joint		23	24	56.3	80	58	
2.1 D (53 kW)	1989.05-1994.06			F	Saloon Engine J8S600,J8S740	GC050001	Outer Joint		23	24	56.3	80	58	
2.1 Turbo-D (65 kW)	1986.03-1994.06	MT/AT	L/R	F	Saloon Engine J8S714/J8S786/J8S788	GDS50007	Drive Shaft		23	23	57.5	83.5	698.5	
	1986.03-1994.06			F	Saloon Engine J8S714/J8S786/J8S788	GC050001	Outer Joint		23	24	56.3	80	58	
2.2 (79 kW)	1986.07-1994.02	MT/AT	L/R	F	Saloon Engine J7T754/J7T755	GDS50007	Drive Shaft		23	23	57.5	83.5	698.5	
	1986.07-1994.02			F	Saloon Engine J7T754/J7T755	GC050001	Outer Joint		23	24	56.3	80	58	
2.2 4x4 (79 kW)	1990.07-1994.02	MT/AT	L/R		Saloon Engine J7T754/J7T755	GDS50007	Drive Shaft		23	23	57.5	83.5	698.5	
	1990.07-1994.02				Saloon Engine J7T754/J7T755	GC050001	Outer Joint		23	24	56.3	80	58	
<b>21 SAVANNA (K48_)</b>														
1.7 (54 kW)	1986.06-1989.12	MT	L	F	Estate Engine F2N750	GDS50033	Drive Shaft		21	29.95	46.3	84	648	
	1986.06-1989.12	MT	R	F	Estate Engine F2N750	GDS50138	Drive Shaft		21	23	46.2	82	741	
	1986.06-1989.12			F	Estate Engine F2N750	GC050001	Outer Joint		23	24	56.3	80	58	
	1988.05-1993.06	MT	L	F	Estate Engine F3N726	GDS50033	Drive Shaft		21	29.95	46.3	84	648	
	1988.05-1993.06	MT	R	F	Estate Engine F3N726	GDS50138	Drive Shaft		21	23	46.2	82	741	
	1988.05-1993.06			F	Estate Engine F3N726	GC050001	Outer Joint		23	24	56.3	80	58	
1.7 (55 kW)	1986.06-1993.03	MT	L	F	Estate Engine F2N712	GDS50033	Drive Shaft		21	29.95	46.3	84	648	
	1986.06-1993.03	MT	R	F	Estate Engine F2N712	GDS50138	Drive Shaft		21	23	46.2	82	741	
	1986.06-1993.03			F	Estate Engine F2N712	GC050001	Outer Joint		23	24	56.3	80	58	
1.7 (64 kW)	1987.06-1989.04	MT	L	F	Estate Engine F2N752	GDS50033	Drive Shaft		21	29.95	46.3	84	648	
	1987.06-1989.04	MT	R	F	Estate Engine F2N752	GDS50138	Drive Shaft		21	23	46.2	82	741	
	1987.06-1989.04			F	Estate Engine F2N752	GC050001	Outer Joint		23	24	56.3	80	58	
1.7 (65 kW)	1986.10-1988.12	MT	L	F	Estate Engine F2N710	GDS50033	Drive Shaft		21	29.95	46.3	84	648	
	1986.10-1988.12	MT	R	F	Estate Engine F2N710	GDS50138	Drive Shaft		21	23	46.2	82	741	
	1986.10-1988.12			F	Estate Engine F2N710	GC050001	Outer Joint		23	24	56.3	80	58	
1.7 (66 kW)	1989.10-1993.12	MT	L	F	Estate Engine F3N722/F3N723	GDS50033	Drive Shaft		21	29.95	46.3	84	648	
	1989.10-1993.12	MT	R	F	Estate Engine F3N722/F3N723	GDS50138	Drive Shaft		21	23	46.2	82	741	
	1989.10-1993.12			F	Estate Engine F3N722/F3N723	GC050001	Outer Joint		23	24	56.3	80	58	
1.7 (69 kW)	1986.06-1989.12	MT	L	F	Estate Engine F3N722/F3N723	GDS50033	Drive Shaft		21	29.95	46.3	84	648	
	1986.06-1989.12	MT	R	F	Estate Engine F3N722/F3N723	GDS50138	Drive Shaft		21	23	46.2	82	741	
	1986.06-1989.12			F	Estate Engine F3N722/F3N723	GC050001	Outer Joint		23	24	56.3	80	58	
1.9 D (47 kW)	1986.03-1994.08	MT	L	F	Estate Engine F8Q710	GDS50033	Drive Shaft		21	29.95	46.3	84	648	



		YEAR	TRANSM	L/R	F/R		G-AP Ref.	PRODUCT	ABS	Technical Specifications						
										A	B	C	H	L	P	
<b>RENAULT</b>																
<b>21 SAVANNA (K48_)</b>																
1.9 D (47 kW)	1986.03-	1994.08	MT	R	F	Estate Engine F8Q710	GDS50138	Drive Shaft		21	23	46.2	82	741		
	1986.03-	1994.08			F	Estate Engine F8Q710	GC050001	Outer Joint		23	24	56.3	80	58	I	
2.0 (85 kW)	1986.06-	1988.12	MT/AT	L/R	F	Estate Engine J7R750/J7R751	GDS50007	Drive Shaft		23	23	57.5	83.5	698.5		
2.0 (99 kW)	1990.06-	1994.02	MT/AT	L/R	F	Estate Engine J7R740	GDS50007	Drive Shaft		23	23	57.5	83.5	698.5		
	1990.06-	1994.02			F	Estate Engine J7R740	GC050001	Outer Joint		23	24	56.3	80	58	I	
2.1 D (48 kW)	1986.10-	1990.09	MT/AT	L/R	F	Estate Engine J8S704	GDS50007	Drive Shaft		23	23	57.5	83.5	698.5		
2.1 D (51 kW)	1992.02-	1995.09	MT/AT	L/R	F	Estate Engine J8S784	GDS50007	Drive Shaft		23	23	57.5	83.5	698.5		
	1992.02-	1995.09			F	Estate Engine J8S784	GC050001	Outer Joint		23	24	56.3	80	58	I	
2.1 D (53 kW)	1989.08-	1992.12	MT/AT	L/R	F	Estate Engine J8S600/J8S740	GDS50007	Drive Shaft		23	23	57.5	83.5	698.5		
	1989.08-	1992.12			F	Estate Engine J8S600/J8S740	GC050001	Outer Joint		23	24	56.3	80	58	I	
2.1 D 4x4 (48 kW)	1988.10-	1992.05	MT/AT	L/R	F	Estate Engine J8S704	GDS50007	Drive Shaft		23	23	57.5	83.5	698.5		
2.1 Turbo-D (65 kW)	1986.10-	1993.11	MT	L/R	F	Estate Engine J8S714/J8S786/J8S788	GDS50007	Drive Shaft		23	23	57.5	83.5	698.5		
	1986.10-	1993.11			F	Estate Engine J8S714/J8S786/J8S788	GC050001	Outer Joint		23	24	56.3	80	58	I	
2.2 (79 kW)	1986.06-	1993.11	MT/AT	L/R	F	Estate Engine J7T754/J7T755	GDS50007	Drive Shaft		23	23	57.5	83.5	698.5		
2.2 4x4 (79 kW)	1986.06-	1993.11			F	Estate Engine J7T754/J7T755	GC050001	Outer Joint		23	24	56.3	80	58	I	
	1986.06-	1993.12	MT/AT	L/R	F	Estate Engine J7T754/J7T755	GDS50007	Drive Shaft		23	23	57.5	83.5	698.5		
2.2 4x4 (79 kW)	1986.06-	1993.12				Estate Engine J7T754/J7T755	GC050001	Outer Joint		23	24	56.3	80	58	I	
	1986.06-	1993.12				Estate Engine J7T754/J7T755	GC050001	Outer Joint		23	24	56.3	80	58	I	
<b>25 (B29_)</b>																
2.0 (74 kW)	1984.04-	1992.12			F	Hatchback Engine J6R760/J6R762/J6R706/J6R763/J6R707	GC050007	Outer Joint		23	25	56.3	80.5	56	O	
	1984.04-	1992.12	MT	L/R	F	Hatchback Engine J6R760/J6R762/J6R706/J6R763/J6R707	GDS50031	Drive Shaft	48T	23	23	56	85	720		
	1984.04-	1992.12	MT/AT	L/R	F	Hatchback Engine J6R760/J6R762/J6R706/J6R763/J6R707	GDS50052	Drive Shaft		23	23	56.3	80.5	713		
2.0 12V (103 kW)	1988.06-	1993.12			F	Hatchback Engine J7R720/J7R721	GC050007	Outer Joint		23	25	56.3	80.5	56	O	
2.0 12V (99 kW)	1989.06-	1992.12			F	Hatchback Engine J7R726	GC050007	Outer Joint		23	25	56.3	80.5	56	O	
2.1 Diesel (46 kW)	1984.04-	1989.05			F	Hatchback Engine J8S706	GC050007	Outer Joint		23	25	56.3	80.5	56	O	
	1984.04-	1989.05	MT	L/R	F	Hatchback Engine J8S706	GDS50031	Drive Shaft	48T	23	23	56	85	720		
	1984.04-	1989.05	MT	L/R	F	Hatchback Engine J8S706	GDS50052	Drive Shaft		23	23	56.3	80.5	713		
2.1 Diesel (51 kW)	1989.06-	1992.12			F	Hatchback Engine J8S736	GC050007	Outer Joint		23	25	56.3	80.5	56	O	
2.1 Turbo-D (63 kW)	1984.04-	1992.12			F	Hatchback Engine J8S708/J8S738	GC050007	Outer Joint		23	25	56.3	80.5	56	O	
	1984.04-	1992.12	MT	L/R	F	Hatchback Engine J8S708/J8S738	GDS50031	Drive Shaft	48T	23	23	56	85	720		
	1984.04-	1992.12	MT	L/R	F	Hatchback Engine J8S708/J8S738	GDS50052	Drive Shaft		23	23	56.3	80.5	713		
2.2 (79 kW)	1986.09-	1992.12			F	Hatchback Engine J7T733/J7T708/J7T732	GC050007	Outer Joint		23	25	56.3	80.5	56	O	
	1986.09-	1992.12	MT	L/R	F	Hatchback Engine J7T733/J7T708/J7T732	GDS50031	Drive Shaft	48T	23	23	56	85	720		
	1986.09-	1992.12	MT	L/R	F	Hatchback Engine J7T733/J7T708/J7T732	GDS50052	Drive Shaft		23	23	56.3	80.5	713		
2.2 (89 kW)	1984.04-	1989.12			F	Hatchback Engine J7T706/J7T707/J7T714/J7T715	GC050007	Outer Joint		23	25	56.3	80.5	56	O	
	1984.04-	1989.12	MT	L/R	F	Hatchback Engine J7T706/J7T707/J7T714/J7T715	GDS50031	Drive Shaft	48T	23	23	56	85	720		
	1984.04-	1989.12	MT	L/R	F	Hatchback Engine J7T706/J7T707/J7T714/J7T715	GDS50052	Drive Shaft		23	23	56.3	80.5	713		
2.2 (91 kW)	1984.04-	1989.12	MT	L/R	F	Hatchback Engine J7T730/J7T731	GDS50031	Drive Shaft	48T	23	23	56	85	720		
	1984.04-	1989.12	MT	L/R	F	Hatchback Engine J7T730/J7T731	GDS50052	Drive Shaft		23	23	56.3	80.5	713		
2.4 V6 Turbo (133 kW)	1984.10-	1990.05			F	Hatchback Engine Z7U702	GC050007	Outer Joint		23	25	56.3	80.5	56	O	
2.5 V6 Turbo (151 kW)	1990.01-	1992.12			F	Hatchback Engine Z7U700	GC050007	Outer Joint		23	25	56.3	80.5	56	O	
2.7 V6 Injection (104 kW)	1984.04-	1989.08			F	Hatchback Engine Z7V708/Z7V709/Z7V711	GC050007	Outer Joint		23	25	56.3	80.5	56	O	
2.8 V6 (115 kW)	1987.06-	1990.02			F	Hatchback Engine Z7W700	GC050007	Outer Joint		23	25	56.3	80.5	56	O	
2.8 V6 Injection (100 kW)	1986.06-	1988.02			F	Hatchback Engine Z7W702	GC050007	Outer Joint		23	25	56.3	80.5	56	O	
2.8 V6 Injection (110 kW)	1987.06-	1992.12			F	Hatchback Engine Z7W706/Z7W707/Z7W709	GC050007	Outer Joint		23	25	56.3	80.5	56	O	
<b>30 (127_)</b>																
2.1 Turbo-D (63 kW)	1982.02-	1986.03			F	Hatchback Engine J8S702	GC050007	Outer Joint		23	25	56.3	80.5	56	O	
	1982.02-	1986.03	MT	L/R	F	Hatchback Engine J8S702	GDS50030	Drive Shaft		23	23	56.3	80.5	697		
2.6 (92 kW)	1976.08-	1978.08			F	Hatchback Engine 112	GC050027	Outer Joint		23	25	56.3	109	56	O	
2.6 (96 kW)	1975.02-	1976.07			F	Hatchback Engine 112	GC050027	Outer Joint		23	25	56.3	109	56	O	
2.6 TS (94 kW)	1978.07-	1984.01			F	Hatchback Engine 144	GC050027	Outer Joint		23	25	56.3	109	56	O	
2.6 TX (105 kW)	1978.10-	1983.12			F	Hatchback Engine 140	GC050027	Outer Joint		23	25	56.3	109	56	O	
<b>4</b>																
-							GCI50013	Inner Joint		22	21	36	49	94		
<b>4 (112)</b>																
0.8 (1120) (20 kW)	1981-	1982					GC050018	Outer Joint		23	30	36.3	90.5	58	O	
0.8 (1123) (19 kW)	1973.09-	1983					GC050018	Outer Joint		23	30	36.3	90.5	58	O	
0.8 (1123) (21 kW)	1983-	1988					GC050018	Outer Joint		23	30	36.3	90.5	58	O	
0.8 (1124) (20 kW)	1983-	1988					GC050018	Outer Joint		23	30	36.3	90.5	58	O	
0.8 (1126) (20 kW)	1976-	1982					GC050018	Outer Joint		23	30	36.3	90.5	58	O	
0.8 (1129) (20 kW)	1976-	1982					GC050018	Outer Joint		23	30	36.3	90.5	58	O	
1.1 (1128) (25 kW)	1978-	1990					GC050018	Outer Joint		23	30	36.3	90.5	58	O	





		YEAR	TRANSM	L/R	F/R		G-AP Ref.	PRODUCT	ABS	Technical Specifications							
										A	B	C	H	L	P		
<b>RENAULT</b>																	
<b>4 (112_)</b>																	
0.8 (19 kW)	1962.10-	1983.09	MT	L/R	F	Estate Engine 800/800705	GDS50005	Drive Shaft			23	22	36.3	90.5	661.5		
0.8 (21 kW)	1983.10-	1988.10	MT	L/R	F	Estate Engine 800705/B1B707	GDS50005	Drive Shaft			23	22	36.3	90.5	661.5		
0.8 (25 kW)	1971.09-	1988.12	MT	L/R	F	Estate Engine 80001	GDS50005	Drive Shaft			23	22	36.3	90.5	661.5		
1.1 (25 kW)	1978.06-	1990.06	MT	L/R	F	Estate Engine 688712/C1E714/C1E719	GDS50005	Drive Shaft			23	22	36.3	90.5	661.5		
<b>4 (R21_, R23_)</b>																	
0.8 (21 kW)	1983.04-	1989.07	MT	L/R	F	Box Engine 800705/B1B707	GDS50005	Drive Shaft			23	22	36.3	90.5	661.5		
0.8 (25 kW)	1966.09-	1988.12	MT	L/R	F	Box Engine 80001	GDS50005	Drive Shaft			23	22	36.3	90.5	661.5		
1.1 (25 kW)	1976.10-	1989.07	MT	L/R	F	Box Engine 688711/688712/C1E714/C1E718/C1E719	GDS50005	Drive Shaft			23	22	36.3	90.5	661.5		
1.1 (26 kW)	1982.07-	1989.05	MT	L/R	F	Box Engine C1E718/C1E719	GDS50005	Drive Shaft			23	22	36.3	90.5	661.5		
<b>5 (122_)</b>																	
0.8 (27 kW)	1982.01-	1984.12	MT	L/R	F	Hatchback Engine 800710	GDS50005	Drive Shaft			23	22	36.3	90.5	661.5		
1.0 (32 kW)	1972.01-	1985.12	MT	L/R	F	Hatchback Engine 689710	GDS50005	Drive Shaft			23	22	36.3	90.5	661.5		
1.1 (33 kW)	1980.09-	1985.12	MT	L/R	F	Hatchback Engine 688713/C1E726	GDS50005	Drive Shaft			23	22	36.3	90.5	661.5		
1.3 (33 kW)	1979.06-	1984.09	MT	L/R	F	Hatchback Engine 810719	GDS50005	Drive Shaft			23	22	36.3	90.5	661.5		
1.3 (47 kW)	1975.09-	1984.09	MT	L/R	F	Hatchback Engine 810725	GDS50005	Drive Shaft			23	22	36.3	90.5	661.5		
1.4 (46 kW)	1982.01-	1985.12	MT	L/R	F	Hatchback Engine 847725/C2J713	GDS50005	Drive Shaft			23	22	36.3	90.5	661.5		
<b>6</b>																	
0.8 (1180) (25 kW)	1973.09-	1980					GC050018	Outer Joint			23	30	36.3	90.5	58	O	
1.1 (1181) (33 kW)	1970-						GC050018	Outer Joint			23	30	36.3	90.5	58	O	
<b>6 (118_)</b>																	
1.1 (35 kW)	1971.07-	1980.04	MT	L/R	F	Hatchback Engine 688.10	GDS50005	Drive Shaft			23	22	36.3	90.5	661.5		
<b>9</b>																	
-							GC150059	Inner Joint			23	22	36.3	41	64.5		
<b>9 (L42)</b>																	
1.4 (L422/421) (44 kW)	1981-	1988					GC050012	Outer Joint			21	30	46.3	80.5	57.5	O	
1.4 (L423, L42R) (49-53 kW)	1981-	1988					GC050012	Outer Joint			21	30	46.3	80.5	57.5	O	
<b>9 (L42_)</b>																	
1.1 (35 kW)	1981.09-	1987.05	MT	R	F	Saloon Engine C1E715/C1E720	GDS50012	Drive Shaft			21	23	46.4	81.5	726		
	1981.09-	1987.05	MT	L	F	Saloon Engine C1E715/C1E720	GDS50013	Drive Shaft			21	29.95	46.4	81.5	633.5		
1.2 (40 kW)	1985.09-	1988.12	MT	R	F	Saloon Engine C1G700/C1G710	GDS50012	Drive Shaft			21	23	46.4	81.5	726		
	1985.09-	1988.12	MT	L	F	Saloon Engine C1G700/C1G710	GDS50013	Drive Shaft			21	29.95	46.4	81.5	633.5		
	1985.09-	1988.12		L	F	Saloon Engine C1G700/C1G710	GDS50041	Drive Shaft			21	29.95	46.2	82	639		
1.4 (44 kW)	1981.12-	1988.12	MT	R	F	Saloon Engine C1J715/C1J792/C1J796/C2J730	GDS50012	Drive Shaft			21	23	46.4	81.5	726		
	1981.12-	1988.12	MT	L	F	Saloon Engine C1J715/C1J792/C1J796/C2J730	GDS50013	Drive Shaft			21	29.95	46.4	81.5	633.5		
1.4 (49 kW)	1985.09-	1988.12	MT	R	F	Saloon Engine C2J720/C2J766/C2J767/C2J768	GDS50012	Drive Shaft			21	23	46.4	81.5	726		
	1985.09-	1988.12	MT	L	F	Saloon Engine C2J720/C2J766/C2J767/C2J768	GDS50013	Drive Shaft			21	29.95	46.4	81.5	633.5		
1.4 (53 kW)	1981.09-	1985.12	MT	R	F	Saloon Engine C2J717/C2J755	GDS50012	Drive Shaft			21	23	46.4	81.5	726		
	1981.09-	1985.12	MT	L	F	Saloon Engine C2J717/C2J755	GDS50013	Drive Shaft			21	29.95	46.4	81.5	633.5		
1.4 Automatik (50 kW)	1981.09-	1985.12	3AT	R	F	Saloon Engine C2J718/C2J757	GDS50012	Drive Shaft			21	23	46.4	81.5	726		
	1981.09-	1985.12	AT	R	F	Saloon Engine C2J718/C2J757	GDS50012	Drive Shaft			21	23	46.4	81.5	726		
1.6 D (40 kW)	1982.10-	1988.12	MT&3AT	R	F	Saloon Engine F8M700/F8M720/F8M730	GDS50012	Drive Shaft			21	23	46.4	81.5	726		
	1982.10-	1988.12	MT	L	F	Saloon Engine F8M700/F8M720/F8M730	GDS50013	Drive Shaft			21	29.95	46.4	81.5	633.5		
1.7 (54 kW)	1986.10-	1988.12	MT	R	F	Saloon Engine F3N718	GDS50012	Drive Shaft			21	23	46.4	81.5	726		
	1986.10-	1988.12	MT	L	F	Saloon Engine F3N718	GDS50013	Drive Shaft			21	29.95	46.4	81.5	633.5		
1.7 (55 kW)	1986.10-	1988.12	MT	R	F	Saloon Engine F2N730	GDS50012	Drive Shaft			21	23	46.4	81.5	726		
	1986.10-	1988.12	MT	L	F	Saloon Engine F2N730	GDS50013	Drive Shaft			21	29.95	46.4	81.5	633.5		
1.7 (59 kW)	1984.09-	1988.12	MT	R	F	Saloon Engine F2N700/F2N704	GDS50012	Drive Shaft			21	23	46.4	81.5	726		
	1984.09-	1988.12	MT	L	F	Saloon Engine F2N700/F2N704	GDS50013	Drive Shaft			21	29.95	46.4	81.5	633.5		
<b>AVANTIME (DE0_)</b>																	
2.0 16V Turbo (120 kW)	2001.11-	2003.05				MPV Engine F4R760/F4R761	GC050057	Outer Joint	44T		27	27	64	90	68	I	
3.0 V6 (152 kW)	2001.09-	2003.05				MPV Engine L7X720/L7X721	GC050057	Outer Joint	44T		27	27	64	90	68	I	
<b>CAPTUR</b>																	
1.5 DCi (66 kW)	2013.06-		AT	L	F	Hatchback	GDS50564	Drive Shaft			25	26	52.4	88.5	678		
<b>CLIO</b>																	
-							GC099070	Outer Joint			21	25	46.3	79	58	O	
							GC050017	Outer Joint			21	22	51.5	83	56.5	I	
	2002-		AT				GC150015	Inner Joint			23	21	36.25	50.5	68		
	2002-		MT				GC150015	Inner Joint			23	21	36.25	50.5	68		
	2004-	2006	MT				GC050090	Outer Joint	44T		21	21	55	83.5	57.5	M	
1				R			GDS50293	Drive Shaft			21	23	46.3	80.5	709.5		
1.1	1990-			L			GDS50116	Drive Shaft			21	29.95	49.8	83.5	610		









		YEAR	TRANSM	L/R	F/R		G-AP Ref.	PRODUCT	ABS	Technical Specifications											
										A	B	C	H	L	P						
<b>RENAULT CLIO</b>																					
1.1	1990-			R			GDS50117	Drive Shaft		21	23	49.8	83.5	698.5							
1.2	1990-			L			GDS50116	Drive Shaft		21	29.95	49.8	83.5	610							
	1990-			R			GDS50117	Drive Shaft		21	23	49.8	83.5	698.5							
1.4	1990-			L			GDS50116	Drive Shaft		21	29.95	49.8	83.5	610							
	1990-			R			GDS50117	Drive Shaft		21	23	49.8	83.5	698.5							
1.6				R			GDS50293	Drive Shaft		21	23	46.3	80.5	709.5							
	2000.01-	2006.12	MT				GC050048	Outer Joint	26T	21	21	55	83.5	57.5	M						
	2002-						GC099207	Outer Joint		21	22	46.4	86	58	I						
	2002.02-	2006.12	MT				GC041081	Outer Joint		21	21	55	83.5	57.5	M						
1.6 16V	2000.01-	2006.12	MT				GC050048	Outer Joint	26T	21	21	55	83.5	57.5	M						
	2002.02-	2006.12	MT				GC041081	Outer Joint		21	21	55	83.5	57.5	M						
1.6 8V	2000.01-	2006.12	MT				GC050048	Outer Joint	26T	21	21	55	83.5	57.5	M						
	2002.02-	2006.12	MT				GC041081	Outer Joint		21	21	55	83.5	57.5	M						
1.7	1990-			L			GDS50116	Drive Shaft		21	29.95	49.8	83.5	610							
	1990-			R			GDS50117	Drive Shaft		21	23	49.8	83.5	698.5							
1.9	1990-			L			GDS50116	Drive Shaft		21	29.95	49.8	83.5	610							
	1990-			R			GDS50117	Drive Shaft		21	23	49.8	83.5	698.5							
1.9 D							GC050034	Outer Joint		21	22	51.5	83	56.5	O						
							GC050062	Outer Joint	26T	21	22	51.5	83	56.5	O						
							GC050063	Outer Joint	44T	21	22	51.5	83	56.5	O						
<b>CLIO (B/C57_, 5/357_)</b>																					
1.2 (40 kW)	1991.01-	1996.06	MT	R	F	Hatchback Engine E7F706	GDS50205	Drive Shaft		21	23	57	85	703							
	1991.01-	1996.06	MT	L	F	Hatchback Engine E7F706	GDS50050	Drive Shaft		21	29.95	56.5	83	618							
	1991.01-	1996.06	MT	R	F	Hatchback Engine E7F706	GDS50014	Drive Shaft		21	23	46.4	81.5	707							
	1991.01-	1996.06	MT		F	Hatchback Engine E7F706	GC050008	Outer Joint		21	25	56.2	83.5	58	O						
	1991.01-	1996.06	MT	L	F	Hatchback Engine E7F706	GDS50015	Drive Shaft		21	29.95	46.4	81.5	612.5							
	1996.01-	1996.12	MT	R	F	Hatchback Engine C3G720	GDS50205	Drive Shaft		21	23	57	85	703							
	1996.01-	1998.09	MT	R	F	Hatchback Engine D7F730	GDS50205	Drive Shaft		21	23	57	85	703							
	1996.01-	1996.12	MT	L	F	Hatchback Engine C3G720	GDS50050	Drive Shaft		21	29.95	56.5	83	618							
	1996.01-	1998.09	MT	L	F	Hatchback Engine D7F730	GDS50050	Drive Shaft		21	29.95	56.5	83	618							
	1996.01-	1996.12	MT	R	F	Hatchback Engine C3G720	GDS50014	Drive Shaft		21	23	46.4	81.5	707							
	1996.01-	1998.09	MT	R	F	Hatchback Engine D7F730	GDS50014	Drive Shaft		21	23	46.4	81.5	707							
	1996.01-	1996.12	MT		F	Hatchback Engine C3G720	GC050008	Outer Joint		21	25	56.2	83.5	58	O						
	1996.01-	1998.09	MT		F	Hatchback Engine D7F730	GC050008	Outer Joint		21	25	56.2	83.5	58	O						
	1996.01-	1996.12	MT	L	F	Hatchback Engine C3G720	GDS50015	Drive Shaft		21	29.95	46.4	81.5	612.5							
	1996.01-	1998.09	MT	L	F	Hatchback Engine D7F730	GDS50015	Drive Shaft		21	29.95	46.4	81.5	612.5							
	1.2 (43 kW)	1990.05-	1998.09	MT	R	F	Hatchback Engine E7F700/E7F708/E7F750	GDS50205	Drive Shaft		21	23	57	85	703						
1990.05-		1998.09	MT	L	F	Hatchback Engine E7F700/E7F708/E7F750	GDS50050	Drive Shaft		21	29.95	56.5	83	618							
1990.05-		1998.09	MT	R	F	Hatchback Engine E7F700/E7F708/E7F750	GDS50014	Drive Shaft		21	23	46.4	81.5	707							
1990.05-		1998.09	MT		F	Hatchback Engine E7F700/E7F708/E7F750	GC050008	Outer Joint		21	25	56.2	83.5	58	O						
1990.05-		1998.09	MT	L	F	Hatchback Engine E7F700/E7F708/E7F750	GDS50015	Drive Shaft		21	29.95	46.4	81.5	612.5							
1996.01-		1998.09	MT	R	F	Hatchback Engine D7F730	GDS50205	Drive Shaft		21	23	57	85	703							
1996.01-		1998.09	MT	L	F	Hatchback Engine D7F730	GDS50050	Drive Shaft		21	29.95	56.5	83	618							
1996.01-		1998.09	MT	R	F	Hatchback Engine D7F730	GDS50014	Drive Shaft		21	23	46.4	81.5	707							
1996.01-		1998.09	MT	F	F	Hatchback Engine D7F730	GC050008	Outer Joint		21	25	56.2	83.5	58	O						
1996.01-		1998.09	MT	L	F	Hatchback Engine D7F730	GDS50015	Drive Shaft		21	29.95	46.4	81.5	612.5							
1.2 (44 kW)	1990.05-	1996.03	MT	R	F	Hatchback Engine E5F710	GDS50205	Drive Shaft		21	23	57	85	703							
	1990.05-	1996.03	MT	L	F	Hatchback Engine E5F710	GDS50050	Drive Shaft		21	29.95	56.5	83	618							
	1990.05-	1996.03	MT	R	F	Hatchback Engine E5F710	GDS50014	Drive Shaft		21	23	46.4	81.5	707							
	1990.05-	1996.03	MT	L	F	Hatchback Engine E5F710	GDS50015	Drive Shaft		21	29.95	46.4	81.5	612.5							
1.4 (55 kW)	1991.01-	1998.09	3AT	R	F	Hatchback Engine E7J756/E7J757	GDS50022	Drive Shaft		21	23	46.3	84	706							
	1991.01-	1998.09	MT	R	F	Hatchback Engine E7J756/E7J757	GDS50014	Drive Shaft		21	23	46.4	81.5	707							
	1991.01-	1998.09	MT		F	Hatchback Engine E7J756/E7J757	GC050008	Outer Joint		21	25	56.2	83.5	58	O						
	1991.01-	1998.09	MT	L	F	Hatchback Engine E7J756/E7J757	GDS50015	Drive Shaft		21	29.95	46.4	81.5	612.5							
1.4 (59 kW)	1991.01-	1998.09	3AT	R	F	Hatchback Engine E7J710/E7J711	GDS50022	Drive Shaft		21	23	46.3	84	706							
	1991.01-	1998.09	MT	R	F	Hatchback Engine E7J710/E7J711	GDS50014	Drive Shaft		21	23	46.4	81.5	707							
	1991.01-	1998.09	MT		F	Hatchback Engine E7J710/E7J711	GC050008	Outer Joint		21	25	56.2	83.5	58	O						
	1991.01-	1998.09	MT	L	F	Hatchback Engine E7J710/E7J711	GDS50015	Drive Shaft		21	29.95	46.4	81.5	612.5							
1.8 (65 kW)	1991.01-	1998.09	MT	R	F	Hatchback Engine F3P710/F3P714	GDS50022	Drive Shaft		21	23	46.3	84	706							
	1991.01-	1998.09	MT	L	F	Hatchback Engine F3P710/F3P714	GDS50020	Drive Shaft		21	29.95	50	84	610.5							
	1991.01-	1998.09	MT		F	Hatchback Engine F3P710/F3P714	GC050008	Outer Joint		21	25	56.2	83.5	58	O						

		TRANSM	L/R	F/R		G-AP Ref.	PRODUCT	ABS	Technical Specifications								
									YEAR	A	B	C	H	L	P		
<b>RENAULT</b>																	
<b>CLIO (B/C57_, 5/357_)</b>																	
1.8 (66 kW)	1994.08-	1998.09	MT	R	F	Hatchback Engine F3P754/F3P755	GDS50022	Drive Shaft		21	23	46.3	84	706			
	1994.08-	1998.09	MT	L	F	Hatchback Engine F3P754/F3P755	GDS50020	Drive Shaft		21	29.95	50	84	610.5			
	1994.08-	1998.09			F	Hatchback Engine F3P754/F3P755	GC050011	Outer Joint	26T	21	25	56.2	83.5	58	O		
	1994.08-	1998.09	MT		F	Hatchback Engine F3P754/F3P755	GC050008	Outer Joint		21	25	56.2	83.5	58	O		
1.8 16V (99 kW)	1991.01-	1996.03			F	Hatchback Engine F7P722	GC050011	Outer Joint	26T	21	25	56.2	83.5	58	O		
	1991.01-	1996.03	MT		F	Hatchback Engine F7P722	GC050008	Outer Joint		21	25	56.2	83.5	58	O		
1.8 Rsi (79 kW)	1995.08-	1998.09	MT	R	F	Hatchback Engine F3P758	GDS50022	Drive Shaft		21	23	46.3	84	706			
	1995.08-	1998.09	MT	L	F	Hatchback Engine F3P758	GDS50020	Drive Shaft		21	29.95	50	84	610.5			
	1995.08-	1998.09			F	Hatchback Engine F3P758	GC050011	Outer Joint	26T	21	25	56.2	83.5	58	O		
	1995.08-	1998.09	MT		F	Hatchback Engine F3P758	GC050008	Outer Joint		21	25	56.2	83.5	58	O		
1.8 Rsi (80 kW)	1993.01-	1995.08	MT	R	F	Hatchback Engine F3P712	GDS50022	Drive Shaft		21	23	46.3	84	706			
	1993.01-	1995.08	MT	L	F	Hatchback Engine F3P712	GDS50020	Drive Shaft		21	29.95	50	84	610.5			
	1993.01-	1995.08			F	Hatchback Engine F3P712	GC050011	Outer Joint	26T	21	25	56.2	83.5	58	O		
	1993.01-	1995.08	MT		F	Hatchback Engine F3P712	GC050008	Outer Joint		21	25	56.2	83.5	58	O		
1.9 D (40 kW)	1997.01-	1998.09		L	F	Hatchback Engine F8Q678	GDS50303	Drive Shaft		21	29.95	57	84	634			
	1997.01-	1998.09		R	F	Hatchback Engine F8Q678	GDS50051	Drive Shaft		21	23	46	83.5	718			
	1997.01-	1998.09		L	F	Hatchback Engine F8Q678	GDS50045	Drive Shaft	26T	21	29.95	51.5	83	634			
	1997.01-	1998.09		R	F	Hatchback Engine F8Q678	GDS50082	Drive Shaft	26T	21	23	51.5	83	717			
1.9 D (47 kW)	1991.01-	1998.09	MT	R	F	Hatchback Engine F8Q730/F8Q732	GDS50022	Drive Shaft		21	23	46.3	84	706			
	1991.01-	1998.09	MT	L	F	Hatchback Engine F8Q730/F8Q732	GDS50020	Drive Shaft		21	29.95	50	84	610.5			
	1991.01-	1998.09			F	Hatchback Engine F8Q730/F8Q732	GC050011	Outer Joint	26T	21	25	56.2	83.5	58	O		
	1991.01-	1998.09	MT		F	Hatchback Engine F8Q730/F8Q732	GC050008	Outer Joint		21	25	56.2	83.5	58	O		
2.0 Williams (108 kW)	1994.01-	1998.09	MT		F	Hatchback Engine F7R700	GC050008	Outer Joint		21	25	56.2	83.5	58	O		
<b>CLIO / THALIA</b>																	
-							GCI50058	Inner Joint		23	22	36.3	40	64.5			
<b>CLIO GRANDTOUR (KR0/1)</b>																	
1.2 16V (55 kW)	2008.02-						GC050112	Outer Joint		23	28	49	83.5	54.5	I		
1.2 16V (58 kW)	2008.02-						GC050112	Outer Joint		23	28	49	83.5	54.5	I		
1.2 16V (74 kW)	2008.02-		MT				GC050092	Outer Joint		23	29	49	86	57	I		
1.5 DCi (50 kW)	2008.02-						GC050092	Outer Joint		23	29	49	86	57	I		
1.5 DCi (63 kW)	2008.02-						GC050112	Outer Joint		23	28	49	83.5	54.5	I		
1.6 16V (82 kW)	2008.02-						GC099085	Outer Joint		23	30	49	86	59	I		
<b>CLIO GRANDTOUR (KR0/1_)</b>																	
1.2 16V (55 kW)	2008.02-				F	Estate Engine D4F740	GC050112	Outer Joint		23	28	49	83.5	54.5	I		
	2008.02-			L	F	Estate Engine D4F740	GDS50369	Drive Shaft		23	26	49	83.5	651			
	2008.02-			R	F	Estate Engine D4F740	GDS50372	Drive Shaft		23	26	49	83.5	890			
1.2 16V (58 kW)	2008.02-			L	F	Estate Engine D4F764	GDS50369	Drive Shaft		23	26	49	83.5	651			
	2008.02-			R	F	Estate Engine D4F764	GDS50372	Drive Shaft		23	26	49	83.5	890			
1.2 16V Hi-Flex (55 kW)	2008.07-				F	Estate Engine D4F740	GC050112	Outer Joint		23	28	49	83.5	54.5	I		
1.5 DCi (50 kW)	2008.02-				F	Estate Engine K9K768/K9K714	GC050092	Outer Joint		23	29	49	86	57	I		
	2008.02-			L	F	Estate Engine K9K768/K9K714	GDS50353	Drive Shaft		23	26	49	86	649			
	2008.02-			R	F	Estate Engine K9K768/K9K714	GDS50354	Drive Shaft		23	26	49	86	897			
1.5 DCi (63 kW)	2008.02-				F	Estate Engine K9K766	GC050112	Outer Joint		23	28	49	83.5	54.5	I		
	2008.02-			L	F	Estate Engine K9K766	GDS50353	Drive Shaft		23	26	49	86	649			
	2008.02-			R	F	Estate Engine K9K766	GDS50354	Drive Shaft		23	26	49	86	897			
1.5 DCi (65 kW)	2010.08-			L	F	Estate Engine K9K772/K9K770	GDS50379	Drive Shaft		25	26	52.8	85.5	650			
	2010.08-			R	F	Estate Engine K9K772/K9K770	GDS50483	Drive Shaft		25	26	52.8	85.5	891			
1.5 DCi (76 kW)	2008.02-			L	F	Estate Engine K9K772	GDS50379	Drive Shaft		25	26	52.8	85.5	650			
	2008.02-			R	F	Estate Engine K9K772	GDS50483	Drive Shaft		25	26	52.8	85.5	891			
1.5 DCi (78 kW)	2008.02-		MT	L	F	Estate Engine K9K764	GDS50353	Drive Shaft		23	26	49	86	649			
	2008.02-		MT	R	F	Estate Engine K9K764	GDS50354	Drive Shaft		23	26	49	86	897			
	2008.02-			L	F	Estate Engine K9K764	GDS50379	Drive Shaft		25	26	52.8	85.5	650			
	2008.02-			R	F	Estate Engine K9K764	GDS50483	Drive Shaft		25	26	52.8	85.5	891			
1.6 16V (82 kW)	2008.02-		5MT		F	Estate Engine K4M800/801	GC099085	Outer Joint		23	30	49	86	59	I		
	2008.02-			R	F	Estate Engine K4M800/801	GDS50443	Drive Shaft		23	23	49	86	789			
1.6 16V (94 kW)	2008.11-			R	F	Estate Engine K4M862	GDS50483	Drive Shaft		25	26	52.8	85.5	891			
<b>CLIO II</b>																	
1.2	2001.04-		MT	L	F		GDS50103	Drive Shaft	44T	21	29.95	57	84.5	625.7			
	2001.04-		MT	R	F		GDS50241	Drive Shaft	44T	21	23	57	84.5	718.5			
1.4	1998-	2005		L	F		GDS50363	Drive Shaft	26T	21	29.95	52.2	85.5	630			
	1998-	2005		R	F		GDS50162	Drive Shaft	26T	21	23	52.2	85.5	723.5			



		TRANSM	L/R	F/R		G-AP Ref.	PRODUCT	ABS	Technical Specifications										
									YEAR	A	B	C	H	L	P				
<b>RENAULT</b>																			
<b>CLIO II</b>																			
1.4	2001.04-		MT	L	F		GDS50103	Drive Shaft	44T	21	29.95	57	84.5	625.7					
	2001.04-		MT	R	F		GDS50241	Drive Shaft	44T	21	23	57	84.5	718.5					
1.5 DCi	1998-2005			L	F		GDS50363	Drive Shaft	26T	21	29.95	52.2	85.5	630					
	1998-2005			R	F		GDS50162	Drive Shaft	26T	21	23	52.2	85.5	723.5					
	2001.04-		MT	L	F		GDS50103	Drive Shaft	44T	21	29.95	57	84.5	625.7					
	2001.04-		MT	R	F		GDS50241	Drive Shaft	44T	21	23	57	84.5	718.5					
1.9 DTi	2001-		MT	R			GDS50092	Drive Shaft		21	23	57	84.5	719					
<b>CLIO II (B/C/ B0/1)</b>																			
1.2 (43 kW)	1998.09-	2005.05					GC099070	Outer Joint		21	25	46.3	79	58	O				
1.4 (55 kW)	1998.09-	2005.05					GC050004	Outer Joint	26T	21	30	52.2	85.5	59	I				
1.4 16V (70 kW)	1999.10-	2000.08					GC050004	Outer Joint	26T	21	30	52.2	85.5	59	I				
1.4 16V (72 kW)	1999.10-	2000.08					GC050004	Outer Joint	26T	21	30	52.2	85.5	59	I				
1.5 DCi (48 kW)	2001.06-						GC050004	Outer Joint	26T	21	30	52.2	85.5	59	I				
	2001.06-						GC050066	Outer Joint	44T	21	28	52.5	85	51	I				
1.5 DCi (59 kW)	2001.06-						GC050004	Outer Joint	26T	21	30	52.2	85.5	59	I				
1.5 DCi (60 kW)	2001.06-	2003.10					GC050069	Outer Joint	44T	23	30	57.5	86.5	58.5	I				
	2001.06-						GC050066	Outer Joint	44T	21	28	52.5	85	51	I				
1.5 DCi (74 kW)	2001.06-						GC050004	Outer Joint	26T	21	30	52.2	85.5	59	I				
1.6 (55 kW)	1998.09-	2005.05					GC050004	Outer Joint	26T	21	30	52.2	85.5	59	I				
1.6 (66 kW)	1998.09-	2005.05					GC050004	Outer Joint	26T	21	30	52.2	85.5	59	I				
1.9 D (40 kW)	1998.09-	2005.05					GC050004	Outer Joint	26T	21	30	52.2	85.5	59	I				
1.9 D (44 kW)	1998.09-	2005.05					GC050004	Outer Joint	26T	21	30	52.2	85.5	59	I				
1.9 D (47 kW)	1998.09-	2005.05					GC050004	Outer Joint	26T	21	30	52.2	85.5	59	I				
1.9 DTi (59 kW)	2000.02-	2005.05					GC050004	Outer Joint	26T	21	30	52.2	85.5	59	I				
1.9 DTi (68 kW)	2000.02-	2005.05					GC050004	Outer Joint	26T	21	30	52.2	85.5	59	I				
1.9 DTi (75 kW)	2000.02-	2005.05					GC050004	Outer Joint	26T	21	30	52.2	85.5	59	I				
1.9 DTi (81 kW)	2000.02-	2005.05					GC050004	Outer Joint	26T	21	30	52.2	85.5	59	I				
1.9 DTi (88 kW)	2000.02-	2005.05					GC050004	Outer Joint	26T	21	30	52.2	85.5	59	I				
1.9 DTi (96 kW)	2000.02-	2005.05					GC050004	Outer Joint	26T	21	30	52.2	85.5	59	I				
<b>CLIO II (BB0/1/2_ , CB0/1/2_ )</b>																			
1.2 (55 kW)	2001.06-	2003.10	MT	L	F	Hatchback	GDS50004	Drive Shaft	26T	21	29.95	57	84.5	625.7					
	2001.06-	2003.10	Semi-AT	L	F	Hatchback	GDS50502	Drive Shaft	44T	21		57	84.5	628					
	2001.06-	2003.10		R	F	Hatchback	GDS50263	Drive Shaft	44T	21	23	52.2	85.5	723.5					
	2001.06-	2003.10	AT	R	F	Hatchback	GDS50486	Drive Shaft	26T	21	23	52.2	85.5	733					
	2001.06-	2003.10	MT	R	F	Hatchback	GDS50146	Drive Shaft		21	23	57	84.5	732.5					
	2001.06-	2003.10	MT	R	F	Hatchback	GC150058	Inner Joint		23	22	36.3	40	64.5					
	2001.06-	2003.10	MT	R	F	Hatchback	GDS50395	Drive Shaft	26T	21	23	51.5	83	728					
	2001.06-	2003.10	MT	R	F	Hatchback	GDS50151	Drive Shaft		21	23	49.8	83.5	712					
	2001.06-	2003.10	MT	R	F	Hatchback	GDS50017	Drive Shaft	26T	21	23	51.5	83	715					
	2001.06-	2003.10	Semi-AT	R	F	Hatchback	GDS50250	Drive Shaft	26T	21	23	57	84.5	732.5					
	2001.06-	2003.10	AT		F	Hatchback	GDS99242	Drive Shaft	44T	21	26	52.2	85.5	621					
	2001.06-	2003.10	AT	L	F	Hatchback	GDS99169	Drive Shaft	26T	21	26	52.2	85.5	621					
	2001.06-	2003.10	MT	L	F	Hatchback	GDS50177	Drive Shaft		21	29.95	57	84.5	625.7					
	2001.06-	2003.10	MT	L	F	Hatchback	GDS99073	Drive Shaft	44T	21	29.95	57	84.5	628					
	2001.06-	2003.10	MT	L	F	Hatchback	GDS50401	Drive Shaft	44T	21	29.95	57	84	629					
	2001.06-	2003.10	MT	L	F	Hatchback	GDS50150	Drive Shaft		21	29.95	49.8	83.5	623					
1.2 16V (55 kW)	2001.06-		MT	L	F	Hatchback Engine D4F706/D4F712/D4F714/D4F722/D4F728	GDS50401	Drive Shaft	44T	21	29.95	57	84	629					
	2001.06-		MT	L	F	Hatchback Engine D4F706/D4F712/D4F714/D4F722/D4F728	GDS50150	Drive Shaft		21	29.95	49.8	83.5	623					
	2001.06-		MT	L	F	Hatchback Engine D4F706/D4F712/D4F714/D4F722/D4F728	GDS50004	Drive Shaft	26T	21	29.95	57	84.5	625.7					
	2001.06-			R	F	Hatchback Engine D4F706/D4F712/D4F714/D4F722/D4F728	GDS50263	Drive Shaft	44T	21	23	52.2	85.5	723.5					
	2001.06-		MT	R	F	Hatchback Engine D4F706/D4F712/D4F714/D4F722/D4F728	GDS50395	Drive Shaft	26T	21	23	51.5	83	728					
	2001.06-		MT	R	F	Hatchback Engine D4F706/D4F712/D4F714/D4F722/D4F728	GDS50151	Drive Shaft		21	23	49.8	83.5	712					
	2001.06-		MT	R	F	Hatchback Engine D4F706/D4F712/D4F714/D4F722/D4F728	GDS50017	Drive Shaft	26T	21	23	51.5	83	715					
	2001.06-		AT	L	F	Hatchback Engine D4F706/D4F712/D4F714/D4F722/D4F728	GDS99169	Drive Shaft	26T	21	26	52.2	85.5	621					
	2001.06-		MT	L	F	Hatchback Engine D4F706/D4F712/D4F714/D4F722/D4F728	GDS50177	Drive Shaft		21	29.95	57	84.5	625.7					
	2001.06-		MT	L	F	Hatchback Engine D4F706/D4F712/D4F714/D4F722/D4F728	GDS99073	Drive Shaft	44T	21	29.95	57	84.5	628					
	2001.06-		Semi-AT	L	F	Hatchback Engine D4F706/D4F712/D4F714/D4F722/D4F728	GDS50502	Drive Shaft	44T	21		57	84.5	628					
	2001.06-		AT	R	F	Hatchback Engine D4F706/D4F712/D4F714/D4F722/D4F728	GDS50486	Drive Shaft	26T	21	23	52.2	85.5	733					
	2001.06-		MT	R	F	Hatchback Engine D4F706/D4F712/D4F714/D4F722/D4F728	GDS50146	Drive Shaft		21	23	57	84.5	732.5					
	2001.06-		MT	R	F	Hatchback Engine D4F706/D4F712/D4F714/D4F722/D4F728	GC150058	Inner Joint		23	22	36.3	40	64.5					





		TRANSM	L/R	F/R		G-AP Ref.	PRODUCT	ABS	Technical Specifications									
									YEAR	A	B	C	H	L	P			
<b>RENAULT</b>																		
<b>CLIO II (BB0/1/2_, CB0/1/2_)</b>																		
1.2 16V (55 kW)	2001.06-		Semi-AT	R	F	Hatchback Engine D4F706/D4F712/D4F714/D4F722/D4F728	GDS50250	Drive Shaft	26T	21	23	57	84.5	732.5				
	2001.06-		AT		F	Hatchback Engine D4F706/D4F712/D4F714/D4F722/D4F728	GDS99242	Drive Shaft	44T	21	26	52.2	85.5	621				
1.4 (55 kW)	1998.09-	2005.05	MT		F	Hatchback Engine E7J780	GC050004	Outer Joint	26T	21	30	52.2	85.5	59	I			
	1998.09-	2005.05	MT	L	F	Hatchback Engine E7J780	GDS50177	Drive Shaft		21	29.95	57	84.5	625.7				
	1998.09-	2005.05	MT	L	F	Hatchback Engine E7J780	GDS50150	Drive Shaft		21	29.95	49.8	83.5	623				
	1998.09-	2005.05	MT	L	F	Hatchback Engine E7J780	GDS50004	Drive Shaft	26T	21	29.95	57	84.5	625.7				
	1998.09-	2005.05	MT	R	F	Hatchback Engine E7J780	GDS50146	Drive Shaft		21	23	57	84.5	732.5				
	1998.09-	2005.05	MT	R	F	Hatchback Engine E7J780	GDS50250	Drive Shaft	26T	21	23	57	84.5	732.5				
	1998.09-	2005.05	MT	R	F	Hatchback Engine E7J780	GCI50058	Inner Joint		23	22	36.3	40	64.5				
	1998.09-	2005.05	MT	R	F	Hatchback Engine E7J780	GC050034	Outer Joint		21	22	51.5	83	56.5	O			
	1998.09-	2005.05	MT	R	F	Hatchback Engine E7J780	GDS50336	Drive Shaft	26T	21	23	57	84	727				
	1998.09-	2005.05	MT	R	F	Hatchback Engine E7J780	GDS50395	Drive Shaft	26T	21	23	51.5	83	728				
	1998.09-	2005.05	MT	R	F	Hatchback Engine E7J780	GDS50063	Drive Shaft		21	23	51.5	83	720				
	1998.09-	2005.05	MT	R	F	Hatchback Engine E7J780	GDS50151	Drive Shaft		21	23	49.8	83.5	712				
	1998.09-	2005.05	MT	R	F	Hatchback Engine E7J780	GDS50017	Drive Shaft	26T	21	23	51.5	83	715				
	1998.09-	2005.05		R	F	Hatchback Engine E7J780	GDS99150	Drive Shaft	26T	21	23	52.2	85.5	747				
1.4 16V (70 kW)	1999.10-	2004.09			F	Hatchback Engine K4J712/713	GC050004	Outer Joint	26T	21	30	52.2	85.5	59	I			
	1999.10-	2004.09	MT	L	F	Hatchback Engine K4J712/713	GDS50177	Drive Shaft		21	29.95	57	84.5	625.7				
	1999.10-	2004.09	MT	L	F	Hatchback Engine K4J712/713	GDS99073	Drive Shaft	44T	21	29.95	57	84.5	628				
	1999.10-	2004.09	MT	L	F	Hatchback Engine K4J712/713	GDS50150	Drive Shaft		21	29.95	49.8	83.5	623				
	1999.10-	2004.09	MT	L	F	Hatchback Engine K4J712/713	GDS50004	Drive Shaft	26T	21	29.95	57	84.5	625.7				
	1999.10-	2004.09	AT	R	F	Hatchback Engine K4J712/713	GDS99150	Drive Shaft	26T	21	23	52.2	85.5	747				
	1999.10-	2004.09	MT	R	F	Hatchback Engine K4J712/713	GDS50146	Drive Shaft		21	23	57	84.5	732.5				
	1999.10-	2004.09	MT	R	F	Hatchback Engine K4J712/713	GDS50250	Drive Shaft	26T	21	23	57	84.5	732.5				
	1999.10-	2004.09	MT	R	F	Hatchback Engine K4J712/713	GCI50058	Inner Joint		23	22	36.3	40	64.5				
	1999.10-	2004.09	MT	R	F	Hatchback Engine K4J712/713	GDS50395	Drive Shaft	26T	21	23	51.5	83	728				
	1999.10-	2004.09	MT	R	F	Hatchback Engine K4J712/713	GDS50151	Drive Shaft		21	23	49.8	83.5	712				
	1999.10-	2004.09	MT	R	F	Hatchback Engine K4J712/713	GDS50017	Drive Shaft	26T	21	23	51.5	83	715				
1.4 16V (72 kW)	2000.08-		AT	L	F	Hatchback Engine K4J710/K4J711/K4J712/K4J713	GDS99169	Drive Shaft	26T	21	26	52.2	85.5	621				
	2000.08-		MT	L	F	Hatchback Engine K4J710/K4J711/K4J712/K4J713	GDS50177	Drive Shaft		21	29.95	57	84.5	625.7				
	2000.08-		AT	R	F	Hatchback Engine K4J710/K4J711/K4J712/K4J713	GDS50486	Drive Shaft	26T	21	23	52.2	85.5	733				
	2000.08-			R	F	Hatchback Engine K4J710/K4J711/K4J712/K4J713	GDS99150	Drive Shaft	26T	21	23	52.2	85.5	747				
	2000.08-		MT	R	F	Hatchback Engine K4J710/K4J711/K4J712/K4J713	GCI50058	Inner Joint		23	22	36.3	40	64.5				
1.5 DCi (47 kW)	2005.06-				F	Hatchback Engine K9K740	GC050143	Outer Joint		25	32	52.8	85.5	62.5	I			
	2005.06-		MT	L	F	Hatchback Engine K9K740	GDS50177	Drive Shaft		21	29.95	57	84.5	625.7				
	2005.06-		MT	L	F	Hatchback Engine K9K740	GDS99073	Drive Shaft	44T	21	29.95	57	84.5	628				
	2005.06-			L	F	Hatchback Engine K9K740	GDS50280	Drive Shaft	44T	23	26	57.5	86.5	602				
	2005.06-			L/R	F	Hatchback Engine K9K740	GC099087	Outer Joint		23	30	57.5	86.5	58.5	I			
	2005.06-		MT	R	F	Hatchback Engine K9K740	GDS50146	Drive Shaft		21	23	57	84.5	732.5				
	2005.06-		MT	R	F	Hatchback Engine K9K740	GDS50250	Drive Shaft	26T	21	23	57	84.5	732.5				
	2005.06-			R	F	Hatchback Engine K9K740	GDS50373	Drive Shaft	44T	23	26	57.5	86.5	864				
1.5 DCi (48 kW)	2001.06-		MT	L	F	Hatchback Engine K9K700/K9K704	GDS50397	Drive Shaft		21	29.95	50	84	632				
	2001.06-		MT	R	F	Hatchback Engine K9K700/K9K704	GDS50395	Drive Shaft	26T	21	23	51.5	83	728				
	2001.06-		MT	R	F	Hatchback Engine K9K700/K9K704	GDS50437	Drive Shaft		21	23	51.5	83	729				
	2001.06-		MT	L	F	Hatchback Engine K9K700/K9K704	GDS50177	Drive Shaft		21	29.95	57	84.5	625.7				
	2001.06-		MT	L	F	Hatchback Engine K9K700/K9K704	GDS99073	Drive Shaft	44T	21	29.95	57	84.5	628				
	2001.06-		MT	R	F	Hatchback Engine K9K700/K9K704	GDS50146	Drive Shaft		21	23	57	84.5	732.5				
	2001.06-		MT	R	F	Hatchback Engine K9K700/K9K704	GDS50250	Drive Shaft	26T	21	23	57	84.5	732.5				
1.5 DCi (50 kW)	2004.08-				F	Hatchback Engine K9K700/K9K714	GC050092	Outer Joint		23	29	49	86	57	I			
	2004.08-			L	F	Hatchback Engine K9K700/K9K714	GDS50397	Drive Shaft		21	29.95	50	84	632				
	2004.08-			R	F	Hatchback Engine K9K700/K9K714	GDS50395	Drive Shaft	26T	21	23	51.5	83	728				
	2004.08-			R	F	Hatchback Engine K9K700/K9K714	GDS50437	Drive Shaft		21	23	51.5	83	729				
	2004.08-		MT	L	F	Hatchback Engine K9K700/K9K714	GDS50177	Drive Shaft		21	29.95	57	84.5	625.7				
	2004.08-		MT	L	F	Hatchback Engine K9K700/K9K714	GDS99073	Drive Shaft	44T	21	29.95	57	84.5	628				
	2004.08-			L	F	Hatchback Engine K9K700/K9K714	GDS50280	Drive Shaft	44T	23	26	57.5	86.5	602				
	2004.08-			L	F	Hatchback Engine K9K700/K9K714	GC099087	Outer Joint		23	30	57.5	86.5	58.5	I			
	2004.08-		MT	R	F	Hatchback Engine K9K700/K9K714	GDS50146	Drive Shaft		21	23	57	84.5	732.5				
	2004.08-		MT	R	F	Hatchback Engine K9K700/K9K714	GDS50250	Drive Shaft	26T	21	23	57	84.5	732.5				
	2004.08-		MT	R	F	Hatchback Engine K9K700/K9K714	GDS50364	Drive Shaft	44T	23	26	57.5	86.5	866				
	2004.08-			R	F	Hatchback Engine K9K700/K9K714	GC050052	Outer Joint	44T	23	30	57.5	86.5	58.5	I			
1.5 DCi (59 kW)	2001.06-	2003.10	MT	L	F	Hatchback Engine K9K702	GDS50411	Drive Shaft	44T	23	29.95	57.5	86.5	631				



		TRANSM	L/R	F/R		G-AP Ref.	PRODUCT	ABS	Technical Specifications					
									YEAR	A	B	C	H	L
<b>RENAULT</b>														
<b>CLIO II (BB0/1/2_ , CB0/1/2_ )</b>														
1.5 DCi (60 kW)	2001.06-			L	F	Hatchback Engine K9K702	GDS50261	Drive Shaft	44T	23	29.95	57.5	86.5	630
	2001.06-		MT	L	F	Hatchback Engine K9K702	GDS50394	Drive Shaft		23	29.95	57.5	86.5	631
	2001.06-		MT	L	F	Hatchback Engine K9K702	GDS50194	Drive Shaft	26T	23	29.95	57.5	86.5	631
	2001.06-		MT	R	F	Hatchback Engine K9K702	GDS50260	Drive Shaft	44T	23	23	57.5	86.5	724
	2001.06-		MT	R	F	Hatchback Engine K9K702	GDS50193	Drive Shaft	26T	23	23	57.5	86.5	724
	2001.06-		MT	R	F	Hatchback Engine K9K702	GDS50462	Drive Shaft		23	23	57.5	86.5	724
	2001.06-		MT	L	F	Hatchback Engine K9K702	GDS50411	Drive Shaft	44T	23	29.95	57.5	86.5	631
1.5 DCi (62 kW)	2007.02-				F	Hatchback Engine K9K718	GC050143	Outer Joint		25	32	52.8	85.5	62.5 I
	2007.02-			L	F	Hatchback Engine K9K718	GDS50280	Drive Shaft	44T	23	26	57.5	86.5	602
	2007.02-			L	F	Hatchback Engine K9K718	GCI50085	Inner Joint		26	33	40	64	123
	2007.02-			L/R	F	Hatchback Engine K9K718	GC099087	Outer Joint		23	30	57.5	86.5	58.5 I
	2007.02-			R	F	Hatchback Engine K9K718	GDS50373	Drive Shaft	44T	23	26	57.5	86.5	864
	2007.02-			R	F	Hatchback Engine K9K718	GCI50086	Inner Joint		26	33	33	326	94
1.5 DCi (74 kW)	2004.01-			L	F	Hatchback Engine K9K712	GDS50279	Drive Shaft	44T	23	26	58.8	85	596
	2004.01-		MT	R	F	Hatchback Engine K9K712	GDS50364	Drive Shaft	44T	23	26	57.5	86.5	866
	2004.01-					Hatchback Engine K9K712	GC050052	Outer Joint	44T	23	30	57.5	86.5	58.5 I
1.6 (66 kW)	1998.09-2005.05				F	Hatchback Engine K7M744/K7M745	GC050004	Outer Joint	26T	21	30	52.2	85.5	59 I
	1998.09-2005.05	AT	L	F	Hatchback Engine K7M744/K7M745	GDS99169	Drive Shaft	26T	21	26	52.2	85.5	621	
	1998.09-2005.05	AT	L	F	Hatchback Engine K7M744/K7M745	GDS99242	Drive Shaft	44T	21	26	52.2	85.5	621	
	1998.09-2005.05	MT	L	F	Hatchback Engine K7M744/K7M745	GDS99073	Drive Shaft	44T	21	29.95	57	84.5	628	
	1998.09-2005.05	MT	L	F	Hatchback Engine K7M744/K7M745	GDS50150	Drive Shaft		21	29.95	49.8	83.5	623	
	1998.09-2005.05	MT	L	F	Hatchback Engine K7M744/K7M745	GDS50004	Drive Shaft	26T	21	29.95	57	84.5	625.7	
	1998.09-2005.05	AT	R	F	Hatchback Engine K7M744/K7M745	GDS50486	Drive Shaft	26T	21	23	52.2	85.5	733	
	1998.09-2005.05	MT	R	F	Hatchback Engine K7M744/K7M745	GDS50250	Drive Shaft	26T	21	23	57	84.5	732.5	
	1998.09-2005.05	MT	R	F	Hatchback Engine K7M744/K7M745	GDS50365	Drive Shaft	44T	21	23	52.2	85.5	723	
	1998.09-2005.05	MT	R	F	Hatchback Engine K7M744/K7M745	GCI50058	Inner Joint		23	22	36.3	40	64.5	
	1998.09-2005.05	MT	R	F	Hatchback Engine K7M744/K7M745	GDS50395	Drive Shaft	26T	21	23	51.5	83	728	
	1998.09-2005.05	MT	R	F	Hatchback Engine K7M744/K7M745	GDS50151	Drive Shaft		21	23	49.8	83.5	712	
	1998.09-2005.05	MT	R	F	Hatchback Engine K7M744/K7M745	GDS50437	Drive Shaft		21	23	51.5	83	729	
	1998.09-2005.05	MT	R	F	Hatchback Engine K7M744/K7M745	GDS50017	Drive Shaft	26T	21	23	51.5	83	715	
	1998.09-2005.05			R	F	Hatchback Engine K7M744/K7M745	GDS99150	Drive Shaft	26T	21	23	52.2	85.5	747
1.9 D (47 kW)	1998.09-2005.05	MT			F	Hatchback Engine F8Q630	GC050004	Outer Joint	26T	21	30	52.2	85.5	59 I
	1998.09-2005.05	MT	L	F	Hatchback Engine F8Q630	GDS50177	Drive Shaft		21	29.95	57	84.5	625.7	
	1998.09-2005.05	MT	L	F	Hatchback Engine F8Q630	GDS50397	Drive Shaft		21	29.95	50	84	632	
	1998.09-2005.05	MT	R	F	Hatchback Engine F8Q630	GDS50146	Drive Shaft		21	23	57	84.5	732.5	
	1998.09-2005.05	MT	R	F	Hatchback Engine F8Q630	GDS50250	Drive Shaft	26T	21	23	57	84.5	732.5	
	1998.09-2005.05	MT	R	F	Hatchback Engine F8Q630	GCI50058	Inner Joint		23	22	36.3	40	64.5	
	1998.09-2005.05	MT	R	F	Hatchback Engine F8Q630	GC050034	Outer Joint		21	22	51.5	83	56.5 O	
	1998.09-2005.05	MT	R	F	Hatchback Engine F8Q630	GDS50336	Drive Shaft	26T	21	23	57	84	727	
	1998.09-2005.05	MT	R	F	Hatchback Engine F8Q630	GDS50395	Drive Shaft	26T	21	23	51.5	83	728	
	1998.09-2005.05	MT	R	F	Hatchback Engine F8Q630	GDS50063	Drive Shaft		21	23	51.5	83	720	
	1998.09-2005.05	MT	R	F	Hatchback Engine F8Q630	GDS50151	Drive Shaft		21	23	49.8	83.5	712	
	1998.09-2005.05	MT	R	F	Hatchback Engine F8Q630	GDS50437	Drive Shaft		21	23	51.5	83	729	
	1998.09-2005.05	MT	R	F	Hatchback Engine F8Q630	GDS50017	Drive Shaft	26T	21	23	51.5	83	715	
	1998.09-2005.05	MT	R	F	Hatchback Engine F8Q630	GDS50177	Drive Shaft		21	29.95	57	84.5	625.7	
1.9 D (48 kW)	2000.02-2001.05	MT	L	F	Hatchback Engine F8Q632	GDS50177	Drive Shaft		21	29.95	57	84.5	625.7	
	2000.02-2001.05			R	F	Hatchback Engine F8Q632	GCI50058	Inner Joint		23	22	36.3	40	64.5
	2000.02-2001.05	MT	R	F	Hatchback Engine F8Q632	GC050034	Outer Joint		21	22	51.5	83	56.5 O	
1.9 DTi (59 kW)	1999.12-2005.05				F	Hatchback Engine F9Q780	GC050004	Outer Joint	26T	21	30	52.2	85.5	59 I
	1999.12-2005.05	MT	L	F	Hatchback Engine F9Q780	GDS50177	Drive Shaft		21	29.95	57	84.5	625.7	
	1999.12-2005.05	MT	L	F	Hatchback Engine F9Q780	GDS50397	Drive Shaft		21	29.95	50	84	632	
	1999.12-2005.05	MT	R	F	Hatchback Engine F9Q780	GDS50146	Drive Shaft		21	23	57	84.5	732.5	
	1999.12-2005.05	MT	R	F	Hatchback Engine F9Q780	GDS50250	Drive Shaft	26T	21	23	57	84.5	732.5	
	1999.12-2005.05	MT	R	F	Hatchback Engine F9Q780	GDS50395	Drive Shaft	26T	21	23	51.5	83	728	
	1999.12-2005.05	MT	R	F	Hatchback Engine F9Q780	GDS50437	Drive Shaft		21	23	51.5	83	729	
2.0 16V Sport (132 kW)	2005.05-2005.11	MT	L	F	Hatchback Engine F4R738	GDS50504	Drive Shaft	44T	23		57.5	86	648	
	2005.05-2005.11			R	F	Hatchback Engine F4R738	GDS99217	Drive Shaft	44T	23	23	57.5	86	733
	2005.05-2005.11	MT	R	F	Hatchback Engine F4R738	GDS50505	Drive Shaft	44T	23	23	57.5	86	733	
<b>CLIO II (SB0/1/2_ )</b>														
1.5 DCi (48 kW)	2001.06-				F	Box Engine K9K700/K9K704	GC050004	Outer Joint	26T	21	30	52.2	85.5	59 I
	2001.06-		MT	L	F	Box Engine K9K700/K9K704	GDS50397	Drive Shaft		21	29.95	50	84	632
	2001.06-		MT	R	F	Box Engine K9K700/K9K704	GDS50395	Drive Shaft	26T	21	23	51.5	83	728





		TRANSM	L/R	F/R		G-AP Ref.	PRODUCT	ABS	Technical Specifications								
									YEAR	A	B	C	H	L	P		
<b>RENAULT CLIO II (SB0/1/2_)</b>																	
1.5 DCi (48 kW)	2001.06-		MT	R	F	Box Engine K9K700/K9K704	GDS50437	Drive Shaft		21	23	51.5	83	729			
	2001.06-		MT	L	F	Box Engine K9K700/K9K704	GDS50177	Drive Shaft		21	29.95	57	84.5	625.7			
	2001.06-		MT	L	F	Box Engine K9K700/K9K704	GDS99073	Drive Shaft	44T	21	29.95	57	84.5	628			
	2001.06-		MT	R	F	Box Engine K9K700/K9K704	GDS50146	Drive Shaft		21	23	57	84.5	732.5			
	2001.06-		MT	R	F	Box Engine K9K700/K9K704	GDS50250	Drive Shaft	26T	21	23	57	84.5	732.5			
1.5 DCi (50 kW)	2004.04-		MT	L	F	Box Engine K9K714	GDS50177	Drive Shaft		21	29.95	57	84.5	625.7			
	2004.04-		MT	L	F	Box Engine K9K714	GDS99073	Drive Shaft	44T	21	29.95	57	84.5	628			
	2004.04-		MT	R	F	Box Engine K9K714	GDS50146	Drive Shaft		21	23	57	84.5	732.5			
	2004.04-		MT	R	F	Box Engine K9K714	GDS50250	Drive Shaft	26T	21	23	57	84.5	732.5			
	2004.04-		MT	R	F	Box Engine K9K714	GDS50364	Drive Shaft	44T	23	26	57.5	86.5	866			
	2004.04-		MT			Box Engine K9K714	GC050052	Outer Joint	44T	23	30	57.5	86.5	58.5	I		
1.9 D (48 kW)	2000.02-	2001.05	MT	L	F	Box Engine F8Q632	GDS50177	Drive Shaft		21	29.95	57	84.5	625.7			
	2000.02-	2001.05	MT	R	F	Box Engine F8Q632	GC050034	Outer Joint		21	22	51.5	83	56.5	O		
<b>CLIO III (BR0/1, CR0/1)</b>																	
1.2 16V (48 kW)	2005.06-				F	Hatchback Engine D4F740	GC050112	Outer Joint		23	28	49	83.5	54.5	I		
	2005.06-				L	Hatchback Engine D4F740	GDS50369	Drive Shaft		23	26	49	83.5	651			
	2005.06-				R	Hatchback Engine D4F740	GDS50372	Drive Shaft		23	26	49	83.5	890			
	2005.06-		MT				GC050112	Outer Joint		23	28	49	83.5	54.5	I		
1.2 16V (55 kW)	2005.06-		MT				GC050112	Outer Joint		23	28	49	83.5	54.5	I		
	2005.08-	2006.04			F	Hatchback Engine D4F740	GC050112	Outer Joint		23	28	49	83.5	54.5	I		
	2005.08-	2006.04			L	Hatchback Engine D4F740	GDS50369	Drive Shaft		23	26	49	83.5	651			
	2005.08-	2006.04			R	Hatchback Engine D4F740	GDS50372	Drive Shaft		23	26	49	83.5	890			
1.2 16V (58 kW)	2005.06-		MT				GC050112	Outer Joint		23	28	49	83.5	54.5	I		
	2006.10-				F	Hatchback Engine D4F764	GC050112	Outer Joint		23	28	49	83.5	54.5	I		
	2006.10-				L	Hatchback Engine D4F764	GDS50369	Drive Shaft		23	26	49	83.5	651			
	2006.10-				R	Hatchback Engine D4F764	GDS50372	Drive Shaft		23	26	49	83.5	890			
1.2 16V (74 kW)	2005.06-		MT				GC050112	Outer Joint		23	28	49	83.5	54.5	I		
	2007-	2010			MX		GC050092	Outer Joint		23	29	49	86	57	I		
	2007.04-		AT		F	Hatchback Engine D4F784	GC050112	Outer Joint		23	28	49	83.5	54.5	I		
1.2 16V (76 kW)	2007-	2010			MX	GC050092	Outer Joint		23	29	49	86	57	I			
1.2 16V Hi-Flex (55 kW)	2008.07-				F	Hatchback Engine D4F740/D4F742	GC050112	Outer Joint		23	28	49	83.5	54.5	I		
	2008.07-				L	Hatchback Engine D4F740/D4F742	GDS50369	Drive Shaft		23	26	49	83.5	651			
	2008.07-				R	Hatchback Engine D4F740/D4F742	GDS50372	Drive Shaft		23	26	49	83.5	890			
1.4 16V (70 kW)	2005.06-					GC050092	Outer Joint		23	29	49	86	57	I			
1.4 16V (72 kW)	2005.06-				F	Hatchback Engine K4J780	GC050092	Outer Joint		23	29	49	86	57	I		
	2005.06-				L	Hatchback Engine K4J780	GDS50353	Drive Shaft		23	26	49	86	649			
	2005.06-				R	Hatchback Engine K4J780	GDS50354	Drive Shaft		23	26	49	86	897			
	2005.06-						GC050092	Outer Joint		23	29	49	86	57	I		
1.5 DCi (47 kW)	2005.06-				F	Hatchback Engine K9K752	GC050143	Outer Joint		25	32	52.8	85.5	62.5	I		
	2005.06-				L	Hatchback Engine K9K752	GDS50353	Drive Shaft		23	26	49	86	649			
	2005.06-				R	Hatchback Engine K9K752	GDS50354	Drive Shaft		23	26	49	86	897			
1.5 DCi (48 kW)	2005.05-				F	Hatchback Engine K9K752	GC050143	Outer Joint		25	32	52.8	85.5	62.5	I		
	2005.05-				L	Hatchback Engine K9K752	GDS50353	Drive Shaft		23	26	49	86	649			
	2005.05-				R	Hatchback Engine K9K752	GDS50354	Drive Shaft		23	26	49	86	897			
1.5 DCi (50 kW)	2005.06-						GC050092	Outer Joint		23	29	49	86	57	I		
	2005.08-	2007.04			F	Hatchback Engine K9K714/K9K768	GC050092	Outer Joint		23	29	49	86	57	I		
	2005.08-	2007.04			L	Hatchback Engine K9K714/K9K768	GDS50353	Drive Shaft		23	26	49	86	649			
	2005.08-	2007.04			R	Hatchback Engine K9K714/K9K768	GDS50354	Drive Shaft		23	26	49	86	897			
1.5 DCi (60 kW)	2007.11-				F	Hatchback Engine K9K750	GC050143	Outer Joint		25	32	52.8	85.5	62.5	I		
	2007.11-				L	Hatchback Engine K9K750	GDS50353	Drive Shaft		23	26	49	86	649			
	2007.11-				R	Hatchback Engine K9K750	GDS50354	Drive Shaft		23	26	49	86	897			
1.5 DCi (63 kW)	2005.06-						GC050092	Outer Joint		23	29	49	86	57	I		
	2005.08-	2006.07			F	Hatchback Engine K9K766	GC050092	Outer Joint		23	29	49	86	57	I		
	2005.08-	2006.07			L	Hatchback Engine K9K766	GDS50353	Drive Shaft		23	26	49	86	649			
	2005.08-	2006.07			R	Hatchback Engine K9K766	GDS50354	Drive Shaft		23	26	49	86	897			
1.5 DCi (76 kW)	2005.06-				F	Hatchback Engine K9K772	GC050143	Outer Joint		25	32	52.8	85.5	62.5	I		
	2005.06-				L	Hatchback Engine K9K772	GDS50353	Drive Shaft		23	26	49	86	649			
	2005.06-				R	Hatchback Engine K9K772	GDS50354	Drive Shaft		23	26	49	86	897			
	2005.06-				L	Hatchback Engine K9K772	GDS50379	Drive Shaft		25	26	52.8	85.5	650			
	2005.06-				R	Hatchback Engine K9K772	GDS50483	Drive Shaft		25	26	52.8	85.5	891			
	2005.06-						GC050143	Outer Joint		25	32	52.8	85.5	62.5	I		
1.5 DCi (78 kW)	2005.08-	2007.04			F	Hatchback Engine K9K764	GC050143	Outer Joint		25	32	52.8	85.5	62.5	I		









		TRANSM	L/R	F/R		G-AP Ref.	PRODUCT	ABS	Technical Specifications								
									YEAR	A	B	C	H	L	P		
<b>RENAULT</b>																	
<b>CLIO III (BR0/1, CR0/1)</b>																	
1.5 DCi (78 kW)	2005.08-	2007.04			L	F	Hatchback Engine K9K764	GDS50379	Drive Shaft	25	26	52.8	85.5	650			
	2005.08-	2007.04			R	F	Hatchback Engine K9K764	GDS50483	Drive Shaft	25	26	52.8	85.5	891			
1.6 16V (65 kW)	2005.06-					F	Hatchback Engine K4M804	GC099085	Outer Joint	23	30	49	86	59	I		
	2005.06-				L	F	Hatchback Engine K4M804	GDS50353	Drive Shaft	23	26	49	86	649			
	2005.06-						MT/AT		GC099085	Outer Joint	23	30	49	86	59	I	
1.6 16V (82 kW)	2005.06-						MT/AT		GC099085	Outer Joint	23	30	49	86	59	I	
	2005.08-	2007.07	5MT			F	Hatchback Engine K4M800/K4M801	GC099085	Outer Joint	23	30	49	86	59	I		
	2005.08-	2007.07			L	F	Hatchback Engine K4M800/K4M801	GDS50353	Drive Shaft	23	26	49	86	649			
	2005.08-	2007.07			R	F	Hatchback Engine K4M800/K4M801	GDS50354	Drive Shaft	23	26	49	86	897			
	2005.08-	2007.07			R	F	Hatchback Engine K4M800/K4M801	GDS50443	Drive Shaft	23	23	49	86	789			
1.6 16V (94 kW)	2005.06-						MT/AT		GC099085	Outer Joint	23	30	49	86	59	I	
1.6 16V GT (94 kW)	2009.06-				R	F	Hatchback Engine K4M862	GDS50483	Drive Shaft	25	26	52.8	85.5	891			
2.0 16V (102 kW)	2006.09-								GC050124	Outer Joint	25	22	52.6	88	55	I	
	2006.10-				MT	L	F	Hatchback Engine M4R700/M4R701	GDS50468	Drive Shaft	27	26	56.7	88.5	689		
	2006.10-				MT	R	F	Hatchback Engine M4R700/M4R701	GDS50467	Drive Shaft	27	26	56.7	88.5	940		
2.0 16V Sport (145 kW)	2006.05-								GC050152	Outer Joint	27	33	56.7	87	62	I	
2.0 16V Sport (148 kW)	2008.09-									GC050152	Outer Joint	27	33	56.7	87	62	I
<b>CLIO IV</b>																	
0.9 TCE (66 kW)	2012.11-				MT	R	F	Hatchback	GDS50563	Drive Shaft	23	26	49	86	909		
1.2 16V (54 kW)	2012.11-				MT	L	F	Hatchback Engine D4F740	GDS50490	Drive Shaft	23	26	49	86	666		
	2012.11-				MT	R	F	Hatchback Engine D4F740	GDS50488	Drive Shaft	23	26	49	86	908		
1.5 DCi (55 kW)	2012.11-				MT	L	F	Hatchback Engine K9K612	GDS50487	Drive Shaft	23	26	49	86	662		
	2012.11-				MT	R	F	Hatchback Engine K9K612	GDS50489	Drive Shaft	23	26	49	86	910		
1.5 DCi (66 kW)	2012.11-				MT	L	F	Hatchback Engine K9K608	GDS50487	Drive Shaft	23	26	49	86	662		
	2012.11-				MT	R	F	Hatchback Engine K9K608	GDS50489	Drive Shaft	23	26	49	86	910		
<b>CLIO MK II (BB0/1/2_, CB0/1/2_)</b>																	
1.6 (81 kW)	1995-06-26 02:38:24	2009.02	AT		L	F	Hatchback Engine K4M 748	GDS99169	Drive Shaft	26T	21	26	52.2	85.5	621		
	1995-06-26 02:38:24	2009.02	AT		L	F	Hatchback Engine K4M 748	GDS99242	Drive Shaft	44T	21	26	52.2	85.5	621		
	1995-06-26 02:38:24	2009.02	MT		L	F	Hatchback Engine K4M 748	GDS99073	Drive Shaft	44T	21	29.95	57	84.5	628		
	1995-06-26 02:38:24	2009.02	AT		R	F	Hatchback Engine K4M 748	GDS50486	Drive Shaft	26T	21	23	52.2	85.5	733		
	1995-06-26 02:38:24	2009.02	MT		R	F	Hatchback Engine K4M 748	GDS50250	Drive Shaft	26T	21	23	57	84.5	732.5		
	1995-06-26 02:38:24	2009.02	MT		R	F	Hatchback Engine K4M 748	GDS50365	Drive Shaft	44T	21	23	52.2	85.5	723		
	1995-06-26 02:38:24	2009.02	MT		R	F	Hatchback Engine K4M 748	GDS50410	Drive Shaft	26T	21	23	52.2	85.5	723		
1.6 Flex (81 kW)	1995-06-22 01:12:00	2006.12	AT		L	F	Hatchback	GDS99169	Drive Shaft	26T	21	26	52.2	85.5	621		
	1995-06-22 01:12:00	2006.12	AT		L	F	Hatchback	GDS99242	Drive Shaft	44T	21	26	52.2	85.5	621		
	1995-06-22 01:12:00	2006.12	MT		L	F	Hatchback	GDS99073	Drive Shaft	44T	21	29.95	57	84.5	628		
	1995-06-22 01:12:00	2006.12	AT		R	F	Hatchback	GDS50486	Drive Shaft	26T	21	23	52.2	85.5	733		
	1995-06-22 01:12:00	2006.12	MT		R	F	Hatchback	GDS50250	Drive Shaft	26T	21	23	57	84.5	732.5		
	1995-06-22 01:12:00	2006.12	MT		R	F	Hatchback	GDS50365	Drive Shaft	44T	21	23	52.2	85.5	723		
<b>ESPACE (J11_)</b>																	
2.0 (80 kW)	1984.07-	1990.12				F	MPV Engine J6R234/J6R236	GC050007	Outer Joint	23	25	56.3	80.5	56	O		
	1984.07-	1990.12	MT	L/R		F	MPV Engine J6R234/J6R236	GDS50030	Drive Shaft	23	23	56.3	80.5	697			
2.1 TD (65 kW)	1984.10-	1990.12				F	MPV Engine J8S240/J8S774	GC050007	Outer Joint	23	25	56.3	80.5	56	O		
	1984.10-	1990.12	MT	L/R		F	MPV Engine J8S240/J8S774	GDS50030	Drive Shaft	23	23	56.3	80.5	697			
<b>ESPACE II (J/S63_)</b>																	
2.0 (76 kW)	1991.01-	1996.10				F	MPV Engine J7R768	GC050007	Outer Joint	23	25	56.3	80.5	56	O		
	1991.01-	1996.10	MT/AT	L/R		F	MPV Engine J7R768	GDS50031	Drive Shaft	48T	23	23	56	85	720		
	1991.01-	1996.10	MT/AT	L/R		F	MPV Engine J7R768	GDS50052	Drive Shaft	23	23	56.3	80.5	713			
2.1 RTDT QuaDra (65 kW)	1991.01-	1992.05								GC050007	Outer Joint	23	25	56.3	80.5	56	O
2.1 TD (65 kW)	1991.01-	1996.10				F	MPV Engine J8S772/J8S776/J8S778/J8S610	GC050007	Outer Joint	23	25	56.3	80.5	56	O		
	1991.01-	1996.10	MT/AT	L/R		F	MPV Engine J8S772/J8S776/J8S778/J8S610	GDS50031	Drive Shaft	48T	23	23	56	85	720		
	1991.01-	1996.10	MT/AT	L/R		F	MPV Engine J8S772/J8S776/J8S778/J8S610	GDS50052	Drive Shaft	23	23	56.3	80.5	713			
2.1 TD (66 kW)	1994.11-	1996.10				F	MPV Engine J8S612	GC050007	Outer Joint	23	25	56.3	80.5	56	O		
2.2 (79 kW)	1991.01-	1996.10				F	MPV Engine J7T773/J7T776/J7T772	GC050007	Outer Joint	23	25	56.3	80.5	56	O		
	1991.01-	1996.10	MT/AT	L/R		F	MPV Engine J7T773/J7T776/J7T772	GDS50031	Drive Shaft	48T	23	23	56	85	720		
	1991.01-	1996.10	MT/AT	L/R		F	MPV Engine J7T773/J7T776/J7T772	GDS50052	Drive Shaft	23	23	56.3	80.5	713			
2.2 4x4 (79 kW)	1991.03-	1996.12								GC050007	Outer Joint	23	25	56.3	80.5	56	O
	1991.03-	1996.12	MT/AT	L/R		F	MPV Engine J7T772/J7T773	GDS50031	Drive Shaft	48T	23	23	56	85	720		
	1991.03-	1996.12	MT/AT	L/R						GDS50052	Drive Shaft	23	23	56.3	80.5	713	
2.8 V6 (110 kW)	1991.01-	1996.10				F	MPV Engine Z7W712/Z7W713/Z7W717	GC050007	Outer Joint	23	25	56.3	80.5	56	O		



		TRANSM	L/R	F/R		G-AP Ref.	PRODUCT	ABS	Technical Specifications						
									YEAR	A	B	C	H	L	P
<b>RENAULT</b>															
<b>ESPACE III (JE0_)</b>															
1.9 DTi (72 kW)	1999.02-	2002.10			F	MPV Engine F9Q722	GC050035	Outer Joint		27	25	64	89	60	O
	1999.02-	2002.10			F	MPV Engine F9Q722	GC050065	Outer Joint	44T	27	25	64	89	60	O
	1999.02-	2002.10	MT	L	F	MPV Engine F9Q722	GDS50221	Drive Shaft	44T	27	29.95	64	89	729	
	1999.02-	2002.10	MT	R	F	MPV Engine F9Q722	GDS50223	Drive Shaft	44T	27	23	64	89	773	
2.0 (102 kW)	2001.09-	2002.10				MPV Engine F4R700/F4R701	GC050089	Outer Joint	44T	27	32	65	88.5	62.5	I
	2001.09-	2002.10			F	MPV Engine F4R700/F4R701	GC050035	Outer Joint		27	25	64	89	60	O
	2001.09-	2002.10			F	MPV Engine F4R700/F4R701	GC050065	Outer Joint	44T	27	25	64	89	60	O
	2001.09-	2002.10	MT	L	F	MPV Engine F4R700/F4R701	GDS50221	Drive Shaft	44T	27	29.95	64	89	729	
	2001.09-	2002.10	MT	R	F	MPV Engine F4R700/F4R701	GDS50211	Drive Shaft	44T	27	23	65	88.5	772	
2.0 16V (103 kW)	1998.10-	2002.10			F	MPV Engine F4R700/F4R701	GC050035	Outer Joint		27	25	64	89	60	O
	1998.10-	2002.10			F	MPV Engine F4R700/F4R701	GC050065	Outer Joint	44T	27	25	64	89	60	O
	1998.10-	2002.10	MT	L	F	MPV Engine F4R700/F4R701	GDS50221	Drive Shaft	44T	27	29.95	64	89	729	
	1998.10-	2002.10	MT	R	F	MPV Engine F4R700/F4R701	GDS50211	Drive Shaft	44T	27	23	65	88.5	772	
	1998.10-	2002.10				MPV Engine F4R700/F4R701	GC050089	Outer Joint	44T	27	32	65	88.5	62.5	I
2.2 12V TD (83 kW)	1996.11-	2000.10	MT	R	F	MPV Engine G8T714/G8T716/G8T760	GDS50019	Drive Shaft	44T	27	39	64	89	978	
	1996.11-	2000.10	MT	L	F	MPV Engine G8T714/G8T716/G8T760	GDS50200	Drive Shaft	44T	27	37.1	64	89	619	
2.2 DCi (85 kW)	2000.07-	2002.10			L	MPV Engine G9T710	GDS50225	Drive Shaft	44T	27	37.1	64	90	594	
	2000.07-	2002.10	MT	L	F	MPV Engine G9T710	GDS50367	Drive Shaft	44T	27	37.1	64	89	599	
	2000.07-	2002.10			R	MPV Engine G9T710	GDS50272	Drive Shaft	44T	27	39	64	90	1010	
2.2 DCi (95 kW)	2000.10-	2002.10	5MT		F	MPV Engine G9T642/G9T710	GC050035	Outer Joint		27	25	64	89	60	O
	2000.10-	2002.10	5MT		F	MPV Engine G9T642/G9T710	GC050065	Outer Joint	44T	27	25	64	89	60	O
	2000.10-	2002.10			L	MPV Engine G9T642/G9T710	GDS50225	Drive Shaft	44T	27	37.1	64	90	594	
	2000.10-	2002.10	MT	L	F	MPV Engine G9T642/G9T710	GDS50367	Drive Shaft	44T	27	37.1	64	89	599	
	2000.10-	2002.10			R	MPV Engine G9T642/G9T710	GDS50272	Drive Shaft	44T	27	39	64	90	1010	
3.0 V6 24V (140 kW)	1998.10-	2002.10				MPV Engine L7X727	GC050057	Outer Joint	44T	27	27	64	90	68	I
	1998.10-	2002.10			F	MPV Engine L7X727	GC050035	Outer Joint		27	25	64	89	60	O
	1998.10-	2002.10			F	MPV Engine L7X727	GC050065	Outer Joint	44T	27	25	64	89	60	O
<b>ESPACE IV (JK0/1)</b>															
1.9 DCi (85 kW)	2002.11-	2005.02					GC050041	Outer Joint		27	37	56.5	93	72	I
1.9 DCi (88 kW)	2002.11-	2005.02					GC050041	Outer Joint		27	37	56.5	93	72	I
2.0 (125 kW)	2006.01-						GC050108	Outer Joint		27	35	56.5	90.5	71	I
2.0 (98 kW)	2006.01-						GC050108	Outer Joint		27	35	56.5	90.5	71	I
2.0 Turbo (120 kW)	2002.11-						GC050041	Outer Joint		27	37	56.5	93	72	I
2.2 DCi (110 kW)	2002.11-						GC050041	Outer Joint		27	37	56.5	93	72	I
3.0 DCi (130 kW)	2002.11-						GC050041	Outer Joint		27	37	56.5	93	72	I
3.0 DCi (133 kW)	2002.11-						GC050041	Outer Joint		27	37	56.5	93	72	I
3.5 V6 (177 kW)	2002.11-						GC050041	Outer Joint		27	37	56.5	93	72	I
<b>ESPACE IV (JK0/1_)</b>															
1.9 DCi (85 kW)	2003.04-	2005.02			L	F	MPV Engine F9Q820	GDS50390	Drive Shaft		27	37.1	56.5	92	659
	2003.04-	2005.02			R	F	MPV Engine F9Q820	GDS50391	Drive Shaft		27	39	56.5	92	995
1.9 DCi (88 kW)	2002.11-				L	F	MPV Engine F9Q680/F9Q820/F9Q826	GDS50390	Drive Shaft		27	37.1	56.5	92	659
	2002.11-				R	F	MPV Engine F9Q680/F9Q820/F9Q826	GDS50391	Drive Shaft		27	39	56.5	92	995
2.0 (100 kW)	2002.11-				L	F	MPV Engine F4R792	GDS50390	Drive Shaft		27	37.1	56.5	92	659
	2002.11-				R	F	MPV Engine F4R792	GDS50391	Drive Shaft		27	39	56.5	92	995
	2002.11-				AT	R	F	MPV Engine F4R792	GDS50454	Drive Shaft		27	26	56.5	92
2.0 (125 kW)	2005.05-	2007.01			L	F	MPV Engine F4R796/797/896/897	GDS50390	Drive Shaft		27	37.1	56.5	92	659
	2005.05-	2007.01			R	F	MPV Engine F4R796/797/896/897	GDS50391	Drive Shaft		27	39	56.5	92	995
2.0 DCi (110 kW)	2006.08-	2007.01	MT	L	F	MPV Engine M9R740/M9R750	GDS50493	Drive Shaft		27	39	56.8	90	663	
2.0 DCi (127 kW)	2006.02-	2007.01	MT	L	F	MPV Engine M9R760/M9R761/M9R762/M9R763	GDS50493	Drive Shaft		27	39	56.8	90	663	
	2006.02-	2007.01	AT	R	F	MPV Engine M9R760/M9R761/M9R762/M9R763	GDS50540	Drive Shaft		27	30	56.5	91	979	
2.0 DCi (96 kW)	2006.08-	2007.01	MT	L	F	MPV Engine M9R802	GDS50493	Drive Shaft		27	39	56.8	90	663	
	2006.08-	2007.01	AT	R	F	MPV Engine M9R802	GDS50540	Drive Shaft		27	30	56.5	91	979	
2.0 Turbo (120 kW)	2002.11-				L	F	MPV Engine F4R794/F4R795/F4R796/F4R797	GDS50390	Drive Shaft		27	37.1	56.5	92	659
	2002.11-				R	F	MPV Engine F4R794/F4R795/F4R796/F4R797	GDS50391	Drive Shaft		27	39	56.5	92	995
2.2 DCi (102 kW)	2006.08-	2007.04			L	F	MPV Engine G9T645	GDS50392	Drive Shaft		27	37.1	56.8	90	619
	2006.08-	2007.04			R	F	MPV Engine G9T645	GDS50393	Drive Shaft		27	39	56.5	92	1035
2.2 DCi (110 kW)	2002.11-				F	MPV Engine G9T742/G9T743	GC050041	Outer Joint		27	37	56.5	93	72	I
	2002.11-				L	F	MPV Engine G9T742/G9T743	GDS50392	Drive Shaft		27	37.1	56.8	90	619
	2002.11-				R	F	MPV Engine G9T742/G9T743	GDS50393	Drive Shaft		27	39	56.5	92	1035
<b>EXPRESS</b>															
-							GC099070	Outer Joint		21	25	46.3	79	58	O

		TRANSM	L/R	F/R		G-AP Ref.	PRODUCT	ABS	Technical Specifications					
									YEAR	A	B	C	H	L
<b>RENAULT</b>														
<b>EXTRA VAN (F40_, G40_)</b>														
1.0 (27 kW)	1986.02-	1992.05	MT	R	F	Box Engine C1C706	GDS50044	Drive Shaft	21	23	46.4	81.5	693.5	
	1986.02-	1992.05	MT	L	F	Box Engine C1C706	GDS50024	Drive Shaft	21	29.95	46.4	81.5	599	
1.2 (40 kW)	1991.09-	1998.03	MT	R	F	Box Engine C3G710/C3G712	GDS50044	Drive Shaft	21	23	46.4	81.5	693.5	
	1991.09-	1998.03	MT	L	F	Box Engine C3G710/C3G712	GDS50024	Drive Shaft	21	29.95	46.4	81.5	599	
1.4 (43 kW)	1985.07-	1991.08	MT	R	F	Box Engine C1J768/C1J780	GDS50044	Drive Shaft	21	23	46.4	81.5	693.5	
	1985.07-	1991.08	MT	L	F	Box Engine C1J768/C1J780	GDS50024	Drive Shaft	21	29.95	46.4	81.5	599	
1.4 (44 kW)	1986.03-	1991.08	MT	R	F	Box Engine C2J784	GDS50044	Drive Shaft	21	23	46.4	81.5	693.5	
	1986.03-	1991.08	MT	L	F	Box Engine C2J784	GDS50024	Drive Shaft	21	29.95	46.4	81.5	599	
1.4 (55 kW)	1991.09-	1998.03	MT	R	F	Box Engine E7J720/E7J724/E7J726/E7J773	GDS50044	Drive Shaft	21	23	46.4	81.5	693.5	
	1991.09-	1998.03	MT	L	F	Box Engine E7J720/E7J724/E7J726/E7J773	GDS50024	Drive Shaft	21	29.95	46.4	81.5	599	
1.4 (58 kW)	1994.01-	1998.03	MT	R	F	Box Engine E7J728	GDS50044	Drive Shaft	21	23	46.4	81.5	693.5	
	1994.01-	1998.03	MT	L	F	Box Engine E7J728	GDS50024	Drive Shaft	21	29.95	46.4	81.5	599	
1.4 (59 kW)	1995.05-	1997.08	MT	R	F	Box Engine E7J773	GDS50044	Drive Shaft	21	23	46.4	81.5	693.5	
	1995.05-	1997.08	AT	L	F	Box Engine E7J773	GDS50201	Drive Shaft	21	29.95	49.8	83.5	597	
	1995.05-	1997.08	MT	L	F	Box Engine E7J773	GDS50024	Drive Shaft	21	29.95	46.4	81.5	599	
1.4 CAT (43 kW)	1988.08-	1998.03	MT	R	F	Box Engine C3J702/C3J700/C3J760/C3J762	GDS50044	Drive Shaft	21	23	46.4	81.5	693.5	
	1988.08-	1998.03	MT	L	F	Box Engine C3J702/C3J700/C3J760/C3J762	GDS50024	Drive Shaft	21	29.95	46.4	81.5	599	
1.6 D (40 kW)	1986.03-	1998.08	MT	R	F	Box Engine F8M730/F8M720/F8M760/F8M736	GDS50044	Drive Shaft	21	23	46.4	81.5	693.5	
	1986.03-	1998.08	MT	L	F	Box Engine F8M730/F8M720/F8M760/F8M736	GDS50024	Drive Shaft	21	29.95	46.4	81.5	599	
1.9 D (40 kW)	1994.09-	1998.03	MT	R	F	Box Engine F8Q640/F8Q682	GDS50044	Drive Shaft	21	23	46.4	81.5	693.5	
	1994.09-	1998.03	MT	L	F	Box Engine F8Q640/F8Q682	GDS50024	Drive Shaft	21	29.95	46.4	81.5	599	
<b>FLUENCE (L30_)</b>														
1.5 DCi (63 kW)	2010.02-		5MT	L	F	Saloon Engine K9K830	GDS50426	Drive Shaft	25	26	52.7	88.5	680	
	2010.02-		5MT	L	F	Saloon Engine K9K830	GCI50096	Inner Joint	26	30	40	64	96	
	2010.02-		5MT	L	F	Saloon Engine K9K830	GC050145	Outer Joint	25	33	52.7	88.5	59.5 I	
1.5 DCi (66 kW)	2010.02-		5MT	L	F	Saloon Engine K9K834	GDS50426	Drive Shaft	25	26	52.7	88.5	680	
1.5 DCi (70 kW)	2014.07-		5MT	L	F	Saloon Engine K9K 826	GDS50426	Drive Shaft	25	26	52.7	88.5	680	
	2014.07-		MT			Saloon Engine K9K 826	GC050163	Outer Joint	25	23	52.4	88.5	61 M	
1.5 DCi (78 kW)	2005.06-		MT			Saloon Engine K9K832	GC050163	Outer Joint	25	23	52.4	88.5	61 M	
1.5 DCi (81 kW)	2010.02-		MT			Saloon Engine K9K836/K9K837	GC050157	Outer Joint	25	33	52.6	89	60 I	
	2010.02-		MT			Saloon Engine K9K836/K9K837	GC050163	Outer Joint	25	23	52.4	88.5	61 M	
1.6 16V (81 kW)	2010.02-		MT	L	F	Saloon Engine K4M838/K4M839	GDS50383	Drive Shaft	25	26	52.7	88.5	688	
	2010.02-		MT	L	F	Saloon Engine K4M838/K4M839	GCI50096	Inner Joint	26	30	40	64	96	
	2010.02-		MT	L	F	Saloon Engine K4M838/K4M839	GC050145	Outer Joint	25	33	52.7	88.5	59.5 I	
	2010.02-			L	F	Saloon Engine K4M838/K4M839	GDS34223	Drive Shaft	25	26	52.7	88.5	685	
	2010.02-			L	F	Saloon Engine K4M838/K4M839	GCI50040	Inner Joint	26	30	43	42.5	83	
	2010.02-			L/R	F	Saloon Engine K4M838/K4M839	GC050145	Outer Joint	25	33	52.7	88.5	59.5 I	
	2010.02-			R	F	Saloon Engine K4M838/K4M839	GDS34222	Drive Shaft	25	23	52.7	88.5	822	
	2010.02-			R	F	Saloon Engine K4M838/K4M839	GCI50084	Inner Joint	23	30	26.5	173	86	
1.6 16V (82 kW)	2010.02-		MT	L	F	Saloon Engine K4M838	GDS50383	Drive Shaft	25	26	52.7	88.5	688	
	2010.02-		MT	L	F	Saloon Engine K4M838	GCI50096	Inner Joint	26	30	40	64	96	
	2010.02-		MT	L	F	Saloon Engine K4M838	GC050145	Outer Joint	25	33	52.7	88.5	59.5 I	
	2010.02-			L	F	Saloon Engine K4M838	GDS34223	Drive Shaft	25	26	52.7	88.5	685	
	2010.02-			L	F	Saloon Engine K4M838	GCI50040	Inner Joint	26	30	43	42.5	83	
	2010.02-			L/R	F	Saloon Engine K4M838	GC050145	Outer Joint	25	33	52.7	88.5	59.5 I	
	2010.02-			R	F	Saloon Engine K4M838	GDS34222	Drive Shaft	25	23	52.7	88.5	822	
2.0 16V (103 kW)	2010.02-		MT			Saloon Engine M4R714/M4R751	GCI50084	Inner Joint	23	30	26.5	173	86	
<b>FUEGO</b>														
1.4/1.6/2.1	1982.08-	1984			L/R		GDS50145	Drive Shaft	23	23	56.3	80	685	
<b>FUEGO (136_)</b>														
2.0 TX/GTX (81 kW)	1980.10-	1985.10	MT		F	Coupe Engine 829710/J6R710/J6R712/J6R713/J6R715/J6R726	GC050007	Outer Joint	23	25	56.3	80.5	56 O	
<b>GRAND MODUS</b>														
1.2 16V (55 kW)	2008-						GC050112	Outer Joint	23	28	49	83.5	54.5 I	
1.2 16V (74 kW)	2008-						GC050092	Outer Joint	23	29	49	86	57 I	
	2008-						GC050112	Outer Joint	23	28	49	83.5	54.5 I	
1.5 DCi (63 kW)	2008-		MT			G. Box: 5 Sp.	GC099085	Outer Joint	23	30	49	86	59 I	
1.5 DCi (76 kW)	2008-		MT			G. Box: 5 Sp.	GC099085	Outer Joint	23	30	49	86	59 I	
1.5 DCi (78 kW)	2008-		MT			G. Box: 5 Sp.	GC099085	Outer Joint	23	30	49	86	59 I	
<b>GRAND SCENIC I (JM0/1)</b>														
1.5 DCi (74 kW)	2004.04-						GC050093	Outer Joint	25	30	52.6	88	58 I	









		TRANSM	L/R	F/R		G-AP Ref.	PRODUCT	ABS	Technical Specifications							
									YEAR	A	B	C	H	L	P	
<b>RENAULT</b>																
<b>GRAND SCENIC I (JM0/1)</b>																
1.5 DCi (78 kW)	2007-	2008				GC050124	Outer Joint		25	22	52.6	88	55	I		
1.6 16V (83 kW)	2004.04-					GC050124	Outer Joint		25	22	52.6	88	55	I		
1.9 DCi (60 kW)	2004.04-					GC099213	Outer Joint		25	33	53	88	61.5	I		
1.9 DCi (68 kW)	2004.04-					GC099213	Outer Joint		25	33	53	88	61.5	I		
1.9 DCi (75 kW)	2004.04-					GC099213	Outer Joint		25	33	53	88	61.5	I		
1.9 DCi (77 kW)	2004.04-					GC099213	Outer Joint		25	33	53	88	61.5	I		
1.9 DCi (81 kW)	2004.04-					GC099213	Outer Joint		25	33	53	88	61.5	I		
1.9 DCi (88 kW)	2004.04-					GC099213	Outer Joint		25	33	53	88	61.5	I		
1.9 DCi (96 kW)	2004.04-					GC099213	Outer Joint		25	33	53	88	61.5	I		
2.0 (120 kW)	2004.04-					GC099213	Outer Joint		25	33	53	88	61.5	I		
2.0 (99 kW)	2004.04-					GC099213	Outer Joint		25	33	53	88	61.5	I		
<b>GRAND SCENIC II (JM0/1_)</b>																
1.5 DCi (74 kW)	2004.07-	2006.10			F	MPV Engine K9K728	GC050093	Outer Joint	25	30	52.6	88	58	I		
	2004.07-	2006.10		L	F	MPV Engine K9K728	GDS50403	Drive Shaft	25	26	52.6	88	674			
	2004.07-	2006.10	MT	L	F	MPV Engine K9K728	GDS50350	Drive Shaft	25	26	52.6	88	668.5			
	2004.07-	2006.10	MT	R	F	MPV Engine K9K728	GDS50495	Drive Shaft	25	26	52.6	88	914			
1.5 DCi (78 kW)	2005.05-		MT	L	F	MPV Engine K9KP732	GDS50350	Drive Shaft	25	26	52.6	88	668.5			
1.6 (77 kW)	2006.06-		MT	R	F	MPV Engine K4M788	GDS50442	Drive Shaft	25	26	52.6	88	911			
1.6 (83 kW)	2004.04-			L	F	MPV Engine K4M761/K4M782	GDS50494	Drive Shaft	25	26	52.6	88	664			
	2004.04-		MT	R	F	MPV Engine K4M761/K4M782	GDS50442	Drive Shaft	25	26	52.6	88	911			
	2004.04-		MT	L	F	MPV Engine K4M761/K4M782	GDS50350	Drive Shaft	25	26	52.6	88	668.5			
	2004.04-		AT	R	F	MPV Engine K4M761/K4M782	GDS50386	Drive Shaft	25	23	52.6	88	806			
1.9 DCi (81 kW)	2005.05-				F	MPV Engine F9QE804	GC099213	Outer Joint	25	33	53	88	61.5	I		
	2005.05-		MT	L	F	MPV Engine F9QE804	GDS99201	Drive Shaft	25	39	53	88	638			
	2005.05-			R	F	MPV Engine F9QE804	GDS50400	Drive Shaft	25	39	53	88	932			
1.9 DCi (88 kW)	2004.04-				F	MPV Engine F9Q812	GC099213	Outer Joint	25	33	53	88	61.5	I		
	2004.04-		MT	L	F	MPV Engine F9Q812	GDS99201	Drive Shaft	25	39	53	88	638			
	2004.04-			R	F	MPV Engine F9Q812	GDS50400	Drive Shaft	25	39	53	88	932			
1.9 DCi (96 kW)	2005.05-	2007.07			F	MPV Engine F9Q816/F9Q818/F9QEE804/F9QJ803	GC099213	Outer Joint	25	33	53	88	61.5	I		
	2005.05-	2007.07	MT	L	F	MPV Engine F9Q816/F9Q818/F9QEE804/F9QJ803	GDS99201	Drive Shaft	25	39	53	88	638			
	2005.05-	2007.07		R	F	MPV Engine F9Q816/F9Q818/F9QEE804/F9QJ803	GDS50400	Drive Shaft	25	39	53	88	932			
2.0 (120 kW)	2004.08-	2006.10			F	MPV Engine F4R776	GC099213	Outer Joint	25	33	53	88	61.5	I		
	2004.08-	2006.10		L	F	MPV Engine F4R776	GDS99186	Drive Shaft	25	26	52.6	88	669			
	2004.08-	2006.10	MT	L	F	MPV Engine F4R776	GDS99201	Drive Shaft	25	39	53	88	638			
	2004.08-	2006.10		R	F	MPV Engine F4R776	GDS50399	Drive Shaft	25	23	52.6	88	803			
	2004.08-	2006.10	MT	R	F	MPV Engine F4R776	GDS50400	Drive Shaft	25	39	53	88	932			
2.0 (99 kW)	2004.04-				F	MPV Engine F4R770/F4R771	GC099213	Outer Joint	25	33	53	88	61.5	I		
	2004.04-			L	F	MPV Engine F4R770/F4R771	GDS99186	Drive Shaft	25	26	52.6	88	669			
	2004.04-		MT	L	F	MPV Engine F4R770/F4R771	GDS99201	Drive Shaft	25	39	53	88	638			
	2004.04-			R	F	MPV Engine F4R770/F4R771	GDS50399	Drive Shaft	25	23	52.6	88	803			
	2004.04-		MT	R	F	MPV Engine F4R770/F4R771	GDS50400	Drive Shaft	25	39	53	88	932			
	2004.04-		AT			MPV Engine F4R770/F4R771	GC050137	Outer Joint	25	32	52.6	88	58	I		
2.0 DCi (110 kW)	2006.07-	2006.10		L	F	MPV Engine M9R700/M9R721/M9R722	GDS50444	Drive Shaft	27	39	56.5	90.5	626			
	2006.07-	2006.10	MT	L	F	MPV Engine M9R700/M9R721/M9R722	GDS18274	Drive Shaft	27	30	56.5	90	624			
	2006.07-	2006.10	MT	R	F	MPV Engine M9R700/M9R721/M9R722	GDS50453	Drive Shaft	27	39	56.5	90.5	973.5			
<b>GRAND SCENIC III (JZ0/1_)</b>																
1.4 16V (96 kW)	2009.02-					MPV Engine H4J700	GC050157	Outer Joint	25	33	52.6	89	60	I		
1.5 DCi (63 kW)	2009.04-		5MT	L	F	MPV Engine K9K830	GDS50426	Drive Shaft	25	26	52.7	88.5	680			
	2009.04-		MT	R	F	MPV Engine K9K830	GDS50425	Drive Shaft	25	26	52.7	88.5	931			
1.5 DCi (70 kW)	2010.11-		5MT	L	F	MPV Engine K9K846	GDS50426	Drive Shaft	25	26	52.7	88.5	680			
	2010.11-		MT	R	F	MPV Engine K9K846	GDS50425	Drive Shaft	25	26	52.7	88.5	931			
1.6 16V (81 kW)	2009.02-		MT	R	F	MPV Engine K4M858	GDS50510	Drive Shaft	25	26	52.4	88.5	929			
1.6 DCi (96 kW)	2011.04-			R	F	MPV Engine R9M402/R9M404	GDS50429	Drive Shaft	27	39	56.5	91.5	956			
1.9 DCi (96 kW)	2009.02-			R	F	MPV Engine F9Q870/F9Q872	GDS50429	Drive Shaft	27	39	56.5	91.5	956			
<b>KANGOO</b>																
-							GC050017	Outer Joint	21	22	51.5	83	56.5	I		
1				R			GDS50293	Drive Shaft	26T	21	23	46.3	80.5	709.5		
1.2	1997-			L			GDS50112	Drive Shaft	26T	21	29.95	57	84.5	630.7		
	1997-			R			GDS50114	Drive Shaft	26T	21	23	57	84.5	724.5		
1.4	1997-			L			GDS50112	Drive Shaft	26T	21	29.95	57	84.5	630.7		
	1997-			R			GDS50114	Drive Shaft	26T	21	23	57	84.5	724.5		



		TRANSM	L/R	F/R		G-AP Ref.	PRODUCT	ABS	Technical Specifications								
									YEAR	A	B	C	H	L	P		
<b>RENAULT KANGOO</b>																	
1.5 DCi	1998-2005		L	F		GDS50363	Drive Shaft	26T	21	29.95	52.2	85.5	630				
	1998-2005		R	F		GDS50162	Drive Shaft	26T	21	23	52.2	85.5	723.5				
1.6						GC050034	Outer Joint		21	22	51.5	83	56.5	O			
						GC050062	Outer Joint	26T	21	22	51.5	83	56.5	O			
						GC050063	Outer Joint	44T	21	22	51.5	83	56.5	O			
1.6 16V	2002-					GC099207	Outer Joint		21	22	46.4	86	58	I			
1.9 D	1997-		L			GDS50112	Drive Shaft	26T	21	29.95	57	84.5	630.7				
	1997-		R			GDS50114	Drive Shaft	26T	21	23	57	84.5	724.5				
<b>KANGOO (KC0/1)</b>																	
1.2 16V (55 kW)	2001.06-					GC050069	Outer Joint	44T	23	30	57.5	86.5	58.5	I			
1.5 DCi (42 kW)	2003.07-					GC050069	Outer Joint	44T	23	30	57.5	86.5	58.5	I			
1.5 DCi (50 kW)	2005.06-					GC050069	Outer Joint	44T	23	30	57.5	86.5	58.5	I			
1.5 DCi (62 kW)	2005.06-					GC050069	Outer Joint	44T	23	30	57.5	86.5	58.5	I			
1.5 DCi (KC07) (48 kW)	2001.12-					GC050069	Outer Joint	44T	23	30	57.5	86.5	58.5	I			
	2001.12-					GC050066	Outer Joint	44T	21	28	52.5	85	51	I			
1.5 DCi (KC08 KC09) (60 kW)	2002.07-					GC050069	Outer Joint	44T	23	30	57.5	86.5	58.5	I			
1.6 16V (70 kW)	2001.06-					GC050004	Outer Joint	26T	21	30	52.2	85.5	59	I			
	2001.06-					GC050066	Outer Joint	44T	21	28	52.5	85	51	I			
1.9 DCi 4WD (59 kW)	2001.10-					GC050082	Outer Joint	44T	23	23	58.8	85	61	M			
1.9 DCi 4WD (62 kW)	2001.10-					GC050082	Outer Joint	44T	23	23	58.8	85	61	M			
1.9 DTi (KC0U) (59 kW)	2000.02-					GC050004	Outer Joint	26T	21	30	52.2	85.5	59	I			
<b>KANGOO (KC0/_)</b>																	
1.2 16V (55 kW)	2001.06-			F	MPV Engine D4F712/D4F714/D4F716	GC050069	Outer Joint	44T	23	30	57.5	86.5	58.5	I			
	2001.06-	MT	L	F	MPV Engine D4F712/D4F714/D4F716	GDS50401	Drive Shaft	44T	21	29.95	57	84	629				
	2001.06-	MT	L	F	MPV Engine D4F712/D4F714/D4F716	GDS50150	Drive Shaft		21	29.95	49.8	83.5	623				
	2001.06-	MT	R	F	MPV Engine D4F712/D4F714/D4F716	GDS50395	Drive Shaft	26T	21	23	51.5	83	728				
	2001.06-	MT	R	F	MPV Engine D4F712/D4F714/D4F716	GDS50357	Drive Shaft	26T	21	23	57	84	718				
	2001.06-	MT	L	F	MPV Engine D4F712/D4F714/D4F716	GDS50177	Drive Shaft		21	29.95	57	84.5	625.7				
	2001.06-	MT	L	F	MPV Engine D4F712/D4F714/D4F716	GDS50411	Drive Shaft	44T	23	29.95	57.5	86.5	631				
	2001.06-	MT	L	F	MPV Engine D4F712/D4F714/D4F716	GDS50523	Drive Shaft	26T	23		58.8	85	641				
	2001.06-		L	F	MPV Engine D4F712/D4F714/D4F716	GDS99073	Drive Shaft	44T	21	29.95	57	84.5	628				
	2001.06-	MT	R	F	MPV Engine D4F712/D4F714/D4F716	GDS50146	Drive Shaft		21	23	57	84.5	732.5				
	2001.06-	MT	R	F	MPV Engine D4F712/D4F714/D4F716	GDS50250	Drive Shaft	26T	21	23	57	84.5	732.5				
	2001.06-	MT	R	F	MPV Engine D4F712/D4F714/D4F716	GDS50339	Drive Shaft		21	23	57	84.5	718.5				
	2001.06-		R	F	MPV Engine D4F712/D4F714/D4F716	GDS99072	Drive Shaft	44T	21	23	57	84.5	720				
	1.5 DCi (42 kW)	2003.07-			F	MPV Engine K9K704	GC050069	Outer Joint	44T	23	30	57.5	86.5	58.5	I		
2003.07-			R	F	MPV Engine K9K704	GDS50245	Drive Shaft	44T	21	23	52.5	85	726				
2003.07-		MT	L	F	MPV Engine K9K704	GDS50177	Drive Shaft		21	29.95	57	84.5	625.7				
2003.07-		MT	L	F	MPV Engine K9K704	GDS99073	Drive Shaft	44T	21	29.95	57	84.5	628				
2003.07-		MT	R	F	MPV Engine K9K704	GDS50146	Drive Shaft		21	23	57	84.5	732.5				
2003.07-		MT	R	F	MPV Engine K9K704	GDS50250	Drive Shaft	26T	21	23	57	84.5	732.5				
1.5 DCi (45 kW)	2005.04-2010.06		R	F	MPV	GDS50245	Drive Shaft	44T	21	23	52.5	85	726				
1.5 DCi (48 kW)	2001.12-			F	MPV Engine K9K700/K9K704	GC050069	Outer Joint	44T	23	30	57.5	86.5	58.5	I			
	2001.12-	MT	L	F	MPV Engine K9K700/K9K704	GDS50398	Drive Shaft		21	29.95	50	84	632				
	2001.12-	MT	L	F	MPV Engine K9K700/K9K704	GDS50356	Drive Shaft	26T	21	29.95	51.5	83	634				
	2001.12-		R	F	MPV Engine K9K700/K9K704	GDS50245	Drive Shaft	44T	21	23	52.5	85	726				
	2001.12-	MT	R	F	MPV Engine K9K700/K9K704	GDS50395	Drive Shaft	26T	21	23	51.5	83	728				
	2001.12-	MT	L	F	MPV Engine K9K700/K9K704	GDS50177	Drive Shaft		21	29.95	57	84.5	625.7				
	2001.12-	MT	L	F	MPV Engine K9K700/K9K704	GDS99073	Drive Shaft	44T	21	29.95	57	84.5	628				
	2001.12-		L	F	MPV Engine K9K700/K9K704	GDS50411	Drive Shaft	44T	23	29.95	57.5	86.5	631				
	2001.12-	MT	R	F	MPV Engine K9K700/K9K704	GDS50146	Drive Shaft		21	23	57	84.5	732.5				
	2001.12-	MT	R	F	MPV Engine K9K700/K9K704	GDS50250	Drive Shaft	26T	21	23	57	84.5	732.5				
	2001.12-	MT	R	F	MPV Engine K9K700/K9K704	GDS50339	Drive Shaft		21	23	57	84.5	718.5				
1.5 DCi (50 kW)	2005.08-			F	MPV Engine K9K714	GC050069	Outer Joint	44T	23	30	57.5	86.5	58.5	I			
	2005.08-	MT	L	F	MPV Engine K9K714	GDS50177	Drive Shaft		21	29.95	57	84.5	625.7				
	2005.08-		L	F	MPV Engine K9K714	GDS50514	Drive Shaft	44T	23	26	57.5	86.5	606				
	2005.08-		L	F	MPV Engine K9K714	GCI50085	Inner Joint		26	33	40	64	123				
	2005.08-		L/R	F	MPV Engine K9K714	GC099087	Outer Joint		23	30	57.5	86.5	58.5	I			
	2005.08-	MT	R	F	MPV Engine K9K714	GDS50146	Drive Shaft		21	23	57	84.5	732.5				
	2005.08-		R	F	MPV Engine K9K714	GDS50515	Drive Shaft	44T	23	26	57.5	86.5	866				
	2005.08-		R	F	MPV Engine K9K714	GCI50086	Inner Joint		26	33	33	326	94				

		YEAR	TRANSM	L/R	F/R		G-AP Ref.	PRODUCT	ABS	Technical Specifications										
										A	B	C	H	L	P					
<b>RENAULT KANGOO (KC0/1_)</b>																				
1.5 DCi (50 kW)	2005.08-		MT			MPV Engine K9K714	GC050052	Outer Joint	44T	23	30	57.5	86.5	58.5	I					
1.5 DCi (60 kW)	2002.07-				F	MPV Engine K9K702/K9K710	GC050069	Outer Joint	44T	23	30	57.5	86.5	58.5	I					
	2002.07-			L	F	MPV Engine K9K702/K9K710	GDS50261	Drive Shaft	44T	23	29.95	57.5	86.5	630						
	2002.07-		MT	L	F	MPV Engine K9K702/K9K710	GDS50394	Drive Shaft		23	29.95	57.5	86.5	631						
	2002.07-		MT	L	F	MPV Engine K9K702/K9K710	GDS50194	Drive Shaft	26T	23	29.95	57.5	86.5	631						
	2002.07-		MT	R	F	MPV Engine K9K702/K9K710	GDS50260	Drive Shaft	44T	23	23	57.5	86.5	724						
	2002.07-		MT	R	F	MPV Engine K9K702/K9K710	GDS50193	Drive Shaft	26T	23	23	57.5	86.5	724						
	2002.07-		MT	L	F	MPV Engine K9K702/K9K710	GDS50411	Drive Shaft	44T	23	29.95	57.5	86.5	631						
1.5 DCi (62 kW)	2005.08-	2007.04		L	F	MPV Engine K9K718	GDS50514	Drive Shaft	44T	23	26	57.5	86.5	606						
	2005.08-	2007.04		L	F	MPV Engine K9K718	GCI50085	Inner Joint		26	33	40	64	123						
	2005.08-	2007.04		L/R	F	MPV Engine K9K718	GC099087	Outer Joint		23	30	57.5	86.5	58.5	I					
	2005.08-	2007.04	MT	R	F	MPV Engine K9K718	GDS50364	Drive Shaft	44T	23	26	57.5	86.5	866						
	2005.08-	2007.04		R	F	MPV Engine K9K718	GDS50515	Drive Shaft	44T	23	26	57.5	86.5	866						
	2005.08-	2007.04		R	F	MPV Engine K9K718	GCI50086	Inner Joint		26	33	33	326	94						
1.6 16V (70 kW)	2001.06-		MT	L	F	MPV Engine K4M750/K4M752/K4M753	GC050150	Outer Joint	44T	21	29.95	49.8	83.5	58.5	I					
	2001.06-		MT	R	F	MPV Engine K4M750/K4M752/K4M753	GDS50395	Drive Shaft	26T	21	23	51.5	83	728						
	2001.06-		MT	R	F	MPV Engine K4M750/K4M752/K4M753	GDS50357	Drive Shaft	26T	21	23	57	84	718						
	2001.06-		AT	L	F	MPV Engine K4M750/K4M752/K4M753	GDS99169	Drive Shaft	26T	21	26	52.2	85.5	621						
	2001.06-		AT	L	F	MPV Engine K4M750/K4M752/K4M753	GDS99242	Drive Shaft	44T	21	26	52.2	85.5	621						
	2001.06-		MT	L	F	MPV Engine K4M750/K4M752/K4M753	GDS50177	Drive Shaft		21	29.95	57	84.5	625.7						
	2001.06-			L	F	MPV Engine K4M750/K4M752/K4M753	GDS50411	Drive Shaft	44T	23	29.95	57.5	86.5	631						
	2001.06-			L	F	MPV Engine K4M750/K4M752/K4M753	GDS50519	Drive Shaft	44T	21	26	52.2	85.5	609						
	2001.06-		AT	R	F	MPV Engine K4M750/K4M752/K4M753	GDS50486	Drive Shaft	26T	21	23	52.2	85.5	733						
	2001.06-		MT	R	F	MPV Engine K4M750/K4M752/K4M753	GDS50146	Drive Shaft		21	23	57	84.5	732.5						
	2001.06-		MT	R	F	MPV Engine K4M750/K4M752/K4M753	GDS50250	Drive Shaft	26T	21	23	57	84.5	732.5						
	2001.06-		MT	R	F	MPV Engine K4M750/K4M752/K4M753	GDS50339	Drive Shaft		21	23	57	84.5	718.5						
	1.6 16V 4x4 (70 kW)	2001.10-			L	F	MPV Engine K4M750/K4M752/K4M753	GDS50506	Drive Shaft	44T	23	29.95	58.8	85	645					
2001.10-				L	F	MPV Engine K4M750/K4M752/K4M753	GDS50519	Drive Shaft	44T	21	26	52.2	85.5	609						
2001.10-			AT	R	F	MPV Engine K4M750/K4M752/K4M753	GDS50525	Drive Shaft	44T	21	23	52.2	85.5	741						
2001.10-				R	F	MPV Engine K4M750/K4M752/K4M753	GDS50527	Drive Shaft	44T	23	23	58.8	85	739						
2001.10-				R	F	MPV Engine K4M750/K4M752/K4M753	GCI50079	Inner Joint		23	22	36.3	50	55.5						
1.9 DCi 4x4 (59 kW)	2001.10-			L	F	MPV Engine F9Q782/F9Q790	GDS50506	Drive Shaft	44T	23	29.95	58.8	85	645						
	2001.10-			R	F	MPV Engine F9Q782/F9Q790	GDS50527	Drive Shaft	44T	23	23	58.8	85	739						
	2001.10-			R	F	MPV Engine F9Q782/F9Q790	GCI50079	Inner Joint		23	22	36.3	50	55.5						
	2001.10-			R	F	MPV Engine F9Q782/F9Q790	GC099283	Outer Joint	44T	23	23	58.8	85	61	M					
1.9 DCi 4x4 (62 kW)	2003.10-		L	F	MPV Engine F9Q790	GDS50506	Drive Shaft	44T	23	29.95	58.8	85	645							
<b>KANGOO / GRAND KANGOO (KW0/1_)</b>																				
1.5 DCi (50 kW)	2008.02-			L	F	MPV Engine K9K800	GDS99228	Drive Shaft		27	26	56.7	91	675						
	2008.02-			R	F	MPV Engine K9K800	GDS99229	Drive Shaft		27	26	56.7	91	920						
	2008.02-			L	F	MPV Engine K9K800	GDS50514	Drive Shaft	44T	23	26	57.5	86.5	606						
	2008.02-			L	F	MPV Engine K9K800	GCI50085	Inner Joint		26	33	40	64	123						
	2008.02-		L/R	F	MPV Engine K9K800	GC099087	Outer Joint		23	30	57.5	86.5	58.5	I						
	2008.02-			R	F	MPV Engine K9K800	GDS50541	Drive Shaft		23	26	49	83.5	913						
1.5 DCi (55 kW)	2008.02-			R	F	MPV Engine K9K800	GCI50086	Inner Joint		26	33	33	326	94						
	2012.11-			L	F	MPV Engine K9K802	GDS99070	Drive Shaft		23	26	49	86	675						
1.5 DCi (63 kW)	2012.11-		MT	R	F	MPV Engine K9K802	GDS50541	Drive Shaft		23	26	49	83.5	913						
	2008.02-			L	F	MPV Engine K9K802	GDS99228	Drive Shaft		27	26	56.7	91	675						
	2008.02-			R	F	MPV Engine K9K802	GDS99229	Drive Shaft		27	26	56.7	91	920						
1.5 DCi (66 kW)	2008.02-		MT	R	F	MPV Engine K9K802	GDS50541	Drive Shaft		23	26	49	83.5	913						
	2012.11-			L	F	MPV Engine K9K808	GDS99070	Drive Shaft		23	26	49	86	675						
1.5 DCi (76 kW)	2012.11-		MT	R	F	MPV Engine K9K808	GDS50541	Drive Shaft		23	26	49	83.5	913						
	2008.02-			L	F	MPV Engine K9K804/K9K806	GDS50423	Drive Shaft		27	26	56.7	91	680						
1.5 DCi (78 kW)	2008.02-		MT	L	F	MPV	GDS50423	Drive Shaft		27	26	56.7	91	680						
1.5 DCi (80 kW)	2010.09-			L	F	MPV Engine RHWK9K800	GDS50423	Drive Shaft		27	26	56.7	91	680						
1.6 (64 kW)	2008.02-			L	F	MPV Engine K7M750	GDS99070	Drive Shaft		23	26	49	86	675						
	2008.02-			L	F	MPV Engine K7M750	GDS99228	Drive Shaft		27	26	56.7	91	675						
	2008.02-			R	F	MPV Engine K7M750	GDS99229	Drive Shaft		27	26	56.7	91	920						
	2008.02-		MT	R	F	MPV Engine K7M750	GDS50541	Drive Shaft		23	26	49	83.5	913						
1.6 16V (78 kW)	2008.02-		L	F	MPV Engine K4M830/K4M831	GDS99228	Drive Shaft		27	26	56.7	91	675							









		TRANSM	L/R	F/R		G-AP Ref.	PRODUCT	ABS	Technical Specifications									
									YEAR	A	B	C	H	L	P			
<b>RENAULT</b>																		
<b>KANGOO / GRAND KANGOO (KW0/1_)</b>																		
1.6 16V (78 kW)	2008.02-			R	F	MPV Engine K4M830/K4M831	GDS99229	Drive Shaft		27	26	56.7	91	920				
1.6 16V Hi-Flex (78 kW)	2008.02-			L	F	MPV Engine K4M850	GDS99228	Drive Shaft		27	26	56.7	91	675				
	2008.02-			R	F	MPV Engine K4M850	GDS99229	Drive Shaft		27	26	56.7	91	920				
<b>KANGOO BE BOP (KW0/1_)</b>																		
1.5 DCi (55 kW)	2010.09-		MT	R	F	MPV Engine K9K802	GDS50541	Drive Shaft		23	26	49	83.5	913				
1.5 DCi (66 kW)	2009.06-			L	F	MPV Engine K9K808	GDS99228	Drive Shaft		27	26	56.7	91	675				
	2009.06-			R	F	MPV Engine K9K808	GDS99229	Drive Shaft		27	26	56.7	91	920				
	2009.06-		MT	R	F	MPV Engine K9K808	GDS50541	Drive Shaft		23	26	49	83.5	913				
1.5 DCi (76 kW)	2009.02-			L	F	MPV Engine K9K806	GDS50423	Drive Shaft		27	26	56.7	91	680				
1.5 DCi (80 kW)	2009.06-		MT	L	F	MPV Engine K9K804	GDS50423	Drive Shaft		27	26	56.7	91	680				
1.6 (78 kW)	2009.02-			L	F	MPV Engine K4M830	GDS99228	Drive Shaft		27	26	56.7	91	675				
	2009.02-			MT	L	F	MPV Engine K4M830	GDS99070	Drive Shaft		23	26	49	86	675			
	2009.02-			R	F	MPV Engine K4M830	GDS99229	Drive Shaft		27	26	56.7	91	920				
<b>KANGOO EXPRESS (FC0/1_)</b>																		
1.2 (44 kW)	1998.07-	2001.07		R	F	Box Engine D7F764/D7F766	GDS50526	Drive Shaft	26T	21	23	52.3	84.5	724				
1.2 16V (55 kW)	2001.10-			R	F	Box Engine D4F712/D4F714/D4F730	GDS99072	Drive Shaft	44T	21	23	57	84.5	720				
	2001.10-		MT	L	F	Box Engine D4F712/D4F714/D4F730	GDS50401	Drive Shaft	44T	21	29.95	57	84	629				
	2001.10-		MT	L	F	Box Engine D4F712/D4F714/D4F730	GDS50150	Drive Shaft		21	29.95	49.8	83.5	623				
	2001.10-		MT	R	F	Box Engine D4F712/D4F714/D4F730	GDS50395	Drive Shaft	26T	21	23	51.5	83	728				
	2001.10-		MT	R	F	Box Engine D4F712/D4F714/D4F730	GDS50357	Drive Shaft	26T	21	23	57	84	718				
	2001.10-		MT	L	F	Box Engine D4F712/D4F714/D4F730	GDS50177	Drive Shaft		21	29.95	57	84.5	625.7				
	2001.10-			L	F	Box Engine D4F712/D4F714/D4F730	GDS99073	Drive Shaft	44T	21	29.95	57	84.5	628				
	2001.10-		MT	R	F	Box Engine D4F712/D4F714/D4F730	GDS50146	Drive Shaft		21	23	57	84.5	732.5				
	2001.10-		MT	R	F	Box Engine D4F712/D4F714/D4F730	GDS50250	Drive Shaft	26T	21	23	57	84.5	732.5				
	2001.10-			MT	R	F	Box Engine D4F712/D4F714/D4F730	GDS50339	Drive Shaft		21	23	57	84.5	718.5			
	1.2 BiFuel (43 kW)	1998.07-	2001.07		R	F	Box Engine D7F710/D7F744	GDS50526	Drive Shaft	26T	21	23	52.3	84.5	724			
1.5 DCi (42 kW)	2002.12-		MT	L	F	Box Engine K9K704	GDS50398	Drive Shaft		21	29.95	50	84	632				
	2002.12-		MT	L	F	Box Engine K9K704	GDS50356	Drive Shaft	26T	21	29.95	51.5	83	634				
	2002.12-			R	F	Box Engine K9K704	GDS50245	Drive Shaft	44T	21	23	52.5	85	726				
	2002.12-		MT	R	F	Box Engine K9K704	GDS50395	Drive Shaft	26T	21	23	51.5	83	728				
	2002.12-		MT	L	F	Box Engine K9K704	GDS50177	Drive Shaft		21	29.95	57	84.5	625.7				
	2002.12-		MT	L	F	Box Engine K9K704	GDS99073	Drive Shaft	44T	21	29.95	57	84.5	628				
	2002.12-		MT	R	F	Box Engine K9K704	GDS50146	Drive Shaft		21	23	57	84.5	732.5				
	2002.12-		MT	R	F	Box Engine K9K704	GDS50250	Drive Shaft	26T	21	23	57	84.5	732.5				
	2002.12-		MT	R	F	Box Engine K9K704	GDS50339	Drive Shaft		21	23	57	84.5	718.5				
1.5 DCi (45 kW)	2005.10-		MT	R	F	Box Engine K9K704/K9K716	GDS50245	Drive Shaft	44T	21	23	52.5	85	726				
1.5 DCi (48 kW)	2001.12-				F	Box Engine K9K700/K9K702/K9K704	GC050069	Outer Joint	44T	23	30	57.5	86.5	58.5	I			
	2001.12-		MT	L	F	Box Engine K9K700/K9K702/K9K704	GDS50398	Drive Shaft		21	29.95	50	84	632				
	2001.12-		MT	L	F	Box Engine K9K700/K9K702/K9K704	GDS50356	Drive Shaft	26T	21	29.95	51.5	83	634				
	2001.12-			R	F	Box Engine K9K700/K9K702/K9K704	GDS50245	Drive Shaft	44T	21	23	52.5	85	726				
	2001.12-		MT	R	F	Box Engine K9K700/K9K702/K9K704	GDS50395	Drive Shaft	26T	21	23	51.5	83	728				
	2001.12-		MT	L	F	Box Engine K9K700/K9K702/K9K704	GDS50177	Drive Shaft		21	29.95	57	84.5	625.7				
	2001.12-		MT	L	F	Box Engine K9K700/K9K702/K9K704	GDS99073	Drive Shaft	44T	21	29.95	57	84.5	628				
	2001.12-			L	F	Box Engine K9K700/K9K702/K9K704	GDS50411	Drive Shaft	44T	23	29.95	57.5	86.5	631				
	2001.12-		MT	R	F	Box Engine K9K700/K9K702/K9K704	GDS50146	Drive Shaft		21	23	57	84.5	732.5				
	2001.12-		MT	R	F	Box Engine K9K700/K9K702/K9K704	GDS50250	Drive Shaft	26T	21	23	57	84.5	732.5				
	2001.12-		MT	R	F	Box Engine K9K700/K9K702/K9K704	GDS50339	Drive Shaft		21	23	57	84.5	718.5				
1.5 DCi (50 kW)	2005.06-		MT	L	F	Box Engine K9K714	GDS50177	Drive Shaft		21	29.95	57	84.5	625.7				
	2005.06-		MT	L	F	Box Engine K9K714	GDS99073	Drive Shaft	44T	21	29.95	57	84.5	628				
	2005.06-			L	F	Box Engine K9K714	GDS50514	Drive Shaft	44T	23	26	57.5	86.5	606				
	2005.06-			L	F	Box Engine K9K714	GC150085	Inner Joint		26	33	40	64	123				
	2005.06-			L/R	F	Box Engine K9K714	GC099087	Outer Joint		23	30	57.5	86.5	58.5	I			
	2005.06-		MT	R	F	Box Engine K9K714	GDS50146	Drive Shaft		21	23	57	84.5	732.5				
	2005.06-		MT	R	F	Box Engine K9K714	GDS50250	Drive Shaft	26T	21	23	57	84.5	732.5				
	2005.06-		MT	R	F	Box Engine K9K714	GDS50364	Drive Shaft	44T	23	26	57.5	86.5	866				
	2005.06-			R	F	Box Engine K9K714	GDS50515	Drive Shaft	44T	23	26	57.5	86.5	866				
	2005.06-			R	F	Box Engine K9K714	GC150086	Inner Joint		26	33	33	326	94				
	2005.06-					Box Engine K9K714	GC050052	Outer Joint	44T	23	30	57.5	86.5	58.5	I			
1.5 DCi (60 kW)	2003.04-			L	F	Box Engine K9K702/K9K710	GDS50261	Drive Shaft	44T	23	29.95	57.5	86.5	630				
	2003.04-		MT	L	F	Box Engine K9K702/K9K710	GDS50401	Drive Shaft	44T	21	29.95	57	84	629				
	2003.04-		MT	L	F	Box Engine K9K702/K9K710	GDS50394	Drive Shaft		23	29.95	57.5	86.5	631				

		TRANSM	L/R	F/R		G-AP Ref.	PRODUCT	ABS	Technical Specifications					
									YEAR	A	B	C	H	L
<b>RENAULT</b>														
<b>KANGOO EXPRESS (FC0/1_)</b>														
1.5 DCi (60 kW)	2003.04-		MT	L	F	Box Engine K9K702/K9K710	GDS50194	Drive Shaft	26T	23	29.95	57.5	86.5	631
	2003.04-		MT	R	F	Box Engine K9K702/K9K710	GDS50260	Drive Shaft	44T	23	23	57.5	86.5	724
	2003.04-		MT	R	F	Box Engine K9K702/K9K710	GDS50193	Drive Shaft	26T	23	23	57.5	86.5	724
	2003.04-		MT	L	F	Box Engine K9K702/K9K710	GDS50411	Drive Shaft	44T	23	29.95	57.5	86.5	631
1.5 DCi (62 kW)	2005.06-			L	F	Box Engine K9K718	GDS50514	Drive Shaft	44T	23	26	57.5	86.5	606
	2005.06-			L	F	Box Engine K9K718	GCI50085	Inner Joint		26	33	40	64	123
	2005.06-			L/R	F	Box Engine K9K718	GC099087	Outer Joint		23	30	57.5	86.5	58.5 I
	2005.06-		MT	R	F	Box Engine K9K718	GDS50364	Drive Shaft	44T	23	26	57.5	86.5	866
	2005.06-			R	F	Box Engine K9K718	GDS50515	Drive Shaft	44T	23	26	57.5	86.5	866
	2005.06-			R	F	Box Engine K9K718	GCI50086	Inner Joint		26	33	33	326	94
	2005.06-					Box Engine K9K718	GC050052	Outer Joint	44T	23	30	57.5	86.5	58.5 I
1.6 16V (70 kW)	2001.10-		MT	L	F	Box Engine K4M752	GDS50150	Drive Shaft		21	29.95	49.8	83.5	623
	2001.10-		MT	R	F	Box Engine K4M752	GDS50395	Drive Shaft	26T	21	23	51.5	83	728
	2001.10-		MT	R	F	Box Engine K4M752	GDS50357	Drive Shaft	26T	21	23	57	84	718
	2001.10-		AT	L	F	Box Engine K4M752	GDS99169	Drive Shaft	26T	21	26	52.2	85.5	621
	2001.10-		AT	L	F	Box Engine K4M752	GDS99242	Drive Shaft	44T	21	26	52.2	85.5	621
	2001.10-		MT	L	F	Box Engine K4M752	GDS50177	Drive Shaft		21	29.95	57	84.5	625.7
	2001.10-			L	F	Box Engine K4M752	GDS50411	Drive Shaft	44T	23	29.95	57.5	86.5	631
	2001.10-			L	F	Box Engine K4M752	GDS50519	Drive Shaft	44T	21	26	52.2	85.5	609
	2001.10-		AT	R	F	Box Engine K4M752	GDS50486	Drive Shaft	26T	21	23	52.2	85.5	733
	2001.10-		MT	R	F	Box Engine K4M752	GDS50146	Drive Shaft		21	23	57	84.5	732.5
	2001.10-		MT	R	F	Box Engine K4M752	GDS50250	Drive Shaft	26T	21	23	57	84.5	732.5
	2001.10-		MT	R	F	Box Engine K4M752	GDS50339	Drive Shaft		21	23	57	84.5	718.5
1.6 16V 4x4 (70 kW)	2001.10-			L	F	Box Engine K4M750/K4M752/K4M753	GDS50519	Drive Shaft	44T	21	26	52.2	85.5	609
1.9 D (48 kW)	1999.09-2003.06		MT	L	F	Box Engine F8Q632	GDS50177	Drive Shaft		21	29.95	57	84.5	625.7
	1999.09-2003.06		MT	L	F	Box Engine F8Q632	GDS99073	Drive Shaft	44T	21	29.95	57	84.5	628
	1999.09-2003.06		MT	R	F	Box Engine F8Q632	GDS50146	Drive Shaft		21	23	57	84.5	732.5
	1999.09-2003.06		MT	R	F	Box Engine F8Q632	GDS50250	Drive Shaft	26T	21	23	57	84.5	732.5
1.9 DCi (62 kW)	2003.07-			L	F	Box Engine F9Q790	GDS50411	Drive Shaft	44T	23	29.95	57.5	86.5	631
1.9 DCi 4x4 (59 kW)	2001.10-			L	F	Box Engine F9Q782/F9Q790	GDS50506	Drive Shaft	44T	23	29.95	58.8	85	645
	2001.10-			R	F	Box Engine F9Q782/F9Q790	GDS50527	Drive Shaft	44T	23	23	58.8	85	739
	2001.10-			R	F	Box Engine F9Q782/F9Q790	GCI50079	Inner Joint		23	22	36.3	50	55.5
	2001.10-			R	F	Box Engine F9Q782/F9Q790	GC099283	Outer Joint	44T	23	23	58.8	85	61 M
1.9 DCi 4x4 (62 kW)	2003.07-			L	F	Box Engine F9Q790	GDS50506	Drive Shaft	44T	23	29.95	58.8	85	645
<b>KANGOO EXPRESS (FW0/1_)</b>														
1.5 DCi (50 kW)	2008.02-			L	F	Box Engine K9K800	GDS99228	Drive Shaft		27	26	56.7	91	675
	2008.02-			R	F	Box Engine K9K800	GDS99229	Drive Shaft		27	26	56.7	91	920
	2008.02-		MT	R	F	Box Engine K9K800	GDS50541	Drive Shaft		23	26	49	83.5	913
1.5 DCi (55 kW)	2010.09-			L	F	Box Engine K9K800/K9K808	GDS99070	Drive Shaft		23	26	49	86	675
	2010.09-		MT	R	F	Box Engine K9K800/K9K808	GDS50541	Drive Shaft		23	26	49	83.5	913
1.5 DCi (63 kW)	2008.02-			L	F	Box Engine K9K800/K9K802	GDS99228	Drive Shaft		27	26	56.7	91	675
	2008.02-			R	F	Box Engine K9K800/K9K802	GDS99229	Drive Shaft		27	26	56.7	91	920
1.5 DCi (66 kW)	2009.06-			L	F	Box Engine K9K808	GDS99228	Drive Shaft		27	26	56.7	91	675
	2009.06-			R	F	Box Engine K9K808	GDS99229	Drive Shaft		27	26	56.7	91	920
	2009.06-		MT	R	F	Box Engine K9K808	GDS50541	Drive Shaft		23	26	49	83.5	913
1.5 DCi (76 kW)	2008.02-			L	F	Box Engine K9K806	GDS50423	Drive Shaft		27	26	56.7	91	680
1.5 DCi (80 kW)	2010.09-			L	F	Box Engine K9K804	GDS50423	Drive Shaft		27	26	56.7	91	680
1.5 DCi 110 (81 kW)	2013.09-		MT	L	F	Box	GDS50423	Drive Shaft		27	26	56.7	91	680
1.6 (64 kW)	2008.02-			L	F	Box Engine K7M750	GDS99070	Drive Shaft		23	26	49	86	675
	2008.02-			L	F	Box Engine K7M750	GDS99228	Drive Shaft		27	26	56.7	91	675
	2008.02-			R	F	Box Engine K7M750	GDS99229	Drive Shaft		27	26	56.7	91	920
	2008.02-		MT	R	F	Box Engine K7M750	GDS50541	Drive Shaft		23	26	49	83.5	913
1.6 16V (78 kW)	2008.02-			L	F	Box Engine K4M830	GDS99228	Drive Shaft		27	26	56.7	91	675
	2008.02-			R	F	Box Engine K4M830	GDS99229	Drive Shaft		27	26	56.7	91	920
1.6 16V LPG (72 kW)	2008.02-			L	F	Box Engine K4M834	GDS99070	Drive Shaft		23	26	49	86	675
	2008.02-			L	F	Box Engine K4M834	GDS99228	Drive Shaft		27	26	56.7	91	675
	2008.02-			R	F	Box Engine K4M834	GDS99229	Drive Shaft		27	26	56.7	91	920
<b>KANGOO I (FC0/1), VAN</b>														
1.9 DTi (59 kW)	2000.02-					FC0U	GC050004	Outer Joint	26T	21	30	52.2	85.5	59 I
<b>KANGOO MPV</b>														
1.2 16V	2002.01-		MT	R			GDS50092	Drive Shaft		21	23	57	84.5	719



		YEAR	TRANSM	L/R	F/R		G-AP Ref.	PRODUCT	ABS	Technical Specifications										
										A	B	C	H	L	P					
<b>RENAULT KANGOO MPV</b>																				
1.4 8V	1999.10-	2003.04	AT	L	F		GDS50216	Drive Shaft	26T		21	26	57	84.5	617					
	1999.10-	2003.04	AT	R	F		GDS50233	Drive Shaft	26T		21	23	57	84.5	737					
1.9 DTi	2001.03-		MT	R			GDS50092	Drive Shaft			21	23	57	84.5	719					
<b>KANGOO VAN</b>																				
1.2	1998.05-	1999.09	MT	L			GDS50018	Drive Shaft			21	29.95	57	85	622.5					
	1998.05-	1999.09	MT	R	F		GDS50164	Drive Shaft			21	23	57	84.5	714.5					
1.9 D	1998.05-	1999.09	MT	L			GDS50018	Drive Shaft			21	29.95	57	85	622.5					
	1998.05-	1999.09	MT	R	F		GDS50164	Drive Shaft			21	23	57	84.5	714.5					
<b>KOLEOS (HY_)</b>																				
2.0 DCi (110 kW)	2008.09-		AT	L	F	Closed Off-Road Vehicle Engine M9R855/M9R856/M9R862/M9R865/M9R866	GDS41365	Drive Shaft			29	30	56	102	650					
	2008.09-					Closed Off-Road Vehicle Engine M9R855/M9R856/M9R862/M9R865/M9R866	GDS41475	Drive Shaft			29	30	56	102	971					
2.0 DCi 4x4 (110 kW)	2008.09-		AT	L	F	Closed Off-Road Vehicle Engine M9R855/856/862/865/866	GDS41365	Drive Shaft			29	30	56	102	650					
	2008.09-			R	F	Closed Off-Road Vehicle Engine M9R855/856/862/865/866	GDS41441	Drive Shaft			29	29	56	102	1009					
	2008.09-			R	F	Closed Off-Road Vehicle Engine M9R855/856/862/865/866	GCI41131	Inner Joint			29	29	33	482	100					
	2008.09-			R	F	Closed Off-Road Vehicle Engine M9R855/856/862/865/866	GC041249	Outer Joint			29	36	56	102	72	I				
	2008.09-					Closed Off-Road Vehicle Engine M9R855/856/862/865/866	GDS41475	Drive Shaft			29	30	56	102	971					
2.0 DCi 4x4 (127 kW)	2008.09-					Closed Off-Road Vehicle Engine M9R830	GC041285	Drive Shaft	48T		25	24	56	110.5	38.5	I				
	2008.09-		AT	L	F	Closed Off-Road Vehicle Engine M9R830	GDS41365	Outer Joint			29	30	56	102	650					
	2008.09-			R	F	Closed Off-Road Vehicle Engine M9R830	GDS41441	Drive Shaft			29	29	56	102	1009					
	2008.09-			R	F	Closed Off-Road Vehicle Engine M9R830	GCI41131	Inner Joint			29	29	33	482	100					
	2008.09-			R	F	Closed Off-Road Vehicle Engine M9R830	GC041249	Outer Joint			29	36	56	102	72	I				
2.5 4x4 (126 kW)	2008.09-					Closed Off-Road Vehicle Engine 2TR700/2TR702/2TR703	GC041285	Outer Joint	48T		25	24	56	110.5	38.5	I				
<b>LAGUNA</b>																				
1.6	2000.12-		MT				GC050025	Outer Joint			23	25	56	84	61	O				
1.6 16V	1998.05-	2000.12	MT				GC050025	Outer Joint			23	25	56	84	61	O				
1.8	1998.05-	2000.12	MT				GC050025	Outer Joint			23	25	56	84	61	O				
1.9 TD	1998.05-	2000.12	MT				GC050025	Outer Joint			23	25	56	84	61	O				
2	1998.05-	2000.12	AT				GC050025	Outer Joint			23	25	56	84	61	O				
2.0 16V	1995.03-	1998.05		L			GDS50131	Drive Shaft	44T		23	29.95	56.2	83.5	658.5					
	1995.03-	1998.05		R			GDS50133	Drive Shaft	44T		23	23	57.5	83.5	801					
	1998.05-	2000.12	MT				GC050025	Outer Joint			23	25	56	84	61	O				
2.2 D	1995.04-	1998.05		L			GDS50131	Drive Shaft	44T		23	29.95	56.2	83.5	658.5					
2.2 DCi 16V	2001-			L			GDS50269	Drive Shaft			27	37.1	56.5	91.5	595					
	2001-			R			GDS50209	Drive Shaft			27	39	56.5	92	1014					
2.2 TD 12V	1998.05-	2000.12	MT		PK1		GC050025	Outer Joint			23	25	56	84	61	O				
3.0 V6	1998.05-		AT				GC050025	Outer Joint			23	25	56	84	61	O				
	1998.05-		MT		JC5		GC050025	Outer Joint			23	25	56	84	61	O				
<b>LAGUNA (DT0/1)</b>																				
1.5 DCi (81 kW)	2012.03-		MT	L	F	Coupe Engine K9K846	GDS50378	Drive Shaft			27	26	56.7	91	687					
	2012.03-		MT	R	F	Coupe Engine K9K846	GDS50377	Drive Shaft			27	26	56.7	91	940					
	2012.03-					Coupe Engine K9K846	GC050130	Outer Joint			27	33	56.7	91	61	I				
2.0 DCi (110 kW)	2008.09-		MT	L	F	Coupe Engine M9R802/M9R805/M9R814	GDS50496	Drive Shaft			27	39	56.5	90.5	640					
	2008.09-		MT	R	F	Coupe Engine M9R802/M9R805/M9R814	GDS50380	Drive Shaft			27	39	56.7	86.5	985					
	2008.09-		AT		F	Coupe Engine M9R802/M9R805/M9R814	GC050131	Outer Joint			27	36	56.7	86.5	66	I				
2.0 DCi (127 kW)	2008.09-		MT	L	F	Coupe Engine M9R800/M9R809/M9R815	GDS50496	Drive Shaft			27	39	56.5	90.5	640					
	2008.09-		MT	R	F	Coupe Engine M9R800/M9R809/M9R815	GDS50380	Drive Shaft			27	39	56.7	86.5	985					
	2008.09-					Coupe Engine M9R800/M9R809/M9R815	GC050131	Outer Joint			27	36	56.7	86.5	66	I				
2.0 DCi GT (131 kW)	2008.09-		MT	L	F	Coupe Engine M9R816/M9R820	GDS50496	Drive Shaft			27	39	56.5	90.5	640					
	2008.09-					Coupe Engine M9R816/M9R820	GC050131	Outer Joint			27	36	56.7	86.5	66	I				
2.0 GT (150 kW)	2008.09-		MT	L	F	Coupe Engine F4R800	GDS50496	Drive Shaft			27	39	56.5	90.5	640					
	2008.09-		MT	R	F	Coupe Engine F4R800	GDS50380	Drive Shaft			27	39	56.7	86.5	985					
	2008.09-					Coupe Engine F4R800	GC050131	Outer Joint			27	36	56.7	86.5	66	I				
<b>LAGUNA I</b>																				
2.2 D	1995.04-	1998.04	MT		F		GC050003	Outer Joint			23	29	57.5	83.5	62	O				
2.2 TD	1996.06-	1998.04	MT		F		GC050003	Outer Joint			23	29	57.5	83.5	62	O				
<b>LAGUNA I (B56, 556, K56), SW</b>																				
1.8 (66 kW)	1993.11-	2001.03				Ch-950213	GC050005	Outer Joint	44T		23	25	56.3	84	61.5	O				
1.8 (69 kW)	1993.11-	2001.03				Ch-950213	GC050005	Outer Joint	44T		23	25	56.3	84	61.5	O				
2.0 (70 kW)	1995.06-	2001.02				Ch-950213	GC050005	Outer Joint	44T		23	25	56.3	84	61.5	O				
2.0 (80 kW)	1995.06-	2001.02				Ch-950213	GC050005	Outer Joint	44T		23	25	56.3	84	61.5	O				





		TRANSM	L/R	F/R		G-AP Ref.	PRODUCT	ABS	Technical Specifications								
									YEAR	A	B	C	H	L	P		
<b>RENAULT</b>																	
<b>LAGUNA I (B56, 556, K56), SW</b>																	
2.0 (93 kW)	1995.06-	2001.02				Ch-950213	GC050005	Outer Joint	44T	23	25	56.3	84	61.5	O		
2.0 16V (102 kW)	1995.06-	2001.03					GC050005	Outer Joint	44T	23	25	56.3	84	61.5	O		
2.0 16V (103 kW)	1995.06-	2001.03					GC050005	Outer Joint	44T	23	25	56.3	84	61.5	O		
2.2 D (61 kW)	1993.11-	2001.03					GC050005	Outer Joint	44T	23	25	56.3	84	61.5	O		
2.2 DT (83 kW)	1996-	2001					GC050005	Outer Joint	44T	23	25	56.3	84	61.5	O		
<b>LAGUNA I (B56_, 556_)</b>																	
1.6 16V (79 kW)	1997.11-	2001.03	MT	R	F	Hatchback Engine K4M720	GDS50189	Drive Shaft		23	23	57.5	86.5	742			
	1997.11-	2001.03		L	F	Hatchback Engine K4M720	GDS50197	Drive Shaft		23	29.95	56.3	85	706			
	1997.11-	2001.03		R	F	Hatchback Engine K4M720	GDS50043	Drive Shaft		23	23	56	84	747			
1.8 (66 kW)	1993.11-	2001.03	MT	L	F	Hatchback Engine F3P720/F3P724	GC050046	Outer Joint	44T	23	29	57.5	83.5	62	O		
	1993.11-	2001.03				Hatchback Engine F3P720/F3P724	GC050051	Outer Joint	48T	23	25	56.3	80	58	O		
	1993.11-	2001.03		R	F	Hatchback Engine F3P720/F3P724	GDS50053	Drive Shaft		21	23	56.2	83.5	751			
	1993.11-	2001.03	MT	R	F	Hatchback Engine F3P720/F3P724	GDS50046	Drive Shaft		23	23	56.2	83.5	748			
	1993.11-	2001.03	MT	L	F	Hatchback Engine F3P720/F3P724	GDS50093	Drive Shaft		23	29.95	56.3	80	700			
	1993.11-	2001.03	MT	R	F	Hatchback Engine F3P720/F3P724	GDS50035	Drive Shaft		21	23	50	85	751			
	1993.11-	2001.03	MT	L	F	Hatchback Engine F3P720/F3P724	GDS50034	Drive Shaft		21	29.95	56.2	83.5	699			
	1993.11-	2001.03	MT	R	F	Hatchback Engine F3P720/F3P724	GDS50134	Drive Shaft	44T	23	23	56.2	83.5	748			
	1993.11-	2001.03	MT	L	F	Hatchback Engine F3P720/F3P724	GDS50026	Drive Shaft	44T	23	29.95	57.5	83.5	702			
	1993.11-	2001.03	MT		F	Hatchback Engine F3P720/F3P724	GC050008	Outer Joint		21	25	56.2	83.5	58	O		
	1993.11-	2001.03		L	F	Hatchback Engine F3P720/F3P724	GDS50309	Drive Shaft		21	29.95	56.2	83.5	702			
	1993.11-	2001.03			F	Hatchback Engine F3P720/F3P724	GC050026	Outer Joint		23	25	56.2	83.5	58	O		
	1993.11-	2001.03			F	Hatchback Engine F3P720/F3P724	GC050045	Outer Joint	30T	23	25	56.2	83.5	58	O		
	1995.08-	2001.03	MT	L	F	Hatchback Engine F3P670/F3P678	GC050046	Outer Joint	44T	23	29	57.5	83.5	62	O		
	1995.08-	2001.03		L		Hatchback Engine F3P670/F3P678	GDS50075	Drive Shaft	44T	21	29.95	56.2	83.5	703			
	1995.08-	2001.03				Hatchback Engine F3P670/F3P678	GC050051	Outer Joint	48T	23	25	56.3	80	58	O		
	1995.08-	2001.03		R	F	Hatchback Engine F3P670/F3P678	GDS50053	Drive Shaft		21	23	56.2	83.5	751			
	1995.08-	2001.03	MT	R	F	Hatchback Engine F3P670/F3P678	GDS50046	Drive Shaft		23	23	56.2	83.5	748			
	1995.08-	2001.03	MT	L	F	Hatchback Engine F3P670/F3P678	GDS50093	Drive Shaft		23	29.95	56.3	80	700			
	1995.08-	2001.03	MT	R	F	Hatchback Engine F3P670/F3P678	GDS50035	Drive Shaft		21	23	50	85	751			
	1995.08-	2001.03	MT	L	F	Hatchback Engine F3P670/F3P678	GDS50034	Drive Shaft		21	29.95	56.2	83.5	699			
	1995.08-	2001.03	MT	R	F	Hatchback Engine F3P670/F3P678	GDS50134	Drive Shaft	44T	23	23	56.2	83.5	748			
	1995.08-	2001.03	MT	L	F	Hatchback Engine F3P670/F3P678	GDS50026	Drive Shaft	44T	23	29.95	57.5	83.5	702			
	1995.08-	2001.03	MT		F	Hatchback Engine F3P670/F3P678	GC050008	Outer Joint		21	25	56.2	83.5	58	O		
1995.08-	2001.03		L	F	Hatchback Engine F3P670/F3P678	GDS50309	Drive Shaft		21	29.95	56.2	83.5	702				
1995.08-	2001.03			F	Hatchback Engine F3P670/F3P678	GC050026	Outer Joint		23	25	56.2	83.5	58	O			
1995.08-	2001.03			F	Hatchback Engine F3P670/F3P678	GC050045	Outer Joint	30T	23	25	56.2	83.5	58	O			
1.8 (69 kW)	1995.06-	2001.02	MT	L	F	Hatchback Engine F3P674	GC050046	Outer Joint	44T	23	29	57.5	83.5	62	O		
	1995.06-	2001.02	MT	R	F	Hatchback Engine F3P674	GDS50046	Drive Shaft		23	23	56.2	83.5	748			
	1995.06-	2001.02	MT	L	F	Hatchback Engine F3P674	GDS50093	Drive Shaft		23	29.95	56.3	80	700			
	1995.06-	2001.02	MT	R	F	Hatchback Engine F3P674	GDS50035	Drive Shaft		21	23	50	85	751			
	1995.06-	2001.02	MT	L	F	Hatchback Engine F3P674	GDS50034	Drive Shaft		21	29.95	56.2	83.5	699			
	1995.06-	2001.02	MT	R	F	Hatchback Engine F3P674	GDS50134	Drive Shaft	44T	23	23	56.2	83.5	748			
	1995.06-	2001.02	MT	L	F	Hatchback Engine F3P674	GDS50026	Drive Shaft	44T	23	29.95	57.5	83.5	702			
	1995.06-	2001.02	MT		F	Hatchback Engine F3P674	GC050008	Outer Joint		21	25	56.2	83.5	58	O		
	1995.08-	2001.03	MT	L	F	Hatchback Engine F3P720/F3P724	GC050046	Outer Joint	44T	23	29	57.5	83.5	62	O		
	1995.08-	2001.03		L		Hatchback Engine F3P720/F3P724	GDS50075	Drive Shaft	44T	21	29.95	56.2	83.5	703			
	1995.08-	2001.03				Hatchback Engine F3P720/F3P724	GC050051	Outer Joint	48T	23	25	56.3	80	58	O		
	1995.08-	2001.03		R	F	Hatchback Engine F3P720/F3P724	GDS50053	Drive Shaft		21	23	56.2	83.5	751			
	1995.08-	2001.03	MT	R	F	Hatchback Engine F3P720/F3P724	GDS50046	Drive Shaft		23	23	56.2	83.5	748			
	1995.08-	2001.03	MT	L	F	Hatchback Engine F3P720/F3P724	GDS50093	Drive Shaft		23	29.95	56.3	80	700			
	1995.08-	2001.03	MT	R	F	Hatchback Engine F3P720/F3P724	GDS50035	Drive Shaft		21	23	50	85	751			
	1995.08-	2001.03	MT	L	F	Hatchback Engine F3P720/F3P724	GDS50034	Drive Shaft		21	29.95	56.2	83.5	699			
	1995.08-	2001.03	MT	R	F	Hatchback Engine F3P720/F3P724	GDS50134	Drive Shaft	44T	23	23	56.2	83.5	748			
	1995.08-	2001.03	MT	L	F	Hatchback Engine F3P720/F3P724	GDS50026	Drive Shaft	44T	23	29.95	57.5	83.5	702			
	1995.08-	2001.03	MT		F	Hatchback Engine F3P720/F3P724	GC050008	Outer Joint		21	25	56.2	83.5	58	O		
	1995.08-	2001.03		L	F	Hatchback Engine F3P720/F3P724	GDS50309	Drive Shaft		21	29.95	56.2	83.5	702			
	1995.08-	2001.03			F	Hatchback Engine F3P720/F3P724	GC050026	Outer Joint		23	25	56.2	83.5	58	O		
	1995.08-	2001.03			F	Hatchback Engine F3P720/F3P724	GC050045	Outer Joint	30T	23	25	56.2	83.5	58	O		
	1.8 (70 kW)	1995.06-	1998.06			F	Hatchback Engine F3P676	GC050026	Outer Joint		23	25	56.2	83.5	58	O	
		1995.06-	1998.06			F	Hatchback Engine F3P676	GC050045	Outer Joint	30T	23	25	56.2	83.5	58	O	
1.8 16V (88 kW)	1998.04-	2001.03	MT	R	F	Hatchback Engine F4P760	GDS50189	Drive Shaft		23	23	57.5	86.5	742			



		TRANSM	L/R	F/R		G-AP Ref.	PRODUCT	ABS	Technical Specifications								
									YEAR	A	B	C	H	L	P		
<b>RENAULT LAGUNA I (B56_, 556_)</b>																	
1.8 16V (88 kW)	1998.04-	2001.03			L	F	Hatchback Engine F4P760	GDS50197	Drive Shaft		23	29.95	56.3	85	706		
	1998.04-	2001.03			R	F	Hatchback Engine F4P760	GDS50043	Drive Shaft		23	23	56	84	747		
1.9 DCi (79 kW)	1999.09-	2001.03			L	F	Hatchback Engine F9Q718	GDS50227	Drive Shaft		23	37.1	56	84	619		
	1999.09-	2001.03			R	F	Hatchback Engine F9Q718	GDS50268	Drive Shaft		23	39	56	84	935		
1.9 DTi (72 kW)	1997.10-	2001.03	MT		R	F	Hatchback Engine F9Q710/F9Q716/F9Q717	GDS50189	Drive Shaft		23	23	57.5	86.5	742		
	1997.10-	2001.03	MT		L	F	Hatchback Engine F9Q710/F9Q716/F9Q717	GDS50197	Drive Shaft		23	29.95	56.3	85	706		
	1997.10-	2001.03	MT		R	F	Hatchback Engine F9Q710/F9Q716/F9Q717	GDS50043	Drive Shaft		23	23	56	84	747		
2.0 (103 kW)	1995.06-	2001.02				F	Hatchback Engine N7Q700/N7Q704	GC050026	Outer Joint		23	25	56.2	83.5	58	O	
	1995.06-	2001.02				F	Hatchback Engine N7Q700/N7Q704	GC050045	Outer Joint	30T	23	25	56.2	83.5	58	O	
	1995.06-	2001.02	MT		L	F	Hatchback Engine N7Q700/N7Q704	GDS50130	Drive Shaft		23	29.95	56.2	83.5	658.5		
2.0 (80 kW)	1999.03-	2001.03			L		Hatchback Engine F3R611	GDS50075	Drive Shaft	44T	21	29.95	56.2	83.5	703		
	1999.03-	2001.03			R	F	Hatchback Engine F3R611	GDS50053	Drive Shaft		21	23	56.2	83.5	751		
	1999.03-	2001.03	4AT		L	F	Hatchback Engine F3R611	GDS50309	Drive Shaft		21	29.95	56.2	83.5	702		
	1999.03-	2001.03	4AT		F		Hatchback Engine F3R611	GC050026	Outer Joint		23	25	56.2	83.5	58	O	
	1999.03-	2001.03	4AT		F		Hatchback Engine F3R611	GC050045	Outer Joint	30T	23	25	56.2	83.5	58	O	
2.0 (83 kW)	1993.11-	2001.03	MT		L	F	Hatchback Engine F3R722/F3R723	GC050046	Outer Joint	44T	23	29	57.5	83.5	62	O	
	1993.11-	2001.03			R	F	Hatchback Engine F3R722/F3R723	GDS50189	Drive Shaft		23	23	57.5	86.5	742		
	1993.11-	2001.03			L		Hatchback Engine F3R722/F3R723	GDS50075	Drive Shaft	44T	21	29.95	56.2	83.5	703		
	1993.11-	2001.03					Hatchback Engine F3R722/F3R723	GC099088	Outer Joint		21	29	57.4	82	63	O	
	1993.11-	2001.03			R	F	Hatchback Engine F3R722/F3R723	GDS50053	Drive Shaft		21	23	56.2	83.5	751		
	1993.11-	2001.03	MT		R	F	Hatchback Engine F3R722/F3R723	GDS50046	Drive Shaft		23	23	56.2	83.5	748		
	1993.11-	2001.03	MT		L	F	Hatchback Engine F3R722/F3R723	GDS50093	Drive Shaft		23	29.95	56.3	80	700		
	1993.11-	2001.03	MT		R	F	Hatchback Engine F3R722/F3R723	GDS50035	Drive Shaft		21	23	50	85	751		
	1993.11-	2001.03	MT		L	F	Hatchback Engine F3R722/F3R723	GDS50034	Drive Shaft		21	29.95	56.2	83.5	699		
	1993.11-	2001.03	MT		R	F	Hatchback Engine F3R722/F3R723	GDS50134	Drive Shaft	44T	23	23	56.2	83.5	748		
	1993.11-	2001.03	MT		L	F	Hatchback Engine F3R722/F3R723	GDS50026	Drive Shaft	44T	23	29.95	57.5	83.5	702		
	1993.11-	2001.03	MT			F		Hatchback Engine F3R722/F3R723	GC050008	Outer Joint		21	25	56.2	83.5	58	O
	1993.11-	2001.03			L	F	Hatchback Engine F3R722/F3R723	GDS50309	Drive Shaft		21	29.95	56.2	83.5	702		
	1993.11-	2001.03			F		Hatchback Engine F3R722/F3R723	GC050026	Outer Joint		23	25	56.2	83.5	58	O	
	1993.11-	2001.03			F		Hatchback Engine F3R722/F3R723	GC050045	Outer Joint	30T	23	25	56.2	83.5	58	O	
2.0 (84 kW)	1995.06-	2001.02			R	F	Hatchback Engine F3R768	GDS50189	Drive Shaft		23	23	57.5	86.5	742		
	1995.06-	2001.02					Hatchback Engine F3R768	GC099088	Outer Joint		21	29	57.4	82	63	O	
	1995.06-	2001.02				F	Hatchback Engine F3R768	GC050026	Outer Joint		23	25	56.2	83.5	58	O	
	1995.06-	2001.02				F	Hatchback Engine F3R768	GC050045	Outer Joint	30T	23	25	56.2	83.5	58	O	
2.0 16V (102 kW)	1995.06-	2001.03			R	F	Hatchback Engine N7Q700/N7Q704	GDS50189	Drive Shaft		23	23	57.5	86.5	742		
	1995.06-	2001.03					Hatchback Engine N7Q700/N7Q704	GC099088	Outer Joint		21	29	57.4	82	63	O	
	1995.06-	2001.03	MT		L	F	Hatchback Engine N7Q700/N7Q704	GDS50130	Drive Shaft		23	29.95	56.2	83.5	658.5		
	1995.06-	2001.03				F	Hatchback Engine N7Q700/N7Q704	GC050026	Outer Joint		23	25	56.2	83.5	58	O	
	1995.06-	2001.03				F	Hatchback Engine N7Q700/N7Q704	GC050045	Outer Joint	30T	23	25	56.2	83.5	58	O	
2.0 16V (103 kW)	1999.09-	2001.03			L	F	Hatchback Engine F4R780	GDS50197	Drive Shaft		23	29.95	56.3	85	706		
	1999.09-	2001.03			R	F	Hatchback Engine F4R780	GDS50043	Drive Shaft		23	23	56	84	747		
2.2 D (61 kW)	1993.11-	2001.03	MT		R	F	Hatchback Engine G8T706/G8T752/G8T790/G8T794	GDS50189	Drive Shaft		23	23	57.5	86.5	742		
	1993.11-	2001.03					Hatchback Engine G8T706/G8T752/G8T790/G8T794	GC099088	Outer Joint		21	29	57.4	82	63	O	
	1993.11-	2001.03	MT		L	F	Hatchback Engine G8T706/G8T752/G8T790/G8T794	GDS50130	Drive Shaft		23	29.95	56.2	83.5	658.5		
	1993.11-	2001.03			R	F	Hatchback Engine G8T706/G8T752/G8T790/G8T794	GDS50215	Drive Shaft	44T	23	23	56.2	83.5	802		
	1993.11-	2001.03	MT		R	F	Hatchback Engine G8T706/G8T752/G8T790/G8T794	GDS50047	Drive Shaft		23	23	55.5	82.5	795		
	1993.11-	2001.03	MT		R	F	Hatchback Engine G8T706/G8T752/G8T790/G8T794	GDS50461	Drive Shaft	44T	23	29.95	56.3	84	658		
	1993.11-	2001.03				F	Hatchback Engine G8T706/G8T752/G8T790/G8T794	GC050026	Outer Joint		23	25	56.2	83.5	58	O	
	1993.11-	2001.03				F	Hatchback Engine G8T706/G8T752/G8T790/G8T794	GC050045	Outer Joint	30T	23	25	56.2	83.5	58	O	
2.2 DT (83 kW)	1996.03-	2001.03	MT		R	F	Hatchback Engine G8T760	GDS50189	Drive Shaft		23	23	57.5	86.5	742		
	1996.03-	2001.03	MT			F	Hatchback Engine G8T760	GC050015	Outer Joint		23	29	56.3	80	63	O	
	1996.03-	2001.03					Hatchback Engine G8T760	GC099088	Outer Joint		21	29	57.4	82	63	O	
	1996.03-	2001.03	MT		R	F	Hatchback Engine G8T760	GDS50319	Drive Shaft		23	39	56.3	85	958		
	1996.03-	2001.03				F	Hatchback Engine G8T760	GC050026	Outer Joint		23	25	56.2	83.5	58	O	
	1996.03-	2001.03	MT			F	Hatchback Engine G8T760	GC050105	Outer Joint		23	27	56.3	85	68	I	
	1996.03-	2001.03				F	Hatchback Engine G8T760	GC050045	Outer Joint	30T	23	25	56.2	83.5	58	O	
3.0 (123 kW)	1993.11-	2001.03	MT		R	F	Hatchback Engine Z7X760/Z7X765	GDS50319	Drive Shaft		23	39	56.3	85	958		
	1993.11-	2001.03	MT			F	Hatchback Engine Z7X760/Z7X765	GC050105	Outer Joint		23	27	56.3	85	68	I	
3.0 24V (140 kW)	1997.03-	2001.03	MT		R	F	Hatchback Engine L7X700/L7X701	GDS50331	Drive Shaft		23	39	56.3	85	955		
<b>LAGUNA I (K56_)</b>																	
1.6 16V (79 kW)	1997.11-	2001.03			L	F	Estate Engine K4M720	GDS50197	Drive Shaft		23	29.95	56.3	85	706		





		TRANSM	L/R	F/R		G-AP Ref.	PRODUCT	ABS	Technical Specifications								
									YEAR	A	B	C	H	L	P		
<b>RENAULT LAGUNA I (K56_)</b>																	
1.6 16V (79 kW)	1997.11-	2001.03		R	F	Estate Engine K4M720	GDS50043	Drive Shaft		23	23	56	84	747			
1.8 (66 kW)	1995.09-	2001.03	MT	L	F	Estate Engine F3P670/F3P678	GDS50093	Drive Shaft		23	29.95	56.3	80	700			
	1995.09-	2001.03	MT	R	F	Estate Engine F3P670/F3P678	GDS50035	Drive Shaft		21	23	50	85	751			
	1995.09-	2001.03	MT	L	F	Estate Engine F3P670/F3P678	GDS50034	Drive Shaft		21	29.95	56.2	83.5	699			
	1995.09-	2001.03	MT	R	F	Estate Engine F3P670/F3P678	GDS50134	Drive Shaft	44T	23	23	56.2	83.5	748			
	1995.09-	2001.03	MT	L	F	Estate Engine F3P670/F3P678	GDS50026	Drive Shaft	44T	23	29.95	57.5	83.5	702			
	1995.09-	2001.03	MT		F	Estate Engine F3P670/F3P678	GC050008	Outer Joint		21	25	56.2	83.5	58	O		
	1995.09-	2001.03		L	F	Estate Engine F3P670/F3P678	GDS50309	Drive Shaft		21	29.95	56.2	83.5	702			
	1995.09-	2001.03	MT	L	F	Estate Engine F3P670/F3P678	GC050046	Outer Joint	44T	23	29	57.5	83.5	62	O		
	1995.09-	2001.03				Estate Engine F3P670/F3P678	GC050051	Outer Joint	48T	23	25	56.3	80	58	O		
	1995.09-	2001.03		R	F	Estate Engine F3P670/F3P678	GDS50053	Drive Shaft		21	23	56.2	83.5	751			
	1995.09-	2001.03	MT	R	F	Estate Engine F3P670/F3P678	GDS50046	Drive Shaft		23	23	56.2	83.5	748			
1.8 (69 kW)	1995.09-	2001.03		R	F	Estate Engine F3P720/F3P724	GDS50053	Drive Shaft		21	23	56.2	83.5	751			
	1995.09-	2001.03	MT	R	F	Estate Engine F3P720/F3P724	GDS50046	Drive Shaft		23	23	56.2	83.5	748			
	1995.09-	2001.03	MT	L	F	Estate Engine F3P720/F3P724	GDS50093	Drive Shaft		23	29.95	56.3	80	700			
	1995.09-	2001.03	MT	R	F	Estate Engine F3P720/F3P724	GDS50035	Drive Shaft		21	23	50	85	751			
	1995.09-	2001.03	MT	L	F	Estate Engine F3P720/F3P724	GDS50034	Drive Shaft		21	29.95	56.2	83.5	699			
	1995.09-	2001.03	MT	R	F	Estate Engine F3P720/F3P724	GDS50134	Drive Shaft	44T	23	23	56.2	83.5	748			
	1995.09-	2001.03	MT	L	F	Estate Engine F3P720/F3P724	GDS50026	Drive Shaft	44T	23	29.95	57.5	83.5	702			
	1995.09-	2001.03	MT		F	Estate Engine F3P720/F3P724	GC050008	Outer Joint		21	25	56.2	83.5	58	O		
	1995.09-	2001.03		L	F	Estate Engine F3P720/F3P724	GDS50309	Drive Shaft		21	29.95	56.2	83.5	702			
	1995.09-	2001.03	MT	L	F	Estate Engine F3P720/F3P724	GC050046	Outer Joint	44T	23	29	57.5	83.5	62	O		
	1995.09-	2001.03				Estate Engine F3P720/F3P724	GC050051	Outer Joint	48T	23	25	56.3	80	58	O		
1.8 16V (88 kW)	1998.04-	2001.03		L	F	Estate Engine F4P760	GDS50197	Drive Shaft		23	29.95	56.3	85	706			
	1998.04-	2001.03		R	F	Estate Engine F4P760	GDS50043	Drive Shaft		23	23	56	84	747			
1.9 DCi (79 kW)	1999.09-	2001.03		L	F	Estate Engine F9Q718	GDS50227	Drive Shaft		23	37.1	56	84	619			
	1999.09-	2001.03		R	F	Estate Engine F9Q718	GDS50268	Drive Shaft		23	39	56	84	935			
1.9 DTi (72 kW)	1997.10-	2001.03	MT	L	F	Estate Engine F9Q710/F9Q716//F9Q717	GDS50197	Drive Shaft		23	29.95	56.3	85	706			
	1997.10-	2001.03	MT	R	F	Estate Engine F9Q710/F9Q716//F9Q717	GDS50043	Drive Shaft		23	23	56	84	747			
2.0 (83 kW)	1995.09-	2001.03		R	F	Estate Engine F3R722/F3R723	GDS50053	Drive Shaft		21	23	56.2	83.5	751			
	1995.09-	2001.03	MT	R	F	Estate Engine F3R722/F3R723	GDS50046	Drive Shaft		23	23	56.2	83.5	748			
	1995.09-	2001.03	MT	L	F	Estate Engine F3R722/F3R723	GDS50093	Drive Shaft		23	29.95	56.3	80	700			
	1995.09-	2001.03	MT	R	F	Estate Engine F3R722/F3R723	GDS50035	Drive Shaft		21	23	50	85	751			
	1995.09-	2001.03	MT	L	F	Estate Engine F3R722/F3R723	GDS50034	Drive Shaft		21	29.95	56.2	83.5	699			
	1995.09-	2001.03	MT	R	F	Estate Engine F3R722/F3R723	GDS50134	Drive Shaft	44T	23	23	56.2	83.5	748			
	1995.09-	2001.03	MT	L	F	Estate Engine F3R722/F3R723	GDS50026	Drive Shaft	44T	23	29.95	57.5	83.5	702			
	1995.09-	2001.03	MT		F	Estate Engine F3R722/F3R723	GC050008	Outer Joint		21	25	56.2	83.5	58	O		
	1995.09-	2001.03		L	F	Estate Engine F3R722/F3R723	GDS50309	Drive Shaft		21	29.95	56.2	83.5	702			
	1995.09-	2001.03	MT	L	F	Estate Engine F3R722/F3R723	GC050046	Outer Joint	44T	23	29	57.5	83.5	62	O		
	1995.09-	2001.03		R	F	Estate Engine F3R722/F3R723	GDS50189	Drive Shaft		23	23	57.5	86.5	742			
1995.09-	2001.03				Estate Engine F3R722/F3R723	GC099088	Outer Joint		21	29	57.4	82	63	O			
2.0 (84 kW)	1998.10-	2001.01	MT	R	F	Estate Engine F3R768	GDS50189	Drive Shaft		23	23	57.5	86.5	742			
2.0 16V (102 kW)	1995.09-	2001.03			F	Estate Engine N7Q700/N7Q704	GC050026	Outer Joint		23	25	56.2	83.5	58	O		
	1995.09-	2001.03			F	Estate Engine N7Q700/N7Q704	GC050045	Outer Joint	30T	23	25	56.2	83.5	58	O		
	1995.09-	2001.03	MT	L	F	Estate Engine N7Q700/N7Q704	GDS50130	Drive Shaft		23	29.95	56.2	83.5	658.5			
	1995.09-	2001.03		R	F	Estate Engine N7Q700/N7Q704	GDS50189	Drive Shaft		23	23	57.5	86.5	742			
	1995.09-	2001.03				Estate Engine N7Q700/N7Q704	GC099088	Outer Joint		21	29	57.4	82	63	O		
2.2 D (61 kW)	1995.09-	2001.03		R	F	Estate Engine G8T706/G8T752/G8T790/G8T794	GDS50215	Drive Shaft	44T	23	23	56.2	83.5	802			
	1995.09-	2001.03	MT	R	F	Estate Engine G8T706/G8T752/G8T790/G8T794	GDS50047	Drive Shaft		23	23	55.5	82.5	795			
	1995.09-	2001.03	MT	R	F	Estate Engine G8T706/G8T752/G8T790/G8T794	GDS50461	Drive Shaft	44T	23	29.95	56.3	84	658			
	1995.09-	2001.03			F	Estate Engine G8T706/G8T752/G8T790/G8T794	GC050026	Outer Joint		23	25	56.2	83.5	58	O		
	1995.09-	2001.03			F	Estate Engine G8T706/G8T752/G8T790/G8T794	GC050045	Outer Joint	30T	23	25	56.2	83.5	58	O		
	1995.09-	2001.03	MT	L	F	Estate Engine G8T706/G8T752/G8T790/G8T794	GDS50130	Drive Shaft		23	29.95	56.2	83.5	658.5			
	1995.09-	2001.03	MT	R	F	Estate Engine G8T706/G8T752/G8T790/G8T794	GDS50189	Drive Shaft		23	23	57.5	86.5	742			
	1995.09-	2001.03	MT		F	Estate Engine G8T706/G8T752/G8T790/G8T794	GC050015	Outer Joint		23	29	56.3	80	63	O		
	1995.09-	2001.03				Estate Engine G8T706/G8T752/G8T790/G8T794	GC099088	Outer Joint		21	29	57.4	82	63	O		
2.2 DT (83 kW)	1996.03-	2001.03	MT	R	F	Estate Engine G8T760	GDS50319	Drive Shaft		23	39	56.3	85	958			
	1996.03-	2001.03			F	Estate Engine G8T760	GC050026	Outer Joint		23	25	56.2	83.5	58	O		
	1996.03-	2001.03	MT		F	Estate Engine G8T760	GC050105	Outer Joint		23	27	56.3	85	68	I		
	1996.03-	2001.03			F	Estate Engine G8T760	GC050045	Outer Joint	30T	23	25	56.2	83.5	58	O		
	1996.02-	2001.03	MT	R	F	Estate Engine Z7X765	GDS50319	Drive Shaft		23	39	56.3	85	958			





		TRANSM	L/R	F/R		G-AP Ref.	PRODUCT	ABS	Technical Specifications							
									YEAR	A	B	C	H	L	P	
<b>RENAULT</b>																
<b>LAGUNA I (K56_)</b>																
3.0 (123 kW)	1996.02-	2001.03	MT		F	Estate Engine Z7X765	GC050105	Outer Joint		23	27	56.3	85	68	I	
3.0 24V (140 kW)	1997.03-	2001.03	MT	R	F	Estate Engine L7X700/L7X701	GDS50331	Drive Shaft		23	39	56.3	85	955		
<b>LAGUNA II</b>																
1.6	1998.05-	2001.01	MT				GC099086	Outer Joint		23	32	56.3	85	62.5	I	
1.8	1998.05-	2001.01	MT				GC099086	Outer Joint		23	32	56.3	85	62.5	I	
<b>LAGUNA II (B74, K74), SW</b>																
1.9 DCi (79 kW)	2001.03-						GC050041	Outer Joint		27	37	56.5	93	72	I	
2.0 DCi (110 kW)	2005.08-						GC050041	Outer Joint		27	37	56.5	93	72	I	
2.2 DCi (110 kW)	2001.10-						GC050041	Outer Joint		27	37	56.5	93	72	I	
2.2 DCi (85 kW)	2001.10-						GC050041	Outer Joint		27	37	56.5	93	72	I	
3.0 V6 24V (152 kW)	2001.03-						GC050041	Outer Joint		27	37	56.5	93	72	I	
<b>LAGUNA II (BG0/1_)</b>																
1.6 16V (79 kW)	2001.03-		4AT/5AT	L	F	Hatchback Engine K4M710/K4M714	GDS50328	Drive Shaft		27	26	56.5	91.5	697		
	2001.03-		5MT	L	F	Hatchback Engine K4M710/K4M714	GDS50446	Drive Shaft		27	29.95	56.5	91.5	719		
	2001.03-		4AT/5AT	R	F	Hatchback Engine K4M710/K4M714	GDS50329	Drive Shaft		27	23	56.5	91.5	824		
	2001.03-		MT	R	F	Hatchback Engine K4M710/K4M714	GDS50219	Drive Shaft		27	23	56.5	91.5	793.5		
	2001.03-					Hatchback Engine K4M710/K4M714	GC050083	Outer Joint		27	30	56.5	91.5	59	I	
1.6 16V (82 kW)	2005.02-		5MT	L	F	Hatchback Engine K4M716	GDS50446	Drive Shaft		27	29.95	56.5	91.5	719		
	2005.02-		AT	L	F	Hatchback Engine K4M716	GDS50281	Drive Shaft		27	26	56.5	92	700		
	2005.02-		AT	R	F	Hatchback Engine K4M716	GDS50509	Drive Shaft		27	26	56.7	91	822		
	2005.02-		MT	R	F	Hatchback Engine K4M716	GDS50219	Drive Shaft		27	23	56.5	91.5	793.5		
	2005.02-					Hatchback Engine K4M716	GC050083	Outer Joint		27	30	56.5	91.5	59	I	
1.8 16V (85 kW)	2001.03-		AT		F	Hatchback Engine F4P770/F4P771/F4P773/F4P774/F4P775	GC050079	Outer Joint		27	32	56.5	92	62.5	I	
	2001.03-		MT	L	F	Hatchback Engine F4P770/F4P771/F4P773/F4P774/F4P775	GDS50208	Drive Shaft		27	29.95	56.5	92	723		
	2001.03-		MT	R	F	Hatchback Engine F4P770/F4P771/F4P773/F4P774/F4P775	GDS50226	Drive Shaft		27	23	56.5	92	802		
	2001.03-		AT	L	F	Hatchback Engine F4P770/F4P771/F4P773/F4P774/F4P775	GDS50281	Drive Shaft		27	26	56.5	92	700		
	2001.03-		AT	R	F	Hatchback Engine F4P770/F4P771/F4P773/F4P774/F4P775	GDS50509	Drive Shaft		27	26	56.7	91	822		
	2001.03-		MT/AT	R	F	Hatchback Engine F4P770/F4P771/F4P773/F4P774/F4P775	GDS50219	Drive Shaft		27	23	56.5	91.5	793.5		
	2001.03-		MT/AT			Hatchback Engine F4P770/F4P771/F4P773/F4P774/F4P775	GC050083	Outer Joint		27	30	56.5	91.5	59	I	
1.8 16V (86 kW)	2001.03-				F	Hatchback Engine F4P770/F4P774	GC050079	Outer Joint		27	32	56.5	92	62.5	I	
	2001.03-		AT	L	F	Hatchback Engine F4P770/F4P774	GDS50281	Drive Shaft		27	26	56.5	92	700		
	2001.03-		AT	R	F	Hatchback Engine F4P770/F4P774	GDS50509	Drive Shaft		27	26	56.7	91	822		
	2001.03-		MT	R	F	Hatchback Engine F4P770/F4P774	GDS50219	Drive Shaft		27	23	56.5	91.5	793.5		
	2001.03-		MT/AT			Hatchback Engine F4P770/F4P774	GC050083	Outer Joint		27	30	56.5	91.5	59	I	
1.8 16V (88 kW)	2001.03-		5MT		F	Hatchback Engine F4P770/F4P773	GC050079	Outer Joint		27	32	56.5	92	62.5	I	
	2001.03-		5MT/6MT	L	F	Hatchback Engine F4P770/F4P773	GDS50208	Drive Shaft		27	29.95	56.5	92	723		
	2001.03-		5MT/6MT	R	F	Hatchback Engine F4P770/F4P773	GDS50226	Drive Shaft		27	23	56.5	92	802		
	2001.03-		4AT/5AT	R	F	Hatchback Engine F4P770/F4P773	GDS50219	Drive Shaft		27	23	56.5	91.5	793.5		
	2001.03-		MT	R	F	Hatchback Engine F4P770/F4P773	GDS50219	Drive Shaft		27	23	56.5	91.5	793.5		
	2001.03-		MT			Hatchback Engine F4P770/F4P773	GC050083	Outer Joint		27	30	56.5	91.5	59	I	
	2001.03-		MT/AT			Hatchback Engine F4P770/F4P772	GC050079	Outer Joint		27	32	56.5	92	62.5	I	
1.8 16V (89 kW)	2001.03-		MT	L	F	Hatchback Engine F4P770/F4P772	GDS50208	Drive Shaft		27	29.95	56.5	92	723		
	2001.03-		MT	R	F	Hatchback Engine F4P770/F4P772	GDS50226	Drive Shaft		27	23	56.5	92	802		
	2001.03-		AT	L	F	Hatchback Engine F4P770/F4P772	GDS50281	Drive Shaft		27	26	56.5	92	700		
	2001.03-			R	F	Hatchback Engine F4P770/F4P772	GDS50219	Drive Shaft		27	23	56.5	91.5	793.5		
	2001.03-		MT/AT			Hatchback Engine F4P770/F4P772	GC050083	Outer Joint		27	30	56.5	91.5	59	I	
	2001.03-		MT/AT			Hatchback Engine F4P770/F4P772	GC050079	Outer Joint		27	32	56.5	92	62.5	I	
1.9 DCi (68 kW)	2005.02-	2007.04			F	Hatchback Engine F9Q664	GC050113	Outer Joint		27	35	56.5	91.5	71	I	
	2005.02-	2007.04	MT	L	F	Hatchback Engine F9Q664	GDS50207	Drive Shaft		27	37.1	56.5	91.5	632		
	2005.02-	2007.04	MT	R	F	Hatchback Engine F9Q664	GDS50219	Drive Shaft		27	23	56.5	91.5	793.5		
	2005.02-	2007.04	MT	R	F	Hatchback Engine F9Q664	GDS50228	Drive Shaft		27	39	56.5	90.5	967		
	2005.02-	2007.04	5MT			Hatchback Engine F9Q664	GC050083	Outer Joint		27	30	56.5	91.5	59	I	
1.9 DCi (74 kW)	2001.10-				F	Hatchback Engine F9Q754	GC050079	Outer Joint		27	32	56.5	92	62.5	I	
	2001.10-		MT	L	F	Hatchback Engine F9Q754	GDS50207	Drive Shaft		27	37.1	56.5	91.5	632		
	2001.10-		MT	R	F	Hatchback Engine F9Q754	GDS50228	Drive Shaft		27	39	56.5	90.5	967		
	2001.10-		MT	R	F	Hatchback Engine F9Q754	GDS50219	Drive Shaft		27	23	56.5	91.5	793.5		
	2001.10-		5MT			Hatchback Engine F9Q754	GC050083	Outer Joint		27	30	56.5	91.5	59	I	
1.9 DCi (77 kW)	2001.06-		MT/AT		F	Hatchback Engine F9Q752	GC050079	Outer Joint		27	32	56.5	92	62.5	I	
	2001.06-		5MT/6MT	R	F	Hatchback Engine F9Q752	GDS50226	Drive Shaft		27	23	56.5	92	802		
	2001.06-		MT	R	F	Hatchback Engine F9Q752	GDS50219	Drive Shaft		27	23	56.5	91.5	793.5		
	2001.06-					Hatchback Engine F9Q752	GC050083	Outer Joint		27	30	56.5	91.5	59	I	
1.9 DCi (79 kW)	2001.03-			F	Hatchback Engine F9Q718/F9Q754	GC050113	Outer Joint		27	35	56.5	91.5	71	I		



		TRANSM	L/R	F/R		G-AP Ref.	PRODUCT	ABS	Technical Specifications						
									YEAR	A	B	C	H	L	P
<b>RENAULT LAGUNA II (BG0/1_)</b>															
1.9 DCi (79 kW)	2001.03-			L	F	Hatchback Engine F9Q718/F9Q754	GDS50207	Drive Shaft	27	37.1	56.5	91.5	632		
	2001.03-			R	F	Hatchback Engine F9Q718/F9Q754	GDS50228	Drive Shaft	27	39	56.5	90.5	967		
1.9 DCi (81 kW)	2005.01-				F	Hatchback Engine F9Q674/F9Q758	GC050113	Outer Joint	27	35	56.5	91.5	71	I	
	2005.01-		MT	L	F	Hatchback Engine F9Q674/F9Q758	GDS50207	Drive Shaft	27	37.1	56.5	91.5	632		
	2005.01-		MT	R	F	Hatchback Engine F9Q674/F9Q758	GDS50228	Drive Shaft	27	39	56.5	90.5	967		
	2005.01-				R	F	Hatchback Engine F9Q674/F9Q758	GDS99266	Drive Shaft	27	39	56.5	91.5	967	
	2001.03-				F	Hatchback Engine F9Q670/F9Q674/F9Q750	GC050113	Outer Joint	27	35	56.5	91.5	71	I	
1.9 DCi (88 kW)	2001.03-		5MT/6MT	L	F	Hatchback Engine F9Q670/F9Q674/F9Q750	GDS50207	Drive Shaft	27	37.1	56.5	91.5	632		
	2001.03-		5MT/6MT	R	F	Hatchback Engine F9Q670/F9Q674/F9Q750	GDS50228	Drive Shaft	27	39	56.5	90.5	967		
	2001.03-		MT	R	F	Hatchback Engine F9Q670/F9Q674/F9Q750	GDS50257	Drive Shaft	27	39	56.5	92	968		
	2001.03-				R	F	Hatchback Engine F9Q670/F9Q674/F9Q750	GDS99266	Drive Shaft	27	39	56.5	91.5	967	
	2005.02-	2007.04			F	Hatchback Engine F9Q758/F9Q759	GC050079	Outer Joint	27	32	56.5	92	62.5	I	
1.9 DCi (96 kW)	2005.02-	2007.04	MT	L	F	Hatchback Engine F9Q758/F9Q759	GDS50207	Drive Shaft	27	37.1	56.5	91.5	632		
	2005.02-	2007.04	MT	R	F	Hatchback Engine F9Q758/F9Q759	GDS50257	Drive Shaft	27	39	56.5	92	968		
	2005.02-	2007.04	MT	R	F	Hatchback Engine F9Q758/F9Q759	GDS50228	Drive Shaft	27	39	56.5	90.5	967		
	2001.08-	2007.07			F	Hatchback Engine F4R712/F4R713/F4R714/F4R715	GC050079	Outer Joint	27	32	56.5	92	62.5	I	
2.0 16V (99 kW)	2001.08-	2007.07		L	F	Hatchback Engine F4R712/F4R713/F4R714/F4R715	GDS50208	Drive Shaft	27	29.95	56.5	92	723		
	2001.08-	2007.07	AT	L	F	Hatchback Engine F4R712/F4R713/F4R714/F4R715	GDS50281	Drive Shaft	27	26	56.5	92	700		
	2001.08-	2007.07	MT	L	F	Hatchback Engine F4R712/F4R713/F4R714/F4R715	GDS50460	Drive Shaft	27	26	56.5	92	692		
	2001.08-	2007.07	AT	R	F	Hatchback Engine F4R712/F4R713/F4R714/F4R715	GDS50509	Drive Shaft	27	26	56.7	91	822		
	2001.08-	2007.07	MT	R	F	Hatchback Engine F4R712/F4R713/F4R714/F4R715	GDS50445	Drive Shaft	27	23	56.5	92	791		
	2001.04-		MT/AT		F	Hatchback Engine F5R700/F5R701	GC050079	Outer Joint	27	32	56.5	92	62.5	I	
2.0 16V iDE (103 kW)	2001.04-		MT	R	F	Hatchback Engine F5R700/F5R701	GDS50226	Drive Shaft	27	23	56.5	92	802		
	2001.04-				R	F	Hatchback Engine F5R700/F5R701	GDS50219	Drive Shaft	27	23	56.5	91.5	793.5	
	2001.04-					Hatchback Engine F5R700/F5R701	GC050083	Outer Joint	27	30	56.5	91.5	59	I	
	2002.11-	2005.02		L	F	Hatchback Engine F4R764/F4R765/F4R786/F4R787	GDS50207	Drive Shaft	27	37.1	56.5	91.5	632		
2.0 16V Turbo (120 kW)	2002.11-	2005.02	MT	R	F	Hatchback Engine F4R764/F4R765/F4R786/F4R787	GDS50257	Drive Shaft	27	39	56.5	92	968		
	2005.08-				F	Hatchback Engine M9R740	GC050041	Outer Joint	27	37	56.5	93	72	I	
2.0 DCi (110 kW)	2005.08-			R	F	Hatchback Engine M9R740	GDS50518	Drive Shaft	27	39	56.8	90	985		
	2005.08-			R	F	Hatchback Engine M9R740	GCI50087	Inner Joint	39	35	30	367	89.5		
	2005.08-			R	F	Hatchback Engine M9R740	GC099291	Outer Joint	27	37	56.8	90	73	I	
	2005.11-	2007.08	MT	L	F	Hatchback Engine M9R760	GDS50496	Drive Shaft	27	39	56.5	90.5	640		
2.0 DCi (127 kW)	2005.11-	2007.08	MT	R	F	Hatchback Engine M9R760	GDS50380	Drive Shaft	27	39	56.7	86.5	985		
	2005.11-	2007.08		R	F	Hatchback Engine M9R760	GDS50518	Drive Shaft	27	39	56.8	90	985		
	2005.11-	2007.08		R	F	Hatchback Engine M9R760	GCI50087	Inner Joint	39	35	30	367	89.5		
	2005.11-	2007.08		R	F	Hatchback Engine M9R760	GC099291	Outer Joint	27	37	56.8	90	73	I	
	2005.11-	2007.08				Hatchback Engine M9R760	GC050131	Outer Joint	27	36	56.7	86.5	66	I	
	2005.02-	2007.07			F	Hatchback Engine G9T600/G9T605/G9T706/G9T707	GC050113	Outer Joint	27	35	56.5	91.5	71	I	
2.2 DCi (102 kW)	2005.02-	2007.07		L	F	Hatchback Engine G9T600/G9T605/G9T706/G9T707	GDS50256	Drive Shaft	27	37.1	56.5	92	593		
	2005.02-	2007.07	AT	L	F	Hatchback Engine G9T600/G9T605/G9T706/G9T707	GDS50471	Drive Shaft	27	26	56.8	90	619		
	2005.02-	2007.07	AT	R	F	Hatchback Engine G9T600/G9T605/G9T706/G9T707	GDS50469	Drive Shaft	27	26	56.8	90	982		
	2001.10-		MT/AT		F	Hatchback Engine G9T700/G9T702	GC050041	Outer Joint	27	37	56.5	93	72	I	
2.2 DCi (110 kW)	2001.10-			L	F	Hatchback Engine G9T700/G9T702	GDS50256	Drive Shaft	27	37.1	56.5	92	593		
	2001.10-		4AT/5AT	R	F	Hatchback Engine G9T700/G9T702	GDS50330	Drive Shaft	27	26	56.5	92	984		
	2001.10-		AT	L	F	Hatchback Engine G9T700/G9T702	GDS50471	Drive Shaft	27	26	56.8	90	619		
	2001.10-		AT	R	F	Hatchback Engine G9T700/G9T702	GDS50469	Drive Shaft	27	26	56.8	90	982		
	2004.04-	2005.10		L	F	Hatchback Engine G9T600	GDS50256	Drive Shaft	27	37.1	56.5	92	593		
2.2 DCi (85 kW)	2001.03-		AT	L	F	Hatchback Engine L7X731	GDS50471	Drive Shaft	27	26	56.8	90	619		
3.0 V6 24V (152 kW)	2001.03-		AT	R	F	Hatchback Engine L7X731	GDS50469	Drive Shaft	27	26	56.8	90	982		
<b>LAGUNA II SPORT TOURER (KG0/1_)</b>															
1.6 16V (79 kW)	2001.03-		4AT/5AT	L	F	Estate Engine K4M710/K4M714	GDS50328	Drive Shaft	27	26	56.5	91.5	697		
	2001.03-		5MT	L	F	Estate Engine K4M710/K4M714	GDS50446	Drive Shaft	27	29.95	56.5	91.5	719		
	2001.03-		4AT/5AT	R	F	Estate Engine K4M710/K4M714	GDS50329	Drive Shaft	27	23	56.5	91.5	824		
	2001.03-		MT	R	F	Estate Engine K4M710/K4M714	GDS50219	Drive Shaft	27	23	56.5	91.5	793.5		
	2001.03-					Estate Engine K4M710/K4M714	GC050083	Outer Joint	27	30	56.5	91.5	59	I	
1.6 16V (82 kW)	2005.02-		5MT	L	F	Estate Engine K4M716	GDS50446	Drive Shaft	27	29.95	56.5	91.5	719		
	2005.02-		MT	R	F	Estate Engine K4M716	GDS50219	Drive Shaft	27	23	56.5	91.5	793.5		
	2005.02-					Estate Engine K4M716	GC050083	Outer Joint	27	30	56.5	91.5	59	I	
1.8 16V (85 kW)	2001.03-		AT		F	Estate Engine F4P770/F4P771/F4P774/F4P775	GC050079	Outer Joint	27	32	56.5	92	62.5	I	
	2001.03-		MT	L	F	Estate Engine F4P770/F4P771/F4P774/F4P775	GDS50208	Drive Shaft	27	29.95	56.5	92	723		
	2001.03-		MT	R	F	Estate Engine F4P770/F4P771/F4P774/F4P775	GDS50226	Drive Shaft	27	23	56.5	92	802		





		TRANSM	L/R	F/R		G-AP Ref.	PRODUCT	ABS	Technical Specifications									
									YEAR	A	B	C	H	L	P			
<b>RENAULT</b>																		
<b>LAGUNA II SPORT TOURER (KG0/1_)</b>																		
1.8 16V (85 kW)	2001.03-		AT	R	F	Estate Engine F4P770/F4P771/F4P774/F4P775	GDS50219	Drive Shaft		27	23	56.5	91.5	793.5				
1.8 16V (86 kW)	2001.03-				F	Estate Engine F4P770	GC050079	Outer Joint		27	32	56.5	92	62.5	I			
1.8 16V (88 kW)	2001.03-		5MT		F	Estate Engine F4P770/F4P773	GC050079	Outer Joint		27	32	56.5	92	62.5	I			
	2001.03-		5MT/6MT	L	F	Estate Engine F4P770/F4P773	GDS50208	Drive Shaft		27	29.95	56.5	92	723				
	2001.03-		5MT/6MT	R	F	Estate Engine F4P770/F4P773	GDS50226	Drive Shaft		27	23	56.5	92	802				
	2001.03-		AT	L	F	Estate Engine F4P770/F4P773	GDS50281	Drive Shaft		27	26	56.5	92	700				
	2001.03-		AT	R	F	Estate Engine F4P770/F4P773	GDS50509	Drive Shaft		27	26	56.7	91	822				
	2001.03-		MT	R	F	Estate Engine F4P770/F4P773	GDS50219	Drive Shaft		27	23	56.5	91.5	793.5				
	2001.03-		MT/AT			Estate Engine F4P770/F4P773	GC050083	Outer Joint		27	30	56.5	91.5	59	I			
	2001.03-					Estate Engine F4P770/F4P774	GDS50281	Drive Shaft		27	26	56.5	92	700				
1.8 16V (89 kW)	2001.03-		AT	L	F	Estate Engine F4P770/F4P774	GDS50509	Drive Shaft		27	26	56.7	91	822				
	2001.03-		AT	R	F	Estate Engine F4P770/F4P774	GDS50219	Drive Shaft		27	23	56.5	91.5	793.5				
	2001.03-		MT	R	F	Estate Engine F4P770/F4P774	GDS50219	Drive Shaft		27	23	56.5	91.5	793.5				
	2001.03-				F	Estate Engine F4P770/F4P774	GC050083	Outer Joint		27	30	56.5	91.5	59	I			
	2001.03-				F	Estate Engine F4P770/F4P774	GC050079	Outer Joint		27	32	56.5	92	62.5	I			
	2001.03-		MT	L	F	Estate Engine F4P770/F4P774	GDS50208	Drive Shaft		27	29.95	56.5	92	723				
	2001.03-		MT	R	F	Estate Engine F4P770/F4P774	GDS50226	Drive Shaft		27	23	56.5	92	802				
1.9 DCi (66 kW)	2003.08-2007.09		MT	R	F	Estate	GDS50219	Drive Shaft		27	23	56.5	91.5	793.5				
	2003.08-2007.09		MT/AT			Estate	GC050083	Outer Joint		27	30	56.5	91.5	59	I			
1.9 DCi (68 kW)	2004.03-				F	Estate Engine F9Q664	GC050113	Outer Joint		27	35	56.5	91.5	71	I			
	2004.03-		MT	L	F	Estate Engine F9Q664	GDS50207	Drive Shaft		27	37.1	56.5	91.5	632				
	2004.03-		MT	R	F	Estate Engine F9Q664	GDS50228	Drive Shaft		27	39	56.5	90.5	967				
	2004.03-		MT	R	F	Estate Engine F9Q664	GDS50219	Drive Shaft		27	23	56.5	91.5	793.5				
	2004.03-		5MT			Estate Engine F9Q664	GC050083	Outer Joint		27	30	56.5	91.5	59	I			
1.9 DCi (74 kW)	2001.10-				F	Estate Engine F9Q754	GC050079	Outer Joint		27	32	56.5	92	62.5	I			
	2001.10-		MT	L	F	Estate Engine F9Q754	GDS50207	Drive Shaft		27	37.1	56.5	91.5	632				
	2001.10-		MT	R	F	Estate Engine F9Q754	GDS50228	Drive Shaft		27	39	56.5	90.5	967				
	2001.10-		MT	R	F	Estate Engine F9Q754	GDS50219	Drive Shaft		27	23	56.5	91.5	793.5				
	2001.10-		5MT			Estate Engine F9Q754	GC050083	Outer Joint		27	30	56.5	91.5	59	I			
1.9 DCi (77 kW)	2001.06-		MT/AT		F	Estate Engine F9Q752	GC050079	Outer Joint		27	32	56.5	92	62.5	I			
	2001.06-		5MT/6MT	R	F	Estate Engine F9Q752	GDS50226	Drive Shaft		27	23	56.5	92	802				
1.9 DCi (79 kW)	2001.03-		5MT		F	Estate Engine F9Q718/F9Q754	GC050041	Outer Joint		27	37	56.5	93	72	I			
	2001.03-			L	F	Estate Engine F9Q718/F9Q754	GDS50207	Drive Shaft		27	37.1	56.5	91.5	632				
	2001.03-			R	F	Estate Engine F9Q718/F9Q754	GDS50228	Drive Shaft		27	39	56.5	90.5	967				
1.9 DCi (81 kW)	2005.01-				F	Estate Engine F9Q674/F9Q758	GC050113	Outer Joint		27	35	56.5	91.5	71	I			
	2005.01-		MT	L	F	Estate Engine F9Q674/F9Q758	GDS50207	Drive Shaft		27	37.1	56.5	91.5	632				
	2005.01-		MT	R	F	Estate Engine F9Q674/F9Q758	GDS50228	Drive Shaft		27	39	56.5	90.5	967				
1.9 DCi (88 kW)	2001.03-				F	Estate Engine F9Q670/F9Q674/F9Q750	GC050113	Outer Joint		27	35	56.5	91.5	71	I			
	2001.03-		5MT/6MT	L	F	Estate Engine F9Q670/F9Q674/F9Q750	GDS50207	Drive Shaft		27	37.1	56.5	91.5	632				
	2001.03-		5MT/6MT	R	F	Estate Engine F9Q670/F9Q674/F9Q750	GDS50228	Drive Shaft		27	39	56.5	90.5	967				
	2001.03-		MT	R	F	Estate Engine F9Q670/F9Q674/F9Q750	GDS50257	Drive Shaft		27	39	56.5	92	968				
	2001.03-			R	F	Estate Engine F9Q670/F9Q674/F9Q750	GDS99266	Drive Shaft		27	39	56.5	91.5	967				
1.9 DCi (96 kW)	2005.02-2007.04				F	Estate Engine F9Q758/F9Q759	GC050079	Outer Joint		27	32	56.5	92	62.5	I			
	2005.02-2007.04		MT	L	F	Estate Engine F9Q758/F9Q759	GDS50207	Drive Shaft		27	37.1	56.5	91.5	632				
	2005.02-2007.04		MT	R	F	Estate Engine F9Q758/F9Q759	GDS50257	Drive Shaft		27	39	56.5	92	968				
	2005.02-2007.04		MT	R	F	Estate Engine F9Q758/F9Q759	GDS50228	Drive Shaft		27	39	56.5	90.5	967				
2.0 16V (99 kW)	2002.06-2007.07				F	Estate Engine F4R712/F4R713/F4R714/F4R715	GC050079	Outer Joint		27	32	56.5	92	62.5	I			
	2002.06-2007.07			L	F	Estate Engine F4R712/F4R713/F4R714/F4R715	GDS50208	Drive Shaft		27	29.95	56.5	92	723				
	2002.06-2007.07		AT	L	F	Estate Engine F4R712/F4R713/F4R714/F4R715	GDS50281	Drive Shaft		27	26	56.5	92	700				
	2002.06-2007.07			R	F	Estate Engine F4R712/F4R713/F4R714/F4R715	GDS50226	Drive Shaft		27	23	56.5	92	802				
	2002.06-2007.07			R	F	Estate Engine F4R712/F4R713/F4R714/F4R715	GDS50445	Drive Shaft		27	23	56.5	92	791				
	2002.06-2007.07		AT	R	F	Estate Engine F4R712/F4R713/F4R714/F4R715	GDS50509	Drive Shaft		27	26	56.7	91	822				
2.0 16V iDE (103 kW)	2001.04-		MT/AT		F	Estate Engine F5R700/F5R701	GC050079	Outer Joint		27	32	56.5	92	62.5	I			
	2001.04-		MT	R	F	Estate Engine F5R700/F5R701	GDS50226	Drive Shaft		27	23	56.5	92	802				
	2001.04-		MT	R	F	Estate Engine F5R700/F5R701	GDS50219	Drive Shaft		27	23	56.5	91.5	793.5				
	2001.04-					Estate Engine F5R700/F5R701	GC050083	Outer Joint		27	30	56.5	91.5	59	I			
2.0 16V Turbo (120 kW)	2002.11-2005.02			L	F	Estate Engine F4R764/F4R765/F4R786/F4R787	GDS50207	Drive Shaft		27	37.1	56.5	91.5	632				
	2002.11-2005.02		MT	R	F	Estate Engine F4R764/F4R765/F4R786/F4R787	GDS50257	Drive Shaft		27	39	56.5	92	968				
2.0 DCi (110 kW)	2005.08-				F	Estate Engine M9R740	GC050041	Outer Joint		27	37	56.5	93	72	I			
	2005.08-			R	F	Estate Engine M9R740	GDS50518	Drive Shaft		27	39	56.8	90	985				
	2005.08-			R	F	Estate Engine M9R740	GCI50087	Inner Joint		39	35	30	367	89.5				
	2005.08-			R	F	Estate Engine M9R740	GC099291	Outer Joint		27	37	56.8	90	73	I			









		TRANSM	L/R	F/R		G-AP Ref.	PRODUCT	ABS	Technical Specifications						
									YEAR	A	B	C	H	L	P
<b>RENAULT</b>															
<b>LAGUNA II SPORT TOURER (KG0/1_)</b>															
2.0 DCi (127 kW)	2005.11-	2007.08			R	F	Estate Engine M9R760	GDS50518	Drive Shaft	27	39	56.8	90	985	
	2005.11-	2007.08			R	F	Estate Engine M9R760	GC150087	Inner Joint	39	35	30	367	89.5	
	2005.11-	2007.08			R	F	Estate Engine M9R760	GC099291	Outer Joint	27	37	56.8	90	73	I
2.2 DCi (102 kW)	2005.02-	2006.02				F	Estate Engine G9T600/G9T706/G9T707	GC050113	Outer Joint	27	35	56.5	91.5	71	I
	2005.02-	2006.02			L	F	Estate Engine G9T600/G9T706/G9T707	GDS50256	Drive Shaft	27	37.1	56.5	92	593	
	2005.02-	2006.02	AT		L	F	Estate Engine G9T600/G9T706/G9T707	GDS50471	Drive Shaft	27	26	56.8	90	619	
	2005.02-	2006.02	AT		R	F	Estate Engine G9T600/G9T706/G9T707	GDS50469	Drive Shaft	27	26	56.8	90	982	
2.2 DCi (110 kW)	2001.10-		MT/AT			F	Estate Engine G9T702	GC050041	Outer Joint	27	37	56.5	93	72	I
	2001.10-				L	F	Estate Engine G9T702	GDS50256	Drive Shaft	27	37.1	56.5	92	593	
	2001.10-		4AT/5AT		R	F	Estate Engine G9T702	GDS50330	Drive Shaft	27	26	56.5	92	984	
	2001.10-		AT		L	F	Estate Engine G9T702	GDS50471	Drive Shaft	27	26	56.8	90	619	
2.2 DCi (85 kW)	2004.04-	2005.10			L	F	Estate Engine G9T600	GDS50256	Drive Shaft	27	37.1	56.5	92	593	
3.0 V6 24V (152 kW)	2001.03-		AT		L	F	Estate Engine L7X731	GDS50471	Drive Shaft	27	26	56.8	90	619	
<b>LAGUNA III (BT0/1)</b>															
1.5 DCi (81 kW)	2007.10-		MT		L	F	Hatchback Engine K9K780	GDS50378	Drive Shaft	27	26	56.7	91	687	
	2007.10-		MT		R	F	Hatchback Engine K9K780	GDS50377	Drive Shaft	27	26	56.7	91	940	
	2007.10-						Hatchback Engine K9K780	GC050130	Outer Joint	27	33	56.7	91	61	I
2.0 DCi (110 kW)	2007.10-		MT		L	F	Hatchback Engine M9R802/M9R805/M9R814	GDS50496	Drive Shaft	27	39	56.5	90.5	640	
	2007.10-		MT		R	F	Hatchback Engine M9R802/M9R805/M9R814	GDS50380	Drive Shaft	27	39	56.7	86.5	985	
	2007.10-						Hatchback Engine M9R802/M9R805/M9R814	GC050131	Outer Joint	27	36	56.7	86.5	66	I
2.0 DCi (127 kW)	2008.01-		MT		L	F	Hatchback Engine M9R 800/M9R 809/M9R 815	GDS50496	Drive Shaft	27	39	56.5	90.5	640	
	2008.01-				R	F	Hatchback Engine M9R 800/M9R 809/M9R 815	GDS50380	Drive Shaft	27	39	56.7	86.5	985	
	2008.01-						Hatchback Engine M9R 800/M9R 809/M9R 815	GC050131	Outer Joint	27	36	56.7	86.5	66	I
2.0 DCi (96 kW)	2007.10-		MT		L	F	Hatchback Engine M9R742/M9R744/M9R802	GDS50496	Drive Shaft	27	39	56.5	90.5	640	
	2007.10-		MT		R	F	Hatchback Engine M9R742/M9R744/M9R802	GDS50380	Drive Shaft	27	39	56.7	86.5	985	
	2007.10-						Hatchback Engine M9R742/M9R744/M9R802	GC050131	Outer Joint	27	36	56.7	86.5	66	I
2.0 DCi GT (131 kW)	2008.03-				L	F	Hatchback Engine M9R 816	GDS50496	Drive Shaft	27	39	56.5	90.5	640	
	2008.03-						Hatchback Engine M9R 816	GC050131	Outer Joint	27	36	56.7	86.5	66	I
2.0 GT (150 kW)	2008.03-					Hatchback Engine F4R 800	GC050131	Outer Joint	27	36	56.7	86.5	66	I	
<b>LAGUNA III (BTO/1)</b>															
1.5 DCi (81 kW)	2007.10-							GC050131	Outer Joint	27	36	56.7	86.5	66	I
2.0 DCi (110 kW)	2007.10-							GC050108	Outer Joint	27	35	56.5	90.5	71	I
2.0 DCi (127 kW)	2007.10-							GC050108	Outer Joint	27	35	56.5	90.5	71	I
<b>LAGUNA III GRANDTOUR (KT0/1)</b>															
2.0 DCi (110 kW)	2007.10-		MT		L	F	Estate Engine M9R802/M9R805/M9R814	GDS50496	Drive Shaft	27	39	56.5	90.5	640	
	2007.10-		MT		R	F	Estate Engine M9R802/M9R805/M9R814	GDS50380	Drive Shaft	27	39	56.7	86.5	985	
	2007.10-						Estate Engine M9R802/M9R805/M9R814	GC050131	Outer Joint	27	36	56.7	86.5	66	I
2.0 DCi (127 kW)	2008.01-		MT		L	F	Estate Engine M9R 800/M9R 809/M9R 815	GDS50496	Drive Shaft	27	39	56.5	90.5	640	
	2008.01-		MT		R	F	Estate Engine M9R 800/M9R 809/M9R 815	GDS50380	Drive Shaft	27	39	56.7	86.5	985	
	2008.01-						Estate Engine M9R 800/M9R 809/M9R 815	GC050131	Outer Joint	27	36	56.7	86.5	66	I
2.0 DCi (96 kW)	2007.10-		MT		L	F	Estate Engine M9R742/M9R744/M9R802	GDS50496	Drive Shaft	27	39	56.5	90.5	640	
	2007.10-		MT		R	F	Estate Engine M9R742/M9R744/M9R802	GDS50380	Drive Shaft	27	39	56.7	86.5	985	
	2007.10-						Estate Engine M9R742/M9R744/M9R802	GC050131	Outer Joint	27	36	56.7	86.5	66	I
2.0 DCi GT (131 kW)	2008.03-		MT		L	F	Estate Engine M9R 816/M9R 820	GDS50496	Drive Shaft	27	39	56.5	90.5	640	
	2008.03-						Estate Engine M9R 816/M9R 820	GC050131	Outer Joint	27	36	56.7	86.5	66	I
2.0 GT (150 kW)	2008.03-					Estate Engine F4R 800	GC050131	Outer Joint	27	36	56.7	86.5	66	I	
<b>LAGUNA III SPORT TOURER (KT0/1)</b>															
1.5 DCi (81 kW)	2007.10-		MT		L	F	Estate Engine K9K780	GDS50378	Drive Shaft	27	26	56.7	91	687	
	2007.10-		MT		R	F	Estate Engine K9K780	GDS50377	Drive Shaft	27	26	56.7	91	940	
	2007.10-						Estate Engine K9K780	GC050130	Outer Joint	27	33	56.7	91	61	I
<b>LOGAN (KS_)</b>															
1.5 DCi (50 kW)	2007.04-				L	F	Estate Engine K9K792	GDS50353	Drive Shaft	23	26	49	86	649	
	2007.04-				R	F	Estate Engine K9K792	GDS50354	Drive Shaft	23	26	49	86	897	
	2007.04-		MT		L	F	Estate Engine K9K792	GDS50570	Drive Shaft	23	26	49	83.5	647	
1.6 (77 kW)	2007.04-		MT		L	F	Estate Engine K7M697	GDS50570	Drive Shaft	23	26	49	83.5	647	
<b>LOGAN (LS, KS), SW</b>															
1.5 DCi (50 kW)	2007.04-							GC099085	Outer Joint	23	30	49	86	59	I
1.6 (77 kW)	2007.04-							GC099085	Outer Joint	23	30	49	86	59	I
<b>MAGANE</b>															
2.0 i								GC050034	Outer Joint	21	22	51.5	83	56.5	O
								GC050062	Outer Joint	26T	21	22	51.5	83	56.5

		TRANSM	L/R	F/R		G-AP Ref.	PRODUCT	ABS	Technical Specifications									
									YEAR	A	B	C	H	L	P			
<b>RENAULT</b>																		
<b>MAGANE</b>																		
2.0 i						GC050063	Outer Joint	44T	21	22	51.5	83	56.5	O				
<b>MASTER I (P__)</b>																		
2.0 (58 kW)	1986.10-	1998.07		L/R	F	Platform/Chassis Engine J5R728	GDS50003	Drive Shaft	32	27	65	113	825					
2.0 (59 kW)	1982.10-	1986.09		L/R	R	Platform/Chassis Engine 829730	GDS50003	Drive Shaft	32	27	65	113	825					
2.5 D (52 kW)	1980.09-	1998.07		L/R	R	Platform/Chassis Engine 8140.61.2300/S8U731	GDS50003	Drive Shaft	32	27	65	113	825					
<b>MASTER I (T__)</b>																		
2.2 (67 kW)	1980.08-	1998.07		L/R	F	Bus Engine J7T782/J7T788	GDS50003	Drive Shaft	32	27	65	113	825					
2.5 TD (69 kW)	1989.08-	1998.07		L/R	F	Bus Engine 8140.27.2500/8140.27.2510/S9U714	GDS50003	Drive Shaft	32	27	65	113	825					
2.5 TD (72 kW)	1989.08-	1998.07		L/R	F	Bus Engine 8140.27.2580/S9U702	GDS50003	Drive Shaft	32	27	65	113	825					
2.0 (58 kW)	1986.10-	1998.07		L/R	F	Bus Engine J5R718	GDS50003	Drive Shaft	32	27	65	113	825					
2.0 (59 kW)	1980.08-	1986.09		L/R	F	Bus Engine 829731	GDS50003	Drive Shaft	32	27	65	113	825					
2.1 D (44 kW)	1980.08-	1998.07		L/R	F	Bus Engine J8S330	GDS50003	Drive Shaft	32	27	65	113	825					
2.4 D (52 kW)	1980.08-	1989.08		L/R	F	Bus Engine 8140.61.2300/S8U731	GDS50003	Drive Shaft	32	27	65	113	825					
2.5 D (55 kW)	1989.08-	1998.07		L/R	F	Bus Engine 8140.67.2510/S8U742	GDS50003	Drive Shaft	32	27	65	113	825					
<b>MASTER I VAN (T__)</b>																		
2.5 D (55 kW)	1989.08-	1998.07		L/R	F	Box Engine 8140.67.2510/S8U742	GDS50003	Drive Shaft	32	27	65	113	825					
2.5 TD (69 kW)	1989.08-	1998.07		L/R	F	Box Engine 8140.27.2500/8140.27.2510/S9U714	GDS50003	Drive Shaft	32	27	65	113	825					
2.5 TD (72 kW)	1989.08-	1998.07		L/R	F	Box Engine 8140.27.2580/S9U702	GDS50003	Drive Shaft	32	27	65	113	825					
2.0 (58 kW)	1986.10-	1998.07		L/R	F	Box Engine J5R718	GDS50003	Drive Shaft	32	27	65	113	825					
2.0 (59 kW)	1980.08-	1986.10		L/R	F	Box Engine 829731	GDS50003	Drive Shaft	32	27	65	113	825					
2.4 D (52 kW)	1980.08-	1989.08		L/R	F	Box Engine 8140.61.2300/S8U731	GDS50003	Drive Shaft	32	27	65	113	825					
<b>MASTER II</b>																		
1.9 DCi (60 kW)	2001.01-						GC044026	Outer Joint	51T	28	36	65	96	71	I			
1.9 DTi (59 kW)	2000.09-						GC044026	Outer Joint	51T	28	36	65	96	71	I			
2.2 DCi (66 kW)	2000.09-						GC044026	Outer Joint	51T	28	36	65	96	71	I			
2.5 DCi (84 kW)	2001.10-						GC044026	Outer Joint	51T	28	36	65	96	71	I			
2.8 DTi (84 kW)	2000.03-					Ch-B000462	GC044026	Outer Joint	51T	28	36	65	96	71	I			
<b>MASTER II (ED/HD/UD)</b>																		
2.5 D (59 kW)	1998.07-	2001.01	MT		F	Platform/Chassis Engine S8U770	GC044008	Outer Joint	51T	28	27	67.1	93.5	64.5	I			
	1998.07-	2001.01	MT		F	Platform/Chassis Engine S8U770	GC050014	Outer Joint		28	27	67.1	93.5	64.5	I			
2.5 DCi (107 kW)	2006.08-		MT/AT	L	F	Platform/Chassis Engine G9U632	GDS99286	Drive Shaft	51T	28	39	65	96	700				
	2006.08-		MT	R	F	Platform/Chassis Engine G9U632	GDS50066	Drive Shaft		28	39	65	96	1142				
	2006.08-			R	F	Platform/Chassis Engine G9U632	GDS50366	Drive Shaft	51T	28	39	65	96	1116				
2.5 DCi (73 kW)	2003.10-		MT/AT	L	F	Platform/Chassis Engine G9U754	GDS99286	Drive Shaft	51T	28	39	65	96	700				
	2003.10-		MT	R	F	Platform/Chassis Engine G9U754	GDS50066	Drive Shaft		28	39	65	96	1142				
	2003.10-					Platform/Chassis Engine G9U754	GC044026	Outer Joint	51T	28	36	65	96	71	I			
2.5 DCi (74 kW)	2006.08-		MT	R	F	Platform/Chassis Engine G9U754	GDS50066	Drive Shaft		28	39	65	96	1142				
	2006.08-					Platform/Chassis Engine G9U754	GC044026	Outer Joint	51T	28	36	65	96	71	I			
2.5 DCi (84 kW)	2001.10-		MT		F	Platform/Chassis Engine G9U720/G9U754	GC044026	Outer Joint	51T	28	36	65	96	71	I			
	2001.10-		MT		F	Platform/Chassis Engine G9U720/G9U754	GC044025	Outer Joint		28	36	65	96	71	I			
	2001.10-		MT	L	F	Platform/Chassis Engine G9U720/G9U754	GDS44005	Drive Shaft	51T	28	37.1	65	96	670				
	2001.10-		MT	L	F	Platform/Chassis Engine G9U720/G9U754	GDS50010	Drive Shaft		28	37.1	67.1	93.5	669				
	2001.10-		MT	R	F	Platform/Chassis Engine G9U720/G9U754	GDS44004	Drive Shaft	51T	28	39	67.1	93.5	1118				
	2001.10-		MT	R	F	Platform/Chassis Engine G9U720/G9U754	GDS50011	Drive Shaft		28	39	67.1	93.5	1118				
	2001.10-		MT	R	F	Platform/Chassis Engine G9U720/G9U754	GDS50066	Drive Shaft		28	39	65	96	1142				
	2004.01-		MT/AT	L	F	Platform/Chassis Engine G9U750	GDS99286	Drive Shaft	51T	28	39	65	96	700				
	2004.01-		MT	R	F	Platform/Chassis Engine G9U750	GDS50066	Drive Shaft		28	39	65	96	1142				
	2004.01-					Platform/Chassis Engine G9U750	GC044026	Outer Joint	51T	28	36	65	96	71	I			
2.5 DCi (88 kW)	2006.08-		MT/AT	L	F	Platform/Chassis Engine G9U650	GDS99286	Drive Shaft	51T	28	39	65	96	700				
	2006.08-		MT	R	F	Platform/Chassis Engine G9U650	GDS50066	Drive Shaft		28	39	65	96	1142				
	2006.08-			R	F	Platform/Chassis Engine G9U650	GDS50366	Drive Shaft	51T	28	39	65	96	1116				
2.8 DTi (84 kW)	1998.07-	2001.10	MT		F	Platform/Chassis Engine S9W702	GC044008	Outer Joint	51T	28	27	67.1	93.5	64.5	I			
	1998.07-	2001.10	MT		F	Platform/Chassis Engine S9W702	GC050014	Outer Joint		28	27	67.1	93.5	64.5	I			
3.0 DCi (100 kW)	2003.10-		MT	L	F	Platform/Chassis Engine ZD3202	GDS50057	Drive Shaft	51T	28	39	65	96	687				
	2003.10-		MT	R	F	Platform/Chassis Engine ZD3202	GDS50059	Drive Shaft	51T	28	39	65	96	1126				
<b>MASTER II (JD)</b>																		
1.9 DCi (60 kW)	2001.11-		MT		F	Bus Engine F9Q772/F9Q774	GC044026	Outer Joint	51T	28	36	65	96	71	I			
	2001.11-		MT		F	Bus Engine F9Q772/F9Q774	GC044025	Outer Joint		28	36	65	96	71	I			
	2001.11-		MT	L	F	Bus Engine F9Q772/F9Q774	GDS44005	Drive Shaft	51T	28	37.1	65	96	670				
	2001.11-		MT	L	F	Bus Engine F9Q772/F9Q774	GDS50246	Drive Shaft		28	37.1	65	96	644				
	2001.11-		MT	L	F	Bus Engine F9Q772/F9Q774	GDS50058	Drive Shaft	51T	28	37.1	65	96	644				



		TRANSM	L/R	F/R		G-AP Ref.	PRODUCT	ABS	Technical Specifications						
									YEAR	A	B	C	H	L	P
<b>RENAULT MASTER II (JD)</b>															
1.9 DCi (60 kW)	2001.11-		MT	L	F	Bus Engine F9Q772/F9Q774	GDS50010	Drive Shaft		28	37.1	67.1	93.5	669	
	2001.11-		MT	R	F	Bus Engine F9Q772/F9Q774	GDS44022	Drive Shaft		28	39	67.1	93.5	1147	
	2001.11-		MT	R	F	Bus Engine F9Q772/F9Q774	GDS44017	Drive Shaft	51T	28	39	67.1	93.5	1147	
	2001.11-		MT	R	F	Bus Engine F9Q772/F9Q774	GDS44021	Drive Shaft		28	39	65	96	1126	
	2001.11-		MT	R	F	Bus Engine F9Q772/F9Q774	GDS50060	Drive Shaft	51T	28	39	65	96	1126	
2.5 D (59 kW)	1998.07-2001.01				F	Bus Engine S8U770	GC044008	Outer Joint	51T	28	27	67.1	93.5	64.5 I	
	1998.07-2001.01				F	Bus Engine S8U770	GC050014	Outer Joint		28	27	67.1	93.5	64.5 I	
2.5 DCi (107 kW)	2006.08-				L	F	Bus Engine G9U632	GDS50166	Drive Shaft	51T	28	37.1	65	96	663
	2006.08-				R	F	Bus Engine G9U632	GDS99151	Drive Shaft	51T	28	39	65	96	1144
	2006.08-		MT/AT		L	F	Bus Engine G9U632	GDS99286	Drive Shaft	51T	28	39	65	96	700
	2006.08-		MT		R	F	Bus Engine G9U632	GDS50066	Drive Shaft		28	39	65	96	1142
	2006.08-				R	F	Bus Engine G9U632	GDS50366	Drive Shaft	51T	28	39	65	96	1116
2.5 DCi (73 kW)	2003.10-		MT		L	F	Bus Engine G9U754	GDS44012	Drive Shaft		28	37.1	65	96	663
	2003.10-		MT		L	F	Bus Engine G9U754	GDS50166	Drive Shaft	51T	28	37.1	65	96	663
	2003.10-		MT		R	F	Bus Engine G9U754	GDS50249	Drive Shaft		28	39	65	96	1144
	2003.10-		MT		R	F	Bus Engine G9U754	GDS99151	Drive Shaft	51T	28	39	65	96	1144
	2003.10-		MT/AT		L	F	Bus Engine G9U754	GDS99286	Drive Shaft	51T	28	39	65	96	700
	2003.10-		MT		R	F	Bus Engine G9U754	GDS50066	Drive Shaft		28	39	65	96	1142
	2003.10-				R	F	Bus Engine G9U754	GDS50366	Drive Shaft	51T	28	39	65	96	1116
2.5 DCi (74 kW)	2006.08-		MT/AT		L	F	Bus Engine G9U754	GDS99286	Drive Shaft	51T	28	39	65	96	700
	2006.08-		MT		R	F	Bus Engine G9U754	GDS50066	Drive Shaft		28	39	65	96	1142
	2006.08-		MT		R	F	Bus Engine G9U754	GDS50366	Drive Shaft	51T	28	39	65	96	1116
	2006.08-						Bus Engine G9U754	GC044026	Outer Joint	51T	28	36	65	96	71 I
2.5 DCi (84 kW)	2001.10-		MT			F	Bus Engine G9U720/G9U754	GC044026	Outer Joint	51T	28	36	65	96	71 I
	2001.10-		MT			F	Bus Engine G9U720/G9U754	GC044025	Outer Joint		28	36	65	96	71 I
	2001.10-		MT		L	F	Bus Engine G9U720/G9U754	GDS44005	Drive Shaft	51T	28	37.1	65	96	670
	2001.10-		MT		L	F	Bus Engine G9U720/G9U754	GDS50010	Drive Shaft		28	37.1	67.1	93.5	669
	2001.10-		MT		R	F	Bus Engine G9U720/G9U754	GDS44004	Drive Shaft	51T	28	39	67.1	93.5	1118
	2001.10-		MT		R	F	Bus Engine G9U720/G9U754	GDS50011	Drive Shaft		28	39	67.1	93.5	1118
	2001.10-		MT		R	F	Bus Engine G9U720/G9U754	GDS50066	Drive Shaft		28	39	65	96	1142
	2004.01-		MT/AT		L	F	Bus Engine G9U750	GDS99286	Drive Shaft	51T	28	39	65	96	700
2.5 DCi (88 kW)	2006.08-				L	F	Bus Engine G9U650	GDS50166	Drive Shaft	51T	28	37.1	65	96	663
	2006.08-				R	F	Bus Engine G9U650	GDS99151	Drive Shaft	51T	28	39	65	96	1144
	2006.08-		MT/AT		L	F	Bus Engine G9U650	GDS99286	Drive Shaft	51T	28	39	65	96	700
	2006.08-		MT		R	F	Bus Engine G9U650	GDS50066	Drive Shaft		28	39	65	96	1142
	2006.08-				R	F	Bus Engine G9U650	GDS50366	Drive Shaft	51T	28	39	65	96	1116
2.8 DTi (84 kW)	1998.07-2001.10		MT			F	Bus Engine S9W702	GC044008	Outer Joint	51T	28	27	67.1	93.5	64.5 I
	1998.07-2001.10		MT			F	Bus Engine S9W702	GC050014	Outer Joint		28	27	67.1	93.5	64.5 I
3.0 DCi (100 kW)	2003.10-		MT		L	F	Bus Engine ZD3200/ZD3202	GDS50057	Drive Shaft	51T	28	39	65	96	687
	2003.10-		MT		R	F	Bus Engine ZD3200/ZD3202	GDS50059	Drive Shaft	51T	28	39	65	96	1126
<b>MASTER II VAN (FD)</b>															
1.9 DCi (60 kW)	2001.11-		MT			F	Box Engine F9Q772/F9Q774	GC044026	Outer Joint	51T	28	36	65	96	71 I
	2001.11-		MT			F	Box Engine F9Q772/F9Q774	GC044025	Outer Joint		28	36	65	96	71 I
	2001.11-		MT		L	F	Box Engine F9Q772/F9Q774	GDS44005	Drive Shaft	51T	28	37.1	65	96	670
	2001.11-		MT		L	F	Box Engine F9Q772/F9Q774	GDS50246	Drive Shaft		28	37.1	65	96	644
	2001.11-		MT		L	F	Box Engine F9Q772/F9Q774	GDS50058	Drive Shaft	51T	28	37.1	65	96	644
	2001.11-		MT		L	F	Box Engine F9Q772/F9Q774	GDS50010	Drive Shaft		28	37.1	67.1	93.5	669
	2001.11-		MT		R	F	Box Engine F9Q772/F9Q774	GDS44022	Drive Shaft		28	39	67.1	93.5	1147
	2001.11-		MT		R	F	Box Engine F9Q772/F9Q774	GDS44017	Drive Shaft	51T	28	39	67.1	93.5	1147
	2001.11-		MT		R	F	Box Engine F9Q772/F9Q774	GDS44021	Drive Shaft		28	39	65	96	1126
	2001.11-		MT		R	F	Box Engine F9Q772/F9Q774	GDS50060	Drive Shaft	51T	28	39	65	96	1126
2.5 D (59 kW)	1998.07-2001.01		MT			F	Box Engine S8U770	GC044008	Outer Joint	51T	28	27	67.1	93.5	64.5 I
	1998.07-2001.01		MT			F	Box Engine S8U770	GC050014	Outer Joint		28	27	67.1	93.5	64.5 I
2.5 DCi (107 kW)	2006.08-		MT/AT		L	F	Box Engine G9U632	GDS99286	Drive Shaft	51T	28	39	65	96	700
	2006.08-		MT		R	F	Box Engine G9U632	GDS50066	Drive Shaft		28	39	65	96	1142
	2006.08-				R	F	Box Engine G9U632	GDS50366	Drive Shaft	51T	28	39	65	96	1116
2.5 DCi (73 kW)	2003.10-		MT/AT		L	F	Box Engine G9U754	GDS99286	Drive Shaft	51T	28	39	65	96	700
	2003.10-				R	F	Box Engine G9U754	GDS50066	Drive Shaft		28	39	65	96	1142





		TRANSM	L/R	F/R		G-AP Ref.	PRODUCT	ABS	Technical Specifications							
									YEAR	A	B	C	H	L	P	
<b>RENAULT MASTER II VAN (FD)</b>																
2.5 DCi (73 kW)	2003.10-				Box Engine G9U754	GC044026	Outer Joint	51T	28	36	65	96	71	I		
2.5 DCi (74 kW)	2006.08-		MT/AT	L	F	Box Engine G9U754	GDS99286	Drive Shaft	51T	28	39	65	96	700		
	2006.08-		MT	R	F	Box Engine G9U754	GDS50066	Drive Shaft		28	39	65	96	1142		
2.5 DCi (84 kW)	2001.10-		MT		F	Box Engine G9U720/G9U754/G9U724	GC044026	Outer Joint	51T	28	36	65	96	71	I	
	2001.10-		MT		F	Box Engine G9U720/G9U754/G9U724	GC044025	Outer Joint		28	36	65	96	71	I	
	2001.10-		MT	L	F	Box Engine G9U720/G9U754/G9U724	GDS44005	Drive Shaft	51T	28	37.1	65	96	670		
	2001.10-		MT	L	F	Box Engine G9U720/G9U754/G9U724	GDS50010	Drive Shaft		28	37.1	67.1	93.5	669		
	2001.10-		MT	R	F	Box Engine G9U720/G9U754/G9U724	GDS44004	Drive Shaft	51T	28	39	67.1	93.5	1118		
	2001.10-		MT	R	F	Box Engine G9U720/G9U754/G9U724	GDS50011	Drive Shaft		28	39	67.1	93.5	1118		
	2001.10-		MT	R	F	Box Engine G9U720/G9U754/G9U724	GDS50066	Drive Shaft		28	39	65	96	1142		
	2004.01-		MT/AT	L	F	Box Engine G9U750	GDS99286	Drive Shaft	51T	28	39	65	96	700		
	2004.01-		MT	R	F	Box Engine G9U750	GDS50066	Drive Shaft		28	39	65	96	1142		
2.5 DCi (88 kW)	2006.08-		MT/AT	L	F	Box Engine G9U650	GDS99286	Drive Shaft	51T	28	39	65	96	700		
	2006.08-		MT	R	F	Box Engine G9U650	GDS50066	Drive Shaft		28	39	65	96	1142		
	2006.08-			R	F	Box Engine G9U650	GDS50366	Drive Shaft	51T	28	39	65	96	1116		
2.8 DTi (84 kW)	1998.07-2001.10		MT		F	Box Engine S9W702	GC044008	Outer Joint	51T	28	27	67.1	93.5	64.5	I	
	1998.07-2001.10		MT		F	Box Engine S9W702	GC050014	Outer Joint		28	27	67.1	93.5	64.5	I	
3.0 DCi (100 kW)	2003.10-		MT	L	F	Box Engine ZD3202	GDS50057	Drive Shaft	51T	28	39	65	96	687		
	2003.10-		MT	R	F	Box Engine ZD3202	GDS50059	Drive Shaft	51T	28	39	65	96	1126		
<b>MASTER III</b>																
2.5 DCi	2009-			L	F		GCI50045	Inner Joint		39	27	39	74	109		
	2009-			L/R	F		GC050132	Outer Joint		31	27	70	100.5	63.5	I	
	2009-			R	F		GCI50046	Inner Joint		39	27	30	364	87		
<b>MASTER III (EV, HV, UV)</b>																
2.3 DCi (107 kW)	2010.02-			L	F	Platform/Chassis Engine M9T678/M9T680	GDS18247	Drive Shaft		31	39	70	100.5	743		
	2010.02-			R	F	Platform/Chassis Engine M9T678/M9T680	GDS18248	Drive Shaft		31	39	70	100.5	1075		
	2010.02-			R	F	Platform/Chassis Engine M9T678/M9T680	GCI50046	Inner Joint		39	27	30	364	87		
	2010.02-			R	F	Platform/Chassis Engine M9T678/M9T680	GC050132	Outer Joint		31	27	70	100.5	63.5	I	
2.3 DCi (74 kW)	2010.02-			L	F	Platform/Chassis Engine M9T670/M9T672/M9T676	GDS18247	Drive Shaft		31	39	70	100.5	743		
	2010.02-			R	F	Platform/Chassis Engine M9T670/M9T672/M9T676	GDS18248	Drive Shaft		31	39	70	100.5	1075		
	2010.02-			R	F	Platform/Chassis Engine M9T670/M9T672/M9T676	GCI50046	Inner Joint		39	27	30	364	87		
	2010.02-			R	F	Platform/Chassis Engine M9T670/M9T672/M9T676	GC050132	Outer Joint		31	27	70	100.5	63.5	I	
2.3 DCi (92 kW)	2010.02-			L	F	Platform/Chassis Engine M9T670/M9T672/M9T676	GDS18247	Drive Shaft		31	39	70	100.5	743		
	2010.02-			R	F	Platform/Chassis Engine M9T670/M9T672/M9T676	GDS18248	Drive Shaft		31	39	70	100.5	1075		
	2010.02-			R	F	Platform/Chassis Engine M9T670/M9T672/M9T676	GCI50046	Inner Joint		39	27	30	364	87		
	2010.02-			R	F	Platform/Chassis Engine M9T670/M9T672/M9T676	GC050132	Outer Joint		31	27	70	100.5	63.5	I	
<b>MASTER III (FV)</b>																
2.3 DCi (107 kW)	2010.02-			L	F	Box Engine M9T678/M9T680/M9T694/M9T696/M9T698	GDS18247	Drive Shaft		31	39	70	100.5	743		
	2010.02-			R	F	Box Engine M9T678/M9T680/M9T694/M9T696/M9T698	GDS18248	Drive Shaft		31	39	70	100.5	1075		
	2010.02-			R	F	Box Engine M9T678/M9T680/M9T694/M9T696/M9T698	GCI50046	Inner Joint		39	27	30	364	87		
	2010.02-			R	F	Box Engine M9T678/M9T680/M9T694/M9T696/M9T698	GC050132	Outer Joint		31	27	70	100.5	63.5	I	
2.3 DCi (74 kW)	2010.02-			L	F	Box Engine M9T670/M9T672/M9T676	GDS18247	Drive Shaft		31	39	70	100.5	743		
	2010.02-		MT	L	F	Box Engine M9T690/M9T692	GDS18247	Drive Shaft		31	39	70	100.5	743		
	2010.02-			R	F	Box Engine M9T670/M9T672/M9T676	GDS18248	Drive Shaft		31	39	70	100.5	1075		
	2010.02-			R	F	Box Engine M9T670/M9T672/M9T676	GCI50046	Inner Joint		39	27	30	364	87		
	2010.02-			R	F	Box Engine M9T670/M9T672/M9T676	GC050132	Outer Joint		31	27	70	100.5	63.5	I	
2.3 DCi (92 kW)	2010.02-			L	F	Box Engine M9T670/M9T672/M9T676	GDS18247	Drive Shaft		31	39	70	100.5	743		
	2010.02-			R	F	Box Engine M9T670/M9T672/M9T676	GDS18248	Drive Shaft		31	39	70	100.5	1075		
	2010.02-			R	F	Box Engine M9T670/M9T672/M9T676	GCI50046	Inner Joint		39	27	30	364	87		
	2010.02-			R	F	Box Engine M9T670/M9T672/M9T676	GC050132	Outer Joint		31	27	70	100.5	63.5	I	
<b>MASTER III (JV)</b>																
2.3 DCi (107 kW)	2011.02-		MT	L	F	Bus Engine M9T680	GDS18247	Drive Shaft		31	39	70	100.5	743		
	2011.02-		MT	R	F	Bus Engine M9T680	GDS18248	Drive Shaft		31	39	70	100.5	1075		
	2011.02-		MT	R	F	Bus Engine M9T680	GCI50046	Inner Joint		39	27	30	364	87		
	2011.02-		MT	R	F	Bus Engine M9T680	GC050132	Outer Joint		31	27	70	100.5	63.5	I	
2.3 DCi (74 kW)	2011.02-		MT	L	F	Bus Engine M9T670/M9T672/M9T676	GDS18247	Drive Shaft		31	39	70	100.5	743		
	2011.02-		MT	R	F	Bus Engine M9T670/M9T672/M9T676	GDS18248	Drive Shaft		31	39	70	100.5	1075		
	2011.02-		MT	R	F	Bus Engine M9T670/M9T672/M9T676	GCI50046	Inner Joint		39	27	30	364	87		
	2011.02-		MT	R	F	Bus Engine M9T670/M9T672/M9T676	GC050132	Outer Joint		31	27	70	100.5	63.5	I	
2.3 DCi (92 kW)	2011.02-		MT	L	F	Bus Engine M9T670/M9T672/M9T676	GDS18247	Drive Shaft		31	39	70	100.5	743		



		TRANSM	L/R	F/R		G-AP Ref.	PRODUCT	ABS	Technical Specifications						
									YEAR	A	B	C	H	L	P
<b>RENAULT</b>															
<b>MASTER III (JV)</b>															
2.3 DCi (92 kW)	2011.02-		MT	R	F	Bus Engine M9T670/M9T672/M9T676	GDS18248	Drive Shaft		31	39	70	100.5	1075	
	2011.02-		MT	R	F	Bus Engine M9T670/M9T672/M9T676	GC150046	Inner Joint		39	27	30	364	87	
	2011.02-		MT	R	F	Bus Engine M9T670/M9T672/M9T676	GC050132	Outer Joint		31	27	70	100.5	63.5	I
<b>MEGANE</b>															
-							GC050050	Outer Joint	44T	21	30	51.5	83	56.5	O
1.6/1.9 D/2.0 i							GC050017	Outer Joint		21	22	51.5	83	56.5	I
1.9 DTi	1996-			R			GDS50149	Drive Shaft	44T	23	23	57.5	86.5	742	
2	1996-			R			GDS50149	Drive Shaft	44T	23	23	57.5	86.5	742	
2.0 16V	1996-			R			GDS50149	Drive Shaft	44T	23	23	57.5	86.5	742	
<b>MEGANE CC (EZ0/1_)</b>															
1.4 TCE (96 kW)	2010.06-					Convertible Engine H4J.700	GC050157	Outer Joint		25	33	52.6	89	60	I
1.6 16V (81 kW)	2010.06-		MT	R	F	Convertible Engine K4M858	GDS50510	Drive Shaft		25	26	52.4	88.5	929	
	2010.06-					Convertible Engine K4M858	GC050163	Outer Joint		25	23	52.4	88.5	61	M
1.6 DCi (96 kW)	2011.04-					Convertible Engine R9M402	GC050157	Outer Joint		25	33	52.6	89	60	I
1.9 DCi (96 kW)	2010.06-					Convertible Engine F9Q870	GC050157	Outer Joint		25	33	52.6	89	60	I
<b>MEGANE I (BA0/1)</b>															
1.9 DCi (75 kW)	2001.02-						GC050069	Outer Joint	44T	23	30	57.5	86.5	58.5	I
1.9 DTi (59 kW)	2001-						GC050069	Outer Joint	44T	23	30	57.5	86.5	58.5	I
<b>MEGANE I (BA0/1_)</b>															
1.4 16V (70 kW)	1999.03-2003.08		MT	L	F	Hatchback Engine K4J714/K4J750	GDS50009	Drive Shaft	44T	21	29.95	57	84.5	645.7	
	1999.03-2003.08		MT	L	F	Hatchback Engine K4J714/K4J750	GDS50055	Drive Shaft		21	29.95	50	84	650	
	1999.03-2003.08		MT	R	F	Hatchback Engine K4J714/K4J750	GDS50173	Drive Shaft		21	23	57	84.5	742.9	
	1999.03-2003.08		MT	R	F	Hatchback Engine K4J714/K4J750	GDS50038	Drive Shaft	44T	21	23	52.2	85.5	752	
	1999.03-2003.08		MT	R	F	Hatchback Engine K4J714/K4J750	GDS50316	Drive Shaft		21	23	57	84	741	
	1999.03-2003.08				F	Hatchback Engine K4J714/K4J750	GC050043	Outer Joint	44T	21	22	51.5	83	56.5	I
1.4 e (55 kW)	1996.01-2003.08				F	Hatchback Engine E7J626/E7J764	GC050043	Outer Joint	44T	21	22	51.5	83	56.5	I
	1996.01-2003.08		MT	L	F	Hatchback Engine E7J626/E7J764	GDS50009	Drive Shaft	44T	21	29.95	57	84.5	645.7	
	1996.01-2003.08		MT	L	F	Hatchback Engine E7J626/E7J764	GDS50055	Drive Shaft		21	29.95	50	84	650	
	1996.01-2003.08		MT	R	F	Hatchback Engine E7J626/E7J764	GDS50173	Drive Shaft		21	23	57	84.5	742.9	
	1996.01-2003.08		MT	R	F	Hatchback Engine E7J626/E7J764	GDS50038	Drive Shaft	44T	21	23	52.2	85.5	752	
	1996.01-2003.08		MT	R	F	Hatchback Engine E7J626/E7J764	GDS50316	Drive Shaft		21	23	57	84	741	
1.6 16V (79 kW)	1999.03-2003.08		MT	L	F	Hatchback Engine K4M700/K4M701/K4M704/K4M708	GDS50009	Drive Shaft	44T	21	29.95	57	84.5	645.7	
	1999.03-2003.08		MT	L	F	Hatchback Engine K4M700/K4M701/K4M704/K4M708	GDS50055	Drive Shaft		21	29.95	50	84	650	
	1999.03-2003.08			L	F	Hatchback Engine K4M700/K4M701/K4M704/K4M708	GDS50253	Drive Shaft	44T	23	26	57.5	86.5	634	
	1999.03-2003.08		MT	R	F	Hatchback Engine K4M700/K4M701/K4M704/K4M708	GDS50173	Drive Shaft		21	23	57	84.5	742.9	
	1999.03-2003.08		MT	R	F	Hatchback Engine K4M700/K4M701/K4M704/K4M708	GDS50038	Drive Shaft	44T	21	23	52.2	85.5	752	
	1999.03-2003.08		MT	R	F	Hatchback Engine K4M700/K4M701/K4M704/K4M708	GDS50316	Drive Shaft		21	23	57	84	741	
1.6 LPG (80 kW)	2000.10-2002.08		MT	R	F	Hatchback Engine K4M704	GDS50173	Drive Shaft		21	23	57	84.5	742.9	
1.8 16V (85 kW)	2001.01-2003.08				F	Hatchback Engine F4P720/F4P722	GC050114	Outer Joint	44T	23	35	57.5	87	71	I
	2001.01-2003.08			L	F	Hatchback Engine F4P720/F4P722	GDS50160	Drive Shaft	44T	23	29.95	57	87	656.5	
	2001.01-2003.08			R	F	Hatchback Engine F4P720/F4P722	GDS50313	Drive Shaft	44T	23	23	57.5	86.5	750	
	2001.01-2003.08					Hatchback Engine F4P720/F4P722	GC050052	Outer Joint	44T	23	30	57.5	86.5	58.5	I
1.9 D Eco (47 kW)	1996.01-2003.08				F	Hatchback Engine F8Q620/F8Q624	GC050043	Outer Joint	44T	21	22	51.5	83	56.5	I
	1996.01-2003.08		MT	L	F	Hatchback Engine F8Q620/F8Q624	GDS50009	Drive Shaft	44T	21	29.95	57	84.5	645.7	
	1996.01-2003.08		MT	L	F	Hatchback Engine F8Q620/F8Q624	GDS50055	Drive Shaft		21	29.95	50	84	650	
	1996.01-2003.08		MT	R	F	Hatchback Engine F8Q620/F8Q624	GDS50173	Drive Shaft		21	23	57	84.5	742.9	
	1996.01-2003.08		MT	R	F	Hatchback Engine F8Q620/F8Q624	GDS50038	Drive Shaft	44T	21	23	52.2	85.5	752	
	1996.01-2003.08		MT	R	F	Hatchback Engine F8Q620/F8Q624	GDS50316	Drive Shaft		21	23	57	84	741	
1.9 DCi (75 kW)	2001.02-2003.08				F	Hatchback Engine F9Q732/F9Q733	GC050069	Outer Joint	44T	23	30	57.5	86.5	58.5	I
	2001.02-2003.08		AT	L	F	Hatchback Engine F9Q732/F9Q733	GDS50253	Drive Shaft	44T	23	26	57.5	86.5	634	
	2001.02-2003.08		MT	L	F	Hatchback Engine F9Q732/F9Q733	GDS50314	Drive Shaft	44T	23	29.95	57.5	86.5	654	
	2001.02-2003.08		MT			Hatchback Engine F9Q732/F9Q733	GC050052	Outer Joint	44T	23	30	57.5	86.5	58.5	I
1.9 DCi (77 kW)	1999.03-2003.08		MT			Hatchback Engine F9Q732/F9Q738	GC050052	Outer Joint	44T	23	30	57.5	86.5	58.5	I
1.9 DT (66 kW)	1996.01-2003.08				F	Hatchback Engine F8Q784/F8Q786	GC050043	Outer Joint	44T	21	22	51.5	83	56.5	I
	1996.01-2003.08		MT	L	F	Hatchback Engine F8Q784/F8Q786	GDS50029	Drive Shaft	44T	23	29.95	56.8	84	654	
	1996.01-2003.08		MT	L	F	Hatchback Engine F8Q784/F8Q786	GDS50028	Drive Shaft		23	29.95	56.8	84	654	
	1996.01-2003.08		MT	R	F	Hatchback Engine F8Q784/F8Q786	GDS50173	Drive Shaft		21	23	57	84.5	742.9	
	1996.01-2003.08		MT	R	F	Hatchback Engine F8Q784/F8Q786	GDS50320	Drive Shaft	44T	23	23	56.8	84	755	
	1996.01-2003.08		MT	R	F	Hatchback Engine F8Q784/F8Q786	GDS50247	Drive Shaft		23	23	56.8	84	750.5	
	1996.01-2003.08					Hatchback Engine F8Q784/F8Q786	GC050051	Outer Joint	48T	23	25	56.3	80	58	O
	2001.02-2003.08				F	Hatchback Engine F9Q744	GC050069	Outer Joint	44T	23	30	57.5	86.5	58.5	I





		TRANSM	L/R	F/R		G-AP Ref.	PRODUCT	ABS	Technical Specifications						
									YEAR	A	B	C	H	L	P
<b>RENAULT</b>															
<b>MEGANE I (BA0/1_)</b>															
1.9 DTi (59 kW)	2001.02-	2003.08													
	2001.02-	2003.08	MT			Hatchback Engine F9Q744	GC050052	Outer Joint	44T	23	30	57.5	86.5	58.5	I
1.9 DTi (72 kW)	1997.03-	2001.02	AT	L	F	Hatchback Engine F9Q730/F9Q731/F9Q734/F9Q736	GDS50253	Drive Shaft	44T	23	26	57.5	86.5	634	
	1997.03-	2001.02				Hatchback Engine F9Q730/F9Q731/F9Q734/F9Q736	GC050051	Outer Joint	48T	23	25	56.3	80	58	O
1.9 TDi (69 kW)	1996.09-	2003.08	MT	L	F	Hatchback Engine F8Q784	GDS50029	Drive Shaft	44T	23	29.95	56.8	84	654	
	1996.09-	2003.08	MT	L	F	Hatchback Engine F8Q784	GDS50028	Drive Shaft		23	29.95	56.8	84	654	
	1996.09-	2003.08		R	F	Hatchback Engine F8Q784	GDS99076	Drive Shaft	44T	23	23	56.2	83.5	742.5	
	1996.09-	2003.08	MT	R	F	Hatchback Engine F8Q784	GDS50320	Drive Shaft	44T	23	23	56.8	84	755	
	1996.09-	2003.08	MT	R	F	Hatchback Engine F8Q784	GDS50247	Drive Shaft		23	23	56.8	84	750.5	
	1996.09-	2003.08				Hatchback Engine F8Q784	GC050051	Outer Joint	48T	23	25	56.3	80	58	O
	1996.09-	2003.08				Hatchback Engine F8Q784	GC050052	Outer Joint	44T	23	30	57.5	86.5	58.5	I
2.0 (85 kW)	1998.05-	2001.05	MT	R	F	Hatchback	GDS50173	Drive Shaft		21	23	57	84.5	742.9	
2.0 16V (108 kW)	1996.07-	2003.08			F	Hatchback Engine F7R710/F7R714	GC050043	Outer Joint	44T	21	22	51.5	83	56.5	I
	1996.07-	2003.08	MT	L	F	Hatchback Engine F7R710/F7R714	GDS50029	Drive Shaft	44T	23	29.95	56.8	84	654	
	1996.07-	2003.08	MT	L	F	Hatchback Engine F7R710/F7R714	GDS50028	Drive Shaft		23	29.95	56.8	84	654	
	1996.07-	2003.08	MT	R	F	Hatchback Engine F7R710/F7R714	GDS50320	Drive Shaft	44T	23	23	56.8	84	755	
	1996.07-	2003.08	MT	R	F	Hatchback Engine F7R710/F7R714	GDS50247	Drive Shaft		23	23	56.8	84	750.5	
	1996.07-	2003.08				Hatchback Engine F7R710/F7R714	GC050051	Outer Joint	48T	23	25	56.3	80	58	O
2.0 i (80 kW)	1999.03-	2003.08			F	Hatchback Engine F3R750/F3R751	GC050043	Outer Joint	44T	21	22	51.5	83	56.5	I
	1999.03-	2003.08	MT	L	F	Hatchback Engine F3R750/F3R751	GDS50009	Drive Shaft	44T	21	29.95	57	84.5	645.7	
	1999.03-	2003.08	MT	L	F	Hatchback Engine F3R750/F3R751	GDS50055	Drive Shaft		21	29.95	50	84	650	
	1999.03-	2003.08	MT	R	F	Hatchback Engine F3R750/F3R751	GDS50173	Drive Shaft		21	23	57	84.5	742.9	
	1999.03-	2003.08	MT	R	F	Hatchback Engine F3R750/F3R751	GDS50038	Drive Shaft	44T	21	23	52.2	85.5	752	
	1999.03-	2003.08	MT	R	F	Hatchback Engine F3R750/F3R751	GDS50316	Drive Shaft		21	23	57	84	741	
2.0 i (84 kW)	1996.01-	2003.08			F	Hatchback Engine F3R750/F3R751	GC050043	Outer Joint	44T	21	22	51.5	83	56.5	I
	1996.01-	2003.08	MT	L	F	Hatchback Engine F3R750/F3R751	GDS50009	Drive Shaft	44T	21	29.95	57	84.5	645.7	
	1996.01-	2003.08	MT	L	F	Hatchback Engine F3R750/F3R751	GDS50055	Drive Shaft		21	29.95	50	84	650	
	1996.01-	2003.08	MT	R	F	Hatchback Engine F3R750/F3R751	GDS50173	Drive Shaft		21	23	57	84.5	742.9	
	1996.01-	2003.08	MT	R	F	Hatchback Engine F3R750/F3R751	GDS50038	Drive Shaft	44T	21	23	52.2	85.5	752	
	1996.01-	2003.08	MT	R	F	Hatchback Engine F3R750/F3R751	GDS50316	Drive Shaft		21	23	57	84	741	
<b>MEGANE I (DA0/1), COACH</b>															
1.9 DCi (75 kW)	2001.02-	2003.08					GC050069	Outer Joint	44T	23	30	57.5	86.5	58.5	I
1.9 DCi (77 kW)	2001.02-	2003.08					GC050069	Outer Joint	44T	23	30	57.5	86.5	58.5	I
<b>MEGANE I (KA0/1), SW</b>															
1.9 DCi (75 kW)	2001.02-						GC050069	Outer Joint	44T	23	30	57.5	86.5	58.5	I
1.9 DTi (59 kW)	2001.02-						GC050069	Outer Joint	44T	23	30	57.5	86.5	58.5	I
1.9 DTi (72 kW)	1999.03-	2001.02					GC050005	Outer Joint	44T	23	25	56.3	84	61.5	O
<b>MEGANE I (LA0/1), CLASSIC</b>															
1.6 16V (79 kW)	1999.03-	2006.01	AT				GC050069	Outer Joint	44T	23	30	57.5	86.5	58.5	I
1.9 DCi (75 kW)	2001.02-						GC050069	Outer Joint	44T	23	30	57.5	86.5	58.5	I
1.9 DTi (59 kW)	2001.02-						GC050069	Outer Joint	44T	23	30	57.5	86.5	58.5	I
1.9 DTi (72 kW)	2001.02-						GC050069	Outer Joint	44T	23	30	57.5	86.5	58.5	I
<b>MEGANE I CABRIOLET (EA0/1_)</b>															
1.4 16V (70 kW)	1999.03-	2003.08			F	Convertible Engine K4J714/K4J750	GC050043	Outer Joint	44T	21	22	51.5	83	56.5	I
	1999.03-	2003.08	MT	L	F	Convertible Engine K4J714/K4J750	GDS50009	Drive Shaft	44T	21	29.95	57	84.5	645.7	
	1999.03-	2003.08	MT	L	F	Convertible Engine K4J714/K4J750	GDS50055	Drive Shaft		21	29.95	50	84	650	
	1999.03-	2003.08	MT	R	F	Convertible Engine K4J714/K4J750	GDS50173	Drive Shaft		21	23	57	84.5	742.9	
	1999.03-	2003.08	MT	R	F	Convertible Engine K4J714/K4J750	GDS50038	Drive Shaft	44T	21	23	52.2	85.5	752	
	1999.03-	2003.08	MT	R	F	Convertible Engine K4J714/K4J750	GDS50316	Drive Shaft		21	23	57	84	741	
1.6 16V (79 kW)	1999.03-	2003.08	MT	L	F	Convertible Engine K4M700/K4M701/K4M708	GDS50009	Drive Shaft	44T	21	29.95	57	84.5	645.7	
	1999.03-	2003.08	MT	L	F	Convertible Engine K4M700/K4M701/K4M708	GDS50055	Drive Shaft		21	29.95	50	84	650	
	1999.03-	2003.08		L	F	Convertible Engine K4M700/K4M701/K4M708	GDS50253	Drive Shaft	44T	23	26	57.5	86.5	634	
	1999.03-	2003.08	MT	R	F	Convertible Engine K4M700/K4M701/K4M708	GDS50173	Drive Shaft		21	23	57	84.5	742.9	
	1999.03-	2003.08	MT	R	F	Convertible Engine K4M700/K4M701/K4M708	GDS50038	Drive Shaft	44T	21	23	52.2	85.5	752	
	1999.03-	2003.08	MT	R	F	Convertible Engine K4M700/K4M701/K4M708	GDS50316	Drive Shaft		21	23	57	84	741	
2.0 (84 kW)	1997.04-	2003.08			F	Convertible Engine F3R750	GC050043	Outer Joint	44T	21	22	51.5	83	56.5	I
	1997.04-	2003.08	MT	L	F	Convertible Engine F3R750	GDS50009	Drive Shaft	44T	21	29.95	57	84.5	645.7	
	1997.04-	2003.08	MT	L	F	Convertible Engine F3R750	GDS50055	Drive Shaft		21	29.95	50	84	650	
	1997.04-	2003.08	MT	R	F	Convertible Engine F3R750	GDS50038	Drive Shaft	44T	21	23	52.2	85.5	752	
	1997.04-	2003.08	MT	R	F	Convertible Engine F3R750	GDS50316	Drive Shaft		21	23	57	84	741	





		TRANSM	L/R	F/R		G-AP Ref.	PRODUCT	ABS	Technical Specifications								
									YEAR	A	B	C	H	L	P		
<b>RENAULT</b>																	
<b>MEGANE I CABRIOLET (EA0/1_)</b>																	
2.0 16V (102 kW)	2002.01-	2003.08			F	Convertible Engine F4R746/F4R770	GC050114	Outer Joint	44T	23	35	57.5	87	71	I		
	2002.01-	2003.08	MT			Convertible Engine F4R746/F4R770	GC050052	Outer Joint	44T	23	30	57.5	86.5	58.5	I		
2.0 16V iDE (103 kW)	1999.11-	2003.08			F	Convertible Engine F5R740	GC050114	Outer Joint	44T	23	35	57.5	87	71	I		
	1999.11-	2003.08		L	F	Convertible Engine F5R740	GDS50404	Drive Shaft	44T	23	29.95	57.5	86	655			
	1999.11-	2003.08		R	F	Convertible Engine F5R740	GDS50325	Drive Shaft	44T	23	23	56.3	85	744			
	1999.11-	2003.08	MT			Convertible Engine F5R740	GC050052	Outer Joint	44T	23	30	57.5	86.5	58.5	I		
2.0 i (80 kW)	1999.03-	2003.08			F	Convertible Engine F3R791/F3R796	GC050043	Outer Joint	44T	21	22	51.5	83	56.5	I		
	1999.03-	2003.08	MT	L	F	Convertible Engine F3R791/F3R796	GDS50009	Drive Shaft	44T	21	29.95	57	84.5	645.7			
	1999.03-	2003.08	MT	L	F	Convertible Engine F3R791/F3R796	GDS50055	Drive Shaft		21	29.95	50	84	650			
	1999.03-	2003.08	MT	R	F	Convertible Engine F3R791/F3R796	GDS50173	Drive Shaft		21	23	57	84.5	742.9			
	1999.03-	2003.08	MT	R	F	Convertible Engine F3R791/F3R796	GDS50038	Drive Shaft	44T	21	23	52.2	85.5	752			
	1999.03-	2003.08	MT	R	F	Convertible Engine F3R791/F3R796	GDS50316	Drive Shaft		21	23	57	84	741			
<b>MEGANE I CLASSIC (LA0/1_)</b>																	
1.4 (55 kW)	1996.09-	2003.08			F	Saloon Engine E7J626/E7J764	GC050043	Outer Joint	44T	21	22	51.5	83	56.5	I		
	1996.09-	2003.08	MT	L	F	Saloon Engine E7J626/E7J764	GDS50009	Drive Shaft	44T	21	29.95	57	84.5	645.7			
	1996.09-	2003.08	MT	L	F	Saloon Engine E7J626/E7J764	GDS50055	Drive Shaft		21	29.95	50	84	650			
	1996.09-	2003.08	MT	R	F	Saloon Engine E7J626/E7J764	GDS50173	Drive Shaft		21	23	57	84.5	742.9			
	1996.09-	2003.08	MT	R	F	Saloon Engine E7J626/E7J764	GDS50038	Drive Shaft	44T	21	23	52.2	85.5	752			
	1996.09-	2003.08	MT	R	F	Saloon Engine E7J626/E7J764	GDS50316	Drive Shaft		21	23	57	84	741			
1.4 16V (70 kW)	1999.03-	2003.08			F	Saloon Engine K4J714/K4J750	GC050043	Outer Joint	44T	21	22	51.5	83	56.5	I		
	1999.03-	2003.08	MT	L	F	Saloon Engine K4J714/K4J750	GDS50009	Drive Shaft	44T	21	29.95	57	84.5	645.7			
	1999.03-	2003.08	MT	L	F	Saloon Engine K4J714/K4J750	GDS50055	Drive Shaft		21	29.95	50	84	650			
	1999.03-	2003.08	MT	R	F	Saloon Engine K4J714/K4J750	GDS50173	Drive Shaft		21	23	57	84.5	742.9			
	1999.03-	2003.08	MT	R	F	Saloon Engine K4J714/K4J750	GDS50038	Drive Shaft	44T	21	23	52.2	85.5	752			
	1999.03-	2003.08	MT	R	F	Saloon Engine K4J714/K4J750	GDS50316	Drive Shaft		21	23	57	84	741			
1.6 16V (79 kW)	1999.03-	2003.08	MT	L	F	Saloon Engine K4M700/K4M701/K4M708	GDS50009	Drive Shaft	44T	21	29.95	57	84.5	645.7			
	1999.03-	2003.08	MT	L	F	Saloon Engine K4M700/K4M701/K4M708	GDS50055	Drive Shaft		21	29.95	50	84	650			
	1999.03-	2003.08		L	F	Saloon Engine K4M700/K4M701/K4M708	GDS50253	Drive Shaft	44T	23	26	57.5	86.5	634			
	1999.03-	2003.08	MT	R	F	Saloon Engine K4M700/K4M701/K4M708	GDS50173	Drive Shaft		21	23	57	84.5	742.9			
	1999.03-	2003.08	MT	R	F	Saloon Engine K4M700/K4M701/K4M708	GDS50038	Drive Shaft	44T	21	23	52.2	85.5	752			
	1999.03-	2003.08	MT	R	F	Saloon Engine K4M700/K4M701/K4M708	GDS50316	Drive Shaft		21	23	57	84	741			
1.8 16V (85 kW)	2001.01-	2003.08			F	Saloon Engine F4P720/F4P722	GC050114	Outer Joint	44T	23	35	57.5	87	71	I		
	2001.01-	2003.08		L	F	Saloon Engine F4P720/F4P722	GDS50160	Drive Shaft	44T	23	29.95	57	87	656.5			
	2001.01-	2003.08		R	F	Saloon Engine F4P720/F4P722	GDS50313	Drive Shaft	44T	23	23	57.5	86.5	750			
	2001.01-	2003.08				Saloon Engine F4P720/F4P722	GC050052	Outer Joint	44T	23	30	57.5	86.5	58.5	I		
1.9 D (47 kW)	1996.09-	2003.08			F	Saloon Engine F8Q620/F8Q624	GC050043	Outer Joint	44T	21	22	51.5	83	56.5	I		
	1996.09-	2003.08	MT	L	F	Saloon Engine F8Q620/F8Q624	GDS50009	Drive Shaft	44T	21	29.95	57	84.5	645.7			
	1996.09-	2003.08	MT	L	F	Saloon Engine F8Q620/F8Q624	GDS50055	Drive Shaft		21	29.95	50	84	650			
	1996.09-	2003.08	MT	R	F	Saloon Engine F8Q620/F8Q624	GDS50173	Drive Shaft		21	23	57	84.5	742.9			
	1996.09-	2003.08	MT	R	F	Saloon Engine F8Q620/F8Q624	GDS50038	Drive Shaft	44T	21	23	52.2	85.5	752			
	1996.09-	2003.08	MT	R	F	Saloon Engine F8Q620/F8Q624	GDS50316	Drive Shaft		21	23	57	84	741			
1.9 DCi (75 kW)	2001.02-	2003.08			F	Saloon Engine F9Q732/F9Q733/F9Q738	GC050069	Outer Joint	44T	23	30	57.5	86.5	58.5	I		
	2001.02-	2003.08	AT	L	F	Saloon Engine F9Q732/F9Q733/F9Q738	GDS50253	Drive Shaft	44T	23	26	57.5	86.5	634			
	2001.02-	2003.08	MT	L	F	Saloon Engine F9Q732/F9Q733/F9Q738	GDS50314	Drive Shaft	44T	23	29.95	57.5	86.5	654			
	2001.02-	2003.08	MT	R	F	Saloon Engine F9Q732/F9Q733/F9Q738	GDS50039	Drive Shaft	44T	23	23	57.5	86.5	748			
	2001.02-	2003.08	MT			Saloon Engine F9Q732/F9Q733/F9Q738	GC050052	Outer Joint	44T	23	30	57.5	86.5	58.5	I		
1.9 DT (66 kW)	1996.09-	2003.08			F	Saloon Engine F8Q784/F8Q786	GC050043	Outer Joint	44T	21	22	51.5	83	56.5	I		
	1996.09-	2003.08	MT	L	F	Saloon Engine F8Q784/F8Q786	GDS50029	Drive Shaft	44T	23	29.95	56.8	84	654			
	1996.09-	2003.08	MT	L	F	Saloon Engine F8Q784/F8Q786	GDS50028	Drive Shaft		23	29.95	56.8	84	654			
	1996.09-	2003.08	MT	R	F	Saloon Engine F8Q784/F8Q786	GDS50173	Drive Shaft		21	23	57	84.5	742.9			
	1996.09-	2003.08	MT	R	F	Saloon Engine F8Q784/F8Q786	GDS50320	Drive Shaft	44T	23	23	56.8	84	755			
	1996.09-	2003.08	MT	R	F	Saloon Engine F8Q784/F8Q786	GDS50247	Drive Shaft		23	23	56.8	84	750.5			
	1996.09-	2003.08				Saloon Engine F8Q784/F8Q786	GC050051	Outer Joint	48T	23	25	56.3	80	58	O		
1.9 DTi (59 kW)	2001.02-	2003.08			F	Saloon Engine F9Q744	GC050069	Outer Joint	44T	23	30	57.5	86.5	58.5	I		
	2001.02-	2003.08		L	F	Saloon Engine F9Q744	GDS50311	Drive Shaft	44T	23	29.95	56	82	650			
	2001.02-	2003.08	MT			Saloon Engine F9Q744	GC050052	Outer Joint	44T	23	30	57.5	86.5	58.5	I		
1.9 DTi (72 kW)	1997.03-	2001.02		L	F	Saloon Engine F9Q730/F9Q731/F9Q734/F9Q736	GDS50253	Drive Shaft	44T	23	26	57.5	86.5	634			
	1997.03-	2001.02				Saloon Engine F9Q730/F9Q731/F9Q734/F9Q736	GC050051	Outer Joint	48T	23	25	56.3	80	58	O		
1.9 TDi (69 kW)	1996.09-	2003.08			F	Saloon Engine F8Q784	GC050043	Outer Joint	44T	21	22	51.5	83	56.5	I		
	1996.09-	2003.08	MT	L	F	Saloon Engine F8Q784	GDS50029	Drive Shaft	44T	23	29.95	56.8	84	654			
	1996.09-	2003.08	MT	L	F	Saloon Engine F8Q784	GDS50028	Drive Shaft		23	29.95	56.8	84	654			



		TRANSM	L/R	F/R		G-AP Ref.	PRODUCT	ABS	Technical Specifications							
									YEAR	A	B	C	H	L	P	
<b>RENAULT</b>																
<b>MEGANE I CLASSIC (LA0/1_)</b>																
1.9 TDi (69 kW)	1996.09-	2003.08			R	F	Saloon Engine F8Q784	GDS99076	Drive Shaft	44T	23	23	56.2	83.5	742.5	
	1996.09-	2003.08	MT		R	F	Saloon Engine F8Q784	GDS50320	Drive Shaft	44T	23	23	56.8	84	755	
	1996.09-	2003.08	MT		R	F	Saloon Engine F8Q784	GDS50247	Drive Shaft		23	23	56.8	84	750.5	
	1996.09-	2003.08					Saloon Engine F8Q784	GC050051	Outer Joint	48T	23	25	56.3	80	58	O
	1996.09-	2003.08					Saloon Engine F8Q784	GC050052	Outer Joint	44T	23	30	57.5	86.5	58.5	I
2.0 (85 kW)	1998.05-	2001.05	MT		R	F	Saloon	GDS50173	Drive Shaft		21	23	57	84.5	742.9	
2.0 i (80 kW)	1999.03-	2003.08				F	Saloon Engine F3R750/F3R751/F3R752/F3R791/F3R796/F3R797/F3R798	GC050043	Outer Joint	44T	21	22	51.5	83	56.5	I
	1999.03-	2003.08	MT		L	F	Saloon Engine F3R750/F3R751/F3R752/F3R791/F3R796/F3R797/F3R798	GDS50009	Drive Shaft	44T	21	29.95	57	84.5	645.7	
	1999.03-	2003.08	MT		L	F	Saloon Engine F3R750/F3R751/F3R752/F3R791/F3R796/F3R797/F3R798	GDS50055	Drive Shaft		21	29.95	50	84	650	
	1999.03-	2003.08	MT		R	F	Saloon Engine F3R750/F3R751/F3R752/F3R791/F3R796/F3R797/F3R798	GDS50173	Drive Shaft		21	23	57	84.5	742.9	
	1999.03-	2003.08	MT		R	F	Saloon Engine F3R750/F3R751/F3R752/F3R791/F3R796/F3R797/F3R798	GDS50038	Drive Shaft	44T	21	23	52.2	85.5	752	
2.0 i (84 kW)	1999.03-	2003.08	MT		R	F	Saloon Engine F3R750/F3R751/F3R752/F3R791/F3R796/F3R797/F3R798	GDS50316	Drive Shaft		21	23	57	84	741	
	1996.09-	2003.08				F	Saloon Engine F3R750/F3R751/F3R752/F3R791/F3R796/F3R797/F3R798	GC050043	Outer Joint	44T	21	22	51.5	83	56.5	I
	1996.09-	2003.08	MT		L	F	Saloon Engine F3R750/F3R751/F3R752/F3R791/F3R796/F3R797/F3R798	GDS50009	Drive Shaft	44T	21	29.95	57	84.5	645.7	
	1996.09-	2003.08	MT		L	F	Saloon Engine F3R750/F3R751/F3R752/F3R791/F3R796/F3R797/F3R798	GDS50055	Drive Shaft		21	29.95	50	84	650	
	1996.09-	2003.08	MT		R	F	Saloon Engine F3R750/F3R751/F3R752/F3R791/F3R796/F3R797/F3R798	GDS50173	Drive Shaft		21	23	57	84.5	742.9	
MEGANE I COACH (DA0/1_)	1999.03-	2003.08				F	Coupe Engine K4J714/K4J750	GC050043	Outer Joint	44T	21	22	51.5	83	56.5	I
	1999.03-	2003.08	MT		L	F	Coupe Engine K4J714/K4J750	GDS50009	Drive Shaft	44T	21	29.95	57	84.5	645.7	
	1999.03-	2003.08	MT		L	F	Coupe Engine K4J714/K4J750	GDS50055	Drive Shaft		21	29.95	50	84	650	
	1999.03-	2003.08	MT		R	F	Coupe Engine K4J714/K4J750	GDS50173	Drive Shaft		21	23	57	84.5	742.9	
	1999.03-	2003.08	MT		R	F	Coupe Engine K4J714/K4J750	GDS50038	Drive Shaft	44T	21	23	52.2	85.5	752	
1.6 16V (79 kW)	1999.03-	2003.08	MT		R	F	Coupe Engine K4J714/K4J750	GDS50316	Drive Shaft		21	23	57	84	741	
	1999.03-	2003.08	MT		L	F	Coupe Engine K4M700/K4M701/K4M708	GDS50009	Drive Shaft	44T	21	29.95	57	84.5	645.7	
	1999.03-	2003.08	MT		L	F	Coupe Engine K4M700/K4M701/K4M708	GDS50055	Drive Shaft		21	29.95	50	84	650	
	1999.03-	2003.08	MT		R	F	Coupe Engine K4M700/K4M701/K4M708	GDS50173	Drive Shaft		21	23	57	84.5	742.9	
	1999.03-	2003.08	MT		R	F	Coupe Engine K4M700/K4M701/K4M708	GDS50038	Drive Shaft	44T	21	23	52.2	85.5	752	
1.9 DCi (75 kW)	1999.03-	2003.08	MT		R	F	Coupe Engine K4M700/K4M701/K4M708	GDS50316	Drive Shaft		21	23	57	84	741	
	2001.02-	2003.08				F	Coupe Engine F9Q732/F9Q733	GC050069	Outer Joint	44T	23	30	57.5	86.5	58.5	I
	2001.02-	2003.08	AT		L	F	Coupe Engine F9Q732/F9Q733	GDS50253	Drive Shaft	44T	23	26	57.5	86.5	634	
	2001.02-	2003.08	MT		L	F	Coupe Engine F9Q732/F9Q733	GDS50314	Drive Shaft	44T	23	29.95	57.5	86.5	654	
	2001.02-	2003.08	MT		R	F	Coupe Engine F9Q732/F9Q733	GDS50039	Drive Shaft	44T	23	23	57.5	86.5	748	
1.9 DTi (72 kW)	2001.02-	2003.08	MT				Coupe Engine F9Q732/F9Q733	GC050052	Outer Joint	44T	23	30	57.5	86.5	58.5	I
	1997.03-	2001.02	AT		L	F	Coupe Engine F9Q731/F9Q734/F9Q736	GDS50253	Drive Shaft	44T	23	26	57.5	86.5	634	
2.0 16V (102 kW)	1997.03-	2001.02					Coupe Engine F9Q731/F9Q734/F9Q736	GC050051	Outer Joint	48T	23	25	56.3	80	58	O
	2002.01-	2003.08				F	Coupe Engine F4R746	GC050114	Outer Joint	44T	23	35	57.5	87	71	I
2.0 16V iDE (103 kW)	2002.01-	2003.08	MT				Coupe Engine F4R746	GC050052	Outer Joint	44T	23	30	57.5	86.5	58.5	I
	1999.11-	2003.08				F	Coupe Engine F5R740	GC050114	Outer Joint	44T	23	35	57.5	87	71	I
	1999.11-	2003.08			L	F	Coupe Engine F5R740	GDS50404	Drive Shaft	44T	23	29.95	57.5	86	655	
	1999.11-	2003.08	MT		R	F	Coupe Engine F5R740	GDS50325	Drive Shaft	44T	23	23	56.3	85	744	
2.0 i (80 kW)	1999.11-	2003.08	MT				Coupe Engine F5R740	GC050052	Outer Joint	44T	23	30	57.5	86.5	58.5	I
	1999.03-	2003.08				F	Coupe Engine F3R791/F3R796	GC050043	Outer Joint	44T	21	22	51.5	83	56.5	I
	1999.03-	2003.08			L	F	Coupe Engine F3R791/F3R796	GDS50404	Drive Shaft	44T	23	29.95	57.5	86	655	
	1999.03-	2003.08	MT		L	F	Coupe Engine F3R791/F3R796	GDS50009	Drive Shaft	44T	21	29.95	57	84.5	645.7	
	1999.03-	2003.08	MT		L	F	Coupe Engine F3R791/F3R796	GDS50055	Drive Shaft		21	29.95	50	84	650	
	1999.03-	2003.08	MT		R	F	Coupe Engine F3R791/F3R796	GDS50173	Drive Shaft		21	23	57	84.5	742.9	
	1999.03-	2003.08	MT		R	F	Coupe Engine F3R791/F3R796	GDS50038	Drive Shaft	44T	21	23	52.2	85.5	752	
	1999.03-	2003.08	MT		R	F	Coupe Engine F3R791/F3R796	GDS50316	Drive Shaft		21	23	57	84	741	
2.0 i (84 kW)	1996.03-	2003.08				F	Coupe Engine F3R750/F3R751	GC050043	Outer Joint	44T	21	22	51.5	83	56.5	I
	1996.03-	2003.08	MT		L	F	Coupe Engine F3R750/F3R751	GDS50009	Drive Shaft	44T	21	29.95	57	84.5	645.7	
	1996.03-	2003.08	MT		L	F	Coupe Engine F3R750/F3R751	GDS50055	Drive Shaft		21	29.95	50	84	650	
	1996.03-	2003.08	MT		R	F	Coupe Engine F3R750/F3R751	GDS50173	Drive Shaft		21	23	57	84.5	742.9	
	1996.03-	2003.08	MT		R	F	Coupe Engine F3R750/F3R751	GDS50038	Drive Shaft	44T	21	23	52.2	85.5	752	
	1996.03-	2003.08	MT		R	F	Coupe Engine F3R750/F3R751	GDS50316	Drive Shaft		21	23	57	84	741	
<b>MEGANE I GRANDTOUR (KA0/1_)</b>																
1.4 16V (70 kW)	1999.03-	2003.08				F	Estate Engine K4J714/K4J750	GC050043	Outer Joint	44T	21	22	51.5	83	56.5	I
	1999.03-	2003.08			L	F	Estate Engine K4J714/K4J750	GDS50358	Drive Shaft	44T	21	29.95	57	84	646	
	1999.03-	2003.08			L	F	Estate Engine K4J714/K4J750	GDS50326	Drive Shaft	44T	21	29.95	57	84.5	648	





		TRANSM	L/R	F/R		G-AP Ref.	PRODUCT	ABS	Technical Specifications									
									YEAR	A	B	C	H	L	P			
<b>RENAULT</b>																		
<b>MEGANE I GRANDTOUR (KA0/1_)</b>																		
1.4 16V (70 kW)	1999.03-	2003.08				Estate Engine K4J714/K4J750	GDS50316	Drive Shaft		21	23	57	84	741				
	1999.03-	2003.08				Estate Engine K4J714/K4J750	GDS50327	Drive Shaft	44T	21	23	57	84.5	740				
	1999.03-	2003.08	MT			Estate Engine K4J714/K4J750	GDS50173	Drive Shaft		21	23	57	84.5	742.9				
1.4 e (55 kW)	1999.03-	2003.08				Estate Engine E7J626	GC050043	Outer Joint	44T	21	22	51.5	83	56.5	I			
	1999.03-	2003.08				Estate Engine E7J626	GDS50326	Drive Shaft	44T	21	29.95	57	84.5	648				
	1999.03-	2003.08				Estate Engine E7J626	GDS50327	Drive Shaft	44T	21	23	57	84.5	740				
	1999.03-	2003.08	MT			Estate Engine E7J626	GDS50173	Drive Shaft		21	23	57	84.5	742.9				
1.6 16V (79 kW)	1999.03-	2003.08	AT	L	F	Estate Engine K4M700/K4M701/K4M704/K4M708	GDS50253	Drive Shaft	44T	23	26	57.5	86.5	634				
	1999.03-	2003.08	MT	L	F	Estate Engine K4M700/K4M701/K4M704/K4M708	GDS50358	Drive Shaft	44T	21	29.95	57	84	646				
	1999.03-	2003.08	AT	R	F	Estate Engine K4M700/K4M701/K4M704/K4M708	GDS50323	Drive Shaft	44T	23	23	57.5	86.5	778				
	1999.03-	2003.08	MT	R	F	Estate Engine K4M700/K4M701/K4M704/K4M708	GDS50173	Drive Shaft		21	23	57	84.5	742.9				
	1999.03-	2003.08	MT	R	F	Estate Engine K4M700/K4M701/K4M704/K4M708	GDS50284	Drive Shaft	44T	21	23	56.2	83.5	740.5				
1.6 e (66 kW)	1999.03-	2003.08				Estate Engine K7M702/K7M703	GC050043	Outer Joint	44T	21	22	51.5	83	56.5	I			
	1999.03-	2003.08	AT	R	F	Estate Engine K7M702/K7M703	GDS50284	Drive Shaft	44T	21	23	56.2	83.5	740.5				
	1999.03-	2003.08	MT	R	F	Estate Engine K7M702/K7M703	GDS50173	Drive Shaft		21	23	57	84.5	742.9				
1.8 16V (85 kW)	2001.01-	2003.08				Estate Engine F4P720/F4P722	GC050114	Outer Joint	44T	23	35	57.5	87	71	I			
	2001.01-	2003.08				Estate Engine F4P720/F4P722	GDS50160	Drive Shaft	44T	23	29.95	57	87	656.5				
	2001.01-	2003.08				Estate Engine F4P720/F4P722	GDS50313	Drive Shaft	44T	23	23	57.5	86.5	750				
	2001.01-	2003.08	MT			Estate Engine F4P720/F4P722	GC050052	Outer Joint	44T	23	30	57.5	86.5	58.5	I			
1.9 D (47 kW)	1999.04-	2003.08				Estate Engine F8Q622/F8Q790	GC050043	Outer Joint	44T	21	22	51.5	83	56.5	I			
	1999.04-	2003.08				Estate Engine F8Q622/F8Q790	GDS50326	Drive Shaft	44T	21	29.95	57	84.5	648				
	1999.04-	2003.08				Estate Engine F8Q622/F8Q790	GDS50327	Drive Shaft	44T	21	23	57	84.5	740				
	1999.04-	2003.08	MT	R	F	Estate Engine F8Q622/F8Q790	GDS50173	Drive Shaft		21	23	57	84.5	742.9				
1.9 DCi (75 kW)	2001.02-	2003.08				Estate Engine F9Q732/F9Q733/F9Q738	GC050069	Outer Joint	44T	23	30	57.5	86.5	58.5	I			
	2001.02-	2003.08	AT	L	F	Estate Engine F9Q732/F9Q733/F9Q738	GDS50253	Drive Shaft	44T	23	26	57.5	86.5	634				
	2001.02-	2003.08	MT			Estate Engine F9Q732/F9Q733/F9Q738	GC050052	Outer Joint	44T	23	30	57.5	86.5	58.5	I			
1.9 DTi (59 kW)	2001.02-	2003.08				Estate Engine F9Q744	GC050069	Outer Joint	44T	23	30	57.5	86.5	58.5	I			
	2001.02-	2003.08				Estate Engine F9Q744	GDS50311	Drive Shaft	44T	23	29.95	56	82	650				
	2001.02-	2003.08	MT			Estate Engine F9Q744	GC050052	Outer Joint	44T	23	30	57.5	86.5	58.5	I			
1.9 DTi (72 kW)	1999.03-	2001.02				Estate Engine F9Q731/F9Q736	GDS50253	Drive Shaft	44T	23	26	57.5	86.5	634				
<b>MEGANE II</b>																		
1.8	2001.02-	2003.03	MT	L	F		GDS50089	Drive Shaft	44T	23	29.95	56.2	83.5	653				
2.0 16V	1999.04-	2003.05	MT	L	F		GDS50089	Drive Shaft	44T	23	29.95	56.2	83.5	653				
	1999.04-	2003.05	MT	R	F		GDS50091	Drive Shaft	44T	23	23	56.2	83.5	744				
<b>MEGANE II (BM0/1, CM0/1)</b>																		
1.4 16V (60 kW)	2002.11-		MT				GC099085	Outer Joint		23	30	49	86	59	I			
1.4 16V (70 kW)	2002.11-		MT				GC099085	Outer Joint		23	30	49	86	59	I			
1.4 16V (72 kW)	2002.11-		MT				GC099085	Outer Joint		23	30	49	86	59	I			
1.5 DCi (60 kW)	2002.11-					BM0FCMOF	GC099085	Outer Joint		23	30	49	86	59	I			
1.5 DCi (63 kW)	2003-	2008					GC099085	Outer Joint		23	30	49	86	59	I			
1.5 DCi (74 kW)	2003-	2008					GC099085	Outer Joint		23	30	49	86	59	I			
1.5 DCi (76 kW)	2003-	2008					GC099085	Outer Joint		23	30	49	86	59	I			
1.5 DCi (78 kW)	2003-	2008					GC099085	Outer Joint		23	30	49	86	59	I			
1.6 (77 kW)	2006.09-						GC099085	Outer Joint		23	30	49	86	59	I			
1.6 16V (82 kW)	2002.11-						GC099085	Outer Joint		23	30	49	86	59	I			
1.6 16V (83 kW)	2002.11-						GC099085	Outer Joint		23	30	49	86	59	I			
1.9 DCi (60 kW)	2002.11-					BM0GCMOG	GC099213	Outer Joint		25	33	53	88	61.5	I			
1.9 DCi (66 kW)	2002.11-						GC099213	Outer Joint		25	33	53	88	61.5	I			
1.9 DCi (68 kW)	2002.11-						GC099213	Outer Joint		25	33	53	88	61.5	I			
1.9 DCi (75 kW)	2002.11-					BM0GCMOG	GC099213	Outer Joint		25	33	53	88	61.5	I			
1.9 DCi (77 kW)	2002.11-					BM0GCMOG	GC099213	Outer Joint		25	33	53	88	61.5	I			
1.9 DCi (81 kW)	2002.11-						GC099213	Outer Joint		25	33	53	88	61.5	I			
1.9 DCi (88 kW)	2002.11-					BM0GCMOG	GC099213	Outer Joint		25	33	53	88	61.5	I			
2.0 16V Turbo (120 kW)	2004.05-						GC099213	Outer Joint		25	33	53	88	61.5	I			
<b>MEGANE II (BM0/1_, CM0/1_)</b>																		
1.4 16V (60 kW)	2003.10-					Hatchback Engine K4J732	GC099085	Outer Joint		23	30	49	86	59	I			
	2003.10-					Hatchback Engine K4J732	GDS50405	Drive Shaft		23	26	49	86	674				









		TRANSM	L/R	F/R		G-AP Ref.	PRODUCT	ABS	Technical Specifications						
									YEAR	A	B	C	H	L	P
<b>RENAULT</b>															
<b>MEGANE II (BM0/1_, CM0/1_)</b>															
1.4 16V (60 kW)	2003.10-		L	F	Hatchback Engine K4J732	GDS99070	Drive Shaft		23	26	49	86	675		
	2003.10-	5MT	R	F	Hatchback Engine K4J732	GDS99071	Drive Shaft		23	26	49	86	911		
1.4 16V (72 kW)	2002.11-			F	Hatchback Engine K4J730/K4J740	GC099085	Outer Joint		23	30	49	86	59	I	
	2002.11-		L	F	Hatchback Engine K4J730/K4J740	GDS50405	Drive Shaft		23	26	49	86	674		
	2002.11-		L	F	Hatchback Engine K4J730/K4J740	GDS99070	Drive Shaft		23	26	49	86	675		
	2002.11-	5MT	R	F	Hatchback Engine K4J730/K4J740	GDS99071	Drive Shaft		23	26	49	86	911		
	2002.11-			F	Hatchback Engine K9K722	GC099085	Outer Joint		23	30	49	86	59	I	
1.5 DCi (60 kW)	2002.11-		L	F	Hatchback Engine K9K722	GDS50405	Drive Shaft		23	26	49	86	674		
	2002.11-		L	F	Hatchback Engine K9K722	GDS50402	Drive Shaft		25	26	53	88	660		
	2002.11-		L	F	Hatchback Engine K9K722	GDS99070	Drive Shaft		23	26	49	86	675		
	2002.11-		R	F	Hatchback Engine K9K722	GDS50348	Drive Shaft		25	26	53	88	905		
	2002.11-	5MT	R	F	Hatchback Engine K9K722	GDS99071	Drive Shaft		23	26	49	86	911		
	2002.11-			F	Hatchback Engine K9K724	GC099085	Outer Joint		23	30	49	86	59	I	
1.5 DCi (63 kW)	2005.02-2007.07		L	F	Hatchback Engine K9K724	GDS50405	Drive Shaft		23	26	49	86	674		
	2005.02-2007.07		L	F	Hatchback Engine K9K724	GDS99070	Drive Shaft		23	26	49	86	675		
	2005.02-2007.07	5MT	R	F	Hatchback Engine K9K724	GDS99071	Drive Shaft		23	26	49	86	911		
	2005.02-2007.07			F	Hatchback Engine K9K728/K9K729	GC099085	Outer Joint		23	30	49	86	59	I	
1.5 DCi (74 kW)	2003.10-2005.11		L	F	Hatchback Engine K9K728/K9K729	GDS50516	Drive Shaft		23	26	49	86	674		
	2003.10-2005.11	MT	R	F	Hatchback Engine K9K728/K9K729	GDS50351	Drive Shaft		23	23	49	86	802		
	2007.01-		L	F	Hatchback Engine K9K734	GDS50516	Drive Shaft		23	26	49	86	674		
1.5 DCi (76 kW)	2007.01-		R	F	Hatchback Engine K9K734	GDS99188	Drive Shaft		23	26	49	86	916		
	2005.02-2007.07			F	Hatchback Engine K9K732/K9K734	GC099085	Outer Joint		23	30	49	86	59	I	
1.5 DCi (78 kW)	2005.02-2007.07		L	F	Hatchback Engine K9K732/K9K734	GDS50516	Drive Shaft		23	26	49	86	674		
	2005.02-2007.07		L	F	Hatchback Engine K9K732/K9K734	GDS50402	Drive Shaft		25	26	53	88	660		
	2005.02-2007.07	MT	L	F	Hatchback Engine K9K732/K9K734	GDS50350	Drive Shaft		25	26	52.6	88	668.5		
	2005.02-2007.07		R	F	Hatchback Engine K9K732/K9K734	GDS50348	Drive Shaft		25	26	53	88	905		
	2005.02-2007.07	AT	R	F	Hatchback Engine K9K732/K9K734	GDS50351	Drive Shaft		23	23	49	86	802		
	2005.06-	AT	R	F	Hatchback Engine K4M788	GDS50351	Drive Shaft		23	23	49	86	802		
1.6 16V (82 kW)	2006.01-			F	Hatchback Engine K4M760/K4M812/K4M813	GC099085	Outer Joint		23	30	49	86	59	I	
	2006.01-		L	F	Hatchback Engine K4M760/K4M812/K4M813	GDS99070	Drive Shaft		23	26	49	86	675		
	2006.01-	MT	L	F	Hatchback Engine K4M760/K4M812/K4M813	GDS99070	Drive Shaft		23	26	49	86	675		
	2006.01-	MT	R	F	Hatchback Engine K4M760/K4M812/K4M813	GDS99071	Drive Shaft		23	26	49	86	911		
1.6 16V (83 kW)	2002.11-			F	Hatchback Engine K4M760	GC099085	Outer Joint		23	30	49	86	59	I	
	2002.11-		L	F	Hatchback Engine K4M760	GDS99070	Drive Shaft		23	26	49	86	675		
	2002.11-	MT	L	F	Hatchback Engine K4M760	GDS99070	Drive Shaft		23	26	49	86	675		
	2002.11-	4AT	R	F	Hatchback Engine K4M760	GDS50440	Drive Shaft		23	23	49	86	804		
	2002.11-	MT	R	F	Hatchback Engine K4M760	GDS99071	Drive Shaft		23	26	49	86	911		
	2002.11-	AT	R	F	Hatchback Engine K4M760	GDS50351	Drive Shaft		23	23	49	86	802		
1.6 FlexFuel (77 kW)	2007.01-		L	F	Hatchback Engine K4M788	GDS99070	Drive Shaft		23	26	49	86	675		
	2007.01-	AT	R	F	Hatchback Engine K4M788	GDS50351	Drive Shaft		23	23	49	86	802		
1.9 DCi (68 kW)	2004.03-	MT	L	F	Hatchback Engine F9Q808	GDS99201	Drive Shaft		25	39	53	88	638		
	2004.03-		R	F	Hatchback Engine F9Q808	GDS50400	Drive Shaft		25	39	53	88	932		
1.9 DCi (81 kW)	2005.05-			F	Hatchback Engine F9Q804/F9Q818	GC099213	Outer Joint		25	33	53	88	61.5	I	
	2005.05-	MT	L	F	Hatchback Engine F9Q804/F9Q818	GDS99201	Drive Shaft		25	39	53	88	638		
	2005.05-		R	F	Hatchback Engine F9Q804/F9Q818	GDS50400	Drive Shaft		25	39	53	88	932		
1.9 DCi (88 kW)	2002.11-			F	Hatchback Engine F9Q800	GC099213	Outer Joint		25	33	53	88	61.5	I	
	2002.11-	MT	L	F	Hatchback Engine F9Q800	GDS99201	Drive Shaft		25	39	53	88	638		
	2002.11-	5MT/6MT	R	F	Hatchback Engine F9Q800	GDS50400	Drive Shaft		25	39	53	88	932		
1.9 DCi (96 kW)	2005.05-2007.07	MT	L	F	Hatchback Engine F9Q803/F9Q816	GDS99201	Drive Shaft		25	39	53	88	638		
	2005.05-2007.07		R	F	Hatchback Engine F9Q803/F9Q816	GDS50400	Drive Shaft		25	39	53	88	932		
	2005.05-2007.07	AT			Hatchback Engine F9Q803/F9Q816	GC050137	Outer Joint		25	32	52.6	88	58	I	
	2005.05-2007.07				Hatchback Engine F9Q803/F9Q816	GC050109	Outer Joint		23	33	49	86.5	61	I	
2.0 (102 kW)	1995-06-28 01:26:24	2010.12	AT	L	F	Hatchback	GDS50255	Drive Shaft		23	26	49	86	673	
	1995-06-28 01:26:24	2010.12	AT	R	F	Hatchback	GDS50351	Drive Shaft		23	23	49	86	802	
	1995-06-28 01:26:24	2010.12				Hatchback	GC050117	Outer Joint		23	32	49	86	62	I
2.0 (169 kW)	2006.08-	MT	R	F	Hatchback Engine F4R774	GDS50400	Drive Shaft		25	39	53	88	932		
	2006.08-		L	F	Hatchback Engine F4R774	GDS18197	Drive Shaft		27	39	57	88	663		
	2006.08-		L	F	Hatchback Engine F4R774	GCI99150	Inner Joint		39	32	39	66	104.5		
	2006.08-		L	F	Hatchback Engine F4R774	GC018209	Outer Joint		27	33	57	88	59	I	
	2006.08-	MT	R	F	Hatchback Engine F4R774	GDS50554	Drive Shaft		27	39	56.7	88.5	960		
	2006.08-	MT	R	F	Hatchback Engine F4R774	GCI99160	Inner Joint		39	32	33	352	90		

		TRANSM	L/R	F/R		G-AP Ref.	PRODUCT	ABS	Technical Specifications								
									YEAR	A	B	C	H	L	P		
<b>RENAULT</b>																	
<b>MEGANE II (BM0/1_, CM0/1_)</b>																	
2.0 (169 kW)	2006.08-		MT	R	F	Hatchback Engine F4R774	GC050149	Outer Joint	27	33	56.7	88.5	59.5	I			
	2006.08-			R	F	Hatchback Engine F4R774	GDS18366	Drive Shaft	27	39	57	88	961				
2.0 16V (99 kW)	2002.11-		6MT	L	F	Hatchback Engine F4R770	GDS50441	Drive Shaft	23	39	49	86.5	636				
	2002.11-		6MT	R	F	Hatchback Engine F4R770	GDS50447	Drive Shaft	23	39	49	86.5	930				
	2002.11-		AT	L	F	Hatchback Engine F4R770	GDS50255	Drive Shaft	23	26	49	86	673				
	2002.11-		AT	R	F	Hatchback Engine F4R770	GDS50351	Drive Shaft	23	23	49	86	802				
	2002.11-			R	F	Hatchback Engine F4R770	GDS50520	Drive Shaft	23	23	49	86	803				
	2002.11-					Hatchback Engine F4R770	GC050109	Outer Joint	23	33	49	86.5	61	I			
2.0 16V Turbo (120 kW)	2004.02-2007.07				F	Hatchback Engine F4R776	GC099213	Outer Joint	25	33	53	88	61.5	I			
	2004.02-2007.07		MT	L	F	Hatchback Engine F4R776	GDS99201	Drive Shaft	25	39	53	88	638				
	2004.02-2007.07			R	F	Hatchback Engine F4R776	GDS50400	Drive Shaft	25	39	53	88	932				
2.0 DCi (110 kW)	2006.06-2007.07			L	F	Hatchback Engine M9R700/M9R722	GDS50444	Drive Shaft	27	39	56.5	90.5	626				
	2006.06-2007.07		MT	R	F	Hatchback Engine M9R700/M9R722	GDS50453	Drive Shaft	27	39	56.5	90.5	973.5				
2.0 Renault Sport (165 kW)	2005.04-2007.07			L	F	Hatchback Engine F4R774/F4Rt774	GDS18197	Drive Shaft	27	39	57	88	663				
	2005.04-2007.07			L	F	Hatchback Engine F4R774/F4Rt774	GCI99150	Inner Joint	39	32	39	66	104.5				
	2005.04-2007.07			L	F	Hatchback Engine F4R774/F4Rt774	GC018209	Outer Joint	27	33	57	88	59	I			
	2005.04-2007.07			R	F	Hatchback Engine F4R774/F4Rt774	GDS50554	Drive Shaft	27	39	56.7	88.5	960				
	2005.04-2007.07			R	F	Hatchback Engine F4R774/F4Rt774	GCI99160	Inner Joint	39	32	33	352	90				
	2005.04-2007.07			R	F	Hatchback Engine F4R774/F4Rt774	GC050149	Outer Joint	27	33	56.7	88.5	59.5	I			
<b>MEGANE II (EM0/1)</b>																	
1.5 DCi Coupe-Cabrio (63 kW)	2005.05-						GC099085	Outer Joint	23	30	49	86	59	I			
1.5 DCi Coupe-Cabrio (76 kW)	2005.05-						GC099085	Outer Joint	23	30	49	86	59	I			
1.5 DCi Coupe-Cabrio (78 kW)	2005.05-						GC099085	Outer Joint	23	30	49	86	59	I			
1.6 16V Coupe-Cabrio (82 kW)	2007.01-						GC099085	Outer Joint	23	30	49	86	59	I			
1.6 Coupe-Cabrio (83 kW)	2003.09-						GC099085	Outer Joint	23	30	49	86	59	I			
1.9 DCi Coupe-Cabrio (81 kW)	2003.09-						GC099213	Outer Joint	25	33	53	88	61.5	I			
1.9 DCi Coupe-Cabrio (88 kW)	2003.09-						GC099213	Outer Joint	25	33	53	88	61.5	I			
2.0 16V Coupe-Cabrio (120 kW)	2004.05-						GC099213	Outer Joint	25	33	53	88	61.5	I			
<b>MEGANE II (EM0/1_)</b>																	
2.0 (102 kW)	2003.09-2007.02		AT	L	F	Convertible Engine F4R770	GDS50255	Drive Shaft	23	26	49	86	673				
	2003.09-2007.02		AT	R	F	Convertible Engine F4R770	GDS50351	Drive Shaft	23	23	49	86	802				
	2003.09-2007.02					Convertible Engine F4R770	GC050117	Outer Joint	23	32	49	86	62	I			
<b>MEGANE II (KM0/1), SW</b>																	
1.4 (72 kW)	2003.08-						GC099085	Outer Joint	23	30	49	86	59	I			
1.5 DCi (60 kW)	2003.08-						GC099085	Outer Joint	23	30	49	86	59	I			
1.5 DCi (63 kW)	2003.08-						GC099085	Outer Joint	23	30	49	86	59	I			
1.5 DCi (74 kW)	2003.08-						GC099085	Outer Joint	23	30	49	86	59	I			
1.5 DCi (76 kW)	2003.08-						GC099085	Outer Joint	23	30	49	86	59	I			
1.5 DCi (78 kW)	2003.08-						GC099085	Outer Joint	23	30	49	86	59	I			
1.6 (83 kW)	2003.08-						GC099085	Outer Joint	23	30	49	86	59	I			
1.6 16V (82 kW)	2007.01-						GC099085	Outer Joint	23	30	49	86	59	I			
1.9 DCi (68 kW)	2003.08-						GC099213	Outer Joint	25	33	53	88	61.5	I			
1.9 DCi (81 kW)	2003.08-						GC099213	Outer Joint	25	33	53	88	61.5	I			
1.9 DCi (88 kW)	2003.08-						GC099213	Outer Joint	25	33	53	88	61.5	I			
<b>MEGANE II (KM0/1_)</b>																	
1.9 DCi (81 kW)	2005.05-				F	Estate Engine F9Q804/F9Q818	GC099213	Outer Joint	25	33	53	88	61.5	I			
	2005.05-		MT	L	F	Estate Engine F9Q804/F9Q818	GDS99201	Drive Shaft	25	39	53	88	638				
	2005.05-			R	F	Estate Engine F9Q804/F9Q818	GDS50400	Drive Shaft	25	39	53	88	932				
1.9 DCi (88 kW)	2003.08-		MT	L	F	Estate Engine F9Q800	GDS99201	Drive Shaft	25	39	53	88	638				
	2003.08-			R	F	Estate Engine F9Q800	GDS50400	Drive Shaft	25	39	53	88	932				
1.9 DCi (96 kW)	2005.05-2007.07		MT	L	F	Estate Engine F9Q803/F9Q804	GDS99201	Drive Shaft	25	39	53	88	638				
	2005.05-2007.07			R	F	Estate Engine F9Q803/F9Q804	GDS50400	Drive Shaft	25	39	53	88	932				
	2005.05-2007.07		AT			Estate Engine F9Q803/F9Q804	GC050137	Outer Joint	25	32	52.6	88	58	I			
	2005.05-2007.07					Estate Engine F9Q803/F9Q804	GC050109	Outer Joint	23	33	49	86.5	61	I			
2.0 (99 kW)	2003.08-		6MT	R	F	Estate Engine F4R770/F4R771	GDS50447	Drive Shaft	23	39	49	86.5	930				
	2003.08-		AT	L	F	Estate Engine F4R770/F4R771	GDS50255	Drive Shaft	23	26	49	86	673				
	2003.08-		AT	R	F	Estate Engine F4R770/F4R771	GDS50351	Drive Shaft	23	23	49	86	802				
	2003.08-			R	F	Estate Engine F4R770/F4R771	GDS50520	Drive Shaft	23	23	49	86	803				
	2003.08-					Estate Engine F4R770/F4R771	GC050109	Outer Joint	23	33	49	86.5	61	I			
2.0 DCi (110 kW)	2006.06-2007.07			L	F	Estate Engine M9R700/M9R722	GDS50444	Drive Shaft	27	39	56.5	90.5	626				
	2006.06-2007.07		MT	R	F	Estate Engine M9R700/M9R722	GDS50453	Drive Shaft	27	39	56.5	90.5	973.5				



		TRANSM	L/R	F/R		G-AP Ref.	PRODUCT	ABS	Technical Specifications									
									YEAR	A	B	C	H	L	P			
<b>RENAULT</b>																		
<b>MEGANE II (LM0/1)</b>																		
1.4 (60 kW)	2003.09-					GC099085	Outer Joint		23	30	49	86	59	I				
1.4 (72 kW)	2003.09-					GC099085	Outer Joint		23	30	49	86	59	I				
1.5 DCi (60 kW)	2003.09-					GC099085	Outer Joint		23	30	49	86	59	I				
1.5 DCi (63 kW)	2003.09-					GC099085	Outer Joint		23	30	49	86	59	I				
1.5 DCi (74 kW)	2003.09-					GC099085	Outer Joint		23	30	49	86	59	I				
1.5 DCi (76 kW)	2005.05-					GC099213	Outer Joint		25	33	53	88	61.5	I				
1.5 DCi (78 kW)	2005.05-					GC099213	Outer Joint		25	33	53	88	61.5	I				
1.6 (77 kW)	2003.09-					GC099085	Outer Joint		23	30	49	86	59	I				
1.6 (83 kW)	2003.09-					GC099085	Outer Joint		23	30	49	86	59	I				
1.6 16V (82 kW)	2007.01-					GC099085	Outer Joint		23	30	49	86	59	I				
1.9 DCi (66 kW)	2002.11-					GC099213	Outer Joint		25	33	53	88	61.5	I				
1.9 DCi (68 kW)	2002.11-					GC099213	Outer Joint		25	33	53	88	61.5	I				
1.9 DCi (81 kW)	2002.11-					GC099213	Outer Joint		25	33	53	88	61.5	I				
1.9 DCi (88 kW)	2002.11-					GC099213	Outer Joint		25	33	53	88	61.5	I				
1.9 DCi (96 kW)	2002.11-					GC099213	Outer Joint		25	33	53	88	61.5	I				
2.0 (99 kW)	2003.09-					GC099213	Outer Joint		25	33	53	88	61.5	I				
<b>MEGANE II (LM0/1_)</b>																		
1.4 (60 kW)	2003.09-			F	Saloon Engine K4J732	GC099085	Outer Joint		23	30	49	86	59	I				
	2003.09-		L	F	Saloon Engine K4J732	GDS50405	Drive Shaft		23	26	49	86	674					
	2003.09-	5MT	R	F	Saloon Engine K4J732	GDS99071	Drive Shaft		23	26	49	86	911					
1.4 (72 kW)	2003.09-			F	Saloon Engine K4J730/K4J740	GC099085	Outer Joint		23	30	49	86	59	I				
	2003.09-		L	F	Saloon Engine K4J730/K4J740	GDS50494	Drive Shaft		25	26	52.6	88	664					
	2003.09-		L	F	Saloon Engine K4J730/K4J740	GDS50405	Drive Shaft		23	26	49	86	674					
	2003.09-		L	F	Saloon Engine K4J730/K4J740	GDS99070	Drive Shaft		23	26	49	86	675					
	2003.09-		R	F	Saloon Engine K4J730/K4J740	GDS50442	Drive Shaft		25	26	52.6	88	911					
	2003.09-	5MT	R	F	Saloon Engine K4J730/K4J740	GDS99071	Drive Shaft		23	26	49	86	911					
1.5 DCi (60 kW)	2003.09-			F	Saloon Engine K9K722	GC099085	Outer Joint		23	30	49	86	59	I				
	2003.09-		L	F	Saloon Engine K9K722	GDS50405	Drive Shaft		23	26	49	86	674					
	2003.09-		L	F	Saloon Engine K9K722	GDS50402	Drive Shaft		25	26	53	88	660					
	2003.09-		L	F	Saloon Engine K9K722	GDS99070	Drive Shaft		23	26	49	86	675					
	2003.09-		R	F	Saloon Engine K9K722	GDS50348	Drive Shaft		25	26	53	88	905					
	2003.09-	5MT	R	F	Saloon Engine K9K722	GDS99071	Drive Shaft		23	26	49	86	911					
1.5 DCi (63 kW)	2005.02-2006.04			F	Saloon Engine K9K724	GC099085	Outer Joint		23	30	49	86	59	I				
	2005.02-2006.04		L	F	Saloon Engine K9K724	GDS50405	Drive Shaft		23	26	49	86	674					
	2005.02-2006.04		L	F	Saloon Engine K9K724	GDS99070	Drive Shaft		23	26	49	86	675					
	2005.02-2006.04	5MT	R	F	Saloon Engine K9K724	GDS99071	Drive Shaft		23	26	49	86	911					
1.5 DCi (74 kW)	2003.11-2005.11			F	Saloon Engine K9K728/K9K729	GC099085	Outer Joint		23	30	49	86	59	I				
	2003.11-2005.11	MT	L	F	Saloon Engine K9K728/K9K729	GDS50405	Drive Shaft		23	26	49	86	674					
	2003.11-2005.11	MT	R	F	Saloon Engine K9K728/K9K729	GDS99188	Drive Shaft		23	26	49	86	916					
	2003.11-2005.11	MT	R	F	Saloon Engine K9K728/K9K729	GDS99071	Drive Shaft		23	26	49	86	911					
1.5 DCi (76 kW)	2007.01-		L	F	Saloon Engine K9K734	GDS50516	Drive Shaft		23	26	49	86	674					
	2007.01-		R	F	Saloon Engine K9K734	GDS99188	Drive Shaft		23	26	49	86	916					
1.5 DCi (78 kW)	2005.02-2006.02			F	Saloon Engine K9K732	GC099085	Outer Joint		23	30	49	86	59	I				
	2005.02-2006.02		L	F	Saloon Engine K9K732	GDS50516	Drive Shaft		23	26	49	86	674					
	2005.02-2006.02		L	F	Saloon Engine K9K732	GDS50402	Drive Shaft		25	26	53	88	660					
	2005.02-2006.02	MT	L	F	Saloon Engine K9K732	GDS50350	Drive Shaft		25	26	52.6	88	668.5					
	2005.02-2006.02		R	F	Saloon Engine K9K732	GDS50348	Drive Shaft		25	26	53	88	905					
1.6 (83 kW)	2003.09-			F	Saloon Engine K4M760/K4M761	GC099085	Outer Joint		23	30	49	86	59	I				
	2003.09-		L	F	Saloon Engine K4M760/K4M761	GDS50494	Drive Shaft		25	26	52.6	88	664					
	2003.09-		L	F	Saloon Engine K4M760/K4M761	GDS99070	Drive Shaft		23	26	49	86	675					
	2003.09-	MT	L	F	Saloon Engine K4M760/K4M761	GDS99070	Drive Shaft		23	26	49	86	675					
	2003.09-		R	F	Saloon Engine K4M760/K4M761	GDS50442	Drive Shaft		25	26	52.6	88	911					
	2003.09-	MT	R	F	Saloon Engine K4M760/K4M761	GDS99071	Drive Shaft		23	26	49	86	911					
	2003.09-	AT	R	F	Saloon Engine K4M760/K4M761	GDS50351	Drive Shaft		23	23	49	86	802					
	2003.09-																	
1.6 16V (82 kW)	2006.01-			F	Saloon Engine K4M812/K4M813/K4MD812	GC099085	Outer Joint		23	30	49	86	59	I				
	2006.01-	MT	L	F	Saloon Engine K4M812/K4M813/K4MD812	GDS99070	Drive Shaft		23	26	49	86	675					
	2006.01-	AT	R	F	Saloon Engine K4M812/K4M813/K4MD812	GDS50440	Drive Shaft		23	23	49	86	804					
	2006.01-	MT	R	F	Saloon Engine K4M812/K4M813/K4MD812	GDS99071	Drive Shaft		23	26	49	86	911					
1.9 DCi (68 kW)	2004.03-	MT	L	F	Saloon Engine F9Q808	GDS99201	Drive Shaft		25	39	53	88	638					
	2004.03-		R	F	Saloon Engine F9Q808	GDS50400	Drive Shaft		25	39	53	88	932					
1.9 DCi (81 kW)	2005.05-			F	Saloon Engine F9Q803/F9Q804/F9Q816/F9Q818	GC099213	Outer Joint		25	33	53	88	61.5	I				





		TRANSM	L/R	F/R		G-AP Ref.	PRODUCT	ABS	Technical Specifications											
									YEAR	A	B	C	H	L	P					
<b>RENAULT MEGANE II (LM0/1_)</b>																				
1.9 DCi (81 kW)	2005.05-		MT	L	F	Saloon Engine F9Q803/F9Q804/F9Q816/F9Q818	GDS99201	Drive Shaft		25	39	53	88	638						
	2005.05-			R	F	Saloon Engine F9Q803/F9Q804/F9Q816/F9Q818	GDS50400	Drive Shaft		25	39	53	88	932						
1.9 DCi (88 kW)	2003.09-		MT	L	F	Saloon Engine F9Q800	GDS99201	Drive Shaft		25	39	53	88	638						
	2003.09-			R	F	Saloon Engine F9Q800	GDS50400	Drive Shaft		25	39	53	88	932						
1.9 DCi (96 kW)	2005.05-2007.04		MT	L	F	Saloon Engine F9Q803	GDS99201	Drive Shaft		25	39	53	88	638						
	2005.05-2007.04			R	F	Saloon Engine F9Q803	GDS50400	Drive Shaft		25	39	53	88	932						
	2005.05-2007.04		AT			Saloon Engine F9Q803	GC050137	Outer Joint		25	32	52.6	88	58	I					
	2005.05-2007.04					Saloon Engine F9Q803	GC050109	Outer Joint		23	33	49	86.5	61	I					
2.0 (99 kW)	2003.09-		6MT	L	F	Saloon Engine F4R770/F4R771	GDS50441	Drive Shaft		23	39	49	86.5	636						
	2003.09-		6MT	R	F	Saloon Engine F4R770/F4R771	GDS50447	Drive Shaft		23	39	49	86.5	930						
	2003.09-		AT	L	F	Saloon Engine F4R770/F4R771	GDS50255	Drive Shaft		23	26	49	86	673						
	2003.09-		AT	R	F	Saloon Engine F4R770/F4R771	GDS50351	Drive Shaft		23	23	49	86	802						
	2003.09-			R	F	Saloon Engine F4R770/F4R771	GDS50520	Drive Shaft		23	23	49	86	803						
	2003.09-					Saloon Engine F4R770/F4R771	GC050109	Outer Joint		23	33	49	86.5	61	I					
2.0 DCi (110 kW)	2006.06-2007.04			L	F	Saloon Engine M9R700/M9R722	GDS50444	Drive Shaft		27	39	56.5	90.5	626						
	2006.06-2007.04		MT	R	F	Saloon Engine M9R700/M9R722	GDS50453	Drive Shaft		27	39	56.5	90.5	973.5						
<b>MEGANE II COUPE-CABRIOLET II (EM0/1_)</b>																				
1.5 DCi (76 kW)	2007.01-			L	F	Convertible Engine K9K734	GDS50402	Drive Shaft		25	26	53	88	660						
	2007.01-			R	F	Convertible Engine K9K734	GDS50348	Drive Shaft		25	26	53	88	905						
1.5 DCi (78 kW)	2006.01-2007.08				F	Convertible Engine K9K732	GC099085	Outer Joint		23	30	49	86	59	I					
	2006.01-2007.08			L	F	Convertible Engine K9K732	GDS50402	Drive Shaft		25	26	53	88	660						
	2006.01-2007.08		MT	L	F	Convertible Engine K9K732	GDS50350	Drive Shaft		25	26	52.6	88	668.5						
	2006.01-2007.08			R	F	Convertible Engine K9K732	GDS50348	Drive Shaft		25	26	53	88	905						
1.6 (83 kW)	2003.09-				F	Convertible Engine K4M760/K4M761	GC099085	Outer Joint		23	30	49	86	59	I					
	2003.09-			L	F	Convertible Engine K4M760/K4M761	GDS99070	Drive Shaft		23	26	49	86	675						
	2003.09-		MT	L	F	Convertible Engine K4M760/K4M761	GDS99070	Drive Shaft		23	26	49	86	675						
	2003.09-			R	F	Convertible Engine K4M760/K4M761	GDS50440	Drive Shaft		23	23	49	86	804						
	2003.09-		MT	R	F	Convertible Engine K4M760/K4M761	GDS99071	Drive Shaft		23	26	49	86	911						
	2003.09-		AT	R	F	Convertible Engine K4M760/K4M761	GDS50351	Drive Shaft		23	23	49	86	802						
1.6 16V (82 kW)	2006.01-				F	Convertible Engine K4M760/K4M761/K4M812/K4M813/K4M813/K4M813/K4M813/K4M813	GC099085	Outer Joint		23	30	49	86	59	I					
	2006.01-			L	F	Convertible Engine K4M760/K4M761/K4M812/K4M813/K4M813/K4M813/K4M813/K4M813	GDS99070	Drive Shaft		23	26	49	86	675						
	2006.01-		MT	L	F	Convertible Engine K4M760/K4M761/K4M812/K4M813/K4M813/K4M813/K4M813/K4M813	GDS99070	Drive Shaft		23	26	49	86	675						
	2006.01-			R	F	Convertible Engine K4M760/K4M761/K4M812/K4M813/K4M813/K4M813/K4M813/K4M813	GDS50440	Drive Shaft		23	23	49	86	804						
	2006.01-		MT	R	F	Convertible Engine K4M760/K4M761/K4M812/K4M813/K4M813/K4M813/K4M813/K4M813	GDS99071	Drive Shaft		23	26	49	86	911						
1.9 DCi (81 kW)	2005.05-				F	Convertible Engine F9Q804/F9Q816/F9Q818	GC099213	Outer Joint		25	33	53	88	61.5	I					
	2005.05-		MT	L	F	Convertible Engine F9Q804/F9Q816/F9Q818	GDS99201	Drive Shaft		25	39	53	88	638						
	2005.05-			R	F	Convertible Engine F9Q804/F9Q816/F9Q818	GDS50400	Drive Shaft		25	39	53	88	932						
1.9 DCi (88 kW)	2003.09-		MT	L	F	Convertible Engine F9Q800	GDS99201	Drive Shaft		25	39	53	88	638						
	2003.09-			R	F	Convertible Engine F9Q800	GDS50400	Drive Shaft		25	39	53	88	932						
1.9 DCi (96 kW)	2005.05-2007.08			R	F	Convertible Engine F9Q803	GDS50400	Drive Shaft		25	39	53	88	932						
	2005.05-2007.08		AT			Convertible Engine F9Q803	GC050137	Outer Joint		25	32	52.6	88	58	I					
	2005.05-2007.08					Convertible Engine F9Q803	GC050109	Outer Joint		23	33	49	86.5	61	I					
2.0 (99 kW)	2003.09-		6MT	R	F	Convertible Engine F4R770/F4R771	GDS50447	Drive Shaft		23	39	49	86.5	930						
	2003.09-		AT	L	F	Convertible Engine F4R770/F4R771	GDS50255	Drive Shaft		23	26	49	86	673						
	2003.09-		AT	R	F	Convertible Engine F4R770/F4R771	GDS50351	Drive Shaft		23	23	49	86	802						
	2003.09-			R	F	Convertible Engine F4R770/F4R771	GDS50520	Drive Shaft		23	23	49	86	803						
	2003.09-					Convertible Engine F4R770/F4R771	GC050109	Outer Joint		23	33	49	86.5	61	I					
2.0 16V Turbo (120 kW)	2004.08-2007.08				F	Convertible Engine F4R776	GC099213	Outer Joint		25	33	53	88	61.5	I					
	2004.08-2007.08		MT	L	F	Convertible Engine F4R776	GDS99201	Drive Shaft		25	39	53	88	638						
	2004.08-2007.08			R	F	Convertible Engine F4R776	GDS50400	Drive Shaft		25	39	53	88	932						
2.0 DCi (110 kW)	2006.06-2007.08			L	F	Convertible Engine M9R700/M9R722	GDS50444	Drive Shaft		27	39	56.5	90.5	626						
	2006.06-2007.08		MT	R	F	Convertible Engine M9R700/M9R722	GDS50453	Drive Shaft		27	39	56.5	90.5	973.5						
<b>MEGANE II SPORT TOURER (KM0/1_)</b>																				
1.4 (72 kW)	2003.08-				F	Estate Engine K4J730/K4J740	GC099085	Outer Joint		23	30	49	86	59	I					
	2003.08-			L	F	Estate Engine K4J730/K4J740	GDS50494	Drive Shaft		25	26	52.6	88	664						
	2003.08-			L	F	Estate Engine K4J730/K4J740	GDS50405	Drive Shaft		23	26	49	86	674						
	2003.08-			L	F	Estate Engine K4J730/K4J740	GDS99070	Drive Shaft		23	26	49	86	675						
	2003.08-			R	F	Estate Engine K4J730/K4J740	GDS50442	Drive Shaft		25	26	52.6	88	911						
	2003.08-		5MT	R	F	Estate Engine K4J730/K4J740	GDS99071	Drive Shaft		23	26	49	86	911						
1.5 DCi (60 kW)	2003.08-				F	Estate Engine K9K722	GC099085	Outer Joint		23	30	49	86	59	I					
	2003.08-			L	F	Estate Engine K9K722	GDS50405	Drive Shaft		23	26	49	86	674						



		TRANSM	L/R	F/R		G-AP Ref.	PRODUCT	ABS	Technical Specifications								
									YEAR	A	B	C	H	L	P		
<b>RENAULT</b>																	
<b>MEGANE II SPORT TOURER (KM0/1_)</b>																	
1.5 DCi (60 kW)	2003.08-					Estate Engine K9K722	GDS50402	Drive Shaft	25	26	53	88	660				
	2003.08-					Estate Engine K9K722	GDS99070	Drive Shaft	23	26	49	86	675				
	2003.08-					Estate Engine K9K722	GDS50348	Drive Shaft	25	26	53	88	905				
	2003.08-		5MT			Estate Engine K9K722	GDS99071	Drive Shaft	23	26	49	86	911				
1.5 DCi (63 kW)	2005.02-2006.02					Estate Engine K9K724	GC099085	Outer Joint	23	30	49	86	59	I			
	2005.02-2006.02					Estate Engine K9K724	GDS50405	Drive Shaft	23	26	49	86	674				
	2005.02-2006.02					Estate Engine K9K724	GDS99070	Drive Shaft	23	26	49	86	675				
	2005.02-2006.02		5MT			Estate Engine K9K724	GDS99071	Drive Shaft	23	26	49	86	911				
1.5 DCi (74 kW)	2003.11-2005.11					Estate Engine K9K728/K9K729	GC099085	Outer Joint	23	30	49	86	59	I			
	2003.11-2005.11					Estate Engine K9K728/K9K729	GDS50516	Drive Shaft	23	26	49	86	674				
	2003.11-2005.11					Estate Engine K9K728/K9K729	GDS99188	Drive Shaft	23	26	49	86	916				
1.5 DCi (76 kW)	2007.01-					Estate Engine K9K728	GDS50516	Drive Shaft	23	26	49	86	674				
	2007.01-					Estate Engine K9K728	GDS99188	Drive Shaft	23	26	49	86	916				
1.5 DCi (78 kW)	2005.02-2007.07					Estate Engine K9K732/K9K734	GC099085	Outer Joint	23	30	49	86	59	I			
	2005.02-2007.07					Estate Engine K9K732/K9K734	GDS50516	Drive Shaft	23	26	49	86	674				
	2005.02-2007.07					Estate Engine K9K732/K9K734	GDS50402	Drive Shaft	25	26	53	88	660				
	2005.02-2007.07		MT			Estate Engine K9K732/K9K734	GDS50350	Drive Shaft	25	26	52.6	88	668.5				
	2005.02-2007.07					Estate Engine K9K732/K9K734	GDS50348	Drive Shaft	25	26	53	88	905				
1.6 (83 kW)	2003.08-					Estate Engine K4M760/K4M761	GC099085	Outer Joint	23	30	49	86	59	I			
	2003.08-					Estate Engine K4M760/K4M761	GDS50494	Drive Shaft	25	26	52.6	88	664				
	2003.08-					Estate Engine K4M760/K4M761	GDS99070	Drive Shaft	23	26	49	86	675				
	2003.08-		MT			Estate Engine K4M760/K4M761	GDS99070	Drive Shaft	23	26	49	86	675				
	2003.08-					Estate Engine K4M760/K4M761	GDS50442	Drive Shaft	25	26	52.6	88	911				
	2003.08-		AT			Estate Engine K4M760/K4M761	GDS50440	Drive Shaft	23	23	49	86	804				
	2003.08-		MT			Estate Engine K4M760/K4M761	GDS99071	Drive Shaft	23	26	49	86	911				
	2003.08-		AT			Estate Engine K4M760/K4M761	GDS50351	Drive Shaft	23	23	49	86	802				
1.6 16V (82 kW)	2006.01-					Estate Engine K4M760/K4M761/K4M812/K4M813/K4MD812	GC099085	Outer Joint	23	30	49	86	59	I			
	2006.01-					Estate Engine K4M760/K4M761/K4M812/K4M813/K4MD812	GDS99070	Drive Shaft	23	26	49	86	675				
	2006.01-		MT			Estate Engine K4M760/K4M761/K4M812/K4M813/K4MD812	GDS99070	Drive Shaft	23	26	49	86	675				
	2006.01-		MT			Estate Engine K4M760/K4M761/K4M812/K4M813/K4MD812	GDS99071	Drive Shaft	23	26	49	86	911				
1.6 16V Hi-Flex (77 kW)	2008.02-					Estate Engine K4M762	GDS99070	Drive Shaft	23	26	49	86	675				
1.9 DCi (68 kW)	2004.03-		MT			Estate Engine F9Q808	GDS99201	Drive Shaft	25	39	53	88	638				
	2004.03-					Estate Engine F9Q808	GDS50400	Drive Shaft	25	39	53	88	932				
2.0 (102 kW)	2006.12-2011.01		AT			Estate	GDS50255	Drive Shaft	23	26	49	86	673				
	2006.12-2011.01		AT			Estate	GDS50351	Drive Shaft	23	23	49	86	802				
	2006.12-2011.01					Estate	GC050117	Outer Joint	23	32	49	86	62	I			
<b>MEGANE III (BZ0_)</b>																	
1.4 TCE (96 kW)	2009.04-					Hatchback Engine H4J700	GC050157	Outer Joint	25	33	52.6	89	60	I			
1.5 DCi (63 kW)	2009.12-		5MT			Hatchback Engine K9K830	GDS50426	Drive Shaft	25	26	52.7	88.5	680				
	2009.12-					Hatchback Engine K9K830	GDS50383	Drive Shaft	25	26	52.7	88.5	688				
	2009.12-					Hatchback Engine K9K830	GCI50096	Inner Joint	26	30	40	64	96				
	2009.12-					Hatchback Engine K9K830	GC050145	Outer Joint	25	33	52.7	88.5	59.5	I			
	2009.12-		MT			Hatchback Engine K9K830	GDS50425	Drive Shaft	25	26	52.7	88.5	931				
1.5 DCi (66 kW)	2008.11-		5MT			Hatchback Engine K9KH834	GDS50426	Drive Shaft	25	26	52.7	88.5	680				
	2008.11-					Hatchback Engine K9KH834	GDS50383	Drive Shaft	25	26	52.7	88.5	688				
	2008.11-					Hatchback Engine K9KH834	GCI50096	Inner Joint	26	30	40	64	96				
	2008.11-					Hatchback Engine K9KH834	GC050145	Outer Joint	25	33	52.7	88.5	59.5	I			
	2008.11-					Hatchback Engine K9KH834	GDS50425	Drive Shaft	25	26	52.7	88.5	931				
1.6 16V (74 kW)	2008.11-		5MT			Hatchback Engine K4M848	GDS50426	Drive Shaft	25	26	52.7	88.5	680				
	2008.11-					Hatchback Engine K4M848	GDS50383	Drive Shaft	25	26	52.7	88.5	688				
	2008.11-					Hatchback Engine K4M848	GCI50096	Inner Joint	26	30	40	64	96				
	2008.11-					Hatchback Engine K4M848	GC050145	Outer Joint	25	33	52.7	88.5	59.5	I			
	2008.11-		MT			Hatchback Engine K4M848	GDS50425	Drive Shaft	25	26	52.7	88.5	931				
	2008.11-					Hatchback Engine K4M848	GC050163	Outer Joint	25	23	52.4	88.5	61	M			
1.6 16V (81 kW)	2008.11-		MT			Hatchback Engine K4M858	GDS50510	Drive Shaft	25	26	52.4	88.5	929				
	2008.11-					Hatchback Engine K4M858	GC050163	Outer Joint	25	23	52.4	88.5	61	M			
1.6 16V (82 kW)	2008.11-		MT			Hatchback Engine K4M760	GDS50510	Drive Shaft	25	26	52.4	88.5	929				
	2008.11-					Hatchback Engine K4M760	GC050163	Outer Joint	25	23	52.4	88.5	61	M			
1.6 16V Bifuel (81 kW)	2008.11-		MT			Hatchback Engine K4M866	GDS50510	Drive Shaft	25	26	52.4	88.5	929				
	2008.11-					Hatchback Engine K4M866	GC050163	Outer Joint	25	23	52.4	88.5	61	M			
1.6 DCi (96 kW)	2011.04-					Hatchback Engine R9M402/R9M404	GC050157	Outer Joint	25	33	52.6	89	60	I			
1.9 DCi (96 kW)	2008.11-					Hatchback Engine F9Q870/F9Q872	GC050157	Outer Joint	25	33	52.6	89	60	I			
<b>MEGANE III (DZ0/1_)</b>																	
1.4 TCE (96 kW)	2009.04-					Coupe Engine H4J700	GC050157	Outer Joint	25	33	52.6	89	60	I			





		TRANSM	L/R	F/R		G-AP Ref.	PRODUCT	ABS	Technical Specifications					
									YEAR	A	B	C	H	L
<b>RENAULT</b>														
<b>MEGANE III (DZ0/1_)</b>														
1.5 DCi (63 kW)	2008.11-		5MT	L	F	Coupe Engine K9KF830	GDS50426	Drive Shaft	25	26	52.7	88.5	680	
	2008.11-			L	F	Coupe Engine K9KF830	GDS50383	Drive Shaft	25	26	52.7	88.5	688	
	2008.11-			L	F	Coupe Engine K9KF830	GCI50096	Inner Joint	26	30	40	64	96	
	2008.11-			L	F	Coupe Engine K9KF830	GC050145	Outer Joint	25	33	52.7	88.5	59.5 I	
	2008.11-		MT	R	F	Coupe Engine K9KF830	GDS50425	Drive Shaft	25	26	52.7	88.5	931	
1.5 DCi (66 kW)	2008.11-		5MT	L	F	Coupe Engine K9KH834	GDS50426	Drive Shaft	25	26	52.7	88.5	680	
	2008.11-			L	F	Coupe Engine K9KH834	GDS50383	Drive Shaft	25	26	52.7	88.5	688	
	2008.11-			L	F	Coupe Engine K9KH834	GCI50096	Inner Joint	26	30	40	64	96	
	2008.11-			L	F	Coupe Engine K9KH834	GC050145	Outer Joint	25	33	52.7	88.5	59.5 I	
	2008.11-		MT	R	F	Coupe Engine K9KH834	GDS50425	Drive Shaft	25	26	52.7	88.5	931	
1.6 16V (74 kW)	2008.11-		5MT	L	F	Coupe Engine K4MP848	GDS50426	Drive Shaft	25	26	52.7	88.5	680	
	2008.11-			L	F	Coupe Engine K4MP848	GDS50383	Drive Shaft	25	26	52.7	88.5	688	
	2008.11-			L	F	Coupe Engine K4MP848	GCI50096	Inner Joint	26	30	40	64	96	
	2008.11-			L	F	Coupe Engine K4MP848	GC050145	Outer Joint	25	33	52.7	88.5	59.5 I	
	2008.11-		MT	R	F	Coupe Engine K4MP848	GDS50425	Drive Shaft	25	26	52.7	88.5	931	
1.6 16V (81 kW)	2008.11-					Coupe Engine K4MP848	GC050163	Outer Joint	25	23	52.4	88.5	61 M	
	2008.11-		MT	R	F	Coupe Engine K4M858	GDS50510	Drive Shaft	25	26	52.4	88.5	929	
1.6 16V Bifuel (81 kW)	2008.11-					Coupe Engine K4M866	GC050163	Outer Joint	25	23	52.4	88.5	61 M	
	2008.11-		MT	R	F	Coupe Engine K4M866	GDS50510	Drive Shaft	25	26	52.4	88.5	929	
1.6 DCi (96 kW)	2011.04-					Coupe Engine R9M402	GC050157	Outer Joint	25	33	52.6	89	60 I	
1.9 DCi (96 kW)	2008.11-					Coupe Engine F9Q870/F9Q872	GC050157	Outer Joint	25	33	52.6	89	60 I	
<b>MEGANE III GRANDTOUR (KZ0/1)</b>														
1.5 DCi (63 kW)	2009.03-		MT	L	F	Estate	GDS50426	Drive Shaft	25	26	52.7	88.5	680	
	2009.03-			L	F	Estate	GDS50383	Drive Shaft	25	26	52.7	88.5	688	
	2009.03-			L	F	Estate	GCI50096	Inner Joint	26	30	40	64	96	
	2009.03-			L	F	Estate	GC050145	Outer Joint	25	33	52.7	88.5	59.5 I	
	2009.03-		MT	R	F	Estate	GDS50425	Drive Shaft	25	26	52.7	88.5	931	
1.5 DCi (66 kW)	2009.05-		5MT	L	F	Estate Engine K9K834	GDS50426	Drive Shaft	25	26	52.7	88.5	680	
	2009.05-			L	F	Estate Engine K9K834	GDS50383	Drive Shaft	25	26	52.7	88.5	688	
	2009.05-			L	F	Estate Engine K9K834	GCI50096	Inner Joint	26	30	40	64	96	
	2009.05-			L	F	Estate Engine K9K834	GC050145	Outer Joint	25	33	52.7	88.5	59.5 I	
	2009.05-		MT	R	F	Estate Engine K9K834	GDS50425	Drive Shaft	25	26	52.7	88.5	931	
1.6 16V (74 kW)	2009.05-		5MT	L	F	Estate Engine K4M848	GDS50426	Drive Shaft	25	26	52.7	88.5	680	
	2009.05-			L	F	Estate Engine K4M848	GDS50383	Drive Shaft	25	26	52.7	88.5	688	
	2009.05-			L	F	Estate Engine K4M848	GCI50096	Inner Joint	26	30	40	64	96	
	2009.05-			L	F	Estate Engine K4M848	GC050145	Outer Joint	25	33	52.7	88.5	59.5 I	
	2009.05-		MT	R	F	Estate Engine K4M848	GDS50425	Drive Shaft	25	26	52.7	88.5	931	
	2009.05-					Estate Engine K4M848	GC050163	Outer Joint	25	23	52.4	88.5	61 M	
1.6 16V (81 kW)	2009.05-		MT	R	F	Estate Engine K4M858	GDS50510	Drive Shaft	25	26	52.4	88.5	929	
	2009.05-					Estate Engine K4M858	GC050163	Outer Joint	25	23	52.4	88.5	61 M	
1.6 16V Bifuel (81 kW)	2008.11-		MT	R	F	Estate Engine K4M866	GDS50510	Drive Shaft	25	26	52.4	88.5	929	
	2008.11-					Estate Engine K4M866	GC050163	Outer Joint	25	23	52.4	88.5	61 M	
1.6 DCi (96 kW)	2011.04-					Estate Engine K9M402/K9M404	GC050157	Outer Joint	25	33	52.6	89	60 I	
<b>MEGANE SCENIC (JA0/1_)</b>														
1.9 D (47 kW)	1997.03-1999.09		MT	L	F	MPV Engine F8Q790	GDS50131	Drive Shaft	44T	23	29.95	56.2	83.5	658.5
	1997.03-1999.09		MT	R	F	MPV Engine F8Q790	GDS50199	Drive Shaft	44T	23	23	57.5	83.5	748
	1997.03-1999.09		MT	L	F	MPV Engine F8Q790	GDS50130	Drive Shaft		23	29.95	56.2	83.5	658.5
	1997.03-1999.09		MT	R	F	MPV Engine F8Q790	GDS50252	Drive Shaft		23	23	57.5	83.5	748
2.0 i (80 kW)	1999.01-1999.09		MT	L	F	MPV Engine F3R796	GDS50131	Drive Shaft	44T	23	29.95	56.2	83.5	658.5
	1999.01-1999.09		MT	R	F	MPV Engine F3R796	GDS50199	Drive Shaft	44T	23	23	57.5	83.5	748
	1999.01-1999.09		MT	L	F	MPV Engine F3R796	GDS50130	Drive Shaft		23	29.95	56.2	83.5	658.5
	1999.01-1999.09		MT	R	F	MPV Engine F3R796	GDS50252	Drive Shaft		23	23	57.5	83.5	748
2.0 i (84 kW)	1997.01-1999.09		MT	L	F	MPV Engine F3R750/F3R751	GDS50131	Drive Shaft	44T	23	29.95	56.2	83.5	658.5
	1997.01-1999.09		MT	R	F	MPV Engine F3R750/F3R751	GDS50199	Drive Shaft	44T	23	23	57.5	83.5	748
	1997.01-1999.09		MT	L	F	MPV Engine F3R750/F3R751	GDS50130	Drive Shaft		23	29.95	56.2	83.5	658.5
	1997.01-1999.09		MT	R	F	MPV Engine F3R750/F3R751	GDS50252	Drive Shaft		23	23	57.5	83.5	748
<b>MODUS (F/JP0)</b>														
1.2 (74 kW)	2011-		MT				GC050092	Outer Joint		23	29	49	86	57 I
1.2 (76 kW)	2011-		MT				GC050092	Outer Joint		23	29	49	86	57 I
1.2 16V (48 kW)	2004.12-					G. Box: 5 Sp.	GC050112	Outer Joint		23	28	49	83.5	54.5 I









		TRANSM	L/R	F/R		G-AP Ref.	PRODUCT	ABS	Technical Specifications									
									YEAR	A	B	C	H	L	P			
<b>RENAULT</b>																		
<b>MODUS (F/JP0)</b>																		
1.2 16V (55 kW)	2004.12-				G. Box: 5 Sp.	GC050112	Outer Joint		23	28	49	83.5	54.5	I				
1.2 16V (58 kW)	2004.12-				G. Box: 5 Sp.	GC050112	Outer Joint		23	28	49	83.5	54.5	I				
1.4 16V (72 kW)	2004.12-					GC050092	Outer Joint		23	29	49	86	57	I				
	2004.12-					GC050112	Outer Joint		23	28	49	83.5	54.5	I				
1.5 DCi (48 kW)	2004.12-	2005.08				GC050092	Outer Joint		23	29	49	86	57	I				
1.5 DCi (50 kW)	2004.12-	2005.08				GC050092	Outer Joint		23	29	49	86	57	I				
	2005.08-					GC099085	Outer Joint		23	30	49	86	59	I				
1.5 DCi (55 kW)	2010-					GC050112	Outer Joint		23	28	49	83.5	54.5	I				
1.5 DCi (60 kW)	2004.12-	2005.08				GC050092	Outer Joint		23	29	49	86	57	I				
1.5 DCi (63 kW)	2004.12-	2005.08				GC050092	Outer Joint		23	29	49	86	57	I				
1.5 DCi (65 kW)	2010-					GC050112	Outer Joint		23	28	49	83.5	54.5	I				
1.6 (65 kW)	2004.12-		MT/AT		G. Box: 5 Sp.	GC099085	Outer Joint		23	30	49	86	59	I				
1.6 (82 kW)	2004.12-		MT/AT		G. Box: 5 Sp.	GC099085	Outer Joint		23	30	49	86	59	I				
<b>MODUS / GRAND MODUS (F/JP0_)</b>																		
1.2 (48 kW)	2005.05-			F	Hatchback Engine D4F740	GC050112	Outer Joint		23	28	49	83.5	54.5	I				
	2005.05-		L	F	Hatchback Engine D4F740	GDS50369	Drive Shaft		23	26	49	83.5	651					
	2005.05-		R	F	Hatchback Engine D4F740	GDS50372	Drive Shaft		23	26	49	83.5	890					
1.2 (55 kW)	2004.12-			F	Hatchback Engine D4F740	GC050112	Outer Joint		23	28	49	83.5	54.5	I				
	2004.12-		L	F	Hatchback Engine D4F740	GDS50369	Drive Shaft		23	26	49	83.5	651					
	2004.12-		R	F	Hatchback Engine D4F740	GDS50372	Drive Shaft		23	26	49	83.5	890					
1.2 (58 kW)	2004.12-		5MT	F	Hatchback Engine D4F764	GC050112	Outer Joint		23	28	49	83.5	54.5	I				
	2004.12-		6MT	F	Hatchback Engine D4F764	GC050143	Outer Joint		25	32	52.8	85.5	62.5	I				
	2004.12-		L	F	Hatchback Engine D4F764	GDS50369	Drive Shaft		23	26	49	83.5	651					
	2004.12-		R	F	Hatchback Engine D4F764	GDS50372	Drive Shaft		23	26	49	83.5	890					
1.2 16V (74 kW)	2007.04-		L	F	Hatchback Engine D4F784	GDS50369	Drive Shaft		23	26	49	83.5	651					
	2007.04-		R	F	Hatchback Engine D4F784	GDS50372	Drive Shaft		23	26	49	83.5	890					
1.2 16V Hi-Flex (55 kW)	2008.10-			F	Hatchback Engine D4F740	GC050112	Outer Joint		23	28	49	83.5	54.5	I				
1.4 (72 kW)	2004.12-			F	Hatchback Engine K4J770	GC050112	Outer Joint		23	28	49	83.5	54.5	I				
	2004.12-			F	Hatchback Engine K4J770	GC050092	Outer Joint		23	29	49	86	57	I				
	2004.12-		R	F	Hatchback Engine K4J770	GDS50354	Drive Shaft		23	26	49	86	897					
1.5 DCi (48 kW)	2004.12-		L	F	Hatchback Engine K9K752	GDS50353	Drive Shaft		23	26	49	86	649					
	2004.12-		R	F	Hatchback Engine K9K752	GDS50354	Drive Shaft		23	26	49	86	897					
1.5 DCi (50 kW)	2004.12-			F	Hatchback Engine K9K762/K9K768	GC099085	Outer Joint		23	30	49	86	59	I				
	2004.12-			F	Hatchback Engine K9K762/K9K768	GC050092	Outer Joint		23	29	49	86	57	I				
	2004.12-		R	F	Hatchback Engine K9K762/K9K768	GDS50354	Drive Shaft		23	26	49	86	897					
1.5 DCi (60 kW)	2004.09-			F	Hatchback Engine K9K750	GC050092	Outer Joint		23	29	49	86	57	I				
1.5 DCi (63 kW)	2004.12-			F	Hatchback Engine K9K760/K9K766	GC050092	Outer Joint		23	29	49	86	57	I				
	2004.12-		L	F	Hatchback Engine K9K760/K9K766	GDS50353	Drive Shaft		23	26	49	86	649					
	2004.12-		R	F	Hatchback Engine K9K760/K9K766	GDS50354	Drive Shaft		23	26	49	86	897					
1.5 DCi (65 kW)	2010.10-			Hatchback Engine K9K750	GC050117	Outer Joint		23	32	49	86	62	I					
1.5 DCi (76 kW)	2007.05-			F	Hatchback Engine K9K772	GC050143	Outer Joint		25	32	52.8	85.5	62.5	I				
	2007.05-		L	F	Hatchback Engine K9K772	GDS50353	Drive Shaft		23	26	49	86	649					
	2007.05-		R	F	Hatchback Engine K9K772	GDS50354	Drive Shaft		23	26	49	86	897					
	2007.05-		L	F	Hatchback Engine K9K772	GDS50379	Drive Shaft		25	26	52.8	85.5	650					
	2007.05-		R	F	Hatchback Engine K9K772	GDS50483	Drive Shaft		25	26	52.8	85.5	891					
1.5 DCi (78 kW)	2005.04-	2007.07		F	Hatchback Engine K9K764	GC050143	Outer Joint		25	32	52.8	85.5	62.5	I				
	2005.04-	2007.07	L	F	Hatchback Engine K9K764	GDS50353	Drive Shaft		23	26	49	86	649					
	2005.04-	2007.07	MT	L	F	Hatchback Engine K9K764	GDS50379	Drive Shaft		25	26	52.8	85.5	650				
	2005.04-	2007.07	R	F	Hatchback Engine K9K764	GDS50354	Drive Shaft		23	26	49	86	897					
	2005.04-	2007.07	MT	R	F	Hatchback Engine K9K764	GDS50483	Drive Shaft		25	26	52.8	85.5	891				
1.6 (65 kW)	2004.12-			F	Hatchback Engine K4M794	GC099085	Outer Joint		23	30	49	86	59	I				
	2004.12-		R	F	Hatchback Engine K4M794	GDS50443	Drive Shaft		23	23	49	86	789					
	2004.12-		MT		Hatchback Engine K4M794	GC050117	Outer Joint		23	32	49	86	62	I				
1.6 (82 kW)	2004.12-		5MT	F	Hatchback Engine K4M790/K4M791/K4M800/K4M801	GC099085	Outer Joint		23	30	49	86	59	I				
	2004.12-		L	F	Hatchback Engine K4M790/K4M791/K4M800/K4M801	GDS50353	Drive Shaft		23	26	49	86	649					
	2004.12-		R	F	Hatchback Engine K4M790/K4M791/K4M800/K4M801	GDS50443	Drive Shaft		23	23	49	86	789					
<b>PLUENCE</b>																		
1.5 DCi 16V	2009-		R	F		GDS50384	Drive Shaft		25	26	52.7	88.5	931					
1.6 16V	2009-		R	F		GDS50384	Drive Shaft		25	26	52.7	88.5	931					
<b>R12 TL</b>																		
1.5	1993.11-				ARGENTINA (5V)	GC050009	Outer Joint		20	30	48	107	57.5	I				

		YEAR	TRANSM	L/R	F/R		G-AP Ref.	PRODUCT	ABS	Technical Specifications										
										A	B	C	H	L	P					
<b>RENAULT</b>																				
<b>R12 TL</b>																				
1.6	1993.11-					ARGENTINA (5V)	GC050009	Outer Joint		20	30	48	107	57.5	I					
<b>RODEO 5</b>																				
1.1 (35 kW)	1981.11-	1987.12	MT	L/R	F	Convertible Engine 688712	GDS50005	Drive Shaft		23	22	36.3	90.5	661.5						
<b>RODEO 6</b>																				
1.1 (35 kW)	1973.08-	1981.11	MT	L/R	F	Convertible Engine 688.10	GDS50005	Drive Shaft		23	22	36.3	90.5	661.5						
<b>SAFRANE</b>																				
2.5 TD	1993.03-	1996.07				BV PK1	GCI50025	Inner Joint		39	25	30	450.5	76.1						
<b>SAFRANE (B54_)</b>																				
2.0 12V (97 kW)	1992.04-	1996.07		R	F	Hatchback Engine J7R734/J7R735	GDS50175	Drive Shaft		23	37.1	56.2	83.5	540						
	1992.04-	1996.07		L	F	Hatchback Engine J7R734/J7R735	GDS50008	Drive Shaft	30T	23	37.1	56.2	83.5	597.5						
	1992.04-	1996.07		R	F	Hatchback Engine J7R734/J7R735	GDS50105	Drive Shaft	30T	23	37.1	56.2	83.5	540						
2.1 DT (65 kW)	1993.11-	1996.07		R	F	Hatchback Engine J8S760	GDS50175	Drive Shaft		23	37.1	56.2	83.5	540						
	1993.11-	1996.07		L	F	Hatchback Engine J8S760	GDS50008	Drive Shaft	30T	23	37.1	56.2	83.5	597.5						
	1993.11-	1996.07		R	F	Hatchback Engine J8S760	GDS50105	Drive Shaft	30T	23	37.1	56.2	83.5	540						
	1993.11-	1996.07			F	Hatchback Engine J8S760	GC050026	Outer Joint		23	25	56.2	83.5	58	O					
	1993.11-	1996.07			F	Hatchback Engine J8S760	GC050045	Outer Joint	30T	23	25	56.2	83.5	58	O					
2.2 (101 kW)	1992.04-	1996.07		R	F	Hatchback Engine J7T760/J7T761	GDS50175	Drive Shaft		23	37.1	56.2	83.5	540						
	1992.04-	1996.07		L	F	Hatchback Engine J7T760/J7T761	GDS50008	Drive Shaft	30T	23	37.1	56.2	83.5	597.5						
	1992.04-	1996.07		R	F	Hatchback Engine J7T760/J7T761	GDS50105	Drive Shaft	30T	23	37.1	56.2	83.5	540						
	1992.04-	1996.07			F	Hatchback Engine J7T760/J7T761	GC050026	Outer Joint		23	25	56.2	83.5	58	O					
	1992.04-	1996.07			F	Hatchback Engine J7T760/J7T761	GC050045	Outer Joint	30T	23	25	56.2	83.5	58	O					
2.2 (79 kW)	1992.04-	1996.07		R	F	Hatchback Engine J7T762	GDS50175	Drive Shaft		23	37.1	56.2	83.5	540						
	1992.04-	1996.07		L	F	Hatchback Engine J7T762	GDS50008	Drive Shaft	30T	23	37.1	56.2	83.5	597.5						
	1992.04-	1996.07		R	F	Hatchback Engine J7T762	GDS50105	Drive Shaft	30T	23	37.1	56.2	83.5	540						
	1992.04-	1996.07			F	Hatchback Engine J7T762	GC050026	Outer Joint		23	25	56.2	83.5	58	O					
	1992.04-	1996.07			F	Hatchback Engine J7T762	GC050045	Outer Joint	30T	23	25	56.2	83.5	58	O					
2.5 DT (83 kW)	1992.12-	1996.07	AT	R	F	Hatchback Engine S8U762/S8U763	GDS50171	Drive Shaft	30T	23	39	56.2	83.5	1001						
	1992.12-	1996.07			F	Hatchback Engine S8U762/S8U763	GC050026	Outer Joint		23	25	56.2	83.5	58	O					
	1992.12-	1996.07			F	Hatchback Engine S8U762/S8U763	GC050045	Outer Joint	30T	23	25	56.2	83.5	58	O					
<b>SAFRANE II (B54_)</b>																				
2.0 16V (100 kW)	1996.07-	2000.12	MT	L	F	Hatchback Engine N7Q710/N7Q711	GDS50271	Drive Shaft	30T	23	26	64	84.5	670						
	1996.07-	2000.12	MT	R	F	Hatchback Engine N7Q710/N7Q711	GDS50099	Drive Shaft	30T	23	26	64	84.5	929						
	1996.07-	2000.12	MT		F	Hatchback Engine N7Q710/N7Q711	GC050056	Outer Joint	30T	23	27	64	84.5	68	I					
2.2 DT (83 kW)	1996.07-	2000.12	MT	L	F	Hatchback Engine G8T740	GDS50295	Drive Shaft	30T	23	37.1	64	84.5	598						
	1996.07-	2000.12	MT	R	F	Hatchback Engine G8T740	GDS50296	Drive Shaft	30T	23	39	64	84.5	985						
	1996.07-	2000.12	MT		F	Hatchback Engine G8T740	GC050056	Outer Joint	30T	23	27	64	84.5	68	I					
2.5 20V (121 kW)	1996.07-	2000.12	MT	L	F	Hatchback Engine N7U700/N7U701	GDS50100	Drive Shaft	30T	23	26	64	84.5	594						
	1996.07-	2000.12	MT	R	F	Hatchback Engine N7U700/N7U701	GDS50074	Drive Shaft	30T	23	26	64	84.5	1020						
	1996.07-	2000.12	MT		F	Hatchback Engine N7U700/N7U701	GC050056	Outer Joint	30T	23	27	64	84.5	68	I					
<b>SCENIC</b>																				
1.6 16V	2001.01-	2006.12	MT				GC099206	Outer Joint		23	21	56.2	83.5	57	M					
	2001.01-	2006.12	MT				GC050087	Outer Joint	44T	23	21	56.2	83.5	57	M					
2.0 16V	2001.01-	2006.12	MT				GC044064	Outer Joint		23	25	57	83.5	58	O					
	2001.01-	2006.12	MT				GC050086	Outer Joint	44T	23	25	57	83.5	58	O					
<b>SCENIC / J64</b>																				
-	2002-		AT				GC050053	Outer Joint		23	23	57	83	61	M					
	2002-		MT				GC050053	Outer Joint		23	23	57	83	61	M					
<b>SCENIC I (JA0/1)</b>																				
1.9 DCi (75 kW)	2000.11-	2003.08					GC050069	Outer Joint	44T	23	30	57.5	86.5	58.5	I					
1.9 DCi RX4 (74 kW)	2000.11-	2003.08					GC050082	Outer Joint	44T	23	23	58.8	85	61	M					
1.9 DCi RX4 (75 kW)	2000.11-	2003.08					GC050082	Outer Joint	44T	23	23	58.8	85	61	M					
1.9 DTi (59 kW)	2001.02-	2003.08					GC050069	Outer Joint	44T	23	30	57.5	86.5	58.5	I					
1.9 DTi (72 kW)	1999.09-	2003.08					GC050005	Outer Joint	44T	23	25	56.3	84	61.5	O					
2.0 16V RX4 (102 kW)	2000.06-	2003.08					GC050082	Outer Joint	44T	23	23	58.8	85	61	M					
<b>SCENIC I (JA0/1_)</b>																				
1.4 16V (70 kW)	1999.09-	2003.08	MT	L	F	MPV Engine K4J714/K4J750	GDS50009	Drive Shaft	44T	21	29.95	57	84.5	645.7						
	1999.09-	2003.08	MT	L	F	MPV Engine K4J714/K4J750	GDS50055	Drive Shaft		21	29.95	50	84	650						
	1999.09-	2003.08	MT	R	F	MPV Engine K4J714/K4J750	GDS50173	Drive Shaft		21	23	57	84.5	742.9						
	1999.09-	2003.08	MT	R	F	MPV Engine K4J714/K4J750	GDS50038	Drive Shaft	44T	21	23	52.2	85.5	752						
	1999.09-	2003.08	MT	R	F	MPV Engine K4J714/K4J750	GDS50316	Drive Shaft		21	23	57	84	741						
1.6 (75 kW)	2001.03-	2003.08	AT		F	MPV Engine K4M708/K4M709	GC050069	Outer Joint	44T	23	30	57.5	86.5	58.5	I					



		TRANSM	L/R	F/R		G-AP Ref.	PRODUCT	ABS	Technical Specifications							
									YEAR	A	B	C	H	L	P	
<b>RENAULT SCENIC I (JA0/1_)</b>																
1.6 (75 kW)	2001.03-	2003.08	MT		F	MPV Engine K4M708/K4M709	GC050114	Outer Joint	44T	23	35	57.5	87	71	I	
1.6 (79 kW)	1999.09-	2003.09	AT	L	F	MPV Engine K4M700/K4M706	GDS50253	Drive Shaft	44T	23	26	57.5	86.5	634		
	1999.09-	2003.09	MT	R	F	MPV Engine K4M700/K4M706	GDS50173	Drive Shaft		21	23	57	84.5	742.9		
	1999.09-	2003.09	MT			MPV Engine K4M700/K4M706	GC050052	Outer Joint	44T	23	30	57.5	86.5	58.5	I	
1.6 (81 kW)	2001.06-	2003.09				MPV	GC050052	Outer Joint	44T	23	30	57.5	86.5	58.5	I	
1.6 16V (85 kW)	1999.09-	2003.08	MT			MPV	GC050052	Outer Joint	44T	23	30	57.5	86.5	58.5	I	
1.8 16V (85 kW)	2001.01-	2003.08			F	MPV Engine F4P720/F4P722	GC050114	Outer Joint	44T	23	35	57.5	87	71	I	
	2001.01-	2003.08		L	F	MPV Engine F4P720/F4P722	GDS50160	Drive Shaft	44T	23	29.95	57	87	656.5		
	2001.01-	2003.08		R	F	MPV Engine F4P720/F4P722	GDS50313	Drive Shaft	44T	23	23	57.5	86.5	750		
	2001.01-	2003.08				MPV Engine F4P720/F4P722	GC050052	Outer Joint	44T	23	30	57.5	86.5	58.5	I	
1.9 DCi (75 kW)	1999.09-	2003.08			F	MPV Engine F9Q732/F9Q733	GC050069	Outer Joint	44T	23	30	57.5	86.5	58.5	I	
	1999.09-	2003.08	AT	L	F	MPV Engine F9Q732/F9Q733	GDS50253	Drive Shaft	44T	23	26	57.5	86.5	634		
	1999.09-	2003.08	MT	L	F	MPV Engine F9Q732/F9Q733	GDS50314	Drive Shaft	44T	23	29.95	57.5	86.5	654		
	1999.09-	2003.08		R	F	MPV Engine F9Q732/F9Q733	GDS50517	Drive Shaft	44T	23	23	57.5	86	779		
	1999.09-	2003.08	MT			MPV Engine F9Q732/F9Q733	GC050052	Outer Joint	44T	23	30	57.5	86.5	58.5	I	
1.9 DCi RX4 (74 kW)	2002.12-	2003.08	MT	R	F	MPV Engine F9Q732/F9Q748/F9Q796	GDS50254	Drive Shaft	44T	23	23	56.2	83.5	762		
	2002.12-	2003.08				MPV Engine F9Q732/F9Q748/F9Q796	GC050107	Outer Joint	44T	23	25	56.2	83.5	58	O	
1.9 DCi RX4 (75 kW)	2000.11-	2003.08				MPV Engine F9Q740	GC099283	Outer Joint	44T	23	23	58.8	85	61	M	
	2000.11-	2003.08	MT	L	F	MPV Engine F9Q740	GDS50324	Drive Shaft	44T	23	29.95	58.8	85	681		
	2000.11-	2003.08	MT	R	F	MPV Engine F9Q740	GDS50254	Drive Shaft	44T	23	23	56.2	83.5	762		
	2000.11-	2003.08	MT	R	F	MPV Engine F9Q740	GDS50389	Drive Shaft	44T	23	23	56.2	83.5	778		
	2000.11-	2003.08				MPV Engine F9Q740	GC050107	Outer Joint	44T	23	25	56.2	83.5	58	O	
1.9 DTi (59 kW)	2001.02-	2003.08			F	MPV Engine F9Q744	GC050069	Outer Joint	44T	23	30	57.5	86.5	58.5	I	
	2001.02-	2003.08		L	F	MPV Engine F9Q744	GDS50311	Drive Shaft	44T	23	29.95	56	82	650		
	2001.02-	2003.08		R	F	MPV Engine F9Q744	GDS99076	Drive Shaft	44T	23	23	56.2	83.5	742.5		
	2001.02-	2003.08		R	F	MPV Engine F9Q744	GDS50039	Drive Shaft	44T	23	23	57.5	86.5	748		
	2001.02-	2003.08				MPV Engine F9Q744	GC050052	Outer Joint	44T	23	30	57.5	86.5	58.5	I	
1.9 DTi (72 kW)	1999.09-	2003.08			F	MPV Engine F9Q731/F9Q734/F9Q736	GC050005	Outer Joint	44T	23	25	56.3	84	61.5	O	
	1999.09-	2003.08	AT	L	F	MPV Engine F9Q731/F9Q734/F9Q736	GDS50253	Drive Shaft	44T	23	26	57.5	86.5	634		
	1999.09-	2003.08	MT	L	F	MPV Engine F9Q731/F9Q734/F9Q736	GDS50029	Drive Shaft	44T	23	29.95	56.8	84	654		
	1999.09-	2003.08	MT	L	F	MPV Engine F9Q731/F9Q734/F9Q736	GDS50028	Drive Shaft		23	29.95	56.8	84	654		
	1999.09-	2003.08	MT	R	F	MPV Engine F9Q731/F9Q734/F9Q736	GDS50320	Drive Shaft	44T	23	23	56.8	84	755		
	1999.09-	2003.08	MT			MPV Engine F9Q731/F9Q734/F9Q736	GC050052	Outer Joint	44T	23	30	57.5	86.5	58.5	I	
	1999.09-	2003.08				MPV Engine F9Q731/F9Q734/F9Q736	GC050051	Outer Joint	48T	23	25	56.3	80	58	O	
2.0 16V (102 kW)	2000.07-	2003.08			F	MPV Engine F4R740/F4R741/F4R746	GC050114	Outer Joint	44T	23	35	57.5	87	71	I	
	2000.07-	2003.08	AT	L	F	MPV Engine F4R740/F4R741/F4R746	GDS50253	Drive Shaft	44T	23	26	57.5	86.5	634		
	2000.07-	2003.08	MT	L	F	MPV Engine F4R740/F4R741/F4R746	GDS50160	Drive Shaft	44T	23	29.95	57	87	656.5		
	2000.07-	2003.08	MT	R	F	MPV Engine F4R740/F4R741/F4R746	GDS50325	Drive Shaft	44T	23	23	56.3	85	744		
	2000.07-	2003.08	MT			MPV Engine F4R740/F4R741/F4R746	GC050052	Outer Joint	44T	23	30	57.5	86.5	58.5	I	
	2000.07-	2003.08				MPV Engine F4R740/F4R741/F4R746	GC050107	Outer Joint	44T	23	25	56.2	83.5	58	O	
2.0 16V (103 kW)	1999.09-	2003.08			F	MPV Engine F4R740/F4R741/F4R744	GC050114	Outer Joint	44T	23	35	57.5	87	71	I	
	1999.09-	2003.08	AT	L	F	MPV Engine F4R740/F4R741/F4R744	GDS50253	Drive Shaft	44T	23	26	57.5	86.5	634		
	1999.09-	2003.08	MT	L	F	MPV Engine F4R740/F4R741/F4R744	GDS50160	Drive Shaft	44T	23	29.95	57	87	656.5		
	1999.09-	2003.08	MT	R	F	MPV Engine F4R740/F4R741/F4R744	GDS50325	Drive Shaft	44T	23	23	56.3	85	744		
	1999.09-	2003.08	MT			MPV Engine F4R740/F4R741/F4R744	GC050052	Outer Joint	44T	23	30	57.5	86.5	58.5	I	
	1999.09-	2003.08				MPV Engine F4R740/F4R741/F4R744	GC050107	Outer Joint	44T	23	25	56.2	83.5	58	O	
2.0 16V RX4 (102 kW)	2000.06-	2003.08				MPV Engine F4R744/F4R746	GC099283	Outer Joint	44T	23	23	58.8	85	61	M	
	2000.06-	2003.08	MT	L	F	MPV Engine F4R744/F4R746	GDS50324	Drive Shaft	44T	23	29.95	58.8	85	681		
	2000.06-	2003.08	MT	R	F	MPV Engine F4R744/F4R746	GDS50254	Drive Shaft	44T	23	23	56.2	83.5	762		
	2000.06-	2003.08	MT	R	F	MPV Engine F4R744/F4R746	GDS50389	Drive Shaft	44T	23	23	56.2	83.5	778		
	2000.06-	2003.08				MPV Engine F4R744/F4R746	GC050107	Outer Joint	44T	23	25	56.2	83.5	58	O	
<b>SCENIC II</b>																
1.6	2001.04-	2004.02	MT	L	F		GDS50089	Drive Shaft	44T	23	29.95	56.2	83.5	653		
1.8	2000.07-	2003.03	MT	L	F		GDS50089	Drive Shaft	44T	23	29.95	56.2	83.5	653		
	2000.07-	2003.03	MT	R	F		GDS50091	Drive Shaft	44T	23	23	56.2	83.5	744		
2.0 16V	1999.06-	2004.02	MT	L	F		GDS50089	Drive Shaft	44T	23	29.95	56.2	83.5	653		
	1999.06-	2004.02	MT	R	F		GDS50091	Drive Shaft	44T	23	23	56.2	83.5	744		
<b>SCENIC II (JM0/1)</b>																
1.4 (72 kW)	2003.06-						GC050124	Outer Joint		25	22	52.6	88	55	I	
1.5 DCi (60 kW)	2003.06-						GC050093	Outer Joint		25	30	52.6	88	58	I	
1.5 DCi (63 kW)	2003.06-						GC050093	Outer Joint		25	30	52.6	88	58	I	





		TRANSM	L/R	F/R		G-AP Ref.	PRODUCT	ABS	Technical Specifications						
									YEAR	A	B	C	H	L	P
<b>RENAULT</b>															
<b>SCENIC II (JM0/1)</b>															
1.5 DCi (76 kW)	2005.05-		MT			GC050124	Outer Joint		25	22	52.6	88	55	I	
1.5 DCi (78 kW)	2005.05-		MT			GC050124	Outer Joint		25	22	52.6	88	55	I	
1.6 (77 kW)	2006.06-	2009				GC050124	Outer Joint		25	22	52.6	88	55	I	
1.6 16V (82 kW)	2007.01-					GC050124	Outer Joint		25	22	52.6	88	55	I	
1.9 DCi (88 kW)	2003.06-					GC099213	Outer Joint		25	33	53	88	61.5	I	
2.0 (99 kW)	2003.06-					GC099213	Outer Joint		25	33	53	88	61.5	I	
2.0 T 16V (120 kW)	2004.05-					GC099213	Outer Joint		25	33	53	88	61.5	I	
<b>SCENIC II (JM0/1_)</b>															
1.4 (72 kW)	2003.07-	2007.07			F	MPV Engine K4J730/K4J740	GC050116	Outer Joint	25	22	52.6	88	55	I	
	2003.07-	2007.07		L	F	MPV Engine K4J730/K4J740	GDS50494	Drive Shaft	25	26	52.6	88	664		
	2003.07-	2007.07	MT	L	F	MPV Engine K4J730/K4J740	GDS50350	Drive Shaft	25	26	52.6	88	668.5		
	2003.07-	2007.07	MT	R	F	MPV Engine K4J730/K4J740	GDS50442	Drive Shaft	25	26	52.6	88	911		
1.5 DCi (60 kW)	2003.07-	2005.11			F	MPV Engine K9K722	GC050093	Outer Joint	25	30	52.6	88	58	I	
	2003.07-	2005.11		L	F	MPV Engine K9K722	GDS50402	Drive Shaft	25	26	53	88	660		
	2003.07-	2005.11	MT	L	F	MPV Engine K9K722	GDS50350	Drive Shaft	25	26	52.6	88	668.5		
	2003.07-	2005.11		R	F	MPV Engine K9K722	GDS50348	Drive Shaft	25	26	53	88	905		
1.5 DCi (63 kW)	2003.07-	2005.11		R	F	MPV Engine K9K722	GDS50442	Drive Shaft	25	26	52.6	88	911		
	2005.04-	2006.10	MT	L	F	MPV Engine K9K724	GDS50350	Drive Shaft	25	26	52.6	88	668.5		
1.5 DCi (74 kW)	2005.04-	2006.10		R	F	MPV Engine K9K724	GDS50442	Drive Shaft	25	26	52.6	88	911		
	2003.11-	2004.03		L	F	MPV Engine K9K728/K9K729	GDS50403	Drive Shaft	25	26	52.6	88	674		
1.5 DCi (76 kW)	2003.11-	2004.03	MT	L	F	MPV Engine K9K728/K9K729	GDS50350	Drive Shaft	25	26	52.6	88	668.5		
	2003.11-	2004.03	MT	R	F	MPV Engine K9K728/K9K729	GDS50495	Drive Shaft	25	26	52.6	88	914		
	2007.01-			L	F	MPV Engine K9K734	GDS50403	Drive Shaft	25	26	52.6	88	674		
1.5 DCi (78 kW)	2007.01-		MT	R	F	MPV Engine K9K734	GDS50495	Drive Shaft	25	26	52.6	88	914		
	2007.01-		MT	L	F	MPV Engine K9K734	GDS50350	Drive Shaft	25	26	52.6	88	668.5		
	2005.04-	2006.10		L	F	MPV Engine K9K732	GDS50402	Drive Shaft	25	26	53	88	660		
1.6 (77 kW)	2005.04-	2006.10	MT	L	F	MPV Engine K9K732	GDS50350	Drive Shaft	25	26	52.6	88	668.5		
	2005.04-	2006.10		R	F	MPV Engine K9K732	GDS50348	Drive Shaft	25	26	53	88	905		
	2006.06-		MT	R	F	MPV Engine K4M788	GDS50442	Drive Shaft	25	26	52.6	88	911		
1.6 (83 kW)	2006.06-			F		MPV Engine K4M788	GC050116	Outer Joint	25	22	52.6	88	55	I	
	2003.07-	2007.07		L	F	MPV Engine K4M761/K4M782	GC050116	Outer Joint	25	22	52.6	88	55	I	
	2003.07-	2007.07	MT	L	F	MPV Engine K4M761/K4M782	GDS50494	Drive Shaft	25	26	52.6	88	664		
	2003.07-	2007.07	AT	R	F	MPV Engine K4M761/K4M782	GDS50386	Drive Shaft	25	23	52.6	88	806		
1.6 16V (82 kW)	2003.07-	2007.07	MT	R	F	MPV Engine K4M761/K4M782	GDS50442	Drive Shaft	25	26	52.6	88	911		
	2007.01-			L	F	MPV Engine K4M812/K4M9766/K4MC813	GDS50494	Drive Shaft	25	26	52.6	88	664		
	2007.01-		MT	R	F	MPV Engine K4M812/K4M9766/K4MC813	GDS50442	Drive Shaft	25	26	52.6	88	911		
1.9 DCi (81 kW)	2007.01-		MT	L	F	MPV Engine K4M812/K4M9766/K4MC813	GDS50350	Drive Shaft	25	26	52.6	88	668.5		
	2005.05-		MT	L	F	MPV Engine F9Q804	GDS99201	Drive Shaft	25	39	53	88	638		
1.9 DCi (88 kW)	2005.05-			R	F	MPV Engine F9Q804	GDS50400	Drive Shaft	25	39	53	88	932		
	2003.07-	2005.07			F	MPV Engine F9Q812	GC099213	Outer Joint	25	33	53	88	61.5	I	
1.9 DCi (96 kW)	2003.07-	2005.07	MT	L	F	MPV Engine F9Q812	GDS99201	Drive Shaft	25	39	53	88	638		
	2003.07-	2005.07		R	F	MPV Engine F9Q812	GDS50400	Drive Shaft	25	39	53	88	932		
	2005.05-	2007.07	MT	L	F	MPV Engine F9Q804/F9Q816/F9Q818/F9QJ803	GDS99201	Drive Shaft	25	39	53	88	638		
2.0 (99 kW)	2005.05-	2007.07	R	F		MPV Engine F9Q804/F9Q816/F9Q818/F9QJ803	GDS50400	Drive Shaft	25	39	53	88	932		
	2003.07-	2006.11			F	MPV Engine F4R770/F4R771	GC099213	Outer Joint	25	33	53	88	61.5	I	
	2003.07-	2006.11		L	F	MPV Engine F4R770/F4R771	GDS99186	Drive Shaft	25	26	52.6	88	669		
	2003.07-	2006.11	MT	L	F	MPV Engine F4R770/F4R771	GDS99201	Drive Shaft	25	39	53	88	638		
	2003.07-	2006.11		R	F	MPV Engine F4R770/F4R771	GDS50399	Drive Shaft	25	23	52.6	88	803		
	2003.07-	2006.11	MT	R	F	MPV Engine F4R770/F4R771	GDS50400	Drive Shaft	25	39	53	88	932		
2.0 16V Turbo (120 kW)	2003.07-	2006.11	AT			MPV Engine F4R770/F4R771	GC050137	Outer Joint	25	32	52.6	88	58	I	
	2003.11-	2006.10			F	MPV Engine F4R776	GC099213	Outer Joint	25	33	53	88	61.5	I	
	2003.11-	2006.10	MT	L	F	MPV Engine F4R776	GDS99201	Drive Shaft	25	39	53	88	638		
2.0 DCi (110 kW)	2003.11-	2006.10		R	F	MPV Engine F4R776	GDS50400	Drive Shaft	25	39	53	88	932		
	2006.07-			L	F	MPV Engine M9R700/M9R721/M9R722	GDS50444	Drive Shaft	27	39	56.5	90.5	626		
	2006.07-		MT	L	F	MPV Engine M9R700/M9R721/M9R722	GDS99201	Drive Shaft	25	39	53	88	638		
	2006.07-		MT	L	F	MPV Engine M9R700/M9R721/M9R722	GDS18274	Drive Shaft	27	30	56.5	90	624		
<b>SCENIC III (JZ0/1_)</b>	2006.07-			R	F	MPV Engine M9R700/M9R721/M9R722	GDS50400	Drive Shaft	25	39	53	88	932		
	2006.07-		MT	R	F	MPV Engine M9R700/M9R721/M9R722	GDS50453	Drive Shaft	27	39	56.5	90.5	973.5		
	2009.02-		MT			MPV Engine H4J700	GC050157	Outer Joint	25	33	52.6	89	60	I	



		TRANSM	L/R	F/R		G-AP Ref.	PRODUCT	ABS	Technical Specifications							
									YEAR	A	B	C	H	L	P	
<b>RENAULT SCENIC III (JZ0/1_)</b>																
1.5 DCi (63 kW)	2009.04-		MT	L	F	MPV Engine K9K830	GDS50426	Drive Shaft	25	26	52.7	88.5	680			
	2009.04-		MT	R	F	MPV Engine K9K830	GDS50425	Drive Shaft	25	26	52.7	88.5	931			
1.5 DCi (70 kW)	2010.11-		5MT	L	F	MPV Engine K9K846	GDS50426	Drive Shaft	25	26	52.7	88.5	680			
	2010.11-		MT	R	F	MPV Engine K9K846	GDS50425	Drive Shaft	25	26	52.7	88.5	931			
1.6 16V (81 kW)	2009.02-		MT	R	F	MPV Engine K4M858	GDS50510	Drive Shaft	25	26	52.4	88.5	929			
	2009.02-					MPV Engine K4M858	GC050163	Outer Joint	25	23	52.4	88.5	61	M		
1.6 DCi (96 kW)	2011.04-				R	F	MPV Engine R9M402/R9M404	GDS50429	Drive Shaft	27	39	56.5	91.5	956		
	2011.04-		MT				MPV Engine R9M402/R9M404	GC050157	Outer Joint	25	33	52.6	89	60	I	
1.6 E85 (81 kW)	2009.02-		MT	R	F	MPV Engine K4M866	GDS50510	Drive Shaft	25	26	52.4	88.5	929			
	2009.02-						MPV Engine K4M866	GC050163	Outer Joint	25	23	52.4	88.5	61	M	
1.9 DCi (96 kW)	2009.02-					F	MPV Engine F9Q870	GC099213	Outer Joint	25	33	53	88	61.5	I	
	2009.02-				R	F	MPV Engine F9Q870	GDS50429	Drive Shaft	27	39	56.5	91.5	956		
<b>SUPER 5 (B/C40_)</b>																
1.0 (30 kW)	1984.10-	1988.10	MT	R	F	Hatchback Engine C1C700	GDS50023	Drive Shaft	21	23	46.2	82	680			
	1984.10-	1988.10	MT	L	F	Hatchback Engine C1C700	GDS50025	Drive Shaft	21	29.95	46.2	82	612			
	1984.10-	1988.10	MT&3AT	R	F	Hatchback Engine C1C700	GDS50044	Drive Shaft	21	23	46.4	81.5	693.5			
	1984.10-	1988.10	3AT	L	F	Hatchback Engine C1C700	GDS50201	Drive Shaft	21	29.95	49.8	83.5	597			
	1984.10-	1988.10	MT	R	F	Hatchback Engine C1C700	GDS50032	Drive Shaft	21	23	49.8	83.5	690			
	1984.10-	1988.10	MT	L	F	Hatchback Engine C1C700	GDS50024	Drive Shaft	21	29.95	46.4	81.5	599			
1.1 (33 kW)	1986.01-	1995.03	MT	R	F	Hatchback Engine C1E750/C1E752/C1E756/C1E760	GDS50023	Drive Shaft	21	23	46.2	82	680			
	1986.01-	1995.03	MT	L	F	Hatchback Engine C1E750/C1E752/C1E756/C1E760	GDS50025	Drive Shaft	21	29.95	46.2	82	612			
	1986.01-	1995.03	MT&3AT	R	F	Hatchback Engine C1E750/C1E752/C1E756/C1E760	GDS50044	Drive Shaft	21	23	46.4	81.5	693.5			
	1986.01-	1995.03	3AT	L	F	Hatchback Engine C1E750/C1E752/C1E756/C1E760	GDS50201	Drive Shaft	21	29.95	49.8	83.5	597			
	1986.01-	1995.03	MT	R	F	Hatchback Engine C1E750/C1E752/C1E756/C1E760	GDS50032	Drive Shaft	21	23	49.8	83.5	690			
	1986.01-	1995.03	MT	L	F	Hatchback Engine C1E750/C1E752/C1E756/C1E760	GDS50024	Drive Shaft	21	29.95	46.4	81.5	599			
1.1 (34 kW)	1984.10-	1988.10	MT	R	F	Hatchback Engine C1E750/C1E752/C1E754	GDS50023	Drive Shaft	21	23	46.2	82	680			
	1984.10-	1988.10	MT	L	F	Hatchback Engine C1E750/C1E752/C1E754	GDS50025	Drive Shaft	21	29.95	46.2	82	612			
	1984.10-	1988.10	MT&3AT	R	F	Hatchback Engine C1E750/C1E752/C1E754	GDS50044	Drive Shaft	21	23	46.4	81.5	693.5			
	1984.10-	1988.10	3AT	L	F	Hatchback Engine C1E750/C1E752/C1E754	GDS50201	Drive Shaft	21	29.95	49.8	83.5	597			
	1984.10-	1988.10	MT	R	F	Hatchback Engine C1E750/C1E752/C1E754	GDS50032	Drive Shaft	21	23	49.8	83.5	690			
	1984.10-	1988.10	MT	L	F	Hatchback Engine C1E750/C1E752/C1E754	GDS50024	Drive Shaft	21	29.95	46.4	81.5	599			
1.4 (43 kW)	1984.10-	1988.06	MT	R	F	Hatchback Engine C1J768/C1J780	GDS50023	Drive Shaft	21	23	46.2	82	680			
	1984.10-	1988.06	MT	L	F	Hatchback Engine C1J768/C1J780	GDS50025	Drive Shaft	21	29.95	46.2	82	612			
	1984.10-	1988.06	MT&3AT	R	F	Hatchback Engine C1J768/C1J780	GDS50044	Drive Shaft	21	23	46.4	81.5	693.5			
	1984.10-	1988.06	3AT	L	F	Hatchback Engine C1J768/C1J780	GDS50201	Drive Shaft	21	29.95	49.8	83.5	597			
	1984.10-	1988.06	MT	R	F	Hatchback Engine C1J768/C1J780	GDS50032	Drive Shaft	21	23	49.8	83.5	690			
	1984.10-	1988.06	MT	L	F	Hatchback Engine C1J768/C1J780	GDS50024	Drive Shaft	21	29.95	46.4	81.5	599			
1.4 (44 kW)	1987.06-	1990.08	MT	R	F	Hatchback Engine C2J784	GDS50023	Drive Shaft	21	23	46.2	82	680			
	1987.06-	1990.08	MT	L	F	Hatchback Engine C2J784	GDS50025	Drive Shaft	21	29.95	46.2	82	612			
	1987.06-	1990.08	MT&3AT	R	F	Hatchback Engine C2J784	GDS50044	Drive Shaft	21	23	46.4	81.5	693.5			
	1987.06-	1990.08	3AT	L	F	Hatchback Engine C2J784	GDS50201	Drive Shaft	21	29.95	49.8	83.5	597			
	1987.06-	1990.08	MT	R	F	Hatchback Engine C2J784	GDS50032	Drive Shaft	21	23	49.8	83.5	690			
	1987.06-	1990.08	MT	L	F	Hatchback Engine C2J784	GDS50024	Drive Shaft	21	29.95	46.4	81.5	599			
1.4 (49 kW)	1987.06-	1989.07	MT	R	F	Hatchback Engine C2J782	GDS50023	Drive Shaft	21	23	46.2	82	680			
	1987.06-	1989.07	MT	L	F	Hatchback Engine C2J782	GDS50025	Drive Shaft	21	29.95	46.2	82	612			
	1987.06-	1989.07	MT&3AT	R	F	Hatchback Engine C2J782	GDS50044	Drive Shaft	21	23	46.4	81.5	693.5			
	1987.06-	1989.07	3AT	L	F	Hatchback Engine C2J782	GDS50201	Drive Shaft	21	29.95	49.8	83.5	597			
	1987.06-	1989.07	MT	R	F	Hatchback Engine C2J782	GDS50032	Drive Shaft	21	23	49.8	83.5	690			
	1987.06-	1989.07	MT	L	F	Hatchback Engine C2J782	GDS50024	Drive Shaft	21	29.95	46.4	81.5	599			
1.4 (52 kW)	1984.10-	1989.07	MT	R	F	Hatchback Engine C2J700/C2J780/C2J781/C2J788/C2J789/C2J798	GDS50023	Drive Shaft	21	23	46.2	82	680			
	1984.10-	1989.07	MT	L	F	Hatchback Engine C2J700/C2J780/C2J781/C2J788/C2J789/C2J798	GDS50025	Drive Shaft	21	29.95	46.2	82	612			
	1984.10-	1989.07	MT&3AT	R	F	Hatchback Engine C2J700/C2J780/C2J781/C2J788/C2J789/C2J798	GDS50044	Drive Shaft	21	23	46.4	81.5	693.5			
	1984.10-	1989.07	3AT	L	F	Hatchback Engine C2J700/C2J780/C2J781/C2J788/C2J789/C2J798	GDS50201	Drive Shaft	21	29.95	49.8	83.5	597			
	1984.10-	1989.07	MT	R	F	Hatchback Engine C2J700/C2J780/C2J781/C2J788/C2J789/C2J798	GDS50032	Drive Shaft	21	23	49.8	83.5	690			
	1984.10-	1989.07	MT	L	F	Hatchback Engine C2J700/C2J780/C2J781/C2J788/C2J789/C2J798	GDS50024	Drive Shaft	21	29.95	46.4	81.5	599			
1.4 CAT (43 kW)	1985.10-	1996.12	MT	R	F	Hatchback Engine C3J700/C3J702/C3J760	GDS50023	Drive Shaft	21	23	46.2	82	680			
	1985.10-	1996.12	MT	L	F	Hatchback Engine C3J700/C3J702/C3J760	GDS50025	Drive Shaft	21	29.95	46.2	82	612			
	1985.10-	1996.12	MT&3AT	R	F	Hatchback Engine C3J700/C3J702/C3J760	GDS50044	Drive Shaft	21	23	46.4	81.5	693.5			
	1985.10-	1996.12	3AT	L	F	Hatchback Engine C3J700/C3J702/C3J760	GDS50201	Drive Shaft	21	29.95	49.8	83.5	597			
	1985.10-	1996.12	MT	R	F	Hatchback Engine C3J700/C3J702/C3J760	GDS50032	Drive Shaft	21	23	49.8	83.5	690			
	1985.10-	1996.12	MT	L	F	Hatchback Engine C3J700/C3J702/C3J760	GDS50024	Drive Shaft	21	29.95	46.4	81.5	599			





		TRANSM	L/R	F/R		G-AP Ref.	PRODUCT	ABS	Technical Specifications						
									YEAR	A	B	C	H	L	P
<b>RENAULT</b>															
<b>SUPER 5 (B/C40_)</b>															
1.4 Turbo (88 kW)	1985.04-	1990.08	MT	R	F	Hatchback Engine C1J782/C1J784/C1J788	GDS50023	Drive Shaft		21	23	46.2	82	680	
	1985.04-	1990.08	MT	L	F	Hatchback Engine C1J782/C1J784/C1J788	GDS50025	Drive Shaft		21	29.95	46.2	82	612	
	1985.04-	1990.08	MT&3AT	R	F	Hatchback Engine C1J782/C1J784/C1J788	GDS50044	Drive Shaft		21	23	46.4	81.5	693.5	
	1985.04-	1990.08	3AT	L	F	Hatchback Engine C1J782/C1J784/C1J788	GDS50201	Drive Shaft		21	29.95	49.8	83.5	597	
	1985.04-	1990.08	MT	R	F	Hatchback Engine C1J782/C1J784/C1J788	GDS50032	Drive Shaft		21	23	49.8	83.5	690	
	1985.04-	1990.08	MT	L	F	Hatchback Engine C1J782/C1J784/C1J788	GDS50024	Drive Shaft		21	29.95	46.4	81.5	599	
1.6 D (40 kW)	1985.08-	1996.12	MT	R	F	Hatchback Engine F8M720/F8M730	GDS50044	Drive Shaft		21	23	46.4	81.5	693.5	
	1985.08-	1996.12	MT	L	F	Hatchback Engine F8M720/F8M730	GDS50024	Drive Shaft		21	29.95	46.4	81.5	599	
1.7 (54 kW)	1986.10-	1995.03	MT	R	F	Hatchback Engine F3N716/F3N717	GDS50023	Drive Shaft		21	23	46.2	82	680	
	1986.10-	1995.03	MT	L	F	Hatchback Engine F3N716/F3N717	GDS50025	Drive Shaft		21	29.95	46.2	82	612	
	1986.10-	1995.03	MT&3AT	R	F	Hatchback Engine F3N716/F3N717	GDS50044	Drive Shaft		21	23	46.4	81.5	693.5	
	1986.10-	1995.03	3AT	L	F	Hatchback Engine F3N716/F3N717	GDS50201	Drive Shaft		21	29.95	49.8	83.5	597	
	1986.10-	1995.03	MT	R	F	Hatchback Engine F3N716/F3N717	GDS50032	Drive Shaft		21	23	49.8	83.5	690	
	1986.10-	1995.03	MT	L	F	Hatchback Engine F3N716/F3N717	GDS50024	Drive Shaft		21	29.95	46.4	81.5	599	
1.7 (64 kW)	1987.06-	1995.03	MT	R	F	Hatchback Engine F2N740/F2N742	GDS50023	Drive Shaft		21	23	46.2	82	680	
	1987.06-	1995.03	MT	L	F	Hatchback Engine F2N740/F2N742	GDS50025	Drive Shaft		21	29.95	46.2	82	612	
	1987.06-	1995.03	MT&3AT	R	F	Hatchback Engine F2N740/F2N742	GDS50044	Drive Shaft		21	23	46.4	81.5	693.5	
	1987.06-	1995.03	3AT	L	F	Hatchback Engine F2N740/F2N742	GDS50201	Drive Shaft		21	29.95	49.8	83.5	597	
	1987.06-	1995.03	MT	R	F	Hatchback Engine F2N740/F2N742	GDS50032	Drive Shaft		21	23	49.8	83.5	690	
	1987.06-	1995.03	MT	L	F	Hatchback Engine F2N740/F2N742	GDS50024	Drive Shaft		21	29.95	46.4	81.5	599	
1.7 i (69 kW)	1986.10-	1991.08	MT	R	F	Hatchback Engine F3N702/F3N722	GDS50023	Drive Shaft		21	23	46.2	82	680	
	1986.10-	1991.08	MT	L	F	Hatchback Engine F3N702/F3N722	GDS50025	Drive Shaft		21	29.95	46.2	82	612	
	1986.10-	1991.08	MT&3AT	R	F	Hatchback Engine F3N702/F3N722	GDS50044	Drive Shaft		21	23	46.4	81.5	693.5	
	1986.10-	1991.08	3AT	L	F	Hatchback Engine F3N702/F3N722	GDS50201	Drive Shaft		21	29.95	49.8	83.5	597	
	1986.10-	1991.08	MT	R	F	Hatchback Engine F3N702/F3N722	GDS50032	Drive Shaft		21	23	49.8	83.5	690	
	1986.10-	1991.08	MT	L	F	Hatchback Engine F3N702/F3N722	GDS50024	Drive Shaft		21	29.95	46.4	81.5	599	
<b>THALIA (LB0/1/2)</b>															
1.4 (55 kW)	2000.08-						GC050004	Outer Joint	26T	21	30	52.2	85.5	59	I
1.4 16V (72 kW)	2000.08-						GC050004	Outer Joint	26T	21	30	52.2	85.5	59	I
1.5 DCi (48 kW)	2002.04-						GC050004	Outer Joint	26T	21	30	52.2	85.5	59	I
<b>THALIA I (LB0/1/2_)</b>															
1.4 (55 kW)	2000.08-		AT	R	F	Saloon Engine K7J700	GDS99150	Drive Shaft	26T	21	23	52.2	85.5	747	
	2000.08-		MT	R	F	Saloon Engine K7J700	GC150058	Inner Joint		23	22	36.3	40	64.5	
1.4 16V (72 kW)	2000.08-		AT	L	F	Saloon Engine K4J712	GDS50519	Drive Shaft	44T	21	26	52.2	85.5	609	
	2000.08-		AT	R	F	Saloon Engine K4J712	GDS99150	Drive Shaft	26T	21	23	52.2	85.5	747	
	2000.08-		MT	R	F	Saloon Engine K4J712	GC150058	Inner Joint		23	22	36.3	40	64.5	
1.5 DCi (47 kW)	2005.06-		MT	L	F	Saloon Engine K9K740	GDS50280	Drive Shaft	44T	23	26	57.5	86.5	602	
	2005.06-		MT	L/R	F	Saloon Engine K9K740	GC099087	Outer Joint		23	30	57.5	86.5	58.5	I
	2005.06-		MT	R	F	Saloon Engine K9K740	GDS50373	Drive Shaft	44T	23	26	57.5	86.5	864	
1.5 DCi (48 kW)	2002.04-				F	Saloon Engine K9K700	GC050004	Outer Joint	26T	21	30	52.2	85.5	59	I
	2002.04-		MT	L	F	Saloon Engine K9K700	GDS50397	Drive Shaft		21	29.95	50	84	632	
	2002.04-		MT	R	F	Saloon Engine K9K700	GDS50395	Drive Shaft	26T	21	23	51.5	83	728	
	2002.04-		MT	R	F	Saloon Engine K9K700	GDS50437	Drive Shaft		21	23	51.5	83	729	
1.5 DCi (60 kW)	2001.06-		MT	L	F	Saloon Engine K9K702	GDS50280	Drive Shaft	44T	23	26	57.5	86.5	602	
	2001.06-		MT	L/R	F	Saloon Engine K9K702	GC099087	Outer Joint		23	30	57.5	86.5	58.5	I
	2001.06-		MT	R	F	Saloon Engine K9K702	GDS50373	Drive Shaft	44T	23	26	57.5	86.5	864	
<b>TRAFIC</b>															
2.2	1991.01-	1999.12	MT				GC099076	Outer Joint		25	27	56.3	110.5	62	I
2.5 DTi (99 KW)	2003.05-						GC045015	Outer Joint		21	20	56.4	76	56	O
All Models	1984.11-	1989.12					GC050010	Outer Joint		23	27	56.3	110	62	I
<b>TRAFIC (P6)</b>															
1.4 (35 kW)	1980.03-	1989.04			R	Platform/Chassis Engine 847700/C1J700	GC050027	Outer Joint		23	25	56.3	109	56	O
	1980.03-	1989.04	MT	L/R	R	Platform/Chassis Engine 847700/C1J700	GDS50006	Drive Shaft		23	27	56.3	109	712.5	
1.6 (48 kW)	1980.03-	1986.06			R	Platform/Chassis Engine 841705/A1M705	GC050027	Outer Joint		23	25	56.3	109	56	O
	1980.03-	1986.06	MT	L/R	R	Platform/Chassis Engine 841705/A1M705	GDS50006	Drive Shaft		23	27	56.3	109	712.5	
1.7 (50 kW)	1986.06-	1989.04			R	Platform/Chassis Engine F1N722	GC050027	Outer Joint		23	25	56.3	109	56	O
	1986.06-	1989.04	MT	L/R	R	Platform/Chassis Engine F1N722	GDS50006	Drive Shaft		23	27	56.3	109	712.5	
2.0 (59 kW)	1980.03-	1989.04			R	Platform/Chassis Engine J5R726	GC050027	Outer Joint		23	25	56.3	109	56	O
	1980.03-	1989.04	MT	L/R	R	Platform/Chassis Engine J5R726	GDS50006	Drive Shaft		23	27	56.3	109	712.5	
2.0 (63 kW)	1980.03-	1986.12			R	Platform/Chassis Engine 829720/829721	GC050027	Outer Joint		23	25	56.3	109	56	O
	1980.03-	1986.12	MT	L/R	R	Platform/Chassis Engine 829720/829721	GDS50006	Drive Shaft		23	27	56.3	109	712.5	





		TRANSM	L/R	F/R		G-AP Ref.	PRODUCT	ABS	Technical Specifications						
									YEAR	A	B	C	H	L	P
<b>RENAULT</b>															
<b>TRAFIC (P6)</b>															
2.1 D (43 kW)	1980.03-1989.04			R	Platform/Chassis Engine 852720	GC050027	Outer Joint		23	25	56.3	109	56	O	
	1980.03-1989.04	MT	L/R	R	Platform/Chassis Engine 852720	GDS50006	Drive Shaft		23	27	56.3	109	712.5		
2.5 D (51 kW)	1980.03-1989.04			R	Platform/Chassis Engine 8140.61.240/S8U720/S8U722	GC050027	Outer Joint		23	25	56.3	109	56	O	
	1980.03-1989.04	MT	L/R	R	Platform/Chassis Engine 8140.61.240/S8U720/S8U722	GDS50006	Drive Shaft		23	27	56.3	109	712.5		
<b>TRAFIC (PXX)</b>															
1.7 (50 kW)	1989.05-1994.08	MT	L/R	F	Platform/Chassis Engine F1N722	GDS44006	Drive Shaft		25	27	56.3	110.5	713.5		
2.0 (59 kW)	1989.05-1997.10	MT	L/R	R	Platform/Chassis Engine J5R726	GDS44006	Drive Shaft		25	27	56.3	110.5	713.5		
2.1 D (43 kW)	1989.05-1994.06	MT	L/R	R	Platform/Chassis Engine 852720	GDS44006	Drive Shaft		25	27	56.3	110.5	713.5		
2.1 D (47 kW)	1994.06-1997.10	MT	L/R	R	Platform/Chassis Engine J8S620/J8S758	GDS44006	Drive Shaft		25	27	56.3	110.5	713.5		
2.5 D (51 kW)	1989.05-2001.03	MT	L/R	F	Platform/Chassis Engine 8140.61.240/S8U720/S8U722	GDS44006	Drive Shaft		25	27	56.3	110.5	713.5		
<b>TRAFIC (T1, T3, T4)</b>															
1.4 (35 kW)	1980.03-1989.04	MT	L/R	F	Box Engine 847700/847701/C1J700	GDS50006	Drive Shaft		23	27	56.3	109	712.5		
	1980.03-1989.04			F	Box Engine 847700/847701/C1J700	GC050027	Outer Joint		23	25	56.3	109	56	O	
1.6 (48 kW)	1983.01-1986.06	MT	L/R	F	Box Engine A1M707/A1M708	GDS50006	Drive Shaft		23	27	56.3	109	712.5		
	1983.01-1986.06			F	Box Engine A1M707/A1M708	GC050027	Outer Joint		23	25	56.3	109	56	O	
1.6 4x4 (48 kW)	1985.08-1986.06	MT	L/R		Box Engine A1M707	GDS50006	Drive Shaft		23	27	56.3	109	712.5		
	1985.08-1986.06				Box Engine A1M707	GC050027	Outer Joint		23	25	56.3	109	56	O	
1.7 (50 kW)	1986.06-1989.04	MT	L/R	F	Box Engine F1N724	GDS50006	Drive Shaft		23	27	56.3	109	712.5		
	1986.06-1989.04			F	Box Engine F1N724	GC050027	Outer Joint		23	25	56.3	109	56	O	
2.0 (59 kW)	1986.06-1989.04	MT	L/R	F	Box Engine J5R716/J5R722/J5R726	GDS50006	Drive Shaft		23	27	56.3	109	712.5		
	1986.06-1989.04			F	Box Engine J5R716/J5R722/J5R726	GC050027	Outer Joint		23	25	56.3	109	56	O	
2.0 4x4 (59 kW)	1986.06-1989.04	MT	L/R		Box Engine J5R716/J5R722/J5R726	GDS50006	Drive Shaft		23	27	56.3	109	712.5		
	1986.06-1989.04				Box Engine J5R716/J5R722/J5R726	GC050027	Outer Joint		23	25	56.3	109	56	O	
2.1 D (43 kW)	1980.09-1989.04	MT	L/R	F	Box Engine 852750	GDS50006	Drive Shaft		23	27	56.3	109	712.5		
	1980.09-1989.04			F	Box Engine 852750	GC050027	Outer Joint		23	25	56.3	109	56	O	
2.1 D 4x4 (43 kW)	1986.11-1989.04	MT	L/R		Box Engine 852750	GDS50006	Drive Shaft		23	27	56.3	109	712.5		
	1986.11-1989.04				Box Engine 852750	GC050027	Outer Joint		23	25	56.3	109	56	O	
<b>TRAFIC (T5, T6, T7)</b>															
1.4 (35 kW)	1980.03-1989.04	MT	L/R	F	Bus Engine 847700/847701/C1J700	GDS50006	Drive Shaft		23	27	56.3	109	712.5		
	1980.03-1989.04			F	Bus Engine 847700/847701/C1J700	GC050027	Outer Joint		23	25	56.3	109	56	O	
1.6 (48 kW)	1984.01-1986.06	MT	L/R	F	Bus Engine 841705/A1M707/A1M708	GDS50006	Drive Shaft		23	27	56.3	109	712.5		
	1984.01-1986.06			F	Bus Engine 841705/A1M707/A1M708	GC050027	Outer Joint		23	25	56.3	109	56	O	
1.6 4x4 (48 kW)	1980.03-1986.08	MT	L/R		Bus Engine A1M707	GDS50006	Drive Shaft		23	27	56.3	109	712.5		
	1980.03-1986.08				Bus Engine A1M707	GC050027	Outer Joint		23	25	56.3	109	56	O	
1.7 (50 kW)	1986.06-1989.04	MT	L/R	F	Bus Engine F1N724	GDS50006	Drive Shaft		23	27	56.3	109	712.5		
	1986.06-1989.04			F	Bus Engine F1N724	GC050027	Outer Joint		23	25	56.3	109	56	O	
2.0 (59 kW)	1986.06-1989.04	MT	L/R	F	Bus Engine J5R716/J5R722/J5R726	GDS50006	Drive Shaft		23	27	56.3	109	712.5		
	1986.06-1989.04			F	Bus Engine J5R716/J5R722/J5R726	GC050027	Outer Joint		23	25	56.3	109	56	O	
2.0 4x4 (59 kW)	1986.06-1989.04	MT	L/R		Bus Engine J5R716/J5R722/J5R726	GDS50006	Drive Shaft		23	27	56.3	109	712.5		
	1986.06-1989.04				Bus Engine J5R716/J5R722/J5R726	GC050027	Outer Joint		23	25	56.3	109	56	O	
2.1 D (43 kW)	1980.03-1989.04	MT	L/R	F	Bus Engine 852750	GDS50006	Drive Shaft		23	27	56.3	109	712.5		
	1980.03-1989.04			F	Bus Engine 852750	GC050027	Outer Joint		23	25	56.3	109	56	O	
<b>TRAFIC (TXW)</b>															
1.7 (50 kW)	1992.08-1994.08	MT	L/R	F	Bus Engine F1N724	GDS44006	Drive Shaft		25	27	56.3	110.5	713.5		
1.9 D (44 kW)	1997.06-2001.03	MT	L/R	F	Bus Engine F8Q606	GDS44006	Drive Shaft		25	27	56.3	110.5	713.5		
2.0 (59 kW)	1989.05-1990.08	MT	L/R	F	Bus Engine J5R726	GDS44006	Drive Shaft		25	27	56.3	110.5	713.5		
2.1 D (43 kW)	1989.05-1994.06	MT	L/R	F	Bus Engine 852720/852750	GDS44006	Drive Shaft		25	27	56.3	110.5	713.5		
2.1 D (47 kW)	1994.06-1997.10	MT	L/R	F	Bus Engine J8S620/J8S758	GDS44006	Drive Shaft		25	27	56.3	110.5	713.5		
2.2 (70 kW)	1989.05-1994.06	MT	L/R	F	Bus Engine J7T780	GDS44006	Drive Shaft		25	27	56.3	110.5	713.5		
2.2 (74 kW)	1994.06-1997.10	MT	L/R	F	Bus Engine J7T600	GDS44006	Drive Shaft		25	27	56.3	110.5	713.5		
2.5 D (55 kW)	1989.05-2001.03	MT	L/R	F	Bus Engine 8140.67.2500/8140.67.2550/8140.67.2580/S8U750/S8U752/S8U758	GDS44006	Drive Shaft		25	27	56.3	110.5	713.5		
2.5 D 4x4 (55 kW)	1989.08-2001.03	MT	L/R	F	Bus Engine 8140.67.2500/8140.67.2550/8140.67.2580/S8U750/S8U752/S8U758	GDS44006	Drive Shaft		25	27	56.3	110.5	713.5		
<b>TRAFIC (TXX)</b>															
1.4 (35 kW)	1989.05-1991.06	MT	L/R	F	Box Engine C1J700	GDS44006	Drive Shaft		25	27	56.3	110.5	713.5		
1.7 (50 kW)	1992.08-1994.08	MT	L/R	F	Box Engine F1N720	GDS44006	Drive Shaft		25	27	56.3	110.5	713.5		
1.9 D (44 kW)	1997.06-2001.03	MT	L/R	F	Box Engine F8Q606	GDS44006	Drive Shaft		25	27	56.3	110.5	713.5		
2.0 (59 kW)	1989.05-1990.08	MT	L/R	F	Box Engine J5R716	GDS44006	Drive Shaft		25	27	56.3	110.5	713.5		
2.1 D (43 kW)	1989.05-1994.06	MT	L/R	F	Box Engine 852750	GDS44006	Drive Shaft		25	27	56.3	110.5	713.5		
2.1 D (47 kW)	1994.06-1997.10	MT	L/R	F	Box Engine J8S620/J8S758	GDS44006	Drive Shaft		25	27	56.3	110.5	713.5		
2.2 (70 kW)	1989.05-1994.06	MT	L/R	F	Box Engine J7T780	GDS44006	Drive Shaft		25	27	56.3	110.5	713.5		
2.2 (74 kW)	1994.06-1997.10	MT	L/R	F	Box Engine J7T600	GDS44006	Drive Shaft		25	27	56.3	110.5	713.5		



		TRANSM	L/R	F/R		G-AP Ref.	PRODUCT	ABS	Technical Specifications							
									YEAR	A	B	C	H	L	P	
<b>RENAULT TRAFIC (TXX)</b>																
2.2 4x4 (70 kW)	1989.05-	1994.06	MT	L/R	F	Box Engine J7T780	GDS44006	Drive Shaft	25	27	56.3	110.5	713.5			
2.2 4x4 (74 kW)	1994.06-	1997.10	MT	L/R	F	Box Engine J7T600	GDS44006	Drive Shaft	25	27	56.3	110.5	713.5			
2.5 D (55 kW)	1989.05-	2001.03	MT	L/R	F	Box Engine 8140.67.2500/8140.67.2550/8140.67.2580/S8U750/S8U752/S8U758	GDS44006	Drive Shaft	25	27	56.3	110.5	713.5			
<b>TRAFIC DIESEL</b>																
2.1	1989.05-			L/R			GDS50183	Drive Shaft	25	27	56.3	110.5	716			
2.5	1989.05-			L/R			GDS50183	Drive Shaft	25	27	56.3	110.5	716			
<b>TRAFIC ESSENCE</b>																
1.7	1989.05-			L/R			GDS50183	Drive Shaft	25	27	56.3	110.5	716			
2	1989.05-			L/R			GDS50183	Drive Shaft	25	27	56.3	110.5	716			
<b>TRAFIC II (EL)</b>																
1.9 DCi (60 kW)	2001.03-				F	Platform/Chassis Engine F9Q762	GC018105	Outer Joint	27	26	56.5	93.5	64	M		
	2001.03-			L	F	Platform/Chassis Engine F9Q762	GDS44003	Drive Shaft	27	37.1	56.5	93.5	676			
	2001.03-			R	F	Platform/Chassis Engine F9Q762	GDS44013	Drive Shaft	27	39	56.5	93.5	1020			
1.9 DCi (74 kW)	2001.03-				F	Platform/Chassis Engine F9Q760	GC018105	Outer Joint	27	26	56.5	93.5	64	M		
	2001.03-			L	F	Platform/Chassis Engine F9Q760	GDS44003	Drive Shaft	27	37.1	56.5	93.5	676			
	2001.03-			R	F	Platform/Chassis Engine F9Q760	GDS44013	Drive Shaft	27	39	56.5	93.5	1020			
2.0 (88 kW)	2001.03-			F	Platform/Chassis Engine F4R720	GC018105	Outer Joint	27	26	56.5	93.5	64	M			
2.0 DCi (66 kW)	2006.08-				F	Platform/Chassis Engine M9R780/M9R782	GC060005	Outer Joint	27	36	56.6	94	71	I		
	2006.08-			L	F	Platform/Chassis Engine M9R780/M9R782	GDS60022	Drive Shaft	27	39	56.6	94	694			
	2006.08-			R	F	Platform/Chassis Engine M9R780/M9R782	GDS18271	Drive Shaft	27	39	56.6	94	1013			
2.0 DCi (84 kW)	2006.08-				F	Platform/Chassis Engine M9R780/M9R782/M9R786	GC060005	Outer Joint	27	36	56.6	94	71	I		
	2006.08-			L	F	Platform/Chassis Engine M9R780/M9R782/M9R786	GDS60022	Drive Shaft	27	39	56.6	94	694			
	2006.08-			R	F	Platform/Chassis Engine M9R780/M9R782/M9R786	GDS18271	Drive Shaft	27	39	56.6	94	1013			
2.5 DCi (107 kW)	2006.08-				F	Platform/Chassis Engine G9U630	GC060005	Outer Joint	27	36	56.6	94	71	I		
	2006.08-			L	F	Platform/Chassis Engine G9U630	GDS50497	Drive Shaft	27	39	56.6	94	667			
	2006.08-			R	F	Platform/Chassis Engine G9U630	GDS18301	Drive Shaft	27	39	56.6	94	1045			
2.5 DCi (99 kW)	2001.03-			L	F	Platform/Chassis Engine G9U730	GDS50557	Drive Shaft	27	37.1	56.5	92	634			
	2001.03-			R	F	Platform/Chassis Engine G9U730	GDS50562	Drive Shaft	27	39	56.5	92	1056			
	2001.03-			R	F	Platform/Chassis Engine G9U730	GC150097	Inner Joint	39	35	30	409	90			
	2001.03-			R	F	Platform/Chassis Engine G9U730	GC050080	Outer Joint	27	37	56.5	92	73	I		
<b>TRAFIC II (JL)</b>																
1.9 DCi (60 kW)	2001.03-				F	Bus Engine F9Q762	GC018105	Outer Joint	27	26	56.5	93.5	64	M		
	2001.03-		5MT		F	Bus Engine F9Q762	GC044034	Outer Joint	27	26	56.5	93.5	64	M		
	2001.03-			L	F	Bus Engine F9Q762	GDS44003	Drive Shaft	27	37.1	56.5	93.5	676			
	2001.03-			R	F	Bus Engine F9Q762	GDS44013	Drive Shaft	27	39	56.5	93.5	1020			
1.9 DCi (74 kW)	2001.03-				F	Bus Engine F9Q760	GC018105	Outer Joint	27	26	56.5	93.5	64	M		
	2001.03-		6MT		F	Bus Engine F9Q760	GC044034	Outer Joint	27	26	56.5	93.5	64	M		
	2001.03-			L	F	Bus Engine F9Q760	GDS44003	Drive Shaft	27	37.1	56.5	93.5	676			
	2001.03-			R	F	Bus Engine F9Q760	GDS44013	Drive Shaft	27	39	56.5	93.5	1020			
2.0 (88 kW)	2001.03-			F	Bus Engine F4R720/F4R722	GC018105	Outer Joint	27	26	56.5	93.5	64	M			
2.0 16V (86 kW)	2001.03-		6MT		F	Bus Engine F4R720/F4R722	GC044034	Outer Joint	27	26	56.5	93.5	64	M		
	2001.03-			L	F	Bus Engine F4R720/F4R722	GDS44003	Drive Shaft	27	37.1	56.5	93.5	676			
	2001.03-			R	F	Bus Engine F4R720/F4R722	GDS44013	Drive Shaft	27	39	56.5	93.5	1020			
2.0 DCi (66 kW)	2006.08-			F	Bus Engine M9R782	GC060005	Outer Joint	27	36	56.6	94	71	I			
2.0 DCi (84 kW)	2006.08-			L	F	Bus Engine M9R782	GDS60022	Drive Shaft	27	39	56.6	94	694			
	2006.08-			R	F	Bus Engine M9R782	GDS18271	Drive Shaft	27	39	56.6	94	1013			
	2006.08-				F	Bus Engine M9R780/M9R692/M9R786/M9R782/M9R630	GC060005	Outer Joint	27	36	56.6	94	71	I		
2.5 DCi (107 kW)	2006.08-			L	F	Bus Engine M9R780/M9R692/M9R786/M9R782/M9R630	GDS60022	Drive Shaft	27	39	56.6	94	694			
	2006.08-			R	F	Bus Engine M9R780/M9R692/M9R786/M9R782/M9R630	GDS18271	Drive Shaft	27	39	56.6	94	1013			
	2006.08-				F	Bus Engine G9U630	GC060005	Outer Joint	27	36	56.6	94	71	I		
2.5 DCi (84 kW)	2006.08-			L	F	Bus Engine G9U630	GDS50497	Drive Shaft	27	39	56.6	94	667			
	2006.08-			R	F	Bus Engine G9U630	GDS18301	Drive Shaft	27	39	56.6	94	1045			
	2008.02-			L	F	Bus Engine G9U630	GDS50497	Drive Shaft	27	39	56.6	94	667			
2.5 DCi (99 kW)	2008.02-			R	F	Bus Engine G9U630	GDS18301	Drive Shaft	27	39	56.6	94	1045			
	2003.05-			L	F	Bus Engine G9U730	GDS50557	Drive Shaft	27	37.1	56.5	92	634			
	2003.05-			R	F	Bus Engine G9U730	GDS50562	Drive Shaft	27	39	56.5	92	1056			
2.5 DCi (99 kW)	2003.05-			R	F	Bus Engine G9U730	GC150097	Inner Joint	39	35	30	409	90			
	2003.05-			R	F	Bus Engine G9U730	GC050080	Outer Joint	27	37	56.5	92	73	I		
	2003.05-			R	F	Bus Engine G9U730	GC050080	Outer Joint	27	37	56.5	92	73	I		
<b>TRAFIC II VAN (FL)</b>																
1.9 DCi (60 kW)	2001.03-				F	Box Engine F9Q760/F9Q762	GC018105	Outer Joint	27	26	56.5	93.5	64	M		





		TRANSM	L/R	F/R		G-AP Ref.	PRODUCT	ABS	Technical Specifications								
									YEAR	A	B	C	H	L	P		
<b>RENAULT TRAFIC II VAN (FL)</b>																	
1.9 DCi (60 kW)	2001.03-		5MT		F	Box Engine F9Q760/F9Q762	GC044034	Outer Joint		27	26	56.5	93.5	64	M		
	2001.03-			L	F	Box Engine F9Q760/F9Q762	GDS44003	Drive Shaft		27	37.1	56.5	93.5	676			
	2001.03-			R	F	Box Engine F9Q760/F9Q762	GDS44013	Drive Shaft		27	39	56.5	93.5	1020			
1.9 DCi (74 kW)	2001.03-				F	Box Engine F9Q760	GC018105	Outer Joint		27	26	56.5	93.5	64	M		
	2001.03-		6MT		F	Box Engine F9Q760	GC044034	Outer Joint		27	26	56.5	93.5	64	M		
	2001.03-			L	F	Box Engine F9Q760	GDS44003	Drive Shaft		27	37.1	56.5	93.5	676			
	2001.03-			R	F	Box Engine F9Q760	GDS44013	Drive Shaft		27	39	56.5	93.5	1020			
2.0 (88 kW)	2001.03-				F	Box Engine F4R720/F4R722	GC018105	Outer Joint		27	26	56.5	93.5	64	M		
	2001.03-		6MT		F	Box Engine F4R720/F4R722	GC044034	Outer Joint		27	26	56.5	93.5	64	M		
	2001.03-			L	F	Box Engine F4R720/F4R722	GDS44003	Drive Shaft		27	37.1	56.5	93.5	676			
	2001.03-			R	F	Box Engine F4R720/F4R722	GDS44013	Drive Shaft		27	39	56.5	93.5	1020			
2.0 16V (86 kW)	2006.08-				F	Box Engine F4R820	GC018105	Outer Joint		27	26	56.5	93.5	64	M		
2.0 DCi (66 kW)	2006.08-				F	Box Engine M9R780/M9R782/M9R630	GC060005	Outer Joint		27	36	56.6	94	71	I		
	2006.08-			L	F	Box Engine M9R780/M9R782/M9R630	GDS60022	Drive Shaft		27	39	56.6	94	694			
	2006.08-			R	F	Box Engine M9R780/M9R782/M9R630	GDS18271	Drive Shaft		27	39	56.6	94	1013			
2.0 DCi (84 kW)	2006.08-				F	Box Engine M9R692/M9R780/M9R782/M9R786	GC060005	Outer Joint		27	36	56.6	94	71	I		
	2006.08-			L	F	Box Engine M9R692/M9R780/M9R782/M9R786	GDS60022	Drive Shaft		27	39	56.6	94	694			
	2006.08-			R	F	Box Engine M9R692/M9R780/M9R782/M9R786	GDS18271	Drive Shaft		27	39	56.6	94	1013			
2.5 DCi (107 kW)	2006.08-				F	Box Engine G9U630	GC060005	Outer Joint		27	36	56.6	94	71	I		
	2006.08-			L	F	Box Engine G9U630	GDS50497	Drive Shaft		27	39	56.6	94	667			
	2006.08-			R	F	Box Engine G9U630	GDS18301	Drive Shaft		27	39	56.6	94	1045			
2.5 DCi (99 kW)	2003.05-			L	F	Box Engine G9U730	GDS50557	Drive Shaft		27	37.1	56.5	92	634			
	2003.05-			R	F	Box Engine G9U730	GDS50562	Drive Shaft		27	39	56.5	92	1056			
	2003.05-			R	F	Box Engine G9U730	GCI50097	Inner Joint		39	35	30	409	90			
	2003.05-			R	F	Box Engine G9U730	GC050080	Outer Joint		27	37	56.5	92	73	I		
2.5 DTi (99 kW)	2003.03-2003.07			L	F	Box Engine G9U730	GDS50557	Drive Shaft		27	37.1	56.5	92	634			
	2003.03-2003.07			R	F	Box Engine G9U730	GDS50562	Drive Shaft		27	39	56.5	92	1056			
	2003.03-2003.07			R	F	Box Engine G9U730	GCI50097	Inner Joint		39	35	30	409	90			
	2003.03-2003.07			R	F	Box Engine G9U730	GC050080	Outer Joint		27	37	56.5	92	73	I		
<b>TWINGO I (C06)</b>																	
1.2 16V (44 kW)	2001.01-						GC050066	Outer Joint	44T	21	28	52.5	85	51	I		
1.2 16V (55 kW)	2001.01-						GC050066	Outer Joint	44T	21	28	52.5	85	51	I		
<b>TWINGO I (C06_)</b>																	
1.2 16V (44 kW)	2004.08-		MT	L	F	Hatchback Engine D4F708	GDS50102	Drive Shaft	38T	21	29.95	57	84.5	625.7			
	2004.08-		MT	L	F	Hatchback Engine D4F708	GDS50401	Drive Shaft	44T	21	29.95	57	84	629			
	2004.08-		MT	L	F	Hatchback Engine D4F708	GDS50150	Drive Shaft		21	29.95	49.8	83.5	623			
	2004.08-		MT	R	F	Hatchback Engine D4F708	GDS50359	Drive Shaft	38T	21	23	57	84	739			
	2004.08-		MT	R	F	Hatchback Engine D4F708	GDS50438	Drive Shaft	44T	21	23	52.3	84.5	740			
	2004.08-		MT	R	F	Hatchback Engine D4F708	GDS50095	Drive Shaft		21	23	46.2	80.5	734			
	2004.08-		MT	R	F	Hatchback Engine D4F708	GCI50058	Inner Joint		23	22	36.3	40	64.5			
1.2 16V (55 kW)	2001.01-		MT	L	F	Hatchback Engine D4F702	GDS50401	Drive Shaft	44T	21	29.95	57	84	629			
	2001.01-		MT	L	F	Hatchback Engine D4F702	GDS50307	Drive Shaft	26T	21	29.95	57	84	623			
	2001.01-		MT	R	F	Hatchback Engine D4F702	GDS50438	Drive Shaft	44T	21	23	52.3	84.5	740			
	2001.01-		MT	R	F	Hatchback Engine D4F702	GDS50308	Drive Shaft	26T	21	23	57	84	737			
<b>TWINGO II (CN0)</b>																	
1.2 (43 kW)	2007.03-						GC050112	Outer Joint		23	28	49	83.5	54.5	I		
1.2 16V (55 kW)	2009.03-		MT				GC050112	Outer Joint		23	28	49	83.5	54.5	I		
1.2 16V (56 kW)	2009.03-		MT				GC050112	Outer Joint		23	28	49	83.5	54.5	I		
1.2 T (74 kW)	2007.03-						GC050092	Outer Joint		23	29	49	86	57	I		
1.5 DCi (47 kW)	2007.03-						GC050092	Outer Joint		23	29	49	86	57	I		
1.5 DCi (62 kW)	2007.03-						GC050092	Outer Joint		23	29	49	86	57	I		
1.6 RS (98 kW)	2008.05-						GC050093	Outer Joint		25	30	52.6	88	58	I		
<b>TWINGO II (CN0_)</b>																	
1.2 (43 kW)	2008.01-				F	Hatchback Engine D7F800	GC050112	Outer Joint		23	28	49	83.5	54.5	I		
	2008.01-			L	F	Hatchback Engine D7F800	GDS50544	Drive Shaft		23	30	49	83.5	631			
	2008.01-			R	F	Hatchback Engine D7F800	GDS50542	Drive Shaft		23	23	49	83.5	721			
1.2 16V (55 kW)	2007.03-				F	Hatchback Engine D4F722	GC050112	Outer Joint		23	28	49	83.5	54.5	I		
	2007.03-		MT	L	F	Hatchback Engine D4F722	GDS50544	Drive Shaft		23	30	49	83.5	631			
	2007.03-		MT/AT	R	F	Hatchback Engine D4F722	GDS50542	Drive Shaft		23	23	49	83.5	721			
1.2 16V (56 kW)	2007.03-				F	Hatchback Engine D4F772	GC050112	Outer Joint		23	28	49	83.5	54.5	I		
	2007.03-		MT	L	F	Hatchback Engine D4F772	GDS50544	Drive Shaft		23	30	49	83.5	631			









		TRANSM	L/R	F/R		G-AP Ref.	PRODUCT	ABS	Technical Specifications								
									YEAR	A	B	C	H	L	P		
<b>RENAULT</b>																	
<b>TWINGO II (CNO.)</b>																	
1.2 16V (56 kW)	2007.03-		MT/AT	R	F	Hatchback Engine D4F772	GDS50542	Drive Shaft		23	23	49	83.5	721			
1.2 TCE (75 kW)	2011.02-			L	F	Hatchback Engine D4F780/D4F782	GDS50539	Drive Shaft		23	26	49	86	611			
	2011.02-			L	F	Hatchback Engine D4F780/D4F782	GC150048	Inner Joint		26	30	40	64	121			
	2011.02-			L	F	Hatchback Engine D4F780/D4F782	GC050092	Outer Joint		23	29	49	86	57	I		
1.2 Turbo (74 kW)	2007.07-				F	Hatchback Engine D4F780	GC050112	Outer Joint		23	28	49	83.5	54.5	I		
	2007.07-			L	F	Hatchback Engine D4F780	GDS50539	Drive Shaft		23	26	49	86	611			
	2007.07-			L	F	Hatchback Engine D4F780	GC150048	Inner Joint		26	30	40	64	121			
	2007.07-			L	F	Hatchback Engine D4F780	GC050092	Outer Joint		23	29	49	86	57	I		
1.5 DCi (47 kW)	2007.03-			L	F	Hatchback Engine K9K740	GDS50539	Drive Shaft		23	26	49	86	611			
	2007.03-			L/R	F	Hatchback Engine K9K740	GC199169	Inner Joint		26	30	33	326	95			
	2007.03-			L/R	F	Hatchback Engine K9K740	GC050092	Outer Joint		23	29	49	86	57	I		
	2007.03-			R	F	Hatchback Engine K9K740	GDS50538	Drive Shaft		23	26	49	86	868			
<b>VEL SATIS</b>																	
2.0 T 16V (120 kW)	2002.06-						GC018105	Outer Joint		27	26	56.5	93.5	64	M		
2.2 DCi (102 kW)	2004.09-						GC018105	Outer Joint		27	26	56.5	93.5	64	M		
2.2 DCi (110 kW)	2002.06-						GC018105	Outer Joint		27	26	56.5	93.5	64	M		
2.2 DCi (85 kW)	2004.04-						GC018105	Outer Joint		27	26	56.5	93.5	64	M		
<b>RENAULT LCV</b>																	
<b>CLIO II (SB0/1/2), VAN</b>																	
1.5 DCi (48 kW)	2001.06-						GC050004	Outer Joint	26T	21	30	52.2	85.5	59	I		
<b>CLIO III, VAN</b>																	
1.5 DCi (50 kW)	2005-						GC050092	Outer Joint		23	29	49	86	57	I		
<b>KANGOO I (FC0/1), VAN</b>																	
1.5 DCi (48 kW)	2001.12-						GC050069	Outer Joint	44T	23	30	57.5	86.5	58.5	I		
1.5 DCi (50 kW)	2001.12-						GC050069	Outer Joint	44T	23	30	57.5	86.5	58.5	I		
1.6 16V 4WD (70 kW)	2001.10-						GC050004	Outer Joint	26T	21	30	52.2	85.5	59	I		
1.9 DCi (62 kW)	2003.07-						GC050069	Outer Joint	44T	23	30	57.5	86.5	58.5	I		
<b>MASTER III</b>																	
2.5 DCi (73 kW)	2000-	2010				Ch-B000461	GC044026	Outer Joint	51T	28	36	65	96	71	I		
2.5 DCi (74 kW)	2006-	2010				Ch-B000461	GC044026	Outer Joint	51T	28	36	65	96	71	I		
2.5 DCi (84 kW)	2006-	2010				Ch-B000461	GC044026	Outer Joint	51T	28	36	65	96	71	I		
2.5 DCi (88 kW)	2006-						GC044026	Outer Joint	51T	28	36	65	96	71	I		
3.0 DCi (100 kW)	2003-						GC044026	Outer Joint	51T	28	36	65	96	71	I		
<b>MEGANE II VAN</b>																	
1.5 DCi (50 kW)	2004-						GC099085	Outer Joint		23	30	49	86	59	I		
1.5 DCi (55 kW)	2004-						GC099085	Outer Joint		23	30	49	86	59	I		
<b>MODUS VAN</b>																	
1.2 16V (55 kW)	2004-						GC050112	Outer Joint		23	28	49	83.5	54.5	I		
1.5 DCi (50 kW)	2004-						GC050092	Outer Joint		23	29	49	86	57	I		
1.5 DCi (63 kW)	2004-						GC050092	Outer Joint		23	29	49	86	57	I		
<b>TRAFIC III (EL, FL, J6)</b>																	
1.9 DCi (60 kW)	2001.03-						GC018105	Outer Joint		27	26	56.5	93.5	64	M		
1.9 DCi (74 kW)	2001.03-						GC018105	Outer Joint		27	26	56.5	93.5	64	M		
2.0 (88 kW)	2001.03-						GC018105	Outer Joint		27	26	56.5	93.5	64	M		
2.5 Dci (99 kW)	2003.09-						GC050041	Outer Joint		27	37	56.5	93	72	I		
<b>ROVER</b>																	
<b>100 / METRO (XP)</b>																	
1.1 C/L/S (44 kW)	1990.03-	1998.12	MT/AT		F	Hatchback Engine 11K2A/11K2D	GC051010	Outer Joint		25	22	50	82	56	I		
1.4 S/L/GTA (55 kW)	1990.03-	1998.12	MT/AT		F	Hatchback Engine 14K2A/14K2D	GC051010	Outer Joint		25	22	50	82	56	I		
1.5 D (42 kW)	1994.12-	1998.12	MT		F	Hatchback Engine TUD5	GC051010	Outer Joint		25	22	50	82	56	I		
<b>200 (XW)</b>																	
1.4 GSi/Si (70 kW)	1990.01-	1995.10			F	Hatchback Engine 14K4C	GC099209	Outer Joint	27T	26	22	49	78.8	55	I		
	1990.01-	1995.10	MT	L	F	Hatchback Engine 14K4C	GDS51001	Drive Shaft		26	22	49	78.8	642			
	1990.01-	1995.10	MT	R	F	Hatchback Engine 14K4C	GDS51010	Drive Shaft		26	22	49	78.8	877			
	1990.01-	1995.10	MT	L	F	Hatchback Engine 14K4C	GDS51023	Drive Shaft	27T	26	22	49	78.8	642			
1.4 GSi/Si (76 kW)	1992.12-	1995.10			F	Hatchback Engine 14K4F	GC099209	Outer Joint	27T	26	22	49	78.8	55	I		
	1992.12-	1995.10	MT	L	F	Hatchback Engine 14K4F	GDS51001	Drive Shaft		26	22	49	78.8	642			
	1992.12-	1995.10	MT	R	F	Hatchback Engine 14K4F	GDS51010	Drive Shaft		26	22	49	78.8	877			
	1992.12-	1995.10	MT	L	F	Hatchback Engine 14K4F	GDS51023	Drive Shaft	27T	26	22	49	78.8	642			
1.4 Si/GSi (66 kW)	1989.10-	1995.10			F	Hatchback Engine 14K4C/14K4D	GC099209	Outer Joint	27T	26	22	49	78.8	55	I		

		TRANSM	L/R	F/R		G-AP Ref.	PRODUCT	ABS	Technical Specifications						
									YEAR	A	B	C	H	L	P
<b>ROVER</b>															
<b>200 (XW)</b>															
1.4 Si/GSi (66 kW)	1989.10-	1995.10	MT	L	F	Hatchback Engine 14K4C/14K4D	GDS51001	Drive Shaft		26	22	49	78.8	642	
	1989.10-	1995.10	MT	R	F	Hatchback Engine 14K4C/14K4D	GDS51010	Drive Shaft		26	22	49	78.8	877	
	1989.10-	1995.10	MT	L	F	Hatchback Engine 14K4C/14K4D	GDS51023	Drive Shaft	27T	26	22	49	78.8	642	
1.6 (90 kW)	1992.10-	1999.06	MT	L	F	Coupe Engine D16A8	GDS23122	Drive Shaft		26	27	49	78.8	608	
	1992.10-	1999.06	MT	R	F	Coupe Engine D16A8	GDS23078	Drive Shaft		26	27	49	78.8	606	
	1992.10-	1999.06	AT		F	Coupe Engine D16A8	GC023020	Outer Joint		26	23	49	78.5	54.5 M	
	1992.10-	1999.06	MT		F	Coupe Engine D16A8	GC023007	Outer Joint		26	23	49	78.8	55 I	
	1992.10-	1999.06	MT		F	Coupe Engine D16A8	GC023008	Outer Joint	50T	26	23	49	78.8	55 I	
	1992.10-	1999.06	MT	L	F	Coupe Engine D16A8	GDS81020	Drive Shaft	50T	26	27	49	78.8	608	
	1992.10-	1999.06	MT	R	F	Coupe Engine D16A8	GDS23040	Drive Shaft	50T	26	27	49	78.8	606	
1.6 GSi (82 kW)	1989.10-	1995.10	MT	L	F	Hatchback Engine D16Z2	GDS23122	Drive Shaft		26	27	49	78.8	608	
	1989.10-	1995.10	MT	R	F	Hatchback Engine D16Z2	GDS23078	Drive Shaft		26	27	49	78.8	606	
	1989.10-	1995.10			F	Hatchback Engine D16Z2	GC051024	Outer Joint		26	23	49	78.5	55.5 M	
	1989.10-	1995.10	MT		F	Hatchback Engine D16Z2	GC023020	Outer Joint		26	23	49	78.5	54.5 M	
	1989.10-	1995.10	MT		F	Hatchback Engine D16Z2	GC023007	Outer Joint		26	23	49	78.8	55 I	
	1989.10-	1995.10	MT		F	Hatchback Engine D16Z2	GC023008	Outer Joint	50T	26	23	49	78.8	55 I	
	1989.10-	1995.10	MT	L	F	Hatchback Engine D16Z2	GDS81020	Drive Shaft	50T	26	27	49	78.8	608	
1.6 GTi (90 kW)	1990.09-	1995.10	MT	L	F	Hatchback Engine D16A8	GDS23122	Drive Shaft		26	27	49	78.8	608	
	1990.09-	1995.10	MT	R	F	Hatchback Engine D16A8	GDS23078	Drive Shaft		26	27	49	78.8	606	
	1990.09-	1995.10			F	Hatchback Engine D16A8	GC051024	Outer Joint		26	23	49	78.5	55.5 M	
	1990.09-	1995.10	MT		F	Hatchback Engine D16A8	GC023020	Outer Joint		26	23	49	78.5	54.5 M	
	1990.09-	1995.10	MT		F	Hatchback Engine D16A8	GC023007	Outer Joint		26	23	49	78.8	55 I	
	1990.09-	1995.10	MT		F	Hatchback Engine D16A8	GC023008	Outer Joint	50T	26	23	49	78.8	55 I	
	1990.09-	1995.10	MT	L	F	Hatchback Engine D16A8	GDS81020	Drive Shaft	50T	26	27	49	78.8	608	
1.8 TD (65 kW)	1990.09-	1995.10	MT	R	F	Hatchback Engine D16A8	GDS23040	Drive Shaft	50T	26	27	49	78.8	606	
	1991.09-	1995.10	MT		F	Hatchback Engine XUD7TE	GC051006	Outer Joint	27T	26	32	49	78	68.5 I	
	1993.01-	1995.10	MT		F	Hatchback Engine 20T4H	GC051006	Outer Joint	27T	26	32	49	78	68.5 I	
	1991.09-	1995.10	MT		F	Hatchback Engine 20M4F	GC051006	Outer Joint	27T	26	32	49	78	68.5 I	
	<b>200 SERIES</b>														
	218-1.8 TD	1991.03-	1996.03	MT				GCI51006	Inner Joint		29	25	40	56.5	96.5
		1991.03-	1996.03	MT	L			GDS51004	Drive Shaft	27T	26	29	49	78	594
1991.03-		1996.03	MT	R			GDS50169	Drive Shaft	27T	26	29	49	78	925	
1991.03-		1996.03	MT	L			GDS51011	Drive Shaft		26	29	49	78	594	
218-1.9 Diesel	1991.03-	1996.03	MT				GCI51006	Inner Joint		29	25	40	56.5	96.5	
	1991.03-	1996.03	MT	L			GDS51004	Drive Shaft	27T	26	29	49	78	594	
	1991.03-	1996.03	MT	R			GDS50169	Drive Shaft	27T	26	29	49	78	925	
	1991.03-	1996.03	MT	L			GDS51011	Drive Shaft		26	29	49	78	594	
<b>25 (RF)</b>															
1.1 16V (55 kW)	2004.01-	2005.05	MT	L	F	Hatchback Engine 11K4F	GDS51021	Drive Shaft	43T	26	23	49	78.8	632	
1.4 16V (62 kW)	1999.10-	2005.05	MT/AT		F	Hatchback Engine 14K4M	GC023010	Outer Joint		26	22	49	78.8	55 I	
	1999.10-	2005.05	MT/AT		F	Hatchback Engine 14K4M	GC051003	Outer Joint	43T	26	22	49	78.8	55 I	
	1999.10-	2005.05	MT	L	F	Hatchback Engine 14K4M	GDS51021	Drive Shaft	43T	26	23	49	78.8	632	
1.4 16V (76 kW)	1999.10-	2005.05	MT/AT		F	Hatchback Engine 14K4F	GC023010	Outer Joint		26	22	49	78.8	55 I	
	1999.10-	2005.05	MT/AT		F	Hatchback Engine 14K4F	GC051003	Outer Joint	43T	26	22	49	78.8	55 I	
	1999.10-	2005.05	MT	L	F	Hatchback Engine 14K4F	GDS51021	Drive Shaft	43T	26	23	49	78.8	632	
	1999.10-	2005.05	MT	R	F	Hatchback Engine 14K4F	GDS51020	Drive Shaft	43T	26	23	49	78.8	903	
	1999.10-	2005.05	MT/AT		F	Hatchback Engine 16K4F	GC023010	Outer Joint		26	22	49	78.8	55 I	
1.6 16V (80 kW)	1999.10-	2005.05	MT/AT		F	Hatchback Engine 16K4F	GC051003	Outer Joint	43T	26	22	49	78.8	55 I	
	1999.10-	2005.05	AT	L	F	Hatchback Engine 16K4F	GDS51019	Drive Shaft	43T	26	23	49	78.8	630.5	
	1999.10-	2005.05	MT	L	F	Hatchback Engine 16K4F	GDS51021	Drive Shaft	43T	26	23	49	78.8	632	
	1999.10-	2005.05	AT	R	F	Hatchback Engine 16K4F	GDS51018	Drive Shaft	43T	26	23	49	78.8	887	
	1999.10-	2005.05	MT	R	F	Hatchback Engine 16K4F	GDS51020	Drive Shaft	43T	26	23	49	78.8	903	
	1999.10-	2005.05	MT/AT		F	Hatchback Engine 18K4K	GC023010	Outer Joint		26	22	49	78.8	55 I	
1.8 16V (107 kW)	2000.02-	2005.05	MT/AT		F	Hatchback Engine 18K4K	GC051003	Outer Joint	43T	26	22	49	78.8	55 I	
	2000.02-	2005.05	AT	L	F	Hatchback Engine 18K4K	GDS51019	Drive Shaft	43T	26	23	49	78.8	630.5	
	2000.02-	2005.05	AT	R	F	Hatchback Engine 18K4K	GDS51018	Drive Shaft	43T	26	23	49	78.8	887	
	1999.10-	2005.05	MT/AT		F	Hatchback Engine 18K4F	GC023010	Outer Joint		26	22	49	78.8	55 I	
1.8 16V (85 kW)	1999.10-	2005.05	MT/AT		F	Hatchback Engine 18K4F	GC051003	Outer Joint	43T	26	22	49	78.8	55 I	
	1999.10-	2005.05	AT	L	F	Hatchback Engine 18K4F	GDS51019	Drive Shaft	43T	26	23	49	78.8	630.5	
	1999.10-	2005.05	AT	R	F	Hatchback Engine 18K4F	GDS51018	Drive Shaft	43T	26	23	49	78.8	887	
	1999.10-	2005.05	MT/AT		F	Hatchback Engine 18K4F	GDS51018	Drive Shaft	43T	26	23	49	78.8	887	



		YEAR	TRANSM	L/R	F/R		G-AP Ref.	PRODUCT	ABS	Technical Specifications											
										A	B	C	H	L	P						
<b>ROVER</b>																					
<b>25 (RF)</b>																					
2.0 iDT (74 kW)	1999.10-	2005.05	5MT			F Hatchback Engine 20T2N	GC051007	Outer Joint	43T	26	32	49	78	68.5	I						
	1999.10-	2005.05	MT/AT			F Hatchback Engine 20T2N	GC051005	Outer Joint		26	32	49	78	68.5	I						
	1999.10-	2005.05	MT	L	F	Hatchback Engine 20T2N	GDS51006	Drive Shaft		26	29	49	78	563							
2.0 iDT (83 kW)	2002.01-	2004.12	MT	L	F	Hatchback Engine 20T2N	GDS51006	Drive Shaft		26	29	49	78	563							
<b>400 (XW)</b>																					
1.4 GSi/SI (66 kW)	1990.04-	1995.04				F Saloon Engine 14K4C/14K4D	GC099209	Outer Joint	27T	26	22	49	78.8	55	I						
	1990.04-	1995.04	MT	L	F	Saloon Engine 14K4C/14K4D	GDS51001	Drive Shaft		26	22	49	78.8	642							
	1990.04-	1995.04	MT	R	F	Saloon Engine 14K4C/14K4D	GDS51010	Drive Shaft		26	22	49	78.8	877							
	1990.04-	1995.04	MT	L	F	Saloon Engine 14K4C/14K4D	GDS51023	Drive Shaft	27T	26	22	49	78.8	642							
1.4 GSi/SI CAT (76 kW)	1993.01-	1995.04				F Saloon Engine 14K4F	GC099209	Outer Joint	27T	26	22	49	78.8	55	I						
	1993.01-	1995.04	MT	L	F	Saloon Engine 14K4F	GDS51001	Drive Shaft		26	22	49	78.8	642							
	1993.01-	1995.04	MT	R	F	Saloon Engine 14K4F	GDS51010	Drive Shaft		26	22	49	78.8	877							
	1993.01-	1995.04	MT	L	F	Saloon Engine 14K4F	GDS51023	Drive Shaft	27T	26	22	49	78.8	642							
1.6 GSi (82 kW)	1990.04-	1995.04	MT	L	F	Saloon Engine D16Z2	GDS23122	Drive Shaft		26	27	49	78.8	608							
	1990.04-	1995.04	MT	R	F	Saloon Engine D16Z2	GDS23078	Drive Shaft		26	27	49	78.8	606							
	1990.04-	1995.04	MT		F	Saloon Engine D16Z2	GC023020	Outer Joint		26	23	49	78.5	54.5	M						
	1990.04-	1995.04	MT		F	Saloon Engine D16Z2	GC023007	Outer Joint		26	23	49	78.8	55	I						
	1990.04-	1995.04	MT		F	Saloon Engine D16Z2	GC023008	Outer Joint	50T	26	23	49	78.8	55	I						
	1990.04-	1995.04	MT	L	F	Saloon Engine D16Z2	GDS81020	Drive Shaft	50T	26	27	49	78.8	608							
1.6 GTi (90 kW)	1990.04-	1995.04	MT	L	F	Saloon Engine D16A8	GDS23122	Drive Shaft		26	27	49	78.8	608							
	1990.04-	1995.04	MT	R	F	Saloon Engine D16A8	GDS23078	Drive Shaft		26	27	49	78.8	606							
	1990.04-	1995.04	MT		F	Saloon Engine D16A8	GC023020	Outer Joint		26	23	49	78.5	54.5	M						
	1990.04-	1995.04	MT		F	Saloon Engine D16A8	GC023007	Outer Joint		26	23	49	78.8	55	I						
	1990.04-	1995.04	MT		F	Saloon Engine D16A8	GC023008	Outer Joint	50T	26	23	49	78.8	55	I						
	1990.04-	1995.04	MT	L	F	Saloon Engine D16A8	GDS81020	Drive Shaft	50T	26	27	49	78.8	608							
	1990.04-	1995.04	MT	R	F	Saloon Engine D16A8	GDS23040	Drive Shaft	50T	26	27	49	78.8	606							
	1990.04-	1995.04	MT		F	Saloon Engine D16A8	GDS23040	Drive Shaft	50T	26	27	49	78.8	606							
1.8 TD (65 kW)	1991.09-	1995.04	MT		F	Saloon Engine XUD7TE	GC051006	Outer Joint	27T	26	32	49	78	68.5	I						
1.9 D (49 kW)	1991.09-	1995.04	MT		F	Saloon	GC051006	Outer Joint	27T	26	32	49	78	68.5	I						
2.0 GSi/SLI/GTi/Vite (100 kW)	1993.01-	1995.04	MT		F	Saloon Engine 20T4H	GC051006	Outer Joint	27T	26	32	49	78	68.5	I						
2.0 GTi/GSi/Vitesse (103 kW)	1992.02-	1995.04	MT		F	Saloon Engine 20M4F	GC051006	Outer Joint	27T	26	32	49	78	68.5	I						
<b>400 SERIES</b>																					
418-1.8 TD	1991.03-	1996.03	MT				GCI51006	Inner Joint		29	25	40	56.5	96.5							
	1991.03-	1996.03	MT	L			GDS51004	Drive Shaft	27T	26	29	49	78	594							
	1991.03-	1996.03	MT	R			GDS50169	Drive Shaft	27T	26	29	49	78	925							
	1991.03-	1996.10	MT	L			GDS51011	Drive Shaft		26	29	49	78	594							
418-1.9 Diesel	1991.01-	1995.11	MT				GCI51006	Inner Joint		29	25	40	56.5	96.5							
	1991.01-	1995.11	MT	L			GDS51004	Drive Shaft	27T	26	29	49	78	594							
	1991.01-	1995.11	MT	R			GDS50169	Drive Shaft	27T	26	29	49	78	925							
	1992.10-	1996.03	MT	L			GDS51011	Drive Shaft		26	29	49	78	594							
<b>45 (RT)</b>																					
1.4 (76 kW)	2000.02-	2005.05	5MT			F Hatchback Engine 14K4F	GC051018	Outer Joint		26	22	55	77.5	55.5	I						
	2000.02-	2005.05	5MT			F Hatchback Engine 14K4F	GC051004	Outer Joint	43T	26	22	55	77.5	55.5	I						
	2000.02-	2005.05	5MT			F Saloon Engine 14K4F	GC051018	Outer Joint		26	22	55	77.5	55.5	I						
	2000.02-	2005.05	5MT			F Saloon Engine 14K4F	GC051004	Outer Joint	43T	26	22	55	77.5	55.5	I						
	2000.02-	2005.05	MT	R	F	Hatchback Engine 14K4F	GDS51020	Drive Shaft	43T	26	23	49	78.8	903							
	2000.02-	2005.05	MT	R	F	Saloon Engine 14K4F	GDS51020	Drive Shaft	43T	26	23	49	78.8	903							
1.6 (80 kW)	2000.02-	2005.05	5MT			F Hatchback Engine 16K4F	GC051018	Outer Joint		26	22	55	77.5	55.5	I						
	2000.02-	2005.05	5MT			F Hatchback Engine 16K4F	GC051004	Outer Joint	43T	26	22	55	77.5	55.5	I						
	2000.02-	2005.05	5MT			F Saloon Engine 16K4F	GC051018	Outer Joint		26	22	55	77.5	55.5	I						
	2000.02-	2005.05	5MT			F Saloon Engine 16K4F	GC051004	Outer Joint	43T	26	22	55	77.5	55.5	I						
	2000.02-	2005.05	MT	R	F	Hatchback Engine 16K4F	GDS51020	Drive Shaft	43T	26	23	49	78.8	903							
	2000.02-	2005.05	MT	R	F	Saloon Engine 16K4F	GDS51020	Drive Shaft	43T	26	23	49	78.8	903							
1.8 (86 kW)	2000.02-	2005.05				F Hatchback Engine 18K4F	GC051018	Outer Joint		26	22	55	77.5	55.5	I						
	2000.02-	2005.05				F Hatchback Engine 18K4F	GC051004	Outer Joint	43T	26	22	55	77.5	55.5	I						
	2000.02-	2005.05				F Saloon Engine 18K4F	GC051018	Outer Joint		26	22	55	77.5	55.5	I						
	2000.02-	2005.05				F Saloon Engine 18K4F	GC051004	Outer Joint	43T	26	22	55	77.5	55.5	I						
2.0 IDT (74 kW)	2000.02-	2005.05	5MT			F Hatchback Engine 20T2N	GC051008	Outer Joint		26	32	55	78	68.5	I						
	2000.02-	2005.05	5MT			F Saloon Engine 20T2N	GC051008	Outer Joint		26	32	55	78	68.5	I						
	2000.02-	2005.05	MT			F Hatchback Engine 20T2N	GC023002	Outer Joint	43T	26	32	55	78	68.5	I						
	2000.02-	2005.05	MT			F Saloon Engine 20T2N	GC023002	Outer Joint	43T	26	32	55	78	68.5	I						





		YEAR	TRANSM	L/R	F/R		G-AP Ref.	PRODUCT	ABS	Technical Specifications										
										A	B	C	H	L	P					
<b>ROVER</b>																				
<b>45 (RT)</b>																				
2.0 V6 (110 kW)	2000.02-	2005.05	5AT		F	Hatchback Engine 20K4F	GC023002	Outer Joint	43T	26	32	55	78	68.5	I					
	2000.02-	2005.05	MT		F	Hatchback Engine 20K4F	GC051008	Outer Joint		26	32	55	78	68.5	I					
	2000.02-	2005.05	MT		F	Saloon Engine 20K4F	GC023002	Outer Joint	43T	26	32	55	78	68.5	I					
	2000.02-	2005.05	MT		F	Saloon Engine 20K4F	GC051008	Outer Joint		26	32	55	78	68.5	I					
<b>600</b>																				
618	1996.01-		MT				GCI81008	Inner Joint		27	32	40	43	78						
620	1994.06-		MT				GCI81008	Inner Joint		27	32	40	43	78						
623	1994.06-		MT				GCI81008	Inner Joint		27	32	40	43	78						
<b>600 (RH)</b>																				
1.8 i/Si (85 kW)	1996.03-	1999.02	MT/AT	L	F	Saloon Engine F18A3	GDS23038	Drive Shaft	50T	28	27	60	89	552.5						
	1996.03-	1999.02	MT/AT	R	F	Saloon Engine F18A3	GDS23039	Drive Shaft	50T	28	27	60	89	602.7						
	1996.03-	1999.02	MT/AT		F	Saloon Engine F18A3	GC051001	Outer Joint	50T	28	32	60	89	61	I					
2.0 i (85 kW)	1993.08-	1996.06	MT/AT	L	F	Saloon Engine F20Z2	GDS23038	Drive Shaft	50T	28	27	60	89	552.5						
	1993.08-	1996.06	MT/AT	R	F	Saloon Engine F20Z2	GDS23039	Drive Shaft	50T	28	27	60	89	602.7						
	1993.08-	1996.06	MT/AT		F	Saloon Engine F20Z2	GC051017	Outer Joint		28	32	60	89	61	I					
	1993.08-	1996.06	MT/AT		F	Saloon Engine F20Z2	GC051001	Outer Joint	50T	28	32	60	89	61	I					
2.0 SDi (77 kW)	1994.12-	1999.02	MT/AT		F	Saloon Engine 20T2N	GC051017	Outer Joint		28	32	60	89	61	I					
	1994.12-	1999.02	MT/AT		F	Saloon Engine 20T2N	GC051001	Outer Joint	50T	28	32	60	89	61	I					
2.0 Si (96 kW)	1993.08-	1999.02	MT/AT	L	F	Saloon Engine F20Z1	GDS23038	Drive Shaft	50T	28	27	60	89	552.5						
	1993.08-	1999.02	MT/AT	R	F	Saloon Engine F20Z1	GDS23039	Drive Shaft	50T	28	27	60	89	602.7						
	1993.08-	1999.02	MT/AT		F	Saloon Engine F20Z1	GC051017	Outer Joint		28	32	60	89	61	I					
	1993.08-	1999.02	MT/AT		F	Saloon Engine F20Z1	GC051001	Outer Joint	50T	28	32	60	89	61	I					
2.0 Ti Vitesse (147 kW)	1994.07-	1999.02			F	Saloon Engine 20T4G	GC099208	Outer Joint	45T	28	32	60	89	61	I					
	1994.07-	1999.02	MT/AT		F	Saloon Engine 20T4G	GC051001	Outer Joint	50T	28	32	60	89	61	I					
2.3 Si (116 kW)	1993.08-	1999.02	MT/AT	L	F	Saloon Engine H23A3	GDS23038	Drive Shaft	50T	28	27	60	89	552.5						
	1993.08-	1999.02	MT/AT	R	F	Saloon Engine H23A3	GDS23039	Drive Shaft	50T	28	27	60	89	602.7						
	1993.08-	1999.02	MT/AT		F	Saloon Engine H23A3	GC051017	Outer Joint		28	32	60	89	61	I					
	1993.08-	1999.02	MT/AT		F	Saloon Engine H23A3	GC051001	Outer Joint	50T	28	32	60	89	61	I					
618 i/Si (85 kW)	1996.03-	1999.02					GC099208	Outer Joint	45T	28	32	60	89	61	I					
620 i (85 kW)	1993.08-	1996.06					GC099208	Outer Joint	45T	28	32	60	89	61	I					
<b>75 (RJ)</b>																				
1.8 (88 kW)	1999.02-	2005.05			F	Saloon Engine K1.8	GC051011	Outer Joint		28	23	57.8	83.5	62	M					
	1999.02-	2005.05	AT	L	F	Saloon Engine K1.8	GDS51068	Drive Shaft		28	34	57.8	83.5	623						
1.8 T (110 kW)	2003.02-						GC099151	Outer Joint		28	24	57.8	83.5	62	M					
2.0 CDT (85 kW)	1999.02-	2005.05	MT/AT		F	Saloon Engine M47R	GC099151	Outer Joint		28	24	57.8	83.5	62	M					
2.0 CDTi (96 kW)	2003.02-						GC099151	Outer Joint		28	24	57.8	83.5	62	M					
2.0 V6 (110 kW)	1999.02-	2005.05	MT/AT		F	Saloon Engine 20K4F	GC099151	Outer Joint		28	24	57.8	83.5	62	M					
2.5 V6 (129 kW)	2001.10-						GC099151	Outer Joint		28	24	57.8	83.5	62	M					
2.5 V6 (130 kW)	2001.10-	2005.05	MT/AT		F	Saloon Engine 25K4F	GC099151	Outer Joint		28	24	57.8	83.5	62	M					
	2001.10-						GC099151	Outer Joint		28	24	57.8	83.5	62	M					
<b>75 TOURER (RJ)</b>																				
1.8 (88 kW)	2001.08-	2005.05			F	Estate Engine K1.8	GC051011	Outer Joint		28	23	57.8	83.5	62	M					
	2001.08-	2005.05	AT	L	F	Estate Engine K1.8	GDS51068	Drive Shaft		28	34	57.8	83.5	623						
2.0 CDT (85 kW)	2001.08-	2005.05	MT/AT		F	Estate Engine M47R	GC099151	Outer Joint		28	24	57.8	83.5	62	M					
2.0 V6 (110 kW)	2001.08-	2005.05	MT/AT		F	Estate Engine 20K4F	GC099151	Outer Joint		28	24	57.8	83.5	62	M					
2.5 V6 (130 kW)	2001.08-	2005.05	MT/AT		F	Estate Engine KV6	GC099151	Outer Joint		28	24	57.8	83.5	62	M					
<b>800</b>																				
2	1986.07-	1998.08	MT/AT		F		GC051015	Outer Joint		28	32	55.6	85	61	I					
2.5 Si (129 kW)	1996.04-	1999.02	MT/AT		F	Coupe Engine 25K4F	GC051002	Outer Joint	45T	28	32	55.6	85	61	I					
2.5 TD	1990.09-	1998.08	MT		F		GC051015	Outer Joint		28	32	55.6	85	61	I					
2.5 V6	1986.07-	1988.02	MT/AT		F		GC051015	Outer Joint		28	32	55.6	85	61	I					
2.7 24V (124 kW)	1992.08-	1999.02	MT/AT		F	Coupe Engine C27A1	GC051002	Outer Joint	45T	28	32	55.6	85	61	I					
2.7 V6	1988.02-	1996.03	MT		F		GC051015	Outer Joint		28	32	55.6	85	61	I					
<b>800 (XS)</b>																				
2.0 16V I/SI (103 kW)	1986.10-	1988.10	MT/AT		F	Saloon Engine 20HD	GC051002	Outer Joint	45T	28	32	55.6	85	61	I					
2.0 i/Si (100 kW)	1992.01-	1999.02	MT/AT		F	Saloon Engine 20T4H	GC051002	Outer Joint	45T	28	32	55.6	85	61	I					
	1993.01-	1999.02	MT/AT		F	Hatchback Engine 20T4H	GC051002	Outer Joint	45T	28	32	55.6	85	61	I					
2.0 i/Si (103 kW)	1988.10-	1991.12	MT/AT		F	Hatchback Engine 20HD	GC051002	Outer Joint	45T	28	32	55.6	85	61	I					
2.0 Si (98 kW)	1988.10-	1991.12	MT/AT		F	Hatchback Engine 20HDM16	GC051002	Outer Joint	45T	28	32	55.6	85	61	I					
	1988.10-	1991.12	MT/AT		F	Saloon Engine 20HDM16	GC051002	Outer Joint	45T	28	32	55.6	85	61	I					
2.5 D/SD (87 kW)	1990.01-	1999.02	MT/AT		F	Saloon Engine 4924SHIRG/425SL1RR	GC051002	Outer Joint	45T	28	32	55.6	85	61	I					



		TRANSM	L/R	F/R		G-AP Ref.	PRODUCT	ABS	Technical Specifications															
									YEAR	A	B	C	H	L	P									
<b>ROVER</b>																								
<b>800 (XS)</b>																								
2.5 Si Lux (129 kW)	1996.04-	1999.02	MT/AT		F	Saloon Engine 25K4F	GC051002	Outer Joint	45T	28	32	55.6	85	61	I									
2.5 Si/Sterling (123 kW)	1986.10-	1988.10	MT/AT		F	Saloon Engine C25A2	GC051002	Outer Joint	45T	28	32	55.6	85	61	I									
2.5 Si/Sterling (127 kW)	1987.01-	1991.12	MT/AT		F	Saloon Engine C25A2	GC051002	Outer Joint	45T	28	32	55.6	85	61	I									
2.5 Si/Sterling CAT (110 kW)	1986.10-	1991.12	MT/AT		F	Saloon Engine C25A1	GC051002	Outer Joint	45T	28	32	55.6	85	61	I									
2.7 24V I/SI CAT (124 kW)	1992.01-	1999.02	MT/AT		F	Hatchback Engine C27A1	GC051002	Outer Joint	45T	28	32	55.6	85	61	I									
2.7 Si/Sterling (130 kW)	1988.02-	1991.12	MT/AT		F	Saloon Engine C27A2	GC051002	Outer Joint	45T	28	32	55.6	85	61	I									
2.7 Si/Sterling CAT (124 kW)	1988.02-	1999.02	MT/AT		F	Saloon Engine C27A1	GC051002	Outer Joint	45T	28	32	55.6	85	61	I									
2.7 Vitesse CAT (124 kW)	1988.10-	1991.12	MT		F	Hatchback Engine C27A1	GC051002	Outer Joint	45T	28	32	55.6	85	61	I									
2.7 Vitesse/SLI (130 kW)	1988.10-	1991.12	MT		F	Hatchback Engine C27A2	GC051002	Outer Joint	45T	28	32	55.6	85	61	I									
<b>CABRIOLET (XW)</b>																								
1.4 (66 kW)	1992.01-	1999.11	MT	L	F	Convertible Engine 14K4C/14K4D	GDS51001	Drive Shaft		26	22	49	78.8	642										
	1992.01-	1999.11	MT	R	F	Convertible Engine 14K4C/14K4D	GDS51010	Drive Shaft		26	22	49	78.8	877										
	1992.01-	1999.11	MT	L	F	Convertible Engine 14K4C/14K4D	GDS51023	Drive Shaft	27T	26	22	49	78.8	642										
1.4 i 16V (76 kW)	1993.01-	1999.11	MT	L	F	Convertible Engine 14K4F	GDS51001	Drive Shaft		26	22	49	78.8	642										
	1993.01-	1999.11	MT	R	F	Convertible Engine 14K4F	GDS51010	Drive Shaft		26	22	49	78.8	877										
	1993.01-	1999.11	MT	L	F	Convertible Engine 14K4F	GDS51023	Drive Shaft	27T	26	22	49	78.8	642										
1.6 i (90 kW)	1992.01-	1999.11	AT		F	Convertible Engine D16A8	GC023020	Outer Joint		26	23	49	78.5	54.5	M									
	1992.01-	1999.11	MT		F	Convertible Engine D16A8	GC023007	Outer Joint		26	23	49	78.8	55	I									
	1992.01-	1999.11	MT		F	Convertible Engine D16A8	GC023008	Outer Joint	50T	26	23	49	78.8	55	I									
	1992.01-	1999.11	MT	L	F	Convertible Engine D16A8	GDS81020	Drive Shaft	50T	26	27	49	78.8	608										
	1992.01-	1999.11	MT	R	F	Convertible Engine D16A8	GDS23040	Drive Shaft	50T	26	27	49	78.8	606										
<b>MG ZR</b>																								
2.0 TD	2001.07-		MT	L	F		GDS51017	Drive Shaft	43T	26	29	55	77.5	559										
<b>MG ZS</b>																								
2.0 TD	2001.07-		MT	L	F		GDS51017	Drive Shaft	43T	26	29	55	77.5	559										
<b>MINI</b>																								
1.0 (30 kW)	1992.01-	1993.06	MT/AT		F	Hatchback Engine 99HD81	GC051013	Outer Joint		29	19	48	106	57	I									
1.3 (39 kW)	1992.01-	1995.04	MT/AT		F	Hatchback Engine 12A2D	GC051013	Outer Joint		29	19	48	106	57	I									
850-1100	1972.01-		MT/AT			-05.84	GC051009	Outer Joint		19	19	48	93	55	I									
<b>MONTEGO (XE)</b>																								
1.3 (50 kW)	1984.10-	1988.10	MT/AT		F	Estate Engine 12HL	GC051010	Outer Joint		25	22	50	82	56	I									
<b>STREETWISE</b>																								
1.4 (62 kW)	2003.08-	2005.05	MT	R	F	Hatchback Engine 14 K4M	GDS51020	Drive Shaft	43T	26	23	49	78.8	903										
1.4 (76 kW)	2003.08-	2005.05		R	F	Hatchback Engine 14 K4F	GDS51020	Drive Shaft	43T	26	23	49	78.8	903										
1.6 (80 kW)	2004.01-	2005.05	MT	L	F	Hatchback Engine 16 K4F	GDS51019	Drive Shaft	43T	26	23	49	78.8	630.5										
	2004.01-	2005.05	MT	R	F	Hatchback Engine 16 K4F	GDS51020	Drive Shaft	43T	26	23	49	78.8	903										
1.8 (86 kW)	2003.08-	2005.05	AT	L	F	Hatchback Engine 18K4F	GDS51019	Drive Shaft	43T	26	23	49	78.8	630.5										
	2003.08-	2005.05	AT	R	F	Hatchback Engine 18K4F	GDS51018	Drive Shaft	43T	26	23	49	78.8	887										
<b>SAAB</b>																								
<b>9-3</b>																								
1.8 i (90 kW)	2005.04-	2008.01			F	Estate Engine Z18XE	GC052012	Outer Joint		30	25	52	94.5	61	O									
	2005.04-	2008.01				Estate Engine Z18XE	GC099023	Outer Joint		30	26	53.8	94.5	65.5	M									
1.8 T (110 kW)	2005.03-					Estate Engine B207E	GC099023	Outer Joint		30	26	53.8	94.5	65.5	M									
1.9 TiD (110 kW)	2005.04-	2008.01			F	Estate Engine Z19DTH	GC052012	Outer Joint		30	25	52	94.5	61	O									
	2005.04-	2008.01	MT/AT		F	Estate Engine Z19DTH	GC017051	Outer Joint		30	26	53.8	94.5	65.5	M									
	2005.04-	2008.01	MT	L	F	Estate Engine Z19DTH	GDS21032	Drive Shaft		30	27	53.8	94.5	605										
	2005.04-	2008.01	AT	L/R	F	Estate Engine Z19DTH	GDS44080	Drive Shaft		30	27	53.8	94.5	591										
	2005.04-	2008.01	MT	L/R	F	Estate Engine Z19DTH	GCI99138	Inner Joint		27	28	35	78	83										
	2005.04-	2008.01	MT	R	F	Estate Engine Z19DTH	GDS21032	Drive Shaft		30	27	53.8	94.5	605										
1.9 TiD (88 kW)	2005.04-	2008.01			F	Estate Engine Z19DTJ	GC052012	Outer Joint		30	25	52	94.5	61	O									
	2005.04-	2008.01	MT/AT		F	Estate Engine Z19DTJ	GC017051	Outer Joint		30	26	53.8	94.5	65.5	M									
	2005.04-	2008.01	MT	L/R	F	Estate Engine Z19DTJ	GCI99138	Inner Joint		27	28	35	78	83										
	2005.04-	2008.01	MT	L/R	F	Estate Engine Z19DTJ	GDS21032	Drive Shaft		30	27	53.8	94.5	605										
	2005.04-	2008.01				Estate Engine Z19DTJ	GC099023	Outer Joint		30	26	53.8	94.5	65.5	M									
1.9 TTiD (96 kW)	2007.12-					Estate Engine A19DTR	GC099023	Outer Joint		30	26	53.8	94.5	65.5	M									
2.0 T (110 kW)	2005.04-	2008.01			F	Estate Engine B207E	GC021030	Outer Joint		30	28	55.4	96	65	M									
2.0 T (129 kW)	2005.04-	2008.01			F	Estate Engine B207L	GC021030	Outer Joint		30	28	55.4	96	65	M									
2.0 T (154 kW)	2005.04-	2008.01			F	Estate Engine B207R	GC021030	Outer Joint		30	28	55.4	96	65	M									
2.8 Turbo V6 (184 kW)	2005.04-	2008.01			F	Estate Engine LP9	GC021030	Outer Joint		30	28	55.4	96	65	M									
	2005.04-	2008.01			F	Estate Engine LP9	GC052012	Outer Joint		30	25	52	94.5	61	O									





		YEAR	TRANSM	L/R	F/R		G-AP Ref.	PRODUCT	ABS	Technical Specifications						
										A	B	C	H	L	P	
<b>SAAB</b>																
<b>9-3 (YS3D)</b>																
2.0 i (96 kW)	1998.02-	2002.09	MT/AT		F	Hatchback Engine B204I	GC052001	Outer Joint	29T	33	25	52	99	61	O	
	1998.02-	2002.09	AT	L	F	Hatchback Engine B204I	GDS52001	Drive Shaft	29T	33	34	52	92.5	594		
	1998.02-	2002.09	MT/AT	R	F	Hatchback Engine B204I	GDS52002	Drive Shaft	29T	33	37.1	52	92.5	487		
	1998.02-	2002.09		R	F	Hatchback Engine B204I	GDS18199	Drive Shaft	29T	33	34	52	92.5	932		
2.0 SE Turbo (147 kW)	1998.02-	2002.09	MT/AT		F	Hatchback Engine B204R	GC052001	Outer Joint	29T	33	25	52	99	61	O	
	1998.02-	2002.09	AT	L	F	Hatchback Engine B204R	GDS52001	Drive Shaft	29T	33	34	52	92.5	594		
	1998.02-	2002.09	MT/AT	R	F	Hatchback Engine B204R	GDS52002	Drive Shaft	29T	33	37.1	52	92.5	487		
	1998.02-	2002.09		R	F	Hatchback Engine B204R	GDS18199	Drive Shaft	29T	33	34	52	92.5	932		
2.0 Turbo (110 kW)	2001.01-	2002.09		R	F	Hatchback Engine B205E	GDS18199	Drive Shaft	29T	33	34	52	92.5	932		
2.0 Turbo (113 kW)	1998.10-	2002.09	MT/AT		F	Hatchback Engine B204E	GC052001	Outer Joint	29T	33	25	52	99	61	O	
	1998.10-	2002.09	AT	L	F	Hatchback Engine B204E	GDS52001	Drive Shaft	29T	33	34	52	92.5	594		
	1998.10-	2002.09	MT/AT	R	F	Hatchback Engine B204E	GDS52002	Drive Shaft	29T	33	37.1	52	92.5	487		
	1998.10-	2002.09		R	F	Hatchback Engine B204E	GDS18199	Drive Shaft	29T	33	34	52	92.5	932		
2.0 Turbo (136 kW)	1998.02-	2002.09	MT/AT		F	Hatchback Engine B204L/B205L	GC052001	Outer Joint	29T	33	25	52	99	61	O	
	1998.02-	2002.09	AT	L	F	Hatchback Engine B204L/B205L	GDS52001	Drive Shaft	29T	33	34	52	92.5	594		
	1998.02-	2002.09	MT/AT	R	F	Hatchback Engine B204L/B205L	GDS52002	Drive Shaft	29T	33	37.1	52	92.5	487		
	1998.02-	2002.09		R	F	Hatchback Engine B204L/B205L	GDS18199	Drive Shaft	29T	33	34	52	92.5	932		
2.0 Turbo (151 kW)	1999.10-	2002.09		R	F	Hatchback Engine B205R	GDS18199	Drive Shaft	29T	33	34	52	92.5	932		
2.2 TiD (92 kW)	2000.11-	2002.09		R	F	Hatchback Engine D223L	GDS18199	Drive Shaft	29T	33	34	52	92.5	932		
2.3 (169 kW)	1999.09-	2002.01		R	F	Hatchback Engine B235R	GDS18199	Drive Shaft	29T	33	34	52	92.5	932		
2.3 i (110 kW)	1998.02-	2002.09	MT/AT		F	Hatchback Engine B234I	GC052001	Outer Joint	29T	33	25	52	99	61	O	
	1998.02-	2002.09	AT	L	F	Hatchback Engine B234I	GDS52001	Drive Shaft	29T	33	34	52	92.5	594		
	1998.02-	2002.09	MT/AT	R	F	Hatchback Engine B234I	GDS52002	Drive Shaft	29T	33	37.1	52	92.5	487		
	1998.02-	2002.09		R	F	Hatchback Engine B234I	GDS18199	Drive Shaft	29T	33	34	52	92.5	932		
2.3 Turbo (165 kW)	1998.10-	2002.09			F	Hatchback Engine B235R	GC052008	Outer Joint	29T	33	27	59	98	65	I	
	1998.10-	2002.09		R	F	Hatchback Engine B235R	GDS18199	Drive Shaft	29T	33	34	52	92.5	932		
<b>9-3 (YS3F)</b>																
1.8 T (110 kW)	2002.09-				F	Saloon Engine B207E	GC021030	Outer Joint		30	28	55.4	96	65	M	
	2002.09-					Saloon Engine B207E	GC099023	Outer Joint		30	26	53.8	94.5	65.5	M	
	2003.08-				F	Convertible Engine B207E	GC021030	Outer Joint		30	28	55.4	96	65	M	
	2003.08-					Convertible Engine B207E	GC099023	Outer Joint		30	26	53.8	94.5	65.5	M	
1.8 i (90 kW)	2003.11-	2008.01			F	Saloon Engine Z18XE	GC052012	Outer Joint		30	25	52	94.5	61	O	
	2003.11-	2008.01				Saloon Engine Z18XE	GC099023	Outer Joint		30	26	53.8	94.5	65.5	M	
	2004.01-					Convertible Engine Z 18 XE	GC099023	Outer Joint		30	26	53.8	94.5	65.5	M	
1.9 TiD (110 kW)	2004.06-	2008.01			F	Saloon Engine Z19DTH	GC052012	Outer Joint		30	25	52	94.5	61	O	
	2004.06-	2008.01	MT/AT		F	Saloon Engine Z19DTH	GC017051	Outer Joint		30	26	53.8	94.5	65.5	M	
	2004.06-	2008.01	MT	L	F	Saloon Engine Z19DTH	GDS21032	Drive Shaft		30	27	53.8	94.5	605		
	2004.06-	2008.01	AT	L/R	F	Saloon Engine Z19DTH	GDS44080	Drive Shaft		30	27	53.8	94.5	591		
	2004.06-	2008.01	MT	L/R	F	Saloon Engine Z19DTH	GCI99138	Inner Joint		27	28	35	78	83		
	2004.06-	2008.01	MT	R	F	Saloon Engine Z19DTH	GDS21032	Drive Shaft		30	27	53.8	94.5	605		
	2004.06-	2008.01				Saloon Engine Z19DTH	GC099023	Outer Joint		30	26	53.8	94.5	65.5	M	
	2006.01-	2008.01			F	Convertible Engine Z19DTH	GC052012	Outer Joint		30	25	52	94.5	61	O	
	2006.01-	2008.01	MT/AT		F	Convertible Engine Z19DTH	GC017051	Outer Joint		30	26	53.8	94.5	65.5	M	
	2006.01-	2008.01	MT	L	F	Convertible Engine Z19DTH	GDS21032	Drive Shaft		30	27	53.8	94.5	605		
	2006.01-	2008.01	AT	L/R	F	Convertible Engine Z19DTH	GDS44080	Drive Shaft		30	27	53.8	94.5	591		
	2006.01-	2008.01	MT	L/R	F	Convertible Engine Z19DTH	GCI99138	Inner Joint		27	28	35	78	83		
	2006.01-	2008.01	MT	R	F	Convertible Engine Z19DTH	GDS21032	Drive Shaft		30	27	53.8	94.5	605		
1.9 TiD (88 kW)	2004.06-	2008.01			F	Saloon Engine Z19DT	GC052012	Outer Joint		30	25	52	94.5	61	O	
	2004.06-	2008.01	MT/AT		F	Saloon Engine Z19DT	GC017051	Outer Joint		30	26	53.8	94.5	65.5	M	
	2004.06-	2008.01	MT	L/R	F	Saloon Engine Z19DT	GCI99138	Inner Joint		27	28	35	78	83		
	2004.06-	2008.01	MT	L/R	F	Saloon Engine Z19DT	GDS21032	Drive Shaft		30	27	53.8	94.5	605		
	2004.06-	2008.01				Saloon Engine Z19DT	GC099023	Outer Joint		30	26	53.8	94.5	65.5	M	
	2004.09-					Convertible Engine Z 19 DT	GC099023	Outer Joint		30	26	53.8	94.5	65.5	M	
1.9 TTiD (96 kW)	2007.12-					Convertible Engine A19DTR	GC099023	Outer Joint		30	26	53.8	94.5	65.5	M	
	2007.12-					Saloon Engine A19DTR	GC099023	Outer Joint		30	26	53.8	94.5	65.5	M	
2.0 T (129 kW)	2002.09-				F	Saloon Engine B207L	GC021030	Outer Joint		30	28	55.4	96	65	M	
	2003.08-				F	Convertible Engine B207L	GC021030	Outer Joint		30	28	55.4	96	65	M	
2.0 T (154 kW)	2002.09-				F	Saloon Engine B207R	GC021030	Outer Joint		30	28	55.4	96	65	M	
	2003.08-				F	Convertible Engine B207R	GC021030	Outer Joint		30	28	55.4	96	65	M	
2.2 TiD (92 kW)	2002.09-				F	Saloon Engine D223L	GC021030	Outer Joint		30	28	55.4	96	65	M	
2.8 Turbo V6 (184 kW)	2005.07-	2008.01			F	Convertible Engine LP9	GC052012	Outer Joint		30	25	52	94.5	61	O	









		TRANSM	L/R	F/R		G-AP Ref.	PRODUCT	ABS	Technical Specifications						
									YEAR	A	B	C	H	L	P
<b>SAAB</b>															
<b>9-3 (YS3F)</b>															
2.8 Turbo V6 (184 kW)	2005.07-	2008.01			F	Saloon Engine LP9	GC021030	Outer Joint		30	28	55.4	96	65	M
	2005.07-	2008.01			F	Saloon Engine LP9	GC052012	Outer Joint		30	25	52	94.5	61	O
<b>9-3 CABRIOLET (YS3D)</b>															
2.0 i (96 kW)	1998.02-	2003.08	MT/AT		F	Convertible Engine B204I	GC052001	Outer Joint	29T	33	25	52	99	61	O
	1998.02-	2003.08	AT	L	F	Convertible Engine B204I	GDS52001	Drive Shaft	29T	33	34	52	92.5	594	
	1998.02-	2003.08	MT/AT	R	F	Convertible Engine B204I	GDS52002	Drive Shaft	29T	33	37.1	52	92.5	487	
	1998.02-	2003.08		R	F	Convertible Engine B204I	GDS18199	Drive Shaft	29T	33	34	52	92.5	932	
2.0 SE Turbo (147 kW)	1998.02-	2003.08	MT/AT		F	Convertible Engine B204R	GC052001	Outer Joint	29T	33	25	52	99	61	O
	1998.02-	2003.08	AT	L	F	Convertible Engine B204R	GDS52001	Drive Shaft	29T	33	34	52	92.5	594	
	1998.02-	2003.08	MT/AT	R	F	Convertible Engine B204R	GDS52002	Drive Shaft	29T	33	37.1	52	92.5	487	
	1998.02-	2003.08		R	F	Convertible Engine B204R	GDS18199	Drive Shaft	29T	33	34	52	92.5	932	
2.0 Turbo (110 kW)	2001.01-	2003.08		R	F	Convertible Engine B205E	GDS18199	Drive Shaft	29T	33	34	52	92.5	932	
2.0 Turbo (113 kW)	1998.10-	2003.08	MT/AT		F	Convertible Engine B204E	GC052001	Outer Joint	29T	33	25	52	99	61	O
	1998.10-	2003.08	AT	L	F	Convertible Engine B204E	GDS52001	Drive Shaft	29T	33	34	52	92.5	594	
	1998.10-	2003.08	MT/AT	R	F	Convertible Engine B204E	GDS52002	Drive Shaft	29T	33	37.1	52	92.5	487	
	1998.10-	2003.08		R	F	Convertible Engine B204E	GDS18199	Drive Shaft	29T	33	34	52	92.5	932	
2.0 Turbo (136 kW)	1998.02-	2003.08	MT/AT		F	Convertible Engine B204L/B205L	GC052001	Outer Joint	29T	33	25	52	99	61	O
	1998.02-	2003.08	AT	L	F	Convertible Engine B204L/B205L	GDS52001	Drive Shaft	29T	33	34	52	92.5	594	
	1998.02-	2003.08	MT/AT	R	F	Convertible Engine B204L/B205L	GDS52002	Drive Shaft	29T	33	37.1	52	92.5	487	
	1998.02-	2003.08		R	F	Convertible Engine B204L/B205L	GDS18199	Drive Shaft	29T	33	34	52	92.5	932	
2.0 Turbo (151 kW)	1999.10-	2003.08		R	F	Convertible Engine B205R	GDS18199	Drive Shaft	29T	33	34	52	92.5	932	
2.3 (169 kW)	1999.09-	2002.01			F	Convertible Engine B235R	GC052008	Outer Joint	29T	33	27	59	98	65	I
	1999.09-	2002.01			R	Convertible Engine B235R	GDS18199	Drive Shaft	29T	33	34	52	92.5	932	
2.3 i (110 kW)	1998.02-	2003.08	MT/AT		F	Convertible Engine B234I	GC052001	Outer Joint	29T	33	25	52	99	61	O
	1998.02-	2003.08	AT	L	F	Convertible Engine B234I	GDS52001	Drive Shaft	29T	33	34	52	92.5	594	
	1998.02-	2003.08	MT/AT	R	F	Convertible Engine B234I	GDS52002	Drive Shaft	29T	33	37.1	52	92.5	487	
	1998.02-	2003.08		R	F	Convertible Engine B234I	GDS18199	Drive Shaft	29T	33	34	52	92.5	932	
2.3 Turbo (165 kW)	1999.10-	2003.08			F	Convertible Engine B235R	GC052008	Outer Joint	29T	33	27	59	98	65	I
	1999.10-	2003.08			R	Convertible Engine B235R	GDS18199	Drive Shaft	29T	33	34	52	92.5	932	
<b>9-3 I (YS3D)</b>															
2.0 i (96 kW)	1998.02-	2002.08					GC052005	Outer Joint		33	25	52	99	61	O
	1998.02-	2002.08					GC052001	Outer Joint	29T	33	25	52	99	61	O
2.0 SE Turbo (147 kW)	1998.02-	2002.09		L			GCI21011	Inner Joint		34	25	35	78	64	
	1998.02-	2002.09					GC052005	Outer Joint		33	25	52	99	61	O
	1998.02-	2002.09					GC052001	Outer Joint	29T	33	25	52	99	61	O
2.0 Turbo (110 kW)	1999.10-	2002.09		L			GCI21011	Inner Joint		34	25	35	78	64	
	1999.10-	2002.09					GC052005	Outer Joint		33	25	52	99	61	O
	1999.10-	2002.09					GC052001	Outer Joint	29T	33	25	52	99	61	O
2.0 Turbo (113 kW)	1999.10-	2002.09		L			GCI21011	Inner Joint		34	25	35	78	64	
	1999.10-	2002.09					GC052005	Outer Joint		33	25	52	99	61	O
	1999.10-	2002.09					GC052001	Outer Joint	29T	33	25	52	99	61	O
2.0 Turbo (136 kW)	1999.10-	2002.09		L			GCI21011	Inner Joint		34	25	35	78	64	
	1999.10-	2002.09					GC052005	Outer Joint		33	25	52	99	61	O
	1999.10-	2002.09					GC052001	Outer Joint	29T	33	25	52	99	61	O
2.0 Turbo (147 kW)	1999.10-	2002.09		L			GCI21011	Inner Joint		34	25	35	78	64	
	1999.10-	2002.09					GC052005	Outer Joint		33	25	52	99	61	O
	1999.10-	2002.09					GC052001	Outer Joint	29T	33	25	52	99	61	O
2.2 TiD (85 kW)	1998.02-	2002.09		L			GCI21011	Inner Joint		34	25	35	78	64	
	1998.02-	2002.09					GC052005	Outer Joint		33	25	52	99	61	O
	1998.02-	2002.09					GC052001	Outer Joint	29T	33	25	52	99	61	O
2.2 TiD (92 kW)	1998.02-	2002.09		L			GCI21011	Inner Joint		34	25	35	78	64	
	1998.02-	2002.09					GC052005	Outer Joint		33	25	52	99	61	O
	1998.02-	2002.09					GC052001	Outer Joint	29T	33	25	52	99	61	O
2.3 i (108 kW)	1998.02-	2002.09		L			GCI21011	Inner Joint		34	25	35	78	64	
	1998.02-	2002.09					GC052005	Outer Joint		33	25	52	99	61	O
2.3 i (108-110 kW)	1998.02-	2002.09				GC052001	Outer Joint	29T	33	25	52	99	61	O	
2.3 i (110 kW)	1998.02-	2002.09		L			GCI21011	Inner Joint		34	25	35	78	64	
	1998.02-	2002.09					GC052005	Outer Joint		33	25	52	99	61	O
<b>9-3 II (YS3F)</b>															
1.8 i (90 kW)	2004.01-						GC052012	Outer Joint		30	25	52	94.5	61	O
1.9 TiD (110 kW)	2004.09-						GCI99138	Inner Joint		27	28	35	78	83	

		TRANSM	L/R	F/R		G-AP Ref.	PRODUCT	ABS	Technical Specifications						
									YEAR	A	B	C	H	L	P
<b>SAAB</b>															
<b>9-3 II (YS3F)</b>															
1.9 TiD (110 kW)	2004.09-					GC052012	Outer Joint		30	25	52	94.5	61	O	
1.9 TiD (88 kW)	2004.09-					GCI99138	Inner Joint		27	28	35	78	83		
	2004.09-					GC052012	Outer Joint		30	25	52	94.5	61	O	
1.9 TTiD (132 kW)	2007.12-		MT			GCI99138	Inner Joint		27	28	35	78	83		
2.8 T V6 (184 kW)	2005.03-					GC052012	Outer Joint		30	25	52	94.5	61	O	
<b>9-5 (YS3E)</b>															
1.9 TiD (110 kW)	2005.09-2008.01			F	Estate Engine Z19DTH	GC099254	Outer Joint	29T	30	27	59	94	65	M	
	2005.09-2008.01			F	Saloon Engine Z19DTH	GC099254	Outer Joint	29T	30	27	59	94	65	M	
	2005.09-2008.01			F	Estate Engine Z19DTH	GDS99200	Drive Shaft	29T	30	27	59	94	610		
	2005.09-2008.01			F	Saloon Engine Z19DTH	GDS99200	Drive Shaft	29T	30	27	59	94	610		
2.0 T (136 kW)	2000.07-2001.07			F	Estate Engine B205L	GDS52006	Drive Shaft	29T	33	27	59	92	613		
	2000.07-2001.07				Estate Engine B205L	GC099281	Outer Joint	29T	33	27	59	98	65	I	
	2000.07-				Saloon Engine B205L	GC099281	Outer Joint	29T	33	27	59	98	65	I	
2.2 TiD (88 kW)	2002.03-			F	Estate Engine D223L	GC099254	Outer Joint	29T	30	27	59	94	65	M	
	2002.03-			F	Saloon Engine D223L	GC099254	Outer Joint	29T	30	27	59	94	65	M	
	2002.03-			F	Estate Engine D223L	GDS99200	Drive Shaft	29T	30	27	59	94	610		
	2002.03-			F	Saloon Engine D223L	GDS99200	Drive Shaft	29T	30	27	59	94	610		
2.3 T (136 kW)	2001.01-			F	Estate Engine B235E	GC099254	Outer Joint	29T	30	27	59	94	65	M	
	2001.01-			F	Estate Engine B235E	GC052008	Outer Joint	29T	33	27	59	98	65	I	
	2001.01-			F	Saloon Engine B235E	GC099254	Outer Joint	29T	30	27	59	94	65	M	
	2001.01-			F	Saloon Engine B235E	GC052008	Outer Joint	29T	33	27	59	98	65	I	
	2001.01-			F	Estate Engine B235E	GDS99200	Drive Shaft	29T	30	27	59	94	610		
	2001.01-			F	Saloon Engine B235E	GDS99200	Drive Shaft	29T	30	27	59	94	610		
	2001.01-				Estate Engine B235E	GC099281	Outer Joint	29T	33	27	59	98	65	I	
2.3 Turbo (162 kW)	2003.06-2005.08			F	Estate Engine B235L	GC099254	Outer Joint	29T	30	27	59	94	65	M	
	2003.06-2005.08			F	Saloon Engine B235L	GC099254	Outer Joint	29T	30	27	59	94	65	M	
	2003.06-2005.08			F	Estate Engine B235L	GDS99200	Drive Shaft	29T	30	27	59	94	610		
	2003.06-2005.08			F	Saloon Engine B235L	GDS99200	Drive Shaft	29T	30	27	59	94	610		
2.3 Turbo (184 kW)	2001.09-		MT	L	F Estate Engine B235R	GDS62056	Drive Shaft	43T	25		54	95	640		
	2001.09-			F	Estate Engine B235R	GDS99200	Drive Shaft	29T	30	27	59	94	610		
	2001.09-			F	Saloon Engine B235R	GDS99200	Drive Shaft	29T	30	27	59	94	610		
3.0 TiD (130 kW)	2001.07-			F	Estate Engine D308L	GC099254	Outer Joint	29T	30	27	59	94	65	M	
	2001.07-			F	Saloon Engine D308L	GC099254	Outer Joint	29T	30	27	59	94	65	M	
	2001.07-			F	Estate Engine D308L	GDS99200	Drive Shaft	29T	30	27	59	94	610		
	2001.07-			F	Saloon Engine D308L	GDS99200	Drive Shaft	29T	30	27	59	94	610		
<b>9-5 (YS3G)</b>															
2.0 T BioPower (162 kW)	2010.05-				Saloon Engine A20NFT	GC099023	Outer Joint		30	26	53.8	94.5	65.5	M	
2.0 T BioPower XWD (162 kW)	2010.05-				Saloon Engine A20NHT	GC099367	Outer Joint		30	27	58.9	94	64.5	M	
2.0 TiD (118 kW)	2010.05-				Saloon Engine A20DTH	GC099023	Outer Joint		30	26	53.8	94.5	65.5	M	
2.0 TTiD (140 kW)	2010.05-				Saloon Engine A20DTR	GC099023	Outer Joint		30	26	53.8	94.5	65.5	M	
2.0 TTiD XWD (140 kW)	2010.05-				Saloon Engine A20DTR	GC099367	Outer Joint		30	27	58.9	94	64.5	M	
2.0 Turbo (162 kW)	2010.05-				Saloon Engine A20NHT	GC099023	Outer Joint		30	26	53.8	94.5	65.5	M	
2.0 Turbo XWD (162 kW)	2010.05-				Saloon Engine A20NHT	GC099367	Outer Joint		30	27	58.9	94	64.5	M	
2.8 Turbo V6 XWD (221 kW)	2010.05-				Saloon Engine A28NER	GC099367	Outer Joint		30	27	58.9	94	64.5	M	
<b>9-5 I (YS3E)</b>															
2.0 T (110 kW)	1997.09-2001.06					GC052008	Outer Joint	29T	33	27	59	98	65	I	
2.3 T (125 kW)	1997.09-2001.09					GC052008	Outer Joint	29T	33	27	59	98	65	I	
2.3 T (136 kW)	1997.09-2001.09					GC052008	Outer Joint	29T	33	27	59	98	65	I	
2.3 T (169 kW)	1997.09-2001.09					GC052008	Outer Joint	29T	33	27	59	98	65	I	
3.0 T V6 (147 kW)	1998.01-2001.06		AT			GC052008	Outer Joint	29T	33	27	59	98	65	I	
<b>900</b>															
2.0 (93 kW)	1989.01-1992.08	MT		F	Hatchback Engine B202I	GC052004	Outer Joint		25	25	56.5	86	65	O	
	1989.01-1992.08	MT		F	Hatchback Engine B202I	GC052010	Outer Joint	46T	25	25	56	86	65	O	
	1990.01-1994.06	MT		F	Convertible Engine B202I	GC052004	Outer Joint		25	25	56.5	86	65	O	
	1990.01-1994.06	MT		F	Convertible Engine B202I	GC052010	Outer Joint	46T	25	25	56	86	65	O	
2.0 c (74 kW)	1979.09-1988.12	MT		F	Hatchback Engine B20/B201XC	GC052004	Outer Joint		25	25	56.5	86	65	O	
2.0 i (81 kW)	1985.09-1990.08	MT		F	Hatchback Engine B201	GC052004	Outer Joint		25	25	56.5	86	65	O	
	1985.09-1990.08	MT		F	Hatchback Engine B201	GC052010	Outer Joint	46T	25	25	56	86	65	O	
2.0 i (85 kW)	1980.11-1988.12	MT		F	Hatchback Engine B201XI/BI20	GC052004	Outer Joint		25	25	56.5	86	65	O	
	1980.11-1988.12	MT		F	Hatchback Engine B201XI/BI20	GC052010	Outer Joint	46T	25	25	56	86	65	O	

		TRANSM	L/R	F/R		G-AP Ref.	PRODUCT	ABS	Technical Specifications								
									YEAR	A	B	C	H	L	P		
<b>SAAB</b>																	
<b>900</b>																	
2.0 S Turbo-16 (104 kW)	1991.09-1994.06	MT		F	Convertible Engine B202S	GC052010	Outer Joint	46T	25	25	56	86	65	O			
	1991.09-1993.07	MT		F	Hatchback Engine B202S	GC052010	Outer Joint	46T	25	25	56	86	65	O			
2.1 -16 (100 kW)	1990.08-1994.06	MT		F	Convertible Engine B212I	GC052004	Outer Joint		25	25	56.5	86	65	O			
	1990.08-1994.06	MT		F	Convertible Engine B212I	GC052010	Outer Joint	46T	25	25	56	86	65	O			
	1990.09-1993.07	MT		F	Hatchback Engine B212I	GC052010	Outer Joint	46T	25	25	56	86	65	O			
<b>900 (AC4, AM4)</b>																	
2.0 (93 kW)	1989.01-1993.12	MT		F	Saloon Engine B202I	GC052004	Outer Joint		25	25	56.5	86	65	O			
	1989.01-1993.12	MT		F	Saloon Engine B202I	GC052010	Outer Joint	46T	25	25	56	86	65	O			
2.0 c (74 kW)	1982.07-1988.12	MT		F	Saloon Engine B20/B201XC	GC052004	Outer Joint		25	25	56.5	86	65	O			
2.0 i (81 kW)	1985.09-1990.08	MT		F	Saloon Engine B201	GC052004	Outer Joint		25	25	56.5	86	65	O			
	1985.09-1990.08	MT		F	Saloon Engine B201	GC052010	Outer Joint	46T	25	25	56	86	65	O			
2.0 i (85 kW)	1980.11-1990.08	MT		F	Saloon Engine B120/B201XI	GC052004	Outer Joint		25	25	56.5	86	65	O			
	1980.11-1990.08	MT		F	Saloon Engine B120/B201XI	GC052010	Outer Joint	46T	25	25	56	86	65	O			
2.0 S Turbo-16 (104 kW)	1991.07-1993.12	MT		F	Saloon Engine B202S	GC052010	Outer Joint	46T	25	25	56	86	65	O			
2.0 S Turbo-16 (107 kW)	1992.01-1993.12	MT		F	Saloon Engine B202S	GC052010	Outer Joint	46T	25	25	56	86	65	O			
2.1 -16 (100 kW)	1990.08-1993.12	MT		F	Saloon Engine B212I	GC052004	Outer Joint		25	25	56.5	86	65	O			
	1990.08-1993.12	MT		F	Saloon Engine B212I	GC052010	Outer Joint	46T	25	25	56	86	65	O			
<b>900 II</b>																	
2.0 i (96 kW)	1993.12-1998.02	MT		F	Convertible Engine B204I	GCI44002	Inner Joint		34	25	35	56.2	85.6				
	1993.12-1998.02	MT		F	Convertible Engine B204I	GCI44005	Inner Joint		34	25	35	54	47				
	1994.08-1998.02	MT		F	Coupe Engine B204I	GCI44002	Inner Joint		34	25	35	56.2	85.6				
	1994.08-1998.02	MT		F	Hatchback Engine B204I	GCI44002	Inner Joint		34	25	35	56.2	85.6				
	1994.08-1998.02	MT		F	Coupe Engine B204I	GCI44005	Inner Joint		34	25	35	54	47				
	1994.08-1998.02	MT		F	Hatchback Engine B204I	GCI44005	Inner Joint		34	25	35	54	47				
2.0 i (98 kW)	1993.12-1994.07	MT		F	Coupe Engine B206I	GCI44002	Inner Joint		34	25	35	56.2	85.6				
	1993.12-1994.07	MT		F	Coupe Engine B206I	GCI44005	Inner Joint		34	25	35	54	47				
2.3 -16 (110 kW)	1993.07-1998.02	MT		F	Hatchback Engine B234I	GCI44002	Inner Joint		34	25	35	56.2	85.6				
	1993.07-1998.02	MT		F	Hatchback Engine B234I	GCI44005	Inner Joint		34	25	35	54	47				
	1993.12-1998.02	MT		F	Convertible Engine B234I	GCI44002	Inner Joint		34	25	35	56.2	85.6				
	1993.12-1998.02	MT		F	Coupe Engine B234I	GCI44002	Inner Joint		34	25	35	56.2	85.6				
	1993.12-1998.02	MT		F	Convertible Engine B234I	GCI44005	Inner Joint		34	25	35	54	47				
	1993.12-1998.02	MT		F	Coupe Engine B234I	GCI44005	Inner Joint		34	25	35	54	47				
<b>9000</b>																	
2.0 (92 kW)	1985.12-1988.12	MT/AT		F	Hatchback Engine B202XI	GC052003	Outer Joint	94T	26	25	56	84	61	O			
	1985.12-1988.12	MT/AT		F	Hatchback Engine B202XI	GC052002	Outer Joint		26	25	56	84	61	O			
2.0 (94 kW)	1985.12-1988.08	MT/AT		F	Hatchback Engine B202XI	GC052003	Outer Joint	94T	26	25	56	84	61	O			
	1985.12-1988.08	MT/AT		F	Hatchback Engine B202XI	GC052002	Outer Joint		26	25	56	84	61	O			
	1989.01-1993.01	MT/AT		F	Saloon Engine B202I	GC052003	Outer Joint	94T	26	25	56	84	61	O			
	1989.01-1993.01	MT/AT		F	Saloon Engine B202I	GC052002	Outer Joint		26	25	56	84	61	O			
	1989.01-1993.01	MT/AT		F	Saloon Engine B202I	GC099212	Outer Joint	46T	26	25	56	84	61	O			
2.0 16 Cat (92 kW)	1985-1988	MT/AT				GC052003	Outer Joint	94T	26	25	56	84	61	O			
2.0 16 Cat (94 kW)	1985-1988	MT/AT				GC052003	Outer Joint	94T	26	25	56	84	61	O			
2.0 16 T (118 kW)	1989.06-1998.12	MT/AT				GC052003	Outer Joint	94T	26	25	56	84	61	O			
2.0 16 T (127 kW)	1989.06-1998.12	MT/AT				GC052003	Outer Joint	94T	26	25	56	84	61	O			
2.0 16 T (129 kW)	1989.06-1998.12	MT/AT				GC052003	Outer Joint	94T	26	25	56	84	61	O			
2.0 CD (96 kW)	1993.09-1998.12	MT/AT		F	Saloon Engine B204I	GC052002	Outer Joint		26	25	56	84	61	O			
	1993.09-1998.12	MT/AT		F	Saloon Engine B204I	GC099212	Outer Joint	46T	26	25	56	84	61	O			
2.0 CS (94 kW)	1989.01-1998.12	MT/AT		F	Hatchback Engine B202I	GC052003	Outer Joint	94T	26	25	56	84	61	O			
	1989.01-1998.12	MT/AT		F	Hatchback Engine B202I	GC052002	Outer Joint		26	25	56	84	61	O			
	1989.01-1998.12	MT/AT		F	Hatchback Engine B202I	GC099212	Outer Joint	46T	26	25	56	84	61	O			
2.0 CS (96 kW)	1993.09-1998.12	MT/AT		F	Hatchback Engine B204I	GC052002	Outer Joint		26	25	56	84	61	O			
	1993.09-1998.12	MT/AT		F	Hatchback Engine B204I	GC099212	Outer Joint	46T	26	25	56	84	61	O			
2.0 Turbo (118 kW)	1984.09-1993.08	MT/AT		F	Hatchback Engine B202XL	GC052003	Outer Joint	94T	26	25	56	84	61	O			
	1984.09-1993.08	MT/AT		F	Hatchback Engine B202XL	GC052002	Outer Joint		26	25	56	84	61	O			
2.0 Turbo (127 kW)	1989.06-1992.12	MT/AT		F	Hatchback Engine B202	GC052003	Outer Joint	94T	26	25	56	84	61	O			
	1989.06-1992.12	MT/AT		F	Hatchback Engine B202	GC052002	Outer Joint		26	25	56	84	61	O			
2.0 Turbo (129 kW)	1984.09-1991.12	MT/AT		F	Hatchback Engine B202XL	GC052003	Outer Joint	94T	26	25	56	84	61	O			
	1984.09-1991.12	MT/AT		F	Hatchback Engine B202XL	GC052002	Outer Joint		26	25	56	84	61	O			
	1985.04-1991.12	MT/AT		F	Saloon Engine B202XL	GC052003	Outer Joint	94T	26	25	56	84	61	O			
	1985.04-1991.12	MT/AT		F	Saloon Engine B202XL	GC052002	Outer Joint		26	25	56	84	61	O			
2.3 -16 CD (107 kW)	1989.08-1998.12	MT/AT		F	Saloon Engine B234I	GC052002	Outer Joint		26	25	56	84	61	O			









		TRANSM	L/R	F/R		G-AP Ref.	PRODUCT	ABS	Technical Specifications								
									YEAR	A	B	C	H	L	P		
<b>SAAB</b>																	
<b>9000</b>																	
2.3 -16 CD (107 kW)	1989.08-	1998.12	MT/AT		F	Saloon Engine B234I	GC099212	Outer Joint	46T	26	25	56	84	61	O		
2.3 -16 CD Turbo (147 kW)	1990.07-	1998.12	MT/AT		F	Saloon Engine B234L	GC052011	Outer Joint		26	25	56	84	65	O		
	1990.07-	1998.12	MT/AT		F	Saloon Engine B234L	GC052007	Outer Joint	46T	26	25	56	84	65	O		
2.3 -16 CDE (108 kW)	1993.09-	1998.12	MT/AT		F	Saloon Engine B234I	GC052002	Outer Joint		26	25	56	84	61	O		
	1993.09-	1998.12	MT/AT		F	Saloon Engine B234I	GC099212	Outer Joint	46T	26	25	56	84	61	O		
2.3 -16 CS (107 kW)	1989.09-	1998.12	MT/AT		F	Hatchback Engine B234I	GC052002	Outer Joint		26	25	56	84	61	O		
	1989.09-	1998.12	MT/AT		F	Hatchback Engine B234I	GC099212	Outer Joint	46T	26	25	56	84	61	O		
2.3 -16 CSE (108 kW)	1993.09-	1998.12	MT/AT		F	Hatchback Engine B234I	GC052002	Outer Joint		26	25	56	84	61	O		
	1993.09-	1998.12	MT/AT		F	Hatchback Engine B234I	GC099212	Outer Joint	46T	26	25	56	84	61	O		
2.3 -16 Turbo (143 kW)	1990.09-	1993.08	MT/AT		F	Saloon Engine B234L	GC052011	Outer Joint		26	25	56	84	65	O		
	1990.09-	1998.12	MT/AT		F	Hatchback Engine B234L	GC052011	Outer Joint		26	25	56	84	65	O		
	1990.09-	1993.08	MT/AT		F	Saloon Engine B234L	GC052007	Outer Joint	46T	26	25	56	84	65	O		
	1990.09-	1998.12	MT/AT		F	Hatchback Engine B234L	GC052007	Outer Joint	46T	26	25	56	84	65	O		
2.3 -16 Turbo CSE (147 kW)	1993.09-	1998.12	MT/AT		F	Hatchback Engine B234L	GC052011	Outer Joint		26	25	56	84	65	O		
	1993.09-	1998.12	MT/AT		F	Hatchback Engine B234L	GC052007	Outer Joint	46T	26	25	56	84	65	O		
<b>SEAT</b>																	
<b>ALHAMBRA</b>																	
-	2000.06-	2010.03					GDS61193	Stub Shaft		37		60		322			
-	2000.06-	2010.03					GDS61192	Stub Shaft		26	37	60		129.5			
1.9 TDi	1996.01-		MT				GC018040	Outer Joint		38	27	60	34.5	65	I		
	1996.01-		MT	L			GDS83024	Drive Shaft	48W	38	26	60	34.5	617			
	1996.01-		MT	R			GDS83027	Drive Shaft	48W	38	35	60	34.5	561			
	1996.01-		MT	L			GDS83064	Drive Shaft		38	26	60	34.5	617			
2	1996.01-		AT				GC018040	Outer Joint		38	27	60	34.5	65	I		
	1996.01-		MT				GC018040	Outer Joint		38	27	60	34.5	65	I		
	1996.01-		MT	L			GDS83024	Drive Shaft	48W	38	26	60	34.5	617			
	1996.01-		MT	R			GDS83027	Drive Shaft	48W	38	35	60	34.5	561			
1996.01-		MT	L			GDS83064	Drive Shaft		38	26	60	34.5	617				
<b>ALHAMBRA (710)</b>																	
1.4 TSi (110 kW)	2010.06-			L	F	MPV Engine CAVA/CNWB/CTHA	GDS61188	Drive Shaft		36		59.5	40	487			
	2010.06-					MPV Engine CAVA/CNWB/CTHA	GC083095	Outer Joint		36	28	59.5	40	66	I		
1.8 TFSi (118 kW)	2012.11-		AT	L	F	MPV Engine CDAA	GDS61188	Drive Shaft		36		59.5	40	487			
	2012.11-					MPV Engine CDAA	GC083095	Outer Joint		36	28	59.5	40	66	I		
2.0 TDi (100 kW)	2010.06-	2011.05		L	F	MPV Engine CFFA	GDS61188	Drive Shaft		36		59.5	40	487			
	2010.06-	2011.05				MPV Engine CFFA	GC083095	Outer Joint		36	28	59.5	40	66	I		
2.0 TDi (103 kW)	2010.06-			L	F	MPV Engine CFFB	GDS61188	Drive Shaft		36		59.5	40	487			
	2010.06-					MPV Engine CFFB	GC083095	Outer Joint		36	28	59.5	40	66	I		
	2011.05-					MPV Engine CFFB	GC083095	Outer Joint		36	28	59.5	40	66	I		
2.0 TDi (125 kW)	2010.06-					MPV Engine CFFB	GC083095	Outer Joint		36	28	59.5	40	66	I		
2.0 TDi (130 kW)	2012.11-					MPV Engine CFGC	GC083095	Outer Joint		36	28	59.5	40	66	I		
2.0 TDi (85 kW)	2011.05-			L	F	MPV Engine CFFE	GDS61188	Drive Shaft		36		59.5	40	487			
	2011.05-					MPV Engine CFFE	GC083095	Outer Joint		36	28	59.5	40	66	I		
2.0 TSi (147 kW)	2010.11-			L	F	MPV Engine CCZA	GDS61188	Drive Shaft		36		59.5	40	487			
	2010.11-					MPV Engine CCZA	GC083095	Outer Joint		36	28	59.5	40	66	I		
<b>ALHAMBRA (7V8, 7V9)</b>																	
1.8 T 20V (110 kW)	1997.10-	2010.03	6MT			MPV Engine AJH/AWC	GDS61192	Stub Shaft		26	37	60		129.5			
	1997.10-	2010.03			F	MPV Engine AJH/AWC	GC018025	Outer Joint	48W	38	36	60	34	72.5	I		
	1997.10-	2010.03	MT/AT		F	MPV Engine AJH/AWC	GC018026	Outer Joint	48W	38	27	60	34.5	65	I		
	1997.10-	2010.03	MT/AT		F	MPV Engine AJH/AWC	GCI61044	Inner Joint			34		85				
	1997.10-	2010.03	AT	L	F	MPV Engine AJH/AWC	GDS61085	Drive Shaft	48W	38		60	34.5	513			
	1997.10-	2010.03	MT	L	F	MPV Engine AJH/AWC	GC199053	Inner Joint		26	28	40	77.5	82.5			
	1997.10-	2010.03	MT	L	F	MPV Engine AJH/AWC	GDS18009	Drive Shaft	48W	38	26	60	34.5	620			
	1997.10-	2010.03	AT	L/R	F	MPV Engine AJH/AWC	GC018039	Outer Joint		38	36	60	34	72.5	I		
	1997.10-	2010.03	AT	L/R	F	MPV Engine AJH/AWC	GDS83022	Drive Shaft	48W	38		60	34	486			
	1997.10-	2010.03	MT	L/R	F	MPV Engine AJH/AWC	GDS83023	Drive Shaft	48W	38		60	34	507			
	1997.10-	2010.03		L/R	F	MPV Engine AJH/AWC	GCI61033	Inner Joint			34		85				
	1997.10-	2010.03	AT	R	F	MPV Engine AJH/AWC	GDS61065	Drive Shaft	48W	38		60	34.5	544			
	1997.10-	2010.03	MT	R	F	MPV Engine AJH/AWC	GCI61028	Inner Joint		35	28	42	48	52			
	1997.10-	2010.03	MT	R	F	MPV Engine AJH/AWC	GDS18008	Drive Shaft	48W	38	35	60	34.5	559			
1.9 TDi (110 kW)	2005.05-	2007.05	6MT			MPV Engine ARL/BTB	GDS61192	Stub Shaft		26	37	60		129.5			
	2005.05-	2007.05	6MT			MPV Engine ARL/BTB	GDS61193	Stub Shaft		37		60		322			



	 <b>YEAR</b>	<b>TRANSM</b>	<b>L/R</b>	<b>F/R</b>		<b>G-AP Ref.</b>	<b>PRODUCT</b>	<b>ABS</b>	<b>Technical Specifications</b>					
									<b>A</b>	<b>B</b>	<b>C</b>	<b>H</b>	<b>L</b>	<b>P</b>
<b>SEAT</b> <b>ALHAMBRA (7V8, 7V9)</b>	1997.10-2000.04			L		GCI99053	Inner Joint		26	28	40	77.5	82.5	
	1997.10-2000.04			R		GCI61028	Inner Joint		35	28	42	48	52	
<b>1.8 T 20V (110 kW)</b>	2005.05-2007.05	MT		F	MPV Engine ARL/BTB	GCI61044	Inner Joint			34		85		
	2005.05-2007.05		L/R	F	MPV Engine ARL/BTB	GDS83023	Drive Shaft	48W	38		60	34	507	
<b>1.9 TDi (110 kW)</b>	1996.08-2000.04			L		GCI99053	Inner Joint		26	28	40	77.5	82.5	
	1996.08-2000.04			R		GCI61028	Inner Joint		35	28	42	48	52	
	1996.04-2010.03	6MT			MPV Engine 1Z/AHU/ANU	GDS61192	Stub Shaft		26	37	60		129.5	
	1996.04-2010.03	6MT			MPV Engine 1Z/AHU/ANU	GDS61193	Stub Shaft		37		60		322	
	1996.04-2010.03	5MT		F	MPV Engine 1Z/AHU/ANU	GC018025	Outer Joint	48W	38	36	60	34	72.5	I
	1996.04-2010.03	MT		F	MPV Engine 1Z/AHU/ANU	GCI61044	Inner Joint			34		85		
	1996.04-2010.03	MT/AT		F	MPV Engine 1Z/AHU/ANU	GC018026	Outer Joint	48W	38	27	60	34.5	65	I
	1996.04-2010.03	MT	L	F	MPV Engine 1Z/AHU/ANU	GCI99053	Inner Joint		26	28	40	77.5	82.5	
	1996.04-2010.03	MT	L	F	MPV Engine 1Z/AHU/ANU	GDS18009	Drive Shaft	48W	38	26	60	34.5	620	
	1996.04-2010.03	MT	L/R	F	MPV Engine 1Z/AHU/ANU	GDS83023	Drive Shaft	48W	38		60	34	507	
	1996.04-2010.03		L/R	F	MPV Engine 1Z/AHU/ANU	GDS61087	Drive Shaft	48W	38		60	34.5	506	
	1996.04-2010.03		L/R	F	MPV Engine 1Z/AHU/ANU	GCI61032	Inner Joint			27		34		
	1996.04-2010.03		L/R	F	MPV Engine 1Z/AHU/ANU	GC061022	Outer Joint		38	27	60	34.5	65	M
	1996.04-2010.03	MT	R	F	MPV Engine 1Z/AHU/ANU	GCI61028	Inner Joint		35	28	42	48	52	
	1996.04-2010.03	MT	R	F	MPV Engine 1Z/AHU/ANU	GDS18008	Drive Shaft	48W	38	35	60	34.5	559	
	<b>1.9 TDi (81 kW)</b>	1996.08-2000.04			L		GCI99053	Inner Joint		26	28	40	77.5	82.5
1996.08-2000.04				R		GCI61028	Inner Joint		35	28	42	48	52	
1996.08-2000.06		6MT			MPV Engine AFN/AVG	GDS61192	Stub Shaft		26	37	60		129.5	
1996.08-2000.06		6MT			MPV Engine AFN/AVG	GDS61193	Stub Shaft		37		60		322	
<b>1.9 TDi (85 kW)</b>	2000.06-2010.03	6MT			MPV Engine AUY/BVK	GDS61192	Stub Shaft		26	37	60		129.5	
	2000.06-2010.03	6MT			MPV Engine AUY/BVK	GDS61193	Stub Shaft		37		60		322	
	2000.06-2010.03	6MT		F	MPV Engine AUY/BVK	GC018025	Outer Joint	48W	38	36	60	34	72.5	I
	2000.06-2010.03	MT/AT		F	MPV Engine AUY/BVK	GCI61044	Inner Joint			34		85		
	2000.06-2010.03	5AT	L/R	F	MPV Engine AUY/BVK	GC018039	Outer Joint		38	36	60	34	72.5	I
	2000.06-2010.03	5AT	L/R	F	MPV Engine AUY/BVK	GDS83022	Drive Shaft	48W	38		60	34	486	
	2000.06-2010.03	MT	L/R	F	MPV Engine AUY/BVK	GDS61087	Drive Shaft	48W	38		60	34.5	506	
	2000.06-2010.03	MT	L/R	F	MPV Engine AUY/BVK	GCI61032	Inner Joint			27		34		
	2000.06-2010.03	MT	L/R	F	MPV Engine AUY/BVK	GC061022	Outer Joint		38	27	60	34.5	65	M
	2000.06-2010.03	MT	L/R	F	MPV Engine AUY/BVK	GDS83023	Drive Shaft	48W	38		60	34	507	
<b>1.9 TDi (96 kW)</b>	2002.11-2008.11	6MT			MPV Engine ASZ	GDS61192	Stub Shaft		26	37	60		129.5	
	2002.11-2008.11	6MT			MPV Engine ASZ	GDS61193	Stub Shaft		37		60		322	
	2002.11-2008.11			F	MPV Engine ASZ	GC018025	Outer Joint	48W	38	36	60	34	72.5	I
	2002.11-2008.11	MT/AT		F	MPV Engine ASZ	GCI61044	Inner Joint			34		85		
	2002.11-2008.11	MT	L/R	F	MPV Engine ASZ	GDS83023	Drive Shaft	48W	38		60	34	507	
<b>1.9 TDi 4motion (85 kW)</b>	2000.06-2010.03	6MT			MPV Engine AUY/BVK	GC018025	Outer Joint	48W	38	36	60	34	72.5	I
	2000.06-2010.03	MT/AT		F	MPV Engine AUY/BVK	GCI61044	Inner Joint			34		85		
	2000.06-2010.03	MT	L/R	F	MPV Engine AUY/BVK	GDS83023	Drive Shaft	48W	38		60	34	507	
<b>1.9 TDi 4x4 (96 kW)</b>	2005.06-2008.11				MPV Engine ASZ	GC018025	Outer Joint	48W	38	36	60	34	72.5	I
<b>2.0 i (85 kW)</b>	1996.08-2000.04			L		GCI99053	Inner Joint		26	28	40	77.5	82.5	
	1996.08-2000.04			R		GCI61028	Inner Joint		35	28	42	48	52	
	1996.04-2010.03	MT	L	F	MPV Engine ADY/ATM	GCI99053	Inner Joint		26	28	40	77.5	82.5	
	1996.04-2010.03	MT	L	F	MPV Engine ADY/ATM	GDS18009	Drive Shaft	48W	38	26	60	34.5	620	
	1996.04-2010.03	MT	L/R	F	MPV Engine ADY/ATM	GDS61087	Drive Shaft	48W	38		60	34.5	506	
	1996.04-2010.03	MT	L/R	F	MPV Engine ADY/ATM	GCI61032	Inner Joint			27		34		
	1996.04-2010.03	MT	L/R	F	MPV Engine ADY/ATM	GC061022	Outer Joint		38	27	60	34.5	65	M
	1996.04-2010.03	MT	L/R	F	MPV Engine ADY/ATM	GDS83023	Drive Shaft	48W	38		60	34	507	
	1996.04-2010.03		L/R	F	MPV Engine ADY/ATM	GCI61033	Inner Joint			34		85		
	1996.04-2010.03	AT	R	F	MPV Engine ADY/ATM	GDS61104	Drive Shaft	48W	38		60	34	544	
	1996.04-2010.03	AT	R	F	MPV Engine ADY/ATM	GCI50019	Inner Joint			34		59.5		
	1996.04-2010.03	AT	R	F	MPV Engine ADY/ATM	GC018025	Outer Joint	48W	38	36	60	34	72.5	I
	1996.04-2010.03	AT	R	F	MPV Engine ADY/ATM	GDS61065	Drive Shaft	48W	38		60	34.5	544	
	1996.04-2010.03	MT	R	F	MPV Engine ADY/ATM	GDS83065	Drive Shaft		38	35	60	34.5	561	
	1996.04-2010.03	MT	R	F	MPV Engine ADY/ATM	GCI61028	Inner Joint		35	28	42	48	52	
	1996.04-2010.03	MT	R	F	MPV Engine ADY/ATM	GDS18008	Drive Shaft	48W	38	35	60	34.5	559	
	1996.04-2010.03	6MT			MPV Engine ADY/ATM	GDS61192	Stub Shaft		26	37	60		129.5	
	1996.04-2010.03	6MT			MPV Engine ADY/ATM	GDS61193	Stub Shaft		37		60		322	
	1996.04-2010.03	MT/AT		F	MPV Engine ADY/ATM	GC018025	Outer Joint	48W	38	36	60	34	72.5	I

SEAT ALHAMBRA (7V8, 7V9)	YEAR	TRANSM	L/R	F/R	G-AP Ref.	PRODUCT	ABS	Technical Specifications						
								A	B	C	H	L	P	
2.0 i (85 kW)	1996.04-2010.03	MT/AT		F	MPV Engine ADY/ATM	GC018026	Outer Joint	48W	38	27	60	34.5	65	I
	1996.04-2010.03	MT/AT		F	MPV Engine ADY/ATM	GCI61044	Inner Joint			34		85		
	1996.04-2010.03	AT	L	F	MPV Engine ADY/ATM	GDS61085	Drive Shaft	48W	38		60	34.5	513	
2.0 TDi (103 kW)	2005.11-2010.03			F	MPV Engine BRT	GC018025	Outer Joint	48W	38	36	60	34	72.5	I
	2005.11-2010.03	MT/AT		F	MPV Engine BRT	GCI61044	Inner Joint			34		85		
	2005.11-2010.03		L/R	F	MPV Engine BRT	GDS83023	Drive Shaft	48W	38		60	34	507	
	2005.11-2010.03	6MT			MPV Engine BRT	GDS61192	Stub Shaft		26	37	60		129.5	
	2005.11-2010.03	6MT			MPV Engine BRT	GDS61193	Stub Shaft		37		60		322	
2.8 V6 (150 kW)	2000.06-2010.03	6MT		F	MPV Engine AUE/AYL	GC018025	Outer Joint	48W	38	36	60	34	72.5	I
	2000.06-2010.03	MT/AT		F	MPV Engine AUE/AYL	GCI61044	Inner Joint			34		85		
	2000.06-2010.03	5AT	L	F	MPV Engine AUE/AYL	GC018039	Outer Joint		38	36	60	34	72.5	I
	2000.06-2010.03	5AT	L	F	MPV Engine AUE/AYL	GDS83022	Drive Shaft	48W	38		60	34	486	
	2000.06-2010.03	MT	L/R	F	MPV Engine AUE/AYL	GDS83023	Drive Shaft	48W	38		60	34	507	
	2000.06-2010.03	5AT	R	F	MPV Engine AUE/AYL	GDS99120	Drive Shaft	48W	38	30	60	34	561	
	2000.06-2010.03	6MT			MPV Engine AUE/AYL	GDS61192	Stub Shaft		26	37	60		129.5	
	2000.06-2010.03	6MT			MPV Engine AUE/AYL	GDS61193	Stub Shaft		37		60		322	
2.8 V6 4motion (150 kW)	2000.06-2010.03	6MT			MPV Engine AUE/AYL	GC018025	Outer Joint	48W	38	36	60	34	72.5	I
	2000.06-2010.03	MT/AT		F	MPV Engine AUE/AYL	GCI61044	Inner Joint			34		85		
	2000.06-2010.03	MT	L/R	F	MPV Engine AUE/AYL	GDS83023	Drive Shaft	48W	38		60	34	507	
<b>ALTEA (5P1)</b>														
1.2 TSi (77 kW)	2010.04-			F	MPV Engine CBZB	GCI83011	Inner Joint			33		34		
	2010.04-		MT	F	MPV Engine CBZB	GCI53002	Inner Joint			33		34		
	2010.04-		MT	L	F	MPV Engine CBZB	GDS61198	Drive Shaft	36		59.5	40.5	530	
	2010.04-					GC083037	Outer Joint	36	30	59.5	40.5	55	I	
1.4 (63 kW)	2007-					GC053001	Outer Joint	36	30	59.5	40	49	I	
1.4 16V (63 kW)	2006.05-			F	MPV Engine BXW/CGGB	GC053001	Outer Joint	36	30	59.5	40	49	I	
	2006.05-			F	MPV Engine BXW/CGGB	GCI83008	Inner Joint			33		32		
	2006.05-		L	F	MPV Engine BXW/CGGB	GDS53007	Drive Shaft	36		59.5	40	559		
1.4 TSi (92 kW)	2007.11-			F	MPV Engine CAXC	GCI83011	Inner Joint			33		34		
	2007.11-			F	MPV Engine CAXC	GC083037	Outer Joint	36	30	59.5	40.5	55	I	
	2007.11-		MT	F	MPV Engine CAXC	GCI53002	Inner Joint			33		34		
	2007.11-		MT	L	F	MPV Engine CAXC	GDS61198	Drive Shaft	36		59.5	40.5	530	
	2007.11-					GC083037	Outer Joint	36	30	59.5	40.5	55	I	
1.6 (75 kW)	2004.03-		MT			GC083037	Outer Joint	36	30	59.5	40.5	55	I	
	2004.05-2007.07			F	MPV Engine CMXA/CCSA/BSF/BSE/BGU	GC083037	Outer Joint	36	30	59.5	40.5	55	I	
	2004.05-2007.07		MT	F	MPV Engine CMXA/CCSA/BSF/BSE/BGU	GCI83011	Inner Joint			33		34		
	2004.05-2007.07	5MT	L	F	MPV Engine CMXA/CCSA/BSF/BSE/BGU	GDS83320	Drive Shaft	36		59.5	40	546		
1.6 LPG (75 kW)	2009.09-			F	MPV Engine CHGA	GCI83011	Inner Joint			33		34		
	2009.09-			F	MPV Engine CHGA	GC083037	Outer Joint	36	30	59.5	40.5	55	I	
	2009.09-		L	F	MPV Engine CHGA	GDS83320	Drive Shaft	36		59.5	40	546		
	2009.09-		MT			GC083037	Outer Joint	36	30	59.5	40.5	55	I	
1.6 TDi (66 kW)	2009.10-		MT			GC083037	Outer Joint	36	30	59.5	40.5	55	I	
	2009.10-				Double Clutch	GC083002	Outer Joint	36	27	59.5	40	66	I	
	2010.11-			F	MPV Engine CAYB	GCI83011	Inner Joint			33		34		
	2010.11-		MT	F	MPV Engine CAYB	GCI53002	Inner Joint			33		34		
	2010.11-		MT	F	MPV Engine CAYB	GC083037	Outer Joint	36	30	59.5	40.5	55	I	
	2010.11-		L	F	MPV Engine CAYB	GDS83294	Drive Shaft	36		59.5	38	519		
	2010.11-		R	F	MPV Engine CAYB	GDS61042	Drive Shaft	36		59.5	40.5	814		
	2010.11-		MT	L	F	MPV Engine CAYB	GDS61089	Drive Shaft	36		59.5	40.5	521	
1.6 TDi (77 kW)	2009.10-			F	MPV Engine CAYC	GCI83011	Inner Joint			33		34		
	2009.10-		7AT	F	MPV Engine CAYC	GC083002	Outer Joint	36	27	59.5	40	66	I	
	2009.10-		MT	F	MPV Engine CAYC	GCI53002	Inner Joint			33		34		
	2009.10-		MT	F	MPV Engine CAYC	GC083037	Outer Joint	36	30	59.5	40.5	55	I	
	2009.10-	5MT	L	F	MPV Engine CAYC	GDS83294	Drive Shaft	36		59.5	38	519		
	2009.10-	5MT	R	F	MPV Engine CAYC	GDS61042	Drive Shaft	36		59.5	40.5	814		
	2009.10-		MT	L	F	MPV Engine CAYC	GDS61089	Drive Shaft	36		59.5	40.5	521	
	2009.10-		MT			GC083037	Outer Joint	36	30	59.5	40.5	55	I	
	2009.10-				Double Clutch	GC083002	Outer Joint	36	27	59.5	40	66	I	
1.8 TFSi (118 kW)	2007.01-			F	MPV Engine BYT/BZB/CDA	GC083002	Outer Joint	36	27	59.5	40	66	I	
	2007.01-		MT	L	F	MPV Engine BYT/BZB/CDA	GDS61131	Drive Shaft	36		59.5	40	515	









		TRANSM	L/R	F/R		G-AP Ref.	PRODUCT	ABS	Technical Specifications						
									YEAR	A	B	C	H	L	P
<b>SEAT</b> <b>ALTEA (5P1)</b> 1.8 TFSi (118 kW)	2007.01-		MT		F	MPV Engine BYT/BZB/CDA	GC083100	Outer Joint	36	33	59.5	38	55	I	
	2007.01-					MPV Engine BYT/BZB/CDA	GC061059	Outer Joint	36	33	59.5	40	59.5	I	
	2007.01-						GCI83016	Inner Joint		28		32			
	2007.01-						GC083002	Outer Joint	36	27	59.5	40	66	I	
1.9 TDi (66 kW)	2009.08-			L	F	MPV Engine BXF	GDS83294	Drive Shaft	36		59.5	38	519		
	2009.08-				R	F	MPV Engine BXF	GDS61042	Drive Shaft	36		59.5	40.5	814	
	2009.08-		AT	L	F	MPV Engine BXF	GDS83241	Drive Shaft	36		59.5	40	475		
	2009.08-		MT	L	F	MPV Engine BXF	GDS61089	Drive Shaft	36		59.5	40.5	521		
	2009.08-		MT				GC083037	Outer Joint	36	30	59.5	40.5	55	I	
1.9 TDi (77 kW)	2004.04-		AT			Engine BKC	GC083002	Outer Joint	36	27	59.5	40	66	I	
	2004.04-		MT			Engine BKC	GC083037	Outer Joint	36	30	59.5	40.5	55	I	
	2004.05-2007.07				F	MPV Engine BJB/BKC/BLS/BXE	GC083037	Outer Joint	36	30	59.5	40.5	55	I	
	2004.05-2007.07	6AT			F	MPV Engine BJB/BKC/BLS/BXE	GCI54004	Inner Joint		34		85			
	2004.05-2007.07	6AT			F	MPV Engine BJB/BKC/BLS/BXE	GC061045	Outer Joint	36	27	59.5	40	65	M	
	2004.05-2007.07	6AT			F	MPV Engine BJB/BKC/BLS/BXE	GC083002	Outer Joint	36	27	59.5	40	66	I	
	2004.05-2007.07	MT			F	MPV Engine BJB/BKC/BLS/BXE	GCI83011	Inner Joint		33		34			
	2004.05-2007.07	5MT	L	F	F	MPV Engine BJB/BKC/BLS/BXE	GDS83294	Drive Shaft	36		59.5	38	519		
	2004.05-2007.07	6AT	L	F	F	MPV Engine BJB/BKC/BLS/BXE	GDS54013	Drive Shaft	36		59.5	40	479.5		
	2004.05-2007.07	MT	L	F	F	MPV Engine BJB/BKC/BLS/BXE	GDS83241	Drive Shaft	36		59.5	40	475		
	2004.05-2007.07	MT	L	F	F	MPV Engine BJB/BKC/BLS/BXE	GDS61089	Drive Shaft	36		59.5	40.5	521		
	2004.05-2007.07	MT	L	F	F	MPV Engine BJB/BKC/BLS/BXE	GDS83294	Drive Shaft	36		59.5	38	519		
	2004.05-2007.07	AT	L/R	F	F	MPV Engine BJB/BKC/BLS/BXE	GCI61057	Inner Joint		34		86			
	2004.05-2007.07	5MT	R	F	F	MPV Engine BJB/BKC/BLS/BXE	GDS61042	Drive Shaft	36		59.5	40.5	814		
	2004.05-2007.07	6AT	R	F	F	MPV Engine BJB/BKC/BLS/BXE	GDS54011	Drive Shaft	36		59.5	40	755		
	2004.05-2007.07	AT	R	F	F	MPV Engine BJB/BKC/BLS/BXE	GDS83355	Drive Shaft	36	23	59.5	40	799		
	2.0 FSi (110 kW)	2004.05-2007.07				F	MPV Engine BLR/BLY/BVY/BVZ	GC083037	Outer Joint	36	30	59.5	40.5	55	I
		2004.05-2007.07	6AT			F	MPV Engine BLR/BLY/BVY/BVZ	GCI61011	Inner Joint	26	32	31	68.5	85	
		2004.05-2007.07	MT			F	MPV Engine BLR/BLY/BVY/BVZ	GCI83011	Inner Joint		33		34		
2004.05-2007.07		6AT	L	F	F	MPV Engine BLR/BLY/BVY/BVZ	GDS61093	Drive Shaft	36	26	59.5	40.5	587.5		
2004.05-2007.07		MT	L	F	F	MPV Engine BLR/BLY/BVY/BVZ	GDS61089	Drive Shaft	36		59.5	40.5	521		
2004.05-2007.07		6AT	R	F	F	MPV Engine BLR/BLY/BVY/BVZ	GDS61094	Drive Shaft	36	26	59.5	40.5	884		
2004.05-2007.07		6MT	R	F	F	MPV Engine BLR/BLY/BVY/BVZ	GDS61113	Drive Shaft	36		59.5	40	814		
2004.10-			AT				GC083037	Outer Joint	36	30	59.5	40.5	55	I	
2.0 TDi (100 kW)	2004.03-2009.05				F	MPV Engine AZV	GC083002	Outer Joint	36	27	59.5	40	66	I	
	2004.03-2009.05	6AT			F	MPV Engine AZV	GCI54004	Inner Joint		34		85			
	2004.03-2009.05	AT	L	F	F	MPV Engine AZV	GDS83241	Drive Shaft	36		59.5	40	475		
	2004.03-2009.05	AT	L	F	F	MPV Engine AZV	GDS54013	Drive Shaft	36		59.5	40	479.5		
	2004.03-2009.05	MT	L	F	F	MPV Engine AZV	GDS83236	Drive Shaft	36		59.5	40	484		
	2004.03-2009.05	MT	L	F	F	MPV Engine AZV	GDS83295	Drive Shaft	36		59.5	40	491		
	2004.03-2009.05	AT	L/R	F	F	MPV Engine AZV	GCI61057	Inner Joint		34		86			
	2004.03-2009.05	AT	R	F	F	MPV Engine AZV	GDS83355	Drive Shaft	36	23	59.5	40	799		
	2004.03-2009.05	AT	R	F	F	MPV Engine AZV	GDS54011	Drive Shaft	36		59.5	40	755		
	2004.03-2009.05	MT	R	F	F	MPV Engine AZV	GDS61126	Drive Shaft	36		59.5	40	793		
	2004.03-2009.05	MT	R	F	F	MPV Engine AZV	GDS83313	Drive Shaft	36		59.5	40	792		
	2004.04-						GCI83016	Inner Joint		28		32			
	2004.04-						GC083002	Outer Joint	36	27	59.5	40	66	I	
2.0 TDi (103 kW)	2004.04-						GCI83016	Inner Joint		28		32			
	2004.04-						GC083002	Outer Joint	36	27	59.5	40	66	I	
	2005.11-	6AT			F	MPV Engine BMM	GCI54004	Inner Joint		34		85			
	2005.11-	MT			F	MPV Engine BMM	GC083002	Outer Joint	36	27	59.5	40	66	I	
	2005.11-	AT	L	F	F	MPV Engine BMM	GDS54013	Drive Shaft	36		59.5	40	479.5		
	2005.11-	MT	L	F	F	MPV Engine BMM	GDS83295	Drive Shaft	36		59.5	40	491		
	2005.11-	AT	R	F	F	MPV Engine BMM	GDS54011	Drive Shaft	36		59.5	40	755		
	2005.11-	MT	R	F	F	MPV Engine BMM	GDS83313	Drive Shaft	36		59.5	40	792		
	2005.11-	AT	L	F	F	MPV Engine BMM	GDS83241	Drive Shaft	36		59.5	40	475		
	2005.11-	MT	L	F	F	MPV Engine BMM	GDS83236	Drive Shaft	36		59.5	40	484		
	2005.11-	AT	L/R	F	F	MPV Engine BMM	GCI61057	Inner Joint		34		86			
	2005.11-	AT	R	F	F	MPV Engine BMM	GDS83355	Drive Shaft	36	23	59.5	40	799		
	2005.11-	MT	R	F	F	MPV Engine BMM	GDS61126	Drive Shaft	36		59.5	40	793		
2.0 TDi (125 kW)	2004.04-						GCI83016	Inner Joint		28		32			
	2004.04-						GC083002	Outer Joint	36	27	59.5	40	66	I	



		YEAR	TRANSM	L/R	F/R		G-AP Ref.	PRODUCT	ABS	Technical Specifications						
										A	B	C	H	L	P	
<b>SEAT</b>																
<b>ALTEA (5P1)</b>																
2.0 TDi (125 kW)	2005.11-	2007.07			F	MPV Engine BMN/CEGA	GC061045	Outer Joint		36	27	59.5	40	65	M	
	2005.11-	2007.07	MT		F	MPV Engine BMN/CEGA	GCI153002	Inner Joint			33		34			
	2005.11-	2007.07	MT		F	MPV Engine BMN/CEGA	GC083002	Outer Joint		36	27	59.5	40	66	I	
	2005.11-	2007.07		L	F	MPV Engine BMN/CEGA	GDS83265	Drive Shaft		36		59.5	40	487		
	2005.11-	2007.07	MT	L	F	MPV Engine BMN/CEGA	GDS83236	Drive Shaft		36		59.5	40	484		
	2005.11-	2007.07		L	F	MPV Engine BMN/CEGA	GCI83016	Inner Joint			28		32			
	2005.11-	2007.07		R	F	MPV Engine BMN/CEGA	GDS83313	Drive Shaft		36		59.5	40	792		
	2005.11-	2007.07	MT	R	F	MPV Engine BMN/CEGA	GDS61126	Drive Shaft		36		59.5	40	793		
2.0 TDi 16V (103 kW)	2004.05-	2007.07			F	MPV Engine BKD/CFHC	GC083002	Outer Joint		36	27	59.5	40	66	I	
	2004.05-	2007.07	6AT		F	MPV Engine BKD/CFHC	GCI154004	Inner Joint			34		85			
	2004.05-	2007.07	AT	L	F	MPV Engine BKD/CFHC	GDS83241	Drive Shaft		36		59.5	40	475		
	2004.05-	2007.07	AT	L	F	MPV Engine BKD/CFHC	GDS54013	Drive Shaft		36		59.5	40	479.5		
	2004.05-	2007.07	MT	L	F	MPV Engine BKD/CFHC	GDS83236	Drive Shaft		36		59.5	40	484		
	2004.05-	2007.07	MT	L	F	MPV Engine BKD/CFHC	GCI83016	Inner Joint			28		32			
	2004.05-	2007.07	MT	L	F	MPV Engine BKD/CFHC	GDS83265	Drive Shaft		36		59.5	40	487		
	2004.05-	2007.07	MT	L	F	MPV Engine BKD/CFHC	GDS83295	Drive Shaft		36		59.5	40	491		
	2004.05-	2007.07	AT	L/R	F	MPV Engine BKD/CFHC	GCI61057	Inner Joint			34		86			
	2004.05-	2007.07	AT	R	F	MPV Engine BKD/CFHC	GDS83355	Drive Shaft		36	23	59.5	40	799		
	2004.05-	2007.07	AT	R	F	MPV Engine BKD/CFHC	GDS54011	Drive Shaft		36		59.5	40	755		
	2004.05-	2007.07	MT	R	F	MPV Engine BKD/CFHC	GDS61126	Drive Shaft		36		59.5	40	793		
	2004.05-	2007.07	MT	R	F	MPV Engine BKD/CFHC	GDS83313	Drive Shaft		36		59.5	40	792		
2.0 TFSi (147 kW)	2006.04-	2009.05	MT		F	MPV Engine BWA	GC083002	Outer Joint		36	27	59.5	40	66	I	
	2006.04-	2009.05	MT		F	MPV Engine BWA	GCI153002	Inner Joint			33		34			
	2006.04-	2009.05	AT	R	F	MPV Engine BWA	GDS83349	Drive Shaft		36		59.5	40	784		
2.0 TFSi 4WD (147 kW)	2005-						GC083002	Outer Joint		36	27	59.5	40	66	I	
	2006.03-	2009.05					GCI83016	Inner Joint			28		32			
2.0 TFSi 4WD (155 kW)	2009-					GC053001	Outer Joint		36	30	59.5	40	49	I		
<b>ALTEA XL (5P5, 5P8)</b>																
1.2 TSi (77 kW)	2010.04-				F	MPV Engine CBZB	GCI83011	Inner Joint			33		34			
	2010.04-		MT		F	MPV Engine CBZB	GCI153002	Inner Joint			33		34			
	2010.04-		MT	L	F	MPV Engine CBZB	GDS61198	Drive Shaft		36		59.5	40.5	530		
	2010.04-						GC083037	Outer Joint		36	30	59.5	40.5	55	I	
1.4 16V (63 kW)	2006.10-				F	MPV Engine BXW/CGGB	GC053001	Outer Joint		36	30	59.5	40	49	I	
	2006.10-				F	MPV Engine BXW/CGGB	GCI83008	Inner Joint			33		32			
	2006.10-			L	F	MPV Engine BXW/CGGB	GDS53007	Drive Shaft		36		59.5	40	559		
	2006.10-						GC053001	Outer Joint		36	30	59.5	40	49	I	
1.4 TSi (92 kW)	2007.11-				F	MPV Engine CAXC	GCI83011	Inner Joint			33		34			
	2007.11-				F	MPV Engine CAXC	GC083037	Outer Joint		36	30	59.5	40.5	55	I	
	2007.11-		MT		F	MPV Engine CAXC	GCI153002	Inner Joint			33		34			
	2007.11-		MT	L	F	MPV Engine CAXC	GDS61198	Drive Shaft		36		59.5	40.5	530		
	2007.11-						GC083037	Outer Joint		36	30	59.5	40.5	55	I	
1.6 (75 kW)	2006.10-				F	MPV Engine BSE/BSF/CCSA/CMXA	GC083037	Outer Joint		36	30	59.5	40.5	55	I	
	2006.10-		MT		F	MPV Engine BSE/BSF/CCSA/CMXA	GCI83011	Inner Joint			33		34			
	2006.10-		5MT	L	F	MPV Engine BSE/BSF/CCSA/CMXA	GDS83320	Drive Shaft		36		59.5	40	546		
	2006.10-		MT				GC083037	Outer Joint		36	30	59.5	40.5	55	I	
1.6 LPG (75 kW)	2009.09-				F	MPV Engine CHGA	GCI83011	Inner Joint			33		34			
	2009.09-				F	MPV Engine CHGA	GC083037	Outer Joint		36	30	59.5	40.5	55	I	
	2009.09-			L	F	MPV Engine CHGA	GDS83320	Drive Shaft		36		59.5	40	546		
	2009.09-		MT				GC083037	Outer Joint		36	30	59.5	40.5	55	I	
1.6 TDi (66 kW)	2009.10-		MT				GC083037	Outer Joint		36	30	59.5	40.5	55	I	
	2009.10-					DOUBLE CLUTCH	GCI83016	Inner Joint			28		32			
	2009.10-					Double Clutch	GC083002	Outer Joint		36	27	59.5	40	66	I	
	2010.11-				F	MPV Engine CAYB	GCI83011	Inner Joint			33		34			
	2010.11-		MT		F	MPV Engine CAYB	GCI153002	Inner Joint			33		34			
	2010.11-		MT		F	MPV Engine CAYB	GC083037	Outer Joint		36	30	59.5	40.5	55	I	
	2010.11-			L	F	MPV Engine CAYB	GDS83294	Drive Shaft		36		59.5	38	519		
	2010.11-			R	F	MPV Engine CAYB	GDS61042	Drive Shaft		36		59.5	40.5	814		
1.6 TDi (77 kW)	2009.10-				F	MPV Engine CAYC	GCI83011	Inner Joint			33		34			
	2009.10-		7AT		F	MPV Engine CAYC	GC083002	Outer Joint		36	27	59.5	40	66	I	
	2009.10-		MT		F	MPV Engine CAYC	GCI153002	Inner Joint			33		34			
	2009.10-															

		TRANSM	L/R	F/R		G-AP Ref.	PRODUCT	ABS	Technical Specifications								
									A	B	C	H	L	P			
SEAT	YEAR																
<b>ALTEA XL (5P5, 5P8)</b> 1.6 TDi (77 kW)	2009.10-		MT		F	MPV Engine CAYC	GC083037	Outer Joint	36	30	59.5	40.5	55	I			
	2009.10-		5MT	L	F	MPV Engine CAYC	GDS83294	Drive Shaft	36		59.5	38	519				
	2009.10-		5MT	R	F	MPV Engine CAYC	GDS61042	Drive Shaft	36		59.5	40.5	814				
	2009.10-		MT	L	F	MPV Engine CAYC	GDS61089	Drive Shaft	36		59.5	40.5	521				
	2009.10-		MT				GC083037	Outer Joint	36	30	59.5	40.5	55	I			
	2009.10-					DOUBLE CLUTCH	GCI83016	Inner Joint		28		32					
	2009.10-					Double Clutch	GC083002	Outer Joint	36	27	59.5	40	66	I			
1.8 TFSi (118 kW)	2007.01-		MT		F	MPV Engine BYT/BZB/CDA	GC083002	Outer Joint	36	27	59.5	40	66	I			
	2007.01-		MT	L	F	MPV Engine BYT/BZB/CDA	GDS61131	Drive Shaft	36		59.5	40	515				
	2007.01-		MT			MPV Engine BYT/BZB/CDA	GC083100	Outer Joint	36	33	59.5	38	55	I			
	2007.01-					MPV Engine BYT/BZB/CDA	GC061059	Outer Joint	36	33	59.5	40	59.5	I			
	2007.01-						GCI83016	Inner Joint		28		32					
	2007.01-						GC083002	Outer Joint	36	27	59.5	40	66	I			
1.9 TDi (66 kW)	2006.10-		AT			Engine BKC	GC083002	Outer Joint	36	27	59.5	40	66	I			
1.9 TDi (77 kW)	2006.10-				F	MPV Engine BLS/BXE/BKC	GCI83011	Inner Joint		33		34					
	2006.10-		6AT		F	MPV Engine BLS/BXE/BKC	GC083002	Outer Joint	36	27	59.5	40	66	I			
	2006.10-		6AT		F	MPV Engine BLS/BXE/BKC	GCI54004	Inner Joint		34		85					
	2006.10-		6AT		F	MPV Engine BLS/BXE/BKC	GC061045	Outer Joint	36	27	59.5	40	65	M			
	2006.10-		6MT		F	MPV Engine BLS/BXE/BKC	GC083037	Outer Joint	36	30	59.5	40.5	55	I			
	2006.10-		MT		F	MPV Engine BLS/BXE/BKC	GCI53002	Inner Joint		33		34					
	2006.10-			L	F	MPV Engine BLS/BXE/BKC	GDS83294	Drive Shaft	36		59.5	38	519				
	2006.10-		6AT	L	F	MPV Engine BLS/BXE/BKC	GDS54013	Drive Shaft	36		59.5	40	479.5				
	2006.10-		MT	L	F	MPV Engine BLS/BXE/BKC	GDS83294	Drive Shaft	36		59.5	38	519				
	2006.10-		5MT	R	F	MPV Engine BLS/BXE/BKC	GDS61042	Drive Shaft	36		59.5	40.5	814				
	2006.10-		6AT	R	F	MPV Engine BLS/BXE/BKC	GDS54011	Drive Shaft	36		59.5	40	755				
	2006.10-		AT	L	F	MPV Engine BLS/BXE/BKC	GDS83241	Drive Shaft	36		59.5	40	475				
	2006.10-		MT	L	F	MPV Engine BLS/BXE/BKC	GDS61089	Drive Shaft	36		59.5	40.5	521				
	2006.10-		AT	L/R	F	MPV Engine BLS/BXE/BKC	GCI61057	Inner Joint		34		86					
	2006.10-		AT	R	F	MPV Engine BLS/BXE/BKC	GDS83355	Drive Shaft	36	23	59.5	40	799				
	2006.10-		AT			Engine BKC	GC083002	Outer Joint	36	27	59.5	40	66	I			
	2006.10-		MT			Engine BKC	GC083037	Outer Joint	36	30	59.5	40.5	55	I			
	2.0 FSi (110 kW)	2006.10-	2009.03	6AT		F	MPV Engine BVY/BVZ	GCI61011	Inner Joint	26	32	31	68.5	85			
		2006.10-	2009.03	6AT		F	MPV Engine BVY/BVZ	GC083037	Outer Joint	36	30	59.5	40.5	55	I		
		2006.10-	2009.03	6MT		F	MPV Engine BVY/BVZ	GCI83011	Inner Joint		33		34				
2006.10-		2009.03	MT		F	MPV Engine BVY/BVZ	GCI53002	Inner Joint		33		34					
2006.10-		2009.03	6AT	L	F	MPV Engine BVY/BVZ	GDS61093	Drive Shaft	36	26	59.5	40.5	587.5				
2006.10-		2009.03	MT	L	F	MPV Engine BVY/BVZ	GDS61089	Drive Shaft	36		59.5	40.5	521				
2006.10-		2009.03	6AT	R	F	MPV Engine BVY/BVZ	GDS61094	Drive Shaft	36	26	59.5	40.5	884				
2006.10-		2009.03	6MT	R	F	MPV Engine BVY/BVZ	GDS61113	Drive Shaft	36		59.5	40	814				
2006.10-	2009.03	AT				GC083037	Outer Joint	36	30	59.5	40.5	55	I				
2.0 TDi (103 kW)	2006.10-				F	MPV Engine BMM	GC083002	Outer Joint	36	27	59.5	40	66	I			
	2006.10-		6AT		F	MPV Engine BMM	GCI54004	Inner Joint		34		85					
	2006.10-		MT		F	MPV Engine BMM	GC083002	Outer Joint	36	27	59.5	40	66	I			
	2006.10-		AT	L	F	MPV Engine BMM	GDS54013	Drive Shaft	36		59.5	40	479.5				
	2006.10-		MT	L	F	MPV Engine BMM	GDS83295	Drive Shaft	36		59.5	40	491				
	2006.10-		AT	R	F	MPV Engine BMM	GDS54011	Drive Shaft	36		59.5	40	755				
	2006.10-		MT	R	F	MPV Engine BMM	GDS83313	Drive Shaft	36		59.5	40	792				
	2006.10-		AT	L	F	MPV Engine BMM	GDS83241	Drive Shaft	36		59.5	40	475				
	2006.10-		MT	L	F	MPV Engine BMM	GDS83236	Drive Shaft	36		59.5	40	484				
	2006.10-		AT	L/R	F	MPV Engine BMM	GCI61057	Inner Joint		34		86					
	2006.10-		AT	R	F	MPV Engine BMM	GDS83355	Drive Shaft	36	23	59.5	40	799				
	2006.10-		MT	R	F	MPV Engine BMM	GDS61126	Drive Shaft	36		59.5	40	793				
	2006.10-						GC083002	Outer Joint	36	27	59.5	40	66	I			
	2.0 TDi (125 kW)	2006.10-						GC083002	Outer Joint	36	27	59.5	40	66	I		
2007.06-			MT	R	F	MPV Engine BMN/CEGA	GDS61126	Drive Shaft	36		59.5	40	793				
2007.06-					F	MPV Engine BMN/CEGA	GC061045	Outer Joint	36	27	59.5	40	65	M			
2007.06-			MT		F	MPV Engine BMN/CEGA	GC083002	Outer Joint	36	27	59.5	40	66	I			
2007.06-			MT		F	MPV Engine BMN/CEGA	GCI53002	Inner Joint		33		34					
2007.06-				L	F	MPV Engine BMN/CEGA	GDS83265	Drive Shaft	36		59.5	40	487				
2007.06-		2008.01					GCI83016	Inner Joint		28		32					
2007.06-		MT	L	F	MPV Engine BMN/CEGA	GDS83236	Drive Shaft	36		59.5	40	484					









		TRANSM	L/R	F/R		G-AP Ref.	PRODUCT	ABS	Technical Specifications					
									YEAR	A	B	C	H	L
<b>SEAT</b>														
<b>ALTEA XL (5P5, 5P8)</b>														
2.0 TDi (125 kW)	2007.06-			L	F	MPV Engine BMN/CEGA	GCI83016	Inner Joint		28		32		
2.0 TDi 16V (103 kW)	2006.10-		6AT		F	MPV Engine BKD/CFHC	GCI54004	Inner Joint		34		85		
	2006.10-		MT		F	MPV Engine BKD/CFHC	GC083002	Outer Joint	36	27	59.5	40	66	I
	2006.10-		AT	L	F	MPV Engine BKD/CFHC	GDS54013	Drive Shaft	36		59.5	40	479.5	
	2006.10-		MT	L	F	MPV Engine BKD/CFHC	GDS83295	Drive Shaft	36		59.5	40	491	
	2006.10-		AT	R	F	MPV Engine BKD/CFHC	GDS54011	Drive Shaft	36		59.5	40	755	
	2006.10-		MT	R	F	MPV Engine BKD/CFHC	GDS83313	Drive Shaft	36		59.5	40	792	
	2006.10-		AT	L	F	MPV Engine BKD/CFHC	GDS83241	Drive Shaft	36		59.5	40	475	
	2006.10-		MT	L	F	MPV Engine BKD/CFHC	GDS83236	Drive Shaft	36		59.5	40	484	
	2006.10-		AT	L/R	F	MPV Engine BKD/CFHC	GCI61057	Inner Joint		34		86		
	2006.10-		AT	R	F	MPV Engine BKD/CFHC	GDS83355	Drive Shaft	36	23	59.5	40	799	
2006.10-		MT	R	F	MPV Engine BKD/CFHC	GDS61126	Drive Shaft	36		59.5	40	793		
2.0 TDi 16V 4x4 (103 kW)	2010.10-		AT	L		MPV Engine CFHC	GDS54013	Drive Shaft	36		59.5	40	479.5	
	2010.10-		MT	L		MPV Engine CFHC	GDS83295	Drive Shaft	36		59.5	40	491	
	2010.10-				R	MPV Engine CFHC	GDS83266	Drive Shaft	36		59.5	40	601	
	2010.10-		AT	R		MPV Engine CFHC	GDS54011	Drive Shaft	36		59.5	40	755	
	2010.10-		MT	R		MPV Engine CFHC	GDS83313	Drive Shaft	36		59.5	40	792	
	2010.10-		6AT	L	F	MPV Engine CFHC	GDS83236	Drive Shaft	36		59.5	40	484	
	2010.10-		AT	L/R	F	MPV Engine CFHC	GCI61057	Inner Joint		34		86		
	2010.10-		AT	R	F	MPV Engine CFHC	GDS83355	Drive Shaft	36	23	59.5	40	799	
2010.10-					R	MPV Engine CFHC	GCI83016	Inner Joint		28		32		
2.0 TDi 4x4 (103 kW)	2007.06-		6AT			MPV Engine BMM	GCI54004	Inner Joint		34		85		
	2007.06-		AT	L		MPV Engine BMM	GDS54013	Drive Shaft	36		59.5	40	479.5	
	2007.06-		MT	L		MPV Engine BMM	GDS83295	Drive Shaft	36		59.5	40	491	
	2007.06-		AT	R		MPV Engine BMM	GDS83266	Drive Shaft	36		59.5	40	601	
	2007.06-		AT	R		MPV Engine BMM	GDS54011	Drive Shaft	36		59.5	40	755	
	2007.06-		MT	R		MPV Engine BMM	GDS83313	Drive Shaft	36		59.5	40	792	
	2007.06-				F	MPV Engine BMM	GC083002	Outer Joint	36	27	59.5	40	66	I
	2007.06-				R	MPV Engine BMM	GCI83011	Inner Joint		33		34		
	2007.06-		AT	L	F	MPV Engine BMM	GDS83241	Drive Shaft	36		59.5	40	475	
	2007.06-		MT	L	F	MPV Engine BMM	GDS83236	Drive Shaft	36		59.5	40	484	
	2007.06-		AT	L/R	F	MPV Engine BMM	GCI61057	Inner Joint		34		86		
	2007.06-		AT	R	F	MPV Engine BMM	GDS83355	Drive Shaft	36	23	59.5	40	799	
	2007.06-		AT	R		MPV Engine BMM	GCI83016	Inner Joint		28		32		
2.0 TDi 4x4 (125 kW)	2007.06-		MT			MPV Engine BMN/CEGA/CFJA	GCI53002	Inner Joint		33		34		
	2007.06-		AT	R		MPV Engine BMN/CEGA/CFJA	GDS83266	Drive Shaft	36		59.5	40	601	
	2007.06-				F	MPV Engine BMN/CEGA/CFJA	GC061045	Outer Joint	36	27	59.5	40	65	M
	2007.06-		MT		F	MPV Engine BMN/CEGA/CFJA	GC083002	Outer Joint	36	27	59.5	40	66	I
	2007.06-				R	MPV Engine BMN/CEGA/CFJA	GCI83011	Inner Joint		33		34		
	2007.06-		MT	L	F	MPV Engine BMN/CEGA/CFJA	GDS83236	Drive Shaft	36		59.5	40	484	
	2007.06-		AT	R		MPV Engine BMN/CEGA/CFJA	GCI83016	Inner Joint		28		32		
2.0 TFSi 4WD (147 kW)	2007.06-	2009.05					GCI83016	Inner Joint		28		32		
	2007.06-	2009.05					GC083002	Outer Joint	36	27	59.5	40	66	I
2.0 TFSi 4WD (155 kW)	2007.06-	2009.05					GC053001	Outer Joint	36	30	59.5	40	49	I
2.0 TFSi 4x4 (147 kW)	2007.06-	2009.05	MT			MPV Engine BWA	GCI53002	Inner Joint		33		34		
	2007.06-	2009.05	MT		F	MPV Engine BWA	GC083002	Outer Joint	36	27	59.5	40	66	I
	2007.06-	2009.05	AT	L	F	MPV Engine BWA	GDS83236	Drive Shaft	36		59.5	40	484	
2007.06-	2009.05				R	MPV Engine BWA	GCI83011	Inner Joint		33		34		
2.0 TFSi 4x4 (155 kW)	2009.05-				F	MPV Engine CCZB	GC083002	Outer Joint	36	27	59.5	40	66	I
	2009.05-				R	MPV Engine CCZB	GCI83011	Inner Joint		33		34		
	2009.05-		AT	L	F	MPV Engine CCZB	GDS83236	Drive Shaft	36		59.5	40	484	
<b>AROSA (6H)</b>														
1.0 (37 kW)	1997.05-	2004.06	MT/AT		F	Hatchback Engine AER/ALD/ALL/ANV/AUC	GC053005	Outer Joint	22	30	53	78.5	51	I
	1997.05-	2004.06	MT/AT		F	Hatchback Engine AER/ALD/ALL/ANV/AUC	GCI53001	Inner Joint		33		32		
	1997.05-	2004.06		L	F	Hatchback Engine AER/ALD/ALL/ANV/AUC	GDS61205	Drive Shaft	22		53	78.5	525	
1.4 (44 kW)	1997.05-	2004.06	MT/AT		F	Hatchback Engine AEX/AKK/AKV/ANW/APQ/AUD	GC053005	Outer Joint	22	30	53	78.5	51	I
	1997.05-	2004.06	MT/AT		F	Hatchback Engine AEX/AKK/AKV/ANW/APQ/AUD	GCI53001	Inner Joint		33		32		
	1997.05-	2004.06	MT/AT	L	F	Hatchback Engine AEX/AKK/AKV/ANW/APQ/AUD	GDS61205	Drive Shaft	22		53	78.5	525	
1.4 16V (74 kW)	2000.01-	2004.06	MT/AT		F	Hatchback Engine AFK/AQQ/AUB	GC053005	Outer Joint	22	30	53	78.5	51	I
	2000.01-	2004.06	MT/AT	L	F	Hatchback Engine AFK/AQQ/AUB	GDS61205	Drive Shaft	22		53	78.5	525	
1.4 TDi (55 kW)	2000.01-	2004.06	MT		F	Hatchback Engine AMF	GCI53001	Inner Joint		33		32		



		TRANSM	L/R	F/R		G-AP Ref.	PRODUCT	ABS	Technical Specifications							
									YEAR	A	B	C	H	L	P	
<b>SEAT</b>																
<b>AROSA (6H)</b>																
1.4 TDi (55 kW)	2000.01-	2004.06	5MT	L	F	Hatchback Engine AMF	GDS61075	Drive Shaft	22		53	78.5	525			
	2000.01-	2004.06	5MT	R	F	Hatchback Engine AMF	GDS61074	Drive Shaft	22		53	78.5	712			
1.7 SDi (44 kW)	1997.08-	2004.06	MT/AT		F	Hatchback Engine AKU	GC053005	Outer Joint	22	30	53	78.5	51	I		
	1997.08-	2004.06	MT/AT		F	Hatchback Engine AKU	GCI53001	Inner Joint		33		32				
<b>CORDOBA (6K2)</b>																
1.0 (37 kW)	1999.06-	2002.10		L	F	Hatchback Engine ALD/ANV/AUC	GDS53004	Drive Shaft	22		50	78.5	562			
1.4 (44 kW)	1999.06-	2002.10	MT		F	Hatchback Engine AKK/ANW/AUD	GC053008	Outer Joint	22	30	53	78.5	51	I		
	1999.06-	2002.10	MT		F	Hatchback Engine AKK/ANW/AUD	GCI53001	Inner Joint		33		32				
	1999.06-	2002.10	MT	L	F	Hatchback Engine AKK/ANW/AUD	GDS53004	Drive Shaft	22		50	78.5	562			
1.4 16V (55 kW)	2000.05-	2002.10	MT		F	Hatchback Engine APE/AUA	GC053008	Outer Joint	22	30	53	78.5	51	I		
	2000.05-	2002.10	MT		F	Hatchback Engine APE/AUA	GCI53001	Inner Joint		33		32				
	2000.05-	2002.10	MT	L	F	Hatchback Engine APE/AUA	GDS53004	Drive Shaft	22		50	78.5	562			
1.4 16V (74 kW)	2000.02-	2002.10		L	F	Hatchback Engine AQQ/AUB	GDS53004	Drive Shaft	22		50	78.5	562			
1.6 (55 kW)	1999.06-	2002.10	MT		F	Hatchback Engine ALM	GC053008	Outer Joint	22	30	53	78.5	51	I		
	1999.06-	2002.10	MT		F	Hatchback Engine ALM	GCI53001	Inner Joint		33		32				
	1999.06-	2002.10	MT	L	F	Hatchback Engine ALM	GDS53004	Drive Shaft	22		50	78.5	562			
1.6 (74 kW)	1999.06-	2002.10	MT		F	Hatchback Engine AEH/AKL/APF/AUR	GC053008	Outer Joint	22	30	53	78.5	51	I		
	1999.06-	2002.10	MT/AT		F	Hatchback Engine AEH/AKL/APF/AUR	GCI83004	Inner Joint		33		32				
1.8 T 20V Cupra (115 kW)	2000.07-	2002.10			F	Hatchback Engine AQX/AYP	GCI83011	Inner Joint		33		34				
	2000.07-	2002.10	MT		F	Hatchback Engine AQX/AYP	GCI83009	Inner Joint		33		34				
1.9 SDi (50 kW)	1999.06-	2002.10	MT		F	Hatchback Engine AGP/AQM	GC053008	Outer Joint	22	30	53	78.5	51	I		
	1999.06-	2002.10	MT/AT		F	Hatchback Engine AGP/AQM	GCI83004	Inner Joint		33		32				
1.9 TDi (66 kW)	1999.06-	2002.10	MT		F	Hatchback Engine AGR/ALH	GC053007	Outer Joint	22	30	53.2	78	61	I		
	1999.06-	2002.10	MT		F	Hatchback Engine AGR/ALH	GC061018	Outer Joint	22	30	53	78.5	61	I		
	1999.06-	2002.10	MT		F	Hatchback Engine AGR/ALH	GCI83009	Inner Joint		33		34				
1.9 TDi (81 kW)	1999.06-	2002.10			F	Hatchback Engine ASK/ASV	GC053007	Outer Joint	22	30	53.2	78	61	I		
	1999.06-	2002.10	MT		F	Hatchback Engine ASK/ASV	GC061018	Outer Joint	22	30	53	78.5	61	I		
	1999.06-	2002.10	MT		F	Hatchback Engine ASK/ASV	GCI83009	Inner Joint		33		34				
<b>CORDOBA (6L2)</b>																
1.2 (47 kW)	2002.10-	2006.06	MT		F	Saloon Engine AZQ/BME	GC083027	Outer Joint	36	30	50.7	58.5	47.5	I		
	2002.10-	2006.06	5MT	L	F	Saloon Engine AZQ/BME	GDS83063	Drive Shaft	36		50.7	58.5	501			
	2002.10-	2006.06	5MT	R	F	Saloon Engine AZQ/BME	GDS61063	Drive Shaft	36		50.7	58.5	751			
1.2 12V (51 kW)	2006.05-	2009.11	MT		F	Saloon Engine BXV	GC083027	Outer Joint	36	30	50.7	58.5	47.5	I		
	2006.05-	2009.11		L	F	Saloon Engine BXV	GDS83063	Drive Shaft	36		50.7	58.5	501			
	2006.05-	2009.11		R	F	Saloon Engine BXV	GDS61063	Drive Shaft	36		50.7	58.5	751			
1.4 16V (55 kW)	2002.09-	2007.12	MT		F	Saloon Engine BBY/BKY	GC083027	Outer Joint	36	30	50.7	58.5	47.5	I		
	2002.09-	2007.12	MT/AT		F	Saloon Engine BBY/BKY	GCI61005	Inner Joint		30		57.6				
	2002.09-	2007.12	5MT	L	F	Saloon Engine BBY/BKY	GDS83063	Drive Shaft	36		50.7	58.5	501			
	2002.09-	2007.12	5AT	R	F	Saloon Engine BBY/BKY	GDS61252	Drive Shaft	36		53.7	58.5	730			
	2002.09-	2007.12	5AT	R	F	Saloon Engine BBY/BKY	GCI61005	Inner Joint		30		57.6				
	2002.09-	2007.12	5AT	R	F	Saloon Engine BBY/BKY	GC061070	Outer Joint	36	30	53.7	58.5	55	I		
	2002.09-	2007.12	5MT	R	F	Saloon Engine BBY/BKY	GDS61063	Drive Shaft	36		50.7	58.5	751			
1.4 16V (63 kW)	2006.05-	2009.11	MT		F	Saloon Engine BXW	GC083027	Outer Joint	36	30	50.7	58.5	47.5	I		
	2006.05-	2009.11		L	F	Saloon Engine BXW	GDS83063	Drive Shaft	36		50.7	58.5	501			
	2006.05-	2009.11		R	F	Saloon Engine BXW	GDS61063	Drive Shaft	36		50.7	58.5	751			
1.4 16V (74 kW)	2002.10-	2009.11	MT		F	Saloon Engine BBZ/AUB	GC083027	Outer Joint	36	30	50.7	58.5	47.5	I		
	2002.10-	2009.11	MT	L	F	Saloon Engine BBZ/AUB	GDS83063	Drive Shaft	36		50.7	58.5	501			
	2002.10-	2009.11	5MT	R	F	Saloon Engine BBZ/AUB	GDS61063	Drive Shaft	36		50.7	58.5	751			
1.4 TDi (51 kW)	2005.05-	2009.11	MT		F	Saloon Engine BNM	GC083024	Outer Joint	36	30	50.75	59	54.5	I		
	2005.05-	2009.11	MT	R	F	Saloon Engine BNM	GDS61223	Drive Shaft	36		52	59	757			
1.4 TDi (55 kW)	2002.10-	2005.12	MT		F	Saloon Engine AMF	GC083024	Outer Joint	36	30	50.75	59	54.5	I		
	2002.10-	2005.12	MT/AT		F	Saloon Engine AMF	GCI61006	Inner Joint		30		57.6				
	2002.10-	2005.12	5MT	L	F	Saloon Engine AMF	GDS61098	Drive Shaft	36		50.5	59	472			
	2002.10-	2005.12		L	F	Saloon Engine AMF	GDS61135	Drive Shaft	36		52	59	475			
	2002.10-	2005.12	5MT	R	F	Saloon Engine AMF	GDS61099	Drive Shaft	36		50.5	59	759			
	2002.10-	2005.12		R	F	Saloon Engine AMF	GDS61136	Drive Shaft	36		52	59	763			
	2002.10-	2005.12		R	F	Saloon Engine AMF	GCI61062	Inner Joint		30		59				
1.4 TDi (59 kW)	2005.06-	2009.11	MT		F	Saloon Engine BMS/BNV	GC083024	Outer Joint	36	30	50.75	59	54.5	I		
	2005.06-	2009.11		L	F	Saloon Engine BMS/BNV	GDS61098	Drive Shaft	36		50.5	59	472			
	2005.06-	2009.11		L	F	Saloon Engine BMS/BNV	GDS61135	Drive Shaft	36		52	59	475			
	2005.06-	2009.11		R	F	Saloon Engine BMS/BNV	GDS61099	Drive Shaft	36		50.5	59	759			

		TRANSM	L/R	F/R		G-AP Ref.	PRODUCT	ABS	Technical Specifications							
									YEAR	A	B	C	H	L	P	
<b>SEAT</b>																
<b>CORDOBA (6L2)</b>																
1.4 TDi (59 kW)	2005.06-	2009.11			R	F	Saloon Engine BMS/BNV	GDS61136	Drive Shaft	36		52	59	763		
	2005.06-	2009.11			R	F	Saloon Engine BMS/BNV	GCI161062	Inner Joint		30		59			
1.6 (74 kW)	2003.04-	2009.11	MT			F	Saloon Engine BAH	GC083024	Outer Joint	36	30	50.75	59	54.5	I	
1.6 16V (77 kW)	2006.11-	2009.11	MT			F	Saloon Engine BTS	GCI83011	Inner Joint		33		34			
	2006.11-	2009.11	MT			F	Saloon Engine BTS	GC083024	Outer Joint	36	30	50.75	59	54.5	I	
1.9 SDi (47 kW)	2002.09-	2009.11	MT			F	Saloon Engine ASY	GC083027	Outer Joint	36	30	50.7	58.5	47.5	I	
	2002.09-	2009.11	5MT	L		F	Saloon Engine ASY	GDS83063	Drive Shaft	36		50.7	58.5	501		
	2002.09-	2009.11	5MT	R		F	Saloon Engine ASY	GDS61063	Drive Shaft	36		50.7	58.5	751		
1.9 TDi (74 kW)	2002.09-	2009.11	MT			F	Saloon Engine ATD/AXR/BMT	GC083024	Outer Joint	36	30	50.75	59	54.5	I	
	2002.09-	2009.11	MT/AT			F	Saloon Engine ATD/AXR/BMT	GCI161006	Inner Joint		30		57.6			
	2002.09-	2009.11	5MT	L		F	Saloon Engine ATD/AXR/BMT	GDS61098	Drive Shaft	36		50.5	59	472		
	2002.09-	2009.11		L		F	Saloon Engine ATD/AXR/BMT	GDS61135	Drive Shaft	36		52	59	475		
	2002.09-	2009.11	5MT	R		F	Saloon Engine ATD/AXR/BMT	GDS61099	Drive Shaft	36		50.5	59	759		
	2002.09-	2009.11		R		F	Saloon Engine ATD/AXR/BMT	GDS61136	Drive Shaft	36		52	59	763		
	2002.09-	2009.11		R		F	Saloon Engine ATD/AXR/BMT	GCI161062	Inner Joint		30		59			
1.9 TDi (96 kW)	2002.10-	2009.11	6MT			F	Saloon Engine ASZ/BLT	GC053002	Outer Joint	36	27	50.75	75	65	I	
	2002.10-	2009.11	MT	L		F	Saloon Engine ASZ/BLT	GDS61204	Drive Shaft	36		50.5	75	461		
	2002.10-	2009.11	MT	R		F	Saloon Engine ASZ/BLT	GDS61183	Drive Shaft	36		50.5	75	769		
2.0 (85 kW)	2002.09-	2009.11	MT			F	Saloon Engine AZL/BBX	GC083024	Outer Joint	36	30	50.75	59	54.5	I	
<b>CORDOBA GLX / SXE</b>																
1.8	1995-							GC099136	Outer Joint	22	30	51	78	61	I	
<b>CORDOBA II (6K2, 6K5), VARIO</b>																
1.4 16V (55 kW)	2000.02-	2002.10						GC083027	Outer Joint	36	30	50.7	58.5	47.5	I	
1.6 (74 kW)	1999.06-	2002.10			R			GCI83011	Inner Joint		33		34			
1.9 TDi (66 kW)	1999.06-	2002.10			R			GCI83011	Inner Joint		33		34			
1.9 TDi (81 kW)	1999.06-	2002.10			R			GCI83011	Inner Joint		33		34			
<b>CORDOBA III (6L2)</b>																
1.2 (47 kW)	2002.10-	2006.06						GC083027	Outer Joint	36	30	50.7	58.5	47.5	I	
1.2 12V (51 kW)	2006.05-	2009.11						GC083027	Outer Joint	36	30	50.7	58.5	47.5	I	
1.4 i 16V (55 kW)	2002.10-	2009.11						GC083027	Outer Joint	36	30	50.7	58.5	47.5	I	
1.4 i 16V (63 kW)	2002.10-	2009.11						GC083027	Outer Joint	36	30	50.7	58.5	47.5	I	
1.4 i 16V (74 kW)	2002.10-	2009.11						GC083027	Outer Joint	36	30	50.7	58.5	47.5	I	
1.9 SDi (47 kW)	2002.09-	2009.11						GC083027	Outer Joint	36	30	50.7	58.5	47.5	I	
<b>CORDOBA VARIO (6K5)</b>																
1.4 (44 kW)	1999.06-	2002.12	MT			F	Estate Engine AKK/ANW/AUD	GC053008	Outer Joint	22	30	53	78.5	51	I	
	1999.06-	2002.12	MT			F	Estate Engine AKK/ANW/AUD	GCI153001	Inner Joint		33		32			
	1999.06-	2002.12	MT	L		F	Estate Engine AKK/ANW/AUD	GDS53004	Drive Shaft	22		50	78.5	562		
1.4 16V (55 kW)	1999.06-	2002.12	MT			F	Estate Engine APE/AUA	GC053008	Outer Joint	22	30	53	78.5	51	I	
	1999.06-	2002.12	MT			F	Estate Engine APE/AUA	GCI153001	Inner Joint		33		32			
	1999.06-	2002.12	MT	L		F	Estate Engine APE/AUA	GDS53004	Drive Shaft	22		50	78.5	562		
1.6 (55 kW)	1999.06-	2002.12	MT			F	Estate Engine ALM	GC053008	Outer Joint	22	30	53	78.5	51	I	
	1999.06-	2002.12	MT			F	Estate Engine ALM	GCI153001	Inner Joint		33		32			
	1999.06-	2002.12	MT	L		F	Estate Engine ALM	GDS53004	Drive Shaft	22		50	78.5	562		
1.6 (74 kW)	1999.06-	2002.12	MT			F	Estate Engine AEH/AKL/APF/AUR	GC053008	Outer Joint	22	30	53	78.5	51	I	
	1999.06-	2002.12	MT/AT			F	Estate Engine AEH/AKL/APF/AUR	GCI83004	Inner Joint		33		32			
1.9 SDi (50 kW)	1999.06-	2002.12	MT			F	Estate Engine AGP/AQM	GC053008	Outer Joint	22	30	53	78.5	51	I	
	1999.06-	2002.12	MT/AT			F	Estate Engine AGP/AQM	GCI83004	Inner Joint		33		32			
1.9 TDi (66 kW)	1999.06-	2002.12	MT			F	Estate Engine AGR/ALH	GCI83011	Inner Joint		33		34			
	1999.06-	2002.12	MT			F	Estate Engine AGR/ALH	GC053007	Outer Joint	22	30	53.2	78	61	I	
	1999.06-	2002.12	MT			F	Estate Engine AGR/ALH	GC061018	Outer Joint	22	30	53	78.5	61	I	
1.9 TDi (81 kW)	1999.06-	2002.12				F	Estate Engine ASK/ASV	GC053007	Outer Joint	22	30	53.2	78	61	I	
	1999.06-	2002.12	MT			F	Estate Engine ASK/ASV	GCI83011	Inner Joint		33		34			
	1999.06-	2002.12	MT			F	Estate Engine ASK/ASV	GC061018	Outer Joint	22	30	53	78.5	61	I	
<b>EXEO (3R2)</b>																
1.6 (75 kW)	2009.03-	2010.09				F	Saloon Engine ALZ	GC083030	Outer Joint		38	33	59.5	34	55	M
1.8 T (110 kW)	2008.12-	2010.05				F	Saloon Engine CFMA	GC083078	Outer Joint	45W	38	27	59.5	34.5	63	M
	2008.12-	2010.05				F	Saloon Engine CFMA	GC083067	Outer Joint	45W	38	27	59.5	34	68	M
	2008.12-	2010.05			L	F	Saloon Engine CFMA	GDS83352	Drive Shaft	45W	38		59.5	34.5	594	
1.8 TSi (118 kW)	2010.05-				L	F	Saloon Engine CDHB	GDS83352	Drive Shaft	45W	38		59.5	34.5	594	
	2010.05-					F	Saloon Engine CDHB	GC083069	Outer Joint	45W	38	27	59.5	34.5	63	M
1.8 TSi (88 kW)	2010.09-				L	F	Saloon Engine CDHA	GDS83352	Drive Shaft	45W	38		59.5	34.5	594	









		TRANSM	L/R	F/R		G-AP Ref.	PRODUCT	ABS	Technical Specifications						
									YEAR	A	B	C	H	L	P
<b>SEAT</b>															
<b>EXEO (3R2)</b>															
1.8 TSi (88 kW)	2010.09-			F	Saloon Engine CDHA	GC083069	Outer Joint	45W	38	27	59.5	34.5	63	M	
2.0 TDi (105 kW)	2008.12-			F	Saloon Engine CAGA	GC083078	Outer Joint	45W	38	27	59.5	34.5	63	M	
	2008.12-			F	Saloon Engine CAGA	GC083067	Outer Joint	45W	38	27	59.5	34	68	M	
	2008.12-		AT	F	Saloon Engine CAGA	GC083092	Outer Joint	45W	38	27	59.5	34	68	I	
	2008.12-			L	F	Saloon Engine CAGA	GDS83352	Drive Shaft	45W	38		59.5	34.5	594	
	2008.12-					Saloon Engine CAGA	GC083069	Outer Joint	45W	38	27	59.5	34.5	63	M
2.0 TDi (125 kW)	2009.02-			F	Saloon Engine CAHA	GC083067	Outer Joint	45W	38	27	59.5	34	68	M	
	2009.02-		MT/AT	F	Saloon Engine CAHA	GCI61044	Inner Joint			34		85			
	2009.02-			L	F	Saloon Engine CAHA	GDS83352	Drive Shaft	45W	38		59.5	34.5	594	
	2009.02-		MT	R	F	Saloon Engine CAHA	GDS83255	Drive Shaft	45W	38		59.5	34.5	621	
	2009.02-				F	Saloon Engine CAHA	GC083069	Outer Joint	45W	38	27	59.5	34.5	63	M
2.0 TDi (88 kW)	2008.12-			F	Saloon Engine CAGC	GC083067	Outer Joint	45W	38	27	59.5	34	68	M	
	2008.12-		MT/AT	F	Saloon Engine CAGC	GCI61044	Inner Joint			34		85			
	2008.12-			L	F	Saloon Engine CAGC	GDS83352	Drive Shaft	45W	38		59.5	34.5	594	
	2008.12-		MT	R	F	Saloon Engine CAGC	GDS83255	Drive Shaft	45W	38		59.5	34.5	621	
	2008.12-					Saloon Engine CAGC	GC083069	Outer Joint	45W	38	27	59.5	34.5	63	M
2.0 TFSi (147 kW)	2009.03-			F	Saloon Engine BWE	GC083067	Outer Joint	45W	38	27	59.5	34	68	M	
	2009.03-		AT	F	Saloon Engine BWE	GC083092	Outer Joint	45W	38	27	59.5	34	68	I	
	2009.03-		MT/AT	F	Saloon Engine BWE	GCI61044	Inner Joint			34		85			
	2009.03-			L	F	Saloon Engine BWE	GDS83352	Drive Shaft	45W	38		59.5	34.5	594	
	2009.03-		MT	R	F	Saloon Engine BWE	GDS83255	Drive Shaft	45W	38		59.5	34.5	621	
	2009.03-					Saloon Engine BWE	GC083069	Outer Joint	45W	38	27	59.5	34.5	63	M
2.0 TFSi (155 kW)	2010.05-			L	F	Saloon Engine CDND	GDS83352	Drive Shaft	45W	38		59.5	34.5	594	
	2010.05-				F	Saloon Engine CDND	GC083069	Outer Joint	45W	38	27	59.5	34.5	63	M
<b>EXEO ST (3R5)</b>															
1.6 (75 kW)	2009.06-	2010.09		F	Estate Engine ALZ	GC083030	Outer Joint		38	33	59.5	34	55	M	
1.8 T (110 kW)	2009.06-	2010.05		F	Estate Engine CFMA	GC083078	Outer Joint	45W	38	27	59.5	34.5	63	M	
	2009.06-	2010.05		L	F	Estate Engine CFMA	GDS83352	Drive Shaft	45W	38		59.5	34.5	594	
1.8 TSi (118 kW)	2010.05-			L	F	Estate Engine CDHB	GDS83352	Drive Shaft	45W	38		59.5	34.5	594	
	2010.05-			F	Estate Engine CDHB	GC083069	Outer Joint	45W	38	27	59.5	34.5	63	M	
1.8 TSi (88 kW)	2010.09-			L	F	Estate Engine CDHA	GDS83352	Drive Shaft	45W	38		59.5	34.5	594	
	2010.09-				F	Estate Engine CDHA	GC083069	Outer Joint	45W	38	27	59.5	34.5	63	M
2.0 TDi (105 kW)	2009.05-			F	Estate Engine CAGA/CJCA	GC083078	Outer Joint	45W	38	27	59.5	34.5	63	M	
	2009.05-		AT	F	Estate Engine CAGA/CJCA	GC083092	Outer Joint	45W	38	27	59.5	34	68	I	
	2009.05-		MT	L	F	Estate Engine CAGA/CJCA	GDS83352	Drive Shaft	45W	38		59.5	34.5	594	
	2009.05-					Estate Engine CAGA/CJCA	GC083069	Outer Joint	45W	38	27	59.5	34.5	63	M
2.0 TDi (125 kW)	2009.05-			L	F	Estate Engine CAHA/CGLB	GDS83352	Drive Shaft	45W	38		59.5	34.5	594	
	2009.05-					Estate Engine CAHA/CGLB	GC083069	Outer Joint	45W	38	27	59.5	34.5	63	M
2.0 TDi (88 kW)	2009.07-			L	F	Estate Engine CAGC/CJCC	GDS83352	Drive Shaft	45W	38		59.5	34.5	594	
	2009.07-					Estate Engine CAGC/CJCC	GC083069	Outer Joint	45W	38	27	59.5	34.5	63	M
2.0 TFSi (147 kW)	2009.06-		AT	F	Estate Engine BWE	GC083092	Outer Joint	45W	38	27	59.5	34	68	I	
	2009.06-		MT	L	F	Estate Engine BWE	GDS83352	Drive Shaft	45W	38		59.5	34.5	594	
	2009.06-					Estate Engine BWE	GC083069	Outer Joint	45W	38	27	59.5	34.5	63	M
2.0 TFSi (155 kW)	2010.05-			L	F	Estate Engine CDND	GDS83352	Drive Shaft	45W	38		59.5	34.5	594	
	2010.05-					Estate Engine CDND	GC083069	Outer Joint	45W	38	27	59.5	34.5	63	M
<b>IBIZA (021A)</b>															
0.9 (29 kW)	1990.08-	1993.05	MT		F	Hatchback Engine 09NCA/146A000	GC017005	Outer Joint		22	20	48.1	90.5	59.5	O
0.9 (32 kW)	1986.08-	1993.05	MT		F	Hatchback Engine 146A000	GC017005	Outer Joint		22	20	48.1	90.5	59.5	O
1.2 (44 kW)	1984.11-	1993.12	MT		F	Hatchback Engine 021A1000	GC017005	Outer Joint		22	20	48.1	90.5	59.5	O
1.2 i (52 kW)	1989.01-	1993.05	MT		F	Hatchback Engine 021C.1000	GC017005	Outer Joint		22	20	48.1	90.5	59.5	O
1.5 (63 kW)	1984.11-	1993.05	MT		F	Hatchback Engine 021A2000	GC017005	Outer Joint		22	20	48.1	90.5	59.5	O
1.5 i (65 kW)	1986.10-	1993.05	MT		F	Hatchback Engine 021D.2000	GC017005	Outer Joint		22	20	48.1	90.5	59.5	O
1.5 i (74 kW)	1986.10-	1993.05	MT		F	Hatchback Engine 021B.2000	GC017005	Outer Joint		22	20	48.1	90.5	59.5	O
1.5 i CAT (66 kW)	1986.10-	1993.05	MT		F	Hatchback Engine 021C.2000	GC017005	Outer Joint		22	20	48.1	90.5	59.5	O
1.7 D (40 kW)	1984.06-	1993.05	MT		F	Hatchback Engine 022A.5000	GC017005	Outer Joint		22	20	48.1	90.5	59.5	O
1.7 D (42 kW)	1990.08-	1993.05	MT		F	Hatchback Engine 022A.5000	GC017005	Outer Joint		22	20	48.1	90.5	59.5	O
<b>IBIZA GLX / SXE</b>															
1.8	1995-						GC099136	Outer Joint		22	30	51	78	61	I
<b>IBIZA III (6K1)</b>															
1.0 (37 kW)	1999.08-	2002.02	MT		F	Hatchback Engine ALD/ANV/AUC	GC053008	Outer Joint		22	30	53	78.5	51	I
	1999.08-	2002.02	MT		F	Hatchback Engine ALD/ANV/AUC	GCI53001	Inner Joint			33		32		



		TRANSM	L/R	F/R		G-AP Ref.	PRODUCT	ABS	Technical Specifications									
									YEAR	A	B	C	H	L	P			
<b>SEAT</b>																		
<b>IBIZA III (6K1)</b>																		
1.0 (37 kW)	1999.08-	2002.02	MT	L	F	Hatchback Engine ALD/ANV/AUC	GDS53004	Drive Shaft	22		50	78.5	562					
1.4 (44 kW)	1999.08-	2002.02	MT		F	Hatchback Engine AKK/ANW/AUD	GC053008	Outer Joint	22	30	53	78.5	51	I				
	1999.08-	2002.02	MT		F	Hatchback Engine AKK/ANW/AUD	GCI53001	Inner Joint		33		32						
	1999.08-	2002.02	MT	L	F	Hatchback Engine AKK/ANW/AUD	GDS53004	Drive Shaft	22		50	78.5	562					
1.4 16V (55 kW)	2000.05-	2002.02	MT		F	Hatchback Engine APE/AUA	GC053008	Outer Joint	22	30	53	78.5	51	I				
	2000.05-	2002.02	MT		F	Hatchback Engine APE/AUA	GCI53001	Inner Joint		33		32						
	2000.05-	2002.02	MT	L	F	Hatchback Engine APE/AUA	GDS53004	Drive Shaft	22		50	78.5	562					
1.4 16V (74 kW)	1999.08-	2002.02	MT		F	Hatchback Engine AQQ/AUB	GC053008	Outer Joint	22	30	53	78.5	51	I				
	1999.08-	2002.02	MT		F	Hatchback Engine AQQ/AUB	GCI53001	Inner Joint		33		32						
	1999.08-	2002.02	MT	L	F	Hatchback Engine AQQ/AUB	GDS53004	Drive Shaft	22		50	78.5	562					
1.6 (55 kW)	1999.08-	2002.02	MT		F	Hatchback Engine ALM	GC053008	Outer Joint	22	30	53	78.5	51	I				
	1999.08-	2002.02	MT		F	Hatchback Engine ALM	GCI53001	Inner Joint		33		32						
	1999.08-	2002.02	MT	L	F	Hatchback Engine ALM	GDS53004	Drive Shaft	22		50	78.5	562					
1.6 (74 kW)	1999.08-	2002.02	MT/AT		F	Hatchback Engine AEH/AKL/APF/AUR	GCI83004	Inner Joint		33		32						
1.8 T 20V Cupra (115 kW)	2000.07-	2002.02	MT		F	Hatchback Engine AQX/AYP	GC053008	Outer Joint	22	30	53	78.5	51	I				
	2000.07-	2002.02	MT		F	Hatchback Engine AQX/AYP	GCI83011	Inner Joint		33		34						
1.9 SDi (50 kW)	1999.08-	2002.02	MT		F	Hatchback Engine AGP/AQM	GC053008	Outer Joint	22	30	53	78.5	51	I				
	1999.08-	2002.02	MT		F	Hatchback Engine AGP/AQM	GCI83004	Inner Joint		33		32						
1.9 TDi (66 kW)	1999.08-	2002.02	MT		F	Hatchback Engine AGR/ALH	GCI83011	Inner Joint		33		34						
	1999.08-	2002.02	MT		F	Hatchback Engine AGR/ALH	GC053007	Outer Joint	22	30	53.2	78	61	I				
	1999.08-	2002.02	MT		F	Hatchback Engine AGR/ALH	GC061018	Outer Joint	22	30	53	78.5	61	I				
1.9 TDi (81 kW)	1999.08-	2002.02			F	Hatchback Engine ASK/ASV	GC053007	Outer Joint	22	30	53.2	78	61	I				
	1999.08-	2002.02	MT		F	Hatchback Engine ASK/ASV	GCI83011	Inner Joint		33		34						
	1999.08-	2002.02	MT		F	Hatchback Engine ASK/ASV	GC061018	Outer Joint	22	30	53	78.5	61	I				
<b>IBIZA IV (6L1)</b>																		
1.2 (44 kW)	2002.02-	2008.07					GC083027	Outer Joint	36	30	50.7	58.5	47.5	I				
	2007.06-	2008.05			F	Hatchback Engine BBM	GC083027	Outer Joint	36	30	50.7	58.5	47.5	I				
	2007.06-	2008.05		L	F	Hatchback Engine BBM	GDS83063	Drive Shaft	36		50.7	58.5	501					
	2007.06-	2008.05		R	F	Hatchback Engine BBM	GDS61063	Drive Shaft	36		50.7	58.5	751					
1.2 (47 kW)	2002.02-	2006.06			F	Hatchback Engine AZQ/BME	GC083027	Outer Joint	36	30	50.7	58.5	47.5	I				
	2002.02-	2006.06	5MT	L	F	Hatchback Engine AZQ/BME	GDS83063	Drive Shaft	36		50.7	58.5	501					
	2002.02-	2006.06	5MT	R	F	Hatchback Engine AZQ/BME	GDS61063	Drive Shaft	36		50.7	58.5	751					
	2002.02-	2008.07					GC083027	Outer Joint	36	30	50.7	58.5	47.5	I				
1.2 12V (51 kW)	2006.07-	2007.07			F	Hatchback Engine BXV	GC083024	Outer Joint	36	30	50.75	59	54.5	I				
	2006.07-	2007.07	AT		F	Hatchback Engine BXV	GC083078	Outer Joint	45W	38	27	59.5	34.5	63	M			
	2006.07-	2007.07		L	F	Hatchback Engine BXV	GDS83063	Drive Shaft	36		50.7	58.5	501					
	2006.07-	2007.07		R	F	Hatchback Engine BXV	GDS61063	Drive Shaft	36		50.7	58.5	751					
1.2 16V (51 kW)	2007.03-	2008.06	AT			GC083078	Outer Joint	45W	38	27	59.5	34.5	63	M				
1.4 16V (55 kW)	2002.02-	2007.12			F	Hatchback Engine BBY/BKY	GCI61005	Inner Joint		30		57.6						
	2002.02-	2007.12	MT		F	Hatchback Engine BBY/BKY	GC083027	Outer Joint	36	30	50.7	58.5	47.5	I				
	2002.02-	2007.12	5MT	L	F	Hatchback Engine BBY/BKY	GDS83063	Drive Shaft	36		50.7	58.5	501					
	2002.02-	2007.12	5AT	R	F	Hatchback Engine BBY/BKY	GDS61252	Drive Shaft	36		53.7	58.5	730					
	2002.02-	2007.12	5AT	R	F	Hatchback Engine BBY/BKY	GCI61005	Inner Joint		30		57.6						
	2002.02-	2007.12	5AT	R	F	Hatchback Engine BBY/BKY	GC061070	Outer Joint	36	30	53.7	58.5	55	I				
	2002.02-	2007.12	5MT	R	F	Hatchback Engine BBY/BKY	GDS61063	Drive Shaft	36		50.7	58.5	751					
2002.02-	2007.12					GC083027	Outer Joint	36	30	50.7	58.5	47.5	I					
1.4 16V (63 kW)	2006.05-	2009.11	AT				GC083078	Outer Joint	45W	38	27	59.5	34.5	63	M			
	2006.12-	2007.07			F	Hatchback Engine BXW	GC083027	Outer Joint	36	30	50.7	58.5	47.5	I				
	2006.12-	2007.07	AT		F	Hatchback Engine BXW	GC083078	Outer Joint	45W	38	27	59.5	34.5	63	M			
	2006.12-	2007.07		L	F	Hatchback Engine BXW	GDS83063	Drive Shaft	36		50.7	58.5	501					
	2006.12-	2007.07		R	F	Hatchback Engine BXW	GDS61063	Drive Shaft	36		50.7	58.5	751					
1.4 16V (74 kW)	2002.02-	2007.12					GC083027	Outer Joint	36	30	50.7	58.5	47.5	I				
	2002.02-	2009.11	MT		F	Hatchback Engine AUB/BBZ	GC083027	Outer Joint	36	30	50.7	58.5	47.5	I				
	2002.02-	2009.11	5MT	L	F	Hatchback Engine AUB/BBZ	GDS83063	Drive Shaft	36		50.7	58.5	501					
	2002.02-	2009.11	5MT	R	F	Hatchback Engine AUB/BBZ	GDS61063	Drive Shaft	36		50.7	58.5	751					
1.4 TDi (51 kW)	2005.05-	2009.11	MT		F	Hatchback Engine BNM	GCI83011	Inner Joint		33		34						
	2005.05-	2009.11	MT		F	Hatchback Engine BNM	GC083024	Outer Joint	36	30	50.75	59	54.5	I				
	2005.05-	2009.11	MT	R	F	Hatchback Engine BNM	GDS61223	Drive Shaft	36		52	59	757					
1.4 TDi (55 kW)	2002.05-	2005.12	MT		F	Hatchback Engine AMF	GC083024	Outer Joint	36	30	50.75	59	54.5	I				
	2002.05-	2005.12	MT/AT		F	Hatchback Engine AMF	GCI61006	Inner Joint		30		57.6						
	2002.05-	2005.12	5MT	L	F	Hatchback Engine AMF	GDS61098	Drive Shaft	36		50.5	59	472					

		TRANSM	L/R	F/R		G-AP Ref.	PRODUCT	ABS	Technical Specifications						
									YEAR	A	B	C	H	L	P
<b>SEAT</b>															
<b>IBIZA IV (6L1)</b>															
1.4 TDi (55 kW)	2002.05-2005.12			L	F	Hatchback Engine AMF	GDS61135	Drive Shaft	36		52	59	475		
	2002.05-2005.12	5MT	R	F	Hatchback Engine AMF	GDS61099	Drive Shaft	36		50.5	59	759			
	2002.05-2005.12		R	F	Hatchback Engine AMF	GDS61136	Drive Shaft	36		52	59	763			
	2002.05-2005.12		R	F	Hatchback Engine AMF	GCI61062	Inner Joint		30		59				
1.4 TDi (59 kW)	2005.06-2009.11	AT					GC083078	Outer Joint	45W	38	27	59.5	34.5	63	M
	2006.02-2007.07	AT		F	Hatchback Engine BMS/BNV	GC083078	Outer Joint	45W	38	27	59.5	34.5	63	M	
	2006.02-2007.07	MT		F	Hatchback Engine BMS/BNV	GC083024	Outer Joint		36	30	50.75	59	54.5	I	
	2006.02-2007.07		L	F	Hatchback Engine BMS/BNV	GDS61098	Drive Shaft		36		50.5	59	472		
	2006.02-2007.07		L	F	Hatchback Engine BMS/BNV	GDS61135	Drive Shaft		36		52	59	475		
	2006.02-2007.07		R	F	Hatchback Engine BMS/BNV	GDS61099	Drive Shaft		36		50.5	59	759		
	2006.02-2007.07		R	F	Hatchback Engine BMS/BNV	GDS61136	Drive Shaft		36		52	59	763		
	2006.02-2007.07		R	F	Hatchback Engine BMS/BNV	GCI61062	Inner Joint		30		59				
1.6 (74 kW)	2003.02-2009.11				F	Hatchback Engine BAH	GC083024	Outer Joint	36	30	50.75	59	54.5	I	
	2003.02-2009.11	MT			F	Hatchback Engine BAH	GCI53002	Inner Joint		33		34			
	2003.02-2009.11	AT			SE		GC061010	Outer Joint	36	30	52	75	54.5	I	
1.6 16V (77 kW)	2006.11-2009.11	MT			F	Hatchback Engine BTS	GCI83011	Inner Joint		33		34			
	2006.11-2009.11	MT			F	Hatchback Engine BTS	GC083024	Outer Joint	36	30	50.75	59	54.5	I	
	2006.11-2009.11	MT	L	F	Hatchback Engine BTS	GDS61263	Drive Shaft		36		52	59	514		
	2006.11-2009.11		L	F	Hatchback Engine BTS	GDS61274	Drive Shaft		36		50.5	59	514		
1.8 T Cupra R (132 kW)	2004.01-2008.02	MT			F	Hatchback Engine BBU	GCI53002	Inner Joint		33		34			
	2004.01-2008.02	MT			F	Hatchback Engine BBU	GC083024	Outer Joint	36	30	50.75	59	54.5	I	
	2004.01-2008.02	5MT	L	F	Hatchback Engine BBU	GDS61098	Drive Shaft		36		50.5	59	472		
	2004.01-2008.02	MT	L	F	Hatchback Engine BBU	GDS61135	Drive Shaft		36		52	59	475		
	2004.01-2008.02	5MT	R	F	Hatchback Engine BBU	GDS61099	Drive Shaft		36		50.5	59	759		
	2004.01-2008.02	MT	R	F	Hatchback Engine BBU	GDS61136	Drive Shaft		36		52	59	763		
	2004.01-2008.02	MT	R	F	Hatchback Engine BBU	GCI61062	Inner Joint		30		59				
	2004.01-2008.02						GC083027	Outer Joint	36	30	50.7	58.5	47.5	I	
1.8 T FR (110 kW)	2003.12-2008.05	MT			F	Hatchback Engine BJX/BKV	GCI83011	Inner Joint		33		34			
	2003.12-2008.05	MT			F	Hatchback Engine BJX/BKV	GC083024	Outer Joint	36	30	50.75	59	54.5	I	
	2003.12-2008.05	5MT	L	F	Hatchback Engine BJX/BKV	GDS61098	Drive Shaft		36		50.5	59	472		
	2003.12-2008.05	MT	L	F	Hatchback Engine BJX/BKV	GDS61135	Drive Shaft		36		52	59	475		
	2003.12-2008.05	5MT	R	F	Hatchback Engine BJX/BKV	GDS61099	Drive Shaft		36		50.5	59	759		
	2003.12-2008.05	MT	R	F	Hatchback Engine BJX/BKV	GDS61136	Drive Shaft		36		52	59	763		
	2003.12-2008.05	MT	R	F	Hatchback Engine BJX/BKV	GCI61062	Inner Joint		30		59				
1.8 TFR (110 kW)	2003.12-2008.05						GC083027	Outer Joint	36	30	50.7	58.5	47.5	I	
1.9 SDi (47 kW)	2002.02-2005.12	MT			F	Hatchback Engine ASY	GC083027	Outer Joint	36	30	50.7	58.5	47.5	I	
	2002.02-2005.12	5MT	L	F	Hatchback Engine ASY	GDS83063	Drive Shaft		36		50.7	58.5	501		
	2002.02-2005.12	5MT	R	F	Hatchback Engine ASY	GDS61063	Drive Shaft		36		50.7	58.5	751		
	2002.02-2005.12						GC083027	Outer Joint	36	30	50.7	58.5	47.5	I	
1.9 TDi (74 kW)	2002.02-2009.11	MT			F	Hatchback Engine ATD/AXR/BMT	GC083024	Outer Joint	36	30	50.75	59	54.5	I	
	2002.02-2009.11	MT/AT			F	Hatchback Engine ATD/AXR/BMT	GCI61006	Inner Joint		30		57.6			
	2002.02-2009.11	5MT	L	F	Hatchback Engine ATD/AXR/BMT	GDS61098	Drive Shaft		36		50.5	59	472		
	2002.02-2009.11		L	F	Hatchback Engine ATD/AXR/BMT	GDS61135	Drive Shaft		36		52	59	475		
	2002.02-2009.11	5MT	R	F	Hatchback Engine ATD/AXR/BMT	GDS61099	Drive Shaft		36		50.5	59	759		
	2002.02-2009.11		R	F	Hatchback Engine ATD/AXR/BMT	GDS61136	Drive Shaft		36		52	59	763		
	2002.02-2009.11		R	F	Hatchback Engine ATD/AXR/BMT	GCI61062	Inner Joint		30		59				
1.9 TDi (96 kW)	2002.02-2009.11	6MT			F	Hatchback Engine ASZ/BLT	GC053002	Outer Joint	36	27	50.75	75	65	I	
	2002.02-2009.11	MT	L	F	Hatchback Engine ASZ/BLT	GDS61204	Drive Shaft		36		50.5	75	461		
	2002.02-2009.11	MT	R	F	Hatchback Engine ASZ/BLT	GDS61183	Drive Shaft		36		50.5	75	769		
1.9 TDi Cupra R (110 kW)	2004.03-2008.02						GC083027	Outer Joint	36	30	50.7	58.5	47.5	I	
1.9 TDi Cupra R (118 kW)	2004.03-2008.02				F	Hatchback Engine BPX/BUK	GC053002	Outer Joint	36	27	50.75	75	65	I	
	2004.03-2008.02	6MT	R	F	Hatchback Engine BPX/BUK	GDS61183	Drive Shaft		36		50.5	75	769		
	2004.03-2008.02	MT					GCI83016	Inner Joint		28		32			
2.0 (85 kW)	2003.05-2004.06				F	Hatchback Engine AZL/BBX	GC083024	Outer Joint	36	30	50.75	59	54.5	I	
<b>IBIZA V (6J1, 6J5, 6J8),ST, SW</b>															
1.2 12V (44 kW)	2008.03-							GC083027	Outer Joint	36	30	50.7	58.5	47.5	I
1.2 12V (51 kW)	2008.03-							GC083027	Outer Joint	36	30	50.7	58.5	47.5	I
1.4 16V (63 kW)	2008.03-							GC083027	Outer Joint	36	30	50.7	58.5	47.5	I
1.4 TDi (59 kW)	2008.07-							GC083027	Outer Joint	36	30	50.7	58.5	47.5	I
1.4 TSi (110 kW)	2009.06-							GCI83016	Inner Joint		28		32		
1.4 TSi (132 kW)	2009.06-							GCI83016	Inner Joint		28		32		









		TRANSM	L/R	F/R		G-AP Ref.	PRODUCT	ABS	Technical Specifications							
									YEAR	A	B	C	H	L	P	
<b>SEAT</b>																
<b>IBIZA V (6J1, 6J5, 6J8),ST, SW</b>																
1.6 16V (77 kW)	2008.05-					GC083027	Outer Joint		36	30	50.7	58.5	47.5	I		
1.9 TDi (66 kW)	2008.03-					GC083027	Outer Joint		36	30	50.7	58.5	47.5	I		
1.9 TDi (77 kW)	2008.03-					GC083027	Outer Joint		36	30	50.7	58.5	47.5	I		
2.0 TDi (105 kW)	2010.01-					GCI83016	Inner Joint			28		32				
<b>IBIZA V (6J5)</b>																
1.2 (44 kW)	2009.07-		L	F	Hatchback Engine CGPB	GDS83330	Drive Shaft		36		50.7	58.5	515			
	2009.07-		R	F	Hatchback Engine CGPB	GDS61267	Drive Shaft		36		50.7	58.5	765			
1.2 (51 kW)	2008.03-		L	F	Hatchback Engine BZG/CGPA/CJLB	GDS83330	Drive Shaft		36		50.7	58.5	515			
	2008.03-		R	F	Hatchback Engine BZG/CGPA/CJLB	GDS61267	Drive Shaft		36		50.7	58.5	765			
1.2 TSi (63 kW)	2012.08-		MT	L	F	Hatchback Engine CBZA	GDS61263	Drive Shaft	36		52	59	514			
	2012.08-			L	F	Hatchback Engine CBZA	GDS61274	Drive Shaft	36		50.5	59	514			
1.2 TSi (77 kW)	2010.09-		MT	L	F	Hatchback Engine CBZB	GDS61263	Drive Shaft	36		52	59	514			
	2010.09-			L	F	Hatchback Engine CBZB	GDS61274	Drive Shaft	36		50.5	59	514			
1.4 (63 kW)	2008.03-			L	F	Hatchback Engine BXW/CGGB	GDS83330	Drive Shaft	36		50.7	58.5	515			
	2008.03-			R	F	Hatchback Engine BXW/CGGB	GDS61267	Drive Shaft	36		50.7	58.5	765			
1.4 TDi (59 kW)	2008.07-	2010.06			F	Hatchback Engine BMS	GC083024	Outer Joint	36	30	50.75	59	54.5	I		
	2008.07-	2010.06	MT	L	F	Hatchback Engine BMS	GDS61135	Drive Shaft	36		52	59	475			
	2008.07-	2010.06	MT	R	F	Hatchback Engine BMS	GDS61136	Drive Shaft	36		52	59	763			
	2008.07-	2010.06	MT	R	F	Hatchback Engine BMS	GCI61062	Inner Joint		30		59				
1.4 TSi (110 kW)	2009.06-		AT	L	F	Hatchback Engine CAVF/CNUB/CTHF/CTJB	GDS61260	Drive Shaft	36		52	75	498			
	2009.06-		AT	R	F	Hatchback Engine CAVF/CNUB/CTHF/CTJB	GDS61261	Drive Shaft	36		52	75	785			
1.6 (77 kW)	2008.05-				F	Hatchback Engine BTS	GCI83011	Inner Joint		33		34				
	2008.05-		MT		F	Hatchback Engine BTS	GCI53002	Inner Joint		33		34				
	2008.05-		MT	L	F	Hatchback Engine BTS	GDS61263	Drive Shaft	36		52	59	514			
	2008.05-			L	F	Hatchback Engine BTS	GDS61274	Drive Shaft	36		50.5	59	514			
1.6 LPG (60 kW)	2011.05-		MT	L	F	Hatchback Engine CNKA	GDS61263	Drive Shaft	36		52	59	514			
	2011.05-			L	F	Hatchback Engine CNKA	GDS61274	Drive Shaft	36		50.5	59	514			
1.6 TDi (66 kW)	2009.05-		MT	L	F	Hatchback Engine CAYB	GDS61184	Drive Shaft	36		52	59	496			
	2009.05-		MT	L/R	F	Hatchback Engine CAYB	GC054006	Outer Joint	36	30	52	59	55.5	I		
	2009.05-			R	F	Hatchback Engine CAYB	GDS61185	Drive Shaft	36		52	59	785			
1.9 TDi (66 kW)	2008.07-	2010.06			F	Hatchback Engine BXJ	GC083024	Outer Joint	36	30	50.75	59	54.5	I		
	2008.07-	2010.06	MT	L	F	Hatchback Engine BXJ	GDS61184	Drive Shaft	36		52	59	496			
	2008.07-	2010.06	MT	L/R	F	Hatchback Engine BXJ	GC054006	Outer Joint	36	30	52	59	55.5	I		
	2008.07-	2010.06		R	F	Hatchback Engine BXJ	GDS61185	Drive Shaft	36		52	59	785			
1.9 TDi (77 kW)	2008.03-	2010.06			F	Hatchback Engine BLS	GC083024	Outer Joint	36	30	50.75	59	54.5	I		
2.0 (85 kW)	2008.10-		MT	L	F	Hatchback Engine CEKA	GDS61263	Drive Shaft	36		52	59	514			
<b>IBIZA V SPORTCOUPE (6J1)</b>																
1.2 (44 kW)	2009.07-		L	F	Coupe Engine CGPB	GDS83330	Drive Shaft		36		50.7	58.5	515			
	2009.07-		R	F	Coupe Engine CGPB	GDS61267	Drive Shaft		36		50.7	58.5	765			
1.2 (51 kW)	2008.07-		L	F	Coupe Engine BZG/CGPA/CJLB	GDS83330	Drive Shaft		36		50.7	58.5	515			
	2008.07-		R	F	Coupe Engine BZG/CGPA/CJLB	GDS61267	Drive Shaft		36		50.7	58.5	765			
1.2 TSi (63 kW)	2012.08-		MT	L	F	Coupe Engine CBZA	GDS61263	Drive Shaft	36		52	59	514			
	2012.08-			L	F	Coupe Engine CBZA	GDS61274	Drive Shaft	36		50.5	59	514			
1.2 TSi (77 kW)	2010.09-		7AT	L	F	Coupe Engine CBZB	GDS61198	Drive Shaft	36		59.5	40.5	530			
	2010.09-		MT	L	F	Coupe Engine CBZB	GDS61263	Drive Shaft	36		52	59	514			
	2010.09-			L	F	Coupe Engine CBZB	GDS61274	Drive Shaft	36		50.5	59	514			
1.4 (63 kW)	2008.07-			L	F	Coupe Engine BXW/CGGB	GDS83330	Drive Shaft	36		50.7	58.5	515			
	2008.07-			R	F	Coupe Engine BXW/CGGB	GDS61267	Drive Shaft	36		50.7	58.5	765			
1.4 TDi (59 kW)	2008.07-	2010.06		L	F	Coupe Engine BMS	GDS61135	Drive Shaft	36		52	59	475			
	2008.07-	2010.06		R	F	Coupe Engine BMS	GDS61136	Drive Shaft	36		52	59	763			
	2008.07-	2010.06		R	F	Coupe Engine BMS	GCI61062	Inner Joint		30		59				
1.4 TSi (110 kW)	2009.06-		AT	L	F	Coupe Engine CAVF/CNUB/CTHF/CTJB	GDS61260	Drive Shaft	36		52	75	498			
	2009.06-		AT	R	F	Coupe Engine CAVF/CNUB/CTHF/CTJB	GDS61261	Drive Shaft	36		52	75	785			
1.4 TSi Cupra (132 kW)	2009.06-		AT	L	F	Coupe Engine CAVE/CTHE/CTJC	GDS61260	Drive Shaft	36		52	75	498			
	2009.06-		AT	R	F	Coupe Engine CAVE/CTHE/CTJC	GDS61261	Drive Shaft	36		52	75	785			
1.6 (77 kW)	2008.07-				F	Coupe Engine BTS	GCI83011	Inner Joint		33		34				
	2008.07-		MT		F	Coupe Engine BTS	GCI53002	Inner Joint		33		34				
	2008.07-		MT	L	F	Coupe Engine BTS	GDS61263	Drive Shaft	36		52	59	514			
	2008.07-			L	F	Coupe Engine BTS	GDS61274	Drive Shaft	36		50.5	59	514			
1.6 LPG (60 kW)	2011.05-		MT	L	F	Coupe Engine CNKA	GDS61263	Drive Shaft	36		52	59	514			
	2011.05-			L	F	Coupe Engine CNKA	GDS61274	Drive Shaft	36		50.5	59	514			



		TRANSM	L/R	F/R		G-AP Ref.	PRODUCT	ABS	Technical Specifications						
									YEAR	A	B	C	H	L	P
<b>SEAT</b>															
<b>IBIZA V SPORTCOUPE (6J1)</b>															
1.9 TDi (66 kW)	2008.07-	2010.06			F	Coupe Engine BXJ	GC083024	Outer Joint	36	30	50.75	59	54.5	I	
1.9 TDi (77 kW)	2008.07-	2010.06			F	Coupe Engine BLS	GC083024	Outer Joint	36	30	50.75	59	54.5	I	
2.0 (85 kW)	2008.10-				L	F	Coupe Engine CEKA	GDS61263	Drive Shaft	36		52	59	514	
<b>IBIZA V ST (6J8)</b>															
1.2 (44 kW)	2010.05-				L	F	Estate Engine CGPB	GDS83330	Drive Shaft	36		50.7	58.5	515	
	2010.05-				R	F	Estate Engine CGPB	GDS61267	Drive Shaft	36		50.7	58.5	765	
1.2 (51 kW)	2010.05-				L	F	Estate Engine CGPA/BZG/CJLB	GDS83330	Drive Shaft	36		50.7	58.5	515	
	2010.05-				R	F	Estate Engine CGPA/BZG/CJLB	GDS61267	Drive Shaft	36		50.7	58.5	765	
1.2 TSi (63 kW)	2012.09-		MT		L	F	Estate Engine CBZA	GDS61263	Drive Shaft	36		52	59	514	
	2012.09-				L	F	Estate Engine CBZA	GDS61274	Drive Shaft	36		50.5	59	514	
1.2 TSi (77 kW)	2010.09-		MT		L	F	Estate Engine CBZB	GDS61263	Drive Shaft	36		52	59	514	
	2010.09-				L	F	Estate Engine CBZB	GDS61274	Drive Shaft	36		50.5	59	514	
1.4 (63 kW)	2010.03-				L	F	Estate Engine CGGB	GDS83330	Drive Shaft	36		50.7	58.5	515	
	2010.03-				R	F	Estate Engine CGGB	GDS61267	Drive Shaft	36		50.7	58.5	765	
1.4 TSi (110 kW)	2012.02-		AT		L	F	Estate Engine CAVF/CNUB/CTHF/CTJB	GDS61260	Drive Shaft	36		52	75	498	
	2012.02-		AT		R	F	Estate Engine CAVF/CNUB/CTHF/CTJB	GDS61261	Drive Shaft	36		52	75	785	
<b>INCA</b>															
-	1998-						GC099136	Outer Joint	22	30	51	78	61	I	
<b>INCA (6K9)</b>															
1.4 16V (55 kW)	2000.04-	2003.06	MT		F	Box Engine AUA	GC053008	Outer Joint	22	30	53	78.5	51	I	
	2000.04-	2003.06	MT		F	Box Engine AUA	GCI53001	Inner Joint		33		32			
	2000.04-	2003.06	MT	L	F	Box Engine AUA	GDS53004	Drive Shaft	22		50	78.5	562		
1.4 i (44 kW)	1995.11-	2003.06	MT		F	Box Engine AEX/AKV/APQ/AUD	GC053008	Outer Joint	22	30	53	78.5	51	I	
	1995.11-	2003.06	MT		F	Box Engine AEX/AKV/APQ/AUD	GCI53001	Inner Joint		33		32			
	1995.11-	2003.06	MT	L	F	Box Engine AEX/AKV/APQ/AUD	GDS53004	Drive Shaft	22		50	78.5	562		
1.7 D (42 kW)	1996.09-	2003.06	MT		F	Box Engine AHB	GC053008	Outer Joint	22	30	53	78.5	51	I	
	1996.09-	2003.06	MT		F	Box Engine AHB	GCI83004	Inner Joint		33		32			
	1996.09-	2003.06	MT	L	F	Box Engine AHB	GDS53003	Drive Shaft	22		53	78.5	539.5		
	1996.09-	2003.06	MT	R	F	Box Engine AHB	GDS53005	Drive Shaft	22		53	78.5	774		
1.9 D (47 kW)	1995.11-	2003.06	MT		F	Box Engine 1Y	GC053008	Outer Joint	22	30	53	78.5	51	I	
	1995.11-	2003.06	MT		F	Box Engine 1Y	GCI83004	Inner Joint		33		32			
	1995.11-	2003.06	MT	L	F	Box Engine 1Y	GDS53003	Drive Shaft	22		53	78.5	539.5		
	1995.11-	2003.06	MT	R	F	Box Engine 1Y	GDS53005	Drive Shaft	22		53	78.5	774		
1.9 SDi (47 kW)	1995.11-	2003.06	MT		F	Box Engine AEY/AYQ	GC053008	Outer Joint	22	30	53	78.5	51	I	
	1995.11-	2003.06	MT		F	Box Engine AEY/AYQ	GCI83004	Inner Joint		33		32			
	1995.11-	2003.06	MT	L	F	Box Engine AEY/AYQ	GDS53003	Drive Shaft	22		53	78.5	539.5		
	1995.11-	2003.06	MT	R	F	Box Engine AEY/AYQ	GDS53005	Drive Shaft	22		53	78.5	774		
<b>LEON (1M1)</b>															
1.4 16V (55 kW)	1999.11-	2006.06	5MT		F	Hatchback Engine AHW/APE/AUA/AXP/BCA	GCI83008	Inner Joint		33		32			
	1999.11-	2006.06	MT		F	Hatchback Engine AHW/APE/AUA/AXP/BCA	GC083033	Outer Joint	36	30	53	78.5	51	I	
	1999.11-	2006.06	MT	L	F	Hatchback Engine AHW/APE/AUA/AXP/BCA	GDS61045	Drive Shaft	36		53	78.5	555		
	1999.11-	2006.06	MT	R	F	Hatchback Engine AHW/APE/AUA/AXP/BCA	GDS83046	Drive Shaft	36		53	78.5	822		
1.6 (74 kW)	1999.11-	2006.06			F	Hatchback Engine AEH/AKL/APF	GCI83008	Inner Joint		33		32			
	1999.11-	2006.06			F	Hatchback Engine AEH/AKL/APF	GC083036	Outer Joint	36	30	53.2	77.5	61	I	
	1999.11-	2006.06	MT		F	Hatchback Engine AEH/AKL/APF	GCI83011	Inner Joint		33		34			
	1999.11-	2006.06	AT	L	F	Hatchback Engine AEH/AKL/APF	GDS61156	Drive Shaft	36		53	78	554.5		
	1999.11-	2006.06	AT	L	F	Hatchback Engine AEH/AKL/APF	GCI61062	Inner Joint		30		59			
	1999.11-	2006.06	MT	L	F	Hatchback Engine AEH/AKL/APF	GDS61045	Drive Shaft	36		53	78.5	555		
	1999.11-	2006.06	MT	R	F	Hatchback Engine AEH/AKL/APF	GDS83046	Drive Shaft	36		53	78.5	822		
	1999.11-	2006.06			F	Hatchback Engine AEH/AKL/APF	GC083036	Outer Joint	36	30	53.2	77.5	61	I	
1.6 16V (77 kW)	2000.09-	2006.06			F	Hatchback Engine ATN/AUS/AZD/BCB	GC083036	Outer Joint	36	30	53.2	77.5	61	I	
	2000.09-	2006.06	MT	L	F	Hatchback Engine ATN/AUS/AZD/BCB	GDS61202	Drive Shaft	36		53.2	77.5	547		
	2000.09-	2006.06			L	F	Hatchback Engine ATN/AUS/AZD/BCB	GDS61312	Drive Shaft	36		53	78	546	
	2000.09-	2006.06	MT	R	F	Hatchback Engine ATN/AUS/AZD/BCB	GDS61203	Drive Shaft	36		53.2	77.5	810		
1.8 20V (92 kW)	1999.11-	2006.06			F	Hatchback Engine AGN/APG	GC083036	Outer Joint	36	30	53.2	77.5	61	I	
	1999.11-	2006.06	MT		F	Hatchback Engine AGN/APG	GCI83011	Inner Joint		33		34			
	1999.11-	2006.06	AT	L	F	Hatchback Engine AGN/APG	GDS61156	Drive Shaft	36		53	78	554.5		
	1999.11-	2006.06	AT	L	F	Hatchback Engine AGN/APG	GCI61062	Inner Joint		30		59			
	1999.11-	2006.06	MT	L	F	Hatchback Engine AGN/APG	GDS99116	Drive Shaft	36		53.2	77.5	548.5		
1.8 20V T (132 kW)	1999.11-	2006.06			F	Hatchback Engine APP/AUQ	GC083035	Outer Joint	36	27	53	77.5	65	I	
	1999.11-	2006.06	MT		F	Hatchback Engine APP/AUQ	GCI53002	Inner Joint		33		34			
	1999.11-	2006.06	AT	L	F	Hatchback Engine APP/AUQ	GDS61156	Drive Shaft	36		53	78	554.5		

		TRANSM	L/R	F/R		G-AP Ref.	PRODUCT	ABS	Technical Specifications								
									YEAR	A	B	C	H	L	P		
<b>SEAT</b>																	
<b>LEON (1M1)</b>																	
1.8 20V T (132 kW)	1999.11-	2006.06	AT	L	F	Hatchback Engine APP/AUQ	GCI61062	Inner Joint		30		59					
	1999.11-	2006.06	MT	L	F	Hatchback Engine APP/AUQ	GDS61123	Drive Shaft	36		53	77.5	520				
	1999.11-	2006.06	MT	R	F	Hatchback Engine APP/AUQ	GDS61121	Drive Shaft	36		53	77.5	806				
1.8 20V T 4 (132 kW)	1999.11-	2006.06	MT			Hatchback Engine AJQ/ARY	GCI53002	Inner Joint		33		34					
	1999.11-	2006.06			F	Hatchback Engine AJQ/ARY	GC083035	Outer Joint	36	27	53	77.5	65	I			
	1999.11-	2006.06	6MT	L	F	Hatchback Engine AJQ/ARY	GDS61123	Drive Shaft	36		53	77.5	520				
	1999.11-	2006.06		R	F	Hatchback Engine AJQ/ARY	GDS61186	Drive Shaft	36		53	77.5	653				
	1999.11-	2006.06		R	F	Hatchback Engine AJQ/ARY	GCI61002	Inner Joint		28		31.8					
	1999.11-	2006.06		R	F	Hatchback Engine AJQ/ARY	GC083035	Outer Joint	36	27	53	77.5	65	I			
	1999.11-	2006.06	MT		R	Hatchback Engine AJQ/ARY	GCI83011	Inner Joint		33		34					
1.8 T Cupra R (154 kW)	2002.02-	2006.06			F	Hatchback Engine AMK	GC083035	Outer Joint	36	27	53	77.5	65	I			
	2002.02-	2006.06	6MT	L	F	Hatchback Engine AMK	GDS61123	Drive Shaft	36		53	77.5	520				
	2002.02-	2006.06	6MT	R	F	Hatchback Engine AMK	GDS61121	Drive Shaft	36		53	77.5	806				
1.8 T Cupra R (165 kW)	2003.07-	2006.06		R	F	Hatchback Engine BAM	GDS53010	Drive Shaft	36		59.5	40	768				
1.9 SDi (50 kW)	1999.11-	2006.06	5MT		F	Hatchback Engine AQM	GC083033	Outer Joint	36	30	53	78.5	51	I			
	1999.11-	2006.06	5MT		F	Hatchback Engine AQM	GCI83008	Inner Joint		33		32					
	1999.11-	2006.06		L	F	Hatchback Engine AQM	GDS61045	Drive Shaft	36		53	78.5	555				
	1999.11-	2006.06		R	F	Hatchback Engine AQM	GDS83046	Drive Shaft	36		53	78.5	822				
1.9 TDi (110 kW)	2001.02-	2006.06			F	Hatchback Engine ARL	GC083035	Outer Joint	36	27	53	77.5	65	I			
	2001.02-	2006.06	MT		F	Hatchback Engine ARL	GCI53002	Inner Joint		33		34					
	2001.02-	2006.06		L	F	Hatchback Engine ARL	GDS61123	Drive Shaft	36		53	77.5	520				
	2001.02-	2006.06		R	F	Hatchback Engine ARL	GDS61121	Drive Shaft	36		53	77.5	806				
1.9 TDi (66 kW)	1999.11-	2006.06			F	Hatchback Engine AGR/ALH	GC083036	Outer Joint	36	30	53.2	77.5	61	I			
	1999.11-	2006.06	MT	L	F	Hatchback Engine AGR/ALH	GDS61021	Drive Shaft	36		53.2	77.5	564.5				
	1999.11-	2006.06	MT	L	F	Hatchback Engine AGR/ALH	GDS83006	Drive Shaft	36		53.2	77.5	557				
	1999.11-	2006.06	MT	R	F	Hatchback Engine AGR/ALH	GDS83004	Drive Shaft	36		53.2	77.5	822				
1.9 TDi (74 kW)	2005.10-	2006.06	MT		F	Hatchback Engine AXR	GCI83011	Inner Joint		33		34					
	2005.10-	2006.06		L	F	Hatchback Engine AXR	GDS83006	Drive Shaft	36		53.2	77.5	557				
	2005.10-	2006.06	MT	L	F	Hatchback Engine AXR	GDS61089	Drive Shaft	36		59.5	40.5	521				
	2005.10-	2006.06		R	F	Hatchback Engine AXR	GDS83004	Drive Shaft	36		53.2	77.5	822				
1.9 TDi (81 kW)	1999.11-	2006.06			F	Hatchback Engine AHF/ASV	GC083036	Outer Joint	36	30	53.2	77.5	61	I			
	1999.11-	2006.06	MT		F	Hatchback Engine AHF/ASV	GCI83009	Inner Joint		33		34					
	1999.11-	2006.06	MT	L	F	Hatchback Engine AHF/ASV	GDS61021	Drive Shaft	36		53.2	77.5	564.5				
	1999.11-	2006.06	MT	L	F	Hatchback Engine AHF/ASV	GDS83006	Drive Shaft	36		53.2	77.5	557				
	1999.11-	2006.06	MT	R	F	Hatchback Engine AHF/ASV	GDS83004	Drive Shaft	36		53.2	77.5	822				
1.9 TDi (96 kW)	2003.05-	2006.06			F	Hatchback Engine ASZ	GC083035	Outer Joint	36	27	53	77.5	65	I			
	2003.05-	2006.06	6MT	L	F	Hatchback Engine ASZ	GDS61123	Drive Shaft	36		53	77.5	520				
	2003.05-	2006.06		R	F	Hatchback Engine ASZ	GDS61121	Drive Shaft	36		53	77.5	806				
1.9 TDi Syncro (110 kW)	2002.05-	2006.06	MT			Hatchback Engine ARL	GCI53002	Inner Joint		33		34					
	2002.05-	2006.06		L	F	Hatchback Engine ARL	GDS61123	Drive Shaft	36		53	77.5	520				
	2002.05-	2006.06		R	F	Hatchback Engine ARL	GDS61186	Drive Shaft	36		53	77.5	653				
	2002.05-	2006.06		R	F	Hatchback Engine ARL	GCI61002	Inner Joint		28		31.8					
	2002.05-	2006.06		R	F	Hatchback Engine ARL	GC083035	Outer Joint	36	27	53	77.5	65	I			
2.8 Cupra 4 (150 kW)	2002.05-	2006.06	MT		R	Hatchback Engine ARL	GCI83011	Inner Joint		33		34					
	2001.02-	2006.06	MT			Hatchback Engine AUE	GCI53002	Inner Joint		33		34					
	2001.02-	2006.06			F	Hatchback Engine AUE	GC083035	Outer Joint	36	27	53	77.5	65	I			
	2001.02-	2006.06	6MT	L	F	Hatchback Engine AUE	GDS61123	Drive Shaft	36		53	77.5	520				
	2001.02-	2006.06		R	F	Hatchback Engine AUE	GDS61186	Drive Shaft	36		53	77.5	653				
	2001.02-	2006.06		R	F	Hatchback Engine AUE	GCI61002	Inner Joint		28		31.8					
	2001.02-	2006.06		R	F	Hatchback Engine AUE	GC083035	Outer Joint	36	27	53	77.5	65	I			
2001.02-	2006.06	MT		R	Hatchback Engine AUE	GCI83011	Inner Joint		33		34						
<b>LEON (1P1)</b>																	
1.2 TSi (77 kW)	2010.02-		MT	L	F	Hatchback Engine CBZB	GDS61198	Drive Shaft	36		59.5	40.5	530				
1.4 16V (63 kW)	2006.06-		MT		F	Hatchback Engine BXW/CGGB	GCI53002	Inner Joint		33		34					
	2006.06-		MT	L	F	Hatchback Engine BXW/CGGB	GDS53007	Drive Shaft	36		59.5	40	559				
1.4 TSi (92 kW)	2007.11-				F	Hatchback Engine CAXC	GCI83011	Inner Joint		33		34					
	2007.11-		MT	L	F	Hatchback Engine CAXC	GDS61198	Drive Shaft	36		59.5	40.5	530				
1.6 (75 kW)	2005.07-		MT		F	Hatchback Engine BSE/BSF/CCSA/CMXA	GCI83011	Inner Joint		33		34					
	2005.07-			L	F	Hatchback Engine BSE/BSF/CCSA/CMXA	GDS83320	Drive Shaft	36		59.5	40	546				
	2005.07-		MT	L	F	Hatchback Engine BSE/BSF/CCSA/CMXA	GDS61089	Drive Shaft	36		59.5	40.5	521				
	2005.07-				F	Hatchback Engine BSE/BSF/CCSA/CMXA	GC083037	Outer Joint	36	30	59.5	40.5	55	I			









		TRANSM	L/R	F/R		G-AP Ref.	PRODUCT	ABS	Technical Specifications									
									YEAR	A	B	C	H	L	P			
<b>SEAT LEON (1P1)</b>																		
1.6 LPG (75 kW)	2009.12-		L	F	Hatchback Engine CHGA	GDS83320	Drive Shaft		36		59.5	40	546					
1.6 TDi (66 kW)	2010.11-	MT	L	F	Hatchback Engine CAYB	GDS61089	Drive Shaft		36		59.5	40.5	521					
1.6 TDi (77 kW)	2010.02-	MT	L	F	Hatchback Engine CAYC	GDS83294	Drive Shaft		36		59.5	38	519					
	2010.02-	5MT	L	F	Hatchback Engine CAYC	GDS61089	Drive Shaft		36		59.5	40.5	521					
	2010.02-	AT	R	F	Hatchback Engine CAYC	GDS61280	Drive Shaft		36		59.5	40	801					
	2010.02-	AT			Hatchback Engine CAYC	GC083100	Outer Joint		36	33	59.5	38	55	I				
	2010.02-				Hatchback Engine CAYC	GC061059	Outer Joint		36	33	59.5	40	59.5	I				
1.8 TSi (118 kW)	2007.06-			F	Hatchback Engine BZB/CDA	GC083002	Outer Joint		36	27	59.5	40	66	I				
	2007.06-	MT	L	F	Hatchback Engine BZB/CDA	GDS61131	Drive Shaft		36		59.5	40	515					
	2007.06-				Hatchback Engine BZB/CDA	GC061059	Outer Joint		36	33	59.5	40	59.5	I				
1.9 TDi (66 kW)	2007.06-	MT	L	F	Hatchback Engine BXF	GDS83294	Drive Shaft		36		59.5	38	519					
	2007.06-	MT	L	F	Hatchback Engine BXF	GDS61089	Drive Shaft		36		59.5	40.5	521					
1.9 TDi (77 kW)	2005.07-			F	Hatchback Engine BKC/BLS/BXE	GC083037	Outer Joint		36	30	59.5	40.5	55	I				
	2005.07-	AT		F	Hatchback Engine BKC/BLS/BXE	GC083002	Outer Joint		36	27	59.5	40	66	I				
	2005.07-	MT		F	Hatchback Engine BKC/BLS/BXE	GCI83011	Inner Joint			33		34						
	2005.07-	AT	L	F	Hatchback Engine BKC/BLS/BXE	GDS54013	Drive Shaft		36		59.5	40	479.5					
	2005.07-	MT	L	F	Hatchback Engine BKC/BLS/BXE	GDS83294	Drive Shaft		36		59.5	38	519					
	2005.07-	AT	R	F	Hatchback Engine BKC/BLS/BXE	GDS54011	Drive Shaft		36		59.5	40	755					
	2005.07-	MT	R	F	Hatchback Engine BKC/BLS/BXE	GDS61042	Drive Shaft		36		59.5	40.5	814					
	2005.07-	MT	L	F	Hatchback Engine BKC/BLS/BXE	GDS61089	Drive Shaft		36		59.5	40.5	521					
	2005.07-	AT	L/R	F	Hatchback Engine BKC/BLS/BXE	GCI61057	Inner Joint			34		86						
	2005.07-	AT	R	F	Hatchback Engine BKC/BLS/BXE	GDS83355	Drive Shaft		36	23	59.5	40	799					
2.0 Cupra R (195 kW)	2009.09-			F	Hatchback Engine CDLA	GC083002	Outer Joint		36	27	59.5	40	66	I				
	2009.09-		SEMI-AT	L	F	Hatchback Engine CDLA	GDS83236	Drive Shaft		36		59.5	40	484				
	2009.09-	MT	R	F	Hatchback Engine CDLA	GDS61126	Drive Shaft		36		59.5	40	793					
2.0 FSi (110 kW)	2005.07-2010.05	6AT		F	Hatchback Engine BLR/BLY/BVY/BVZ	GCI61011	Inner Joint		26	32	31	68.5	85					
	2005.07-2010.05	MT		F	Hatchback Engine BLR/BLY/BVY/BVZ	GCI83011	Inner Joint			33		34						
	2005.07-2010.05	MT		F	Hatchback Engine BLR/BLY/BVY/BVZ	GC083037	Outer Joint		36	30	59.5	40.5	55	I				
	2005.07-2010.05	6AT	L	F	Hatchback Engine BLR/BLY/BVY/BVZ	GDS61093	Drive Shaft		36	26	59.5	40.5	587.5					
	2005.07-2010.05	MT	L	F	Hatchback Engine BLR/BLY/BVY/BVZ	GDS61089	Drive Shaft		36		59.5	40.5	521					
	2005.07-2010.05	6AT	R	F	Hatchback Engine BLR/BLY/BVY/BVZ	GDS61094	Drive Shaft		36	26	59.5	40.5	884					
	2005.07-2010.05	MT	R	F	Hatchback Engine BLR/BLY/BVY/BVZ	GDS61113	Drive Shaft		36		59.5	40	814					
2.0 TDi (100 kW)	2005.07-2010.05			F	Hatchback Engine AZV	GC083002	Outer Joint		36	27	59.5	40	66	I				
	2005.07-2010.05	6AT		F	Hatchback Engine AZV	GCI54004	Inner Joint			34		85						
	2005.07-2010.05	AT	L	F	Hatchback Engine AZV	GDS83241	Drive Shaft		36		59.5	40	475					
	2005.07-2010.05	AT	L	F	Hatchback Engine AZV	GDS54013	Drive Shaft		36		59.5	40	479.5					
	2005.07-2010.05	MT	L	F	Hatchback Engine AZV	GDS83236	Drive Shaft		36		59.5	40	484					
	2005.07-2010.05	MT	L	F	Hatchback Engine AZV	GDS83295	Drive Shaft		36		59.5	40	491					
	2005.07-2010.05	AT	L/R	F	Hatchback Engine AZV	GCI61057	Inner Joint			34		86						
	2005.07-2010.05	AT	R	F	Hatchback Engine AZV	GDS83355	Drive Shaft		36	23	59.5	40	799					
	2005.07-2010.05	AT	R	F	Hatchback Engine AZV	GDS54011	Drive Shaft		36		59.5	40	755					
	2005.07-2010.05	MT	R	F	Hatchback Engine AZV	GDS61126	Drive Shaft		36		59.5	40	793					
2.0 TDi (103 kW)	2005.10-	6AT		F	Hatchback Engine BMM	GCI54004	Inner Joint			34		85						
	2005.10-	MT		F	Hatchback Engine BMM	GC083002	Outer Joint		36	27	59.5	40	66	I				
	2005.10-	MT	L	F	Hatchback Engine BMM	GDS83295	Drive Shaft		36		59.5	40	491					
	2005.10-	Semi-AT	L	F	Hatchback Engine BMM	GDS54013	Drive Shaft		36		59.5	40	479.5					
	2005.10-	MT	R	F	Hatchback Engine BMM	GDS83313	Drive Shaft		36		59.5	40	792					
	2005.10-	Semi-AT	R	F	Hatchback Engine BMM	GDS54011	Drive Shaft		36		59.5	40	755					
	2005.10-	AT	L	F	Hatchback Engine BMM	GDS83241	Drive Shaft		36		59.5	40	475					
	2005.10-	MT	L	F	Hatchback Engine BMM	GDS83236	Drive Shaft		36		59.5	40	484					
	2005.10-	AT	L/R	F	Hatchback Engine BMM	GCI61057	Inner Joint			34		86						
	2005.10-	AT	R	F	Hatchback Engine BMM	GDS83355	Drive Shaft		36	23	59.5	40	799					
2.0 TDi (125 kW)	2006.06-2007.07			F	Hatchback Engine BMN/CEGA/CFJA	GC061045	Outer Joint		36	27	59.5	40	65	M				
	2006.06-2007.07	MT	L	F	Hatchback Engine BMN/CEGA/CFJA	GDS83236	Drive Shaft		36		59.5	40	484					
	2006.06-2007.07	MT	L	F	Hatchback Engine BMN/CEGA/CFJA	GCI83016	Inner Joint			28		32						
	2006.06-2007.07	MT	L	F	Hatchback Engine BMN/CEGA/CFJA	GDS83265	Drive Shaft		36		59.5	40	487					
	2006.06-2007.07	MT	R	F	Hatchback Engine BMN/CEGA/CFJA	GDS61126	Drive Shaft		36		59.5	40	793					
2.0 TDi 16V (103 kW)	2005.07-			F	Hatchback Engine BKD/CFHC/CLCB	GC083002	Outer Joint		36	27	59.5	40	66	I				
	2005.07-	6AT		F	Hatchback Engine BKD/CFHC/CLCB	GCI54004	Inner Joint			34		85						



		TRANSM	L/R	F/R		G-AP Ref.	PRODUCT	ABS	Technical Specifications									
									YEAR	A	B	C	H	L	P			
<b>SEAT</b>																		
<b>LEON (1P1)</b>																		
2.0 TDi 16V (103 kW)	2005.07-		AT	L	F	Hatchback Engine BKD/CFHC/CLCB	GDS54013	Drive Shaft	36		59.5	40	479.5					
	2005.07-		MT	L	F	Hatchback Engine BKD/CFHC/CLCB	GDS83295	Drive Shaft	36		59.5	40	491					
	2005.07-		AT	R	F	Hatchback Engine BKD/CFHC/CLCB	GDS54011	Drive Shaft	36		59.5	40	755					
	2005.07-		MT	R	F	Hatchback Engine BKD/CFHC/CLCB	GDS83313	Drive Shaft	36		59.5	40	792					
	2005.07-		AT	L	F	Hatchback Engine BKD/CFHC/CLCB	GDS83241	Drive Shaft	36		59.5	40	475					
	2005.07-		MT	L	F	Hatchback Engine BKD/CFHC/CLCB	GDS83236	Drive Shaft	36		59.5	40	484					
	2005.07-		AT	L/R	F	Hatchback Engine BKD/CFHC/CLCB	GCI61057	Inner Joint		34		86						
	2005.07-		AT	R	F	Hatchback Engine BKD/CFHC/CLCB	GDS83355	Drive Shaft	36	23	59.5	40	799					
	2005.07-		MT	R	F	Hatchback Engine BKD/CFHC/CLCB	GDS61126	Drive Shaft	36		59.5	40	793					
2.0 TFSi (136 kW)	2005.10-2006.05				F	Hatchback Engine BWA1	GC083002	Outer Joint	36	27	59.5	40	66	I				
	2005.10-2006.05	MT	L	F	Hatchback Engine BWA1	GDS83236	Drive Shaft	36		59.5	40	484						
	2005.10-2006.05	MT	R	F	Hatchback Engine BWA1	GDS61126	Drive Shaft	36		59.5	40	793						
2.0 TFSi (147 kW)	2005.05-2009.03	MT		F	Hatchback Engine BWA	GC083002	Outer Joint	36	27	59.5	40	66	I					
	2005.05-2009.03		L	F	Hatchback Engine BWA	GDS83236	Drive Shaft	36		59.5	40	484						
	2005.05-2009.03	AT	R	F	Hatchback Engine BWA	GDS83349	Drive Shaft	36		59.5	40	784						
	2005.05-2009.03		R	F	Hatchback Engine BWA	GDS61126	Drive Shaft	36		59.5	40	793						
2.0 TFSi (155 kW)	2009.06-			F	Hatchback Engine CCZB	GC083002	Outer Joint	36	27	59.5	40	66	I					
	2009.06-	MT/S-AT	L	F	Hatchback Engine CCZB	GDS83236	Drive Shaft	36		59.5	40	484						
	2009.06-	MT	R	F	Hatchback Engine CCZB	GDS61126	Drive Shaft	36		59.5	40	793						
	2009.06-	Semi-AT	R	F	Hatchback Engine CCZB	GDS83349	Drive Shaft	36		59.5	40	784						
2.0 TFSi (177 kW)	2006.11-2007.07	MT		F	Hatchback Engine BWJ/CDLD	GC083002	Outer Joint	36	27	59.5	40	66	I					
	2006.11-2007.07	MT	L	F	Hatchback Engine BWJ/CDLD	GDS83236	Drive Shaft	36		59.5	40	484						
	2006.11-2007.07	MT	R	F	Hatchback Engine BWJ/CDLD	GDS61126	Drive Shaft	36		59.5	40	793						
<b>LEON (5F1)</b>																		
1.2 TSi (63 kW)	2012.12-		L	F	Hatchback Engine CJZB	GDS83373	Drive Shaft	36		59.5	38	511						
1.2 TSi (77 kW)	2013.01-	MT	L	F	Hatchback Engine CJZA	GDS61198	Drive Shaft	36		59.5	40.5	530						
	2013.01-		L	F	Hatchback Engine CJZA	GDS83373	Drive Shaft	36		59.5	38	511						
	2013.01-	AT	R	F	Hatchback Engine CJZA	GDS61199	Drive Shaft	36		59.5	40.5	800						
	2013.01-	AT			Hatchback Engine CJZA	GC083100	Outer Joint	36	33	59.5	38	55	I					
	2013.01-				Hatchback Engine CJZA	GC061059	Outer Joint	36	33	59.5	40	59.5	I					
1.4 TSi (103 kW)	2012.09-	AT	L	F	Hatchback Engine CHPA/CPTA	GDS61304	Drive Shaft	36		59.5	40	511						
	2012.09-	AT	R	F	Hatchback Engine CHPA/CPTA	GDS61303	Drive Shaft	36		59.5	40	795						
	2012.09-	MT	R	F	Hatchback Engine CHPA/CPTA	GDS61283	Drive Shaft	36		59.5	40	815						
	2012.09-	MT			Hatchback Engine CHPA/CPTA	GC083100	Outer Joint	36	33	59.5	38	55	I					
	2012.09-				Hatchback Engine CHPA/CPTA	GC083101	Outer Joint	36	27	59.5	40	65	M					
1.4 TSi (110 kW)	2014.05-	AT	L	F	Hatchback Engine CZEA	GDS61304	Drive Shaft	36		59.5	40	511						
	2014.05-	AT	R	F	Hatchback Engine CZEA	GDS61303	Drive Shaft	36		59.5	40	795						
	2014.05-	MT			Hatchback Engine CZEA	GC083100	Outer Joint	36	33	59.5	38	55	I					
	2014.05-				Hatchback Engine CZEA	GC083101	Outer Joint	36	27	59.5	40	65	M					
1.4 TSi (90 kW)	2012.11-	MT			Hatchback Engine CMBA/CXSA	GC083100	Outer Joint	36	33	59.5	38	55	I					
	2012.11-				Hatchback Engine CMBA/CXSA	GC061059	Outer Joint	36	33	59.5	40	59.5	I					
1.6 TDi (66 kW)	2012.11-		L	F	Hatchback Engine CLHB	GDS61089	Drive Shaft	36		59.5	40.5	521						
1.6 TDi (77 kW)	2012.11-		R	F	Hatchback Engine CLHA	GDS61200	Drive Shaft	36		59.5	40.5	820						
	2012.11-	MT			Hatchback Engine CLHA	GC083100	Outer Joint	36	33	59.5	38	55	I					
	2012.11-				Hatchback Engine CLHA	GC061059	Outer Joint	36	33	59.5	40	59.5	I					
1.6 TDi (81 kW)	2013.09-				Hatchback Engine CRKB	GC061059	Outer Joint	36	33	59.5	40	59.5	I					
1.8 TSi (132 kW)	2013.02-	MT	L	F	Hatchback Engine CJSA	GDS61304	Drive Shaft	36		59.5	40	511						
	2013.02-				Hatchback Engine CJSA	GC083101	Outer Joint	36	27	59.5	40	65	M					
2.0 TDi (105 kW)	2013.05-				Hatchback Engine CRVC	GC061059	Outer Joint	36	33	59.5	40	59.5	I					
2.0 TDi (81 kW)	2013.05-				Hatchback Engine CRVA	GC061059	Outer Joint	36	33	59.5	40	59.5	I					
<b>LEON II (1P1)</b>																		
1.2 TSi (77 kW)	2010.02-					GC083037	Outer Joint	36	30	59.5	40.5	55	I					
1.4 16V (55 kW)	2006.06-					GC053001	Outer Joint	36	30	59.5	40	49	I					
1.4 16V (63 kW)	2006.06-					GC083037	Outer Joint	36	30	59.5	40.5	55	I					
1.4 TSi (92 kW)	2007.11-					GC083037	Outer Joint	36	30	59.5	40.5	55	I					
1.6 (75 kW)	2005.07-					GC083037	Outer Joint	36	30	59.5	40.5	55	I					
1.6 LPG (75 kW)	2009.12-					GC083037	Outer Joint	36	30	59.5	40.5	55	I					
1.6 TDi (66 kW)	2010.02-					GC083037	Outer Joint	36	30	59.5	40.5	55	I					
1.6 TDi (77 kW)	2010.02-				DOUBLE CLUTCH	GCI83016	Inner Joint		28		32							
	2010.02-					GC083002	Outer Joint	36	27	59.5	40	66	I					
1.8 TSi 16V (118 kW)	2007.06-					GC083002	Outer Joint	36	27	59.5	40	66	I					

		TRANSM	L/R	F/R		G-AP Ref.	PRODUCT	ABS	Technical Specifications					
									YEAR	A	B	C	H	L
<b>SEAT</b>														
<b>LEON II (1P1)</b>														
1.8 TSi 16V (118 kW)	2008.11-				DOUBLE CLUTCH	GCI83016	Inner Joint		28		32			
1.9 TDi (66 kW)	2005.07-					GC083037	Outer Joint	36	30	59.5	40.5	55	I	
1.9 TDi (77 kW)	2005.07-					GC083037	Outer Joint	36	30	59.5	40.5	55	I	
2.0 FSi (110 kW)	2005.07-2010.05	MT				GC083037	Outer Joint	36	30	59.5	40.5	55	I	
	2005.07-2010.05	MT				GC083002	Outer Joint	36	27	59.5	40	66	I	
2.0 TDi (100 kW)	2005.07-2010.05	MT				GC083002	Outer Joint	36	27	59.5	40	66	I	
	2005.07-2010.05	MT/AT				GCI83016	Inner Joint		28		32			
2.0 TDi (103 kW)	2005.07-2010.05	MT				GC083002	Outer Joint	36	27	59.5	40	66	I	
	2005.07-2010.05	MT/AT				GCI83016	Inner Joint		28		32			
2.0 TDi (125 kW)	2005.07-2010.05	MT				GC083002	Outer Joint	36	27	59.5	40	66	I	
	2005.07-2010.05	MT/AT				GCI83016	Inner Joint		28		32			
2.0 TFSi (136 kW)	2005.05-2009.06	MT				GC083002	Outer Joint	36	27	59.5	40	66	I	
2.0 TFSi (147 kW)	2009.06-	MT				GC083002	Outer Joint	36	27	59.5	40	66	I	
2.0 TFSi (155 kW)	2009.06-	MT				GC083002	Outer Joint	36	27	59.5	40	66	I	
2.0 TFSi Cupra (177 kW)	2006.11-					GC083002	Outer Joint	36	27	59.5	40	66	I	
2.0 TSi (147 kW)	2005.05-2009.03					GCI83016	Inner Joint		28		32			
2.0 TSi (155 kW)	2009.09-					GC083002	Outer Joint	36	27	59.5	40	66	I	
2.0 TSi (195 kW)	2009.09-					GC083002	Outer Joint	36	27	59.5	40	66	I	
2.0 TSi Cupra (177 kW)	2006.11-					GCI83016	Inner Joint		28		32			
<b>LEON III (5F1, 5F5) , SC</b>														
1.2 TSi (63 kW)	2013.01-					GC083037	Outer Joint	36	30	59.5	40.5	55	I	
1.2 TSi (77 kW)	2013.01-	MT				GC083037	Outer Joint	36	30	59.5	40.5	55	I	
1.6 TDi (66 kW)	2012.11-					GC083037	Outer Joint	36	30	59.5	40.5	55	I	
1.8 TSi (132 kW)	2013.02-	MT			DOUBLE CLUTCH	GCI83016	Inner Joint		28		32			
2.0 TDi (110 kW)	2012.10-2013.02	MT				GCI83016	Inner Joint		28		32			
2.0 TDi (135 kW)	2012.10-2013.02	MT				GCI83016	Inner Joint		28		32			
<b>LEON SC (5F5)</b>														
1.2 TSi (63 kW)	2013.01-		L	F	Coupe Engine CJZB	GDS83373	Drive Shaft	36		59.5	38	511		
1.2 TSi (77 kW)	2013.02-	MT	L	F	Coupe Engine CJZA	GDS61198	Drive Shaft	36		59.5	40.5	530		
	2013.02-		L	F	Coupe Engine CJZA	GDS83373	Drive Shaft	36		59.5	38	511		
	2013.02-	AT	R	F	Coupe Engine CJZA	GDS61199	Drive Shaft	36		59.5	40.5	800		
	2013.02-	AT			Coupe Engine CJZA	GC083100	Outer Joint	36	33	59.5	38	55	I	
	2013.02-				Coupe Engine CJZA	GC061059	Outer Joint	36	33	59.5	40	59.5	I	
	2013.02-				Coupe Engine CJZA	GC061059	Outer Joint	36	33	59.5	40	59.5	I	
1.4 TSi (103 kW)	2013.02-	AT	L	F	Coupe Engine CHPA/CPTA	GDS61304	Drive Shaft	36		59.5	40	511		
	2013.02-	AT	R	F	Coupe Engine CHPA/CPTA	GDS61303	Drive Shaft	36		59.5	40	795		
	2013.02-	MT	R	F	Coupe Engine CHPA/CPTA	GDS61283	Drive Shaft	36		59.5	40	815		
	2013.02-	AT			Coupe Engine CHPA/CPTA	GC083101	Outer Joint	36	27	59.5	40	65	M	
	2013.02-	MT			Coupe Engine CHPA/CPTA	GC083100	Outer Joint	36	33	59.5	38	55	I	
	2013.02-				Coupe Engine CHPA/CPTA	GC061059	Outer Joint	36	33	59.5	40	59.5	I	
1.4 TSi (90 kW)	2013.02-	MT			Coupe Engine CMBA/CXSA	GC083100	Outer Joint	36	33	59.5	38	55	I	
	2013.02-				Coupe Engine CMBA/CXSA	GC061059	Outer Joint	36	33	59.5	40	59.5	I	
1.6 TDi (66 kW)	2013.02-		L	F	Coupe Engine CLHB	GDS61089	Drive Shaft	36		59.5	40.5	521		
1.6 TDi (77 kW)	2013.02-	MT	R	F	Coupe Engine CLHA	GDS61200	Drive Shaft	36		59.5	40.5	820		
	2013.02-	MT			Coupe Engine CLHA	GC083100	Outer Joint	36	33	59.5	38	55	I	
	2013.02-				Coupe Engine CLHA	GC061059	Outer Joint	36	33	59.5	40	59.5	I	
1.6 TDi (81 kW)	2013.09-				Coupe Engine CRKB	GC061059	Outer Joint	36	33	59.5	40	59.5	I	
1.8 TSi (132 kW)	2013.02-	MT	L	F	Coupe Engine CJSA	GDS61304	Drive Shaft	36		59.5	40	511		
	2013.02-				Coupe Engine CJSA	GC083101	Outer Joint	36	27	59.5	40	65	M	
2.0 TDi (105 kW)	2013.05-				Coupe Engine CRVC	GC061059	Outer Joint	36	33	59.5	40	59.5	I	
<b>LEON ST (5F8)</b>														
1.2 TSi (77 kW)	2013.08-	MT	L	F	Estate Engine CJZA	GDS83373	Drive Shaft	36		59.5	38	511		
	2013.08-				Estate Engine CJZA	GC061059	Outer Joint	36	33	59.5	40	59.5	I	
1.2 TSi (81 kW)	2014.05-	MT	L	F	Estate Engine CYVB	GDS61268	Drive Shaft	36		59.5	40	516		
1.4 TSi (103 kW)	2013.10-	AT	L	F	Estate Engine CHPA/CPTA	GDS61304	Drive Shaft	36		59.5	40	511		
	2013.10-	AT	R	F	Estate Engine CHPA/CPTA	GDS61303	Drive Shaft	36		59.5	40	795		
	2013.10-	MT	R	F	Estate Engine CHPA/CPTA	GDS61283	Drive Shaft	36		59.5	40	815		
	2013.10-	MT			Estate Engine CHPA/CPTA	GC083100	Outer Joint	36	33	59.5	38	55	I	
	2013.10-				Estate Engine CHPA/CPTA	GC083101	Outer Joint	36	27	59.5	40	65	M	
1.4 TSi (90 kW)	2013.10-	MT			Estate Engine CMBA/CXSA	GC083100	Outer Joint	36	33	59.5	38	55	I	
	2013.10-				Estate Engine CMBA/CXSA	GC061059	Outer Joint	36	33	59.5	40	59.5	I	









		TRANSM	L/R	F/R		G-AP Ref.	PRODUCT	ABS	Technical Specifications								
									YEAR	A	B	C	H	L	P		
<b>SEAT</b>																	
<b>LEON ST (5F8)</b>																	
1.6 TDi (66 kW)	2013.11-		L	F	Estate Engine CLHB	GDS61089	Drive Shaft	36		59.5	40.5	521					
1.6 TDi (77 kW)	2013.10-	MT	R	F	Estate Engine CLHA	GDS61200	Drive Shaft	36		59.5	40.5	820					
	2013.10-	MT			Estate Engine CLHA	GC083100	Outer Joint	36	33	59.5	38	55	I				
	2013.10-				Estate Engine CLHA	GC061059	Outer Joint	36	33	59.5	40	59.5	I				
1.8 TSi (132 kW)	2013.10-	MT	L	F	Estate Engine CJSA	GDS61304	Drive Shaft	36		59.5	40	511					
	2013.10-				Estate Engine CJSA	GC083101	Outer Joint	36	27	59.5	40	65	M				
2.0 TDi (105 kW)	2013.10-				Estate Engine CRVC	GC061059	Outer Joint	36	33	59.5	40	59.5	I				
<b>MII (KF1_)</b>																	
1.0 (44 kW)	2011.10-		L	F	Hatchback Engine CHYA	GDS50567	Drive Shaft	22	28	46	78	650					
	2011.10-		L/R	F	Hatchback Engine CHYA	GC050170	Outer Joint	22	26	46	78	53	M				
	2011.10-		R	F	Hatchback Engine CHYA	GDS50543	Drive Shaft	22	28	46	78	814					
1.0 (55 kW)	2011.10-		L	F	Hatchback Engine CHYB	GDS50567	Drive Shaft	22	28	46	78	650					
	2011.10-		L/R	F	Hatchback Engine CHYB	GC050170	Outer Joint	22	26	46	78	53	M				
	2011.10-		R	F	Hatchback Engine CHYB	GDS50543	Drive Shaft	22	28	46	78	814					
1.0 EcoFuel (50 kW)	2012.11-	MT	L/R	F	Hatchback Engine CPGA	GC050170	Outer Joint	22	26	46	78	53	M				
<b>OCTAVIA III (1U2, 1U5), SW</b>																	
1.9 TDi (81 kW)	1997.08-	2000.07	AT			GC083037	Outer Joint	36	30	59.5	40.5	55	I				
<b>OCTAVIA III (1Z3, 1Z5), SW</b>																	
1.4 (59 kW)	2006.05-		AT			GC083037	Outer Joint	36	30	59.5	40.5	55	I				
1.4 TSi (90 kW)	2008.11-	2013.04	MT			GC083037	Outer Joint	36	30	59.5	40.5	55	I				
1.6 (75 kW)	2004.09-		MT/AT			GC083037	Outer Joint	36	30	59.5	40.5	55	I				
1.6 FSi (75 kW)	2004.02-	2013.04	MT/AT			GC083037	Outer Joint	36	30	59.5	40.5	55	I				
1.6 FSi (85 kW)	2004.02-	2013.04	MT/AT			GC083037	Outer Joint	36	30	59.5	40.5	55	I				
<b>RONDA (022A)</b>																	
1.6 (68 kW)	1983.08-	1985.09	MT		F Hatchback Engine 022A000/138AR6.000	GC017006	Outer Joint	22	25	48.1	93.5	60.5	I				
	1983.08-	1985.09			F Hatchback Engine 022A000/138AR6.000	GCI18070	Inner Joint		25		32						
	1983.08-	1985.09	MT		F Hatchback Engine 022A000/138AR6.000	GCI48004	Inner Joint		25		32						
<b>TOLEDO</b>																	
1.8 GL-GLX			L			GDS53006	Drive Shaft	22		50	78.5	526					
<b>TOLEDO II (1M2)</b>																	
1.4 16V (55 kW)	1999.07-	2006.05		F	Saloon Engine AHW/APE/AUA/AXP/BCA	GCI83008	Inner Joint		33		32						
	1999.07-	2006.05	MT		F Saloon Engine AHW/APE/AUA/AXP/BCA	GC083033	Outer Joint	36	30	53	78.5	51	I				
	1999.07-	2006.05	MT	L	F Saloon Engine AHW/APE/AUA/AXP/BCA	GDS61045	Drive Shaft	36		53	78.5	555					
	1999.07-	2006.05	MT	R	F Saloon Engine AHW/APE/AUA/AXP/BCA	GDS83046	Drive Shaft	36		53	78.5	822					
1.6 16V (77 kW)	2000.09-	2006.05		F	Saloon Engine AUS/AZD/BCB	GC083036	Outer Joint	36	30	53.2	77.5	61	I				
	2000.09-	2006.05	5MT		F Saloon Engine AUS/AZD/BCB	GCI83008	Inner Joint		33		32						
	2000.09-	2006.05		L	F Saloon Engine AUS/AZD/BCB	GDS61312	Drive Shaft	36		53	78	546					
1.8 20V (92 kW)	1999.04-	2004.05				GCI83011	Inner Joint		33		34						
	1999.04-	2006.05		F	Saloon Engine AGN/APG	GC083036	Outer Joint	36	30	53.2	77.5	61	I				
	1999.04-	2006.05	MT		F Saloon Engine AGN/APG	GCI83011	Inner Joint		33		34						
	1999.04-	2006.05	AT	L	F Saloon Engine AGN/APG	GDS61156	Drive Shaft	36		53	78	554.5					
	1999.04-	2006.05	AT	L	F Saloon Engine AGN/APG	GCI61062	Inner Joint		30		59						
1.8 20VT (132 kW)	2001.05-	2006.05		F	Saloon Engine APP/AUQ	GC083035	Outer Joint	36	27	53	77.5	65	I				
	2001.05-	2006.05		F	Saloon Engine APP/AUQ	GC083036	Outer Joint	36	30	53.2	77.5	61	I				
	2001.05-	2006.05	AT	L	F Saloon Engine APP/AUQ	GDS61156	Drive Shaft	36		53	78	554.5					
	2001.05-	2006.05	AT	L	F Saloon Engine APP/AUQ	GCI61062	Inner Joint		30		59						
	2001.05-	2006.05	MT/AT	L	F Saloon Engine APP/AUQ	GDS61123	Drive Shaft	36		53	77.5	520					
	2001.05-	2006.05		R	F Saloon Engine APP/AUQ	GDS61121	Drive Shaft	36		53	77.5	806					
1.8 T 20V (132 kW)	2001.05-	2004.05				GCI83011	Inner Joint		33		34						
1.9 SDi (50 kW)	1999.11-	2004.06		F	Saloon Engine AQM	GCI83008	Inner Joint		33		32						
	1999.11-	2004.06	L	F	Saloon Engine AQM	GDS61045	Drive Shaft	36		53	78.5	555					
	1999.11-	2004.06	R	F	Saloon Engine AQM	GDS83046	Drive Shaft	36		53	78.5	822					
1.9 TDi (110 kW)	2000.10-	2006.05		F	Saloon Engine ARL	GC083035	Outer Joint	36	27	53	77.5	65	I				
	2000.10-	2006.05		F	Saloon Engine ARL	GC083036	Outer Joint	36	30	53.2	77.5	61	I				
	2000.10-	2006.05	L	F	Saloon Engine ARL	GDS61123	Drive Shaft	36		53	77.5	520					
	2000.10-	2006.05	R	F	Saloon Engine ARL	GDS61121	Drive Shaft	36		53	77.5	806					
1.9 TDi (66 kW)	1999.04-	2006.05		F	Saloon Engine AGR/ALH	GC083036	Outer Joint	36	30	53.2	77.5	61	I				
	1999.04-	2006.05	MT		F Saloon Engine AGR/ALH	GCI83011	Inner Joint		33		34						
	1999.04-	2006.05	MT	L	F Saloon Engine AGR/ALH	GDS83006	Drive Shaft	36		53.2	77.5	557					
	1999.04-	2006.05	MT	R	F Saloon Engine AGR/ALH	GDS83004	Drive Shaft	36		53.2	77.5	822					
1.9 TDi (81 kW)	1999.04-	2006.05		F	Saloon Engine AHF/ASV	GC083036	Outer Joint	36	30	53.2	77.5	61	I				



		TRANSM	L/R	F/R		G-AP Ref.	PRODUCT	ABS	Technical Specifications					
									YEAR	A	B	C	H	L
<b>SEAT</b>														
<b>TOLEDO II (1M2)</b>														
1.9 TDi (81 kW)	1999.04-2006.05	MT		F	Saloon Engine AHF/ASV	GCI83011	Inner Joint		33		34			
	1999.04-2006.05	MT	L	F	Saloon Engine AHF/ASV	GDS61021	Drive Shaft	36		53.2	77.5	564.5		
	1999.04-2006.05	MT	L	F	Saloon Engine AHF/ASV	GDS83006	Drive Shaft	36		53.2	77.5	557		
	1999.04-2006.05	MT	R	F	Saloon Engine AHF/ASV	GDS83004	Drive Shaft	36		53.2	77.5	822		
1.9 TDi (96 kW)	2003.05-2004.12			F	Saloon Engine ASZ	GC083035	Outer Joint	36	27	53	77.5	65	I	
	2003.05-2004.12	6MT	L	F	Saloon Engine ASZ	GDS61123	Drive Shaft	36		53	77.5	520		
	2003.05-2004.12	6MT	R	F	Saloon Engine ASZ	GDS61121	Drive Shaft	36		53	77.5	806		
2.3 V5 (110 kW)	1999.04-2001.05		L	F	Saloon Engine AGZ	GDS61156	Drive Shaft	36		53	78	554.5		
	1999.04-2001.05		L	F	Saloon Engine AGZ	GCI61062	Inner Joint		30		59			
2.3 V5 20V (125 kW)	2001.05-2006.05			F	Saloon Engine AQN	GC083036	Outer Joint	36	30	53.2	77.5	61	I	
	2001.05-2006.05		L	F	Saloon Engine AQN	GDS61156	Drive Shaft	36		53	78	554.5		
	2001.05-2006.05		L	F	Saloon Engine AQN	GCI61062	Inner Joint		30		59			
<b>TOLEDO III (5P2)</b>														
1.4 16V (63 kW)	2006.05-2009.05		L	F	MPV Engine BXW	GDS53007	Drive Shaft	36		59.5	40	559		
1.6 (75 kW)	2004.10-2009.05			F	MPV Engine BBU/BSE/BSF/CCSA	GC083037	Outer Joint	36	30	59.5	40.5	55	I	
	2004.10-2009.05	MT		F	MPV Engine BBU/BSE/BSF/CCSA	GCI83011	Inner Joint		33		34			
	2004.10-2009.05	MT	L	F	MPV Engine BBU/BSE/BSF/CCSA	GDS83320	Drive Shaft	36		59.5	40	546		
	2004.10-2009.05	MT				GC083037	Outer Joint	36	30	59.5	40.5	55	I	
1.8 TFSi (118 kW)	2007.01-2009.05			F	MPV Engine BYT/BZB/CDA	GCI83011	Inner Joint		33		34			
	2007.01-2009.05					GC083002	Outer Joint	36	27	59.5	40	66	I	
1.9 TDi (77 kW)	2004.10-2009.05	AT			Engine BKC	GC083002	Outer Joint	36	27	59.5	40	66	I	
	2004.10-2009.05	MT			Engine BKC	GC083037	Outer Joint	36	30	59.5	40.5	55	I	
	2005.01-2007.07			F	MPV Engine BJB/BKC/BLS/BXE	GC083037	Outer Joint	36	30	59.5	40.5	55	I	
	2005.01-2007.07	MT		F	MPV Engine BJB/BKC/BLS/BXE	GCI83011	Inner Joint		33		34			
	2005.01-2007.07	AT	L	F	MPV Engine BJB/BKC/BLS/BXE	GDS83241	Drive Shaft	36		59.5	40	475		
	2005.01-2007.07	MT	L	F	MPV Engine BJB/BKC/BLS/BXE	GDS83294	Drive Shaft	36		59.5	38	519		
2.0 FSi (110 kW)	2005.01-2007.07	MT	L	F	MPV Engine BJB/BKC/BLS/BXE	GDS61089	Drive Shaft	36		59.5	40.5	521		
	2004.10-2009.05	AT				GC083037	Outer Joint	36	30	59.5	40.5	55	I	
	2005.01-2006.05			F	MPV Engine BLR/BLY/BVY/BVZ	GC083037	Outer Joint	36	30	59.5	40.5	55	I	
	2005.01-2006.05	6AT		F	MPV Engine BLR/BLY/BVY/BVZ	GCI61011	Inner Joint	26	32	31	68.5	85		
	2005.01-2006.05	MT		F	MPV Engine BLR/BLY/BVY/BVZ	GCI83011	Inner Joint		33		34			
	2005.01-2006.05	6AT	L	F	MPV Engine BLR/BLY/BVY/BVZ	GDS61093	Drive Shaft	36	26	59.5	40.5	587.5		
	2005.01-2006.05	MT	L	F	MPV Engine BLR/BLY/BVY/BVZ	GDS61089	Drive Shaft	36		59.5	40.5	521		
	2005.01-2006.05	6AT	R	F	MPV Engine BLR/BLY/BVY/BVZ	GDS61094	Drive Shaft	36	26	59.5	40.5	884		
2.0 TDi (100 kW)	2005.01-2006.05	MT	R	F	MPV Engine BLR/BLY/BVY/BVZ	GDS61113	Drive Shaft	36		59.5	40	814		
	2004.04-2009.05	MT				GCI83016	Inner Joint		28		32			
	2004.04-2009.05					GC083002	Outer Joint	36	27	59.5	40	66	I	
	2004.09-2009.05			F	MPV Engine AZV	GC083002	Outer Joint	36	27	59.5	40	66	I	
	2004.09-2009.05	AT	L	F	MPV Engine AZV	GDS83241	Drive Shaft	36		59.5	40	475		
	2004.09-2009.05	AT	L	F	MPV Engine AZV	GDS54013	Drive Shaft	36		59.5	40	479.5		
	2004.09-2009.05	MT	L	F	MPV Engine AZV	GDS83236	Drive Shaft	36		59.5	40	484		
	2004.09-2009.05	AT	L/R	F	MPV Engine AZV	GCI61057	Inner Joint		34		86			
	2004.09-2009.05	AT	R	F	MPV Engine AZV	GDS83355	Drive Shaft	36	23	59.5	40	799		
	2004.09-2009.05	AT	R	F	MPV Engine AZV	GDS54011	Drive Shaft	36		59.5	40	755		
	2004.09-2009.05	MT	R	F	MPV Engine AZV	GDS61126	Drive Shaft	36		59.5	40	793		
2.0 TDi (103 kW)	2004.09-2009.05	MT	R	F	MPV Engine AZV	GDS83313	Drive Shaft	36		59.5	40	792		
	2004.04-2009.05	MT				GCI83016	Inner Joint		28		32			
	2004.04-2009.05					GC083002	Outer Joint	36	27	59.5	40	66	I	
	2005.11-2009.05	MT		F	MPV Engine BMM	GC083002	Outer Joint	36	27	59.5	40	66	I	
	2005.11-2009.05	AT	L	F	MPV Engine BMM	GDS83241	Drive Shaft	36		59.5	40	475		
	2005.11-2009.05	AT	L	F	MPV Engine BMM	GDS54013	Drive Shaft	36		59.5	40	479.5		
	2005.11-2009.05	MT	L	F	MPV Engine BMM	GDS83236	Drive Shaft	36		59.5	40	484		
	2005.11-2009.05	MT	L	F	MPV Engine BMM	GDS83295	Drive Shaft	36		59.5	40	491		
	2005.11-2009.05	AT	L/R	F	MPV Engine BMM	GCI61057	Inner Joint		34		86			
	2005.11-2009.05	AT	R	F	MPV Engine BMM	GDS54011	Drive Shaft	36		59.5	40	755		
2.0 TDi (125 kW)	2005.11-2009.05	MT	R	F	MPV Engine BMM	GDS61126	Drive Shaft	36		59.5	40	793		
	2005.11-2009.05	MT	R	F	MPV Engine BMM	GDS83313	Drive Shaft	36		59.5	40	792		
	2006.01-2009.05			F	MPV Engine BMN/CEGA	GC061045	Outer Joint	36	27	59.5	40	65	M	
	2006.01-2009.05	MT	L	F	MPV Engine BMN/CEGA	GDS83236	Drive Shaft	36		59.5	40	484		
	2006.01-2009.05	MT	L	F	MPV Engine BMN/CEGA	GCI83016	Inner Joint		28		32			
2006.01-2009.05	MT	L	F	MPV Engine BMN/CEGA	GDS83265	Drive Shaft	36		59.5	40	487			

		TRANSM	L/R	F/R		G-AP Ref.	PRODUCT	ABS	Technical Specifications								
									YEAR	A	B	C	H	L	P		
<b>SEAT</b>																	
<b>TOLEDO III (5P2)</b>																	
2.0 TDi (125 kW)	2006.01-	2009.05	MT	R	F	MPV Engine BMN/CEGA	GDS61126	Drive Shaft	36		59.5	40	793				
2.0 TDi 16V (103 kW)	2004.04-	2009.05			F	MPV Engine BKD	GC083002	Outer Joint	36	27	59.5	40	66	I			
	2004.04-	2009.05	6AT		F	MPV Engine BKD	GCI54004	Inner Joint		34		85					
	2004.04-	2009.05	AT	L	F	MPV Engine BKD	GDS83241	Drive Shaft	36		59.5	40	475				
	2004.04-	2009.05	AT	L	F	MPV Engine BKD	GDS54013	Drive Shaft	36		59.5	40	479.5				
	2004.04-	2009.05	MT	L	F	MPV Engine BKD	GDS83236	Drive Shaft	36		59.5	40	484				
	2004.04-	2009.05	MT	L	F	MPV Engine BKD	GDS83295	Drive Shaft	36		59.5	40	491				
	2004.04-	2009.05	AT	L/R	F	MPV Engine BKD	GCI61057	Inner Joint		34		86					
	2004.04-	2009.05	AT	R	F	MPV Engine BKD	GDS83355	Drive Shaft	36	23	59.5	40	799				
	2004.04-	2009.05	AT	R	F	MPV Engine BKD	GDS54011	Drive Shaft	36		59.5	40	755				
	2004.04-	2009.05	MT	R	F	MPV Engine BKD	GDS61126	Drive Shaft	36		59.5	40	793				
2.0 TFSi (147 kW)	2004.04-	2009.05	MT	R	F	MPV Engine BKD	GDS83313	Drive Shaft	36		59.5	40	792				
	2005.11-	2009.05	MT		F	MPV Engine BWA	GC083002	Outer Joint	36	27	59.5	40	66	I			
	2005.11-	2009.05		L	F	MPV Engine BWA	GDS83295	Drive Shaft	36		59.5	40	491				
2005.11-	2009.05					GC083002	Outer Joint	36	27	59.5	40	66	I				
<b>TOLEDO IV (KG3)</b>																	
1.2 (55 kW)	2012.07-			L	F	Hatchback Engine CGPC	GDS83330	Drive Shaft	36		50.7	58.5	515				
	2012.07-			R	F	Hatchback Engine CGPC	GDS61267	Drive Shaft	36		50.7	58.5	765				
<b>SKODA</b>																	
<b>CITIGO</b>																	
1.0 (44 kW)	2011.10-			L	F	Hatchback Engine CHYA	GDS50567	Drive Shaft	22	28	46	78	650				
	2011.10-			L/R	F	Hatchback Engine CHYA	GC050170	Outer Joint	22	26	46	78	53	M			
	2011.10-			R	F	Hatchback Engine CHYA	GDS50543	Drive Shaft	22	28	46	78	814				
1.0 (55 kW)	2011.10-			L	F	Hatchback Engine CHYB	GDS50567	Drive Shaft	22	28	46	78	650				
	2011.10-			L/R	F	Hatchback Engine CHYB	GC050170	Outer Joint	22	26	46	78	53	M			
	2011.10-			R	F	Hatchback Engine CHYB	GDS50543	Drive Shaft	22	28	46	78	814				
1.0 CNG (50 kW)	2012.11-			L	F	Hatchback Engine CPGA	GDS50567	Drive Shaft	22	28	46	78	650				
	2012.11-		MT	L/R	F	Hatchback Engine CPGA	GC050170	Outer Joint	22	26	46	78	53	M			
	2012.11-			R	F	Hatchback Engine CPGA	GDS50543	Drive Shaft	22	28	46	78	814				
	2012.11-					Hatchback Engine CPGA	GC050153	Outer Joint	22	26	46	78	55	M			
<b>FABIA</b>																	
1.2 (44 kW)	2007.05-		MT		F	Hatchback Engine BBM/CHFA	GC083027	Outer Joint	36	30	50.7	58.5	47.5	I			
	2007.05-		MT	L	F	Hatchback Engine BBM/CHFA	GDS83063	Drive Shaft	36		50.7	58.5	501				
	2007.05-		MT	R	F	Hatchback Engine BBM/CHFA	GDS61063	Drive Shaft	36		50.7	58.5	751				
1.2 (51 kW)	2007.05-		MT		F	Hatchback Engine BZG/CEVA/CGPA/CHTA	GC083027	Outer Joint	36	30	50.7	58.5	47.5	I			
	2007.05-		MT	L	F	Hatchback Engine BZG/CEVA/CGPA/CHTA	GDS83063	Drive Shaft	36		50.7	58.5	501				
	2007.05-		MT	R	F	Hatchback Engine BZG/CEVA/CGPA/CHTA	GDS61063	Drive Shaft	36		50.7	58.5	751				
1.2 TDi (55 kW)	2010.05-		MT	L	F	Hatchback Engine CFWA	GDS61302	Drive Shaft	36		50.5	59	479				
	2010.05-		MT	R	F	Hatchback Engine CFWA	GDS61301	Drive Shaft	36		50.5	59	771				
1.2 TSi (63 kW)	2010.03-		MT	F	Hatchback Engine CBZA	GCI53002	Inner Joint		33		34						
1.2 TSi (77 kW)	2010.03-		MT	F	Hatchback Engine CBZB	GCI53002	Inner Joint		33		34						
1.4 (63 kW)	2007.05-		MT		F	Hatchback Engine BXW/CGGB	GC083027	Outer Joint	36	30	50.7	58.5	47.5	I			
	2007.05-		MT	L	F	Hatchback Engine BXW/CGGB	GDS83063	Drive Shaft	36		50.7	58.5	501				
	2007.05-		MT	R	F	Hatchback Engine BXW/CGGB	GDS61063	Drive Shaft	36		50.7	58.5	751				
1.4 TDi (51 kW)	2007.05-		MT		F	Hatchback Engine BNM	GC083024	Outer Joint	36	30	50.75	59	54.5	I			
	2007.05-		MT	R	F	Hatchback Engine BNM	GDS61223	Drive Shaft	36		52	59	757				
	2007.05-			L	F	Hatchback Engine BNM	GDS61135	Drive Shaft	36		52	59	475				
	2007.05-			R	F	Hatchback Engine BNM	GDS61136	Drive Shaft	36		52	59	763				
	2007.05-			R	F	Hatchback Engine BNM	GCI61062	Inner Joint		30		59					
1.4 TDi (59 kW)	2007.05-		MT		F	Hatchback Engine BMS/BNV	GC083024	Outer Joint	36	30	50.75	59	54.5	I			
	2007.05-			L	F	Hatchback Engine BMS/BNV	GDS61098	Drive Shaft	36		50.5	59	472				
	2007.05-			R	F	Hatchback Engine BMS/BNV	GDS61099	Drive Shaft	36		50.5	59	759				
	2007.05-		MT	L	F	Hatchback Engine BMS/BNV	GDS61135	Drive Shaft	36		52	59	475				
	2007.05-		MT	R	F	Hatchback Engine BMS/BNV	GDS61136	Drive Shaft	36		52	59	763				
	2007.05-		MT	R	F	Hatchback Engine BMS/BNV	GCI61062	Inner Joint		30		59					
1.6 (77 kW)	2007.05-		MT	F	F	Hatchback Engine BTS/CFNA	GCI83011	Inner Joint		33		34					
	2007.05-		MT		F	Hatchback Engine BTS/CFNA	GC083024	Outer Joint	36	30	50.75	59	54.5	I			
	2007.05-		AT	L	F	Hatchback Engine BTS/CFNA	GDS61150	Drive Shaft	36	26	52	75	557				
	2007.05-		AT	L	F	Hatchback Engine BTS/CFNA	GCI61039	Inner Joint	26	22	31	68.5	88.5				
1.6 TDi (55 kW)	2010.04-		MT		F	Hatchback Engine CAYC	GCI53002	Inner Joint		33		34					
	2010.04-			L	F	Hatchback Engine CAYC	GDS61302	Drive Shaft	36		50.5	59	479				









		TRANS	L/R	F/R		G-AP Ref.	PRODUCT	ABS	Technical Specifications								
									YEAR	A	B	C	H	L	P		
<b>SKODA FABIA</b>																	
1.6 TDi (55 kW)	2010.04-			R	F	Hatchback Engine CAYC	GDS61301	Drive Shaft	36		50.5	59	771				
1.6 TDi (66 kW)	2010.03-		MT		F	Hatchback Engine CAYB	GCI53002	Inner Joint		33		34					
	2010.03-			L	F	Hatchback Engine CAYB	GDS61302	Drive Shaft	36		50.5	59	479				
	2010.03-			R	F	Hatchback Engine CAYB	GDS61301	Drive Shaft	36		50.5	59	771				
1.6 TDi (77 kW)	2010.03-		MT		F	Hatchback Engine CAYC	GCI53002	Inner Joint		33		34					
	2010.03-			L	F	Hatchback Engine CAYC	GDS61302	Drive Shaft	36		50.5	59	479				
	2010.03-			R	F	Hatchback Engine CAYC	GDS61301	Drive Shaft	36		50.5	59	771				
1.9 TDi (77 kW)	2007.05-		MT		F	Hatchback Engine BLS/BSW	GC083024	Outer Joint	36	30	50.75	59	54.5	I			
	2007.05-			L	F	Hatchback Engine BLS/BSW	GDS61098	Drive Shaft	36		50.5	59	472				
	2007.05-		MT	L	F	Hatchback Engine BLS/BSW	GDS61135	Drive Shaft	36		52	59	475				
	2007.05-		MT	R	F	Hatchback Engine BLS/BSW	GDS61136	Drive Shaft	36		52	59	763				
	2007.05-		MT	R	F	Hatchback Engine BLS/BSW	GCI61062	Inner Joint		30		59					
<b>FABIA (6Y2)</b>																	
1.0 (37 kW)	1999.12-	2002.08	MT		F	Hatchback Engine AQV/ARV	GC054002	Outer Joint	20	30	52	59.5	49.5	I			
1.2 (40 kW)	2002.08-	2008.03	MT		F	Hatchback Engine AWY/BMD	GC054002	Outer Joint	20	30	52	59.5	49.5	I			
	2002.08-	2008.03	MT		F	Hatchback Engine AWY/BMD	GC083027	Outer Joint	36	30	50.7	58.5	47.5	I			
	2002.08-	2008.03	5MT	L	F	Hatchback Engine AWY/BMD	GDS83063	Drive Shaft	36		50.7	58.5	501				
	2002.08-	2008.03	5MT	R	F	Hatchback Engine AWY/BMD	GDS61063	Drive Shaft	36		50.7	58.5	751				
1.2 (47 kW)	2003.01-	2008.03	MT		F	Hatchback Engine AZQ/BME	GC054002	Outer Joint	20	30	52	59.5	49.5	I			
	2003.01-	2008.03	MT		F	Hatchback Engine AZQ/BME	GC083027	Outer Joint	36	30	50.7	58.5	47.5	I			
	2003.01-	2008.03	5MT	L	F	Hatchback Engine AZQ/BME	GDS83063	Drive Shaft	36		50.7	58.5	501				
	2003.01-	2008.03	5MT	R	F	Hatchback Engine AZQ/BME	GDS61063	Drive Shaft	36		50.7	58.5	751				
1.4 (44 kW)	2000.08-	2002.08	MT		F	Hatchback Engine AZE/AZF	GC054002	Outer Joint	20	30	52	59.5	49.5	I			
	2000.08-	2002.08	MT		F	Hatchback Engine AZE/AZF	GC083027	Outer Joint	36	30	50.7	58.5	47.5	I			
1.4 (50 kW)	1999.08-	2003.05	MT		F	Hatchback Engine AME/AQW/ATZ	GC054002	Outer Joint	20	30	52	59.5	49.5	I			
	1999.08-	2003.05	MT		F	Hatchback Engine AME/AQW/ATZ	GC083027	Outer Joint	36	30	50.7	58.5	47.5	I			
1.4 16V (55 kW)	1999.12-	2008.03	AT		F	Hatchback Engine AUA/BBY/BKY	GC083024	Outer Joint	36	30	50.75	59	54.5	I			
	1999.12-	2008.03	MT		F	Hatchback Engine AUA/BBY/BKY	GC083027	Outer Joint	36	30	50.7	58.5	47.5	I			
	1999.12-	2008.03	5MT	L	F	Hatchback Engine AUA/BBY/BKY	GDS83063	Drive Shaft	36		50.7	58.5	501				
	1999.12-	2008.03	5MT	R	F	Hatchback Engine AUA/BBY/BKY	GDS61063	Drive Shaft	36		50.7	58.5	751				
	1999.12-	2008.03	AT	R	F	Hatchback Engine AUA/BBY/BKY	GDS61252	Drive Shaft	36		53.7	58.5	730				
	1999.12-	2008.03	AT	R	F	Hatchback Engine AUA/BBY/BKY	GCI61005	Inner Joint		30		57.6					
1.4 16V (74 kW)	1999.12-	2008.03	MT		F	Hatchback Engine AUB/BBZ	GC083027	Outer Joint	36	30	50.7	58.5	47.5	I			
	1999.12-	2008.03	5MT	L	F	Hatchback Engine AUB/BBZ	GDS83063	Drive Shaft	36		50.7	58.5	501				
	1999.12-	2008.03	5MT	R	F	Hatchback Engine AUB/BBZ	GDS61063	Drive Shaft	36		50.7	58.5	751				
1.4 TDi (51 kW)	2005.10-	2008.03	MT		F	Hatchback Engine BNM	GC083024	Outer Joint	36	30	50.75	59	54.5	I			
	2005.10-	2008.03	MT	R	F	Hatchback Engine BNM	GDS61223	Drive Shaft	36		52	59	757				
1.4 TDi (55 kW)	2003.04-	2008.03	MT		F	Hatchback Engine AMF	GC083024	Outer Joint	36	30	50.75	59	54.5	I			
	2003.04-	2008.03	MT/AT		F	Hatchback Engine AMF	GCI61006	Inner Joint		30		57.6					
	2003.04-	2008.03	5MT	L	F	Hatchback Engine AMF	GDS61098	Drive Shaft	36		50.5	59	472				
	2003.04-	2008.03	MT	L	F	Hatchback Engine AMF	GDS61135	Drive Shaft	36		52	59	475				
	2003.04-	2008.03	5MT	R	F	Hatchback Engine AMF	GDS61099	Drive Shaft	36		50.5	59	759				
	2003.04-	2008.03	MT	R	F	Hatchback Engine AMF	GDS61136	Drive Shaft	36		52	59	763				
	2003.04-	2008.03	MT	R	F	Hatchback Engine AMF	GCI61062	Inner Joint		30		59					
1.4 TDi (59 kW)	2005.10-	2008.03	MT		F	Hatchback Engine BNV	GC083024	Outer Joint	36	30	50.75	59	54.5	I			
	2005.10-	2008.03	5MT	L	F	Hatchback Engine BNV	GDS61098	Drive Shaft	36		50.5	59	472				
	2005.10-	2008.03	MT	L	F	Hatchback Engine BNV	GDS61135	Drive Shaft	36		52	59	475				
	2005.10-	2008.03	5MT	R	F	Hatchback Engine BNV	GDS61099	Drive Shaft	36		50.5	59	759				
	2005.10-	2008.03	MT	R	F	Hatchback Engine BNV	GDS61136	Drive Shaft	36		52	59	763				
	2005.10-	2008.03	MT	R	F	Hatchback Engine BNV	GCI61062	Inner Joint		30		59					
1.9 SDi (47 kW)	1999.12-	2008.03	MT		F	Hatchback Engine ASY	GC054002	Outer Joint	20	30	52	59.5	49.5	I			
	1999.12-	2008.03	MT		F	Hatchback Engine ASY	GC083027	Outer Joint	36	30	50.7	58.5	47.5	I			
	1999.12-	2008.03	5MT	L	F	Hatchback Engine ASY	GDS83063	Drive Shaft	36		50.7	58.5	501				
	1999.12-	2008.03	5MT	R	F	Hatchback Engine ASY	GDS61063	Drive Shaft	36		50.7	58.5	751				
1.9 TDi (74 kW)	2000.01-	2008.03	MT		F	Hatchback Engine ATD/AXR	GC083024	Outer Joint	36	30	50.75	59	54.5	I			
	2000.01-	2008.03	MT/AT		F	Hatchback Engine ATD/AXR	GCI61006	Inner Joint		30		57.6					
	2000.01-	2008.03	5MT	L	F	Hatchback Engine ATD/AXR	GDS61098	Drive Shaft	36		50.5	59	472				
	2000.01-	2008.03	MT	L	F	Hatchback Engine ATD/AXR	GDS61135	Drive Shaft	36		52	59	475				
	2000.01-	2008.03	5MT	R	F	Hatchback Engine ATD/AXR	GDS61099	Drive Shaft	36		50.5	59	759				
	2000.01-	2008.03	MT	R	F	Hatchback Engine ATD/AXR	GDS61136	Drive Shaft	36		52	59	763				



		TRANSM	L/R	F/R		G-AP Ref.	PRODUCT	ABS	Technical Specifications								
									YEAR	A	B	C	H	L	P		
<b>SKODA FABIA (6Y2)</b>																	
1.9 TDi (74 kW)	2000.01-	2008.03	MT	R	F	Hatchback Engine ATD/AXR	GC161062	Inner Joint		30		59					
1.9 TDi RS (96 kW)	2003.06-	2008.03			F	Hatchback Engine ASZ/BLT	GC053002	Outer Joint	36	27	50.75	75	65	I			
	2003.06-	2008.03	MT		F	Hatchback Engine ASZ/BLT	GC054002	Outer Joint	20	30	52	59.5	49.5	I			
	2003.06-	2008.03	MT	L	F	Hatchback Engine ASZ/BLT	GDS61204	Drive Shaft	36		50.5	75	461				
	2003.06-	2008.03	MT	R	F	Hatchback Engine ASZ/BLT	GDS61183	Drive Shaft	36		50.5	75	769				
2.0 (85 kW)	1999.12-	2008.03	MT		F	Hatchback Engine AZL	GC083024	Outer Joint	36	30	50.75	59	54.5	I			
<b>FABIA (6Y3)</b>																	
1.2 (40 kW)	2001.07-	2007.12	MT		F	Saloon Engine AWY/BMD	GC054002	Outer Joint	20	30	52	59.5	49.5	I			
	2001.07-	2007.12	MT		F	Saloon Engine AWY/BMD	GC083027	Outer Joint	36	30	50.7	58.5	47.5	I			
	2001.07-	2007.12	5MT	L	F	Saloon Engine AWY/BMD	GDS83063	Drive Shaft	36		50.7	58.5	501				
	2001.07-	2007.12	5MT	R	F	Saloon Engine AWY/BMD	GDS61063	Drive Shaft	36		50.7	58.5	751				
1.2 (47 kW)	2003.01-	2007.12	MT		F	Saloon Engine AZQ/BME	GC054002	Outer Joint	20	30	52	59.5	49.5	I			
	2003.01-	2007.12	MT		F	Saloon Engine AZQ/BME	GC083027	Outer Joint	36	30	50.7	58.5	47.5	I			
	2003.01-	2007.12	5MT	L	F	Saloon Engine AZQ/BME	GDS83063	Drive Shaft	36		50.7	58.5	501				
	2003.01-	2007.12	5MT	R	F	Saloon Engine AZQ/BME	GDS61063	Drive Shaft	36		50.7	58.5	751				
1.4 (44 kW)	2000.04-	2002.08	MT		F	Saloon Engine AZE/AZF	GC054002	Outer Joint	20	30	52	59.5	49.5	I			
	2000.04-	2002.08	MT		F	Saloon Engine AZE/AZF	GC083027	Outer Joint	36	30	50.7	58.5	47.5	I			
1.4 (50 kW)	2001.07-	2003.05			F	Saloon Engine AME/AQW/ATZ	GC054002	Outer Joint	20	30	52	59.5	49.5	I			
	2001.07-	2003.05			F	Saloon Engine AME/AQW/ATZ	GC083027	Outer Joint	36	30	50.7	58.5	47.5	I			
1.4 16V (55 kW)	1999.10-	2007.12	MT		F	Saloon Engine AUA/BBY/BKY	GC083027	Outer Joint	36	30	50.7	58.5	47.5	I			
	1999.10-	2007.12	MT		F	Saloon Engine AUA/BBY/BKY	GC083024	Outer Joint	36	30	50.75	59	54.5	I			
	1999.10-	2007.12	5MT	L	F	Saloon Engine AUA/BBY/BKY	GDS83063	Drive Shaft	36		50.7	58.5	501				
	1999.10-	2007.12	5MT	R	F	Saloon Engine AUA/BBY/BKY	GDS61063	Drive Shaft	36		50.7	58.5	751				
	1999.10-	2007.12	AT	R	F	Saloon Engine AUA/BBY/BKY	GDS61252	Drive Shaft	36		53.7	58.5	730				
	1999.10-	2007.12	AT	R	F	Saloon Engine AUA/BBY/BKY	GC161005	Inner Joint		30		57.6					
	1999.10-	2007.12	AT	R	F	Saloon Engine AUA/BBY/BKY	GC061070	Outer Joint	36	30	53.7	58.5	55	I			
1.4 16V (59 kW)	2006.04-	2007.12	MT		F	Saloon Engine BUD	GC083027	Outer Joint	36	30	50.7	58.5	47.5	I			
	2006.04-	2007.12		L	F	Saloon Engine BUD	GDS83063	Drive Shaft	36		50.7	58.5	501				
	2006.04-	2007.12		R	F	Saloon Engine BUD	GDS61063	Drive Shaft	36		50.7	58.5	751				
1.4 16V (74 kW)	1999.12-	2007.12	MT		F	Saloon Engine AUB/BBZ	GC083027	Outer Joint	36	30	50.7	58.5	47.5	I			
	1999.12-	2007.12	5MT	L	F	Saloon Engine AUB/BBZ	GDS83063	Drive Shaft	36		50.7	58.5	501				
	1999.12-	2007.12	5MT	R	F	Saloon Engine AUB/BBZ	GDS61063	Drive Shaft	36		50.7	58.5	751				
1.4 TDi (51 kW)	2005.10-	2007.12			F	Saloon Engine BNM	GC083024	Outer Joint	36	30	50.75	59	54.5	I			
	2005.10-	2007.12	MT	R	F	Saloon Engine BNM	GDS61223	Drive Shaft	36		52	59	757				
1.4 TDi (55 kW)	2003.04-	2007.12	MT		F	Saloon Engine AMF	GC083024	Outer Joint	36	30	50.75	59	54.5	I			
	2003.04-	2007.12	MT/AT		F	Saloon Engine AMF	GC161006	Inner Joint		30		57.6					
	2003.04-	2007.12	5MT	L	F	Saloon Engine AMF	GDS61098	Drive Shaft	36		50.5	59	472				
	2003.04-	2007.12	MT	L	F	Saloon Engine AMF	GDS61135	Drive Shaft	36		52	59	475				
	2003.04-	2007.12	5MT	R	F	Saloon Engine AMF	GDS61099	Drive Shaft	36		50.5	59	759				
	2003.04-	2007.12	MT	R	F	Saloon Engine AMF	GDS61136	Drive Shaft	36		52	59	763				
	2003.04-	2007.12	MT	R	F	Saloon Engine AMF	GC161062	Inner Joint		30		59					
1.4 TDi (59 kW)	2005.10-	2007.12	MT		F	Saloon Engine BNV	GC083024	Outer Joint	36	30	50.75	59	54.5	I			
	2005.10-	2007.12	5MT	L	F	Saloon Engine BNV	GDS61098	Drive Shaft	36		50.5	59	472				
	2005.10-	2007.12	MT	L	F	Saloon Engine BNV	GDS61135	Drive Shaft	36		52	59	475				
	2005.10-	2007.12	5MT	R	F	Saloon Engine BNV	GDS61099	Drive Shaft	36		50.5	59	759				
	2005.10-	2007.12	MT	R	F	Saloon Engine BNV	GDS61136	Drive Shaft	36		52	59	763				
	2005.10-	2007.12	MT	R	F	Saloon Engine BNV	GC161062	Inner Joint		30		59					
1.9 SDi (47 kW)	1999.11-	2007.12	MT		F	Saloon Engine ASY	GC054002	Outer Joint	20	30	52	59.5	49.5	I			
	1999.11-	2007.12	MT		F	Saloon Engine ASY	GC083027	Outer Joint	36	30	50.7	58.5	47.5	I			
	1999.11-	2007.12	5MT	L	F	Saloon Engine ASY	GDS83063	Drive Shaft	36		50.7	58.5	501				
	1999.11-	2007.12	5MT	R	F	Saloon Engine ASY	GDS61063	Drive Shaft	36		50.7	58.5	751				
1.9 TDi (74 kW)	2000.01-	2007.12	MT		F	Saloon Engine ATD/AXR	GC083024	Outer Joint	36	30	50.75	59	54.5	I			
	2000.01-	2007.12	MT/AT		F	Saloon Engine ATD/AXR	GC161006	Inner Joint		30		57.6					
	2000.01-	2007.12	5MT	L	F	Saloon Engine ATD/AXR	GDS61098	Drive Shaft	36		50.5	59	472				
	2000.01-	2007.12	MT	L	F	Saloon Engine ATD/AXR	GDS61135	Drive Shaft	36		52	59	475				
	2000.01-	2007.12	5MT	R	F	Saloon Engine ATD/AXR	GDS61099	Drive Shaft	36		50.5	59	759				
	2000.01-	2007.12	MT	R	F	Saloon Engine ATD/AXR	GDS61136	Drive Shaft	36		52	59	763				
	2000.01-	2007.12	MT	R	F	Saloon Engine ATD/AXR	GC161062	Inner Joint		30		59					
2.0 (85 kW)	1999.12-	2007.12	MT		F	Saloon Engine AZL	GC083024	Outer Joint	36	30	50.75	59	54.5	I			
<b>FABIA (6Y5)</b>																	
1.2 (40 kW)	2001.07-	2007.12	MT		F	Estate Engine AWY/BMD	GC054002	Outer Joint	20	30	52	59.5	49.5	I			

		TRANSM	L/R	F/R		G-AP Ref.	PRODUCT	ABS	Technical Specifications								
									YEAR	A	B	C	H	L	P		
<b>SKODA FABIA (6Y5)</b>																	
1.2 (40 kW)	2001.07-	2007.12	MT		F	Estate Engine AWY/BMD	GC083027	Outer Joint	36	30	50.7	58.5	47.5	I			
	2001.07-	2007.12	5MT	L	F	Estate Engine AWY/BMD	GDS83063	Drive Shaft	36		50.7	58.5	501				
	2001.07-	2007.12	5MT	R	F	Estate Engine AWY/BMD	GDS61063	Drive Shaft	36		50.7	58.5	751				
1.2 (47 kW)	2003.01-	2007.12	MT		F	Estate Engine AZQ/BME	GC054002	Outer Joint	20	30	52	59.5	49.5	I			
	2003.01-	2007.12	MT		F	Estate Engine AZQ/BME	GC083027	Outer Joint	36	30	50.7	58.5	47.5	I			
	2003.01-	2007.12	5MT	L	F	Estate Engine AZQ/BME	GDS83063	Drive Shaft	36		50.7	58.5	501				
	2003.01-	2007.12	5MT	R	F	Estate Engine AZQ/BME	GDS61063	Drive Shaft	36		50.7	58.5	751				
1.4 (44 kW)	2000.04-	2003.03	MT		F	Estate Engine AZE/AZF	GC054002	Outer Joint	20	30	52	59.5	49.5	I			
	2000.04-	2003.03	MT		F	Estate Engine AZE/AZF	GC083027	Outer Joint	36	30	50.7	58.5	47.5	I			
1.4 (50 kW)	2000.04-	2003.05	MT		F	Estate Engine AME/AQW/WATZ	GC054002	Outer Joint	20	30	52	59.5	49.5	I			
	2000.04-	2003.05	MT		F	Estate Engine AME/AQW/WATZ	GC083027	Outer Joint	36	30	50.7	58.5	47.5	I			
1.4 16V (55 kW)	2000.05-	2007.12	AT		F	Estate Engine AUA/BBY/BKY	GC083024	Outer Joint	36	30	50.75	59	54.5	I			
	2000.05-	2007.12	MT		F	Estate Engine AUA/BBY/BKY	GC083027	Outer Joint	36	30	50.7	58.5	47.5	I			
	2000.05-	2007.12	5MT	L	F	Estate Engine AUA/BBY/BKY	GDS83063	Drive Shaft	36		50.7	58.5	501				
	2000.05-	2007.12	5MT	R	F	Estate Engine AUA/BBY/BKY	GDS61063	Drive Shaft	36		50.7	58.5	751				
	2000.05-	2007.12	AT	R	F	Estate Engine AUA/BBY/BKY	GDS61252	Drive Shaft	36		53.7	58.5	730				
	2000.05-	2007.12	AT	R	F	Estate Engine AUA/BBY/BKY	GCI61005	Inner Joint		30		57.6					
1.4 16V (59 kW)	2000.05-	2007.12	AT	R	F	Estate Engine AUA/BBY/BKY	GC061070	Outer Joint	36	30	53.7	58.5	55	I			
	2006.04-	2007.12	MT		F	Estate Engine BUD	GC083027	Outer Joint	36	30	50.7	58.5	47.5	I			
	2006.04-	2007.12		L	F	Estate Engine BUD	GDS83063	Drive Shaft	36		50.7	58.5	501				
1.4 16V (74 kW)	2006.04-	2007.12		R	F	Estate Engine BUD	GDS61063	Drive Shaft	36		50.7	58.5	751				
	2000.04-	2007.12	MT		F	Estate Engine AUB/BBZ	GC083027	Outer Joint	36	30	50.7	58.5	47.5	I			
	2000.04-	2007.12	5MT	L	F	Estate Engine AUB/BBZ	GDS83063	Drive Shaft	36		50.7	58.5	501				
1.4 TDi (51 kW)	2000.04-	2007.12	5MT	R	F	Estate Engine AUB/BBZ	GDS61063	Drive Shaft	36		50.7	58.5	751				
	2005.10-	2007.12	MT		F	Estate Engine BNM	GC083024	Outer Joint	36	30	50.75	59	54.5	I			
	2005.10-	2007.12	MT	R	F	Estate Engine BNM	GDS61223	Drive Shaft	36		52	59	757				
1.4 TDi (55 kW)	2003.04-	2007.12	MT		F	Estate Engine AMF	GC083024	Outer Joint	36	30	50.75	59	54.5	I			
	2003.04-	2007.12	MT/AT		F	Estate Engine AMF	GCI61006	Inner Joint		30		57.6					
	2003.04-	2007.12	5MT	L	F	Estate Engine AMF	GDS61098	Drive Shaft	36		50.5	59	472				
	2003.04-	2007.12	MT	L	F	Estate Engine AMF	GDS61135	Drive Shaft	36		52	59	475				
	2003.04-	2007.12	5MT	R	F	Estate Engine AMF	GDS61099	Drive Shaft	36		50.5	59	759				
	2003.04-	2007.12	MT	R	F	Estate Engine AMF	GDS61136	Drive Shaft	36		52	59	763				
1.4 TDi (59 kW)	2003.04-	2007.12	MT	R	F	Estate Engine AMF	GCI61062	Inner Joint		30		59					
	2005.10-	2007.12	MT		F	Estate Engine BNV	GC083024	Outer Joint	36	30	50.75	59	54.5	I			
	2005.10-	2007.12	5MT	L	F	Estate Engine BNV	GDS61098	Drive Shaft	36		50.5	59	472				
	2005.10-	2007.12	MT	L	F	Estate Engine BNV	GDS61135	Drive Shaft	36		52	59	475				
	2005.10-	2007.12	5MT	R	F	Estate Engine BNV	GDS61099	Drive Shaft	36		50.5	59	759				
	2005.10-	2007.12	MT	R	F	Estate Engine BNV	GDS61136	Drive Shaft	36		52	59	763				
1.9 SDi (47 kW)	2005.10-	2007.12	MT	R	F	Estate Engine BNV	GCI61062	Inner Joint		30		59					
	2000.04-	2007.12	MT		F	Estate Engine ASY	GC054002	Outer Joint	20	30	52	59.5	49.5	I			
	2000.04-	2007.12	MT		F	Estate Engine ASY	GC083027	Outer Joint	36	30	50.7	58.5	47.5	I			
	2000.04-	2007.12	5MT	L	F	Estate Engine ASY	GDS83063	Drive Shaft	36		50.7	58.5	501				
	2000.04-	2007.12	5MT	R	F	Estate Engine ASY	GDS61063	Drive Shaft	36		50.7	58.5	751				
1.9 TDi (74 kW)	2000.04-	2007.12	MT	L	F	Estate Engine ATD/AXR	GDS61135	Drive Shaft	36		52	59	475				
	2000.04-	2007.12	5MT	R	F	Estate Engine ATD/AXR	GDS61099	Drive Shaft	36		50.5	59	759				
	2000.04-	2007.12	MT	R	F	Estate Engine ATD/AXR	GDS61136	Drive Shaft	36		52	59	763				
	2000.04-	2007.12	MT	R	F	Estate Engine ATD/AXR	GCI61062	Inner Joint		30		59					
	2000.04-	2007.12	MT		F	Estate Engine ATD/AXR	GC083024	Outer Joint	36	30	50.75	59	54.5	I			
	2000.04-	2007.12	MT/AT		F	Estate Engine ATD/AXR	GCI61006	Inner Joint		30		57.6					
	2000.04-	2007.12	5MT	L	F	Estate Engine ATD/AXR	GDS61098	Drive Shaft	36		50.5	59	472				
2.0 (85 kW)	2000.04-	2007.12	MT		F	Estate Engine AZL	GC083024	Outer Joint	36	30	50.75	59	54.5	I			
<b>FABIA COMBI</b>																	
1.2 (44 kW)	2007.10-		MT		F	Estate Engine BBM/CHFA	GC083027	Outer Joint	36	30	50.7	58.5	47.5	I			
	2007.10-		MT	L	F	Estate Engine BBM/CHFA	GDS83063	Drive Shaft	36		50.7	58.5	501				
	2007.10-		MT	R	F	Estate Engine BBM/CHFA	GDS61063	Drive Shaft	36		50.7	58.5	751				
1.2 (51 kW)	2007.11-		MT		F	Estate Engine BZG/CEVA/CGPA/CHTA	GC083027	Outer Joint	36	30	50.7	58.5	47.5	I			
	2007.11-		MT	L	F	Estate Engine BZG/CEVA/CGPA/CHTA	GDS83063	Drive Shaft	36		50.7	58.5	501				
	2007.11-		MT	R	F	Estate Engine BZG/CEVA/CGPA/CHTA	GDS61063	Drive Shaft	36		50.7	58.5	751				
1.2 TDi (55 kW)	2010.05-		MT	L	F	Estate Engine CFWA	GDS61302	Drive Shaft	36		50.5	59	479				
	2010.05-			R	F	Estate Engine CFWA	GDS61301	Drive Shaft	36		50.5	59	771				
1.2 TSi (63 kW)	2010.03-		MT		F	Estate Engine CBZA	GCI53002	Inner Joint		33		34					









		TRANSM	L/R	F/R		G-AP Ref.	PRODUCT	ABS	Technical Specifications							
									YEAR	A	B	C	H	L	P	
<b>SKODA</b>																
<b>FABIA COMBI</b>																
1.2 TSi (77 kW)	2010.03-				Estate Engine CBZB	GCI53002	Inner Joint		33		34					
1.4 (63 kW)	2007.11-				Estate Engine BXW/CGGB	GC083027	Outer Joint	36	30	50.7	58.5	47.5	I			
	2007.11-		L	F	Estate Engine BXW/CGGB	GDS83063	Drive Shaft	36		50.7	58.5	501				
	2007.11-		R	F	Estate Engine BXW/CGGB	GDS61063	Drive Shaft	36		50.7	58.5	751				
1.4 TDi (51 kW)	2007.11-				Estate Engine BNM	GC083024	Outer Joint	36	30	50.75	59	54.5	I			
	2007.11-		R	F	Estate Engine BNM	GDS61223	Drive Shaft	36		52	59	757				
1.4 TDi (59 kW)	2007.11-				Estate Engine BMS/BNV	GC083024	Outer Joint	36	30	50.75	59	54.5	I			
	2007.11-		L	F	Estate Engine BMS/BNV	GDS61098	Drive Shaft	36		50.5	59	472				
	2007.11-		R	F	Estate Engine BMS/BNV	GDS61099	Drive Shaft	36		50.5	59	759				
	2007.11-		L	F	Estate Engine BMS/BNV	GDS61135	Drive Shaft	36		52	59	475				
	2007.11-		R	F	Estate Engine BMS/BNV	GDS61136	Drive Shaft	36		52	59	763				
1.6 (77 kW)	2007.11-				Estate Engine BMS/BNV	GCI61062	Inner Joint		30		59					
	2007.11-				Estate Engine BTS/CFNA	GCI83011	Inner Joint		33		34					
	2007.11-				Estate Engine BTS/CFNA	GC083024	Outer Joint	36	30	50.75	59	54.5	I			
	2007.11-		L	F	Estate Engine BTS/CFNA	GDS61150	Drive Shaft	36	26	52	75	557				
1.6 TDi (55 kW)	2007.11-				Estate Engine BTS/CFNA	GCI61039	Inner Joint	26	22	31	68.5	88.5				
	2010.04-				Estate Engine CAYA	GCI53002	Inner Joint		33		34					
	2010.04-		L	F	Estate Engine CAYA	GDS61302	Drive Shaft	36		50.5	59	479				
1.6 TDi (66 kW)	2010.04-				Estate Engine CAYA	GDS61301	Drive Shaft	36		50.5	59	771				
	2010.03-				Estate Engine CAYB	GCI53002	Inner Joint		33		34					
	2010.03-		L	F	Estate Engine CAYB	GDS61302	Drive Shaft	36		50.5	59	479				
1.6 TDi (77 kW)	2010.03-				Estate Engine CAYB	GDS61301	Drive Shaft	36		50.5	59	771				
	2010.03-				Estate Engine CAYC	GCI53002	Inner Joint		33		34					
	2010.03-		L	F	Estate Engine CAYC	GDS61302	Drive Shaft	36		50.5	59	479				
1.9 TDi (77 kW)	2010.03-				Estate Engine CAYC	GDS61301	Drive Shaft	36		50.5	59	771				
	2007.11-				Estate Engine BLS/BSW	GC083024	Outer Joint	36	30	50.75	59	54.5	I			
	2007.11-		L	F	Estate Engine BLS/BSW	GDS61098	Drive Shaft	36		50.5	59	472				
	2007.11-		L	F	Estate Engine BLS/BSW	GDS61135	Drive Shaft	36		52	59	475				
	2007.11-		R	F	Estate Engine BLS/BSW	GDS61136	Drive Shaft	36		52	59	763				
2007.11-		R	F	Estate Engine BLS/BSW	GCI61062	Inner Joint		30		59						
<b>FABIA I (6Y2, 6Y3, 6Y5), SW</b>																
1.4 (50 kW)	1999.08-	2008.03				GC083027	Outer Joint	36	30	50.7	58.5	47.5	I			
1.4 16V (55 kW)	1999.12-	2007.03				GC083027	Outer Joint	36	30	50.7	58.5	47.5	I			
1.4 16V (74 kW)	1999.08-	2008.03				GC083027	Outer Joint	36	30	50.7	58.5	47.5	I			
1.9 SDi (47 kW)	1999.12-	2007.03				GC083027	Outer Joint	36	30	50.7	58.5	47.5	I			
<b>FABIA II (5J2), SW</b>																
1.2 (44 kW)	2006.12-	2011.11				GC083027	Outer Joint	36	30	50.7	58.5	47.5	I			
1.2 (51 kW)	2006.12-	2011.11				GC083027	Outer Joint	36	30	50.7	58.5	47.5	I			
1.2 16V (44 kW)	2006.12-	2011.11				GC083027	Outer Joint	36	30	50.7	58.5	47.5	I			
1.2 16V (51 kW)	2006.12-	2011.11				GC083027	Outer Joint	36	30	50.7	58.5	47.5	I			
1.4 (50 kW)	2001.07-	2007.12				GC083027	Outer Joint	36	30	50.7	58.5	47.5	I			
1.4 (63 kW)	2007.01-					GC083027	Outer Joint	36	30	50.7	58.5	47.5	I			
1.4 TSi (132 kW)	2010.05-					GCI83016	Inner Joint		28		32					
1.6 16V (77 kW)	2007.04-	2010.03	AT			GC061010	Outer Joint	36	30	52	75	54.5	I			
1.9 SDi (47 kW)	2001.07-	2007.12				GC083027	Outer Joint	36	30	50.7	58.5	47.5	I			
<b>FABIA PRAKTIK</b>																
1.2 (40 kW)	2001.07-	2007.12	MT		Box Engine AWY/BMD	GC054002	Outer Joint	20	30	52	59.5	49.5	I			
	2001.07-	2007.12	MT		Box Engine AWY/BMD	GC083027	Outer Joint	36	30	50.7	58.5	47.5	I			
	2001.07-	2007.12	5MT	L	Box Engine AWY/BMD	GDS83063	Drive Shaft	36		50.7	58.5	501				
	2001.07-	2007.12	5MT	R	Box Engine AWY/BMD	GDS61063	Drive Shaft	36		50.7	58.5	751				
1.2 (47 kW)	2003.01-	2007.12	MT		Box Engine AZQ/BME	GC054002	Outer Joint	20	30	52	59.5	49.5	I			
	2003.01-	2007.12	MT		Box Engine AZQ/BME	GC083027	Outer Joint	36	30	50.7	58.5	47.5	I			
	2003.01-	2007.12	5MT	L	Box Engine AZQ/BME	GDS83063	Drive Shaft	36		50.7	58.5	501				
	2003.01-	2007.12	5MT	R	Box Engine AZQ/BME	GDS61063	Drive Shaft	36		50.7	58.5	751				
1.4 (50 kW)	2001.07-	2003.05	MT		Box Engine AME/AQW/ATZ	GC054002	Outer Joint	20	30	52	59.5	49.5	I			
	2001.07-	2003.05	MT		Box Engine AME/AQW/ATZ	GC083027	Outer Joint	36	30	50.7	58.5	47.5	I			
1.4 TDi (51 kW)	2005.10-	2007.12	MT		Box Engine BNM	GC083024	Outer Joint	36	30	50.75	59	54.5	I			
	2005.10-	2007.12	MT	R	Box Engine BNM	GDS61223	Drive Shaft	36		52	59	757				
1.9 SDi (47 kW)	2001.07-	2007.12	MT		Box Engine ASY	GC054002	Outer Joint	20	30	52	59.5	49.5	I			
	2001.07-	2007.12	MT		Box Engine ASY	GC083027	Outer Joint	36	30	50.7	58.5	47.5	I			
	2001.07-	2007.12	5MT	L	Box Engine ASY	GDS83063	Drive Shaft	36		50.7	58.5	501				



		YEAR	TRANSM	L/R	F/R		G-AP Ref.	PRODUCT	ABS	Technical Specifications										
										A	B	C	H	L	P					
<b>SKODA</b>																				
<b>FABIA PRAKTIK</b>																				
1.9 SDi (47 kW)	2001.07-	2007.12	5MT	R	F	Box Engine ASY	GDS61063	Drive Shaft			36		50.7	58.5	751					
<b>FAVORIT (781)</b>																				
1.3 135 (42 kW)	1991.12-	1994.09	MT		F	Hatchback Engine 781.135	GCI54002	Inner Joint			22	22	40	60.2	94.5					
1.3 135 (43 kW)	1991.12-	1994.09	MT		F	Hatchback Engine 781.135	GCI54002	Inner Joint			22	22	40	60.2	94.5					
1.3 135 (44 kW)	1990.10-	1994.09	MT		F	Hatchback Engine 781.135	GCI54002	Inner Joint			22	22	40	60.2	94.5					
1.3 135 X,LX,GLX (40 kW)	1990.01-	1994.09	MT		F	Hatchback Engine 781.135E	GCI54002	Inner Joint			22	22	40	60.2	94.5					
1.3 135L (43 kW)	1989.05-	1994.09	MT		F	Hatchback Engine 781.135	GCI54002	Inner Joint			22	22	40	60.2	94.5					
1.3 136 (45 kW)	1990.10-	1994.09	MT		F	Hatchback Engine 136L	GCI54002	Inner Joint			22	22	40	60.2	94.5					
<b>FAVORIT (787)</b>																				
1.3 (40 kW)	1992.12-	1997.06	MT		F	Pickup Engine 135B	GCI54002	Inner Joint			22	22	40	60.2	94.5					
1.3 (42 kW)	1992.12-	1997.06	MT		F	Pickup Engine 781.135	GCI54002	Inner Joint			22	22	40	60.2	94.5					
1.3 (50 kW)	1992.12-	1997.06	MT		F	Pickup Engine 136B	GCI54002	Inner Joint			22	22	40	60.2	94.5					
<b>FAVORIT FORMAN (785)</b>																				
1.3 (40 kW)	1991.09-	1995.06	MT		F	Estate Engine 781.135E	GCI54002	Inner Joint			22	22	40	60.2	94.5					
1.3 (44 kW)	1991.12-	1995.06	MT		F	Estate Engine 781.135	GCI54002	Inner Joint			22	22	40	60.2	94.5					
1.3 (45 kW)	1991.08-	1995.06	MT		F	Estate Engine OHC	GCI54002	Inner Joint			22	22	40	60.2	94.5					
<b>FELICIA I FUN (797)</b>																				
1.3 (40 kW)	1997.06-	2002.04	MT		F	Pickup Engine 135B/135M/AMG	GC054001	Outer Joint			22	22	45	82	53.5	I				
	1997.06-	2002.04	MT		F	Pickup Engine 135B/135M/AMG	GCI54003	Inner Joint			22	30	40	60.2	94.5					
	1997.06-	2002.04	MT	L	F	Pickup Engine 135B/135M/AMG	GDS54001	Drive Shaft			22	22	45	82	599					
	1997.06-	2002.04	MT	R	F	Pickup Engine 135B/135M/AMG	GDS54002	Drive Shaft			22	22	45	82	861					
1.3 (50 kW)	1997.06-	2002.04	MT		F	Pickup Engine 136B/136M/AMH	GC054001	Outer Joint			22	22	45	82	53.5	I				
	1997.06-	2002.04	MT		F	Pickup Engine 136B/136M/AMH	GCI54003	Inner Joint			22	30	40	60.2	94.5					
	1997.06-	2002.04	MT	L	F	Pickup Engine 136B/136M/AMH	GDS54001	Drive Shaft			22	22	45	82	599					
	1997.06-	2002.04	MT	R	F	Pickup Engine 136B/136M/AMH	GDS54002	Drive Shaft			22	22	45	82	861					
1.6 (55 kW)	1997.06-	2002.04	MT		F	Pickup Engine AEE	GC054001	Outer Joint			22	22	45	82	53.5	I				
	1997.06-	2002.04	MT		F	Pickup Engine AEE	GCI54003	Inner Joint			22	30	40	60.2	94.5					
	1997.06-	2002.04	MT	L	F	Pickup Engine AEE	GDS54001	Drive Shaft			22	22	45	82	599					
	1997.06-	2002.04	MT	R	F	Pickup Engine AEE	GDS54002	Drive Shaft			22	22	45	82	861					
1.9 D (47 kW)	1997.06-	2002.04	MT		F	Pickup Engine AEF	GC054001	Outer Joint			22	22	45	82	53.5	I				
	1997.06-	2002.04	MT		F	Pickup Engine AEF	GCI54003	Inner Joint			22	30	40	60.2	94.5					
	1997.06-	2002.04	MT	L	F	Pickup Engine AEF	GDS54001	Drive Shaft			22	22	45	82	599					
	1997.06-	2002.04	MT	R	F	Pickup Engine AEF	GDS54002	Drive Shaft			22	22	45	82	861					
<b>OCTAVIA</b>																				
1.9 SDi	1999.03-		MT	L	F		GDS54003	Drive Shaft			36		53.2	77.5	555					
<b>OCTAVIA (1U2)</b>																				
1.4 16V (55 kW)	2000.09-	2010.12	5MT		F	Hatchback Engine AXP/BCA	GCI83008	Inner Joint				33		32						
	2000.09-	2010.12	MT		F	Hatchback Engine AXP/BCA	GC083033	Outer Joint			36	30	53	78.5	51	I				
	2000.09-	2010.12	MT	L	F	Hatchback Engine AXP/BCA	GDS61045	Drive Shaft			36		53	78.5	555					
	2000.09-	2010.12	MT	R	F	Hatchback Engine AXP/BCA	GDS83046	Drive Shaft			36		53	78.5	822					
1.6 (55 kW)	1996.09-	2004.09	5MT		F	Hatchback Engine AEE	GCI83008	Inner Joint				33		32						
	1996.09-	2004.09	AT		F	Hatchback Engine AEE	GC083036	Outer Joint			36	30	53.2	77.5	61	I				
	1996.09-	2004.09	MT		F	Hatchback Engine AEE	GC083033	Outer Joint			36	30	53	78.5	51	I				
	1996.09-	2004.09	MT		F	Hatchback Engine AEE	GCI83004	Inner Joint				33		32						
	1996.09-	2004.09	MT	L	F	Hatchback Engine AEE	GDS61045	Drive Shaft			36		53	78.5	555					
	1996.09-	2004.09	MT	R	F	Hatchback Engine AEE	GDS83046	Drive Shaft			36		53	78.5	822					
1.6 (74 kW)	1997.02-	2007.12	AT		F	Hatchback Engine AEH/AKL	GC083036	Outer Joint			36	30	53.2	77.5	61	I				
	1997.02-	2007.12	MT		F	Hatchback Engine AEH/AKL	GC083033	Outer Joint			36	30	53	78.5	51	I				
	1997.02-	2007.12	MT		F	Hatchback Engine AEH/AKL	GCI83004	Inner Joint				33		32						
	1997.02-	2007.12	MT/AT		F	Hatchback Engine AEH/AKL	GCI83008	Inner Joint				33		32						
	1997.02-	2007.12	AT	L	F	Hatchback Engine AEH/AKL	GDS61156	Drive Shaft			36		53	78	554.5					
	1997.02-	2007.12	AT	L	F	Hatchback Engine AEH/AKL	GCI61062	Inner Joint				30		59						
	1997.02-	2007.12	MT	L	F	Hatchback Engine AEH/AKL	GDS61045	Drive Shaft			36		53	78.5	555					
	1997.02-	2007.12	MT	R	F	Hatchback Engine AEH/AKL	GDS83046	Drive Shaft			36		53	78.5	822					
1.6 (75 kW)	2000.11-	2010.12			F	Hatchback Engine AVU/BFQ	GCI83008	Inner Joint				33		32						
	2000.11-	2010.12			F	Hatchback Engine AVU/BFQ	GC083036	Outer Joint			36	30	53.2	77.5	61	I				
	2000.11-	2010.12	MT		F	Hatchback Engine AVU/BFQ	GC083033	Outer Joint			36	30	53	78.5	51	I				
	2000.11-	2010.12	AT	L	F	Hatchback Engine AVU/BFQ	GDS61156	Drive Shaft			36		53	78	554.5					
	2000.11-	2010.12	AT	L	F	Hatchback Engine AVU/BFQ	GCI61062	Inner Joint				30		59						
	2000.11-	2010.12	MT	L	F	Hatchback Engine AVU/BFQ	GDS61045	Drive Shaft			36		53	78.5	555					
	2000.11-	2010.12	MT	R	F	Hatchback Engine AVU/BFQ	GDS83046	Drive Shaft			36		53	78.5	822					

		TRANSM	L/R	F/R		G-AP Ref.	PRODUCT	ABS	Technical Specifications							
									YEAR	A	B	C	H	L	P	
<b>SKODA OCTAVIA (1U2)</b>																
1.8 T (110 kW)	1997.08-2010.12	MT		F	Hatchback Engine AGU/ARX/ARZ/AUM	GCI83011	Inner Joint		33		34					
	1997.08-2010.12	MT		F	Hatchback Engine AGU/ARX/ARZ/AUM	GC083036	Outer Joint	36	30	53.2	77.5	61	I			
	1997.08-2010.12	MT/AT		F	Hatchback Engine AGU/ARX/ARZ/AUM	GCI61006	Inner Joint		30		57.6					
	1997.08-2010.12	MT	L	F	Hatchback Engine AGU/ARX/ARZ/AUM	GDS61021	Drive Shaft	36		53.2	77.5	564.5				
	1997.08-2010.12		L	F	Hatchback Engine AGU/ARX/ARZ/AUM	GDS61156	Drive Shaft	36		53	78	554.5				
	1997.08-2010.12		L	F	Hatchback Engine AGU/ARX/ARZ/AUM	GCI61062	Inner Joint		30		59					
1.8 T 4x4 (110 kW)	2001.05-2006.05	MT			Hatchback Engine ARX	GCI53002	Inner Joint		33		34					
	2001.05-2006.05	MT			Hatchback Engine ARX	GC083036	Outer Joint	36	30	53.2	77.5	61	I			
	2001.05-2006.05	MT		F	Hatchback Engine ARX	GCI83011	Inner Joint		33		34					
	2001.05-2006.05	MT	L	F	Hatchback Engine ARX	GDS61021	Drive Shaft	36		53.2	77.5	564.5				
	2001.05-2006.05	MT		R	Hatchback Engine ARX	GCI83003	Inner Joint		33		32					
1.9 SDi (50 kW)	1997.06-2003.12			F	Hatchback Engine AGP/AQM	GCI83008	Inner Joint		33		32					
	1997.06-2003.12	MT		F	Hatchback Engine AGP/AQM	GC083033	Outer Joint	36	30	53	78.5	51	I			
	1997.06-2003.12	MT		F	Hatchback Engine AGP/AQM	GCI83004	Inner Joint		33		32					
	1997.06-2003.12	MT	L	F	Hatchback Engine AGP/AQM	GDS61045	Drive Shaft	36		53	78.5	555				
	1997.06-2003.12	MT	R	F	Hatchback Engine AGP/AQM	GDS83046	Drive Shaft	36		53	78.5	822				
1.9 TDi (66 kW)	1996.09-2010.03	MT		F	Hatchback Engine AGR/ALH	GCI83009	Inner Joint		33		34					
	1996.09-2010.03	MT		F	Hatchback Engine AGR/ALH	GC083036	Outer Joint	36	30	53.2	77.5	61	I			
	1996.09-2010.03	MT	L	F	Hatchback Engine AGR/ALH	GDS61021	Drive Shaft	36		53.2	77.5	564.5				
	1996.09-2010.03	MT	L	F	Hatchback Engine AGR/ALH	GDS83006	Drive Shaft	36		53.2	77.5	557				
	1996.09-2010.03	MT	R	F	Hatchback Engine AGR/ALH	GDS83004	Drive Shaft	36		53.2	77.5	822				
1.9 TDi (74 kW)	2005.10-2010.12			F	Hatchback Engine AXR	GCI83011	Inner Joint		33		34					
	2005.10-2010.12	MT		F	Hatchback Engine AXR	GCI53002	Inner Joint		33		34					
	2005.10-2010.12		L	F	Hatchback Engine AXR	GDS83006	Drive Shaft	36		53.2	77.5	557				
	2005.10-2010.12	MT	L	F	Hatchback Engine AXR	GDS61021	Drive Shaft	36		53.2	77.5	564.5				
	2005.10-2010.12		R	F	Hatchback Engine AXR	GDS83004	Drive Shaft	36		53.2	77.5	822				
1.9 TDi (81 kW)	1997.08-2006.01	MT		F	Hatchback Engine AHF/ASV	GCI83009	Inner Joint		33		34					
	1997.08-2006.01	MT		F	Hatchback Engine AHF/ASV	GC083036	Outer Joint	36	30	53.2	77.5	61	I			
	1997.08-2006.01	MT	L	F	Hatchback Engine AHF/ASV	GDS61021	Drive Shaft	36		53.2	77.5	564.5				
	1997.08-2006.01	MT	L	F	Hatchback Engine AHF/ASV	GDS83006	Drive Shaft	36		53.2	77.5	557				
	1997.08-2006.01	MT	R	F	Hatchback Engine AHF/ASV	GDS83004	Drive Shaft	36		53.2	77.5	822				
1.9 TDi (96 kW)	2003.05-2004.05	MT		F	Hatchback Engine ASZ	GC083035	Outer Joint	36	27	53	77.5	65	I			
	2003.05-2004.05	MT/AT		F	Hatchback Engine ASZ	GC083036	Outer Joint	36	30	53.2	77.5	61	I			
	2003.05-2004.05		L	F	Hatchback Engine ASZ	GDS61123	Drive Shaft	36		53	77.5	520				
	2003.05-2004.05	MT	R	F	Hatchback Engine ASZ	GDS61121	Drive Shaft	36		53	77.5	806				
2.0 (85 kW)	1999.04-2007.05	MT		F	Hatchback Engine AEG/APK/AQY/AZH/AZJ	GCI83011	Inner Joint		33		34					
	1999.04-2007.05	MT		F	Hatchback Engine AEG/APK/AQY/AZH/AZJ	GC083036	Outer Joint	36	30	53.2	77.5	61	I			
	1999.04-2007.05	AT	L	F	Hatchback Engine AEG/APK/AQY/AZH/AZJ	GDS61156	Drive Shaft	36		53	78	554.5				
	1999.04-2007.05	AT	L	F	Hatchback Engine AEG/APK/AQY/AZH/AZJ	GCI61062	Inner Joint		30		59					
	1999.04-2007.05	MT	L	F	Hatchback Engine AEG/APK/AQY/AZH/AZJ	GDS61021	Drive Shaft	36		53.2	77.5	564.5				
	1999.04-2007.05	MT	R	F	Hatchback Engine AEG/APK/AQY/AZH/AZJ	GDS83004	Drive Shaft	36		53.2	77.5	822				
RS 1.8 T (132 kW)	2001.05-2006.01	MT		F	Hatchback Engine AUQ	GC083036	Outer Joint	36	30	53.2	77.5	61	I			
	2001.05-2006.01		L	F	Hatchback Engine AUQ	GDS61156	Drive Shaft	36		53	78	554.5				
	2001.05-2006.01		L	F	Hatchback Engine AUQ	GCI61062	Inner Joint		30		59					
<b>OCTAVIA (1U5)</b>																
1.4 16V (55 kW)	2000.08-2010.12			F	Estate Engine AXP/BCA	GCI83008	Inner Joint		33		32					
	2000.08-2010.12	MT		F	Estate Engine AXP/BCA	GC083033	Outer Joint	36	30	53	78.5	51	I			
	2000.08-2010.12	MT	L	F	Estate Engine AXP/BCA	GDS61045	Drive Shaft	36		53	78.5	555				
	2000.08-2010.12	MT	R	F	Estate Engine AXP/BCA	GDS83046	Drive Shaft	36		53	78.5	822				
1.6 (55 kW)	1998.07-2004.09	5MT		F	Estate Engine AEE	GCI83008	Inner Joint		33		32					
	1998.07-2004.09	MT		F	Estate Engine AEE	GC083033	Outer Joint	36	30	53	78.5	51	I			
	1998.07-2004.09	MT		F	Estate Engine AEE	GCI83004	Inner Joint		33		32					
	1998.07-2004.09	MT		F	Estate Engine AEE	GC083036	Outer Joint	36	30	53.2	77.5	61	I			
	1998.07-2004.09	MT	L	F	Estate Engine AEE	GDS61045	Drive Shaft	36		53	78.5	555				
	1998.07-2004.09	MT	R	F	Estate Engine AEE	GDS83046	Drive Shaft	36		53	78.5	822				
1.6 (74 kW)	1998.07-2007.12			F	Estate Engine AEH/AKL	GCI83008	Inner Joint		33		32					
	1998.07-2007.12	MT		F	Estate Engine AEH/AKL	GC083033	Outer Joint	36	30	53	78.5	51	I			
	1998.07-2007.12	MT		F	Estate Engine AEH/AKL	GCI83004	Inner Joint		33		32					
	1998.07-2007.12	MT		F	Estate Engine AEH/AKL	GC083036	Outer Joint	36	30	53.2	77.5	61	I			
	1998.07-2007.12	AT	L	F	Estate Engine AEH/AKL	GDS61156	Drive Shaft	36		53	78	554.5				
	1998.07-2007.12	AT	L	F	Estate Engine AEH/AKL	GCI61062	Inner Joint		30		59					









		TRANSM	L/R	F/R		G-AP Ref.	PRODUCT	ABS	Technical Specifications									
									YEAR	A	B	C	H	L	P			
<b>SKODA OCTAVIA (1U5)</b>																		
1.6 (74 kW)	1998.07-	2007.12	MT	L	F	Estate Engine AEH/AKL	GDS61045	Drive Shaft	36		53	78.5	555					
	1998.07-	2007.12	MT	R	F	Estate Engine AEH/AKL	GDS83046	Drive Shaft	36		53	78.5	822					
1.6 (75 kW)	2000.09-	2010.12			F	Estate Engine AVU/BFQ	GCI83008	Inner Joint		33		32						
	2000.09-	2010.12	AT		F	Estate Engine AVU/BFQ	GC083036	Outer Joint	36	30	53.2	77.5	61	I				
	2000.09-	2010.12	MT		F	Estate Engine AVU/BFQ	GC083033	Outer Joint	36	30	53	78.5	51	I				
	2000.09-	2010.12	AT	L	F	Estate Engine AVU/BFQ	GDS61156	Drive Shaft	36		53	78	554.5					
	2000.09-	2010.12	AT	L	F	Estate Engine AVU/BFQ	GCI61062	Inner Joint		30		59						
	2000.09-	2010.12	MT	L	F	Estate Engine AVU/BFQ	GDS61045	Drive Shaft	36		53	78.5	555					
	2000.09-	2010.12	MT	R	F	Estate Engine AVU/BFQ	GDS83046	Drive Shaft	36		53	78.5	822					
1.8 T (110 kW)	1998.07-	2010.12	MT		F	Estate Engine AGU/ARX/ARZ/AUM	GCI83011	Inner Joint		33		34						
	1998.07-	2010.12	MT		F	Estate Engine AGU/ARX/ARZ/AUM	GC083036	Outer Joint	36	30	53.2	77.5	61	I				
	1998.07-	2010.12	MT/AT		F	Estate Engine AGU/ARX/ARZ/AUM	GCI61006	Inner Joint		30		57.6						
	1998.07-	2010.12	MT	L	F	Estate Engine AGU/ARX/ARZ/AUM	GDS61021	Drive Shaft	36		53.2	77.5	564.5					
	1998.07-	2010.12		L	F	Estate Engine AGU/ARX/ARZ/AUM	GDS61156	Drive Shaft	36		53	78	554.5					
	1998.07-	2010.12		L	F	Estate Engine AGU/ARX/ARZ/AUM	GCI61062	Inner Joint		30		59						
1.8 T 4x4 (110 kW)	2001.05-	2006.05	MT			Estate Engine ARX	GCI53002	Inner Joint		33		34						
	2001.05-	2006.05	MT			Estate Engine ARX	GC083036	Outer Joint	36	30	53.2	77.5	61	I				
	2001.05-	2006.05	MT		F	Estate Engine ARX	GCI83011	Inner Joint		33		34						
	2001.05-	2006.05	MT	L	F	Estate Engine ARX	GDS61021	Drive Shaft	36		53.2	77.5	564.5					
	2001.05-	2006.05	MT		R	Estate Engine ARX	GCI83003	Inner Joint		33		32						
1.9 SDi (50 kW)	1998.07-	2003.12	MT		F	Estate Engine AGP/AQM	GC083033	Outer Joint	36	30	53	78.5	51	I				
	1998.07-	2003.12	MT		F	Estate Engine AGP/AQM	GCI83008	Inner Joint		33		32						
	1998.07-	2003.12	MT	L	F	Estate Engine AGP/AQM	GDS61045	Drive Shaft	36		53	78.5	555					
	1998.07-	2003.12	MT	R	F	Estate Engine AGP/AQM	GDS83046	Drive Shaft	36		53	78.5	822					
1.9 TDi (66 kW)	1998.07-	2010.03	MT		F	Estate Engine AGR/ALH	GCI83009	Inner Joint		33		34						
	1998.07-	2010.03	MT		F	Estate Engine AGR/ALH	GC083036	Outer Joint	36	30	53.2	77.5	61	I				
	1998.07-	2010.03	MT	L	F	Estate Engine AGR/ALH	GDS61021	Drive Shaft	36		53.2	77.5	564.5					
	1998.07-	2010.03	MT	L	F	Estate Engine AGR/ALH	GDS83006	Drive Shaft	36		53.2	77.5	557					
	1998.07-	2010.03	MT	R	F	Estate Engine AGR/ALH	GDS83004	Drive Shaft	36		53.2	77.5	822					
1.9 TDi (74 kW)	2000.08-	2010.12			F	Estate Engine ATD/AXR	GCI83011	Inner Joint		33		34						
	2000.08-	2010.12	MT		F	Estate Engine ATD/AXR	GCI53002	Inner Joint		33		34						
	2000.08-	2010.12		L	F	Estate Engine ATD/AXR	GDS83006	Drive Shaft	36		53.2	77.5	557					
	2000.08-	2010.12	5MT	L	F	Estate Engine ATD/AXR	GDS61021	Drive Shaft	36		53.2	77.5	564.5					
	2000.08-	2010.12		R	F	Estate Engine ATD/AXR	GDS83004	Drive Shaft	36		53.2	77.5	822					
1.9 TDi (81 kW)	1998.07-	2006.01	MT		F	Estate Engine AHF/ASV	GCI83009	Inner Joint		33		34						
	1998.07-	2006.01	MT		F	Estate Engine AHF/ASV	GC083036	Outer Joint	36	30	53.2	77.5	61	I				
	1998.07-	2006.01	MT	L	F	Estate Engine AHF/ASV	GDS61021	Drive Shaft	36		53.2	77.5	564.5					
	1998.07-	2006.01	MT	L	F	Estate Engine AHF/ASV	GDS83006	Drive Shaft	36		53.2	77.5	557					
	1998.07-	2006.01	MT	R	F	Estate Engine AHF/ASV	GDS83004	Drive Shaft	36		53.2	77.5	822					
1.9 TDi (96 kW)	2003.05-	2005.05	4MT/AT		F	Estate Engine ASZ	GC083036	Outer Joint	36	30	53.2	77.5	61	I				
	2003.05-	2005.05	MT		F	Estate Engine ASZ	GC083035	Outer Joint	36	27	53	77.5	65	I				
	2003.05-	2005.05	MT	L	F	Estate Engine ASZ	GDS61123	Drive Shaft	36		53	77.5	520					
	2003.05-	2005.05	MT	R	F	Estate Engine ASZ	GDS61121	Drive Shaft	36		53	77.5	806					
1.9 TDi 4x4 (66 kW)	1999.11-	2006.02	MT			Estate Engine AGR	GC083036	Outer Joint	36	30	53.2	77.5	61	I				
	1999.11-	2006.02	MT		F	Estate Engine AGR	GCI83011	Inner Joint		33		34						
	1999.11-	2006.02	MT		R	Estate Engine AGR	GCI83003	Inner Joint		33		32						
1.9 TDi 4x4 (74 kW)	2000.09-	2006.01	MT			Estate Engine ATD	GCI53002	Inner Joint		33		34						
	2000.09-	2006.01	MT	L	F	Estate Engine ATD	GDS61123	Drive Shaft	36		53	77.5	520					
	2000.09-	2006.01		R	F	Estate Engine ATD	GDS61186	Drive Shaft	36		53	77.5	653					
	2000.09-	2006.01		R	F	Estate Engine ATD	GCI61002	Inner Joint		28		31.8						
	2000.09-	2006.01		R	F	Estate Engine ATD	GC083035	Outer Joint	36	27	53	77.5	65	I				
	2000.09-	2006.01	MT		R	Estate Engine ATD	GCI83003	Inner Joint		33		32						
2.0 (85 kW)	1999.04-	2007.05	MT		F	Estate Engine AEG/APK/AQY/AZH/AZJ	GC083036	Outer Joint	36	30	53.2	77.5	61	I				
	1999.04-	2007.05	MT		F	Estate Engine AEG/APK/AQY/AZH/AZJ	GCI83011	Inner Joint		33		34						
	1999.04-	2007.05	AT	L	F	Estate Engine AEG/APK/AQY/AZH/AZJ	GDS61156	Drive Shaft	36		53	78	554.5					
	1999.04-	2007.05	AT	L	F	Estate Engine AEG/APK/AQY/AZH/AZJ	GCI61062	Inner Joint		30		59						
	1999.04-	2007.05		L	F	Estate Engine AEG/APK/AQY/AZH/AZJ	GDS61021	Drive Shaft	36		53.2	77.5	564.5					
	1999.04-	2007.05	MT	R	F	Estate Engine AEG/APK/AQY/AZH/AZJ	GDS83004	Drive Shaft	36		53.2	77.5	822					
2.0 4x4 (85 kW)	2000.08-	2004.09	MT			Estate Engine AZJ/AZH	GC083036	Outer Joint	36	30	53.2	77.5	61	I				
	2000.08-	2004.09	MT			Estate Engine AZJ/AZH	GCI53002	Inner Joint		33		34						
	2000.08-	2004.09	MT		F	Estate Engine AZJ/AZH	GCI83011	Inner Joint		33		34						



		TRANSM	L/R	F/R		G-AP Ref.	PRODUCT	ABS	Technical Specifications					
									YEAR	A	B	C	H	L
<b>SKODA OCTAVIA (1U5)</b>														
2.0 4x4 (85 kW)	2000.08-	2004.09	MT		R	Estate Engine AZJ/AZH	GCI83003	Inner Joint		33		32		
	2000.08-	2004.09		L		Estate Engine AZJ/AZH	GDS61156	Drive Shaft	36		53	78	554.5	
	2000.08-	2004.09		L		Estate Engine AZJ/AZH	GCI61062	Inner Joint		30		59		
2.0 4x4 (88 kW)	2000.01-	2010.12				Estate Engine ATF	GC083036	Outer Joint	36	30	53.2	77.5	61	I
	2000.01-	2010.12	MT		F	Estate Engine ATF	GCI83011	Inner Joint		33		34		
	2000.01-	2010.12	MT		R	Estate Engine ATF	GCI83003	Inner Joint		33		32		
RS 1.8 T (132 kW)	2002.08-	2006.01	MT		F	Estate Engine AUQ	GC083036	Outer Joint	36	30	53.2	77.5	61	I
	2002.08-	2006.01		L	F	Estate Engine AUQ	GDS61156	Drive Shaft	36		53	78	554.5	
	2002.08-	2006.01		L	F	Estate Engine AUQ	GCI61062	Inner Joint		30		59		
<b>OCTAVIA (1Z3)</b>														
1.2 TSi (77 kW)	2010.02-		MT		F	Hatchback Engine CBZB	GCI53002	Inner Joint		33		34		
	2010.02-					Hatchback Engine CBZB	GC061059	Outer Joint	36	33	59.5	40	59.5	I
1.4 (55 kW)	2004.05-	2006.05			F	Hatchback Engine BCA	GCI83008	Inner Joint		33		32		
	2004.05-	2006.05	MT		F	Hatchback Engine BCA	GC053001	Outer Joint	36	30	59.5	40	49	I
	2004.05-	2006.05		L	F	Hatchback Engine BCA	GDS61045	Drive Shaft	36		53	78.5	555	
	2004.05-	2006.05		L	F	Hatchback Engine BCA	GDS53007	Drive Shaft	36		59.5	40	559	
	2004.05-	2006.05		R	F	Hatchback Engine BCA	GDS83046	Drive Shaft	36		53	78.5	822	
1.4 (59 kW)	2006.07-				F	Hatchback Engine BUD/CGGA	GC053001	Outer Joint	36	30	59.5	40	49	I
	2006.07-				F	Hatchback Engine BUD/CGGA	GCI83008	Inner Joint		33		32		
	2006.07-		AT		F	Hatchback Engine BUD/CGGA	GC083037	Outer Joint	36	30	59.5	40.5	55	I
	2006.07-		MT	L	F	Hatchback Engine BUD/CGGA	GDS53007	Drive Shaft	36		59.5	40	559	
1.4 TSi (90 kW)	2008.11-		MT		F	Hatchback Engine CAXA	GCI53002	Inner Joint		33		34		
	2008.11-		AT	L	F	Hatchback Engine CAXA	GDS61281	Drive Shaft	36		59.5	40	528	
	2008.11-		MT	L	F	Hatchback Engine CAXA	GDS61198	Drive Shaft	36		59.5	40.5	530	
	2008.11-		AT	R	F	Hatchback Engine CAXA	GDS61200	Drive Shaft	36		59.5	40.5	820	
	2008.11-		AT			Hatchback Engine CAXA	GC083100	Outer Joint	36	33	59.5	38	55	I
	2008.11-				F	Hatchback Engine CAXA	GCI83011	Inner Joint		33		34		
1.6 (75 kW)	2004.06-				F	Hatchback Engine BGU/BSE/BSF/CCSA/CMXA	GC083037	Outer Joint	36	30	59.5	40.5	55	I
	2004.06-		MT		F	Hatchback Engine BGU/BSE/BSF/CCSA/CMXA	GCI53002	Inner Joint		33		34		
	2004.06-		AT	L	F	Hatchback Engine BGU/BSE/BSF/CCSA/CMXA	GDS83318	Drive Shaft	36	26	59.5	38	581	
	2004.06-		MT	L	F	Hatchback Engine BGU/BSE/BSF/CCSA/CMXA	GDS83320	Drive Shaft	36		59.5	40	546	
	2004.06-		MT	L	F	Hatchback Engine BGU/BSE/BSF/CCSA/CMXA	GDS61089	Drive Shaft	36		59.5	40.5	521	
	2004.06-		AT	R	F	Hatchback Engine BGU/BSE/BSF/CCSA/CMXA	GDS83346	Drive Shaft	36	26	59.5	38	879	
	2004.06-		AT	R	F	Hatchback Engine BGU/BSE/BSF/CCSA/CMXA	GCI61011	Inner Joint	26	32	31	68.5	85	
	2004.06-		AT	R	F	Hatchback Engine BGU/BSE/BSF/CCSA/CMXA	GC083116	Outer Joint	36	30	59.5	38	55	I
1.6 FSi (85 kW)	2004.02-	2008.10	AT/6AT		F	Hatchback Engine BLF	GC083037	Outer Joint	36	30	59.5	40.5	55	I
	2004.02-	2008.10	MT		F	Hatchback Engine BLF	GCI53002	Inner Joint		33		34		
	2004.02-	2008.10	MT	L	F	Hatchback Engine BLF	GDS83319	Drive Shaft	36		59.5	38	557	
1.6 LPG (75 kW)	2009.08-			L	F	Hatchback Engine CHGA	GDS83320	Drive Shaft	36		59.5	40	546	
	2009.08-		MT	L	F	Hatchback Engine CHGA	GDS61089	Drive Shaft	36		59.5	40.5	521	
1.6 MultiFuel (75 kW)	2008.01-			L	F	Hatchback Engine CCSA/CMXA	GDS83320	Drive Shaft	36		59.5	40	546	
	2008.01-		MT	L	F	Hatchback Engine CCSA/CMXA	GDS61089	Drive Shaft	36		59.5	40.5	521	
1.6 TDi (77 kW)	2009.06-				F	Hatchback Engine CAYC	GC083037	Outer Joint	36	30	59.5	40.5	55	I
	2009.06-		MT		F	Hatchback Engine CAYC	GCI53002	Inner Joint		33		34		
	2009.06-		MT	L	F	Hatchback Engine CAYC	GDS83294	Drive Shaft	36		59.5	38	519	
	2009.06-		5MT	L	F	Hatchback Engine CAYC	GDS61089	Drive Shaft	36		59.5	40.5	521	
	2009.06-		AT	R	F	Hatchback Engine CAYC	GDS61280	Drive Shaft	36		59.5	40	801	
	2009.06-		MT	R	F	Hatchback Engine CAYC	GDS61200	Drive Shaft	36		59.5	40.5	820	
1.8 TSi (112 kW)	2009.03-		AT	L	F	Hatchback Engine CDAB	GDS83236	Drive Shaft	36		59.5	40	484	
	2009.03-		MT	L	F	Hatchback Engine CDAB	GDS61131	Drive Shaft	36		59.5	40	515	
	2009.03-					Hatchback Engine CDAB	GC061059	Outer Joint	36	33	59.5	40	59.5	I
	2007.06-		MT		F	Hatchback Engine BZB/CDAA	GC083002	Outer Joint	36	27	59.5	40	66	I
1.8 TSi (118 kW)	2007.06-		MT	L	F	Hatchback Engine BZB/CDAA	GDS61131	Drive Shaft	36		59.5	40	515	
	2007.06-					Hatchback Engine BZB/CDAA	GC061059	Outer Joint	36	33	59.5	40	59.5	I
	2007.06-					Hatchback Engine BZB/CDAA	GC061059	Outer Joint	36	33	59.5	40	59.5	I
1.9 TDi (77 kW)	2004.06-	2010.12	6AT		F	Hatchback Engine BJB/BKC/BLS/BXE	GCI54004	Inner Joint		34		85		
	2004.06-	2010.12	MT		F	Hatchback Engine BJB/BKC/BLS/BXE	GCI53002	Inner Joint		33		34		
	2004.06-	2010.12	MT/6MT		F	Hatchback Engine BJB/BKC/BLS/BXE	GC083037	Outer Joint	36	30	59.5	40.5	55	I
	2004.06-	2010.12	MT/AT		F	Hatchback Engine BJB/BKC/BLS/BXE	GC083002	Outer Joint	36	27	59.5	40	66	I
	2004.06-	2010.12	AT	L	F	Hatchback Engine BJB/BKC/BLS/BXE	GDS83241	Drive Shaft	36		59.5	40	475	
	2004.06-	2010.12	AT	L	F	Hatchback Engine BJB/BKC/BLS/BXE	GDS54013	Drive Shaft	36		59.5	40	479.5	

		TRANSM	L/R	F/R		G-AP Ref.	PRODUCT	ABS	Technical Specifications								
									YEAR	A	B	C	H	L	P		
<b>SKODA OCTAVIA (1Z3)</b>																	
1.9 TDi (77 kW)	2004.06-	2010.12	MT	L	F	Hatchback Engine BJB/BKC/BLS/BXE	GDS61089	Drive Shaft	36		59.5	40.5	521				
	2004.06-	2010.12	MT	L	F	Hatchback Engine BJB/BKC/BLS/BXE	GDS61156	Drive Shaft	36		53	78	554.5				
	2004.06-	2010.12	MT	L	F	Hatchback Engine BJB/BKC/BLS/BXE	GCI61062	Inner Joint		30		59					
	2004.06-	2010.12	MT	L	F	Hatchback Engine BJB/BKC/BLS/BXE	GDS83294	Drive Shaft	36		59.5	38	519				
	2004.06-	2010.12	AT	L/R	F	Hatchback Engine BJB/BKC/BLS/BXE	GCI61057	Inner Joint		34		86					
	2004.06-	2010.12	AT	R	F	Hatchback Engine BJB/BKC/BLS/BXE	GDS83355	Drive Shaft	36	23	59.5	40	799				
	2004.06-	2010.12	AT	R	F	Hatchback Engine BJB/BKC/BLS/BXE	GDS54011	Drive Shaft	36		59.5	40	755				
2.0 FSi (110 kW)	2004.11-				F	Hatchback Engine BLR/BLY/BVY/BVZ	GC083037	Outer Joint	36	30	59.5	40.5	55	I			
	2004.11-		6AT		F	Hatchback Engine BLR/BLY/BVY/BVZ	GCI61011	Inner Joint	26	32	31	68.5	85				
	2004.11-		MT		F	Hatchback Engine BLR/BLY/BVY/BVZ	GCI83011	Inner Joint		33		34					
	2004.11-		6AT	L	F	Hatchback Engine BLR/BLY/BVY/BVZ	GDS61093	Drive Shaft	36	26	59.5	40.5	587.5				
	2004.11-		6AT	R	F	Hatchback Engine BLR/BLY/BVY/BVZ	GDS61094	Drive Shaft	36	26	59.5	40.5	884				
	2004.11-		MT	R	F	Hatchback Engine BLR/BLY/BVY/BVZ	GDS61113	Drive Shaft	36		59.5	40	814				
2.0 RS (147 kW)	2005.10-		MT		F	Hatchback Engine BWA/CCZA	GC083002	Outer Joint	36	27	59.5	40	66	I			
	2005.10-		MT	L	F	Hatchback Engine BWA/CCZA	GDS83236	Drive Shaft	36		59.5	40	484				
	2005.10-		MT	R	F	Hatchback Engine BWA/CCZA	GDS61126	Drive Shaft	36		59.5	40	793				
2.0 TDi (100 kW)	2004.02-	2010.05			F	Hatchback Engine AZV	GC083002	Outer Joint	36	27	59.5	40	66	I			
	2004.02-	2010.05	6AT		F	Hatchback Engine AZV	GCI54004	Inner Joint		34		85					
	2004.02-	2010.05	AT	L	F	Hatchback Engine AZV	GDS83241	Drive Shaft	36		59.5	40	475				
	2004.02-	2010.05	AT	L	F	Hatchback Engine AZV	GDS54013	Drive Shaft	36		59.5	40	479.5				
	2004.02-	2010.05	MT	L	F	Hatchback Engine AZV	GDS83236	Drive Shaft	36		59.5	40	484				
	2004.02-	2010.05	MT	L	F	Hatchback Engine AZV	GDS83295	Drive Shaft	36		59.5	40	491				
	2004.02-	2010.05	AT	L/R	F	Hatchback Engine AZV	GCI61057	Inner Joint		34		86					
	2004.02-	2010.05	AT	R	F	Hatchback Engine AZV	GDS83355	Drive Shaft	36	23	59.5	40	799				
	2004.02-	2010.05	AT	R	F	Hatchback Engine AZV	GDS54011	Drive Shaft	36		59.5	40	755				
	2004.02-	2010.05	MT	R	F	Hatchback Engine AZV	GDS61126	Drive Shaft	36		59.5	40	793				
2.0 TDi (103 kW)	2007.01-		6AT		F	Hatchback Engine BMM	GCI54004	Inner Joint		34		85					
	2007.01-		MT		F	Hatchback Engine BMM	GC083002	Outer Joint	36	27	59.5	40	66	I			
	2007.01-		MT		F	Hatchback Engine BMM	GCI53002	Inner Joint		33		34					
	2007.01-		AT	L	F	Hatchback Engine BMM	GDS54013	Drive Shaft	36		59.5	40	479.5				
	2007.01-		MT	L	F	Hatchback Engine BMM	GDS83295	Drive Shaft	36		59.5	40	491				
	2007.01-		AT	R	F	Hatchback Engine BMM	GDS54011	Drive Shaft	36		59.5	40	755				
	2007.01-		MT	R	F	Hatchback Engine BMM	GDS83313	Drive Shaft	36		59.5	40	792				
	2007.01-		AT	L	F	Hatchback Engine BMM	GDS83241	Drive Shaft	36		59.5	40	475				
	2007.01-		MT	L	F	Hatchback Engine BMM	GDS83236	Drive Shaft	36		59.5	40	484				
	2007.01-		AT	L/R	F	Hatchback Engine BMM	GCI61057	Inner Joint		34		86					
	2007.01-		AT	R	F	Hatchback Engine BMM	GDS83355	Drive Shaft	36	23	59.5	40	799				
2.0 TDi (81 kW)	2010.03-				L	F	Hatchback Engine CFHF/CLCA	GDS83294	Drive Shaft	36		59.5	38	519			
	2010.03-				R	F	Hatchback Engine CFHF/CLCA	GDS61042	Drive Shaft	36		59.5	40.5	814			
	2010.03-		MT		L	F	Hatchback Engine CFHF/CLCA	GDS83236	Drive Shaft	36		59.5	40	484			
	2010.03-		MT	R	F	Hatchback Engine CFHF/CLCA	GDS61126	Drive Shaft	36		59.5	40	793				
2.0 TDi 16V (103 kW)	2004.02-		6AT		F	Hatchback Engine BKD/CFHC/CLCB	GCI54004	Inner Joint		34		85					
	2004.02-		MT		F	Hatchback Engine BKD/CFHC/CLCB	GC083002	Outer Joint	36	27	59.5	40	66	I			
	2004.02-		MT		F	Hatchback Engine BKD/CFHC/CLCB	GCI53002	Inner Joint		33		34					
	2004.02-		AT	L	F	Hatchback Engine BKD/CFHC/CLCB	GDS54013	Drive Shaft	36		59.5	40	479.5				
	2004.02-		MT	L	F	Hatchback Engine BKD/CFHC/CLCB	GDS83295	Drive Shaft	36		59.5	40	491				
	2004.02-		AT	R	F	Hatchback Engine BKD/CFHC/CLCB	GDS54011	Drive Shaft	36		59.5	40	755				
	2004.02-		MT	R	F	Hatchback Engine BKD/CFHC/CLCB	GDS83313	Drive Shaft	36		59.5	40	792				
	2004.02-		AT	L	F	Hatchback Engine BKD/CFHC/CLCB	GDS83241	Drive Shaft	36		59.5	40	475				
	2004.02-		MT	L	F	Hatchback Engine BKD/CFHC/CLCB	GDS83236	Drive Shaft	36		59.5	40	484				
	2004.02-		AT	L/R	F	Hatchback Engine BKD/CFHC/CLCB	GCI61057	Inner Joint		34		86					
	2004.02-		AT	R	F	Hatchback Engine BKD/CFHC/CLCB	GDS83355	Drive Shaft	36	23	59.5	40	799				
	2004.02-		MT	R	F	Hatchback Engine BKD/CFHC/CLCB	GDS61126	Drive Shaft	36		59.5	40	793				
2.0 TDi RS (125 kW)	2006.04-		MT	L	F	Hatchback Engine BMN/CEGA	GDS83265	Drive Shaft	36		59.5	40	487				
	2006.04-		AT	L	F	Hatchback Engine BMN/CEGA	GDS83241	Drive Shaft	36		59.5	40	475				
	2006.04-		MT	L	F	Hatchback Engine BMN/CEGA	GDS83236	Drive Shaft	36		59.5	40	484				
	2006.04-		MT	L	F	Hatchback Engine BMN/CEGA	GCI83016	Inner Joint		28		32					
	2006.04-		AT	L/R	F	Hatchback Engine BMN/CEGA	GCI61057	Inner Joint		34		86					









		TRANSM	L/R	F/R		G-AP Ref.	PRODUCT	ABS	Technical Specifications								
									YEAR	A	B	C	H	L	P		
<b>SKODA</b>																	
<b>OCTAVIA (1Z3)</b>																	
2.0 TDi RS (125 kW)	2006.04-		MT	R	F	Hatchback Engine BMN/CEGA	GDS61126	Drive Shaft		36		59.5	40	793			
<b>OCTAVIA (1Z5)</b>																	
1.2 TSi (77 kW)	2010.02-		MT		F	Estate Engine CBZB	GCI53002	Inner Joint			33		34				
	2010.02-					Estate Engine CBZB	GC061059	Outer Joint	36	33	59.5	40	59.5	I			
1.4 (55 kW)	2004.05-	2006.05			L	F	Estate Engine BCA	GDS53007	Drive Shaft	36		59.5	40	559			
1.4 (59 kW)	2006.05-					F	Estate Engine BUD/CGGA	GC053001	Outer Joint	36	30	59.5	40	49	I		
	2006.05-					F	Estate Engine BUD/CGGA	GCI83008	Inner Joint		33		32				
	2006.05-		AT			F	Estate Engine BUD/CGGA	GC083037	Outer Joint	36	30	59.5	40.5	55	I		
	2006.05-		MT	L	F	Estate Engine BUD/CGGA	GDS53007	Drive Shaft	36		59.5	40	559				
1.4 TSi (90 kW)	2008.11-					F	Estate Engine CAXA	GCI83011	Inner Joint		33		34				
	2008.11-		MT			F	Estate Engine CAXA	GCI53002	Inner Joint		33		34				
	2008.11-		MT	L	F	Estate Engine CAXA	GDS61198	Drive Shaft	36		59.5	40.5	530				
1.6 (75 kW)	2004.11-	2005.12				F	Estate Engine BGU/BSE/BSF/CCSA/CMXA	GCI83011	Inner Joint		33		34				
	2004.11-	2005.12				F	Estate Engine BGU/BSE/BSF/CCSA/CMXA	GC083037	Outer Joint	36	30	59.5	40.5	55	I		
	2004.11-	2005.12	MT			F	Estate Engine BGU/BSE/BSF/CCSA/CMXA	GCI53002	Inner Joint		33		34				
	2004.11-	2005.12	AT	L	F	Estate Engine BGU/BSE/BSF/CCSA/CMXA	GDS83318	Drive Shaft	36	26	59.5	38	581				
	2004.11-	2005.12	MT	L	F	Estate Engine BGU/BSE/BSF/CCSA/CMXA	GDS61089	Drive Shaft	36		59.5	40.5	521				
	2004.11-	2005.12	MT	L	F	Estate Engine BGU/BSE/BSF/CCSA/CMXA	GDS83320	Drive Shaft	36		59.5	40	546				
	2004.11-	2005.12	AT	R	F	Estate Engine BGU/BSE/BSF/CCSA/CMXA	GDS83346	Drive Shaft	36	26	59.5	38	879				
	2004.11-	2005.12	AT	R	F	Estate Engine BGU/BSE/BSF/CCSA/CMXA	GCI61011	Inner Joint	26	32	31	68.5	85				
	2004.11-	2005.12	AT	R	F	Estate Engine BGU/BSE/BSF/CCSA/CMXA	GC083116	Outer Joint	36	30	59.5	38	55	I			
1.6 FSi (85 kW)	2004.11-	2007.03	AT/6AT			F	Estate Engine BLF	GC083037	Outer Joint	36	30	59.5	40.5	55	I		
	2004.11-	2007.03	MT			F	Estate Engine BLF	GCI83011	Inner Joint		33		34				
	2004.11-	2007.03	MT	L	F	Estate Engine BLF	GDS83319	Drive Shaft	36		59.5	38	557				
	2004.11-	2007.03	MT	R	F	Estate Engine BLF	GDS61211	Drive Shaft	36		59.5	40.5	784				
1.6 LPG (75 kW)	2009.08-				L	F	Estate Engine CHGA	GDS83320	Drive Shaft	36		59.5	40	546			
	2009.08-		MT	L	F	Estate Engine CHGA	GDS61089	Drive Shaft	36		59.5	40.5	521				
1.6 MultiFuel (75 kW)	2008.01-				L	F	Estate Engine CCSA/CMXA	GDS83320	Drive Shaft	36		59.5	40	546			
	2008.01-		MT	L	F	Estate Engine CCSA/CMXA	GDS61089	Drive Shaft	36		59.5	40.5	521				
1.6 TDi (77 kW)	2009.06-					F	Estate Engine CAYC	GC083037	Outer Joint	36	30	59.5	40.5	55	I		
	2009.06-		MT			F	Estate Engine CAYC	GCI53002	Inner Joint		33		34				
	2009.06-		MT	L	F	Estate Engine CAYC	GDS83294	Drive Shaft	36		59.5	38	519				
	2009.06-		5MT	L	F	Estate Engine CAYC	GDS61089	Drive Shaft	36		59.5	40.5	521				
	2009.06-		AT	R	F	Estate Engine CAYC	GDS61280	Drive Shaft	36		59.5	40	801				
	2009.06-		MT	R	F	Estate Engine CAYC	GDS61200	Drive Shaft	36		59.5	40.5	820				
	2009.06-		AT			Estate Engine CAYC	GC083100	Outer Joint	36	33	59.5	38	55	I			
1.6 TDi 4x4 (77 kW)	2009.06-				L		Estate Engine CAYC	GDS83295	Drive Shaft	36		59.5	40	491			
	2009.06-				R		Estate Engine CAYC	GDS83266	Drive Shaft	36		59.5	40	601			
	2009.06-		MT	L	F	Estate Engine CAYC	GDS83236	Drive Shaft	36		59.5	40	484				
	2009.06-				R		Estate Engine CAYC	GCI83016	Inner Joint		28		32				
1.8 TSi (112 kW)	2009.03-		AT	L	F	Estate Engine CDAB	GDS83236	Drive Shaft	36		59.5	40	484				
	2009.03-		MT	L	F	Estate Engine CDAB	GDS61131	Drive Shaft	36		59.5	40	515				
	2009.03-					Estate Engine CDAB	GC061059	Outer Joint	36	33	59.5	40	59.5	I			
1.8 TSi (118 kW)	2007.06-		MT			F	Estate Engine BZB/CDA A	GC083002	Outer Joint	36	27	59.5	40	66	I		
	2007.06-		AT	L	F	Estate Engine BZB/CDA A	GDS83236	Drive Shaft	36		59.5	40	484				
	2007.06-		MT	L	F	Estate Engine BZB/CDA A	GDS61131	Drive Shaft	36		59.5	40	515				
	2007.06-					Estate Engine BZB/CDA A	GC061059	Outer Joint	36	33	59.5	40	59.5	I			
1.8 TSi 4x4 (112 kW)	2009.03-				L		Estate Engine CDAB	GDS83295	Drive Shaft	36		59.5	40	491			
	2009.03-				R		Estate Engine CDAB	GDS83266	Drive Shaft	36		59.5	40	601			
	2009.03-		MT	L	F	Estate Engine CDAB	GDS83236	Drive Shaft	36		59.5	40	484				
	2009.03-				R		Estate Engine CDAB	GCI83016	Inner Joint		28		32				
	2009.03-					Estate Engine CDAB	GC061059	Outer Joint	36	33	59.5	40	59.5	I			
1.8 TSi 4x4 (118 kW)	2008.11-				L		Estate Engine CDAA	GDS83295	Drive Shaft	36		59.5	40	491			
	2008.11-				R		Estate Engine CDAA	GDS83266	Drive Shaft	36		59.5	40	601			
	2008.11-				R		Estate Engine CDAA	GCI83011	Inner Joint		33		34				
	2008.11-		MT	L	F	Estate Engine CDAA	GDS83236	Drive Shaft	36		59.5	40	484				
	2008.11-				R		Estate Engine CDAA	GCI83016	Inner Joint		28		32				
	2008.11-					Estate Engine CDAA	GC061059	Outer Joint	36	33	59.5	40	59.5	I			
1.9 TDi (77 kW)	2004.11-	2006.12	6AT			F	Estate Engine BJB/BKC/BLS/BXE	GCI54004	Inner Joint		34		85				
	2004.11-	2006.12	MT			F	Estate Engine BJB/BKC/BLS/BXE	GCI83011	Inner Joint		33		34				
	2004.11-	2006.12	MT/6MT			F	Estate Engine BJB/BKC/BLS/BXE	GC083037	Outer Joint	36	30	59.5	40.5	55	I		



		TRANSM	L/R	F/R		G-AP Ref.	PRODUCT	ABS	Technical Specifications							
									YEAR	A	B	C	H	L	P	
<b>SKODA OCTAVIA (1Z5)</b>																
1.9 TDi (77 kW)	2004.11-2006.12		MT/AT		F	Estate Engine BJB/BKC/BLS/BXE	GC083002	Outer Joint	36	27	59.5	40	66	I		
	2004.11-2006.12		AT	L	F	Estate Engine BJB/BKC/BLS/BXE	GDS83241	Drive Shaft	36		59.5	40	475			
	2004.11-2006.12		AT	L	F	Estate Engine BJB/BKC/BLS/BXE	GDS54013	Drive Shaft	36		59.5	40	479.5			
	2004.11-2006.12		MT	L	F	Estate Engine BJB/BKC/BLS/BXE	GDS61089	Drive Shaft	36		59.5	40.5	521			
	2004.11-2006.12		MT	L	F	Estate Engine BJB/BKC/BLS/BXE	GDS83294	Drive Shaft	36		59.5	38	519			
	2004.11-2006.12		AT	L/R	F	Estate Engine BJB/BKC/BLS/BXE	GCI61057	Inner Joint		34		86				
	2004.11-2006.12		AT	R	F	Estate Engine BJB/BKC/BLS/BXE	GDS83355	Drive Shaft	36	23	59.5	40	799			
	2004.11-2006.12		AT	R	F	Estate Engine BJB/BKC/BLS/BXE	GDS54011	Drive Shaft	36		59.5	40	755			
1.9 TDi 4x4 (77 kW)	2005.01-2010.12		6AT			Estate Engine BKC/BLS/BXE	GCI54004	Inner Joint		34		85				
	2005.01-2010.12		MT	L		Estate Engine BKC/BLS/BXE	GDS83295	Drive Shaft	36		59.5	40	491			
	2005.01-2010.12				R	Estate Engine BKC/BLS/BXE	GDS83266	Drive Shaft	36		59.5	40	601			
	2005.01-2010.12		MT		F	Estate Engine BKC/BLS/BXE	GC083002	Outer Joint	36	27	59.5	40	66	I		
	2005.01-2010.12		MT		F	Estate Engine BKC/BLS/BXE	GCI53002	Inner Joint		33		34				
	2005.01-2010.12		MT	L	F	Estate Engine BKC/BLS/BXE	GDS83236	Drive Shaft	36		59.5	40	484			
	2005.01-2010.12				R	Estate Engine BKC/BLS/BXE	GCI83011	Inner Joint		33		34				
2005.01-2010.12				R	Estate Engine BKC/BLS/BXE	GCI83016	Inner Joint		28		32					
2.0 FSi (110 kW)	2004.11-2007.03				F	Estate Engine BLR/BLY/BVY/BVZ	GC083037	Outer Joint	36	30	59.5	40.5	55	I		
	2004.11-2007.03		6AT		F	Estate Engine BLR/BLY/BVY/BVZ	GCI61011	Inner Joint	26	32	31	68.5	85			
	2004.11-2007.03		MT		F	Estate Engine BLR/BLY/BVY/BVZ	GCI83011	Inner Joint		33		34				
	2004.11-2007.03		6AT	L	F	Estate Engine BLR/BLY/BVY/BVZ	GDS61093	Drive Shaft	36	26	59.5	40.5	587.5			
	2004.11-2007.03		MT	L	F	Estate Engine BLR/BLY/BVY/BVZ	GDS61089	Drive Shaft	36		59.5	40.5	521			
	2004.11-2007.03		6AT	R	F	Estate Engine BLR/BLY/BVY/BVZ	GDS61094	Drive Shaft	36	26	59.5	40.5	884			
	2004.11-2007.03		MT	R	F	Estate Engine BLR/BLY/BVY/BVZ	GDS61113	Drive Shaft	36		59.5	40	814			
2.0 FSi 4x4 (110 kW)	2005.01-2006.12					Estate Engine BLX/BVX	GC083037	Outer Joint	36	30	59.5	40.5	55	I		
	2005.01-2006.12		6AT			Estate Engine BLX/BVX	GCI61011	Inner Joint	26	32	31	68.5	85			
	2005.01-2006.12		MT			Estate Engine BLX/BVX	GCI53002	Inner Joint		33		34				
	2005.01-2006.12			L		Estate Engine BLX/BVX	GDS83294	Drive Shaft	36		59.5	38	519			
	2005.01-2006.12		MT		F	Estate Engine BLX/BVX	GCI83011	Inner Joint		33		34				
	2005.01-2006.12		6AT	L	F	Estate Engine BLX/BVX	GDS61093	Drive Shaft	36	26	59.5	40.5	587.5			
	2005.01-2006.12		MT	L	F	Estate Engine BLX/BVX	GDS61089	Drive Shaft	36		59.5	40.5	521			
	2005.01-2006.12		6AT	R	F	Estate Engine BLX/BVX	GDS61094	Drive Shaft	36	26	59.5	40.5	884			
2.0 RS (147 kW)	2005.10-				F	Estate Engine BWA/CCZA	GC083002	Outer Joint	36	27	59.5	40	66	I		
	2005.10-				L	F	Estate Engine BWA/CCZA	GDS83236	Drive Shaft	36		59.5	40	484		
	2005.10-				R	F	Estate Engine BWA/CCZA	GDS61126	Drive Shaft	36		59.5	40	793		
2.0 TDi (103 kW)	2007.01-		6AT		F	Estate Engine BMM	GCI54004	Inner Joint		34		85				
	2007.01-		MT		F	Estate Engine BMM	GC083002	Outer Joint	36	27	59.5	40	66	I		
	2007.01-		MT		F	Estate Engine BMM	GCI53002	Inner Joint		33		34				
	2007.01-		AT	L	F	Estate Engine BMM	GDS54013	Drive Shaft	36		59.5	40	479.5			
	2007.01-		MT	L	F	Estate Engine BMM	GDS83295	Drive Shaft	36		59.5	40	491			
	2007.01-		AT	R	F	Estate Engine BMM	GDS54011	Drive Shaft	36		59.5	40	755			
	2007.01-		MT	R	F	Estate Engine BMM	GDS83313	Drive Shaft	36		59.5	40	792			
	2007.01-		AT	L	F	Estate Engine BMM	GDS83241	Drive Shaft	36		59.5	40	475			
	2007.01-			L	F	Estate Engine BMM	GDS83236	Drive Shaft	36		59.5	40	484			
	2007.01-		AT	L/R	F	Estate Engine BMM	GCI61057	Inner Joint		34		86				
	2007.01-		AT	R	F	Estate Engine BMM	GDS83355	Drive Shaft	36	23	59.5	40	799			
	2007.01-		MT	R	F	Estate Engine BMM	GDS61126	Drive Shaft	36		59.5	40	793			
2.0 TDi (81 kW)	2010.03-			L	F	Estate Engine CFHF/CLCA	GDS83294	Drive Shaft	36		59.5	38	519			
	2010.03-			R	F	Estate Engine CFHF/CLCA	GDS61042	Drive Shaft	36		59.5	40.5	814			
	2010.03-			L	F	Estate Engine CFHF/CLCA	GDS83236	Drive Shaft	36		59.5	40	484			
	2010.03-			R	F	Estate Engine CFHF/CLCA	GDS61126	Drive Shaft	36		59.5	40	793			
2.0 TDi 16V (100 kW)	2004.02-2010.05				F	Estate Engine AZV	GC083002	Outer Joint	36	27	59.5	40	66	I		
	2004.02-2010.05		6AT		F	Estate Engine AZV	GCI54004	Inner Joint		34		85				
	2004.02-2010.05		AT	L	F	Estate Engine AZV	GDS83241	Drive Shaft	36		59.5	40	475			
	2004.02-2010.05		AT	L	F	Estate Engine AZV	GCI61057	Inner Joint		34		86				
	2004.02-2010.05		AT	L	F	Estate Engine AZV	GDS54013	Drive Shaft	36		59.5	40	479.5			
	2004.02-2010.05		MT	L	F	Estate Engine AZV	GDS83295	Drive Shaft	36		59.5	40	491			
	2004.02-2010.05			L	F	Estate Engine AZV	GDS83236	Drive Shaft	36		59.5	40	484			
	2004.02-2010.05		AT	R	F	Estate Engine AZV	GDS83355	Drive Shaft	36	23	59.5	40	799			
	2004.02-2010.05		AT	R	F	Estate Engine AZV	GDS54011	Drive Shaft	36		59.5	40	755			
	2004.02-2010.05		MT	R	F	Estate Engine AZV	GDS61126	Drive Shaft	36		59.5	40	793			
	2004.02-2010.05		MT	R	F	Estate Engine AZV	GDS83313	Drive Shaft	36		59.5	40	792			

		TRANSM	L/R	F/R		G-AP Ref.	PRODUCT	ABS	Technical Specifications								
									YEAR	A	B	C	H	L	P		
<b>SKODA OCTAVIA (1Z5)</b>																	
2.0 TDi 16V (103 kW)	2004.11-	2007.03	6AT		F	Estate Engine BKD/CFHC/CLCB	GCI54004	Inner Joint		34		85					
	2004.11-	2007.03	MT		F	Estate Engine BKD/CFHC/CLCB	GCI53002	Inner Joint		33		34					
	2004.11-	2007.03	AT	L	F	Estate Engine BKD/CFHC/CLCB	GDS83241	Drive Shaft	36		59.5	40	475				
	2004.11-	2007.03	AT	L	F	Estate Engine BKD/CFHC/CLCB	GDS54013	Drive Shaft	36		59.5	40	479.5				
	2004.11-	2007.03	MT	L	F	Estate Engine BKD/CFHC/CLCB	GDS83295	Drive Shaft	36		59.5	40	491				
	2004.11-	2007.03		L	F	Estate Engine BKD/CFHC/CLCB	GDS83236	Drive Shaft	36		59.5	40	484				
	2004.11-	2007.03	AT	L/R	F	Estate Engine BKD/CFHC/CLCB	GCI61057	Inner Joint		34		86					
	2004.11-	2007.03	AT	R	F	Estate Engine BKD/CFHC/CLCB	GDS83355	Drive Shaft	36	23	59.5	40	799				
	2004.11-	2007.03	AT	R	F	Estate Engine BKD/CFHC/CLCB	GDS54011	Drive Shaft	36		59.5	40	755				
	2004.11-	2007.03	MT	R	F	Estate Engine BKD/CFHC/CLCB	GDS61126	Drive Shaft	36		59.5	40	793				
2.0 TDi 16V 4x4 (103 kW)	2010.05-		MT	L		Estate Engine CFHC	GDS83295	Drive Shaft	36		59.5	40	491				
	2010.05-			R		Estate Engine CFHC	GDS83313	Drive Shaft	36		59.5	40	792				
	2010.05-		MT	R		Estate Engine CFHC	GDS83266	Drive Shaft	36		59.5	40	601				
	2010.05-		MT	L	F	Estate Engine CFHC	GDS83236	Drive Shaft	36		59.5	40	484				
	2010.05-		MT	R		Estate Engine CFHC	GCI83016	Inner Joint		28		32					
2.0 TDi 4x4 (103 kW)	2006.08-		6AT			Estate Engine BMM	GCI54004	Inner Joint		34		85					
	2006.08-		MT			Estate Engine BMM	GCI53002	Inner Joint		33		34					
	2006.08-			L		Estate Engine BMM	GDS83295	Drive Shaft	36		59.5	40	491				
	2006.08-			R		Estate Engine BMM	GDS83266	Drive Shaft	36		59.5	40	601				
	2006.08-		MT		F	Estate Engine BMM	GC083002	Outer Joint	36	27	59.5	40	66	I			
	2006.08-			R		Estate Engine BMM	GCI83011	Inner Joint		33		34					
	2006.08-		MT	L	F	Estate Engine BMM	GDS83236	Drive Shaft	36		59.5	40	484				
	2006.08-			R		Estate Engine BMM	GCI83016	Inner Joint		28		32					
2.0 TDi 4x4 (81 kW)	2011.05-			L		Estate Engine CFHF	GDS83295	Drive Shaft	36		59.5	40	491				
	2011.05-			R		Estate Engine CFHF	GDS83313	Drive Shaft	36		59.5	40	792				
	2011.05-		MT	L	F	Estate Engine CFHF	GDS83236	Drive Shaft	36		59.5	40	484				
	2011.05-		MT	R	F	Estate Engine CFHF	GDS61126	Drive Shaft	36		59.5	40	793				
2.0 TDi RS (125 kW)	2006.04-		MT	L	F	Estate Engine BMN/CEGA	GDS83265	Drive Shaft	36		59.5	40	487				
	2006.04-		AT	L	F	Estate Engine BMN/CEGA	GDS83241	Drive Shaft	36		59.5	40	475				
	2006.04-		MT	L	F	Estate Engine BMN/CEGA	GDS83236	Drive Shaft	36		59.5	40	484				
	2006.04-		MT	L	F	Estate Engine BMN/CEGA	GCI83016	Inner Joint		28		32					
	2006.04-		AT	L/R	F	Estate Engine BMN/CEGA	GCI61057	Inner Joint		34		86					
2006.04-		MT	R	F	Estate Engine BMN/CEGA	GDS61126	Drive Shaft	36		59.5	40	793					
<b>OCTAVIA (5E3)</b>																	
1.2 TSi (77 kW)	2012.11-					Hatchback Engine CJZA	GC061059	Outer Joint	36	33	59.5	40	59.5	I			
	2012.11-			L	F	Hatchback Engine CJZA	GDS83373	Drive Shaft	36		59.5	38	511				
1.4 TSi (103 kW)	2012.11-		AT	L	F	Hatchback Engine CHPA	GDS61304	Drive Shaft	36		59.5	40	511				
	2012.11-		7AT	R	F	Hatchback Engine CHPA	GDS61303	Drive Shaft	36		59.5	40	795				
	2012.11-		AT	R	F	Hatchback Engine CHPA	GDS61280	Drive Shaft	36		59.5	40	801				
	2012.11-		MT	R	F	Hatchback Engine CHPA	GDS61283	Drive Shaft	36		59.5	40	815				
	2012.11-		AT			Hatchback Engine CHPA	GC083100	Outer Joint	36	33	59.5	38	55	I			
	2012.11-		AT			Hatchback Engine CHPA	GC083101	Outer Joint	36	27	59.5	40	65	M			
	2012.11-					Hatchback Engine CHPA	GC061059	Outer Joint	36	33	59.5	40	59.5	I			
1.6 TDi (66 kW)	2012.11-		MT	L	F	Hatchback Engine CLHB	GDS61089	Drive Shaft	36		59.5	40.5	521				
1.6 TDi (77 kW)	2012.11-		MT	L	F	Hatchback Engine CLHA	GDS61089	Drive Shaft	36		59.5	40.5	521				
1.6 TDi (81 kW)	2013.05-		MT	R	F	Hatchback Engine CRKB	GDS61200	Drive Shaft	36		59.5	40.5	820				
	2013.05-		MT			Hatchback Engine CRKB	GC083100	Outer Joint	36	33	59.5	38	55	I			
1.8 TSi (132 kW)	2012.11-		MT	L	F	Hatchback Engine CJSA	GDS61304	Drive Shaft	36		59.5	40	511				
	2012.11-		MT			Hatchback Engine CJSA	GC083101	Outer Joint	36	27	59.5	40	65	M			
2.0 TDi (105 kW)	2012.11-					Hatchback Engine CRVC/CKFB	GC083101	Outer Joint	36	27	59.5	40	65	M			
2.0 TDi (110 kW)	2012.11-					Hatchback Engine CKFC/CRMB	GC083101	Outer Joint	36	27	59.5	40	65	M			
<b>OCTAVIA COMBI (5E5)</b>																	
1.2 TSi (77 kW)	2012.11-			L	F	Estate Engine CJZA	GDS83373	Drive Shaft	36		59.5	38	511				
	2012.11-					Estate Engine CJZA	GC061059	Outer Joint	36	33	59.5	40	59.5	I			
1.4 TSi (103 kW)	2012.11-		AT	L	F	Estate Engine CHPA	GDS61304	Drive Shaft	36		59.5	40	511				
	2012.11-		AT	R	F	Estate Engine CHPA	GDS61303	Drive Shaft	36		59.5	40	795				
	2012.11-		MT	R	F	Estate Engine CHPA	GDS61283	Drive Shaft	36		59.5	40	815				
	2012.11-		AT			Estate Engine CHPA	GC083100	Outer Joint	36	33	59.5	38	55	I			
	2012.11-		AT			Estate Engine CHPA	GC083101	Outer Joint	36	27	59.5	40	65	M			
	2012.11-					Estate Engine CHPA	GC061059	Outer Joint	36	33	59.5	40	59.5	I			









		TRANSM	L/R	F/R		G-AP Ref.	PRODUCT	ABS	Technical Specifications					
									YEAR	A	B	C	H	L
<b>SKODA</b>														
<b>OCTAVIA COMBI (5E5)</b>														
1.6 TDi (66 kW)	2012.11-		MT	L	F	Estate Engine CLHB	GDS61089	Drive Shaft	36		59.5	40.5	521	
1.6 TDi (77 kW)	2012.11-		MT	L	F	Estate Engine CLHA	GDS61089	Drive Shaft	36		59.5	40.5	521	
1.6 TDi (81 kW)	2013.05-		MT	R	F	Estate Engine CRKB	GDS61200	Drive Shaft	36		59.5	40.5	820	
	2013.05-		MT			Estate Engine CRKB	GC083100	Outer Joint	36	33	59.5	38	55	I
1.6 TDi 4x4 (77 kW)	2012.11-		MT	L	F	Estate Engine CLHA	GDS61089	Drive Shaft	36		59.5	40.5	521	
	2012.11-		AT	R	F	Estate Engine CLHA	GDS61280	Drive Shaft	36		59.5	40	801	
	2012.11-		AT			Estate Engine CLHA	GC083100	Outer Joint	36	33	59.5	38	55	I
1.8 TSi (132 kW)	2012.11-		MT	L	F	Estate Engine CJSJ/CJSB	GDS61304	Drive Shaft	36		59.5	40	511	
	2012.11-		MT		F	Estate Engine CJSJ/CJSB	GC083101	Outer Joint	36	27	59.5	40	65	M
1.8 TSi 4x4 (132 kW)	2012.11-					Estate Engine CJSB	GC083101	Outer Joint	36	27	59.5	40	65	M
2.0 TDi (105 kW)	2012.11-					Estate Engine CRVC/CKFB	GC083101	Outer Joint	36	27	59.5	40	65	M
2.0 TDi (110 kW)	2012.11-					Estate Engine CKFC/CRMB	GC083101	Outer Joint	36	27	59.5	40	65	M
2.0 TDi 4x4 (110 kW)	2012.11-					Estate Engine CKFC	GC083101	Outer Joint	36	27	59.5	40	65	M
<b>OCTAVIA II (1U2, 1U5), SW</b>														
1.9 TDi (66 kW)	1996.09-	2006.01	MT				GCI83013	Inner Joint		33		34		
1.9 TDi (81 kW)	1996.09-	2006.01	MT				GCI83013	Inner Joint		33		34		
<b>OCTAVIA III (1Z3, 1Z5), SW</b>														
1.2 TSi (77 kW)	2010.02-		MT			Exc Double Clutch	GC083002	Outer Joint	36	27	59.5	40	66	I
1.4 (55 kW)	2004.05-	2008.10					GC053001	Outer Joint	36	30	59.5	40	49	I
1.4 (59 kW)	2004.05-	2008.10					GC053001	Outer Joint	36	30	59.5	40	49	I
	2006.05-		MT				GC083002	Outer Joint	36	27	59.5	40	66	I
1.4 TSi (90 kW)	2008.11-	2013.04				DOUBLE CLUTCH	GCI83016	Inner Joint		28		32		
	2008.11-	2013.04				Double Clutch	GC083002	Outer Joint	36	27	59.5	40	66	I
1.6 LPG (75 kW)	2009.08-		MT/AT				GC083037	Outer Joint	36	30	59.5	40.5	55	I
1.6 TDi (77 kW)	2009.06-		MT		F	DOUBLE CLUTCH	GCI83016	Inner Joint		28		32		
	2009.06-				F		GC083037	Outer Joint	36	30	59.5	40.5	55	I
	2009.06-						GC083002	Outer Joint	36	27	59.5	40	66	I
1.8 FSi (118 kW)	2008.11-	2013.04					GC083037	Outer Joint	36	30	59.5	40.5	55	I
1.8 TFSi 16V (118 kW)	2008.11-	2013.04	MT			DOUBLE CLUTCH	GCI83016	Inner Joint		28		32		
1.8 TSi (112 kW)	2007.06-					Exc Double Clutch	GC083002	Outer Joint	36	27	59.5	40	66	I
1.8 TSi 16V (118 kW)	2007.06-	2008.10				Exc Double Clutch	GC083002	Outer Joint	36	27	59.5	40	66	I
1.9 TDi (77 kW)	2004.06-	2013.04	AT				GC083002	Outer Joint	36	27	59.5	40	66	I
	2004.06-	2013.04	MT				GC083037	Outer Joint	36	30	59.5	40.5	55	I
	2004.06-	2013.04					GCI83016	Inner Joint		28		32		
2.0 FSi (110 kW)	2004.11-						GC083037	Outer Joint	36	30	59.5	40.5	55	I
2.0 TDi (125 kW)	2006.04-	2008.10					GCI83016	Inner Joint		28		32		
2.0 TDi 16V (100 kW)	2004.02-	2010.05	MT				GCI83016	Inner Joint		28		32		
	2004.02-	2010.05	MT				GC083002	Outer Joint	36	27	59.5	40	66	I
2.0 TDi 16V (103 kW)	2004.02-	2010.05	MT				GCI83016	Inner Joint		28		32		
	2004.02-	2010.05	MT				GC083002	Outer Joint	36	27	59.5	40	66	I
2.0 TFSi RS 16V (147 kW)	2005.10-						GCI83016	Inner Joint		28		32		
	2005.10-						GC083002	Outer Joint	36	27	59.5	40	66	I
<b>OCTAVIA IV (5E3, 5E5), SW</b>														
1.2 TSi (63 kW)	2012.11-		MT			Exc Double Clutch	GC083037	Outer Joint	36	30	59.5	40.5	55	I
1.2 TSi (77 kW)	2012.11-		MT			Exc Double Clutch	GC083037	Outer Joint	36	30	59.5	40.5	55	I
1.4 TSi (103 kW)	2012.11-					DOUBLE CLUTCH	GCI83016	Inner Joint		28		32		
1.6 TDi (66 kW)	2012.11-		MT			Exc Double Clutch	GC083037	Outer Joint	36	30	59.5	40.5	55	I
1.6 TDi (77 kW)	2012.11-		MT			Exc Double Clutch	GC083037	Outer Joint	36	30	59.5	40.5	55	I
1.6 TSi (81 kW)	2014.01-		MT			Exc Double Clutch	GC083037	Outer Joint	36	30	59.5	40.5	55	I
1.8 TFSi 16V (118 kW)	2007.06-	2008.10	AT				GCI83016	Inner Joint		28		32		
1.8 TSi (132 kW)	2012.11-		MT				GCI83016	Inner Joint		28		32		
2.0 TDi (105 kW)	2012.11-		MT				GCI83016	Inner Joint		28		32		
2.0 TDi (110 kW)	2012.11-		MT				GCI83016	Inner Joint		28		32		
<b>RAPID (NH1)</b>														
1.2 (55 kW)	2012.07-			L	F	Saloon Engine CGPC	GDS83330	Drive Shaft	36		50.7	58.5	515	
	2012.07-			R	F	Saloon Engine CGPC	GDS61267	Drive Shaft	36		50.7	58.5	765	
<b>ROOMSTER (5J)</b>														
1.2 (47 kW)	2006.05-	2007.01			F	MPV Engine BME	GC083027	Outer Joint	36	30	50.7	58.5	47.5	I
	2006.05-	2007.01		L	F	MPV Engine BME	GDS83063	Drive Shaft	36		50.7	58.5	501	
	2006.05-	2007.01		R	F	MPV Engine BME	GDS61063	Drive Shaft	36		50.7	58.5	751	
1.2 (51 kW)	2007.01-			L	F	MPV Engine BZG/CGPA	GDS83063	Drive Shaft	36		50.7	58.5	501	



		TRANSM	L/R	F/R		G-AP Ref.	PRODUCT	ABS	Technical Specifications								
									YEAR	A	B	C	H	L	P		
<b>SKODA ROOMSTER (5J)</b>																	
1.2 (51 kW)	2007.01-			R	F	MPV Engine BZG/CGPA	GDS61063	Drive Shaft	36		50.7	58.5	751				
1.2 TDi (55 kW)	2010.03-		MT	L	F	MPV Engine CFWA	GDS61302	Drive Shaft	36		50.5	59	479				
	2010.03-		MT	R	F	MPV Engine CFWA	GDS61301	Drive Shaft	36		50.5	59	771				
1.2 TSi (63 kW)	2010.03-		MT		F	MPV Engine CBZA	GCI53002	Inner Joint		33		34					
1.4 (63 kW)	2006.09-				F	MPV Engine BXW/CGGB	GC083027	Outer Joint	36	30	50.7	58.5	47.5	I			
	2006.09-			L	F	MPV Engine BXW/CGGB	GDS83063	Drive Shaft	36		50.7	58.5	501				
	2006.09-			R	F	MPV Engine BXW/CGGB	GDS61063	Drive Shaft	36		50.7	58.5	751				
1.4 TDi (51 kW)	2006.07- 2010.03				F	MPV Engine BNM	GC083027	Outer Joint	36	30	50.7	58.5	47.5	I			
	2006.07- 2010.03	MT	R	F	MPV Engine BNM	GDS61223	Drive Shaft	36		52	59	757					
1.4 TDi (59 kW)	2006.09- 2010.03	MT		F	MPV Engine BMS/BNV	GC083024	Outer Joint	36	30	50.75	59	54.5	I				
	2006.09- 2010.03	MT	L	F	MPV Engine BMS/BNV	GDS61098	Drive Shaft	36		50.5	59	472					
	2006.09- 2010.03		L	F	MPV Engine BMS/BNV	GDS61135	Drive Shaft	36		52	59	475					
	2006.09- 2010.03	MT	R	F	MPV Engine BMS/BNV	GDS61136	Drive Shaft	36		52	59	763					
	2006.09- 2010.03	MT	R	F	MPV Engine BMS/BNV	GCI61062	Inner Joint		30		59						
	2006.09- 2010.03	MT	R	F	MPV Engine BMS/BNV	GDS61099	Drive Shaft	36		50.5	59	759					
1.6 (77 kW)	2006.09-	MT		F	MPV Engine BTS/CFNA	GC083027	Outer Joint	36	30	50.7	58.5	47.5	I				
	2006.09-	MT		F	MPV Engine BTS/CFNA	GCI83011	Inner Joint		33		34						
	2006.09-	MT	L	F	MPV Engine BTS/CFNA	GDS61150	Drive Shaft	36	26	52	75	557					
	2006.09-	MT	L	F	MPV Engine BTS/CFNA	GCI61039	Inner Joint	26	22	31	68.5	88.5					
1.6 TDi (66 kW)	2010.03-	MT		F	MPV Engine CAYB	GCI53002	Inner Joint		33		34						
	2010.03-	MT	L	F	MPV Engine CAYB	GDS61302	Drive Shaft	36		50.5	59	479					
	2010.03-	MT	R	F	MPV Engine CAYB	GDS61301	Drive Shaft	36		50.5	59	771					
1.6 TDi (77 kW)	2010.03-	MT		F	MPV Engine CAYC	GCI53002	Inner Joint		33		34						
	2010.03-	MT	L	F	MPV Engine CAYC	GDS61302	Drive Shaft	36		50.5	59	479					
	2010.03-	MT	R	F	MPV Engine CAYC	GDS61301	Drive Shaft	36		50.5	59	771					
1.9 TDi (74 kW)	2006.03- 2006.05			L	F	MPV Engine AXR	GDS61135	Drive Shaft	36		52	59	475				
	2006.03- 2006.05	MT	R	F	MPV Engine AXR	GDS61136	Drive Shaft	36		52	59	763					
	2006.03- 2006.05	MT	R	F	MPV Engine AXR	GCI61062	Inner Joint		30		59						
1.9 TDi (77 kW)	2006.09- 2010.03			F	MPV Engine BLS/BSW	GC083024	Outer Joint	36	30	50.75	59	54.5	I				
	2006.09- 2010.03		L	F	MPV Engine BLS/BSW	GDS61098	Drive Shaft	36		50.5	59	472					
	2006.09- 2010.03	MT	L	F	MPV Engine BLS/BSW	GDS61135	Drive Shaft	36		52	59	475					
	2006.09- 2010.03	MT	R	F	MPV Engine BLS/BSW	GDS61136	Drive Shaft	36		52	59	763					
	2006.09- 2010.03	MT	R	F	MPV Engine BLS/BSW	GCI61062	Inner Joint		30		59						
<b>ROOMSTER (5J7, 5J), PRAKTIK</b>																	
1.2 12V (47 kW)	2006-						GC083027	Outer Joint	36	30	50.7	58.5	47.5	I			
1.2 12V (51 kW)	2006-						GC083027	Outer Joint	36	30	50.7	58.5	47.5	I			
1.4 16V (63 kW)	2006.09- 2010.03						GC083027	Outer Joint	36	30	50.7	58.5	47.5	I			
1.6 16V (77 kW)	2006.09-		AT				GC061010	Outer Joint	36	30	52	75	54.5	I			
1.9 TDi (77 kW)	2006.03- 2010.03						GC083027	Outer Joint	36	30	50.7	58.5	47.5	I			
<b>ROOMSTER PRAKTIK (5J)</b>																	
1.2 (51 kW)	2007.03-				F	Box Engine BZG/CGPA	GC083027	Outer Joint	36	30	50.7	58.5	47.5	I			
1.2 TDi (55 kW)	2010.03-		MT	L	F	Box Engine CFWA	GDS61302	Drive Shaft	36		50.5	59	479				
	2010.03-		MT	R	F	Box Engine CFWA	GDS61301	Drive Shaft	36		50.5	59	771				
1.4 (63 kW)	2007.03-				F	Box Engine BXW/CGGB	GC083027	Outer Joint	36	30	50.7	58.5	47.5	I			
1.4 TDi (51 kW)	2007.03- 2010.03				F	Box Engine BNM	GC083024	Outer Joint	36	30	50.75	59	54.5	I			
	2007.03- 2010.03	MT	R	F	Box Engine BNM	GDS61223	Drive Shaft	36		52	59	757					
1.4 TDi (59 kW)	2007.03- 2010.03			F	Box Engine BMS/BNV	GC083024	Outer Joint	36	30	50.75	59	54.5	I				
	2007.03- 2010.03		L	F	Box Engine BMS/BNV	GDS61135	Drive Shaft	36		52	59	475					
	2007.03- 2010.03	MT	R	F	Box Engine BMS/BNV	GDS61136	Drive Shaft	36		52	59	763					
	2007.03- 2010.03	MT	R	F	Box Engine BMS/BNV	GCI61062	Inner Joint		30		59						
1.6 TDi (66 kW)	2010.03-	MT	L	F	Box Engine CAYB	GDS61302	Drive Shaft	36		50.5	59	479					
	2010.03-	MT	R	F	Box Engine CAYB	GDS61301	Drive Shaft	36		50.5	59	771					
<b>SUPERB</b>																	
2.5 TDi V6	2002.05-		AT		F		GC083064	Outer Joint	45T	38	27	60	34	64	I		
	2002.05-		MT		F		GC083064	Outer Joint	45T	38	27	60	34	64	I		
2.8 V6	2002.05-		MT/AT		F		GC083064	Outer Joint	45T	38	27	60	34	64	I		
<b>SUPERB (3T4)</b>																	
1.4 TSi (92 kW)	2008.07-				F	Hatchback Engine CAXC	GCI83011	Inner Joint		33		34					
	2008.07-		MT		F	Hatchback Engine CAXC	GCI53002	Inner Joint		33		34					
	2008.07-		MT/AT		F	Hatchback Engine CAXC	GC083037	Outer Joint	36	30	59.5	40.5	55	I			
1.6 TDi (77 kW)	2010.09-		MT	R	F	Hatchback Engine CAYC	GDS61200	Drive Shaft	36		59.5	40.5	820				

	 YEAR	TRANSM	L/R	F/R		G-AP Ref.	PRODUCT	ABS	Technical Specifications									
									A	B	C	H	L	P				
<b>SKODA SUPERB (3T4)</b>																		
1.6 TDi (77 kW)	2010.09-		MT			Hatchback Engine CAYC	GC083100	Outer Joint		36	33	59.5	38	55	I			
	2010.09-					Hatchback Engine CAYC	GC061059	Outer Joint		36	33	59.5	40	59.5	I			
1.8 TSi (112 kW)	2009.03-		AT	L	F	Hatchback Engine CDAB	GDS83236	Drive Shaft		36		59.5	40	484				
	2009.03-		MT	L	F	Hatchback Engine CDAB	GDS61131	Drive Shaft		36		59.5	40	515				
1.8 TSi (118 kW)	2008.03-				F	Hatchback Engine BZB/CDA	GC083002	Outer Joint		36	27	59.5	40	66	I			
	2008.03-		MT			Hatchback Engine BZB/CDA	GCI53002	Inner Joint			33		34					
	2008.03-		AT	L	F	Hatchback Engine BZB/CDA	GDS83236	Drive Shaft		36		59.5	40	484				
	2008.03-		MT	L	F	Hatchback Engine BZB/CDA	GDS61131	Drive Shaft		36		59.5	40	515				
1.8 TSi 4x4 (118 kW)	2008.11-		MT			Hatchback Engine CDA	GCI53002	Inner Joint			33		34					
	2008.11-			L		Hatchback Engine CDA	GDS83295	Drive Shaft		36		59.5	40	491				
	2008.11-			R		Hatchback Engine CDA	GDS83266	Drive Shaft		36		59.5	40	601				
	2008.11-		AT	L	F	Hatchback Engine CDA	GDS83236	Drive Shaft		36		59.5	40	484				
	2008.11-		MT	L	F	Hatchback Engine CDA	GDS61131	Drive Shaft		36		59.5	40	515				
	2008.11-				R		Hatchback Engine CDA	GCI83016	Inner Joint			28		32				
1.9 TDi (77 kW)	2008.03-				F	Hatchback Engine BLS/BXE	GCI83011	Inner Joint			33		34					
	2008.03-				F	Hatchback Engine BLS/BXE	GC083037	Outer Joint		36	30	59.5	40.5	55	I			
	2008.03-		MT			Hatchback Engine BLS/BXE	GCI53002	Inner Joint			33		34					
	2008.03-		MT	L	F	Hatchback Engine BLS/BXE	GDS83294	Drive Shaft		36		59.5	38	519				
	2008.03-			R	F	Hatchback Engine BLS/BXE	GDS61042	Drive Shaft		36		59.5	40.5	814				
	2008.03-		MT	L	F	Hatchback Engine BLS/BXE	GDS61089	Drive Shaft		36		59.5	40.5	521				
2.0 TDi (103 kW)	2008.03-		6AT		F	Hatchback Engine BMP	GCI54004	Inner Joint			34		85					
	2008.03-		AT	L	F	Hatchback Engine BMP	GDS54013	Drive Shaft		36		59.5	40	479.5				
	2008.03-		MT	L	F	Hatchback Engine BMP	GDS83265	Drive Shaft		36		59.5	40	487				
	2008.03-		MT	L	F	Hatchback Engine BMP	GDS83295	Drive Shaft		36		59.5	40	491				
	2008.03-		AT	R	F	Hatchback Engine BMP	GDS54011	Drive Shaft		36		59.5	40	755				
	2008.03-		MT	R	F	Hatchback Engine BMP	GDS83313	Drive Shaft		36		59.5	40	792				
	2008.03-		AT	L	F	Hatchback Engine BMP	GDS83241	Drive Shaft		36		59.5	40	475				
	2008.03-		MT	L	F	Hatchback Engine BMP	GDS83236	Drive Shaft		36		59.5	40	484				
	2008.03-		MT	L	F	Hatchback Engine BMP	GCI83016	Inner Joint			28		32					
	2008.03-		AT	L/R	F	Hatchback Engine BMP	GCI61057	Inner Joint			34		86					
2008.03-		MT	R	F	Hatchback Engine BMP	GDS61126	Drive Shaft		36		59.5	40	793					
2.0 TDi (125 kW)	2008.07-		MT		F	Hatchback Engine CBBB/CFGB	GCI53002	Inner Joint			33		34					
	2008.07-		MT	L	F	Hatchback Engine CBBB/CFGB	GDS83265	Drive Shaft		36		59.5	40	487				
	2008.07-		AT	R	F	Hatchback Engine CBBB/CFGB	GDS54011	Drive Shaft		36		59.5	40	755				
	2008.07-		AT	L	F	Hatchback Engine CBBB/CFGB	GDS83241	Drive Shaft		36		59.5	40	475				
	2008.07-		MT	L	F	Hatchback Engine CBBB/CFGB	GDS83236	Drive Shaft		36		59.5	40	484				
	2008.07-		MT	L	F	Hatchback Engine CBBB/CFGB	GCI83016	Inner Joint			28		32					
	2008.07-		AT	L/R	F	Hatchback Engine CBBB/CFGB	GCI61057	Inner Joint			34		86					
	2008.07-		MT	R	F	Hatchback Engine CBBB/CFGB	GDS61126	Drive Shaft		36		59.5	40	793				
2.0 TDi 16V (103 kW)	2009.01-				F	Hatchback Engine CLJA/BKD/CFFB	GC083002	Outer Joint		36	27	59.5	40	66	I			
	2009.01-		AT	L	F	Hatchback Engine CLJA/BKD/CFFB	GDS54013	Drive Shaft		36		59.5	40	479.5				
	2009.01-		AT	R	F	Hatchback Engine CLJA/BKD/CFFB	GDS54011	Drive Shaft		36		59.5	40	755				
	2009.01-		AT	L	F	Hatchback Engine CLJA/BKD/CFFB	GDS83241	Drive Shaft		36		59.5	40	475				
	2009.01-		MT	L	F	Hatchback Engine CLJA/BKD/CFFB	GDS83236	Drive Shaft		36		59.5	40	484				
	2009.01-		AT	L/R	F	Hatchback Engine CLJA/BKD/CFFB	GCI61057	Inner Joint			34		86					
	2009.01-		AT	R	F	Hatchback Engine CLJA/BKD/CFFB	GDS83355	Drive Shaft		36	23	59.5	40	799				
2.0 TDi 16V 4x4 (103 kW)	2010.11-			L		Hatchback Engine CFFB	GDS54013	Drive Shaft		36		59.5	40	479.5				
	2010.11-		AT	L	F	Hatchback Engine CFFB	GDS83241	Drive Shaft		36		59.5	40	475				
2.0 TDi 4x4 (125 kW)	2008.09-		MT			Hatchback Engine CBBB/CFGB	GCI53002	Inner Joint			33		34					
	2008.09-			L		Hatchback Engine CBBB/CFGB	GDS83295	Drive Shaft		36		59.5	40	491				
	2008.09-			R		Hatchback Engine CBBB/CFGB	GDS83266	Drive Shaft		36		59.5	40	601				
	2008.09-		MT	L	F	Hatchback Engine CBBB/CFGB	GDS83236	Drive Shaft		36		59.5	40	484				
	2008.09-			R		Hatchback Engine CBBB/CFGB	GCI83016	Inner Joint			28		32					
3.6 FSi 4x4 (191 kW)	2009.04-		MT	R		Hatchback	GDS83313	Drive Shaft		36		59.5	40	792				
3.6 V6 4x4 (191 kW)	2008.11-		MT			Hatchback Engine CDVA	GCI53002	Inner Joint			33		34					
	2008.11-		MT	R		Hatchback Engine CDVA	GDS83313	Drive Shaft		36		59.5	40	792				
<b>SUPERB (3T5)</b>																		
1.4 TSi (92 kW)	2009.10-		MT		F	Estate Engine CAXC	GCI53002	Inner Joint			33		34					
	2009.10-		MT/AT		F	Estate Engine CAXC	GC083037	Outer Joint		36	30	59.5	40.5	55	I			
1.6 TDi (77 kW)	2010.09-		MT	R	F	Estate Engine CAYC	GDS61200	Drive Shaft		36		59.5	40.5	820				







		TRANSM	L/R	F/R		G-AP Ref.	PRODUCT	ABS	Technical Specifications							
									YEAR	A	B	C	H	L	P	
<b>SKODA SUPERB (3T5)</b>																
1.6 TDi (77 kW)	2010.09-		MT			Estate Engine CAYC	GC083100	Outer Joint	36	33	59.5	38	55	I		
	2010.09-					Estate Engine CAYC	GC061059	Outer Joint	36	33	59.5	40	59.5	I		
1.8 TSi (112 kW)	2009.10-		AT	L	F	Estate Engine CDAB	GDS83236	Drive Shaft	36		59.5	40	484			
	2009.10-		MT	L	F	Estate Engine CDAB	GDS61131	Drive Shaft	36		59.5	40	515			
1.8 TSi (118 kW)	2009.10-		MT		F	Estate Engine CDAA	GCI53002	Inner Joint		33		34				
	2009.10-		MT	L	F	Estate Engine CDAA	GDS61131	Drive Shaft	36		59.5	40	515			
1.8 TSi 4x4 (118 kW)	2009.10-		MT			Estate Engine CDAA	GCI53002	Inner Joint		33		34				
	2009.10-			L		Estate Engine CDAA	GDS83295	Drive Shaft	36		59.5	40	491			
	2009.10-			R		Estate Engine CDAA	GDS83266	Drive Shaft	36		59.5	40	601			
	2009.10-		AT	L	F	Estate Engine CDAA	GDS83236	Drive Shaft	36		59.5	40	484			
	2009.10-		MT	L	F	Estate Engine CDAA	GDS61131	Drive Shaft	36		59.5	40	515			
	2009.10-			R		Estate Engine CDAA	GCI83016	Inner Joint		28		32				
1.9 TDi (77 kW)	2009.10-	2010.11		L	F	Estate Engine BLS/BXE	GDS83294	Drive Shaft	36		59.5	38	519			
	2009.10-	2010.11	MT	L	F	Estate Engine BLS/BXE	GDS61089	Drive Shaft	36		59.5	40.5	521			
	2009.10-	2010.11		R	F	Estate Engine BLS/BXE	GDS61042	Drive Shaft	36		59.5	40.5	814			
2.0 TDi (103 kW)	2009.10-	2010.03	AT	L	F	Estate Engine BMP	GDS83241	Drive Shaft	36		59.5	40	475			
	2009.10-	2010.03	AT	L	F	Estate Engine BMP	GDS54013	Drive Shaft	36		59.5	40	479.5			
	2009.10-	2010.03	MT	L	F	Estate Engine BMP	GDS83236	Drive Shaft	36		59.5	40	484			
	2009.10-	2010.03	MT	L	F	Estate Engine BMP	GCI83016	Inner Joint		28		32				
	2009.10-	2010.03	MT	L	F	Estate Engine BMP	GDS83265	Drive Shaft	36		59.5	40	487			
	2009.10-	2010.03	AT	L/R	F	Estate Engine BMP	GCI61057	Inner Joint		34		86				
	2009.10-	2010.03	AT	R	F	Estate Engine BMP	GDS54011	Drive Shaft	36		59.5	40	755			
	2009.10-	2010.03	MT	R	F	Estate Engine BMP	GDS61126	Drive Shaft	36		59.5	40	793			
2.0 TDi (125 kW)	2009.10-		MT		F	Estate Engine CBBB/CFGB	GCI53002	Inner Joint		33		34				
	2009.10-		MT	L	F	Estate Engine CBBB/CFGB	GDS83265	Drive Shaft	36		59.5	40	487			
	2009.10-		AT	R	F	Estate Engine CBBB/CFGB	GDS54011	Drive Shaft	36		59.5	40	755			
	2009.10-		AT	L	F	Estate Engine CBBB/CFGB	GDS83241	Drive Shaft	36		59.5	40	475			
	2009.10-		MT	L	F	Estate Engine CBBB/CFGB	GDS83236	Drive Shaft	36		59.5	40	484			
	2009.10-		MT	L	F	Estate Engine CBBB/CFGB	GCI83016	Inner Joint		28		32				
	2009.10-		MT	R	F	Estate Engine CBBB/CFGB	GDS61126	Drive Shaft	36		59.5	40	793			
2.0 TDi 16V (103 kW)	2009.10-		AT	L	F	Estate Engine BKD/CFFB/CLJA	GDS54013	Drive Shaft	36		59.5	40	479.5			
	2009.10-		AT	R	F	Estate Engine BKD/CFFB/CLJA	GDS54011	Drive Shaft	36		59.5	40	755			
	2009.10-		AT	L	F	Estate Engine BKD/CFFB/CLJA	GDS83241	Drive Shaft	36		59.5	40	475			
	2009.10-		MT	L	F	Estate Engine BKD/CFFB/CLJA	GDS83236	Drive Shaft	36		59.5	40	484			
	2009.10-		MT	R	F	Estate Engine BKD/CFFB/CLJA	GDS61126	Drive Shaft	36		59.5	40	793			
2.0 TDi 16V 4x4 (103 kW)	2010.11-			L		Estate Engine CFFB	GDS54013	Drive Shaft	36		59.5	40	479.5			
	2010.11-		AT	L	F	Estate Engine CFFB	GDS83241	Drive Shaft	36		59.5	40	475			
2.0 TDi 4x4 (125 kW)	2009.10-		MT			Estate Engine CBBB/CFGB	GCI53002	Inner Joint		33		34				
	2009.10-			L		Estate Engine CBBB/CFGB	GDS83295	Drive Shaft	36		59.5	40	491			
	2009.10-			R		Estate Engine CBBB/CFGB	GDS83266	Drive Shaft	36		59.5	40	601			
	2009.10-		MT	L	F	Estate Engine CBBB/CFGB	GDS83236	Drive Shaft	36		59.5	40	484			
	2009.10-			R		Estate Engine CBBB/CFGB	GCI83016	Inner Joint		28		32				
3.6 V6 4x4 (191 kW)	2009.10-		MT			Estate Engine CDVA	GCI53002	Inner Joint		33		34				
<b>SUPERB (3U4)</b>																
1.8 T (110 kW)	2001.12-	2008.03	AT		F	Saloon Engine AWT	GC083019	Outer Joint	45W	38	27	59.5	34.5	63	I	
	2001.12-	2008.03	MT		F	Saloon Engine AWT	GC061012	Outer Joint	45W	33	30	53	30	62	I	
	2001.12-	2008.03	MT	L	F	Saloon Engine AWT	GDS61122	Drive Shaft	45W	33		53	30	602		
	2001.12-	2008.03	MT	R	F	Saloon Engine AWT	GDS83007	Drive Shaft	45W	33		53	30	622		
1.9 TDi (74 kW)	2002.08-	2005.10	MT		F	Saloon Engine AVB	GC083021	Outer Joint	45W	33	27	53	30	63	I	
	2002.08-	2005.10	MT	L	F	Saloon Engine AVB	GDS61083	Drive Shaft	45W	33		53	30	603		
	2002.08-	2005.10	MT	L/R	F	Saloon Engine AVB	GCI50019	Inner Joint		34		59.5				
	2002.08-	2005.10	MT	L/R	F	Saloon Engine AVB	GC083050	Outer Joint		33	27	53	30	63	I	
	2002.08-	2005.10		L/R	F	Saloon Engine AVB	GCI61033	Inner Joint		34		85				
	2002.08-	2005.10	MT	R	F	Saloon Engine AVB	GDS61082	Drive Shaft	45W	33		53	30	620		
1.9 TDi (77 kW)	2005.10-	2007.05	MT		F	Saloon Engine BSV	GC083021	Outer Joint	45W	33	27	53	30	63	I	
	2005.10-	2007.05	MT	L	F	Saloon Engine BSV	GDS61083	Drive Shaft	45W	33		53	30	603		
	2005.10-	2007.05	MT	L/R	F	Saloon Engine BSV	GCI50019	Inner Joint		34		59.5				
	2005.10-	2007.05	MT	L/R	F	Saloon Engine BSV	GC083050	Outer Joint		33	27	53	30	63	I	
	2005.10-	2007.05	MT	R	F	Saloon Engine BSV	GDS61082	Drive Shaft	45W	33		53	30	620		
1.9 TDi (85 kW)	2006.09-	2008.03	MT	L	F	Saloon Engine BPZ	GDS61083	Drive Shaft	45W	33		53	30	603		
	2006.09-	2008.03	MT	L/R	F	Saloon Engine BPZ	GCI50019	Inner Joint		34		59.5				



		TRANSM	L/R	F/R		G-AP Ref.	PRODUCT	ABS	Technical Specifications							
									YEAR	A	B	C	H	L	P	
<b>SKODA SUPERB (3U4)</b>																
1.9 TDi (85 kW)	2006.09-	2008.03	MT	L/R	F	Saloon Engine BPZ	GC083050	Outer Joint		33	27	53	30	63	I	
	2006.09-	2008.03	MT	R	F	Saloon Engine BPZ	GDS61082	Drive Shaft	45W	33		53	30	620		
	2006.09-	2008.03			F	Saloon Engine BPZ	GC083021	Outer Joint	45W	33	27	53	30	63	I	
1.9 TDi (96 kW)	2001.12-	2008.03			F	Saloon Engine AVF/AWX	GC083019	Outer Joint	45W	38	27	59.5	34.5	63	I	
	2001.12-	2008.03		L	F	Saloon Engine AVF/AWX	GDS83008	Drive Shaft	45W	38		59.5	34.5	603		
	2001.12-	2008.03		L/R	F	Saloon Engine AVF/AWX	GCI61033	Inner Joint		34		85				
	2001.12-	2008.03		R	F	Saloon Engine AVF/AWX	GDS61019	Drive Shaft	45W	38		59.5	34.5	624		
2.0 (85 kW)	2001.12-	2008.03	MT		F	Saloon Engine AZM	GC083018	Outer Joint	45W	33	30	53	30	62	I	
	2001.12-	2008.03	MT		F	Saloon Engine AZM	GCI83001	Inner Joint		28		32				
	2001.12-	2008.03	MT	L	F	Saloon Engine AZM	GDS83005	Drive Shaft	45W	33		53	30	614		
	2001.12-	2008.03	MT	R	F	Saloon Engine AZM	GDS83001	Drive Shaft	45W	33		53	30	634		
	2001.12-	2008.03	MT		F	Saloon Engine AZM	GC083045	Outer Joint		33	30	53	30	62	I	
2.0 TDi (103 kW)	2005.10-	2008.03	MT		F	Saloon Engine BSS	GC083019	Outer Joint	45W	38	27	59.5	34.5	63	I	
2.5 TDi (114 kW)	2001.12-	2003.08	MT/AT		F	Saloon Engine AYM	GC083019	Outer Joint	45W	38	27	59.5	34.5	63	I	
	2001.12-	2003.08	MT	L	F	Saloon Engine AYM	GDS83008	Drive Shaft	45W	38		59.5	34.5	603		
	2001.12-	2003.08		L/R	F	Saloon Engine AYM	GCI61033	Inner Joint		34		85				
	2001.12-	2003.08	MT	R	F	Saloon Engine AYM	GDS61019	Drive Shaft	45W	38		59.5	34.5	624		
2.5 TDi (120 kW)	2002.04-	2007.12	MT/AT		F	Saloon Engine BDG	GC083019	Outer Joint	45W	38	27	59.5	34.5	63	I	
	2002.04-	2007.12	MT	L	F	Saloon Engine BDG	GDS83008	Drive Shaft	45W	38		59.5	34.5	603		
	2002.04-	2007.12		L/R	F	Saloon Engine BDG	GCI61033	Inner Joint		34		85				
	2002.04-	2007.12	MT	R	F	Saloon Engine BDG	GDS61019	Drive Shaft	45W	38		59.5	34.5	624		
2.8 V6 (142 kW)	2001.12-	2008.03	MT/AT		F	Saloon Engine AMX	GC083019	Outer Joint	45W	38	27	59.5	34.5	63	I	
	2001.12-	2008.03	MT	L	F	Saloon Engine AMX	GDS83008	Drive Shaft	45W	38		59.5	34.5	603		
	2001.12-	2008.03		L/R	F	Saloon Engine AMX	GCI61033	Inner Joint		34		85				
	2001.12-	2008.03		R	F	Saloon Engine AMX	GDS61019	Drive Shaft	45W	38		59.5	34.5	624		
<b>SUPERB II (3T4, 3T5), SW</b>																
1.4 TSi (92 kW)	2008.07-		MT/AT				GC083037	Outer Joint		36	30	59.5	40.5	55	I	
	2008.07-		MT/AT				GC083002	Outer Joint		36	27	59.5	40	66	I	
1.8 TSi (112 kW)	2008.03-				F		GC083002	Outer Joint		36	27	59.5	40	66	I	
	2008.03-		MT		F	DOUBLE CLUTCH	GCI83016	Inner Joint		28		32				
1.8 TSi (118 kW)	2008.03-				F		GC083002	Outer Joint		36	27	59.5	40	66	I	
2008.03-		MT		F	DOUBLE CLUTCH	GCI83016	Inner Joint		28		32					
1.9 TDi (77 kW)	2008.03-						GC083037	Outer Joint		36	30	59.5	40.5	55	I	
2.0 TDi (103 kW)	2008.03-		MT				GCI83016	Inner Joint		28		32				
	2008.03-		MT/AT				GC083002	Outer Joint		36	27	59.5	40	66	I	
2.0 TDi (125 kW)	2008.03-		MT				GCI83016	Inner Joint		28		32				
	2008.03-		MT/AT				GC083002	Outer Joint		36	27	59.5	40	66	I	
2.0 TDi 16V (103 kW)	2009.01-				F		GC083002	Outer Joint		36	27	59.5	40	66	I	
2.0 TSi (147 kW)	2010.05-						GCI83016	Inner Joint		28		32				
3.6 V6 (191 kW)	2008.11-		MT		F	DOUBLE CLUTCH	GCI83016	Inner Joint		28		32				
<b>YETI (5L)</b>																
1.2 TSi (77 kW)	2009.09-				F	Closed Off-Road Vehicle Engine CBZB	GC083037	Outer Joint		36	30	59.5	40.5	55	I	
	2009.09-		MT		F	Closed Off-Road Vehicle Engine CBZB	GCI53002	Inner Joint		33		34				
	2009.09-		AT	L	F	Closed Off-Road Vehicle Engine CBZB	GDS61201	Drive Shaft		36		59.5	40.5	535		
	2009.09-		MT	L	F	Closed Off-Road Vehicle Engine CBZB	GDS61198	Drive Shaft		36		59.5	40.5	530		
	2009.09-		AT			Closed Off-Road Vehicle Engine CBZB	GC083100	Outer Joint		36	33	59.5	38	55	I	
	2009.09-					Closed Off-Road Vehicle Engine CBZB	GC061059	Outer Joint		36	33	59.5	40	59.5	I	
	2009.09-						GC083037	Outer Joint		36	30	59.5	40.5	55	I	
1.4 TSi (90 kW)	2010.06-		MT		F	Closed Off-Road Vehicle Engine CAXA	GCI53002	Inner Joint		33		34				
	2010.06-		MT	L	F	Closed Off-Road Vehicle Engine CAXA	GDS61198	Drive Shaft		36		59.5	40.5	530		
	2010.06-		MT			Closed Off-Road Vehicle Engine CAXA	GC083100	Outer Joint		36	33	59.5	38	55	I	
	2010.06-						GC083037	Outer Joint		36	30	59.5	40.5	55	I	
1.6 (81 kW)	2014.04-		AT	R	F	Closed Off-Road Vehicle Engine CWVA	GDS83346	Drive Shaft		36	26	59.5	38	879		
	2014.04-		AT	R	F	Closed Off-Road Vehicle Engine CWVA	GCI61011	Inner Joint		26	32	31	68.5	85		
	2014.04-		AT	R	F	Closed Off-Road Vehicle Engine CWVA	GC083116	Outer Joint		36	30	59.5	38	55	I	
1.6 TDi (77 kW)	2010.11-			L	F	Closed Off-Road Vehicle Engine CAYC	GDS83294	Drive Shaft		36		59.5	38	519		
	2010.11-			R	F	Closed Off-Road Vehicle Engine CAYC	GDS61042	Drive Shaft		36		59.5	40.5	814		
	2010.11-		MT	L	F	Closed Off-Road Vehicle Engine CAYC	GDS61089	Drive Shaft		36		59.5	40.5	521		
	2010.11-						GC083037	Outer Joint		36	30	59.5	40.5	55	I	
	2010.11-						GC083002	Outer Joint		36	27	59.5	40	66	I	
1.8 TSi (112 kW)	2009.05-						GC083002	Outer Joint		36	27	59.5	40	66	I	

		TRANSM	L/R	F/R		G-AP Ref.	PRODUCT	ABS	Technical Specifications													
									YEAR	A	B	C	H	L	P							
<b>SKODA</b>																						
<b>YETI (5L)</b>																						
1.8 TSi (112 kW)	2009.05-					GCI83016	Inner Joint		28		32											
1.8 TSi (118 kW)	2009.05-					GC083002	Outer Joint	36	27	59.5	40	66	I									
	2009.05-					GCI83016	Inner Joint		28		32											
1.8 TSi 4x4 (112 kW)	2009.11-		L		Closed Off-Road Vehicle Engine CDAB	GDS83295	Drive Shaft	36		59.5	40	491										
	2009.11-		L	F	Closed Off-Road Vehicle Engine CDAB	GDS83236	Drive Shaft	36		59.5	40	484										
1.8 TSi 4x4 (118 kW)	2009.05-		MT		Closed Off-Road Vehicle Engine CDAA	GCI53002	Inner Joint		33		34											
	2009.05-		L		Closed Off-Road Vehicle Engine CDAA	GDS83295	Drive Shaft	36		59.5	40	491										
	2009.05-			F	Closed Off-Road Vehicle Engine CDAA	GC083002	Outer Joint	36	27	59.5	40	66	I									
	2009.05-		L	F	Closed Off-Road Vehicle Engine CDAA	GDS83236	Drive Shaft	36		59.5	40	484										
2.0 TDi (103 kW)	2011.11-		L	F	Closed Off-Road Vehicle Engine CFHC	GDS83265	Drive Shaft	36		59.5	40	487										
	2011.11-		MT	L	F	Closed Off-Road Vehicle Engine CFHC	GDS83236	Drive Shaft	36		59.5	40	484									
	2011.11-		L	F	Closed Off-Road Vehicle Engine CFHC	GCI83016	Inner Joint		28		32											
	2011.11-		MT	R	F	Closed Off-Road Vehicle Engine CFHC	GDS61126	Drive Shaft	36		59.5	40	793									
	2011.11-			F			GC083002	Outer Joint	36	27	59.5	40	66	I								
2.0 TDi (125 kW)	2011.11-			F			GC083002	Outer Joint	36	27	59.5	40	66	I								
	2011.11-			F			GCI83016	Inner Joint		28		32										
2.0 TDi (81 kW)	2009.11-		MT		F	Closed Off-Road Vehicle Engine CFHA/CLCA	GCI53002	Inner Joint		33		34										
	2009.11-			R	F	Closed Off-Road Vehicle Engine CFHA/CLCA	GDS61200	Drive Shaft	36		59.5	40.5	820									
	2009.11-					Closed Off-Road Vehicle Engine CFHA/CLCA	GC083100	Outer Joint	36	33	59.5	38	55	I								
	2011.11-			F			GC083002	Outer Joint	36	27	59.5	40	66	I								
	2011.11-			F			GCI83016	Inner Joint		28		32										
2.0 TDi 4x4 (103 kW)	2009.05-		MT		Closed Off-Road Vehicle Engine CBDB/CFHC/CLCB	GCI53002	Inner Joint		33		34											
	2009.05-		MT/AT	L	Closed Off-Road Vehicle Engine CBDB/CFHC/CLCB	GDS83295	Drive Shaft	36		59.5	40	491										
	2009.05-		MT	R	Closed Off-Road Vehicle Engine CBDB/CFHC/CLCB	GDS83266	Drive Shaft	36		59.5	40	601										
	2009.05-			F	Closed Off-Road Vehicle Engine CBDB/CFHC/CLCB	GC083002	Outer Joint	36	27	59.5	40	66	I									
	2009.05-		L	F	Closed Off-Road Vehicle Engine CBDB/CFHC/CLCB	GDS83236	Drive Shaft	36		59.5	40	484										
	2009.05-		MT	R	Closed Off-Road Vehicle Engine CBDB/CFHC/CLCB	GCI83016	Inner Joint		28		32											
2.0 TDi 4x4 (125 kW)	2009.11-		MT		Closed Off-Road Vehicle Engine CEGA/CFJA	GCI53002	Inner Joint		33		34											
	2009.11-		L		Closed Off-Road Vehicle Engine CEGA/CFJA	GDS83295	Drive Shaft	36		59.5	40	491										
	2009.11-		MT	R	Closed Off-Road Vehicle Engine CEGA/CFJA	GDS83266	Drive Shaft	36		59.5	40	601										
	2009.11-			F	Closed Off-Road Vehicle Engine CEGA/CFJA	GC083002	Outer Joint	36	27	59.5	40	66	I									
	2009.11-		L	F	Closed Off-Road Vehicle Engine CEGA/CFJA	GDS83236	Drive Shaft	36		59.5	40	484										
	2009.11-		MT	R	Closed Off-Road Vehicle Engine CEGA/CFJA	GCI83016	Inner Joint		28		32											
2.0 TDi 4x4 (81 kW)	2009.11-		MT		Closed Off-Road Vehicle Engine CFHF	GCI53002	Inner Joint		33		34											
	2009.11-		L		Closed Off-Road Vehicle Engine CFHF	GDS83295	Drive Shaft	36		59.5	40	491										
	2009.11-		MT	R	Closed Off-Road Vehicle Engine CFHF	GDS83266	Drive Shaft	36		59.5	40	601										
	2009.11-			F	Closed Off-Road Vehicle Engine CFHF	GC083002	Outer Joint	36	27	59.5	40	66	I									
	2009.11-		MT	L	F	Closed Off-Road Vehicle Engine CFHF	GDS83236	Drive Shaft	36		59.5	40	484									
	2009.11-		MT	R		Closed Off-Road Vehicle Engine CFHF	GCI83016	Inner Joint		28		32										
	2009.11-					Closed Off-Road Vehicle Engine CFHF	GC061059	Outer Joint	36	33	59.5	40	59.5	I								
<b>SMART</b>																						
<b>CABRIO (450)</b>																						
0.6 (40 kW)	2000.03-	2004.01		L	R	Convertible Engine M160E6ALB03/M160.920	GDS99190	Drive Shaft	42T	24	33	50	25.5	476								
	2000.03-	2004.01		R	R	Convertible Engine M160E6ALB03/M160.920	GDS99191	Drive Shaft	42T	24	33	50	25.5	716								
0.6 (45 kW)	2001.01-	2004.01		L	R	Convertible Engine M160E6ALB05/M160.920	GDS99190	Drive Shaft	42T	24	33	50	25.5	476								
	2001.01-	2004.01		R	R	Convertible Engine M160E6ALB05/M160.920	GDS99191	Drive Shaft	42T	24	33	50	25.5	716								
0.6 (52 kW)	2002.06-	2004.01		L	R	Convertible Engine M160.920	GDS99190	Drive Shaft	42T	24	33	50	25.5	476								
	2002.06-	2004.01		R	R	Convertible Engine M160.920	GDS99191	Drive Shaft	42T	24	33	50	25.5	716								
0.7 (45 kW)	2003.01-	2004.01		L	R	Convertible Engine M160.910	GDS99190	Drive Shaft	42T	24	33	50	25.5	476								
	2003.01-	2004.01		R	R	Convertible Engine M160.910	GDS99191	Drive Shaft	42T	24	33	50	25.5	716								
0.7 (55 kW)	2003.01-	2004.01		L	R	Convertible Engine M160.910	GDS99190	Drive Shaft	42T	24	33	50	25.5	476								
	2003.01-	2004.01		R	R	Convertible Engine M160.910	GDS99191	Drive Shaft	42T	24	33	50	25.5	716								
0.8 CDi (30 kW)	2001.03-	2004.01	6MT	L	R	Convertible Engine OM660DE8LA/OM660.940	GDS99190	Drive Shaft	42T	24	33	50	25.5	476								
	2001.03-	2004.01	6MT	R	R	Convertible Engine OM660DE8LA/OM660.940	GDS99191	Drive Shaft	42T	24	33	50	25.5	716								
<b>CITY-COUPÉ (450)</b>																						
0.6 (33 kW)	1998.07-	2004.01		L	R	Coupe Engine M160E6ALB04/M160.920	GDS99190	Drive Shaft	42T	24	33	50	25.5	476								
	1998.07-	2004.01		R	R	Coupe Engine M160E6ALB04/M160.920	GDS99191	Drive Shaft	42T	24	33	50	25.5	716								
0.6 (40 kW)	1998.07-	2004.01		L	R	Coupe Engine M160E6ALB03/M160.920	GDS99190	Drive Shaft	42T	24	33	50	25.5	476								
	1998.07-	2004.01		R	R	Coupe Engine M160E6ALB03/M160.920	GDS99191	Drive Shaft	42T	24	33	50	25.5	716								
0.6 (45 kW)	2001.01-	2004.01		L	R	Coupe Engine M160E6ALB05/M160.920	GDS99190	Drive Shaft	42T	24	33	50	25.5	476								









		TRANSM	L/R	F/R		G-AP Ref.	PRODUCT	ABS	Technical Specifications								
									YEAR	A	B	C	H	L	P		
<b>SMART CITY-COUPÉ (450)</b>																	
0.6 (45 kW)	2001.01-	2004.01		R	R	Coupe Engine M160E6ALB05/M160.920	GDS99191	Drive Shaft	42T	24	33	50	25.5	716			
0.6 (52 kW)	2002.06-	2004.01		L	R	Coupe Engine M160.920	GDS99190	Drive Shaft	42T	24	33	50	25.5	476			
	2002.06-	2004.01		R	R	Coupe Engine M160.920	GDS99191	Drive Shaft	42T	24	33	50	25.5	716			
0.7 (37 kW)	2003.01-	2004.01		L	R	Coupe Engine M160.910	GDS99190	Drive Shaft	42T	24	33	50	25.5	476			
	2003.01-	2004.01		R	R	Coupe Engine M160.910	GDS99191	Drive Shaft	42T	24	33	50	25.5	716			
0.7 (45 kW)	2003.01-	2004.01		L	R	Coupe Engine M160.910	GDS99190	Drive Shaft	42T	24	33	50	25.5	476			
	2003.01-	2004.01		R	R	Coupe Engine M160.910	GDS99191	Drive Shaft	42T	24	33	50	25.5	716			
0.7 (55 kW)	2003.01-	2004.01		L	R	Coupe Engine M160.910	GDS99190	Drive Shaft	42T	24	33	50	25.5	476			
	2003.01-	2004.01		R	R	Coupe Engine M160.910	GDS99191	Drive Shaft	42T	24	33	50	25.5	716			
0.8 CDi (30 kW)	1999.11-	2004.01	6MT	L	R	Coupe Engine OM660DE8LA/OM660.940	GDS99190	Drive Shaft	42T	24	33	50	25.5	476			
	1999.11-	2004.01	6MT	R	R	Coupe Engine OM660DE8LA/OM660.940	GDS99191	Drive Shaft	42T	24	33	50	25.5	716			
<b>CROSSBLADE (450)</b>																	
0.6 (52 kW)	2002.06-	2003.12		L	R	Convertible Engine M160.920	GDS99190	Drive Shaft	42T	24	33	50	25.5	476			
	2002.06-	2003.12		R	R	Convertible Engine M160.920	GDS99191	Drive Shaft	42T	24	33	50	25.5	716			
<b>FORFOUR (454)</b>																	
1.1 (47 kW)	2005.02-						GC017048	Outer Joint		25	21	54	98	59	I		
1.1 (55 kW)	2004.01-						GC017048	Outer Joint		25	21	54	98	59	I		
	2004.07-	2005.04			F	Hatchback Engine M134.910	GC017048	Outer Joint		25	21	54	98	59	I		
1.3 (70 kW)	2004.01-						GC017048	Outer Joint		25	21	54	98	59	I		
	2004.07-	2006.06			F	Hatchback Engine M135.930	GC017048	Outer Joint		25	21	54	98	59	I		
1.5 (80 kW)	2004.01-						GC017048	Outer Joint		25	21	54	98	59	I		
	2004.07-	2006.06			F	Hatchback Engine M135.950	GC017048	Outer Joint		25	21	54	98	59	I		
1.5 CDi (50 kW)	2004.01-						GC039146	Outer Joint		25	23	53	97	61	M		
	2004.09-	2006.06			F	Hatchback Engine OM639.939	GC017048	Outer Joint		25	21	54	98	59	I		
1.5 CDi (70 kW)	2004.01-						GC039146	Outer Joint		25	23	53	97	61	M		
	2004.07-	2006.06			F	Hatchback Engine OM639.939	GC017048	Outer Joint		25	21	54	98	59	I		
<b>FORTWO (450)</b>																	
0.7 (37 kW)	2004.01-	2007.06		L	R	Coupe Engine M160.910	GDS99190	Drive Shaft	42T	24	33	50	25.5	476			
	2004.01-	2007.06		R	R	Coupe Engine M160.910	GDS99191	Drive Shaft	42T	24	33	50	25.5	716			
0.7 (45 kW)	2004.01-	2007.01		L	R	Coupe Engine M160.910	GDS99190	Drive Shaft	42T	24	33	50	25.5	476			
	2004.01-	2007.01		R	R	Coupe Engine M160.910	GDS99191	Drive Shaft	42T	24	33	50	25.5	716			
0.7 (55 kW)	2004.01-	2007.06		L	R	Coupe Engine M160.910	GDS99190	Drive Shaft	42T	24	33	50	25.5	476			
	2004.01-	2007.06		R	R	Coupe Engine M160.910	GDS99191	Drive Shaft	42T	24	33	50	25.5	716			
0.8 CDi (30 kW)	2004.01-	2007.01		L	R	Coupe Engine OM660DE8LA/OM660.940	GDS99190	Drive Shaft	42T	24	33	50	25.5	476			
	2004.01-	2007.01	6MT	R	R	Coupe Engine OM660DE8LA/OM660.940	GDS99191	Drive Shaft	42T	24	33	50	25.5	716			
<b>FORTWO (451)</b>																	
0.8 CDi (33 kW)	2007.01-		AT	L	R	Coupe Engine OM660.950	GDS35052	Drive Shaft	42T	33	33	56.2	44	521			
	2007.01-		AT	L	R	Coupe Engine OM660.950	GCI55001	Inner Joint		33	22	34.9	58	111.5			
	2007.01-		AT	R	R	Coupe Engine OM660.950	GDS35053	Drive Shaft	42T	33	33	56.2	44	763			
	2007.01-		AT	R	R	Coupe Engine OM660.950	GCI55001	Inner Joint		33	22	34.9	58	111.5			
0.8 CDi (40 kW)	2009.08-		AT	L	R	Coupe Engine OM660.951	GDS35052	Drive Shaft	42T	33	33	56.2	44	521			
	2009.08-		AT	L	R	Coupe Engine OM660.951	GCI55001	Inner Joint		33	22	34.9	58	111.5			
	2009.08-		AT	R	R	Coupe Engine OM660.951	GDS35053	Drive Shaft	42T	33	33	56.2	44	763			
	2009.08-		AT	R	R	Coupe Engine OM660.951	GCI55001	Inner Joint		33	22	34.9	58	111.5			
1.0 (45 kW)	2007.07-			L	R	Coupe Engine M132.910	GDS35052	Drive Shaft	42T	33	33	56.2	44	521			
	2007.07-			L	R	Coupe Engine M132.910	GCI55001	Inner Joint		33	22	34.9	58	111.5			
	2007.07-			R	R	Coupe Engine M132.910	GDS35053	Drive Shaft	42T	33	33	56.2	44	763			
	2007.07-			R	R	Coupe Engine M132.910	GCI55001	Inner Joint		33	22	34.9	58	111.5			
1.0 (52 kW)	2007.07-			L	R	Coupe Engine M132.910	GDS35052	Drive Shaft	42T	33	33	56.2	44	521			
	2007.07-			L	R	Coupe Engine M132.910	GCI55001	Inner Joint		33	22	34.9	58	111.5			
	2007.07-			R	R	Coupe Engine M132.910	GDS35053	Drive Shaft	42T	33	33	56.2	44	763			
	2007.07-			R	R	Coupe Engine M132.910	GCI55001	Inner Joint		33	22	34.9	58	111.5			
<b>FORTWO CABRIO (450)</b>																	
0.7 (45 kW)	2004.01-	2007.06		L	R	Convertible Engine M160.910	GDS99190	Drive Shaft	42T	24	33	50	25.5	476			
	2004.01-	2007.06		R	R	Convertible Engine M160.910	GDS99191	Drive Shaft	42T	24	33	50	25.5	716			
0.7 (55 kW)	2004.01-	2007.06		L	R	Convertible Engine M160.910	GDS99190	Drive Shaft	42T	24	33	50	25.5	476			
	2004.01-	2007.06		R	R	Convertible Engine M160.910	GDS99191	Drive Shaft	42T	24	33	50	25.5	716			
0.8 CDi (30 kW)	2004.01-	2007.01		L	R	Convertible Engine OM660DE8LA/OM660.940	GDS99190	Drive Shaft	42T	24	33	50	25.5	476			
	2004.01-	2007.01	6MT	R	R	Convertible Engine OM660DE8LA/OM660.940	GDS99191	Drive Shaft	42T	24	33	50	25.5	716			
<b>FORTWO CABRIO (451)</b>																	
0.8 CDi (33 kW)	2007.01-		AT	L	R	Convertible Engine OM660.950	GDS35052	Drive Shaft	42T	33	33	56.2	44	521			



		TRANSM	L/R	F/R		G-AP Ref.	PRODUCT	ABS	Technical Specifications						
									YEAR	A	B	C	H	L	P
<b>SMART</b>															
<b>FORTWO CABRIO (451)</b>															
0.8 CDi (33 kW)	2007.01-		AT	L	R	Convertible Engine OM660.950	GCI55001	Inner Joint		33	22	34.9	58	111.5	
	2007.01-		AT	R	R	Convertible Engine OM660.950	GDS35053	Drive Shaft	42T	33	33	56.2	44	763	
	2007.01-		AT	R	R	Convertible Engine OM660.950	GCI55001	Inner Joint		33	22	34.9	58	111.5	
1.0 (52 kW)	2007.07-			L	R	Convertible Engine M132.910	GDS35052	Drive Shaft	42T	33	33	56.2	44	521	
	2007.07-			L	R	Convertible Engine M132.910	GCI55001	Inner Joint		33	22	34.9	58	111.5	
	2007.07-			R	R	Convertible Engine M132.910	GDS35053	Drive Shaft	42T	33	33	56.2	44	763	
	2007.07-			R	R	Convertible Engine M132.910	GCI55001	Inner Joint		33	22	34.9	58	111.5	
<b>FORTWO, CABRIO, COUPE</b>															
0.8 CDi (33 kW)	2007.01-				R		GCI55001	Inner Joint		33	22	34.9	58	111.5	
0.8 CDi (40 kW)	2009.08-				R		GCI55001	Inner Joint		33	22	34.9	58	111.5	
1.0 (45 kW)	2007.01-				R		GCI55001	Inner Joint		33	22	34.9	58	111.5	
1.0 (52 kW)	2007.01-				R		GCI55001	Inner Joint		33	22	34.9	58	111.5	
1.0 Brabus (72 kW)	2008.01-				R		GCI55001	Inner Joint		33	22	34.9	58	111.5	
1.0 T (62 kW)	2007.01-				R		GCI55001	Inner Joint		33	22	34.9	58	111.5	
<b>ROADSTER (452)</b>															
0.7 (45 kW)	2003.04-2005.11			L	R	Convertible Engine M160.921	GDS99190	Drive Shaft	42T	24	33	50	25.5	476	
	2003.04-2005.11			R	R	Convertible Engine M160.921	GDS99191	Drive Shaft	42T	24	33	50	25.5	716	
	2003.06-2005.11			L	R	Coupe	GDS99190	Drive Shaft	42T	24	33	50	25.5	476	
	2003.06-2005.11			R	R	Coupe	GDS99191	Drive Shaft	42T	24	33	50	25.5	716	
0.7 (60 kW)	2003.04-2005.11			L	R	Convertible Engine M160.922	GDS99190	Drive Shaft	42T	24	33	50	25.5	476	
	2003.04-2005.11			L	R	Coupe	GDS99190	Drive Shaft	42T	24	33	50	25.5	476	
	2003.04-2005.11			R	R	Convertible Engine M160.922	GDS99191	Drive Shaft	42T	24	33	50	25.5	716	
	2003.04-2005.11			R	R	Coupe	GDS99191	Drive Shaft	42T	24	33	50	25.5	716	
0.7 Brabus (74 kW)	2003.12-2005.11			L	F	Coupe Engine M160.923	GDS99190	Drive Shaft	42T	24	33	50	25.5	476	
	2003.12-2005.11			R	F	Coupe Engine M160.923	GDS99191	Drive Shaft	42T	24	33	50	25.5	716	
	2004.04-2006.03			L	F	Convertible Engine M160.923	GDS99190	Drive Shaft	42T	24	33	50	25.5	476	
	2004.04-2006.03			R	F	Convertible Engine M160.923	GDS99191	Drive Shaft	42T	24	33	50	25.5	716	
<b>SSANGYONG FAMILY</b>															
2.2 D							GDS66001	Drive Shaft		24	23	48	148.5	943	
<b>KYRON</b>															
-	2005-	2012					GCI85048	Inner Joint			28		28		
<b>MUSSO (FJ)</b>															
2.3 D (59 kW)	1995.10-					Closed Off-Road Vehicle Engine MB-OM661/OM601.940	GDS66002	Drive Shaft		28		53	154	480	
2.9 D (73 kW)	1996.03-					Closed Off-Road Vehicle Engine MB-OM662	GDS66002	Drive Shaft		28		53	154	480	
<b>REXTON</b>															
-	2002-	2006					GC099158	Outer Joint		28	35	60	111	81	I
<b>REXTON (GAB_)</b>															
- 2WD	2002-	2006	5MT/4AT	L/R		D27DT,E23, E28	GDS66003	Drive Shaft		28	27	53	154	578	
	2002-	2006	5MT/4AT	L/R		D27DT,E23, E28	GC066001	Outer Joint		28	34	53	154	79	O
	2002-	2006	5MT/4AT	L/R		D27DT,E23, E28	GCI44022	Inner Joint		27	34	47.7	53.5	77	
- 4WD	2002-	2006	5MT/4AT	L/R		D27DT, E32	GDS66004	Drive Shaft		28	27	60	111	545	
	2002-	2006	5MT/4AT	L/R		D27DT, E32	GC099158	Outer Joint		28	35	60	111	81	I
	2002-	2006	5MT/4AT	L/R		D27DT, E32	GCI44023	Inner Joint		27	35	47.7	56.5	63.5	
2.7 D 4x4 (137 kW)	2006.05-					Closed Off-Road Vehicle Engine D27DTP	GC099059	Outer Joint		28	35	53	154	79	O
2.7 XDi (120 kW)	2004.05-	2007.03				Closed Off-Road Vehicle Engine D27DT	GC099059	Outer Joint		28	35	53	154	79	O
<b>REXTON I</b>															
-	2002-	2006					GCI85048	Inner Joint			28		28		
<b>REXTON II</b>															
-	2006-	2006					GCI85048	Inner Joint			28		28		
<b>SUBARU</b>															
<b>ALCYONE / LEONE / LOYALE / DOMINGO</b>															
1.8	1985-	1987	MT/AT				GCI56003	Inner Joint		25	25	40.1	34	83	
<b>B4</b>															
-							GDS56010	Drive Shaft	44T	27	25	56	86.5	682.5	
<b>BRUMBY</b>															
1.8	1990.01-		MT/AT	L/R	R	MY MV	GDS56020	Drive Shaft		23	23	40	41	502.5	
<b>FIORI</b>															
-	1990.01-	1992.12		L			GDS56017	Drive Shaft		24	23	50	108	535.5	

		TRANSM	L/R	F/R		G-AP Ref.	PRODUCT	ABS	Technical Specifications								
									YEAR	A	B	C	H	L	P		
<b>SUBARU FIORI</b>																	
-	1990.01-	1992.12	MT/AT														
<b>FORESTER</b>																	
-	1997.01-	2002.06	MT/AT	L/R	F												
	1997.01-	2002.06	MT/AT	L/R	F		GDS56021	Drive Shaft	44T	27	25	56	86.5	682.5			
	1997.08-	2002.06					GCI56004	Inner Joint		25	30	40	35.8	75.5			
	2004-						GCI56012	Inner Joint		25	29	35	77.5	110			
	2004-						GC056027	Outer Joint	44T	27	23	56	86.5	63	M		
	2004-						GDS56014	Drive Shaft	44T	27	25	56	86.5	780			
<b>FORESTER (SF)</b>																	
2.0 (90 kW)	1997.08-	2002.09			F	Closed Off-Road Vehicle Engine EJ20	GC056017	Outer Joint		27	30	56	87	58.5	I		
	1997.08-	2002.09			F	Closed Off-Road Vehicle Engine EJ20	GC056005	Outer Joint		27	22	56	87	66	M		
2.0 (92 kW)	1998.06-	2002.09			F	Closed Off-Road Vehicle Engine EJ20	GC056017	Outer Joint		27	30	56	87	58.5	I		
	1998.06-	2002.09			F	Closed Off-Road Vehicle Engine EJ20	GC056005	Outer Joint		27	22	56	87	66	M		
2.0 S Turbo (130 kW)	2001.04-	2002.09			F	Closed Off-Road Vehicle Engine EJ205	GC056017	Outer Joint		27	30	56	87	58.5	I		
	2001.04-	2002.09			F	Closed Off-Road Vehicle Engine EJ205	GC056005	Outer Joint		27	22	56	87	66	M		
<b>FORESTER (SG)</b>																	
2.0 (92 kW)	2002.09-					Closed Off-Road Vehicle Engine EJ20	GC056041	Outer Joint	44T	27	23	56	87	61	M		
	2002.09-				F	Closed Off-Road Vehicle Engine EJ20	GC056005	Outer Joint		27	22	56	87	66	M		
	2002.09-				F	Closed Off-Road Vehicle Engine EJ20	GDS56016	Drive Shaft	44T	27	25	56	86.5	771			
	2002.09-				F	Closed Off-Road Vehicle Engine EJ20	GCI56013	Inner Joint		25	29	35	77.5	110			
	2002.09-				F	Closed Off-Road Vehicle Engine EJ20	GC056021	Outer Joint		27	30	56	86.5	55.5	I		
2.0 S Turbo (130 kW)	2002.09-					Closed Off-Road Vehicle Engine EJ20	GC056041	Outer Joint	44T	27	23	56	87	61	M		
	2002.09-				F	Closed Off-Road Vehicle Engine EJ20	GC056026	Outer Joint	44T	27	30	56	86.5	63	I		
	2002.09-				F	Closed Off-Road Vehicle Engine EJ20	GC056005	Outer Joint		27	22	56	87	66	M		
	2002.09-				F	Closed Off-Road Vehicle Engine EJ20	GDS56016	Drive Shaft	44T	27	25	56	86.5	771			
	2002.09-				F	Closed Off-Road Vehicle Engine EJ20	GCI56013	Inner Joint		25	29	35	77.5	110			
	2002.09-				F	Closed Off-Road Vehicle Engine EJ20	GC056021	Outer Joint		27	30	56	86.5	55.5	I		
2.0 X (116 kW)	2005.09-					Closed Off-Road Vehicle Engine EJ204	GC056041	Outer Joint	44T	27	23	56	87	61	M		
	2005.09-				F	Closed Off-Road Vehicle Engine EJ204	GC056026	Outer Joint	44T	27	30	56	86.5	63	I		
	2005.09-				F	Closed Off-Road Vehicle Engine EJ204	GC056005	Outer Joint		27	22	56	87	66	M		
	2005.09-				F	Closed Off-Road Vehicle Engine EJ204	GDS56016	Drive Shaft	44T	27	25	56	86.5	771			
	2005.09-				F	Closed Off-Road Vehicle Engine EJ204	GCI56013	Inner Joint		25	29	35	77.5	110			
	2005.09-				F	Closed Off-Road Vehicle Engine EJ204	GC056021	Outer Joint		27	30	56	86.5	55.5	I		
2.5 (155 kW)	2003.12-				F	Closed Off-Road Vehicle Engine EJ25	GC056026	Outer Joint	44T	27	30	56	86.5	63	I		
	2003.12-				F	Closed Off-Road Vehicle Engine EJ25	GDS56016	Drive Shaft	44T	27	25	56	86.5	771			
	2003.12-				F	Closed Off-Road Vehicle Engine EJ25	GCI56013	Inner Joint		25	29	35	77.5	110			
	2003.12-				F	Closed Off-Road Vehicle Engine EJ25	GC056021	Outer Joint		27	30	56	86.5	55.5	I		
2.5 (171 kW)	2005.01-				F	Closed Off-Road Vehicle Engine EJ255	GDS56016	Drive Shaft	44T	27	25	56	86.5	771			
	2005.01-				F	Closed Off-Road Vehicle Engine EJ255	GCI56013	Inner Joint		25	29	35	77.5	110			
	2005.01-				F	Closed Off-Road Vehicle Engine EJ255	GC056021	Outer Joint		27	30	56	86.5	55.5	I		
2.5 XT (169 kW)	2004.09-	2006.11			F	Closed Off-Road Vehicle Engine EJ255	GC056026	Outer Joint	44T	27	30	56	86.5	63	I		
	2004.09-	2006.11			F	Closed Off-Road Vehicle Engine EJ255	GDS56016	Drive Shaft	44T	27	25	56	86.5	771			
	2004.09-	2006.11			F	Closed Off-Road Vehicle Engine EJ255	GCI56013	Inner Joint		25	29	35	77.5	110			
	2004.09-	2006.11			F	Closed Off-Road Vehicle Engine EJ255	GC056021	Outer Joint		27	30	56	86.5	55.5	I		
<b>FORESTER (SH)</b>																	
2.0 AWD (110 kW)	2008.01-				F	Closed Off-Road Vehicle Engine EJ20	GDS56068	Drive Shaft		27	25	52	76.5	795			
	2008.01-					Closed Off-Road Vehicle Engine EJ20	GC099339	Outer Joint		27	32	52	76.5	62.5	I		
	2010.01-				F	Closed Off-Road Vehicle Engine FB20	GDS56068	Drive Shaft		27	25	52	76.5	795			
	2010.01-					Closed Off-Road Vehicle Engine FB20	GC099339	Outer Joint		27	32	52	76.5	62.5	I		
2.0 D AWD (108 kW)	2008.09-				F	Closed Off-Road Vehicle	GDS56068	Drive Shaft		27	25	52	76.5	795			
	2008.09-					Closed Off-Road Vehicle	GC099339	Outer Joint		27	32	52	76.5	62.5	I		
2.5 AWD (126 kW)	2009.01-				F	Closed Off-Road Vehicle Engine EJ25	GDS56068	Drive Shaft		27	25	52	76.5	795			
	2009.01-					Closed Off-Road Vehicle Engine EJ25	GC099339	Outer Joint		27	32	52	76.5	62.5	I		
<b>IMPREZA</b>																	
-							GDS56015	Drive Shaft	44T	27	25	56	86.5	693			
	1993-	1996	AT	L/R	2WD		GDS56006	Drive Shaft		27	25	56	87	684			
	1993-	1996	AT	L/R	4WD		GDS56006	Drive Shaft		27	25	56	87	684			
	1993-	1996	MT	L/R	4WD		GDS56006	Drive Shaft		27	25	56	87	684			
	2001-						GC056020	Outer Joint		27	30	56	86.5	63	I		
	2004-						GCI56013	Inner Joint		25	29	35	77.5	110			
	2004-						GC056021	Outer Joint		27	30	56	86.5	55.5	I		









		TRANSM	L/R	F/R		G-AP Ref.	PRODUCT	ABS	Technical Specifications									
									YEAR	A	B	C	H	L	P			
<b>SUBARU IMPREZA</b>																		
-	2004-					GC056024	Outer Joint	44T	27	30	56	86.5	55.5	I				
	2004-					GDS56016	Drive Shaft	44T	27	25	56	86.5	771					
	2004-					GC056021	Outer Joint		27	30	56	86.5	55.5	I				
	2004-					GCI56013	Inner Joint		25	29	35	77.5	110					
2.0 i All-wheel Drive (92 kW)	2002.12-	2007.12			F Hatchback Engine EJ201	GDS56016	Drive Shaft	44T	27	25	56	86.5	771					
	2002.12-	2007.12			F Hatchback Engine EJ201	GCI56013	Inner Joint		25	29	35	77.5	110					
	2002.12-	2007.12			F Hatchback Engine EJ201	GC056021	Outer Joint		27	30	56	86.5	55.5	I				
2.5 WRX (169 kW)	2005.09-				F Hatchback Engine EJ255	GDS56016	Drive Shaft	44T	27	25	56	86.5	771					
	2005.09-				F Hatchback Engine EJ255	GCI56013	Inner Joint		25	29	35	77.5	110					
	2005.09-				F Hatchback Engine EJ255	GC056021	Outer Joint		27	30	56	86.5	55.5	I				
	2005.09-				Hatchback Engine EJ255	GC056048	Outer Joint	44T	27	32	56	86.5	71.5	I				
<b>IMPREZA (CDAC)</b>																		
2.0 4WD	2002.11-	2003.08	4AT		F Engine EJ205 TBO	GC056067	Outer Joint	44T	27	30	56	86.5	56	M				
<b>IMPREZA (GD2D)</b>																		
1.5	2003.09-	2004.05	4AT/5MT		Engine EJ152	GC056067	Outer Joint	44T	27	30	56	86.5	56	M				
<b>IMPREZA (GD2E)</b>																		
1.5	2004.06-	2005.03	4AT/5MT		Engine EJ152	GC056067	Outer Joint	44T	27	30	56	86.5	56	M				
<b>IMPREZA (GD2F)</b>																		
1.5	2005.06-		4AT/5MT		Engine EJ152	GC056067	Outer Joint	44T	27	30	56	86.5	56	M				
<b>IMPREZA (GD3D)</b>																		
1.5 4WD	2003.09-	2004.05	4AT/5MT		Engine EJ152	GC056067	Outer Joint	44T	27	30	56	86.5	56	M				
<b>IMPREZA (GD3E)</b>																		
1.5 4WD	2004.06-	2005.03	4AT/5MT		Engine EJ152	GC056067	Outer Joint	44T	27	30	56	86.5	56	M				
<b>IMPREZA (GD9A)</b>																		
2.0 4WD	2000.08-	2001.08	4AT/5MT		Engine EJ204 TBO	GC056067	Outer Joint	44T	27	30	56	86.5	56	M				
<b>IMPREZA (GD9B)</b>																		
2.0 4WD	2001.09-	2002.10	4AT/5MT		Engine EJ204 TBO	GC056067	Outer Joint	44T	27	30	56	86.5	56	M				
<b>IMPREZA (GD9C)</b>																		
2.0 4WD	2002.11-	2003.08	4AT/5MT		Engine EJ204	GC056067	Outer Joint	44T	27	30	56	86.5	56	M				
<b>IMPREZA (GDA A)</b>																		
2.0 4WD	2000.08-	2008.01	4AT	F	Engine EJ205 TBO	GC056067	Outer Joint	44T	27	30	56	86.5	56	M				
	2000.08-	2008.01	5MT	F	Engine EJ205 TBO	GC056067	Outer Joint	44T	27	30	56	86.5	56	M				
<b>IMPREZA (GDAB)</b>																		
2.0 4WD	2001.09-	2002.10	4AT	F	Engine EJ205 TBO	GC056067	Outer Joint	44T	27	30	56	86.5	56	M				
	2001.09-	2002.10	5MT	F	Engine EJ205 TBO	GC056067	Outer Joint	44T	27	30	56	86.5	56	M				
<b>IMPREZA (GDAC)</b>																		
2.0 4WD	2002.11-	2003.08	5MT	F	Engine EJ205 TBO	GC056067	Outer Joint	44T	27	30	56	86.5	56	M				
<b>IMPREZA (GDAD)</b>																		
2.0 4WD	2003.09-	2004.05	4AT	F	Engine EJ205 TBO	GC056067	Outer Joint	44T	27	30	56	86.5	56	M				
	2003.09-	2004.05	5MT	F	Engine EJ205 TBO	GC056067	Outer Joint	44T	27	30	56	86.5	56	M				
<b>IMPREZA (GDAE)</b>																		
2.0 4WD	2004.06-	2005.03	4AT	F	Engine EJ205 TBO	GC056067	Outer Joint	44T	27	30	56	86.5	56	M				
	2004.06-	2005.05	5MT	F	Engine EJ205 TBO	GC056067	Outer Joint	44T	27	30	56	86.5	56	M				
<b>IMPREZA (GDAF)</b>																		
2.0 4WD	2005.06-		4AT	F	Engine EJ205 TBO	GC056067	Outer Joint	44T	27	30	56	86.5	56	M				
	2005.06-		5MT	F	Engine EJ205 TBO	GC056067	Outer Joint	44T	27	30	56	86.5	56	M				
<b>IMPREZA (GC)</b>																		
1.6 i AWD (66 kW)	1992.08-	2000.12			F Saloon Engine EJ16	GC056008	Outer Joint		27	30	56	87	66	I				
	1992.08-	2000.12	MT/AT	F	Saloon Engine EJ16	GC056004	Outer Joint		27	30	56	87	68	M				
1.6 i AWD (70 kW)	1998.06-	2000.12	MT/AT	F	Saloon Engine EJ161	GC056039	Outer Joint		27	30	56	87.1	58	M				
1.8 i AWD (76 kW)	1992.08-	2000.12			F Saloon Engine EJ18/EJ18E	GC056008	Outer Joint		27	30	56	87	66	I				
	1992.08-	2000.12	MT/AT	F	Saloon Engine EJ18/EJ18E	GC056004	Outer Joint		27	30	56	87	68	M				
2.0 i AWD (85 kW)	1995.10-	2000.12			F Saloon Engine EJ20	GC056008	Outer Joint		27	30	56	87	66	I				
2.0 i AWD (92 kW)	1998.06-	2000.12	MT/AT	F	Saloon Engine EJ20	GC056039	Outer Joint		27	30	56	87.1	58	M				
2.0 Turbo GT AWD (155 kW)	1994.03-	2000.12			F Saloon Engine EJ20	GC056008	Outer Joint		27	30	56	87	66	I				
	1994.03-	2000.12	MT&AT	F	Saloon Engine EJ20	GC056004	Outer Joint		27	30	56	87	68	M				
2.0 Turbo GT AWD (160 kW)	1998.06-	2000.12	MT/AT	F	Saloon Engine EJ205	GC056039	Outer Joint		27	30	56	87.1	58	M				
<b>IMPREZA (GC8)</b>																		
2.0 4WD	1998.01-		MT		Engine EJ207	GC056040	Outer Joint		27	30	56	86.5	62.7	M				



		TRANSM	L/R	F/R		G-AP Ref.	PRODUCT	ABS	Technical Specifications						
									YEAR	A	B	C	H	L	P
<b>SUBARU</b>															
<b>IMPREZA (GD, GG)</b>															
1.5 AWD (77 kW)	2006.10-	2008.03			F	Saloon Engine EL15	GC056009	Outer Joint	44T	27	30	56	86.5	63	M
	2006.10-	2008.03			F	Saloon Engine EL15	GDS56013	Drive Shaft		27	25	52	77	770	
	2007.05-				F	Estate Engine EL15	GDS56013	Drive Shaft		27	25	52	77	770	
2.0 AWD (206 kW)	2005.10-				F	Saloon Engine EJ205P	GC056009	Outer Joint	44T	27	30	56	86.5	63	M
	2005.10-					Saloon Engine EJ205P	GC056048	Outer Joint	44T	27	32	56	86.5	71.5	I
2.0 i AWD (92 kW)	2000.12-				F	Saloon Engine EJ20	GDS56016	Drive Shaft	44T	27	25	56	86.5	771	
	2000.12-				F	Saloon Engine EJ20	GCI56013	Inner Joint		25	29	35	77.5	110	
	2000.12-				F	Saloon Engine EJ20	GC056021	Outer Joint		27	30	56	86.5	55.5	I
2.0 i R AWD (118 kW)	2005.09-				F	Estate Engine EJ204/EJ20	GC056009	Outer Joint	44T	27	30	56	86.5	63	M
	2005.09-	2008.03			F	Saloon Engine EJ204	GC056009	Outer Joint	44T	27	30	56	86.5	63	M
	2005.09-	2008.03			F	Saloon Engine EJ204	GDS56016	Drive Shaft	44T	27	25	56	86.5	771	
	2005.09-	2008.03			F	Saloon Engine EJ204	GCI56013	Inner Joint		25	29	35	77.5	110	
	2005.09-	2008.03			F	Saloon Engine EJ204	GC056021	Outer Joint		27	30	56	86.5	55.5	I
	2005.09-				F	Estate Engine EJ204/EJ20	GDS56016	Drive Shaft	44T	27	25	56	86.5	771	
	2005.09-				F	Estate Engine EJ204/EJ20	GCI56013	Inner Joint		25	29	35	77.5	110	
2.0 i WRX AWD (168 kW)	2002.12-	2005.09			F	Saloon Engine EJ205	GDS56016	Drive Shaft	44T	27	25	56	86.5	771	
	2002.12-	2005.09			F	Saloon Engine EJ205	GCI56013	Inner Joint		25	29	35	77.5	110	
	2002.12-	2005.09			F	Saloon Engine EJ205	GC056021	Outer Joint		27	30	56	86.5	55.5	I
2.0 WRX STi AWD (195 kW)	2001.11-				F	Saloon Engine EJ207	GDS56016	Drive Shaft	44T	27	25	56	86.5	771	
	2001.11-				F	Saloon Engine EJ207	GCI56013	Inner Joint		25	29	35	77.5	110	
	2001.11-				F	Saloon Engine EJ207	GC056021	Outer Joint		27	30	56	86.5	55.5	I
	2001.11-					Saloon Engine EJ207	GC056048	Outer Joint	44T	27	32	56	86.5	71.5	I
2.0 WRX STi AWD (235 kW)	2004.01-	2005.03			F	Saloon Engine EJ207	GDS56016	Drive Shaft	44T	27	25	56	86.5	771	
	2004.01-	2005.03			F	Saloon Engine EJ207	GCI56013	Inner Joint		25	29	35	77.5	110	
	2004.01-	2005.03			F	Saloon Engine EJ207	GC056021	Outer Joint		27	30	56	86.5	55.5	I
	2004.01-	2005.03				Saloon Engine EJ207	GC056048	Outer Joint	44T	27	32	56	86.5	71.5	I
2.0 WRX Turbo AWD (160 kW)	2000.12-				F	Saloon Engine EJ205	GDS56016	Drive Shaft	44T	27	25	56	86.5	771	
	2000.12-				F	Saloon Engine EJ205	GCI56013	Inner Joint		25	29	35	77.5	110	
	2000.12-				F	Saloon Engine EJ205	GC056021	Outer Joint		27	30	56	86.5	55.5	I
2.0 WRX Turbo AWD (165 kW)	2002.12-				F	Estate Engine EJ205	GC056026	Outer Joint	44T	27	30	56	86.5	63	I
	2002.12-				F	Estate Engine EJ205	GDS56016	Drive Shaft	44T	27	25	56	86.5	771	
	2002.12-				F	Estate Engine EJ205	GCI56013	Inner Joint		25	29	35	77.5	110	
	2002.12-				F	Estate Engine EJ205	GC056021	Outer Joint		27	30	56	86.5	55.5	I
	2003.01-	2006.11			F	Saloon Engine EJ205	GC056026	Outer Joint	44T	27	30	56	86.5	63	I
	2003.01-	2006.11			F	Saloon Engine EJ205	GDS56016	Drive Shaft	44T	27	25	56	86.5	771	
	2003.01-	2006.11			F	Saloon Engine EJ205	GCI56013	Inner Joint		25	29	35	77.5	110	
2.5 i WRX AWD (169 kW)	2005.09-	2008.03			F	Saloon Engine EJ255	GDS56016	Drive Shaft	44T	27	25	56	86.5	771	
	2005.09-	2008.03			F	Saloon Engine EJ255	GCI56013	Inner Joint		25	29	35	77.5	110	
	2005.09-	2008.03			F	Saloon Engine EJ255	GC056021	Outer Joint		27	30	56	86.5	55.5	I
	2005.09-	2008.03				Saloon Engine EJ255	GC056048	Outer Joint	44T	27	32	56	86.5	71.5	I
2.5 WRX AWD (169 kW)	2005.09-				F	Estate Engine EJ255	GDS56016	Drive Shaft	44T	27	25	56	86.5	771	
	2005.09-				F	Estate Engine EJ255	GCI56013	Inner Joint		25	29	35	77.5	110	
	2005.09-				F	Estate Engine EJ255	GC056021	Outer Joint		27	30	56	86.5	55.5	I
	2005.09-					Estate Engine EJ255	GC056048	Outer Joint	44T	27	32	56	86.5	71.5	I
2.5 WRX STi AWD (206 kW)	2005.09-	2008.03			F	Saloon Engine EJ257	GDS56016	Drive Shaft	44T	27	25	56	86.5	771	
	2005.09-	2008.03			F	Saloon Engine EJ257	GCI56013	Inner Joint		25	29	35	77.5	110	
	2005.09-	2008.03			F	Saloon Engine EJ257	GC056021	Outer Joint		27	30	56	86.5	55.5	I
	2005.09-	2008.03				Saloon Engine EJ257	GC056048	Outer Joint	44T	27	32	56	86.5	71.5	I
<b>IMPREZA (GDBD)</b>															
2.0 4WD	2001.09-	2004.05	6MT			Engine EJ207TBO	GC056057	Outer Joint	44T	27	32	56	86.5	68.5	I
<b>IMPREZA (GDBE)</b>															
2.0 4WD	2004.06-	2005.05	6MT/F				GC056058	Outer Joint	44T	27	32	54.5	86	67	I
<b>IMPREZA (GF)</b>															
1.6 i AWD (66 kW)	1992.08-	2000.12			F	Estate Engine EJ16	GC056008	Outer Joint		27	30	56	87	66	I
	1992.08-	2000.12	MT/AT		F	Estate Engine EJ16	GC056004	Outer Joint		27	30	56	87	68	M
1.6 i AWD (70 kW)	1998.06-	2000.12	MT/AT		F	Estate Engine EJ161	GC056039	Outer Joint		27	30	56	87.1	58	M
1.8 i AWD (76 kW)	1992.08-	2000.12			F	Estate Engine EJ18	GC056008	Outer Joint		27	30	56	87	66	I
	1992.08-	2000.12	MT/AT		F	Estate Engine EJ18	GC056004	Outer Joint		27	30	56	87	68	M
2.0 i AWD (85 kW)	1995.12-	2000.12			F	Estate Engine EJ20	GC056008	Outer Joint		27	30	56	87	66	I

		YEAR	TRANSM	L/R	F/R		G-AP Ref.	PRODUCT	ABS	Technical Specifications						
										A	B	C	H	L	P	
<b>SUBARU</b>																
<b>IMPREZA (GF)</b>																
2.0 i AWD (85 kW)	1995.12-	2000.12	MT/AT			F Estate Engine EJ20	GC056004	Outer Joint			27	30	56	87	68	M
2.0 i Turbo AWD (155 kW)	1994.03-	2000.12				F Estate Engine EJ20	GC056008	Outer Joint			27	30	56	87	66	I
	1994.03-	2000.12	MT&AT			F Estate Engine EJ20	GC056004	Outer Joint			27	30	56	87	68	M
2.0 Turbo GT AWD (160 kW)	1998.06-	2000.12	MT/AT			F Estate Engine EJ205	GC056039	Outer Joint			27	30	56	87.1	58	M
<b>IMPREZA (GF8)</b>																
2	1997.01-	1999.12	MT/AT			Engine EJ20G	GC056040	Outer Joint			27	30	56	86.5	62.7	M
2.0 4WD	1998.01-		MT			Engine EJ207	GC056040	Outer Joint			27	30	56	86.5	62.7	M
<b>IMPREZA (GFC)</b>																
1.6 AWD (66 kW)	1996.12-	2000.12	MT/AT			F Coupe Engine EJ161	GC056004	Outer Joint			27	30	56	87	68	M
2.0 AWD (85 kW)	1995.12-	2000.12	MT/AT			F Coupe Engine EJ20	GC056004	Outer Joint			27	30	56	87	68	M
2.0 Turbo AWD (155 kW)	1996.12-	2000.12	MT/AT			F Coupe Engine EJ20G	GC056039	Outer Joint			27	30	56	87.1	58	M
<b>IMPREZA (GR, GH, G3)</b>																
1.5 (79 kW)	2008.02-					F Hatchback Engine EL15	GDS56013	Drive Shaft			27	25	52	77	770	
1.5 F (79 kW)	2008.02-					F Hatchback Engine EL15	GDS56013	Drive Shaft			27	25	52	77	770	
2.0 D (110 kW)	2009.01-					F Hatchback	GDS56013	Drive Shaft			27	25	52	77	770	
2.0 i (110 kW)	2008.01-					F Hatchback Engine EJ204	GDS56013	Drive Shaft			27	25	52	77	770	
2.5 (169 kW)	2008.01-				L/R	F Hatchback Engine EJ255	GDS56013	Drive Shaft			27	25	52	77	770	
<b>IMPREZA / WRX / STI</b>																
2	1998-		MT			GC8/GF8 EJ207	GCI56005	Inner Joint			25	29	40.1	37.5	68	
<b>IMPREZA SPORTS WAGON (GGBA)</b>																
2.0 4WD	2000.10-	2001.08	6MT			Engine EJ207TBO	GC056057	Outer Joint	44T		27	32	56	86.5	68.5	I
<b>IMPREZA SPORTS WAGON (GGBB)</b>																
2.0 4WD	2001.09-	2002.10	6MT			Engine EJ207TBO	GC056057	Outer Joint	44T		27	32	56	86.5	68.5	I
<b>JUSTY (KA7)</b>																
1.2	1988.11-	1994.02	ECVT			Engine EF12	GC056060	Outer Joint			27	21	50	108	48.7	M
<b>JUSTY (KA8)</b>																
1.2	1988.11-	1994.03	MT/AT			Engine EF12	GC056060	Outer Joint			27	21	50	108	48.7	M
1.2 4WD	1988.11-	1994.02	ECVT			Engine EF12	GC056060	Outer Joint			27	21	50	108	48.7	M
<b>JUSTY (KAD)</b>																
1.0 (37 kW)	1987.05-	1995.10	MT/AT			F Hatchback Engine EF10	GC056014	Outer Joint			24	19	50	108	51	M
	1987.05-	1995.10				F Hatchback Engine EF10	GC056031	Outer Joint			24	19	50	108	47	M
	1987.05-	1995.10				F Hatchback Engine EF10	GC056016	Outer Joint			27	19	50	108.5	51	M
1.0 (40 kW)	1984.11-	1989.06	MT/AT			F Hatchback Engine EF10	GC056014	Outer Joint			24	19	50	108	51	M
	1984.11-	1989.06				F Hatchback Engine EF10	GC056031	Outer Joint			24	19	50	108	47	M
	1984.11-	1989.06				F Hatchback Engine EF10	GC056016	Outer Joint			27	19	50	108.5	51	M
1.0 4WD (37 kW)	1987.05-	1994.11				F Hatchback Engine EF10	GC056006	Outer Joint			27	21	50	110	52.5	M
	1987.05-	1994.11	MT/AT			F Hatchback Engine EF10	GC056014	Outer Joint			24	19	50	108	51	M
	1987.05-	1994.11				Hatchback Engine EF10	GC056031	Outer Joint			24	19	50	108	47	M
1.0 4WD (40 kW)	1984.11-	1990.12				F Hatchback Engine EF10	GC056006	Outer Joint			27	21	50	110	52.5	M
	1984.11-	1990.12	MT/AT			F Hatchback Engine EF10	GC056014	Outer Joint			24	19	50	108	51	M
	1984.11-	1990.12				Hatchback Engine EF10	GC056031	Outer Joint			24	19	50	108	47	M
1.2 (49 kW)	1987.05-	1995.10				F Hatchback Engine EF12	GC056006	Outer Joint			27	21	50	110	52.5	M
	1987.05-	1995.10	MT/AT			F Hatchback Engine EF12	GC056014	Outer Joint			24	19	50	108	51	M
1.2 4WD (49 kW)	1987.05-	1991.05				F Hatchback Engine EF12	GC056006	Outer Joint			27	21	50	110	52.5	M
	1987.05-	1991.05				F Hatchback Engine EF12	GC099255	Outer Joint			24	21	50	108	51	M
	1987.05-	1991.05	MT/AT			F Hatchback Engine EF12	GC056030	Outer Joint			24	21	50	106.5	56	M
1.2 4WD (50 kW)	1986.10-	1990.12				F Hatchback Engine EF12	GC056006	Outer Joint			27	21	50	110	52.5	M
	1986.10-	1990.12	MT/AT			F Hatchback Engine EF12	GC056014	Outer Joint			24	19	50	108	51	M
	1986.10-	1990.12				F Hatchback Engine EF12	GC099255	Outer Joint			24	21	50	108	51	M
1.2 4WD (55 kW)	1990.10-	1994.12				F Hatchback Engine EF12	GC056006	Outer Joint			27	21	50	110	52.5	M
<b>JUSTY III (G3X)</b>																
1.3 (69 kW)	2003.09-					Hatchback Engine M13A	GC057062	Outer Joint	43T		25	28	49	76	61	I
	2003.09-						GC057062	Outer Joint	43T		25	28	49	76	61	I
1.5 (73 kW)	2003.09-						GC057062	Outer Joint	43T		25	28	49	76	61	I
<b>LEGACY</b>																
-					R		GC056029	Outer Joint			24	21	50	104	64.5	I
	1990-	1996			L/R		GDS56006	Drive Shaft			27	25	56	87	684	
	2001-						GC056020	Outer Joint			27	30	56	86.5	63	I
1.6							GCI56009	Inner Joint			23	30	40	35.8	75.5	
							GDS56007	Drive Shaft			27	23	56	87	686.5	
2	1989-		MT/AT				GCI56003	Inner Joint			25	25	40.1	34	83	







		TRANSM	L/R	F/R		G-AP Ref.	PRODUCT	ABS	Technical Specifications											
									YEAR	A	B	C	H	L	P					
<b>SUBARU</b>																				
<b>LEGACY</b>																				
2	1993-																			
2.2	1989-																			
<b>LEGACY (BC)</b>																				
1.8 (76 kW)	1989.01-	1993.12	MT/AT		F	Saloon Engine EJ18SPI	GC056004	Outer Joint												
1.8 4WD (76 kW)	1989.01-	1991.09			F	Saloon Engine EJ18SPI	GC056004	Outer Joint												
2.0 (85 kW)	1991.08-	1993.12	MT		F	Saloon Engine EJ20E	GC056003	Outer Joint												
2.0 Turbo 4WD (147 kW)	1992.05-	1994.07	MT		F	Saloon Engine EJ20-GN	GC056004	Outer Joint												
2200 4WD (100 kW)	1989.01-	1994.07	MT		F	Saloon Engine EJ22EMPI	GC056004	Outer Joint												
<b>LEGACY (BC, BJF)</b>																				
1.8 (76 kW)	1989.01-	1994.07	MT/AT		F	Estate Engine EJ18SPI	GC056004	Outer Joint												
1.8 4WD (76 kW)	1989.01-	1994.07			F	Estate Engine EJ18SPI	GC056004	Outer Joint												
2.0 (85 kW)	1991.09-	1993.12	MT		F	Estate Engine EJ20EMPI	GC056003	Outer Joint												
2.0 Turbo Super 4WD (147 kW)	1992.05-	1994.07	MT		F	Estate Engine EJ20-GN	GC056004	Outer Joint												
2200 Super 4WD (100 kW)	1989.01-	1994.07	MT		F	Estate Engine EJ22EMPI	GC056004	Outer Joint												
<b>LEGACY (BE5)</b>																				
2	1998.12-	1999.04	4AT			Engine EJ20 TBO	GC056040	Outer Joint												
	1998.12-	1999.04	MT/AT			Engine EJ20	GC056040	Outer Joint												
<b>LEGACY (BH5)</b>																				
2	1998.06-		4AT			Engine EJ206	GC056040	Outer Joint												
	1998.06-		MT/AT			Engine EJ201/EJ204	GC056040	Outer Joint												
<b>LEGACY (BH9)</b>																				
2.5	1998.06-		4AT			Engine EJ254	GC056040	Outer Joint												
<b>LEGACY (BHC)</b>																				
2.5	1998.06-		4AT			Engine EJ254	GC056040	Outer Joint												
<b>LEGACY / WRX</b>																				
-	2001-					4WD	GC056028	Outer Joint												
<b>LEGACY I</b>																				
1.8	1989.10-		AT	L/R		4WD	GDS56002	Drive Shaft												
	1989.10-		MT	L/R		4WD	GDS56002	Drive Shaft												
2	1994.04-	1999.10	AT	L/R		4WD	GDS56002	Drive Shaft												
2.0 T	1991.10-		MT	L/R		4WD	GDS56002	Drive Shaft												
2.2	1989.10-		AT	L/R		4WD	GDS56002	Drive Shaft												
	1989.10-		MT	L/R		4WD	GDS56002	Drive Shaft												
	1994.04-	1999.10	AT	L/R		4WD	GDS56002	Drive Shaft												
2.5	1994.04-	1999.10	AT	L/R		4WD	GDS56002	Drive Shaft												
<b>LEGACY II (BD, BG)</b>																				
2.0 i 4WD (85 kW)	1994.09-	1998.11	MT/AT		F	Estate Engine EJ20	GC056039	Outer Joint												
	1994.09-	1999.03	MT/AT		F	Saloon Engine EJ20	GC056039	Outer Joint												
	1994.09-	1998.11			F	Estate Engine EJ20	GC056008	Outer Joint												
	1994.09-	1999.03			F	Saloon Engine EJ20	GC056008	Outer Joint												
2.2 i 4WD (94 kW)	1994.02-	1998.12	MT/AT		F	Estate Engine EJ22EMPI	GC056039	Outer Joint												
	1994.02-	1998.12			F	Estate Engine EJ22EMPI	GC056008	Outer Joint												
	1994.09-	1999.03	MT/AT		F	Saloon Engine EJ22EMPI	GC056039	Outer Joint												
	1994.09-	1999.03			F	Saloon Engine EJ22EMPI	GC056008	Outer Joint												
2.2 i 4WD (96 kW)	1996.06-	1998.11			F	Estate Engine EJ22EMPI	GC056008	Outer Joint												
	1996.06-	1999.03			F	Saloon Engine EJ22EMPI	GC056008	Outer Joint												
<b>LEGACY III (BE, BH)</b>																				
2.0 (92 kW)	1999.04-	2003.08			F	Saloon Engine EJ20	GC056026	Outer Joint	44T											
2.0 AWD (92 kW)	1998.12-	2003.08			F	Estate Engine EJ20	GC056026	Outer Joint	44T											
2.5 (115 kW)	1998.10-	2003.08			F	Saloon Engine EJ25	GC056026	Outer Joint	44T											
2.5 AWD (115 kW)	1998.12-	2003.08			F	Estate Engine EJ25	GC056026	Outer Joint	44T											
<b>LEGACY IV</b>																				
2.0 (101 kW)	2003.10-	2005.07				Saloon Engine EJ20	GC056042	Outer Joint												
	2003.10-	2005.07			F	Saloon Engine EJ20	GDS56013	Drive Shaft												
2.0 (121 kW)	2005.06-					Saloon Engine EJ20	GC056042	Outer Joint												
	2005.06-				F	Saloon Engine EJ20	GDS56013	Drive Shaft												
2.0 (132 kW)	2005.06-					Saloon	GC056042	Outer Joint												
2.0 (140 kW)	2005.06-					Saloon	GC056042	Outer Joint												
2.0 D (110 kW)	2008.02-					Saloon Engine EE20Z	GC056042	Outer Joint												
	2008.02-				F	Saloon Engine EE20Z	GDS56013	Drive Shaft												
2.0 R (110 kW)	2007.09-					Saloon Engine EJ204	GC056042	Outer Joint												



		TRANSM	L/R	F/R		G-AP Ref.	PRODUCT	ABS	Technical Specifications					
									YEAR	A	B	C	H	L
<b>SUBARU</b>														
<b>LEGACY IV</b>														
2.0 R (110 kW)	2007.09-		MT		F	Saloon Engine EJ204	GDS56013	Drive Shaft	27	25	52	77	770	
2.5 (121 kW)	2003.10-	2005.07				Saloon Engine EJ25	GC056042	Outer Joint	27	30	52	76	54	M
	2003.10-	2005.07	MT		F	Saloon Engine EJ25	GDS56013	Drive Shaft	27	25	52	77	770	
2.5 i (127 kW)	2007.09-					Saloon Engine EJ25	GC056042	Outer Joint	27	30	52	76	54	M
	2007.09-				F	Saloon Engine EJ25	GDS56013	Drive Shaft	27	25	52	77	770	
3.0 R (180 kW)	2003.10-	2006.11				Saloon Engine EZ30	GC056042	Outer Joint	27	30	52	76	54	M
	2003.10-	2006.11	MT		F	Saloon Engine EZ30	GDS56013	Drive Shaft	27	25	52	77	770	
<b>LEGACY IV (B13_)</b>														
2.0 AWD (101 kW)	2003.10-	2005.07				Estate Engine EJ20	GC056042	Outer Joint	27	30	52	76	54	M
	2003.10-	2005.07		L/R	F	Estate Engine EJ20	GDS56013	Drive Shaft	27	25	52	77	770	
2.0 AWD (121 kW)	2005.08-	2008.03				Estate Engine EJ20	GC056042	Outer Joint	27	30	52	76	54	M
	2005.08-	2008.03		L/R	F	Estate Engine EJ20	GDS56013	Drive Shaft	27	25	52	77	770	
2.0 AWD (132 kW)	2005.06-					Estate	GC056042	Outer Joint	27	30	52	76	54	M
2.0 AWD (140 kW)	2005.06-					Estate	GC056042	Outer Joint	27	30	52	76	54	M
2.0 D AWD (110 kW)	2008.02-				F	Estate Engine EE20Z	GDS56013	Drive Shaft	27	25	52	77	770	
2.0 R AWD (110 kW)	2007.09-					Estate Engine EJ204	GC056042	Outer Joint	27	30	52	76	54	M
	2007.09-				F	Estate Engine EJ204	GDS56013	Drive Shaft	27	25	52	77	770	
2.5 AWD (121 kW)	2003.09-					Estate Engine EJ25	GC056042	Outer Joint	27	30	52	76	54	M
	2003.09-				F	Estate Engine EJ25	GDS56013	Drive Shaft	27	25	52	77	770	
2.5 i AWD (127 kW)	2008.01-				F	Estate Engine EJ25	GDS56013	Drive Shaft	27	25	52	77	770	
3.0 R AWD (180 kW)	2003.10-	2006.11				Estate Engine EZ30	GC056042	Outer Joint	27	30	52	76	54	M
	2003.10-	2006.11			F	Estate Engine EZ30	GDS56013	Drive Shaft	27	25	52	77	770	
<b>LEGACY V</b>														
2.0 i (110 kW)	2009.09-				F	Estate Engine EJ204	GDS56013	Drive Shaft	27	25	52	77	770	
2.0 i AWD (110 kW)	2009.09-				F	Saloon Engine EJ204	GDS56013	Drive Shaft	27	25	52	77	770	
2.5 i (123 kW)	2009.09-				F	Estate Engine EJ253	GDS56013	Drive Shaft	27	25	52	77	770	
2.5 i AWD (123 kW)	2009.09-				F	Saloon Engine EJ253	GDS56013	Drive Shaft	27	25	52	77	770	
<b>LEONE</b>														
-	1979-	1984				2WD	GC156001	Inner Joint	23	22	40	35.2	69.2	
1.3 (45 kW)	1979.03-	1984.10	MT		F	Estate Engine EA65	GC056011	Outer Joint	30	22	52	137.5	53.5	M
	1979.03-	1984.10	MT		F	Hatchback Engine EA65	GC056011	Outer Joint	30	22	52	137.5	53.5	M
1.6 (63 kW)	1979.03-	1984.10	MT		F	Estate Engine EA71	GC056011	Outer Joint	30	22	52	137.5	53.5	M
	1979.03-	1984.10	MT		F	Hatchback Engine EA71	GC056011	Outer Joint	30	22	52	137.5	53.5	M
1.6 4WD (52 kW)	1979.03-	1984.10	MT		F	Estate Engine EA71	GC056012	Outer Joint	30	23	52	137.5	53.5	M
1.6/1.8	1979.01-	1984.12	MT/AT	L/R		4WD	GDS56020	Drive Shaft	23	23	40	41	502.5	
1.8	1985.01-	1994.12	MT/AT	L/R	F		GDS56001	Drive Shaft	30	23	58	137.5	695	
	1980.09-	1984.10	MT		F	Estate Engine EA81	GC056012	Outer Joint	30	23	52	137.5	53.5	M
1.8 4WD (59 kW)	1980.09-	1984.10	MT		F	Hatchback Engine EA81	GC056012	Outer Joint	30	23	52	137.5	53.5	M
	1980.09-	1984.10	MT		F	Estate Engine EA81	GC056012	Outer Joint	30	23	52	137.5	53.5	M
1.8 Super 4WD (60 kW)	1980.09-	1984.10	MT		F	Hatchback Engine EA81	GC056012	Outer Joint	30	23	52	137.5	53.5	M
1.8 Turismo 4WD (60 kW)	1980.09-	1984.10	MT		F	Hatchback Engine EA81	GC056012	Outer Joint	30	23	52	137.5	53.5	M
<b>LEONE (AB)</b>														
1.3 (45 kW)	1979.03-	1984.10	MT		F	Saloon Engine EA65	GC056011	Outer Joint	30	22	52	137.5	53.5	M
1.6 (63 kW)	1979.03-	1984.10	MT		F	Saloon Engine EA71	GC056011	Outer Joint	30	22	52	137.5	53.5	M
1.8 4WD (59 kW)	1980.09-	1984.10	MT		F	Saloon Engine EA81	GC056012	Outer Joint	30	23	52	137.5	53.5	M
1.8 4WD (60 kW)	1980.09-	1984.10	MT		F	Saloon Engine EA81	GC056012	Outer Joint	30	23	52	137.5	53.5	M
<b>LEONE II</b>														
1.3 (48 kW)	1984.11-	1991.09	MT		F	Saloon Engine EA65	GC056001	Outer Joint	30	22	58	137.5	56	M
1.6 (55 kW)	1984.11-	1991.09	MT		F	Saloon Engine EA71	GC056001	Outer Joint	30	22	58	137.5	56	M
1.8 4WD (66 kW)	1984.11-	1990.12	MT		F	Estate Engine EA82	GC056013	Outer Joint	30	23	58	137.5	56	M
	1984.11-	1990.12	MT		F	Saloon Engine EA82	GC056013	Outer Joint	30	23	58	137.5	56	M
1.8 4WD (72 kW)	1988.01-	1990.12				Saloon Engine EA82	GC056002	Outer Joint	30	25	58	139	57	M
1.8 4WD (88 kW)	1988.01-	1990.12				Saloon Engine EA82	GC056002	Outer Joint	30	25	58	139	57	M
1.8 4WD CAT (70 kW)	1986.07-	1991.09				Saloon Engine EA82	GC056002	Outer Joint	30	25	58	139	57	M
1.8 Super 4WD (96 kW)	1989.03-	1990.12				Estate Engine EA82	GC056002	Outer Joint	30	25	58	139	57	M
1.8 Super 4WD CAT (70 kW)	1986.07-	1992.02				Estate Engine EA82	GC056002	Outer Joint	30	25	58	139	57	M
1.8 Super Turbo 4WD (100 kW)	1984.11-	1990.12				Estate Engine EA82	GC056002	Outer Joint	30	25	58	139	57	M
1.8 Turbo 4WD (100 kW)	1984.11-	1990.12				Saloon Engine EA82	GC056002	Outer Joint	30	25	58	139	57	M
1.8 Turbo 4WD (96 kW)	1989.03-	1990.12				Saloon Engine EA82	GC056002	Outer Joint	30	25	58	139	57	M
<b>LIBERO (E10, E12)</b>														
1.0 4WD (37 kW)	1983.01-	1987.12			F	Bus Engine EF10	GC056007	Outer Joint	24	18	50	85.5	45.5	M
1.2 4WD (38 kW)	1986.08-	2000.02			F	Bus Engine EF12	GC056007	Outer Joint	24	18	50	85.5	45.5	M

	 YEAR	TRANSM	L/R	F/R		G-AP Ref.	PRODUCT	ABS	Technical Specifications							
									A	B	C	H	L	P		
<b>SUBARU</b>																
<b>LIBERO (E10, E12)</b>																
1.2 i 4WD (40 kW)	1991.08-	2000.02			F	Bus Engine EF12	GC056007	Outer Joint		24	18	50	85.5	45.5	M	
<b>LIBERTY</b>																
-	2003-						GCI56013	Inner Joint		25	29	35	77.5	110		
	2003-						GC056022	Outer Joint		27	30	52	77	54	I	
	2003-						GDS56013	Drive Shaft		27	25	52	77	770		
<b>OUTBACK</b>																
-	2000.01-	2002.10	MT/AT	L/R	F		GDS56021	Drive Shaft		27	25	56	86.5	682.5		
<b>OUTBACK (BE, BH)</b>																
2.5 (115 kW)	2000.10-	2003.08			F	Estate Engine EJ25	GC056026	Outer Joint	44T	27	30	56	86.5	63	I	
3.0 H6 (154 kW)	2000.10-	2003.08			F	Estate Engine EZ30	GC056026	Outer Joint	44T	27	30	56	86.5	63	I	
<b>OUTBACK (BL, BP)</b>																
2.0 D (110 kW)	2008.09-	2009.09				Estate	GC056042	Outer Joint		27	30	52	76	54	M	
2.5 (121 kW)	2003.10-	2008.03				Estate Engine EJ25D	GC056042	Outer Joint		27	30	52	76	54	M	
	2003.10-	2008.03	MT		F	Estate Engine EJ25D	GDS56013	Drive Shaft		27	25	52	77	770		
2.5 (127 kW)	2008.09-	2009.09				Estate Engine EJ251	GC056042	Outer Joint		27	30	52	76	54	M	
	2008.09-	2009.09			F	Estate Engine EJ251	GDS56013	Drive Shaft		27	25	52	77	770		
3.0 (180 kW)	2003.10-	2008.03				Estate Engine EZ30	GC056042	Outer Joint		27	30	52	76	54	M	
	2003.10-	2008.03	MT		F	Estate Engine EZ30	GDS56013	Drive Shaft		27	25	52	77	770		
<b>OUTBACK (BM, BR)</b>																
2.0 D (110 kW)	2009.09-					Estate Engine EE20Z	GC056042	Outer Joint		27	30	52	76	54	M	
2.5 i (123 kW)	2009.09-					Estate Engine EJ253	GC056042	Outer Joint		27	30	52	76	54	M	
	2009.09-				F	Estate Engine EJ253	GDS56013	Drive Shaft		27	25	52	77	770		
<b>PICK UP</b>																
1.8	1981-		MT			4WD	GCI56002	Inner Joint		23	23	40	35.2	69.2		
1.8 4WD	1981-		MT	L/R			GDS50172	Drive Shaft		30	23	52	137.5	653		
<b>REX III</b>																
0.5 (28 kW)	1989.06-	1990.07	MT		F	Hatchback Engine EN05	GC056053	Outer Joint		24	18	50	108	49.5	M	
0.5 4WD (28 kW)	1989.06-	1990.07	MT		F	Hatchback Engine EN05	GC056053	Outer Joint		24	18	50	108	49.5	M	
0.5 Kompressor (45 kW)	1989.06-	1990.07	MT		F	Hatchback Engine EN05	GC056053	Outer Joint		24	18	50	108	49.5	M	
	1989.06-	1990.07			F	Hatchback Engine EN05	GC056031	Outer Joint		24	19	50	108	47	M	
0.7 (35 kW)	1990.07-	1992.03	MT		F	Hatchback Engine EN07E	GC056053	Outer Joint		24	18	50	108	49.5	M	
0.7 4WD (35 kW)	1990.07-	1992.03	MT		F	Hatchback Engine EN07E	GC056053	Outer Joint		24	18	50	108	49.5	M	
0.7 Kompressor 4WD (47 kW)	1990.07-	1992.02	MT		F	Hatchback Engine EN07SuperCharger	GC056053	Outer Joint		24	18	50	108	49.5	M	
	1990.07-	1992.02				Hatchback Engine EN07SuperCharger	GC056031	Outer Joint		24	19	50	108	47	M	
0.8 (31 kW)	1989.06-	1992.03	MT		F	Hatchback Engine EN08	GC056053	Outer Joint		24	18	50	108	49.5	M	
<b>SHERPA</b>																
-	1988-	1989			L		GDS56017	Drive Shaft		24	23	50	108	535.5		
<b>SVX</b>																
-	1992-	1996			L/R		GDS56006	Drive Shaft		27	25	56	87	684		
<b>VIVIO</b>																
0.7 (32 kW)	1992.08-	1998.12			F	Hatchback Engine EN07E	GC056007	Outer Joint		24	18	50	85.5	45.5	M	
660 4WD (32 kW)	1992.03-	1995.10			F	Hatchback Engine EN07E	GC056007	Outer Joint		24	18	50	85.5	45.5	M	
<b>XT (XT)</b>																
1.8 Turbo 4WD (100 kW)	1984.11-	1990.12				Coupe Engine EA82	GC056002	Outer Joint		30	25	58	139	57	M	
1.8 Turbo 4WD (88 kW)	1988.01-	1990.12				Coupe Engine EA82	GC056002	Outer Joint		30	25	58	139	57	M	
<b>SUZUKI</b>																
<b>AERIO (INDONESIA) (RH415)</b>																
1.5	2002.10-		MT&AT			Engine E12	GC057041	Outer Joint	42T	25	29	49	76	61	I	
<b>ALTO</b>																
-						WAGON	GCI88018	Inner Joint		22	19	35	51.9	93.4		
<b>ALTO (HA23S/V)</b>																
0.6	2000.12-		AT/MT			Engine K6A	GC057157	Outer Joint		23	18	49	78	56	M	
<b>ALTO (HA25, HA35)</b>																
1.0 (50 kW)	2009.01-		MT	L	F	Hatchback Engine K10B	GDS57211	Drive Shaft	43T	23	22	49	81	662		
	2009.01-		MT	R	F	Hatchback Engine K10B	GDS57124	Drive Shaft	43T	23	22	49	81	819.5		
	2009.01-					Hatchback Engine K10B	GC057112	Outer Joint	43T	23	19	49	81	56.5	I	
<b>ALTO (RF410)</b>																
1.1	2006-	2010					GDS57128	Drive Shaft		23	22	49	77.5	570		
<b>ALTO (SS80)</b>																
0.8 (29 kW)	1982.06-	1985.12			F	Hatchback Engine F8B	GC057006	Outer Joint		23	19	44	89.5	54.5	M	









		TRANSM	L/R	F/R		G-AP Ref.	PRODUCT	ABS	Technical Specifications											
									YEAR	A	B	C	H	L	P					
<b>SUZUKI</b>																				
<b>ALTO / FRONTE / CERVO</b>																				
1	2000-		MT			GC057022	Outer Joint		23	19	49	78	57	M						
<b>ALTO I</b>																				
0.8	1982-1985			L/R	F	GC157003	Inner Joint		22	18	35	37.5	69							
<b>ALTO II (EC)</b>																				
0.8 (29 kW)	1986.01-1993.11				F	Hatchback Engine F8B	GC032001	Outer Joint	23	18	44	89.5	50.5	M						
<b>ALTO III (EF)</b>																				
1.0 (39 kW)	1994.09-2002.06				F	Hatchback Engine G10BB	GC057013	Outer Joint	23	20	49	92	56.5	O						
	1994.09-2002.06				F	Hatchback Engine G10BB	GC057008	Outer Joint	23	20	49	92	54.5	O						
	1994.09-2002.06	MT			F	Hatchback Engine G10BB	GC057007	Outer Joint	23	19	49	92	56.5	M						
	1994.09-2002.06	MT			F	Hatchback Engine G10BB	GC057001	Outer Joint	23	20	49	92	56.5	I						
	1994.09-2002.06	MT			F	Hatchback Engine G10BB	GC057048	Outer Joint	23	20	49	92	54.5	O						
	1994.09-2002.06			L	F	Hatchback Engine G10BB	GDS57078	Drive Shaft	23	22	49	92	590							
	1994.09-2002.06	MT	L	F	F	Hatchback Engine G10BB	GDS32006	Drive Shaft	23	22	49	92	589							
	1994.09-2002.06			L/R	F	Hatchback Engine G10BB	GC057038	Outer Joint	23	20	49	92	56.5	M						
	1994.09-2002.06				R	F	Hatchback Engine G10BB	GDS57077	Drive Shaft	23	22	49	92	823						
	1994.09-2002.06	MT	R	F	F	Hatchback Engine G10BB	GDS88061	Drive Shaft	23	22	49	92	815							
	1994.09-2002.06					Hatchback Engine G10BB	GC099102	Outer Joint	23	19	49	92	56.5	O						
1.0 (43 kW)	2000.01-2002.06				F	Hatchback Engine G10BB	GC057008	Outer Joint	23	20	49	92	54.5	O						
	2000.01-2002.06	AT			F	Hatchback Engine G10BB	GC057013	Outer Joint	23	20	49	92	56.5	O						
	2000.01-2002.06	MT			F	Hatchback Engine G10BB	GC057007	Outer Joint	23	19	49	92	56.5	M						
	2000.01-2002.06	MT			F	Hatchback Engine G10BB	GC057001	Outer Joint	23	20	49	92	56.5	I						
	2000.01-2002.06	MT			F	Hatchback Engine G10BB	GC057048	Outer Joint	23	20	49	92	54.5	O						
	2000.01-2002.06			L	F	Hatchback Engine G10BB	GDS57078	Drive Shaft	23	22	49	92	590							
	2000.01-2002.06	MT	L	F	F	Hatchback Engine G10BB	GDS32006	Drive Shaft	23	22	49	92	589							
	2000.01-2002.06			L/R	F	Hatchback Engine G10BB	GC057038	Outer Joint	23	20	49	92	56.5	M						
	2000.01-2002.06				R	F	Hatchback Engine G10BB	GDS57077	Drive Shaft	23	22	49	92	823						
	2000.01-2002.06	MT	R	F	F	Hatchback Engine G10BB	GDS88061	Drive Shaft	23	22	49	92	815							
	2000.01-2002.06					Hatchback Engine G10BB	GC099102	Outer Joint	23	19	49	92	56.5	O						
<b>ALTO IV (FF)</b>																				
1.1 (46 kW)	2002.06-2008.12				F	Hatchback Engine F10D/F10DN	GC057083	Outer Joint	23	19	49	77.5	57	O						
	2002.06-2008.12				F	Hatchback Engine F10D/F10DN	GC057061	Outer Joint	43T	23	19	49	77.5	57	O					
	2002.06-2008.12	MT	L	F	F	Hatchback Engine F10D/F10DN	GDS57119	Drive Shaft	43T	23	22	49	77.5	567						
	2002.06-2008.12	MT	L	F	F	Hatchback Engine F10D/F10DN	GDS32008	Drive Shaft	23	22	49	78	567							
	2002.06-2008.12	MT	R	F	F	Hatchback Engine F10D/F10DN	GDS57120	Drive Shaft	43T	23	22	49	77.5	800						
	2002.06-2008.12				F	Hatchback Engine F10D/F10DN	GC057027	Outer Joint	23	19	49	78	57	O						
	2002.06-						GC057076	Outer Joint	23	19	49	78	57	O						
<b>ALTO V (GF)</b>																				
1.0 (50 kW)	2002.06-						GC057076	Outer Joint	23	19	49	78	57	O						
<b>BALENO</b>																				
1.3 G13B	1995-		MT			GA11S	GC157002	Inner Joint	22	19	40	57.5	71							
1.8	1999-		MT				GC057029	Outer Joint	25	22	49	77	73	I						
<b>BALENO (EG)</b>																				
1.3 (52 kW)	1996.09-2002.05	MT/AT			F	Hatchback Engine G13BA	GC057037	Outer Joint	25	19	49	76	60.5	I						
	1996.09-2002.05	MT/AT			F	Saloon Engine G13BA	GC057037	Outer Joint	25	19	49	76	60.5	I						
1.3 16V (63 kW)	1997.03-2002.05	MT/AT			F	Estate Engine G13BB	GC057037	Outer Joint	25	19	49	76	60.5	I						
1.3 i 16V (63 kW)	1995.07-2002.05	MT/AT			F	Hatchback Engine G13BB	GC057037	Outer Joint	25	19	49	76	60.5	I						
	1995.07-2002.05	MT/AT			F	Saloon Engine G13B	GC057037	Outer Joint	25	19	49	76	60.5	I						
1.6 i 16V (72 kW)	1995.07-2002.05				F	Hatchback Engine G16B	GC057002	Outer Joint	42T	25	20	49	76.5	61	I					
	1995.07-2002.05				F	Saloon Engine G16B	GC057002	Outer Joint	42T	25	20	49	76.5	61	I					
	1995.07-2002.05	MT/AT			F	Hatchback Engine G16B	GC057014	Outer Joint	25	21	49	76	61	M						
	1995.07-2002.05	MT/AT			F	Hatchback Engine G16B	GC099089	Outer Joint	25	20	49	76	61	M						
	1995.07-2002.05	MT/AT			F	Hatchback Engine G16B	GC057015	Outer Joint	42T	25	21	49	76	61	M					
	1995.07-2002.05	MT/AT			F	Saloon Engine G16B	GC057014	Outer Joint	25	21	49	76	61	M						
	1995.07-2002.05	MT/AT			F	Saloon Engine G16B	GC099089	Outer Joint	25	20	49	76	61	M						
	1995.07-2002.05	MT/AT			F	Saloon Engine G16B	GC057015	Outer Joint	42T	25	21	49	76	61	M					
	1995.07-2002.05					Hatchback Engine G16B	GC057021	Outer Joint	25	20	49	76	63	M						
	1996.08-2002.05					Estate Engine G16B	GC057021	Outer Joint	25	20	49	76	63	M						
	1996.08-2002.05				F	Estate Engine G16B	GC057002	Outer Joint	42T	25	20	49	76.5	61	I					
	1996.08-2002.05	MT/AT			F	Estate Engine G16B	GC057014	Outer Joint	25	21	49	76	61	M						
	1996.08-2002.05	MT/AT			F	Estate Engine G16B	GC099089	Outer Joint	25	20	49	76	61	M						
	1996.08-2002.05	MT/AT			F	Estate Engine G16B	GC057015	Outer Joint	42T	25	21	49	76	61	M					



		TRANSM	L/R	F/R		G-AP Ref.	PRODUCT	ABS	Technical Specifications							
									YEAR	A	B	C	H	L	P	
<b>SUZUKI</b>																
<b>BALENO (EG)</b>																
1.6 i 16V (73 kW)	1996.08-	2002.05			Estate Engine G16B	GC057021	Outer Joint		25	20	49	76	63	M		
1.6 i 16V 4x4 (72 kW)	1995.07-	2002.05		F	Saloon Engine G16B	GC057016	Outer Joint		25	19	49	76.5	61	M		
	1995.07-	2002.05	MT/AT	F	Hatchback Engine G16B	GC057014	Outer Joint		25	21	49	76	61	M		
	1995.07-	2002.05	MT/AT	F	Hatchback Engine G16B	GC099089	Outer Joint		25	20	49	76	61	M		
	1995.07-	2002.05	MT/AT	F	Hatchback Engine G16B	GC057015	Outer Joint	42T	25	21	49	76	61	M		
	1995.07-	2002.05	MT/AT	F	Saloon Engine G16B	GC057014	Outer Joint		25	21	49	76	61	M		
	1995.07-	2002.05	MT/AT	F	Saloon Engine G16B	GC099089	Outer Joint		25	20	49	76	61	M		
	1995.07-	2002.05	MT/AT	F	Saloon Engine G16B	GC057015	Outer Joint	42T	25	21	49	76	61	M		
	1995.07-	2002.05			Hatchback Engine G16B	GC057021	Outer Joint		25	20	49	76	63	M		
	1996.08-	2002.05		F	Estate Engine G16B	GC057016	Outer Joint		25	19	49	76.5	61	M		
	1996.08-	2002.05	MT/AT	F	Estate Engine G16B	GC057014	Outer Joint		25	21	49	76	61	M		
	1996.08-	2002.05	MT/AT	F	Estate Engine G16B	GC099089	Outer Joint		25	20	49	76	61	M		
1.8 GTX (89 kW)	1996.08-	2002.05	MT/AT	F	Estate Engine G16B	GC057015	Outer Joint	42T	25	21	49	76	61	M		
	1996.03-	2002.05			Hatchback Engine J18A	GC057021	Outer Joint		25	20	49	76	63	M		
1.8 GTX (89 kW)	1996.03-	2002.05	MT/AT	F	Hatchback Engine J18A	GC057014	Outer Joint		25	21	49	76	61	M		
	1996.03-	2002.05	MT/AT	F	Saloon Engine J18A	GC057014	Outer Joint		25	21	49	76	61	M		
	1996.03-	2002.05			Hatchback Engine J18A	GC057021	Outer Joint		25	20	49	76	63	M		
1.9 TD (55 kW)	1998.04-	2002.05	5MT	F	Estate	GC019003	Outer Joint		25	29	49	75.5	61	I		
	1998.04-	2002.05	5MT	F	Estate	GC024050	Outer Joint	42T	25	29	49	75.5	61	I		
	1998.04-	2002.05	5MT	F	Hatchback	GC024050	Outer Joint	42T	25	29	49	75.5	61	I		
	1998.04-	2002.05	5MT	F	Hatchback	GC019003	Outer Joint		25	29	49	75.5	61	I		
	1998.04-	2002.05	5MT	F	Saloon	GC024050	Outer Joint	42T	25	29	49	75.5	61	I		
	1998.04-	2002.05	5MT	F	Saloon	GC019003	Outer Joint		25	29	49	75.5	61	I		
<b>BALENO (EG), SW</b>																
1.8 GT (89 kW)	1996.03-	2002.05				GC057014	Outer Joint		25	21	49	76	61	M		
<b>BALENO / CULTUS</b>																
1.3	1995-		MT			GCI88017	Inner Joint		22	19	35	54.4	86			
<b>BALENO NEXTG (INDONESIA) (RM415)</b>																
1.5	2002.10-		MT&AT		Engine E12	GC057041	Outer Joint	42T	25	29	49	76	61	I		
<b>CRESCENT</b>																
1.3	1995-		AT		GA11S G13B	GC057023	Outer Joint		25	21	49	76.5	61	I		
	1995-		AT			GCI57005	Inner Joint		22	21	40	57.5	71			
<b>CULTUS</b>																
1.3						GCI88018	Inner Joint		22	19	35	51.9	93.4			
	1995-		AT		GA11S G13B	GC057023	Outer Joint		25	21	49	76.5	61	I		
	1995-		AT			GCI57005	Inner Joint		22	21	40	57.5	71			
1.3 G13B	1995-		MT		GA11S	GCI57002	Inner Joint		22	19	40	57.5	71			
1.6	1994-	1999	AT			GCI57006	Inner Joint		26	22	40	54	73			
1.8	1999-		MT			GC057029	Outer Joint		25	22	49	77	73	I		
<b>CULTUS BALENO (DG31S)</b>																
1.6 4WD	1996.02-	2002.07	4AT		Engine G16A	GC057159	Outer Joint	42T	25	21	49	76.5	60.5	M		
	1996.02-	2002.07	5MT		Engine G16A	GC057159	Outer Joint	42T	25	21	49	76.5	60.5	M		
<b>CULTUS BALENO (GA11S)</b>																
1.3	1995.01-	2002.07	3AT		Engine G13B	GC057108	Outer Joint		25	19	49	76.5	60.5	M		
	1995.01-	2002.07	5MT		Engine G13B	GC057108	Outer Joint		25	19	49	76.5	60.5	M		
	1995.01-	2002.07	3AT		Engine G13B	GC057160	Outer Joint	42T	25	19	49	76.5	60.5	M		
	1995.01-	2002.07	5MT		Engine G13B	GC057160	Outer Joint	42T	25	19	49	76.5	60.5	M		
	1996.10-	2002.07	CVT		Engine G13B	GC057108	Outer Joint		25	19	49	76.5	60.5	M		
	1996.10-	2002.07	CVT		Engine G13B	GC057160	Outer Joint	42T	25	19	49	76.5	60.5	M		
<b>CULTUS BALENO (GA21S)</b>																
1.5	1995-	2002	4AT		Engine G15A	GC057159	Outer Joint	42T	25	21	49	76.5	60.5	M		
	1995-	2002	5MT		Engine G15A	GC057159	Outer Joint	42T	25	21	49	76.5	60.5	M		
	1995.01-	2002.07	4AT		Engine G15A	GC057152	Outer Joint		25	20	49	76.5	60.5	M		
<b>CULTUS BALENO (GC21S)</b>																
1.5	1995.01-	2002.07	5MT		Engine G15A	GC057160	Outer Joint	42T	25	19	49	76.5	60.5	M		
<b>CULTUS BALENO (GC21W)</b>																
1.5	1996.02-	2002.07	4AT		Engine G15A	GC057152	Outer Joint		25	20	49	76.5	60.5	M		
	1996.02-	2002.07	5MT		Engine G15A	GC057160	Outer Joint	42T	25	19	49	76.5	60.5	M		
<b>CULTUS CRESCENT WAGON (GC41W)</b>																
1.8	1996.02-	2002.07	5MT		Engine J18A	GC057018	Outer Joint		25	22	49	77	73	M		

		YEAR	TRANSM	L/R	F/R		G-AP Ref.	PRODUCT	ABS	Technical Specifications						
										A	B	C	H	L	P	
<b>SUZUKI</b>																
<b>ESCUDO VITARA</b>																
2.7 TX92W 4WD	2000.12-	2005.05	4AT/F			Engine H27A	GC057127	Outer Joint			26	30	48	116	65.5	M
<b>ESCUDO VITARA (TA02)</b>																
1.6	1997.11-		MT/AT			Engine G16A	GC057126	Outer Joint			26	29	48	116	65.5	M
<b>ESCUDO VITARA (TA11W)</b>																
2	1994.12-	1997.11	MT/AT			Engine H20A	GC057126	Outer Joint			26	29	48	116	65.5	M
<b>ESCUDO VITARA (TA31W)</b>																
2	1994.12-	1997.11	4AT			Engine RF TBO	GC057126	Outer Joint			26	29	48	116	65.5	M
<b>ESCUDO VITARA (TA52)</b>																
2	1997.11-		4AT			Engine J20A	GC057126	Outer Joint			26	29	48	116	65.5	M
<b>ESCUDO VITARA (TD02)</b>																
1.6	1997.11-		MT/AT			Engine G16A	GC057126	Outer Joint			26	29	48	116	65.5	M
<b>ESCUDO VITARA (TD11W)</b>																
2	1994.12-	1997.11	MT/AT			Engine H20A	GC057126	Outer Joint			26	29	48	116	65.5	M
<b>ESCUDO VITARA (TD31W)</b>																
2	1994.12-	1997.11	4AT			Engine RF TBO	GC057126	Outer Joint			26	29	48	116	65.5	M
<b>ESCUDO VITARA (TD52)</b>																
2	1997.11-		4AT			Engine J20A	GC057126	Outer Joint			26	29	48	116	65.5	M
<b>ESCUDO VITARA (TD54W)</b>																
2.0 4WD	2005.05-	2008.04	MT/AT			Engine J20A	GC099322	Outer Joint			28	24	58.3	82	63	M
<b>ESCUDO VITARA (TD94W)</b>																
2.7 4WD	2005.05-	2008.04	5AT			Engine H27A	GC099322	Outer Joint			28	24	58.3	82	63	M
<b>ESTEEM</b>																
1.3	1995-		AT			GA11S G13B	GC057023	Outer Joint			25	21	49	76.5	61	I
	1995-		AT				GCI57005	Inner Joint			22	21	40	57.5	71	
<b>GRAND ESCUDO VITARA</b>																
2.7 TX92W 4WD	2000.05-	2005.05	4AT/F			Engine H27A	GC054007	Outer Joint			26	32	48	116	65.5	M
<b>GRAND VITARA / ESCUDO</b>																
-	2006-					JB416/JB420/JB627	GC057067	Outer Joint			28	22	58.2	82	58	I
<b>GRAND VITARA I (FT, GT)</b>																
1.6 (69 kW)	2001.01-	2005.12				Closed Off-Road Vehicle Engine G16B	GC057010	Outer Joint			26	22	48	116	65.5	I
2.0 HDi 16V (80 kW)	2001.07-	2005.09			F	Closed Off-Road Vehicle Engine RHW	GC057009	Outer Joint			26	30	48	116	65.5	I
2.0 TD (64 kW)	1998.03-	2003.07	MT		F	Closed Off-Road Vehicle Engine RF	GC057009	Outer Joint			26	30	48	116	65.5	I
2.5 V6 24V (106 kW)	1998.04-	2003.07	MT		F	Closed Off-Road Vehicle Engine H25A	GC057009	Outer Joint			26	30	48	116	65.5	I
2.5 V6 24V (116 kW)	2004.08-	2005.12	MT		F	Closed Off-Road Vehicle Engine H25A	GC057009	Outer Joint			26	30	48	116	65.5	I
2.7 4x4 (127 kW)	2001.09-	2003.07			F	Closed Off-Road Vehicle Engine H27A	GC057009	Outer Joint			26	30	48	116	65.5	I
<b>GRAND VITARA II (JT)</b>																
1.6 (78 kW)	2005.09-				R	F	Closed Off-Road Vehicle Engine M16A	GDS54014	Drive Shaft		28	26	58.2	82	614	
1.9 DDiS (95 kW)	2005.12-				R	F	Closed Off-Road Vehicle Engine F9QB	GDS54014	Drive Shaft		28	26	58.2	82	614	
2.0 (103 kW)	2005.09-				R	F	Closed Off-Road Vehicle Engine J20A	GDS54014	Drive Shaft		28	26	58.2	82	614	
<b>IGNIS (FH)</b>																
1.3 (60 kW)	2000.10-	2003.09					GC057105	Outer Joint	43T		25	20	49	76	61	M
1.3 (61 kW)	2000.10-	2003.09	MT		F	Closed Off-Road Vehicle Engine M13A	GC057105	Outer Joint	43T		25	20	49	76	61	M
	2000.10-	2003.09	MT		F	Closed Off-Road Vehicle Engine M13A	GC057039	Outer Joint	43T		23	19	49	78	57	M
	2000.10-	2003.09	MT	R	F	Closed Off-Road Vehicle Engine M13A	GDS57121	Drive Shaft	43T		23	22	49	77.5	847	
	2000.10-	2003.09				Closed Off-Road Vehicle Engine M13A	GC057096	Outer Joint	43T		23	20	49	78	60	M
	2000.10-	2003.09					GC057105	Outer Joint	43T		25	20	49	76	61	M
1.3 (66 kW)	2000.10-	2003.09					GC057105	Outer Joint	43T		25	20	49	76	61	M
1.3 4WD (61 kW)	2000.10-	2003.09	5MT		F	Closed Off-Road Vehicle Engine M13A	GC057042	Outer Joint	43T		25	29	49	82	61	I
	2000.10-	2003.09	MT	R	F	Closed Off-Road Vehicle Engine M13A	GDS57121	Drive Shaft	43T		23	22	49	77.5	847	
	2000.10-	2003.09				Closed Off-Road Vehicle Engine M13A	GC057096	Outer Joint	43T		23	20	49	78	60	M
<b>IGNIS I (FH)</b>																
1.3 4WD (60 kW)	2000.10-	2003.09					GC057104	Outer Joint			23	19	49	78	57	M
1.3 4WD (61 kW)	2000.10-	2003.09					GC057104	Outer Joint			23	19	49	78	57	M
1.3 4WD (66 kW)	2000.10-	2003.09					GC057104	Outer Joint			23	19	49	78	57	M
<b>IGNIS II</b>																
1.3 (69 kW)	2003.09-	2005.12			F	Closed Off-Road Vehicle Engine M13A	GC057062	Outer Joint	43T		25	28	49	76	61	I
	2003.09-	2005.12			F	Closed Off-Road Vehicle Engine M13A	GC057081	Outer Joint			25	28	49	76	63	I
	2003.09-	2005.12	MT	L	F	Closed Off-Road Vehicle Engine M13A	GDS99184	Drive Shaft	43T		25	22	49	76	610	
	2003.09-	2005.12				Closed Off-Road Vehicle Engine M13A	GC057097	Outer Joint	43T		25	20	49	75	61	M
1.3 4x4 (69 kW)	2003.09-					Closed Off-Road Vehicle Engine M13A	GC057062	Outer Joint	43T		25	28	49	76	61	I









		YEAR	TRANSM	L/R	F/R		G-AP Ref.	PRODUCT	ABS	Technical Specifications						
										A	B	C	H	L	P	
<b>SUZUKI</b>																
<b>IGNIS II</b>																
1.3 4x4 (69 kW)	2003.09-				F	Closed Off-Road Vehicle Engine M13A	GC057042	Outer Joint	43T	25	29	49	82	61	I	
	2003.09-		MT	L	F	Closed Off-Road Vehicle Engine M13A	GDS99184	Drive Shaft	43T	25	22	49	76	610		
	2003.09-					Closed Off-Road Vehicle Engine M13A	GC057097	Outer Joint	43T	25	20	49	75	61	M	
1.3 DDiS (51 kW)	2003.09-				F	Closed Off-Road Vehicle Engine Z13DT	GC057062	Outer Joint	43T	25	28	49	76	61	I	
	2003.09-				F	Closed Off-Road Vehicle Engine Z13DT	GC057079	Outer Joint	43T	25	29	49	76	63	M	
1.5 (73 kW)	2003.09-	2005.12			F	Closed Off-Road Vehicle Engine M15A	GC057062	Outer Joint	43T	25	28	49	76	61	I	
	2003.09-	2005.12	MT	L	F	Closed Off-Road Vehicle Engine M15A	GDS99184	Drive Shaft	43T	25	22	49	76	610		
1.5 4x4 (73 kW)	2004.04-					Closed Off-Road Vehicle Engine M15A	GC057062	Outer Joint	43T	25	28	49	76	61	I	
	2004.04-				F	Closed Off-Road Vehicle Engine M15A	GC057042	Outer Joint	43T	25	29	49	82	61	I	
<b>IGNIS II (MH)</b>																
1.3 16V (69 kW)	2003.09-						GC057062	Outer Joint	43T	25	28	49	76	61	I	
	2003.09-						GC057103	Outer Joint		25	28	49	82	61	I	
1.3 DDiS (51 kW)	2003.09-						GC057062	Outer Joint	43T	25	28	49	76	61	I	
	2003.09-						GC057103	Outer Joint		25	28	49	82	61	I	
1.5 (73 kW)	2003.09-						GC057062	Outer Joint	43T	25	28	49	76	61	I	
	2003.09-						GC057103	Outer Joint		25	28	49	82	61	I	
1.5 Sport (80 kW)	2003.09-		MT				GC057062	Outer Joint	43T	25	28	49	76	61	I	
	2003.09-		MT				GC057103	Outer Joint		25	28	49	82	61	I	
<b>JIMNY (FJ)</b>																
1.3 16V (60 kW)	2001.02-				R	Closed Off-Road Vehicle Engine M13A	GC059117	Outer Joint		26	19	44	115.5	52	M	
	2001.02-				L/R	R	Closed Off-Road Vehicle Engine M13A	GC099354	Outer Joint		26	29	44	115.5	52	I
1.3 16V 4WD (60 kW)	2001.02-					Closed Off-Road Vehicle Engine M13A	GC059117	Outer Joint		26	19	44	115.5	52	M	
	2001.02-				L/R		Closed Off-Road Vehicle Engine M13A	GC099354	Outer Joint		26	29	44	115.5	52	I
1.3 16V 4x4 (63 kW)	2005.08-					Closed Off-Road Vehicle Engine M13A	GC059117	Outer Joint		26	19	44	115.5	52	M	
	2005.08-					Closed Off-Road Vehicle Engine M13A	GC099354	Outer Joint		26	29	44	115.5	52	I	
	2005.08-				L/R		Closed Off-Road Vehicle Engine M13A	GC099354	Outer Joint		26	29	44	115.5	52	I
1.5 DDiS 4WD (48 kW)	2003.12-			L/R		Closed Off-Road Vehicle Engine K9K700	GC099354	Outer Joint		26	29	44	115.5	52	I	
1.5 DDiS 4x4 (63 kW)	2005.08-			L/R		Closed Off-Road Vehicle Engine K9K266	GC099354	Outer Joint		26	29	44	115.5	52	I	
<b>JIMNY / SIERRA / SAMURAI (JA51)</b>																
1.3	1984.01-	1990.01	MT/AT			Engine G13A	GC057033	Outer Joint		26	22	44.5	136.5	50.5	M	
<b>JIMNY / SIERRA / SAMURAI (JB31W)</b>																
1.3	1993.05-	1995.11	MT/AT			Engine G13B	GC057033	Outer Joint		26	22	44.5	136.5	50.5	M	
<b>KARIMUN</b>																
-							GC057076	Outer Joint		23	19	49	78	57	O	
							GC157034	Inner Joint		22	19	35.4	58	107		
<b>KEI (HN22S)</b>																
0.6	2001.04-		5MT/4AT			Engine K6A	GC057157	Outer Joint		23	18	49	78	56	M	
660	2001.04-		5MT			Engine K6A	GC057125	Outer Joint		23	24	49	78	56	I	
<b>LIANA (ER)</b>																
1.3 (66 kW)	2001.07-	2007.12	5MT		F	Estate Engine M13A	GC024050	Outer Joint	42T	25	29	49	75.5	61	I	
	2001.07-	2007.12	5MT		F	Estate Engine M13A	GC019003	Outer Joint		25	29	49	75.5	61	I	
	2001.07-	2007.12		L/R	F	Estate Engine M13A	GC057041	Outer Joint	42T	25	29	49	76	61	I	
	2002.03-				F	Saloon Engine M13A	GC024050	Outer Joint	42T	25	29	49	75.5	61	I	
	2002.03-				F	Saloon Engine M13A	GC019003	Outer Joint		25	29	49	75.5	61	I	
	2002.03-			L/R	F	Saloon Engine M13A	GC057041	Outer Joint	42T	25	29	49	76	61	I	
1.6 (76 kW)	2001.07-	2007.12	MT/AT		F	Estate Engine M16A	GC024050	Outer Joint	42T	25	29	49	75.5	61	I	
	2001.07-	2007.12	MT/AT		F	Estate Engine M16A	GC019003	Outer Joint		25	29	49	75.5	61	I	
	2001.07-	2007.12		L/R	F	Estate Engine M16A	GC057041	Outer Joint	42T	25	29	49	76	61	I	
	2001.07-	2007.12				Estate Engine M16A	GC057054	Outer Joint	42T	25	29	49	76	61	I	
	2002.03-				F	Saloon Engine M16A	GC024050	Outer Joint	42T	25	29	49	75.5	61	I	
	2002.03-				F	Saloon Engine M16A	GC019003	Outer Joint		25	29	49	75.5	61	I	
	2002.03-			L/R	F	Saloon Engine M16A	GC057041	Outer Joint	42T	25	29	49	76	61	I	
	2002.03-					Saloon Engine M16A	GC057054	Outer Joint	42T	25	29	49	76	61	I	
1.6 (79 kW)	2005.01-				F	Saloon Engine M16A	GC024050	Outer Joint	42T	25	29	49	75.5	61	I	
	2005.01-	2007.12			F	Estate Engine M16A	GC024050	Outer Joint	42T	25	29	49	75.5	61	I	
	2005.01-	2007.12		L/R	F	Estate Engine M16A	GC057041	Outer Joint	42T	25	29	49	76	61	I	
	2005.01-	2007.12				Estate Engine M16A	GC057054	Outer Joint	42T	25	29	49	76	61	I	
	2005.01-			L/R	F	Saloon Engine M16A	GC057041	Outer Joint	42T	25	29	49	76	61	I	
	2005.01-					Saloon Engine M16A	GC057054	Outer Joint	42T	25	29	49	76	61	I	
1.6 4WD (76 kW)	2001.07-	2007.12	MT/AT			Estate Engine M16A	GC019003	Outer Joint		25	29	49	75.5	61	I	
	2001.07-	2007.12	MT/AT		F	Estate Engine M16A	GC024050	Outer Joint	42T	25	29	49	75.5	61	I	



	 YEAR	TRANSM	L/R	F/R		G-AP Ref.	PRODUCT	ABS	Technical Specifications									
									A	B	C	H	L	P				
<b>SUZUKI</b>																		
<b>LIANA (ER)</b>																		
1.6 4WD (76 kW)	2002.03-				Saloon Engine M16A	GC019003	Outer Joint		25	29	49	75.5	61	I				
	2002.03-			F	Saloon Engine M16A	GC024050	Outer Joint	42T	25	29	49	75.5	61	I				
1.6 4WD (78 kW)	2002.04-				Saloon Engine M16A	GC019003	Outer Joint		25	29	49	75.5	61	I				
	2002.04-			F	Saloon Engine M16A	GC024050	Outer Joint	42T	25	29	49	75.5	61	I				
	2002.04-2007.12				Estate Engine M16A	GC019003	Outer Joint		25	29	49	75.5	61	I				
	2002.04-2007.12			F	Estate Engine M16A	GC024050	Outer Joint	42T	25	29	49	75.5	61	I				
1.6 4WD (79 kW)	2005.01-2007.12			F	Estate Engine M16A	GC024050	Outer Joint	42T	25	29	49	75.5	61	I				
	2005.01-2007.12			F	Saloon Engine M16A	GC024050	Outer Joint	42T	25	29	49	75.5	61	I				
1.6 i (78 kW)	2002.04-2007.12			F	Estate Engine M16A	GC024050	Outer Joint	42T	25	29	49	75.5	61	I				
	2002.04-2007.12			F	Estate Engine M16A	GC019003	Outer Joint		25	29	49	75.5	61	I				
	2002.04-2007.12		L/R	F	Estate Engine M16A	GC057041	Outer Joint	42T	25	29	49	76	61	I				
	2002.04-2007.12				Estate Engine M16A	GC057054	Outer Joint	42T	25	29	49	76	61	I				
	2002.08-2007.10			F	Saloon Engine M16A	GC024050	Outer Joint	42T	25	29	49	75.5	61	I				
	2002.08-2007.10			F	Saloon Engine M16A	GC019003	Outer Joint		25	29	49	75.5	61	I				
	2002.08-2007.10		L/R	F	Saloon Engine M16A	GC057041	Outer Joint	42T	25	29	49	76	61	I				
	2002.08-2007.10				Saloon Engine M16A	GC057054	Outer Joint	42T	25	29	49	76	61	I				
<b>MARUTI II</b>																		
1.2	1995-		L/R	F		GCI57003	Inner Joint		22	18	35	37.5	69					
<b>SAMURAI (SJ)</b>																		
1.0 (33 kW)	1988.11-2004.12				Closed Off-Road Vehicle Engine F10A	GC088004	Outer Joint		23	19	44	89	54	M				
	1988.11-2004.12				Closed Off-Road Vehicle Engine F10A	GC057034	Outer Joint		26	19	45	136.5	51.5	M				
	1988.11-2004.12			F	Closed Off-Road Vehicle Engine F10A	GC057020	Outer Joint		26	22	44.5	136.5	50.5	I				
1.3 (44 kW)	1988.11-2004.12				Closed Off-Road Vehicle Engine G13A	GC088004	Outer Joint		23	19	44	89	54	M				
	1988.11-2004.12				Closed Off-Road Vehicle Engine G13A	GC057035	Outer Joint		26	22	48	116.5	65.5	M				
	1988.11-2004.12			F	Closed Off-Road Vehicle Engine G13A	GC057020	Outer Joint		26	22	44.5	136.5	50.5	I				
	1988.11-2004.12	MT		F	Closed Off-Road Vehicle Engine G13A	GC057019	Outer Joint		26	22	47	136	51	M				
1.3 (47 kW)	1988.11-2004.12				Closed Off-Road Vehicle Engine G13A	GC088004	Outer Joint		23	19	44	89	54	M				
	1988.11-2004.12				Closed Off-Road Vehicle Engine G13A	GC057035	Outer Joint		26	22	48	116.5	65.5	M				
	1988.11-2004.12			F	Closed Off-Road Vehicle Engine G13A	GC057020	Outer Joint		26	22	44.5	136.5	50.5	I				
	1988.11-2004.12	MT		F	Closed Off-Road Vehicle Engine G13A	GC057019	Outer Joint		26	22	47	136	51	M				
1.3 (51 kW)	1988.11-2004.12				Closed Off-Road Vehicle Engine G13BA	GC088004	Outer Joint		23	19	44	89	54	M				
	1988.11-2004.12				Closed Off-Road Vehicle Engine G13BA	GC057035	Outer Joint		26	22	48	116.5	65.5	M				
	1988.11-2004.12	MT		F	Closed Off-Road Vehicle Engine G13BA	GC057019	Outer Joint		26	22	47	136	51	M				
1.3 (59 kW)	2000.01-2004.12				Closed Off-Road Vehicle Engine G13BA	GC088004	Outer Joint		23	19	44	89	54	M				
1.9 TD (46 kW)	1998.11-2004.12				Closed Off-Road Vehicle Engine XUD9	GC088004	Outer Joint		23	19	44	89	54	M				
	1998.11-2004.12				Closed Off-Road Vehicle Engine XUD9	GC057035	Outer Joint		26	22	48	116.5	65.5	M				
1.9 TD (47 kW)	1998.11-2004.12				Closed Off-Road Vehicle	GC088004	Outer Joint		23	19	44	89	54	M				
<b>SPLASH</b>																		
1.0 (48 kW)	2008.01-		MT	L	F	Hatchback Engine K10B	GDS57222	Drive Shaft	25	22	49	81.5	641					
	2008.01-		MT	L/R	F	Hatchback Engine K10B	GC044085	Outer Joint	25	20	49	81.5	61	M				
	2008.01-		MT	R	F	Hatchback Engine K10B	GDS57221	Drive Shaft	25	22	49	81.5	882					
	2008.01-						GC044085	Outer Joint	25	20	49	81.5	61	M				
1.0 (50 kW)	2011.06-		MT	L	F	Hatchback Engine K10B	GDS57175	Drive Shaft	25	22	49	82	635					
1.2 (63 kW)	2008.01-		MT	L	F	Hatchback Engine K12B	GDS57222	Drive Shaft	25	22	49	81.5	641					
	2008.01-		MT	L/R	F	Hatchback Engine K12B	GC044085	Outer Joint	25	20	49	81.5	61	M				
	2008.01-		MT	R	F	Hatchback Engine K12B	GDS57221	Drive Shaft	25	22	49	81.5	882					
	2008.01-						GC044085	Outer Joint	25	20	49	81.5	61	M				
1.2 VVT (66 kW)	2011.06-		MT	L	F	Hatchback Engine K12B	GDS57175	Drive Shaft	25	22	49	82	635					
1.2 VVT (67 kW)	2012.08-		MT	L	F	Hatchback Engine K12B	GDS57175	Drive Shaft	25	22	49	82	635					
1.2 VVT (69 kW)	2010.09-		MT	L	F	Hatchback Engine K12B	GDS57222	Drive Shaft	25	22	49	81.5	641					
	2010.09-		MT	L/R	F	Hatchback Engine K12B	GC044085	Outer Joint	25	20	49	81.5	61	M				
	2010.09-		MT	R	F	Hatchback Engine K12B	GDS57221	Drive Shaft	25	22	49	81.5	882					
1.3 CDTi (55 kW)	2008.01-				F	Hatchback Engine D13A/Z13DTJ	GC057100	Outer Joint	25	21	49	82.5	64	M				
	2008.01-		MT	L	F	Hatchback Engine D13A/Z13DTJ	GDS57210	Drive Shaft	25	26	49	81.5	630					
	2008.01-		MT	R	F	Hatchback Engine D13A/Z13DTJ	GDS57197	Drive Shaft	25	22	49	81.5	614					
<b>SPRINT FIREFLY</b>																		
-					ALGERIA	GCI88018	Inner Joint		22	19	35	51.9	93.4					
<b>SWIFT</b>																		
-	1989.01-2000.07	AT	L			GDS57009	Drive Shaft		23	22	49	92	565					
	1989.01-2000.07	AT	R			GDS57010	Drive Shaft		23	22	49	92	555					
1.3	1984.01-1986.12				4 Cyl	GCI57009	Inner Joint		22	19	40	57.5	70					

		YEAR	TRANSM	L/R	F/R		G-AP Ref.	PRODUCT	ABS	Technical Specifications						
										A	B	C	H	L	P	
<b>SUZUKI</b>																
<b>SWIFT</b>																
1.3	1984.01-	1986.12	MT/AT	L		4 Cyl	GDS57007	Drive Shaft		23	22	44	89.5	585		
	1984.01-	1986.12	MT/AT	R		4 Cyl	GDS57008	Drive Shaft		23	22	44	89.5	567		
	1986.01-	1988.12	MT			4 Cyl	GCI57009	Inner Joint		22	19	40	57.5	70		
	1986.01-	1988.12	MT	L		4 Cyl	GDS57007	Drive Shaft		23	22	44	89.5	585		
	1986.01-	1988.12	MT	R		4 Cyl	GDS57008	Drive Shaft		23	22	44	89.5	567		
	1995-	2000					GC057043	Outer Joint	42T	23	19	46	92	56.5	I	
	1995-	2000					GC088018	Outer Joint		23	19	46	92	56.5	I	
RS 415	2006-						GCI57024	Inner Joint		22	28	38	59.5	85		
	2006-			R			GDS99080	Drive Shaft	43T	25	22	49	82	641.5		
<b>SWIFT (AA)</b>																
1.0 Turbo (52 kW)	1985.02-	1989.12			F	Hatchback Engine G10T	GC057006	Outer Joint		23	19	44	89.5	54.5	M	
1.3 (47 kW)	1986.08-	1989.03			F	Hatchback Engine G13A	GC057006	Outer Joint		23	19	44	89.5	54.5	M	
1.3 (54 kW)	1984.10-	1989.03			F	Hatchback Engine G13A	GC057006	Outer Joint		23	19	44	89.5	54.5	M	
<b>SWIFT (ZC11S)</b>																
1.3	2004.11-		4AT/F			Engine M13A	GC057042	Outer Joint	43T	25	29	49	82	61	I	
	2004.11-		5MT/F			Engine M13A	GC057042	Outer Joint	43T	25	29	49	82	61	I	
1.5	2004.11-		4AT/F			Engine M15A	GC057042	Outer Joint	43T	25	29	49	82	61	I	
<b>SWIFT (ZD11S)</b>																
1.3 4WD	2004.11-		4AT/F			Engine M13A	GC057042	Outer Joint	43T	25	29	49	82	61	I	
	2004.11-		5MT/F			Engine M13A	GC057042	Outer Joint	43T	25	29	49	82	61	I	
<b>SWIFT (ZD21S)</b>																
1.5 4WD	2004.11-		4AT/F			Engine M15A	GC057042	Outer Joint	43T	25	29	49	82	61	I	
<b>SWIFT II (AH, AJ)</b>																
1.3 (50 kW)	1989.03-	2001.05	MT		F	Saloon Engine G13A	GCI99099	Inner Joint		22	19	35	51.5	86.5		
1.3 (52 kW)	1989.03-	1991.12			F	Saloon Engine G13A	GC057006	Outer Joint		23	19	44	89.5	54.5	M	
1.6 (70 kW)	1989.11-	1991.12	MT/AT		F	Saloon Engine G16B	GC057011	Outer Joint		25	22	49	76.5	73	M	
	1989.11-	1991.12	MT/AT		F	Saloon Engine G16B	GC057003	Outer Joint		23	22	49	92	67	M	
1.6 4WD (70 kW)	1989.11-	1991.12	MT/AT		F	Saloon Engine G16B	GC057011	Outer Joint		25	22	49	76.5	73	M	
	1989.11-	1991.12	MT/AT		F	Saloon Engine G16B	GC057003	Outer Joint		23	22	49	92	67	M	
1.6 i (68 kW)	1990.01-	2001.05	MT/AT		F	Saloon Engine G16B	GC057011	Outer Joint		25	22	49	76.5	73	M	
	1990.01-	2001.05	MT/AT		F	Saloon Engine G16B	GC057003	Outer Joint		23	22	49	92	67	M	
1.6 i 4WD (68 kW)	1990.01-	2001.05	MT/AT		F	Saloon Engine G16B	GC057011	Outer Joint		25	22	49	76.5	73	M	
	1990.01-	2001.05	MT/AT		F	Saloon Engine G16B	GC057003	Outer Joint		23	22	49	92	67	M	
<b>SWIFT II (EA, MA)</b>																
1.0 (37 kW)	1989.03-	2001.05	MT		F	Hatchback Engine G10A	GC057012	Outer Joint		23	20	49	92	56.5	I	
	1989.03-	2001.05	MT/AT		F	Hatchback Engine G10A	GCI99099	Inner Joint		22	19	35	51.5	86.5		
1.0 i (39 kW)	1991.09-	2001.05	MT	L	F	Hatchback Engine G10A	GDS99096	Drive Shaft		23	22	49	92	678		
	1991.09-	2001.05		L/R	F	Hatchback Engine G10A	GC057038	Outer Joint		23	20	49	92	56.5	M	
	1991.09-	2001.05	MT	R	F	Hatchback Engine G10A	GDS99097	Drive Shaft		23	22	49	92	770		
	1991.09-	2001.05	MT/AT		F	Hatchback Engine G10A	GCI99099	Inner Joint		22	19	35	51.5	86.5		
1.0 i (40 kW)	1989.03-	1991.12			F	Hatchback Engine G10A	GC057012	Outer Joint		23	20	49	92	56.5	I	
	1989.03-	1991.12	MT/AT		F	Hatchback Engine G10A	GCI99099	Inner Joint		22	19	35	51.5	86.5		
1.3 (50 kW)	1989.03-	2001.05		L/R	F	Hatchback Engine G13A	GC057038	Outer Joint		23	20	49	92	56.5	M	
	1989.03-	2001.05	MT		F	Hatchback Engine G13A	GCI99099	Inner Joint		22	19	35	51.5	86.5		
1.3 (52 kW)	1989.03-	1991.12			F	Hatchback Engine G13A	GC057006	Outer Joint		23	19	44	89.5	54.5	M	
1.3 4WD (52 kW)	1989.10-	1991.12				Hatchback Engine G13A	GC057006	Outer Joint		23	19	44	89.5	54.5	M	
1.3 GTi (74 kW)	1989.03-	2001.05	AT		F	Hatchback Engine G13B	GC057011	Outer Joint		25	22	49	76.5	73	M	
	1989.03-	2001.05	AT		F	Hatchback Engine G13B	GCI99099	Inner Joint		22	19	35	51.5	86.5		
<b>SWIFT III</b>																
1.0 (39-43 kW)	1996.10-		MT	L		Engine G10, Hungarian Production	GDS57040	Drive Shaft		23	22	49	92	678		
	1996.10-		MT	R		Engine G10, Hungarian Production	GDS57039	Drive Shaft		23	22	49	92	767		
<b>SWIFT III (MZ, EZ)</b>																
1.3 (68 kW)	2005.02-				F	Hatchback Engine M13A	GC057042	Outer Joint	43T	25	29	49	82	61	I	
	2005.02-			L	F	Hatchback Engine M13A	GDS57166	Drive Shaft		25	22	49	82	651		
	2005.02-			L	F	Hatchback Engine M13A	GDS57168	Drive Shaft		25	22	49	82	630		
	2005.02-			R	F	Hatchback Engine M13A	GDS57167	Drive Shaft		25	22	49	82	895		
	2005.02-			R	F	Hatchback Engine M13A	GDS57169	Drive Shaft		25	22	49	82	641.5		
	2005.02-		MT	L	F	Hatchback Engine M13A	GDS57086	Drive Shaft	43T	25	22	49	82	652		
1.3 4x4 (66 kW)	2006.01-			L		Hatchback Engine M13A	GDS57166	Drive Shaft		25	22	49	82	651		
	2006.01-			L		Hatchback Engine M13A	GDS57168	Drive Shaft		25	22	49	82	630		
	2006.01-			R		Hatchback Engine M13A	GDS57167	Drive Shaft		25	22	49	82	895		









		TRANSM	L/R	F/R		G-AP Ref.	PRODUCT	ABS	Technical Specifications						
									YEAR	A	B	C	H	L	P
<b>SUZUKI</b>															
<b>SWIFT III (MZ, EZ)</b>															
1.3 4x4 (66 kW)	2006.01-			R	Hatchback Engine M13A	GDS57169	Drive Shaft		25	22	49	82	641.5		
	2006.01-			F	Hatchback Engine M13A	GC057042	Outer Joint	43T	25	29	49	82	61	I	
1.3 DDiS (51 kW)	2005.08-			F	Hatchback Engine Z13DT	GC057042	Outer Joint	43T	25	29	49	82	61	I	
	2005.08-			R	F	Hatchback Engine Z13DT	GDS50470	Drive Shaft	43T	25	23	49	82	631	
	2005.08-		MT	L	F	Hatchback Engine Z13DT	GDS57210	Drive Shaft		25	26	49	81.5	630	
1.3 DDiS (55 kW)	2005.08-			F	Hatchback Engine D13A/Z13DTJ	GC057042	Outer Joint	43T	25	29	49	82	61	I	
	2005.08-			R	F	Hatchback Engine D13A/Z13DTJ	GDS50470	Drive Shaft	43T	25	23	49	82	631	
	2005.08-		MT	L	F	Hatchback Engine D13A/Z13DTJ	GDS57210	Drive Shaft		25	26	49	81.5	630	
1.5 (75 kW)	2005.02-			F	Hatchback Engine M15A	GC057042	Outer Joint	43T	25	29	49	82	61	I	
	2005.02-			F	Hatchback Engine M15A	GC057095	Outer Joint	43T	25	29	49	82.5	57	M	
	2005.02-			R	F	Hatchback Engine M15A	GDS57169	Drive Shaft		25	22	49	82	641.5	
1.6 (92 kW)	2006.10-			F	Hatchback Engine M16A	GC057092	Outer Joint		28	29	58	86.5	63	I	
	2006.10-			L/R	F	Hatchback Engine M16A	GC057117	Outer Joint		28	29	58	85	62	I
<b>SX4 (GY)</b>															
1.5 (73 kW)	2006.06-			F	Hatchback Engine M15A	GC057092	Outer Joint		28	29	58	86.5	63	I	
	2006.06-				Hatchback Engine M15A	GC057078	Outer Joint		28	29	58	85	62	I	
1.5 VVT (82 kW)	2010.07-				Hatchback Engine M15A	GC057078	Outer Joint		28	29	58	85	62	I	
1.6 (79 kW)	2007.10-				Saloon Engine M16A	GC057078	Outer Joint		28	29	58	85	62	I	
1.6 (88 kW)	2007.10-				Saloon Engine M16A	GC057078	Outer Joint		28	29	58	85	62	I	
1.6 VVT (79 kW)	2006.06-				Hatchback Engine M16A	GC057078	Outer Joint		28	29	58	85	62	I	
1.6 VVT (88 kW)	2009.07-		MT/AT		Hatchback Engine M16A	GC057078	Outer Joint		28	29	58	85	62	I	
1.6 VVT 4x4 (79 kW)	2006.10-				Hatchback Engine M16A	GC057078	Outer Joint		28	29	58	85	62	I	
1.6 VVT 4x4 (82 kW)	2009.07-		MT/AT		Hatchback Engine M16A	GC057078	Outer Joint		28	29	58	85	62	I	
1.6 VVT 4x4 (88 kW)	2009.07-				Hatchback Engine M16A	GC057078	Outer Joint		28	29	58	85	62	I	
<b>SX4 (YA11)</b>															
1.5	2006.05-		4AT		Engine M15A	GC057149	Outer Joint		28	29	58	85	62.5	I	
<b>SX4 (YA41)</b>															
2	2006.05-		4AT		Engine J20A	GC057141	Outer Joint		28	30	58	85	62.5	M	
<b>SX4 (YA41) 4WD</b>															
2	2006.05-		4AT		Engine J20A	GC057141	Outer Joint		28	30	58	85	62.5	M	
<b>SX4 (YB11)</b>															
1.5 4WD	2006.05-		4AT		Engine M15A	GC057149	Outer Joint		28	29	58	85	62.5	I	
<b>TUTTO</b>															
-						GCI88018	Inner Joint		22	19	35	51.9	93.4		
<b>VITARA (ET, TA)</b>															
1.9 D (50 kW)	1995.01-	1998.03	MT		F	Closed Off-Road Vehicle Engine XUD9A	GC057017	Outer Joint		26	29	48	116	65.5	I
1.9 D (55 kW)	1996.08-	1998.03	MT		F	Closed Off-Road Vehicle Engine XUD9SD	GC057017	Outer Joint		26	29	48	116	65.5	I
2.0 16V (97 kW)	1996.12-	1998.03	MT		F	Closed Off-Road Vehicle Engine J20A	GC057017	Outer Joint		26	29	48	116	65.5	I
2.0 TD (52 kW)	1994.12-	1998.03	MT		F	Closed Off-Road Vehicle Engine RF	GC057017	Outer Joint		26	29	48	116	65.5	I
2.0 TD Intercooler (64 kW)	1995.12-	1998.03	MT		F	Closed Off-Road Vehicle Engine RF	GC057017	Outer Joint		26	29	48	116	65.5	I
2.0 V6 24V (100 kW)	1994.12-	1998.03	MT		F	Closed Off-Road Vehicle Engine H20A	GC057017	Outer Joint		26	29	48	116	65.5	I
2.5 V6 24V (118 kW)	1995.12-	1998.03	MT		F	Closed Off-Road Vehicle Engine H25A	GC057017	Outer Joint		26	29	48	116	65.5	I
<b>VITARA CABRIO (ET, TA)</b>															
1.9 D (55 kW)	1996.08-	1999.03	MT		F	Open Off-Road Vehicle Engine XUD9SD	GC057017	Outer Joint		26	29	48	116	65.5	I
2.0 16V (97 kW)	1996.12-	1999.03	MT		F	Open Off-Road Vehicle Engine J20A	GC057017	Outer Joint		26	29	48	116	65.5	I
<b>WAGON R</b>															
-				L	MC11	GDS57068	Drive Shaft	43T	23	22	49	77.5	548		
	NULL-			L	MC11/MC12	GC057031	Outer Joint		23	19	49	78	57	I	
<b>WAGON R+ (EM)</b>															
1.0 (48 kW)	1998.02-	2000.05	MT		F	MPV Engine K10A	GC057086	Outer Joint		23	19	44	89.6	50.7	M
	1998.02-	2000.05			F	MPV Engine K10A	GC057024	Outer Joint		23	19	49	78	57	M
1.2 (51 kW)	1998.02-	2000.05			F	MPV Engine K12A	GC057006	Outer Joint		23	19	44	89.5	54.5	M
<b>WAGON R+ (MM)</b>															
1.3 (56 kW)	2000.05-	2004.12	MT	L	F	MPV Engine G13BB	GDS57066	Drive Shaft	43T	23	22	49	78	593	
1.3 (69 kW)	2003.10-	2005.12	MT	L	F	MPV Engine M13A	GDS57066	Drive Shaft	43T	23	22	49	78	593	
1.3 4WD (56 kW)	2001.10-		5MT			MPV Engine G13BB	GC044001	Outer Joint	43T	23	20	49	78	61	M
	2001.10-				F	MPV Engine G13BB	GC056010	Outer Joint	41T	23	19	49	78	57	M
1.3 4WD (69 kW)	2003.09-					MPV Engine M13A	GC044001	Outer Joint	43T	23	20	49	78	61	M
1.3 DDiS (51 kW)	2003.09-		MT	L	F	MPV Engine Z13DT	GDS57066	Drive Shaft	43T	23	22	49	78	593	
<b>WAGON R+ I (EM)</b>															
1.2 (51 kW)	1998.02-	2000.05	MT		F		GC057104	Outer Joint		23	19	49	78	57	M



		YEAR	TRANSM	L/R	F/R		G-AP Ref.	PRODUCT	ABS	Technical Specifications						
										A	B	C	H	L	P	
<b>SUZUKI</b>																
<b>WAGON R+ II (MM)</b>																
1.3 16V 4WD (56 kW)	2000.05-						GC044001	Outer Joint	43T	23	20	49	78	61	M	
	2003.09-		MT				GC044001	Outer Joint	43T	23	20	49	78	61	M	
1.3 16V 4WD (59 kW)	2000.05-						GC044001	Outer Joint	43T	23	20	49	78	61	M	
	2003.09-		MT				GC044001	Outer Joint	43T	23	20	49	78	61	M	
<b>WAGON-R (MC22S)</b>																
0.6	2000.12-		MT			Engine K6A	GC057157	Outer Joint		23	18	49	78	56	M	
<b>TATA</b>																
<b>INDICA</b>																
1.4 CRDi	2005-			L/R	F		GC057088	Outer Joint	42T	25	28	52.1	95	59.5	O	
<b>INDIGO</b>																
1.4 CRDi	2006-			L/R	F		GC057088	Outer Joint	42T	25	28	52.1	95	59.5	O	
<b>TOYOTA</b>																
<b>4 RUNNER</b>																
-	1986-	1995					GCI59014	Inner Joint			24		83.3			
	1996-	2002					GC059072	Outer Joint		30	34	69	123	66.5	I	
<b>4 RUNNER (KZN18_, VZN18_, RZN18_)</b>																
3.0 Turbo-D (92 kW)	1995.11-	2002.11			F	Closed Off-Road Vehicle Engine 1KZ-T	GC059015	Outer Joint		26	27	60	162	65.5	I	
<b>ALLION (AZT240)</b>																
2	2001-		CVT			Engine 1AZ-FSE	GC059294	Outer Joint	48T	26	27	63	97	60	M	
<b>ALPHARD (ANH10W)</b>																
2.4	2002.05-		4AT/I			Engine 2AZ-FE	GC059175	Outer Joint	48T	26	27	63.3	100	59	M	
<b>ALPHARD (ANH15W)</b>																
2.4 4WD	2002.05-		4AT/I			Engine 2AZ-FE	GC059175	Outer Joint	48T	26	27	63.3	100	59	M	
<b>ALPHARD (ANH20,GGH20)</b>																
-	2008-						GC059245	Outer Joint		26	27	61.2	100	59	I	
<b>ALPHARD (ATH1_, MNH1_, ANH1_)</b>																
2.4 (117 kW)	2003.09-	2008.04		L	F	MPV Engine 2AZ-FE	GCI59073	Inner Joint		24	27	50	67	110		
	2003.09-	2008.04		R	F	MPV Engine 2AZ-FE	GCI59078	Inner Joint		24	27	40	370	105		
2.4 HybriD 4WD (117 kW)	2003.09-	2008.04		L	F	MPV Engine 2AZ-FXE	GCI59073	Inner Joint		24	27	50	67	110		
	2003.09-	2008.04		R	F	MPV Engine 2AZ-FXE	GCI59078	Inner Joint		24	27	40	370	105		
3.0 (162 kW)	2003.04-	2008.04			F	MPV Engine 1MZ-FE	GC059431	Outer Joint	48T	30	27	61.2	100	64.5	M	
<b>ALPHARD (MNH10W)</b>																
3	2002.05-		4AT/I			Engine 1MZ-FE	GC059154	Outer Joint	48T	30	27	63.4	100	64.5	M	
<b>ALPHARD (MNH15W)</b>																
3.0 4WD	2002.05-		4AT/I			Engine 1MZ-FE	GC059175	Outer Joint	48T	26	27	63.3	100	59	M	
<b>ALPHARD (NH10W)</b>																
2.4	2002.05-		4AT/I			Engine 2AZ-FE	GC059175	Outer Joint	48T	26	27	63.3	100	59	M	
3	2002.05-		4AT/I			Engine 1MZ-FE	GC059154	Outer Joint	48T	30	27	63.4	100	64.5	M	
<b>ALPHARD (NH15W)</b>																
2.4 4WD	2002.05-		4AT/I			Engine 2AZ-FE	GC059175	Outer Joint	48T	26	27	63.3	100	59	M	
3.0 4WD	2002.05-		4AT/I			Engine 1MZ-FE	GC059175	Outer Joint	48T	26	27	63.3	100	59	M	
<b>ALPHARD / VELLFIRE (ANH20,GGH20)</b>																
-	2008-						GC059245	Outer Joint		26	27	61.2	100	59	I	
<b>ALPHARD / VELLFIRE (ANH25,GGH25)</b>																
-4WD	2008-						GC059245	Outer Joint		26	27	61.2	100	59	I	
<b>ALPHARD / VELLFIRE (GGH2_, ANH2_, ATH2_)</b>																
2.4 (123 kW)	2008.04-	2014.12		L	F	MPV Engine 2AZ-FE	GCI59073	Inner Joint		24	27	50	67	110		
	2008.04-	2014.12		R	F	MPV Engine 2AZ-FE	GCI59078	Inner Joint		24	27	40	370	105		
2.4 (125 kW)	2008.04-	2014.12		L	F	MPV Engine 2AZ-FE	GCI59073	Inner Joint		24	27	50	67	110		
	2008.04-	2014.12		R	F	MPV Engine 2AZ-FE	GCI59078	Inner Joint		24	27	40	370	105		
2.4 4WD (125 kW)	2008.04	2014.12		L	F	MPV Engine 2AZ-FE	GCI59073	Inner Joint		24	27	50	67	110		
3.5 (202 kW)	2008.04-	2014.12		L	F	MPV Engine 2GR-FE	GCI59073	Inner Joint		24	27	50	67	110		
3.5 (206 kW)	2008.04-	2014.12		L	F	MPV Engine 2GR-FE	GCI59073	Inner Joint		24	27	50	67	110		
3.5 4WD (206 kW)	2008.04	2014.12		L	F	MPV Engine 2GR-FE	GCI59073	Inner Joint		24	27	50	67	110		
<b>ALTEZZA GITA (GXE15, JCE15)</b>																
- 4WD	1998-	2005					GC059370	Outer Joint	48T	30	30	56	92	59	I	
<b>AURIS (22E15)</b>																
1.3 VVTi (74 kW)	2009.05-						GC059213	Outer Joint		26	23	61.2	95.5	54.5	I	
1.4 D-4D (66 kW)	2007.03-						GC059213	Outer Joint		26	23	61.2	95.5	54.5	I	

		TRANSM	L/R	F/R		G-AP Ref.	PRODUCT	ABS	Technical Specifications														
									YEAR	A	B	C	H	L	P								
<b>TOYOTA</b>																							
<b>AURIS (2ZE15)</b>																							
1.4 VVTi (71 kW)	2007.03-					GC059213	Outer Joint		26	23	61.2	95.5	54.5	I									
1.6 (97 kW)	2009.05-					GC059213	Outer Joint		26	23	61.2	95.5	54.5	I									
1.6 VVTi (91 kW)	2007.03-					GC059213	Outer Joint		26	23	61.2	95.5	54.5	I									
<b>AURIS (NRE15_, ZZE15_, ADE15_, ZRE15_, NDE15_)</b>																							
1.33 Dual-VVTi (73 kW)	2010.01-				F	Hatchback Engine 1NR-FE	GC059028	Outer Joint	48T	26	22	56	99	61	M								
	2010.01-				L	F	Hatchback Engine 1NR-FE	GDS59316	Drive Shaft		26	23	61.2	95.5	662								
	2010.01-				R	F	Hatchback Engine 1NR-FE	GDS59317	Drive Shaft		26	23	61.2	95.5	941								
	2010.01-				L/R	F	Hatchback Engine 1NR-FE	GC059213	Outer Joint		26	23	61.2	95.5	54.5	I							
	2010.01-					F	Hatchback Engine 1NR-FE	GCI99038	Inner Joint		23	23	34	60	113								
1.33 Dual-VVTi (74 kW)	2009.05-				F	Hatchback Engine 1NR-FE	GC059028	Outer Joint	48T	26	22	56	99	61	M								
	2009.05-		MT	L	F	Hatchback Engine 1NR-FE	GDS59316	Drive Shaft		26	23	61.2	95.5	662									
	2009.05-		MT	R	F	Hatchback Engine 1NR-FE	GDS59317	Drive Shaft		26	23	61.2	95.5	941									
	2009.05-			L/R	F	Hatchback Engine 1NR-FE	GC059213	Outer Joint		26	23	61.2	95.5	54.5	I								
	2009.05-				F	Hatchback Engine 1NR-FE	GCI99038	Inner Joint		23	23	34	60	113									
1.4 D-4D (66 kW)	2007.02-		MT	L	F	Hatchback Engine 1ND-TV	GDS59268	Drive Shaft		26	20	61.2	95.5	665									
	2007.02-		MT	R	F	Hatchback Engine 1ND-TV	GDS59447	Drive Shaft		26	20	61.2	95.5	943									
	2007.02-			L/R	F	Hatchback Engine 1ND-TV	GC059213	Outer Joint		26	23	61.2	95.5	54.5	I								
1.4 VVT-i (71 kW)	2007.02-		MT	L	F	Hatchback Engine 4ZZ-FE	GDS59316	Drive Shaft		26	23	61.2	95.5	662									
	2007.02-		MT	R	F	Hatchback Engine 4ZZ-FE	GDS59317	Drive Shaft		26	23	61.2	95.5	941									
	2007.02-			L/R	F	Hatchback Engine 4ZZ-FE	GC059213	Outer Joint		26	23	61.2	95.5	54.5	I								
	2007.02-				F	Hatchback Engine 4ZZ-FE	GCI99038	Inner Joint		23	23	34	60	113									
1.6 (97 kW)	2009.05-			L	F	Hatchback Engine 1ZR-FAE	GDS59268	Drive Shaft		26	20	61.2	95.5	665									
	2009.05-		MT	L	F	Hatchback Engine 1ZR-FAE	GDS59316	Drive Shaft		26	23	61.2	95.5	662									
	2009.05-			R	F	Hatchback Engine 1ZR-FAE	GDS59447	Drive Shaft		26	20	61.2	95.5	943									
	2009.05-		MT	R	F	Hatchback Engine 1ZR-FAE	GDS59317	Drive Shaft		26	23	61.2	95.5	941									
	2009.05-			L/R	F	Hatchback Engine 1ZR-FAE	GC059213	Outer Joint		26	23	61.2	95.5	54.5	I								
1.6 VVT-i (91 kW)	2007.02-			L	F	Hatchback Engine 1ZR-FE	GDS59268	Drive Shaft		26	20	61.2	95.5	665									
	2007.02-		MT	L	F	Hatchback Engine 1ZR-FE	GDS59316	Drive Shaft		26	23	61.2	95.5	662									
	2007.02-			R	F	Hatchback Engine 1ZR-FE	GDS59447	Drive Shaft		26	20	61.2	95.5	943									
	2007.02-		MT	R	F	Hatchback Engine 1ZR-FE	GDS59317	Drive Shaft		26	23	61.2	95.5	941									
	2007.02-			L/R	F	Hatchback Engine 1ZR-FE	GC059213	Outer Joint		26	23	61.2	95.5	54.5	I								
	2007.02-				F	Hatchback Engine 1ZR-FE	GCI99038	Inner Joint		23	23	34	60	113									
1.8 (106 kW)	2009.02-					Hatchback Engine 2ZR-FAE	GCI59100	Inner Joint		20	25	35	63.5	118									
1.8 (108 kW)	2009.02-			L	F	Hatchback Engine 2ZR-FAE	GDS59268	Drive Shaft		26	20	61.2	95.5	665									
	2009.02-			R	F	Hatchback Engine 2ZR-FAE	GDS59447	Drive Shaft		26	20	61.2	95.5	943									
	2009.02-			L/R	F	Hatchback Engine 2ZR-FAE	GC059213	Outer Joint		26	23	61.2	95.5	54.5	I								
	2009.02-					Hatchback Engine 2ZR-FAE	GCI59100	Inner Joint		20	25	35	63.5	118									
1.8 4WD (100 kW)	2009.02-					Hatchback Engine 2ZR-FAE	GCI59100	Inner Joint		20	25	35	63.5	118									
2.0 D-4D (93 kW)	2007.02-			L/R	F	Hatchback Engine 1AD-FTV	GC059318	Outer Joint		30	36	61.4	101	62	I								
	2007.02-					Hatchback Engine 1AD-FTV	GC099320	Outer Joint		30	27	61.2	100	64	I								
2.2 D (130 kW)	2007.02-			L/R	F	Hatchback Engine 2AD-FHV	GC059318	Outer Joint		30	36	61.4	101	62	I								
	2007.02-					Hatchback Engine 2AD-FHV	GC099320	Outer Joint		30	27	61.2	100	64	I								
<b>AURIS (NZE18_, ZRE18_)</b>																							
1.4 D-4D (66 kW)	2012.10-				R	F	Hatchback Engine 1ND-TV	GDS59494	Drive Shaft		26	20	61.2	95.5	938								
2.0 D-4D (91 kW)	2012.10-						Hatchback Engine 1AD-FTV	GC099320	Outer Joint		30	27	61.2	100	64	I							
<b>AURIS TOURING SPORTS (ADE18_, ZWE18_, ZRE18_)</b>																							
1.4 D-4D (66 kW)	2013.07-				R	F	Estate Engine 1ND-TV	GDS59494	Drive Shaft		26	20	61.2	95.5	938								
<b>AURIS VAN (NDE15_)</b>																							
1.4 D-4D (66 kW)	2007.03-	2013.04			L	F	Box Engine 1ND-TV	GDS59268	Drive Shaft		26	20	61.2	95.5	665								
	2007.03-	2013.04			R	F	Box Engine 1ND-TV	GDS59447	Drive Shaft		26	20	61.2	95.5	943								
<b>AURIS VAN (ZRE18_, NZE18_)</b>																							
1.4 D-4D (66 kW)	2013.03-		MT	R	F	Box Engine 1ND-TV	GDS59494	Drive Shaft		26	20	61.2	95.5	938									
<b>AVALON</b>																							
-	1995-	1996						GC059061	Outer Joint		30	34	56	95.5	70	I							
	1995-	1996						GC059162	Outer Joint	48T	30	34	56	95.5	70	I							
<b>AVENSIS</b>																							
2	1999.01-		MT/AT				Engine 2CTE	GC059269	Outer Joint		26	23	56	99	59	M							
<b>AVENSIS (ACM20)</b>																							
2	2001-		MT/AT				Engine 1AZ-FE	GC059294	Outer Joint	48T	26	27	63	97	60	M							
<b>AVENSIS (T25)</b>																							
1.6 VVT-i (81 kW)	2003.04-	2008.11	MT	L	F		Estate Engine 3ZZ-FE	GDS59078	Drive Shaft	48T	26	20	58	96	638.5								









		YEAR	TRANSM	L/R	F/R		G-AP Ref.	PRODUCT	ABS	Technical Specifications						
										A	B	C	H	L	P	
<b>TOYOTA</b>																
<b>AVENSIS (T25)</b>																
1.6 VVT-i (81 kW)	2003.04-	2008.11	MT	L	F	Estate Engine 3ZZ-FE	GCI59005	Inner Joint		20	23	35	63.5	115.7		
	2003.04-	2008.11	MT	L	F	Estate Engine 3ZZ-FE	GC059083	Outer Joint		26	24	58	96	54	I	
	2003.04-	2008.11	MT	R	F	Estate Engine 3ZZ-FE	GDS59172	Drive Shaft	48T	26	20	56	99	919		
1.8 (95 kW)	2003.04-	2008.11	MT	L	F	Estate Engine 1ZZ-FE	GDS59272	Drive Shaft	48T	26	20	58	95.5	651.5		
	2003.04-	2008.11	MT	L	F	Saloon Engine 1ZZ-FE	GDS59272	Drive Shaft	48T	26	20	58	95.5	651.5		
	2003.04-	2008.11	MT	R	F	Estate Engine 1ZZ-FE	GDS59273	Drive Shaft	48T	26	20	58	95.5	925.5		
	2003.04-	2008.11	MT	R	F	Saloon Engine 1ZZ-FE	GDS59273	Drive Shaft	48T	26	20	58	95.5	925.5		
2.0 (108 kW)	2003.04-	2008.11			F	Estate Engine 1AZ-FSE	GC059226	Outer Joint	48T	26	25	58	93	63.5	M	
	2003.04-	2008.11			F	Saloon Engine 1AZ-FSE	GC059226	Outer Joint	48T	26	25	58	93	63.5	M	
2.0 D-4D (85 kW)	2003.04-	2008.11			F	Estate Engine 1CD-FTV	GC059226	Outer Joint	48T	26	25	58	93	63.5	M	
	2003.04-	2008.11		L	F	Estate Engine 1CD-FTV	GDS99107	Drive Shaft	48T	26	24	58	95.5	615		
	2003.04-	2008.11		L	F	Saloon Engine 1CD-FTV	GDS99107	Drive Shaft	48T	26	24	58	95.5	615		
	2003.04-	2008.11	MT	L	F	Estate Engine 1CD-FTV	GDS59207	Drive Shaft	48T	26	24	58	95.5	601		
	2003.04-	2008.11	MT	L	F	Saloon Engine 1CD-FTV	GDS59207	Drive Shaft	48T	26	24	58	95.5	601		
	2003.04-	2008.11		R	F	Estate Engine 1CD-FTV	GDS99106	Drive Shaft	48T	26	24	58	95.5	957.5		
	2003.04-	2008.11		R	F	Saloon Engine 1CD-FTV	GDS99106	Drive Shaft	48T	26	24	58	95.5	957.5		
	2003.04-	2008.11	MT	R	F	Estate Engine 1CD-FTV	GDS59519	Drive Shaft	48T	26	24	58	95.5	972		
	2003.04-						GC059182	Outer Joint	48T	26	25	58	95.5	61.5	M	
2.0 D-4D (93 kW)	2006.03-	2008.11	MT	R	F	Saloon Engine 1AD-FTV	GDS59519	Drive Shaft	48T	26	24	58	95.5	972		
	2006.07-	2008.11			F	Estate Engine 1AD-FTV	GC059226	Outer Joint	48T	26	25	58	93	63.5	M	
	2006.07-	2008.11	MT	R	F	Estate Engine 1AD-FTV	GDS59519	Drive Shaft	48T	26	24	58	95.5	972		
2.2 D-4D (110 kW)	2005.07-	2006.06			F	Estate Engine 2AD-FTV	GC059226	Outer Joint	48T	26	25	58	93	63.5	M	
	2005.07-	2006.06			F	Saloon Engine 2AD-FTV	GC059226	Outer Joint	48T	26	25	58	93	63.5	M	
	2005.07-	2006.06	MT			Estate Engine 2AD-FTV	GC059233	Outer Joint	48T	30	36	63	99	67	I	
	2005.07-	2006.06	MT			Saloon Engine 2AD-FTV	GC059233	Outer Joint	48T	30	36	63	99	67	I	
2.2 D-CAT (130 kW)	2006.07-	2008.11			F	Estate Engine 2AD-FHV	GC059226	Outer Joint	48T	26	25	58	93	63.5	M	
	2006.07-	2008.11			F	Saloon Engine 2AD-FHV	GC059226	Outer Joint	48T	26	25	58	93	63.5	M	
	2006.07-	2008.11	MT			Estate Engine 2AD-FHV	GC059233	Outer Joint	48T	30	36	63	99	67	I	
	2006.07-	2008.11	MT			Saloon Engine 2AD-FHV	GC059233	Outer Joint	48T	30	36	63	99	67	I	
2.4 (120 kW)	2003.10-	2006.05			F	Saloon Engine 2AZ-FSE	GC059226	Outer Joint	48T	26	25	58	93	63.5	M	
	2003.10-	2008.11			F	Estate Engine 2AZ-FSE	GC059226	Outer Joint	48T	26	25	58	93	63.5	M	
2.4 (125 kW)	2003.09-	2008.11			F	Estate Engine 2AZ-FSE	GC059226	Outer Joint	48T	26	25	58	93	63.5	M	
	2003.09-	2008.11			F	Saloon Engine 2AZ-FSE	GC059226	Outer Joint	48T	26	25	58	93	63.5	M	
<b>AVENSIS (T250)</b>																
2	2003.07-	2008.12	4AT/F			Engine 1AZ-FSE	GC099302	Outer Joint	48T	26	25	58	95.5	62	M	
<b>AVENSIS (T250W)</b>																
2	2003.07-	2008.12	4AT/F			Engine 1AZ-FSE	GC099302	Outer Joint	48T	26	25	58	95.5	62	M	
<b>AVENSIS (T251)</b>																
2	2005.06-	2008.12	5AT/F			Engine 2AZ-FSE	GC099302	Outer Joint	48T	26	25	58	95.5	62	M	
<b>AVENSIS (T251W)</b>																
2	2005.06-	2008.12	5AT/F			Engine 2AZ-FSE	GC099302	Outer Joint	48T	26	25	58	95.5	62	M	
<b>AVENSIS (T25_)</b>																
1.8 (95 kW)	2003.04-	2008.11	MT	L	F	Hatchback Engine 1ZZ-FE	GDS59272	Drive Shaft	48T	26	20	58	95.5	651.5		
	2003.04-	2008.11	MT	R	F	Hatchback Engine 1ZZ-FE	GDS59273	Drive Shaft	48T	26	20	58	95.5	925.5		
2.0 (108 kW)	2003.04-	2008.11			F	Hatchback Engine 1AZ-FSE	GC059226	Outer Joint	48T	26	25	58	93	63.5	M	
2.0 D-4D (85 kW)	2003.04-	2008.11		L	F	Hatchback Engine 1CD-FTV	GDS99107	Drive Shaft	48T	26	24	58	95.5	615		
	2003.04-	2008.11	MT	L	F	Hatchback Engine 1CD-FTV	GDS59207	Drive Shaft	48T	26	24	58	95.5	601		
	2003.04-	2008.11		R	F	Hatchback Engine 1CD-FTV	GDS99106	Drive Shaft	48T	26	24	58	95.5	957.5		
	2003.04-	2008.11	MT	R	F	Hatchback Engine 1CD-FTV	GDS59519	Drive Shaft	48T	26	24	58	95.5	972		
2.0 D-4D (93 kW)	2006.07-	2007.05	MT	R	F	Hatchback Engine 1AD-FTV	GDS59519	Drive Shaft	48T	26	24	58	95.5	972		
2.2 D-4D (110 kW)	2005.07-	2006.06	MT			Hatchback Engine 2AD-FTV	GC059233	Outer Joint	48T	30	36	63	99	67	I	
2.2 D-CAT (130 kW)	2006.07-	2008.11			F	Hatchback Engine 2AD-FHV	GC059226	Outer Joint	48T	26	25	58	93	63.5	M	
	2006.07-	2008.11	MT			Hatchback Engine 2AD-FHV	GC059233	Outer Joint	48T	30	36	63	99	67	I	
2.4 (120 kW)	2003.10-	2006.05			F	Hatchback Engine 2AZ-FSE	GC059226	Outer Joint	48T	26	25	58	93	63.5	M	
2.4 (125 kW)	2003.09-	2008.11			F	Hatchback Engine 2AZ-FSE	GC059226	Outer Joint	48T	26	25	58	93	63.5	M	
<b>AVENSIS (ZRT27, ADT27)</b>																
1.6 (97 kW)	2009.02-			L	F	Estate Engine 1ZR-FAE	GDS59553	Drive Shaft		26	20	61.2	95.5	675		
	2009.02-			L	F	Saloon Engine 1ZR-FAE	GDS59553	Drive Shaft		26	20	61.2	95.5	675		
	2009.02-			R	F	Estate Engine 1ZR-FAE	GDS59552	Drive Shaft		26	20	61.2	95.5	958		
	2009.02-			R	F	Saloon Engine 1ZR-FAE	GDS59552	Drive Shaft		26	20	61.2	95.5	958		
1.8 (108 kW)	2009.02-			L	F	Estate Engine 2ZR-FAE	GDS59553	Drive Shaft		26	20	61.2	95.5	675		



		TRANSM	L/R	F/R		G-AP Ref.	PRODUCT	ABS	Technical Specifications						
									YEAR	A	B	C	H	L	P
<b>TOYOTA</b>															
<b>AVENSIS (ZRT27, ADT27)</b>															
1.8 (108 kW)	2009.02-			L	F	Saloon Engine 2ZR-FAE	GDS59553	Drive Shaft		26	20	61.2	95.5	675	
	2009.02-			R	F	Estate Engine 2ZR-FAE	GDS59552	Drive Shaft		26	20	61.2	95.5	958	
	2009.02-			R	F	Saloon Engine 2ZR-FAE	GDS59552	Drive Shaft		26	20	61.2	95.5	958	
2.0 D-4D (91 kW)	2011.11-			L	F	Estate Engine 1AD-FTV	GDS59520	Drive Shaft		30	24	61.2	99.5	620	
	2011.11-			L	F	Saloon Engine 1AD-FTV	GDS59520	Drive Shaft		30	24	61.2	99.5	620	
	2011.11-		MT	R	F	Estate Engine 1AD-FTV	GDS59589	Drive Shaft		30	24	61.2	99.5	1004	
	2011.11-		MT	R	F	Saloon Engine 1AD-FTV	GDS59589	Drive Shaft		30	24	61.2	99.5	1004	
	2011.11-					Estate Engine 1AD-FTV	GC059345	Outer Joint		30	25	61.2	99.5	62	M
	2011.11-					Saloon Engine 1AD-FTV	GC059345	Outer Joint		30	25	61.2	99.5	62	M
2.0 D-4D (93 kW)	2009.02-			L	F	Estate Engine 1AD-FTV	GDS59520	Drive Shaft		30	24	61.2	99.5	620	
	2009.02-			L	F	Saloon Engine 1AD-FTV	GDS59520	Drive Shaft		30	24	61.2	99.5	620	
	2009.02-		MT	R	F	Estate Engine 1AD-FTV	GDS59589	Drive Shaft		30	24	61.2	99.5	1004	
	2009.02-		MT	R	F	Saloon Engine 1AD-FTV	GDS59589	Drive Shaft		30	24	61.2	99.5	1004	
	2009.02-					Estate Engine 1AD-FTV	GC059345	Outer Joint		30	25	61.2	99.5	62	M
	2009.02-					Saloon Engine 1AD-FTV	GC059345	Outer Joint		30	25	61.2	99.5	62	M
2.2 D-4D (110 kW)	2009.02-			L/R	F	Estate Engine 2AD-FTV/2AD-FHV	GC059365	Outer Joint		30	26	61.2	99.5	62	I
	2009.02-			L/R	F	Saloon Engine 2AD-FTV	GC059365	Outer Joint		30	26	61.2	99.5	62	I
2.2 D-4D (130 kW)	2009.02-			L/R	F	Estate Engine 2AD-FHV	GC059365	Outer Joint		30	26	61.2	99.5	62	I
	2009.02-			L/R	F	Saloon Engine 2AD-FHV	GC059365	Outer Joint		30	26	61.2	99.5	62	I
<b>AVENSIS (_T22_)</b>															
1.6 (74 kW)	1997.09-	2000.10		R	F	Saloon Engine 4A-FE	GC059022	Outer Joint	48T	26	23	56	99	61	M
1.6 (81 kW)	1997.09-	2000.10		R	F	Saloon Engine 4A-FE	GC059022	Outer Joint	48T	26	23	56	99	61	M
1.6 VVT-i (81 kW)	2000.10-	2003.02			F	Saloon Engine 3ZZ-FE	GC059028	Outer Joint	48T	26	22	56	99	61	M
	2000.10-	2003.02	MT	L	F	Saloon Engine 3ZZ-FE	GDS59078	Drive Shaft	48T	26	20	58	96	638.5	
	2000.10-	2003.02	MT	L	F	Saloon Engine 3ZZ-FE	GCI59005	Inner Joint		20	23	35	63.5	115.7	
	2000.10-	2003.02	MT	L	F	Saloon Engine 3ZZ-FE	GC059083	Outer Joint		26	24	58	96	54	I
	2000.10-	2003.02	MT	R	F	Saloon Engine 3ZZ-FE	GDS59172	Drive Shaft	48T	26	20	56	99	919	
1.8 (81 kW)	1997.09-	2000.10			F	Saloon Engine 7A-FE	GC059022	Outer Joint	48T	26	23	56	99	61	M
1.8 VVT-i (95 kW)	2000.10-	2003.02	MT	L	F	Saloon Engine 1ZZ-FE	GDS59078	Drive Shaft	48T	26	20	58	96	638.5	
	2000.10-	2003.02	MT	L	F	Saloon Engine 1ZZ-FE	GCI59005	Inner Joint		20	23	35	63.5	115.7	
	2000.10-	2003.02	MT	L	F	Saloon Engine 1ZZ-FE	GC059083	Outer Joint		26	24	58	96	54	I
	2000.10-	2003.02	MT	R	F	Saloon Engine 1ZZ-FE	GDS59172	Drive Shaft	48T	26	20	56	99	919	
2.0 (94 kW)	1997.09-	2000.10			F	Saloon Engine 3S-FE	GC059022	Outer Joint	48T	26	23	56	99	61	M
2.0 D-4D (81 kW)	1999.10-	2003.02	MT		F	Saloon Engine 1CD-FTV	GC059024	Outer Joint	48T	26	24	56	99	61	M
	1999.10-	2003.02	MT		F	Saloon Engine 1CD-FTV	GC059086	Outer Joint		26	24	56	99	61	M
2.0 TD (66 kW)	1997.09-	2003.02			F	Saloon Engine 2C-TE	GC059028	Outer Joint	48T	26	22	56	99	61	M
2.0 VVT-i (110 kW)	2000.10-	2003.02	MT	L	F	Saloon Engine 1AZ-FSE	GDS59078	Drive Shaft	48T	26	20	58	96	638.5	
	2000.10-	2003.02	MT	L	F	Saloon Engine 1AZ-FSE	GCI59005	Inner Joint		20	23	35	63.5	115.7	
	2000.10-	2003.02	MT	L	F	Saloon Engine 1AZ-FSE	GC059083	Outer Joint		26	24	58	96	54	I
	2000.10-	2003.02	MT	R	F	Saloon Engine 1AZ-FSE	GDS59172	Drive Shaft	48T	26	20	56	99	919	
<b>AVENSIS I (722), SW</b>															
2.0 VVT-i (110 kW)	2000.10-	2003.02					GCI59070	Inner Joint					27		33.2
<b>AVENSIS LIFTBACK (_T22_)</b>															
1.6 (74 kW)	1997.09-	2000.10		L/R	F	Hatchback Engine 4A-FE	GC059022	Outer Joint	48T	26	23	56	99	61	M
1.6 (81 kW)	1997.09-	2000.10		R	F	Hatchback Engine 4A-FE	GC059022	Outer Joint	48T	26	23	56	99	61	M
1.6 VVT-i (81 kW)	2000.10-	2003.02			F	Hatchback Engine 3ZZ-FE	GC059028	Outer Joint	48T	26	22	56	99	61	M
	2000.10-	2003.02	MT	L	F	Hatchback Engine 3ZZ-FE	GDS59078	Drive Shaft	48T	26	20	58	96	638.5	
	2000.10-	2003.02	MT	L	F	Hatchback Engine 3ZZ-FE	GCI59005	Inner Joint		20	23	35	63.5	115.7	
	2000.10-	2003.02	MT	L	F	Hatchback Engine 3ZZ-FE	GC059083	Outer Joint		26	24	58	96	54	I
	2000.10-	2003.02	MT	R	F	Hatchback Engine 3ZZ-FE	GDS59172	Drive Shaft	48T	26	20	56	99	919	
1.8 (81 kW)	1997.09-	2000.10			F	Hatchback Engine 7A-FE	GC059022	Outer Joint	48T	26	23	56	99	61	M
1.8 VVT-i (95 kW)	2000.10-	2003.02	MT	L	F	Hatchback Engine 1ZZ-FE	GDS59078	Drive Shaft	48T	26	20	58	96	638.5	
	2000.10-	2003.02	MT	L	F	Hatchback Engine 1ZZ-FE	GCI59005	Inner Joint		20	23	35	63.5	115.7	
	2000.10-	2003.02	MT	L	F	Hatchback Engine 1ZZ-FE	GC059083	Outer Joint		26	24	58	96	54	I
	2000.10-	2003.02	MT	R	F	Hatchback Engine 1ZZ-FE	GDS59172	Drive Shaft	48T	26	20	56	99	919	
2.0 (94 kW)	1997.09-	2000.10			F	Hatchback Engine 3S-FE	GC059022	Outer Joint	48T	26	23	56	99	61	M
2.0 D-4D (81 kW)	1999.10-	2003.02	MT		F	Hatchback Engine 1CD-FTV	GC059024	Outer Joint	48T	26	24	56	99	61	M
	1999.10-	2003.02	MT		F	Hatchback Engine 1CD-FTV	GC059086	Outer Joint		26	24	56	99	61	M
2.0 TD (66 kW)	1997.09-	2003.02			F	Hatchback Engine 2C-TE	GC059028	Outer Joint	48T	26	22	56	99	61	M
2.0 VVT-i (110 kW)	2000.10-	2003.02	MT	L	F	Hatchback Engine 1AZ-FSE	GDS59078	Drive Shaft	48T	26	20	58	96	638.5	
	2000.10-	2003.02	MT	L	F	Hatchback Engine 1AZ-FSE	GCI59005	Inner Joint		20	23	35	63.5	115.7	

		YEAR	TRANSM	L/R	F/R		G-AP Ref.	PRODUCT	ABS	Technical Specifications											
										A	B	C	H	L	P						
<b>TOYOTA</b>																					
<b>AVENSIS LIFTBACK (_T22_)</b>																					
2.0 VVT-i (110 kW)	2000.10-	2003.02	MT	L	F	Hatchback Engine 1AZ-FSE	GC059083	Outer Joint		26	24	58	96	54	I						
	2000.10-	2003.02	MT	R	F	Hatchback Engine 1AZ-FSE	GDS59172	Drive Shaft	48T	26	20	56	99	919							
<b>AVENSIS STATION WAGON (_T22_)</b>																					
1.6 (74 kW)	1997.09-	2000.10		R	F	Estate Engine 4A-FE	GC059022	Outer Joint	48T	26	23	56	99	61	M						
1.6 (81 kW)	1997.09-	2000.10		R	F	Estate Engine 4A-FE	GC059022	Outer Joint	48T	26	23	56	99	61	M						
1.6 VVT-i (81 kW)	2000.10-	2003.02			F	Estate Engine 3ZZ-FE	GC059028	Outer Joint	48T	26	22	56	99	61	M						
	2000.10-	2003.02	MT	L	F	Estate Engine 3ZZ-FE	GDS59078	Drive Shaft	48T	26	20	58	96	638.5							
	2000.10-	2003.02	MT	L	F	Estate Engine 3ZZ-FE	GCI59005	Inner Joint		20	23	35	63.5	115.7							
	2000.10-	2003.02	MT	L	F	Estate Engine 3ZZ-FE	GC059083	Outer Joint		26	24	58	96	54	I						
	2000.10-	2003.02	MT	R	F	Estate Engine 3ZZ-FE	GDS59172	Drive Shaft	48T	26	20	56	99	919							
1.8 (81 kW)	1997.09-	2000.10			F	Estate Engine 7A-FE	GC059022	Outer Joint	48T	26	23	56	99	61	M						
1.8 VVT-i (95 kW)	2000.10-	2003.02	MT	L	F	Estate Engine 1ZZ-FE	GDS59078	Drive Shaft	48T	26	20	58	96	638.5							
	2000.10-	2003.02	MT	L	F	Estate Engine 1ZZ-FE	GCI59005	Inner Joint		20	23	35	63.5	115.7							
	2000.10-	2003.02	MT	L	F	Estate Engine 1ZZ-FE	GC059083	Outer Joint		26	24	58	96	54	I						
	2000.10-	2003.02	MT	R	F	Estate Engine 1ZZ-FE	GDS59172	Drive Shaft	48T	26	20	56	99	919							
2.0 (94 kW)	1997.09-	2000.10			F	Estate Engine 3S-FE	GC059022	Outer Joint	48T	26	23	56	99	61	M						
2.0 D-4D (81 kW)	1999.10-	2003.02	MT		F	Estate Engine 1CD-FTV	GC059024	Outer Joint	48T	26	24	56	99	61	M						
	1999.10-	2003.02	MT		F	Estate Engine 1CD-FTV	GC059086	Outer Joint		26	24	56	99	61	M						
2.0 TD (66 kW)	1997.09-	2003.02			F	Estate Engine 2C-TE	GC059028	Outer Joint	48T	26	22	56	99	61	M						
2.0 VVT-i (110 kW)	2000.10-	2003.02	MT	L	F	Estate Engine 1AZ-FSE	GDS59078	Drive Shaft	48T	26	20	58	96	638.5							
	2000.10-	2003.02	MT	L	F	Estate Engine 1AZ-FSE	GCI59005	Inner Joint		20	23	35	63.5	115.7							
	2000.10-	2003.02	MT	L	F	Estate Engine 1AZ-FSE	GC059083	Outer Joint		26	24	58	96	54	I						
	2000.10-	2003.02	MT	R	F	Estate Engine 1AZ-FSE	GDS59172	Drive Shaft	48T	26	20	56	99	919							
<b>AVENSIS VERSO (M20)</b>																					
2.0 VVT-i (110 kW)	2001.08-						GCI59070	Inner Joint			27		33.2								
<b>AVENSIS VERSO (_CLM2_, _ACM2_)</b>																					
2.0 D-4D (85 kW)	2001.08-	2005.08	MT		F	MPV Engine 1CD-FTV	GC059042	Outer Joint	48T	30	27	63	100.5	64.5	I						
	2001.08-	2005.08	MT		F	MPV Engine 1CD-FTV	GC059024	Outer Joint	48T	26	24	56	99	61	M						
	2001.08-	2005.08		L	F	MPV Engine 1CD-FTV	GCI59073	Inner Joint		24	27	50	67	110							
	2001.08-	2005.08		R	F	MPV Engine 1CD-FTV	GCI59078	Inner Joint		24	27	40	370	105							
	2001.08-	2005.08	MT		F	MPV Engine 1CD-FTV	GC059086	Outer Joint		26	24	56	99	61	M						
2.0 VVT-i (110 kW)	2001.08-	2009.11	MT/AT		F	MPV Engine 1AZ-FE	GC059043	Outer Joint	48T	26	27	58	96	62	I						
	2001.08-	2009.11		L	F	MPV Engine 1AZ-FE	GCI59073	Inner Joint		24	27	50	67	110							
	2001.08-	2009.11		R	F	MPV Engine 1AZ-FE	GCI59078	Inner Joint		24	27	40	370	105							
2.4 VVT-i GLS (115 kW)	2003.10-	2009.11		L	F	MPV Engine 2AZ-FE	GCI59073	Inner Joint		24	27	50	67	110							
	2003.10-	2009.11		R	F	MPV Engine 2AZ-FE	GCI59078	Inner Joint		24	27	40	370	105							
<b>AYGO (KGB, WNB)</b>																					
1.0 VVT-i (50 kW)	2005.07-						GC099128	Outer Joint		24	19	49.5	91	46	M						
<b>AYGO (WNB1_, KGB1_)</b>																					
1.0 (50 kW)	2005.07-			L	F	Hatchback Engine 1KR-FE	GDS10232	Drive Shaft		24	23	49.5	91	650							
	2005.07-			R	F	Hatchback Engine 1KR-FE	GDS10231	Drive Shaft		24	23	49.5	91	841							
	2005.07-			L/R	F	Hatchback Engine 1KR-FE	GCI59069	Inner Joint		23	19	34	60	101							
	2005.07-			L/R	F	Hatchback Engine 1KR-FE	GC099128	Outer Joint		24	19	49.5	91	46	M						
1.4 HDi (40 kW)	2006.01-	2007.08		L	F	Hatchback Engine 2WZ-TV	GDS59495	Drive Shaft		24	23	49.5	91	593							
	2006.01-	2007.08		L	F	Hatchback Engine 2WZ-TV	GCI59069	Inner Joint		23	19	34	60	101							
	2006.01-	2007.08		L/R	F	Hatchback Engine 2WZ-TV	GC045058	Outer Joint		24	20	49.5	91	46	M						
<b>BANDEIRANTES</b>																					
-	1983.01-	1998.12	MT				GC059212	Outer Joint		30	27	55.5	178	61	I						
<b>BLADE (AZE154)</b>																					
-4WD	2006-						GC059245	Outer Joint		26	27	61.2	100	59	I						
<b>BLADE (AZE156,GRE156)</b>																					
-	2006-						GC059245	Outer Joint		26	27	61.2	100	59	I						
<b>CALDINA (AZT241W)</b>																					
2	2002-		AT			Engine 1AZ-FSE	GC059294	Outer Joint	48T	26	27	63	97	60	M						
<b>CALDINA (ET196V)</b>																					
1.5	1992.11-	2002.06	MT/AT			Engine 5E-FE	GC059005	Outer Joint		26	23	56	95.5	55	I						
<b>CAMI (J100E)</b>																					
1.3 4WD	1999.05-	2000.05	MT/AT			Engine HC-EJ	GC014037	Outer Joint	48T	24	19	52	94	81.5	M						
<b>CAMI (J102E)</b>																					
1.3 4WD	2000.05-		MT/AT			Engine K3-VE/K3-VET	GC014037	Outer Joint	48T	24	19	52	94	81.5	M						









		TRANSM	L/R	F/R		G-AP Ref.	PRODUCT	ABS	Technical Specifications									
									YEAR	A	B	C	H	L	P			
<b>TOYOTA CAMRY</b>																		
-				R		GDS59060	Drive Shaft		26	20	56	99.5	940					
	1987-					GC099111	Outer Joint		26	24	56	95.5	55	I				
	1988.01-	1992.05		L/R		GDS59137	Drive Shaft	48T	26		56	96	515.4					
	1990.01-	1992.12	MT/AT	R	SV21-22 4 Cyl	GDS59032	Drive Shaft		26	20	56	95.5	913.5					
	1992-	1995			4 Cyl	GCI59007	Inner Joint		20	32	35	63.5	115.3					
	1992-	1996				GCI59006	Inner Joint			34		33.2						
	1993-	2002				GCI59024	Inner Joint		20	27	35	335	112					
	1993-	2002		L		GDS59059	Drive Shaft		26	20	56	99.5	676.5					
	1997.01-	2002.09	MT/AT	L	20 Series 4 Cyl	GDS22005	Drive Shaft	48T	26	20	56	99.5	676.5					
	1997.01-	2002.09	MT/AT	R	20 Series 4 Cyl	GDS22006	Drive Shaft	48T	26	20	56	99.5	940					
	2002-					GCI59026	Inner Joint		24	26	50	67	104					
	2002-					GCI59025	Inner Joint		24	26	40	369	99.5					
	2002-					GC059106	Outer Joint		26	26	61	100	67	M				
	2002-					GC059188	Outer Joint	48T	26	26	61	100	67	M				
	2002-			L		GDS59074	Drive Shaft	48T	26	24	61	100	667					
	2002-			R		GDS59075	Drive Shaft	48T	26	24	61	100	941					
2				L		GDS59063	Drive Shaft	48T	26	24	70.05	100	658					
				R		GDS59062	Drive Shaft	48T	26	24	70.05	100	955.5					
2.2	1998-		MT		SXV20 5S-FE	GCI59033	Inner Joint		20	24	35	63.5	115.7					
	1998-					GC059066	Outer Joint		26	32	56	101	66	I				
2.4 (ACV30)	2003-			R		GDS59062	Drive Shaft	48T	26	24	70.05	100	955.5					
3.0 V6	1997-	1999				GC031002	Outer Joint		30	26	56	95.5	62	M				
<b>CAMRY (ACV30)</b>																		
2.4	2001-		AT		Engine 2AZ-FE	GC059294	Outer Joint	48T	26	27	63	97	60	M				
	2001.09-		4AT/F		Engine 2AZ-FE	GC059175	Outer Joint	48T	26	27	63.3	100	59	M				
<b>CAMRY (ACZ35)</b>																		
2.4 4WD	2001.09-		4AT/F		Engine 2AZ-FE	GC059175	Outer Joint	48T	26	27	63.3	100	59	M				
<b>CAMRY (MCV3_, ACV3_, XV3_)</b>																		
2.4 VVt-i (112 kW)	2001.11-	2006.11		L	F	Saloon Engine 2AZ-FE	GCI59073	Inner Joint		24	27	50	67	110				
3.0 V6 (137 kW)	2001.11-	2006.11			F	Saloon Engine 1MZ-FE	GC059431	Outer Joint	48T	30	27	61.2	100	64.5	M			
<b>CAMRY (V2),SW</b>																		
2.0 (SV21, SV25_) (89 kW)	1986-	1991	AT			GC059058	Outer Joint		26	30	56	95.5	62	I				
2.0 GLi 16V (SV21, SV25_) (94 kW)	1986-	1991	AT			GC059058	Outer Joint		26	30	56	95.5	62	I				
2.0 TD (CV20) (62-63 kW)	1986-	1991	AT			GC059058	Outer Joint		26	30	56	95.5	62	I				
<b>CAMRY (_CV1_, _XV1_, _V1_)</b>																		
2.2 (100 kW)	1991.06-	1996.08			F	Saloon Engine 5S-FE	GC059125	Outer Joint	48T	26	27	56	99.5	63	I			
	1991.06-	1996.08			F	Saloon Engine 5S-FE	GC059059	Outer Joint		26	32	56	101	64	I			
	1991.06-	1996.08	MT		F	Saloon Engine 5S-FE	GC031001	Outer Joint		26	27	56	99.5	63	I			
	1991.06-	1996.08	MT		F	Saloon Engine 5S-FE	GC059004	Outer Joint	48T	26	32	56	101	64	I			
3.0 (138 kW)	1991.06-	1996.08			F	Saloon Engine 3VZ-FE	GC059048	Outer Joint	48T	30	34	56	100.5	66	M			
	1991.06-	1996.08	MT		F	Saloon Engine 3VZ-FE	GC059009	Outer Joint	48T	30	27	56	100	67.5	I			
	1991.06-	1996.08	MT		F	Saloon Engine 3VZ-FE	GC059161	Outer Joint	48T	30	34	56	95.5	70	I			
	1991.06-	1996.08	MT/AT		F	Saloon Engine 3VZ-FE	GC059060	Outer Joint		30	34	56	95.5	70	I			
	1991.06-	1996.08	MT		F	Saloon Engine 3VZ-FE	GC059065	Outer Joint		30	27	56	100	67.5	I			
<b>CAMRY (_CV2_, _XV2_)</b>																		
2.2 (96 kW)	1996.08-	2001.11			F	Saloon Engine 5S-FE	GC059125	Outer Joint	48T	26	27	56	99.5	63	I			
	1996.08-	2001.11	MT		F	Saloon Engine 5S-FE	GC031001	Outer Joint		26	27	56	99.5	63	I			
	1996.08-	2001.11			F	Saloon Engine 5S-FE	GC059014	Outer Joint	48T	26	32	56	101	66	I			
3.0 24V (140 kW)	1996.08-	2001.11			F	Saloon Engine 1MZ-FE	GC059048	Outer Joint	48T	30	34	56	100.5	66	M			
3.0 V6 (135 kW)	1996.08-	2001.11				Saloon Engine 1MZ-FE	GCI31001	Inner Joint			27		33.2					
<b>CAMRY (_V1_)</b>																		
1.8 (66 kW)	1983.02-	1986.10			F	Saloon Engine 1S-L	GC059062	Outer Joint		26	24	56	95.5	55	I			
	1983.02-	1986.10	MT		F	Saloon Engine 1S-L	GC059001	Outer Joint		26	24	56	95.5	55	I			
1.8 Turbo-D (54 kW)	1983.11-	1988.01			F	Saloon Engine 1C-TL	GC059062	Outer Joint		26	24	56	95.5	55	I			
	1983.11-	1988.01	MT		F	Saloon Engine 1C-TL	GC059001	Outer Joint		26	24	56	95.5	55	I			
2.0 (73 kW)	1986.04-	1988.01	MT		F	Saloon Engine 2S-E/2S-ELC	GC059001	Outer Joint		26	24	56	95.5	55	I			
2.0 GLi (79 kW)	1983.03-	1986.10	MT		F	Saloon Engine 2S-EL	GC059001	Outer Joint		26	24	56	95.5	55	I			
<b>CAMRY (_V2_)</b>																		
1.8 i (66 kW)	1986.10-	1988.08			F	Saloon Engine 1S-L	GC059062	Outer Joint		26	24	56	95.5	55	I			
	1986.10-	1988.08	MT		F	Saloon Engine 1S-L	GC059001	Outer Joint		26	24	56	95.5	55	I			
2.0 (94 kW)	1986.11-	1991.05	MT		F	Saloon Engine 3S-FE	GC059125	Outer Joint	48T	26	27	56	99.5	63	I			



		TRANSM	L/R	F/R		G-AP Ref.	PRODUCT	ABS	Technical Specifications							
									YEAR	A	B	C	H	L	P	
<b>TOYOTA</b>																
<b>CAMRY (_V2_)</b>																
2.0 (94 kW)	1986.11-	1991.05			F	Saloon Engine 3S-FE	GC059062	Outer Joint		26	24	56	95.5	55	I	
	1986.11-	1991.05	MT		F	Saloon Engine 3S-FE	GC059001	Outer Joint		26	24	56	95.5	55	I	
2.0 GLi 16V (89 kW)	1986.11-	1991.05	MT		F	Saloon Engine 3S-FE	GC059125	Outer Joint	48T	26	27	56	99.5	63	I	
	1986.11-	1991.05			F	Saloon Engine 3S-FE	GC059062	Outer Joint		26	24	56	95.5	55	I	
	1986.11-	1991.05	MT		F	Saloon Engine 3S-FE	GC059001	Outer Joint		26	24	56	95.5	55	I	
2.0 Turbo-D (62 kW)	1986.11-	1991.05			F	Saloon Engine 2C-T	GC059062	Outer Joint		26	24	56	95.5	55	I	
	1986.11-	1991.05	MT/AT		F	Saloon Engine 2C-T	GC059001	Outer Joint		26	24	56	95.5	55	I	
2.0 Turbo-D (63 kW)	1988.11-	1991.05			F	Saloon Engine 2C-T	GC059062	Outer Joint		26	24	56	95.5	55	I	
	1988.11-	1991.05	MT/AT		F	Saloon Engine 2C-T	GC059001	Outer Joint		26	24	56	95.5	55	I	
<b>CAMRY / SOLARA</b>																
-	1983-	1988				4 Cyl (2WD)	GC159009	Inner Joint			24		79			
	1989-	1991				4 Cyl	GC059160	Outer Joint	48T	26	30	56	95.5	62	I	
	1989-	1991	AT			4 Cyl (2WD)	GC159009	Inner Joint			24		79			
	1992-	1996				6 Cyl	GC059061	Outer Joint		30	34	56	95.5	70	I	
	1992-	1996				6 Cyl	GC059162	Outer Joint	48T	30	34	56	95.5	70	I	
	1997-	2001				4 Cyl (2WD)	GC059183	Outer Joint	48T	26	24	56	100	61	M	
	1997-	2001				4 Cyl (2WD)	GC059215	Outer Joint		26	24	56	100	61	M	
<b>CAMRY / VISTA / SCEPTER</b>																
-	1989-	1991	MT			SV21 3S-FE	GC131004	Inner Joint		20	27	35	63.5	123		
2	1990-		MT/AT			CV40. CV30 2C-T	GC131004	Inner Joint		20	27	35	63.5	123		
2.2	1998-		MT				GC059095	Outer Joint		26	24	56	99	61	M	
<b>CAMRY GRACIA (SXV20)</b>																
2.2	1996.12-	2002.02	4AT			Engine 5S-FE	GC059012	Outer Joint	48T	26	27	56	100	63	M	
<b>CAMRY LIFTBACK (_V1_)</b>																
1.8 (66 kW)	1983.02-	1986.10			F	Hatchback Engine 1S-L	GC059062	Outer Joint		26	24	56	95.5	55	I	
	1983.02-	1986.10	MT		F	Hatchback Engine 1S-L	GC059001	Outer Joint		26	24	56	95.5	55	I	
1.8 Turbo-D (54 kW)	1984.10-	1988.01			F	Hatchback Engine 1C-TL	GC059062	Outer Joint		26	24	56	95.5	55	I	
	1984.10-	1988.01	MT		F	Hatchback Engine 1C-TL	GC059001	Outer Joint		26	24	56	95.5	55	I	
2.0 (73 kW)	1986.04-	1988.01	MT		F	Hatchback Engine 2S-ELC	GC059001	Outer Joint		26	24	56	95.5	55	I	
<b>CAMRY STATION WAGON (_V2_)</b>																
1.8 (66 kW)	1986.11-	1988.08			F	Estate Engine 1S	GC059062	Outer Joint		26	24	56	95.5	55	I	
	1986.11-	1988.08	MT		F	Estate Engine 1S	GC059001	Outer Joint		26	24	56	95.5	55	I	
2.0 (94 kW)	1986.11-	1991.05	MT		F	Estate Engine 3S-FE	GC059125	Outer Joint	48T	26	27	56	99.5	63	I	
	1986.11-	1991.05			F	Estate Engine 3S-FE	GC059062	Outer Joint		26	24	56	95.5	55	I	
	1986.11-	1991.05	MT		F	Estate Engine 3S-FE	GC059001	Outer Joint		26	24	56	95.5	55	I	
2.0 GLi 16V (89 kW)	1986.11-	1991.05	MT		F	Estate Engine 3S-FE	GC059125	Outer Joint	48T	26	27	56	99.5	63	I	
	1986.11-	1991.05			F	Estate Engine 3S-FE	GC059062	Outer Joint		26	24	56	95.5	55	I	
	1986.11-	1991.05	MT		F	Estate Engine 3S-FE	GC059001	Outer Joint		26	24	56	95.5	55	I	
2.0 Turbo-D (62 kW)	1986.11-	1991.05			F	Estate Engine 2C-T	GC059062	Outer Joint		26	24	56	95.5	55	I	
	1986.11-	1991.05	MT		F	Estate Engine 2C-T	GC059001	Outer Joint		26	24	56	95.5	55	I	
2.0 Turbo-D (63 kW)	1988.11-	1991.05			F	Estate Engine 2C-T	GC059062	Outer Joint		26	24	56	95.5	55	I	
	1988.11-	1991.05	MT/AT		F	Estate Engine 2C-T	GC059001	Outer Joint		26	24	56	95.5	55	I	
2.5 (118 kW)	1990.01-	1991.05			F	Estate Engine 2VZ-FE	GC099115	Outer Joint		26	32	56	97.5	67	I	
<b>CAMRY STATION WAGON (_XV1_, _CV1_, _V10)</b>																
2.2 (100 kW)	1992.03-	1996.07			F	Estate Engine 5S-FE	GC059125	Outer Joint	48T	26	27	56	99.5	63	I	
	1992.03-	1996.07	MT		F	Estate Engine 5S-FE	GC031001	Outer Joint		26	27	56	99.5	63	I	
	1992.03-	1996.07	MT		F	Estate Engine 5S-FE	GC059004	Outer Joint	48T	26	32	56	101	64	I	
3.0 (138 kW)	1992.03-	1996.07			F	Estate Engine 3VZ-FE	GC059048	Outer Joint	48T	30	34	56	100.5	66	M	
	1992.03-	1996.07	MT/AT		F	Estate Engine 3VZ-FE	GC059009	Outer Joint	48T	30	27	56	100	67.5	I	
	1992.03-	1996.07	MT/AT		F	Estate Engine 3VZ-FE	GC059161	Outer Joint	48T	30	34	56	95.5	70	I	
	1992.03-	1996.07	MT/AT		F	Estate Engine 3VZ-FE	GC059060	Outer Joint		30	34	56	95.5	70	I	
	1992.03-	1996.07	MT/AT		F	Estate Engine 3VZ-FE	GC059065	Outer Joint		30	27	56	100	67.5	I	
<b>CAMRY VISTA (CV20)</b>																
2	1986.08-	1989.09	MT			Engine 2C-T	GC059003	Outer Joint		26	25	56	95.6	61	M	
	1989.09-	1990.06	MT/AT			Engine 2C-T	GC059011	Outer Joint		26	27	56	100	63	M	
<b>CAMRY VISTA (CV30)</b>																
2	1990.07-	1994.06	MT/AT			Engine 2C-T	GC059011	Outer Joint		26	27	56	100	63	M	
<b>CAMRY VISTA (CV40)</b>																
2.2	1994.07-	1998.06	MT/AT			Engine 3C-T	GC059011	Outer Joint		26	27	56	100	63	M	
<b>CAMRY VISTA (SV21)</b>																
2	1986.08-	1990.06	AT			Engine 3S-GE	GC059003	Outer Joint		26	25	56	95.6	61	M	

		YEAR	TRANSM	L/R	F/R		G-AP Ref.	PRODUCT	ABS	Technical Specifications										
										A	B	C	H	L	P					
<b>TOYOTA CAMRY VISTA (SV21)</b>																				
2	1989.09-	1990.06	MT			Engine 3S-FE	GC059011	Outer Joint		26	27	56	100	63	M					
<b>CAMRY VISTA (SV25)</b>																				
2.0 4WD	1987.10-	1990.06	MT			Engine 3S-FE	GC059011	Outer Joint		26	27	56	100	63	M					
<b>CAMRY VISTA (SV32)</b>																				
2	1990.01-	1994.06	MT			Engine 3S-FE	GC059011	Outer Joint		26	27	56	100	63	M					
	1990.07-	1994.06	5MT			Engine 3S-FE	GC059089	Outer Joint		26	27	56	98	63	M					
	1990.07-	1994.06	AT			Engine 3S-FE	GC059203	Outer Joint		26	24	56	95.5	55	M					
<b>CAMRY VISTA (SV33)</b>																				
2	1990.01-	1991.01	MT			Engine 3S-FE	GC059011	Outer Joint		26	27	56	100	63	M					
	1990.07-	1994.06	5MT			Engine 3S-FE	GC059089	Outer Joint		26	27	56	98	63	M					
	1990.07-	1992.06	5MT			Engine 3S-GE	GC059089	Outer Joint		26	27	56	98	63	M					
	1990.07-	1994.06	AT			Engine 3S-FE	GC059203	Outer Joint		26	24	56	95.5	55	M					
2.0 4WS	1990.07-	1994.06	MT			Engine 3S-FE	GC059011	Outer Joint		26	27	56	100	63	M					
<b>CAMRY VISTA (VZV20)</b>																				
2	1987.04-	1990.06	MT			Engine 1VZ-FE	GC059203	Outer Joint		26	24	56	95.5	55	M					
<b>CAMRY VISTA (VZV30)</b>																				
2	1990.07-	1992.06	5MT			Engine 1VZ-FE	GC059089	Outer Joint		26	27	56	98	63	M					
	1990.07-	1992.06	AT			Engine 1VZ-FE	GC059203	Outer Joint		26	24	56	95.5	55	M					
<b>CAMRY VISTA (VZV31)</b>																				
2.0 4WS	1990.07-	1992.06	5MT			Engine 1VZ-FE	GC059089	Outer Joint		26	27	56	98	63	M					
	1990.07-	1992.06	MT			Engine 1VZ-FE	GC059089	Outer Joint		26	27	56	98	63	M					
	1990.07-	1992.06	AT			Engine 1VZ-FE	GC059203	Outer Joint		26	24	56	95.5	55	M					
<b>CAMRY VISTA (VZV32)</b>																				
2.5	1991.05-	1994.06	AT			Engine 4VZ-FE	GC059203	Outer Joint		26	24	56	95.5	55	M					
<b>CAMRY VISTA (VZV33)</b>																				
2.5 4WS	1991.05-	1994.06	AT			Engine 4VZ-FE	GC059203	Outer Joint		26	24	56	95.5	55	M					
<b>CARINA E (T19_)</b>																				
1.6 (73 kW)	1993.12-	1997.09			F	Hatchback Engine 4A-FE	GC059004	Outer Joint	48T	26	32	56	101	64	I					
	1995.01-	1997.09			F	Saloon Engine 4A-FE	GC059004	Outer Joint	48T	26	32	56	101	64	I					
1.6 (79 kW)	1993.01-	1997.09			F	Saloon Engine 4A-FE	GC059004	Outer Joint	48T	26	32	56	101	64	I					
1.6 GLi (79 kW)	1992.04-	1997.09			F	Hatchback Engine 4A-FE	GC059004	Outer Joint	48T	26	32	56	101	64	I					
1.6 i (73 kW)	1995.02-	1997.09			F	Estate Engine 4A-FE	GC059004	Outer Joint	48T	26	32	56	101	64	I					
1.8 (79 kW)	1995.01-	1997.09			F	Hatchback Engine 7A-FE	GC059062	Outer Joint		26	24	56	95.5	55	I					
	1995.01-	1997.09			F	Hatchback Engine 7A-FE	GC059004	Outer Joint	48T	26	32	56	101	64	I					
1.8 i (79 kW)	1995.02-	1997.09			F	Estate Engine 7A-FE	GC059062	Outer Joint		26	24	56	95.5	55	I					
	1995.02-	1997.09			F	Estate Engine 7A-FE	GC059004	Outer Joint	48T	26	32	56	101	64	I					
1.8 i 16V (79 kW)	1995.01-	1997.09			F	Saloon Engine 7A-FE	GC059062	Outer Joint		26	24	56	95.5	55	I					
	1995.01-	1997.09			F	Saloon Engine 7A-FE	GC059004	Outer Joint	48T	26	32	56	101	64	I					
2.0 (98 kW)	1993.01-	1997.09			F	Saloon Engine 3S-FE	GC059062	Outer Joint		26	24	56	95.5	55	I					
	1993.01-	1997.09			F	Saloon Engine 3S-FE	GC044008	Outer Joint	51T	28	27	67.1	93.5	64.5	I					
	1993.01-	1997.09	MT/AT		F	Saloon Engine 3S-FE	GC059120	Outer Joint	48T	26	24	56	95.5	55	I					
2.0 D (54 kW)	1992.04-	1996.01			F	Hatchback Engine 2C	GC059062	Outer Joint		26	24	56	95.5	55	I					
	1992.04-	1996.01	MT/AT		F	Hatchback Engine 2C	GC059120	Outer Joint	48T	26	24	56	95.5	55	I					
	1992.08-	1996.01			F	Saloon Engine 2C	GC059062	Outer Joint		26	24	56	95.5	55	I					
	1992.08-	1996.01	MT/AT		F	Saloon Engine 2C	GC059120	Outer Joint	48T	26	24	56	95.5	55	I					
	1993.01-	1996.01	MT/AT		F	Estate Engine 2C	GC059120	Outer Joint	48T	26	24	56	95.5	55	I					
	1993.01-	1996.01			F	Estate Engine 2C	GC059062	Outer Joint		26	24	56	95.5	55	I					
2.0 GLi (98 kW)	1992.04-	1997.09			F	Hatchback Engine 3S-FE	GC059062	Outer Joint		26	24	56	95.5	55	I					
	1992.04-	1997.09			F	Hatchback Engine 3S-FE	GC044008	Outer Joint	51T	28	27	67.1	93.5	64.5	I					
	1992.04-	1997.09	MT/AT		F	Hatchback Engine 3S-FE	GC059120	Outer Joint	48T	26	24	56	95.5	55	I					
	1993.01-	1997.09	MT/AT		F	Estate Engine 3S-FE	GC059120	Outer Joint	48T	26	24	56	95.5	55	I					
	1993.01-	1997.09			F	Estate Engine 3S-FE	GC059062	Outer Joint		26	24	56	95.5	55	I					
	1993.01-	1997.09			F	Estate Engine 3S-FE	GC044008	Outer Joint	51T	28	27	67.1	93.5	64.5	I					
2.0 GTi (116 kW)	1992.04-	1994.02			F	Hatchback Engine 3S-GE	GC059002	Outer Joint	48T	26	25	56	96	62	I					
	1992.04-	1994.02			F	Saloon Engine 3S-GE	GC059002	Outer Joint	48T	26	25	56	96	62	I					
	1992.04-	1994.02			F	Hatchback Engine 3S-GE	GC099124	Outer Joint		26	25	56	96	61	I					
	1992.04-	1994.02			F	Saloon Engine 3S-GE	GC099124	Outer Joint		26	25	56	96	61	I					
2.0 GTi 16V (129 kW)	1994.03-	1997.09			F	Hatchback Engine 3S-GE	GC059002	Outer Joint	48T	26	25	56	96	62	I					
	1994.03-	1997.09			F	Saloon Engine 3S-GE	GC059002	Outer Joint	48T	26	25	56	96	62	I					
2.0 i (93 kW)	1992.12-	1997.09			F	Saloon Engine 3S-FE	GC059062	Outer Joint		26	24	56	95.5	55	I					
	1992.12-	1997.09	MT/AT		F	Saloon Engine 3S-FE	GC059120	Outer Joint	48T	26	24	56	95.5	55	I					









		TRANSM	L/R	F/R		G-AP Ref.	PRODUCT	ABS	Technical Specifications											
									YEAR	A	B	C	H	L	P					
<b>TOYOTA</b>																				
<b>CARINA E (T19)</b>																				
2.0 i (93 kW)	1993.12-	1997.09	MT/AT		F	Hatchback Engine 3S-FE	GC059120	Outer Joint	48T	26	24	56	95.5	55	I					
	1993.12-	1997.09			F	Hatchback Engine 3S-FE	GC059062	Outer Joint		26	24	56	95.5	55	I					
	1993.12-	1997.09			F	Hatchback Engine 3S-FE	GC099124	Outer Joint		26	25	56	96	61	I					
	1995.05-	1997.09	MT/AT		F	Estate Engine 3S-FE	GC059120	Outer Joint	48T	26	24	56	95.5	55	I					
	1995.05-	1997.09			F	Estate Engine 3S-FE	GC059062	Outer Joint		26	24	56	95.5	55	I					
	1995.05-	1997.09			F	Estate Engine 3S-FE	GC099124	Outer Joint		26	25	56	96	61	I					
2.0 TD (61 kW)	1996.01-	1997.09	MT/AT		F	Hatchback Engine 2C-T	GC059120	Outer Joint	48T	26	24	56	95.5	55	I					
	1996.01-	1997.09	MT/AT		F	Saloon Engine 2C-T	GC059120	Outer Joint	48T	26	24	56	95.5	55	I					
	1996.01-	1997.09	MT/AT		F	Estate Engine 2C-T	GC059120	Outer Joint	48T	26	24	56	95.5	55	I					
<b>CARINA E VI</b>																				
2	1992.05-	1996.01	MT				GC059186	Outer Joint	48T	26	25	56	96	61	I					
2.0 TD	1996.02-	1997.11	MT				GC059186	Outer Joint	48T	26	25	56	96	61	I					
<b>CARINA II (T15)</b>																				
1.6 (55 kW)	1983.10-	1987.11					GC022001	Outer Joint		26	23	56	96.5	55	I					
1.6 (62 kW)	1983.10-	1987.11					GC022001	Outer Joint		26	23	56	96.5	55	I					
1.6 (63 kW)	1983.10-	1987.11					GC022001	Outer Joint		26	23	56	96.5	55	I					
1.6 (83 kW)	1983.10-	1987.11					GC022001	Outer Joint		26	23	56	96.5	55	I					
<b>CARINA II (T15)</b>																				
1.6 (55 kW)	1983.10-	1987.11	MT		F	Hatchback Engine 4A-LC	GC022001	Outer Joint		26	23	56	96.5	55	I					
	1983.10-	1987.11	MT		F	Saloon Engine 4A-LC	GC022001	Outer Joint		26	23	56	96.5	55	I					
1.6 (62 kW)	1983.10-	1987.11	MT		F	Hatchback Engine 4A-L	GC022001	Outer Joint		26	23	56	96.5	55	I					
	1983.10-	1987.11	MT		F	Saloon Engine 4A-L	GC022001	Outer Joint		26	23	56	96.5	55	I					
1.6 (63 kW)	1986.10-	1987.11	MT		F	Hatchback Engine 4A-L	GC022001	Outer Joint		26	23	56	96.5	55	I					
1.8 GLi (74 kW)	1983.10-	1987.11			F	Hatchback Engine 1S-L	GC059062	Outer Joint		26	24	56	95.5	55	I					
	1983.10-	1987.11			F	Saloon Engine 1S-EL	GC059062	Outer Joint		26	24	56	95.5	55	I					
	1983.10-	1987.11	MT		F	Hatchback Engine 1S-L	GC059001	Outer Joint		26	24	56	95.5	55	I					
	1983.10-	1987.11	MT		F	Saloon Engine 1S-EL	GC059001	Outer Joint		26	24	56	95.5	55	I					
2.0 D (50 kW)	1984.02-	1988.05			F	Hatchback Engine 2C-L	GC059062	Outer Joint		26	24	56	95.5	55	I					
	1984.02-	1988.05			F	Saloon Engine 2C-L	GC059062	Outer Joint		26	24	56	95.5	55	I					
	1984.02-	1988.05	MT		F	Hatchback Engine 2C-L	GC059001	Outer Joint		26	24	56	95.5	55	I					
	1984.02-	1988.05	MT		F	Saloon Engine 2C-L	GC059001	Outer Joint		26	24	56	95.5	55	I					
2.0 D (51 kW)	1985.12-	1987.11			F	Hatchback Engine 2C-L	GC059062	Outer Joint		26	24	56	95.5	55	I					
	1985.12-	1987.11	MT		F	Hatchback Engine 2C-L	GC059001	Outer Joint		26	24	56	95.5	55	I					
<b>CARINA II (T17)</b>																				
1.6 (72 kW)	1987.12-	1992.03			F	Estate Engine 4A-FE	GC059062	Outer Joint		26	24	56	95.5	55	I					
	1987.12-	1992.03			F	Hatchback Engine 4A-FE	GC059062	Outer Joint		26	24	56	95.5	55	I					
	1987.12-	1992.03			F	Saloon Engine 4A-FE	GC059062	Outer Joint		26	24	56	95.5	55	I					
1.6 (75 kW)	1987.12-	1992.03			F	Estate Engine 4A-FE	GC059062	Outer Joint		26	24	56	95.5	55	I					
	1987.12-	1992.03			F	Hatchback Engine 4A-FE	GC059062	Outer Joint		26	24	56	95.5	55	I					
	1987.12-	1992.03			F	Saloon Engine 4A-FE	GC059062	Outer Joint		26	24	56	95.5	55	I					
2.0 D (54 kW)	1987.12-	1992.01	MT/AT		F	Estate Engine 2C-L	GC059019	Outer Joint	48T	26	24	56	95.5	55	I					
	1987.12-	1992.01			F	Estate Engine 2C-L	GC059062	Outer Joint		26	24	56	95.5	55	I					
	1987.12-	1992.01	MT		F	Estate Engine 2C-L	GC059001	Outer Joint		26	24	56	95.5	55	I					
	1988.03-	1992.06	MT/AT		F	Saloon Engine 2C	GC059019	Outer Joint	48T	26	24	56	95.5	55	I					
	1988.03-	1992.06			F	Hatchback Engine 2C-L	GC059019	Outer Joint	48T	26	24	56	95.5	55	I					
	1988.03-	1992.06			F	Hatchback Engine 2C-L	GC059062	Outer Joint		26	24	56	95.5	55	I					
	1988.03-	1992.06			F	Saloon Engine 2C	GC059062	Outer Joint		26	24	56	95.5	55	I					
	1988.03-	1992.06	MT		F	Hatchback Engine 2C-L	GC059001	Outer Joint		26	24	56	95.5	55	I					
	1988.03-	1992.06	MT		F	Saloon Engine 2C	GC059001	Outer Joint		26	24	56	95.5	55	I					
2.0 GLi (89 kW)	1987.12-	1992.03			F	Hatchback Engine 3S-FE	GC059019	Outer Joint	48T	26	24	56	95.5	55	I					
	1987.12-	1992.03			F	Saloon Engine 3S-FE	GC059019	Outer Joint	48T	26	24	56	95.5	55	I					
<b>CARINA III (T17), SW</b>																				
1.6 (66 kW)	1987.12-	1992.03	MT/AT				GC022001	Outer Joint		26	23	56	96.5	55	I					
1.6 (72 kW)	1987.12-	1992.03	MT/AT				GC022001	Outer Joint		26	23	56	96.5	55	I					
1.6 (75 kW)	1987.12-	1992.03	MT/AT				GC022001	Outer Joint		26	23	56	96.5	55	I					
<b>CELICA</b>																				
-	1986-	1989				GT&ST	GC159009	Inner Joint			24		79							
<b>CELICA (AT16, ST16)</b>																				
1.6 (63 kW)	1986.04-	1989.08			F	Saloon Engine 4A-L	GC059062	Outer Joint		26	24	56	95.5	55	I					
1.6 GT 16V (91 kW)	1986.04-	1989.08			F	Saloon Engine 4A-GEL	GC059062	Outer Joint		26	24	56	95.5	55	I					
	1986.04-	1989.08	MT		F	Saloon Engine 4A-GEL	GC059001	Outer Joint		26	24	56	95.5	55	I					



		YEAR	TRANSM	L/R	F/R		G-AP Ref.	PRODUCT	ABS	Technical Specifications								
										A	B	C	H	L	P			
<b>TOYOTA</b>																		
<b>CELICA (AT16_, ST16_)</b>																		
2.0 (110 kW)	1987.01-	1989.08			F	Saloon Engine 3S-GEL	GC059002	Outer Joint	48T	26	25	56	96	62	I			
	1987.01-	1989.08	MT		F	Saloon Engine 3S-GEL	GC059056	Outer Joint		26	25	56	96	62	I			
<b>CELICA (AT18_, ST18_)</b>																		
2.0 GTi (115 kW)	1989.10-	1993.11	MT		F	Coupe Engine 3S-GE	GC031001	Outer Joint		26	27	56	99.5	63	I			
	1989.10-	1993.11			F	Coupe Engine 3S-GE	GC059002	Outer Joint	48T	26	25	56	96	62	I			
	1989.10-	1993.11			F	Convertible Engine 3S-GE	GC059002	Outer Joint	48T	26	25	56	96	62	I			
	1989.10-	1993.11			F	Coupe Engine 3S-GE	GC059062	Outer Joint		26	24	56	95.5	55	I			
	1989.10-	1993.11			F	Convertible Engine 3S-GE	GC059062	Outer Joint		26	24	56	95.5	55	I			
	1989.10-	1993.11	AT		F	Coupe Engine 3S-GE	GC059001	Outer Joint		26	24	56	95.5	55	I			
	1989.10-	1993.11			F	Coupe Engine 3S-GE	GC099124	Outer Joint		26	25	56	96	61	I			
2.0 Turbo 4WD (150 kW)	1989.10-	1993.11				Coupe Engine 3S-GTE	GC059063	Outer Joint		26	29	56	99.5	62.5	O			
	1989.10-	1993.11	MT		F	Coupe Engine 3S-GTE	GC031001	Outer Joint		26	27	56	99.5	63	I			
	1989.10-	1993.11	AT		F	Coupe Engine 3S-GTE	GC059001	Outer Joint		26	24	56	95.5	55	I			
2.0 Turbo 4WD (153 kW)	1989.10-	1993.11				Coupe Engine 3S-GTE	GC059063	Outer Joint		26	29	56	99.5	62.5	O			
	1989.10-	1993.11	MT		F	Coupe Engine 3S-GTE	GC031001	Outer Joint		26	27	56	99.5	63	I			
	1989.10-	1993.11	AT		F	Coupe Engine 3S-GTE	GC059001	Outer Joint		26	24	56	95.5	55	I			
<b>CELICA (AT20_, ST20_)</b>																		
2.0 i 16V (125 kW)	1993.11-	1999.08			F	Convertible Engine 3S-GE	GC059002	Outer Joint	48T	26	25	56	96	62	I			
<b>CELICA (ST162)</b>																		
2	1985.08-	1989.08	MT&AT			Engine 3S-GELU	GC059003	Outer Joint		26	25	56	95.6	61	M			
<b>CELICA (ST16_, AT16_)</b>																		
1.6 (63 kW)	1986.04-	1989.08			F	Hatchback Engine 4A-L	GC059062	Outer Joint		26	24	56	95.5	55	I			
1.6 GT (85 kW)	1987.08-	1989.08			F	Hatchback Engine 4A-GELC	GC059062	Outer Joint		26	24	56	95.5	55	I			
	1987.08-	1989.08	MT		F	Hatchback Engine 4A-GELC	GC059001	Outer Joint		26	24	56	95.5	55	I			
1.6 GT 16V (91 kW)	1985.09-	1989.08			F	Hatchback Engine 4A-GEL	GC059062	Outer Joint		26	24	56	95.5	55	I			
	1985.09-	1989.08	MT		F	Hatchback Engine 4A-GEL	GC059001	Outer Joint		26	24	56	95.5	55	I			
2.0 GT (103 kW)	1985.08-	1989.08			F	Convertible Engine 3S-GELC	GC059002	Outer Joint	48T	26	25	56	96	62	I			
	1985.08-	1989.08	MT		F	Convertible Engine 3S-GELC	GC059056	Outer Joint		26	25	56	96	62	I			
	1985.09-	1989.08			F	Hatchback Engine 3S-GELC	GC059002	Outer Joint	48T	26	25	56	96	62	I			
	1985.09-	1989.08	MT		F	Hatchback Engine 3S-GELC	GC059056	Outer Joint		26	25	56	96	62	I			
2.0 GT (110 kW)	1985.08-	1989.08			F	Hatchback Engine 3S-GEL	GC059002	Outer Joint	48T	26	25	56	96	62	I			
	1985.08-	1989.08	MT		F	Hatchback Engine 3S-GEL	GC059056	Outer Joint		26	25	56	96	62	I			
	1986.10-	1989.08			F	Convertible Engine 3S-GEL	GC059002	Outer Joint	48T	26	25	56	96	62	I			
	1986.10-	1989.08	MT		F	Convertible Engine 3S-GEL	GC059056	Outer Joint		26	25	56	96	62	I			
2.0 Turbo 4WD (136 kW)	1988.03-	1989.08				Coupe Engine 3S-GTE	GC059063	Outer Joint		26	29	56	99.5	62.5	O			
<b>CELICA (ST182)</b>																		
2	1989.09-	1993.08	MT/AT			Engine 3S-FE	GC059011	Outer Joint		26	27	56	100	63	M			
	1989.09-	1993.08	MT&AT			Engine 3S-GE	GC059003	Outer Joint		26	25	56	95.6	61	M			
<b>CELICA (ST183)</b>																		
2.0 4WS	1989.09-	1993.09	MT/AT			Engine 3S-FE	GC059011	Outer Joint		26	27	56	100	63	M			
	1989.09-	1993.09	MT&AT			Engine 3S-GE	GC059003	Outer Joint		26	25	56	95.6	61	M			
<b>CELICA (ST185)</b>																		
2	1989.10-		MT			Engine 3S-GET TBO	GC059010	Outer Joint		26	27	56	96	67.5	I			
	1989.10-		MT			Engine 3S-GTE TBO	GC059155	Outer Joint	48T	26	27	56	96	67.5	I			
2.0 4WD	1989.10-	1993.08	MT			Engine 3S-GTE	GC059010	Outer Joint		26	27	56	96	67.5	I			
	1989.10-	1993.08	MT			Engine 3S-GTE	GC059155	Outer Joint	48T	26	27	56	96	67.5	I			
<b>CELICA (ST202)</b>																		
2	1993.09-	1999.09	MT/AT			Engine 3S-FE	GC059011	Outer Joint		26	27	56	100	63	M			
	1993.09-	1999.09	MT/AT			Engine 3S-GE	GC059003	Outer Joint		26	25	56	95.6	61	M			
<b>CELICA (ST203)</b>																		
2.0 4WS	1993.09-	1997.12	MT/AT			Engine 3S-FE	GC059011	Outer Joint		26	27	56	100	63	M			
<b>CELICA (ST20_, AT20_)</b>																		
2.0 i 16V (125 kW)	1996.04-	1999.11			F	Coupe Engine 3S-GE	GC059002	Outer Joint	48T	26	25	56	96	62	I			
2.0 i 16V (129 kW)	1993.11-	1999.11			F	Coupe Engine 3S-GE	GC059002	Outer Joint	48T	26	25	56	96	62	I			
2.0 i Turbo 4WD (178 kW)	1994.02-	1999.11			F	Coupe Engine 3S-GTE	GC059002	Outer Joint	48T	26	25	56	96	62	I			
<b>CELICA (ZZT23_)</b>																		
1.8 16V TS (141 kW)	1999.08-	2005.09			F	Coupe Engine 2ZZ-GE	GC059261	Outer Joint	48T	26	25	56	95	61	I			
1.8 16V VT-i (105 kW)	1999.08-	2005.07	6MT		F	Coupe Engine 1ZZ-FE	GC059262	Outer Joint	48T	26	24	58	95	51	I			
<b>CELICA (_A6_)</b>																		
1.6 (91 kW)	1983.12-	1985.12	MT		R	Coupe Engine 4A-GE	GC022001	Outer Joint		26	23	56	96.5	55	I			

		TRANSM	L/R	F/R		G-AP Ref.	PRODUCT	ABS	Technical Specifications								
									YEAR	A	B	C	H	L	P		
<b>TOYOTA</b>																	
<b>CELICA II (TA60, RA40, RA6)</b>																	
1.6 GT Coupe (91 kW)	1983.08-	1985.07				GC022001	Outer Joint		26	23	56	96.5	55	I			
<b>CELICA IV</b>																	
2	1985.11-	1990.01	MT/AT			GC059186	Outer Joint	48T	26	25	56	96	61	I			
<b>CELICA IV (T18)</b>																	
2.0 T 4WD (ST185) Coupe (150-153 kW)	1989-					GC021001	Outer Joint		26	29	56	96	62	O			
<b>COROLLA</b>																	
-				L	ALTIS	GDS59069	Drive Shaft	48T	26	23	58	96	636.5				
				L	CE111	GDS59196	Drive Shaft	48T	26	20	56	95.5	609				
				L	ZNE10	GDS59192	Drive Shaft	48T	26	20	58	96	641				
				R	ALTIS	GDS59080	Drive Shaft	48T	26	23	58	96	908				
				R	CE110	GDS59195	Drive Shaft	48T	26	20	56	95.5	917				
				R	ZNE10	GDS59191	Drive Shaft	48T	26	20	58	96	912				
	1986.01-	1994.08	MT/AT		AE 95 4WD	GCI59012	Inner Joint		23	23	44	49.5	114.5				
	1986.01-	1994.08	MT/AT	L	F	GDS59044	Drive Shaft		26	23	56	95.5	574				
	1986.01-	1994.08	MT/AT	R	F	GDS59046	Drive Shaft		26	23	56	95.5	578.5				
	1988-	1992		L		GDS59070	Drive Shaft		26	23	56	99.5	599				
	1988-	1992		R		GDS59071	Drive Shaft		26	23	56	99.5	908				
	1989.01-	1994.08	MT/AT		AE90,AE 92. AE 94	GCI88015	Inner Joint		23	23	34	61	116				
	1989.01-	1994.08		L	AE90,AE 92. AE 94	GDS59035	Drive Shaft		26	23	56	96.5	605				
	1989.01-	1994.08	MT/AT	R	AE90,AE 92. AE 94	GDS88017	Drive Shaft		26	23	56	96.5	910				
	1989.06-	1991.03		L	AE90 AE92 AE94	GDS22003	Drive Shaft	48T	26	23	56	96.5	605				
	1989.06-	1991.03		R	AE90 AE92 AE94	GDS22004	Drive Shaft	48T	26	23	56	96.5	910				
	1992-	1999				GCI19001	Inner Joint		23	29	34	58.5	128.5				
	2003-					GCI59023	Inner Joint		23	23	34	60	113				
	2003-					GC059082	Outer Joint		26	23	58	96	54	I			
	2003-					GC059130	Outer Joint	48T	26	23	58	96	54	I			
1.6					MZE121/ZZE121/1NZ-FE,3ZZ-FE	GC059083	Outer Joint		26	24	58	96	54	I			
	2004.01-				NZE121 ZZE121	GC059131	Outer Joint	48T	26	24	58	96	54	I			
1.8				L		GDS59079	Drive Shaft	48T	26	20	58	96	910				
				R		GDS59078	Drive Shaft	48T	26	20	58	96	638.5				
				R	AE 102	GDS22001	Drive Shaft	48T	26	23	56	96.5	920				
	2001.02-		4AT/F		Engine 1ZZ-FE	GC059136	Outer Joint	48T	26	23	58	96	52.5	I			
	NULL-			R		GC059083	Outer Joint		26	24	58	96	54	I			
	NULL-			R		GCI59005	Inner Joint		20	23	35	63.5	115.7				
<b>COROLLA (AE86)</b>																	
1.6 16V (85 kW)	1985.12-	1987.04	MT		R Coupe Engine 4A-GEC	GC059001	Outer Joint		26	24	56	95.5	55	I			
1.6 GT 16V (91 kW)	1983.08-	1987.07			R Coupe Engine 4A-GE	GC059062	Outer Joint		26	24	56	95.5	55	I			
	1983.08-	1987.07	MT		R Coupe Engine 4A-GE	GC059001	Outer Joint		26	24	56	95.5	55	I			
<b>COROLLA (AE92)</b>																	
1.6 i	1987-	2002		R	F	GDS59392	Drive Shaft		26	23	56	96.5	926				
<b>COROLLA (E142)</b>																	
1.8	2006.09-	2008.10	CVT		Engine 2ZR-FE/3ZR-FE	GC059387	Outer Joint	48T	26	25	58	95.5	56.5	M			
<b>COROLLA (E144)</b>																	
1.8 4WD	2006.09-	2008.10	CVT		Engine 2ZR-FE	GC059387	Outer Joint	48T	26	25	58	95.5	56.5	M			
<b>COROLLA (E15_)</b>																	
1.33 (74 kW)	2007.01-			L	F Saloon Engine 1NR-FE	GDS59316	Drive Shaft		26	23	61.2	95.5	662				
	2007.01-			R	F Saloon Engine 1NR-FE	GDS59317	Drive Shaft		26	23	61.2	95.5	941				
1.4 D-4D (66 kW)	2007.01-			L	F Saloon Engine 1ND-TV	GDS59268	Drive Shaft		26	20	61.2	95.5	665				
	2007.01-			R	F Saloon Engine 1ND-TV	GDS59447	Drive Shaft		26	20	61.2	95.5	943				
1.4 VVT-i (71 kW)	2007.01-			L	F Saloon Engine 4ZZ-FE	GDS59316	Drive Shaft		26	23	61.2	95.5	662				
	2007.01-			R	F Saloon Engine 4ZZ-FE	GDS59317	Drive Shaft		26	23	61.2	95.5	941				
<b>COROLLA (E8 - E11 / EL,FX,GT,NP)</b>																	
1.3 (EL51)	1994.09-		MT/AT		Engine 4A-FE/4E-FE	GC059017	Outer Joint		26	22	56	95	50	M			
<b>COROLLA (NRE18_, ZRE17_, ZRE18_, NDE18_)</b>																	
1.3 (73 kW)	2013.06-				Saloon Engine 1NR-FE	GCI99038	Inner Joint		23	23	34	60	113				
1.8 VVTi (103 kW)	2013.06-				Saloon Engine 2ZR-FBE/2ZR-FE	GCI59100	Inner Joint		20	25	35	63.5	118				
<b>COROLLA (NZE121, ZZE121)</b>																	
1.6	2004.01-			L		GDS59069	Drive Shaft	48T	26	23	58	96	636.5				
<b>COROLLA (ZZ121)</b>																	
1.4 VVT-i	2002-	2007		L	F	GDS59270	Drive Shaft	48T	26	23	56	99	633.5				
	2002-	2007		R	F	GDS59271	Drive Shaft	48T	26	23	56	99	915				









		TRANSM	L/R	F/R		G-AP Ref.	PRODUCT	ABS	Technical Specifications					
									YEAR	A	B	C	H	L
<b>TOYOTA</b>														
<b>COROLLA (ZZ121)</b>														
1.6 VVT-i	2002-2007			L	F	GDS59270	Drive Shaft	48T	26	23	56	99	633.5	
	2002-2007			R	F	GDS59271	Drive Shaft	48T	26	23	56	99	915	
<b>COROLLA (ZZE122)</b>														
1.8	2001.02-		4AT/F		Engine 1ZZ-FE	GC059153	Outer Joint	48T	26	24	58	96	52.5 I	
<b>COROLLA (ZZE12_ , NDE12_ , ZDE12_ )</b>														
1.4 D (66 kW)	2004.06-	2007.08			F Hatchback Engine 1ND-TV	GC059226	Outer Joint	48T	26	25	58	93	63.5 M	
1.4 VVT-i (71 kW)	2002.01-	2006.12			F Hatchback Engine 4ZZ-FE	GC059037	Outer Joint	48T	26	23	58	95.5	61 M	
	2002.01-	2006.12	MT	R	F Hatchback Engine 4ZZ-FE	GDS59205	Drive Shaft	48T	26	23	58	95.5	909.5	
	2002.01-	2006.12			F Hatchback Engine 4ZZ-FE	GCI99038	Inner Joint		23	23	34	60	113	
1.6 VVT-i (81 kW)	2002.01-	2006.12			F Hatchback Engine 3ZZ-FE	GC059037	Outer Joint	48T	26	23	58	95.5	61 M	
	2002.01-	2006.12	MT	R	F Hatchback Engine 3ZZ-FE	GDS59205	Drive Shaft	48T	26	23	58	95.5	909.5	
	2002.01-	2006.12			F Hatchback Engine 3ZZ-FE	GCI99038	Inner Joint		23	23	34	60	113	
1.8 VVTL-i TS (141 kW)	2002.01-	2007.02			F Hatchback Engine 2ZZ-GE	GC059226	Outer Joint	48T	26	25	58	93	63.5 M	
	2002.01-	2007.02			F Hatchback Engine 2ZZ-GE	GC059044	Outer Joint	48T	26	25	63	100	62 M	
2.0 D-4D (66 kW)	2002.01-	2006.12			F Hatchback Engine 1CD-FTV	GC059226	Outer Joint	48T	26	25	58	93	63.5 M	
2.0 D-4D (81 kW)	2002.01-	2006.12			F Hatchback Engine 1CD-FTV	GC059226	Outer Joint	48T	26	25	58	93	63.5 M	
2.0 D-4D (85 kW)	2003.05-	2007.02			F Hatchback Engine 1CD-FTV	GC059226	Outer Joint	48T	26	25	58	93	63.5 M	
<b>COROLLA ( E10_ )</b>														
1.6 Si (84 kW)	1995.09-	1997.04			F Saloon Engine 4A-FE	GC059063	Outer Joint		26	29	56	99.5	62.5 O	
2.0 D (53 kW)	1992.07-	1997.04			F Saloon Engine 2C	GC059018	Outer Joint		26	24	56	95.5	55 I	
<b>COROLLA ( E12J_ , E12T_ )</b>														
1.4 D-4D (66 kW)	2004.07-	2007.07			F Saloon Engine 1ND-TV	GC059226	Outer Joint	48T	26	25	58	93	63.5 M	
1.4 VVT-i (71 kW)	2002.01-	2007.02			F Estate Engine 4ZZ-FE	GC059037	Outer Joint	48T	26	23	58	95.5	61 M	
	2002.01-	2007.02	MT	R	F Estate Engine 4ZZ-FE	GDS59205	Drive Shaft	48T	26	23	58	95.5	909.5	
	2002.08-	2007.07			F Saloon Engine 4ZZ-FE	GC059037	Outer Joint	48T	26	23	58	95.5	61 M	
	2002.08-	2007.07	MT	R	F Saloon Engine 4ZZ-FE	GDS59205	Drive Shaft	48T	26	23	58	95.5	909.5	
1.6 VVT-i (81 kW)	2002.01-	2007.02			F Estate Engine 3ZZ-FE	GC059037	Outer Joint	48T	26	23	58	95.5	61 M	
	2002.01-	2007.02	MT	R	F Estate Engine 3ZZ-FE	GDS59205	Drive Shaft	48T	26	23	58	95.5	909.5	
	2002.08-	2007.07			F Saloon Engine 3ZZ-FE	GC059037	Outer Joint	48T	26	23	58	95.5	61 M	
	2002.08-	2007.07	MT	R	F Saloon Engine 3ZZ-FE	GDS59205	Drive Shaft	48T	26	23	58	95.5	909.5	
2.0 D-4D (66 kW)	2002.01-	2007.02			F Estate Engine 1CD-FTV	GC059226	Outer Joint	48T	26	25	58	93	63.5 M	
	2002.09-	2004.06			F Saloon Engine 1CD-FTV	GC059226	Outer Joint	48T	26	25	58	93	63.5 M	
2.0 D-4D (85 kW)	2004.06-	2007.07			F Saloon Engine 1CD-FTV	GC059226	Outer Joint	48T	26	25	58	93	63.5 M	
<b>COROLLA ( E8_ )</b>														
1.3 (51 kW)	1983.06-	1984.10	MT		F Saloon Engine 2A-L	GC022001	Outer Joint		26	23	56	96.5	55 I	
1.3 (55 kW)	1984.10-	1987.08	MT		F Saloon Engine 2E-L/2E-LC	GC022001	Outer Joint		26	23	56	96.5	55 I	
	1984.10-	1987.08			F Saloon Engine 2E-L/2E-LC	GC059062	Outer Joint		26	24	56	95.5	55 I	
1.6 (53 kW)	1985.08-	1987.08	MT		F Saloon Engine 4A-LC	GC022001	Outer Joint		26	23	56	96.5	55 I	
1.6 (54 kW)	1985.12-	1988.05	MT		F Saloon Engine 4A-LC	GC022001	Outer Joint		26	23	56	96.5	55 I	
1.6 (62 kW)	1983.06-	1987.08	MT		F Saloon Engine 4A-L	GC022001	Outer Joint		26	23	56	96.5	55 I	
1.8 D (43 kW)	1983.06-	1988.05			F Saloon Engine 1C	GC059062	Outer Joint		26	24	56	95.5	55 I	
	1983.06-	1988.05	MT		F Saloon Engine 1C	GC059001	Outer Joint		26	24	56	95.5	55 I	
1.8 D (47 kW)	1985.07-	1988.05			F Saloon Engine 1C-L	GC059062	Outer Joint		26	24	56	95.5	55 I	
	1985.07-	1988.05	MT		F Saloon Engine 1C-L	GC059001	Outer Joint		26	24	56	95.5	55 I	
<b>COROLLA ( E9_ )</b>														
1.3 i (55 kW)	1987.08-	1992.12			F Saloon Engine 2E/2E-E	GC059062	Outer Joint		26	24	56	95.5	55 I	
1.6 (66 kW)	1987.08-	1989.12	AT		F Saloon Engine 4A-F	GC022001	Outer Joint		26	23	56	96.5	55 I	
	1987.08-	1989.12	AT		F Saloon Engine 4A-F	GC059019	Outer Joint	48T	26	24	56	95.5	55 I	
	1987.08-	1989.12			F Saloon Engine 4A-F	GC059062	Outer Joint		26	24	56	95.5	55 I	
	1987.08-	1989.12	MT		F Saloon Engine 4A-F	GC059001	Outer Joint		26	24	56	95.5	55 I	
1.6 4WD (66 kW)	1987.08-	1989.08	MT		Saloon Engine 4A-F	GC059019	Outer Joint	48T	26	24	56	95.5	55 I	
1.8 D (47 kW)	1987.07-	1993.06	MT		F Saloon Engine 1C	GC059019	Outer Joint	48T	26	24	56	95.5	55 I	
	1987.07-	1993.06			F Saloon Engine 1C	GC059062	Outer Joint		26	24	56	95.5	55 I	
	1987.07-	1993.06	MT		F Saloon Engine 1C	GC059001	Outer Joint		26	24	56	95.5	55 I	
1.8 D (49 kW)	1989.11-	1993.06	MT		F Saloon Engine 1C	GC059019	Outer Joint	48T	26	24	56	95.5	55 I	
	1989.11-	1993.06			F Saloon Engine 1C	GC059062	Outer Joint		26	24	56	95.5	55 I	
	1989.11-	1993.06	MT		F Saloon Engine 1C	GC059001	Outer Joint		26	24	56	95.5	55 I	
<b>COROLLA / DX / LE / SR5 (2WD)</b>														
-	1984-	1985			DX,LE,SR5	GCI59009	Inner Joint			24		79		
	1993-	2000				GC059163	Outer Joint	48T	26	29	56	99.5	62.5 O	



		TRANSM	L/R	F/R		G-AP Ref.	PRODUCT	ABS	Technical Specifications						
									YEAR	A	B	C	H	L	P
<b>TOYOTA</b>															
<b>COROLLA / SPRINTER (AE100)</b>															
1.5	1991.06-	1995.05	MT/AT		Engine 5A-FE	GC059337	Outer Joint		26	29	56	96	54	O	
<b>COROLLA / SPRINTER (AE101)</b>															
1.6	1991.06-	1995.05	MT/AT		Engine 4A-FE	GC059337	Outer Joint		26	29	56	96	54	O	
<b>COROLLA / SPRINTER (AE92)</b>															
1.6	1987.05-	1991.06	MT		Engine 4A-GZE	GC059070	Outer Joint		26	26	56	100	63	M	
<b>COROLLA / SPRINTER (CDE120 DSL)</b>															
2	2001-		MT/AT		Engine 1CD-FTV	GC059294	Outer Joint	48T	26	27	63	97	60	M	
<b>COROLLA / SPRINTER VAN / WAGON (AE100G)</b>															
1.5	1991.09-	1995.05	MT/AT		Engine 5A-FE	GC059337	Outer Joint		26	29	56	96	54	O	
<b>COROLLA COMPACT (E10_)</b>															
1.6 Si (84 kW)	1992.07-	1997.04		F	Hatchback Engine 4A-FE	GC059062	Outer Joint		26	24	56	95.5	55	I	
2.0 D (53 kW)	1992.07-	1997.04		F	Hatchback Engine 2C	GC059062	Outer Joint		26	24	56	95.5	55	I	
<b>COROLLA COMPACT (E11_)</b>															
1.4 (71 kW)	2000.02-	2002.01		F	Hatchback Engine 4ZZ-FE	GC059020	Outer Joint		26	23	56	96.5	55	I	
	2000.02-	2002.01		F	Hatchback Engine 4ZZ-FE	GC059021	Outer Joint	48T	26	23	56	96.5	55	I	
1.6 (81 kW)	2000.02-	2002.01	AT	F	Hatchback Engine 3ZZ-FE	GC059020	Outer Joint		26	23	56	96.5	55	I	
	2000.02-	2002.01	AT	F	Hatchback Engine 3ZZ-FE	GC059021	Outer Joint	48T	26	23	56	96.5	55	I	
<b>COROLLA COMPACT (E9_)</b>															
1.3 (55 kW)	1987.08-	1989.12		F	Hatchback Engine 2E	GC059062	Outer Joint		26	24	56	95.5	55	I	
1.6 (66 kW)	1987.08-	1992.04	AT	F	Hatchback Engine 4A-F	GC022001	Outer Joint		26	23	56	96.5	55	I	
	1987.08-	1992.04	AT	F	Hatchback Engine 4A-F	GC059019	Outer Joint	48T	26	24	56	95.5	55	I	
	1987.08-	1992.04		F	Hatchback Engine 4A-F	GC059062	Outer Joint		26	24	56	95.5	55	I	
	1987.08-	1992.04	MT	F	Hatchback Engine 4A-F	GC059001	Outer Joint		26	24	56	95.5	55	I	
1.6 GTi (85 kW)	1987.08-	1992.04	AT	F	Hatchback Engine 4A-GE	GC022001	Outer Joint		26	23	56	96.5	55	I	
	1987.08-	1992.04		F	Hatchback Engine 4A-GE	GC059063	Outer Joint		26	29	56	99.5	62.5	O	
	1987.08-	1992.04	MT	F	Hatchback Engine 4A-GE	GC059019	Outer Joint	48T	26	24	56	95.5	55	I	
	1987.08-	1992.04		F	Hatchback Engine 4A-GE	GC059062	Outer Joint		26	24	56	95.5	55	I	
	1987.08-	1992.04	MT	F	Hatchback Engine 4A-GE	GC059001	Outer Joint		26	24	56	95.5	55	I	
1.6 i (77 kW)	1989.08-	1992.04	AT	F	Hatchback Engine 4A-FE	GC022001	Outer Joint		26	23	56	96.5	55	I	
	1989.08-	1992.04	MT	F	Hatchback Engine 4A-FE	GC059001	Outer Joint		26	24	56	95.5	55	I	
1.8 D (47 kW)	1987.08-	1992.04	MT	F	Hatchback Engine 1C	GC059001	Outer Joint		26	24	56	95.5	55	I	
	1987.08-	1992.04	MT	F	Hatchback Engine 1C	GC059019	Outer Joint	48T	26	24	56	95.5	55	I	
	1987.08-	1992.04		F	Hatchback Engine 1C	GC059062	Outer Joint		26	24	56	95.5	55	I	
1.8 D (49 kW)	1989.08-	1992.04	MT	F	Hatchback Engine 1C	GC059019	Outer Joint	48T	26	24	56	95.5	55	I	
	1989.08-	1992.04		F	Hatchback Engine 1C	GC059062	Outer Joint		26	24	56	95.5	55	I	
	1989.08-	1992.04	MT	F	Hatchback Engine 1C	GC059001	Outer Joint		26	24	56	95.5	55	I	
<b>COROLLA FX</b>															
-	1984-	1987				GCI88016	Inner Joint			23		79			
<b>COROLLA FX COMPACT (E8B)</b>															
1.3 (55 kW)	1985.08-	1987.08	MT	F	Hatchback Engine 2E-L	GC022001	Outer Joint		26	23	56	96.5	55	I	
1.6 GT 16V (89 kW)	1985.08-	1987.08		F	Hatchback Engine 4A-GEL	GC059062	Outer Joint		26	24	56	95.5	55	I	
	1985.08-	1987.08	MT	F	Hatchback Engine 4A-GEL	GC059001	Outer Joint		26	24	56	95.5	55	I	
1.8 D (43 kW)	1985.01-	1988.05		F	Hatchback Engine 1C	GC059062	Outer Joint		26	24	56	95.5	55	I	
	1985.01-	1988.05	MT	F	Hatchback Engine 1C	GC059001	Outer Joint		26	24	56	95.5	55	I	
1.8 D (47 kW)	1985.08-	1987.08		F	Hatchback Engine 1C-L	GC059062	Outer Joint		26	24	56	95.5	55	I	
	1985.08-	1987.08	MT	F	Hatchback Engine 1C-L	GC059001	Outer Joint		26	24	56	95.5	55	I	
<b>COROLLA FX.FX16</b>															
-	1987-	1988		L	FX	GDS88016	Drive Shaft		26	23	56	96.5	599.5		
	1987-	1988		R	FX	GDS88017	Drive Shaft		26	23	56	96.5	910		
	1987-	1988			FX	GCI88015	Inner Joint		23	23	34	61	116		
<b>COROLLA II / TERCEL / CORSA (EL41)</b>															
1.3	1990.09-	1994.09	MT/AT		Engine 4E-FE	GC059023	Outer Joint		26	23	56	96.5	55	I	
<b>COROLLA II / TERCEL / CORSA (EL43)</b>															
1.5	1990.09-	1994.09	MT/AT		Engine 5E-FE/5E-FHE	GC059023	Outer Joint		26	23	56	96.5	55	I	
<b>COROLLA II / TERCEL / CORSA (EL45)</b>															
1.5 4WD	1990.09-	1994.09	MT/AT		Engine 5E-FE	GC059023	Outer Joint		26	23	56	96.5	55	I	
<b>COROLLA II / TERCEL / CORSA (EL51)</b>															
1.3	1991.01-	1994.09	MT/AT		Engine 4A-FE	GC059023	Outer Joint		26	23	56	96.5	55	I	
	1994.09-	1999.08	MT/AT		Engine 4E-FE	GC059023	Outer Joint		26	23	56	96.5	55	I	

		YEAR	TRANSM	L/R	F/R		G-AP Ref.	PRODUCT	ABS	Technical Specifications						
										A	B	C	H	L	P	
<b>TOYOTA</b>																
<b>COROLLA II / TERCEL / CORSA (EL53)</b>																
1.5	1991.01-	1999.08	MT/AT			Engine 5E-FE	GC059023	Outer Joint			26	23	56	96.5	55	I
<b>COROLLA II / TERCEL / CORSA (EL55)</b>																
1.5 4WD	1994.09-	1999.05	MT/AT			Engine 5E-FE	GC059023	Outer Joint			26	23	56	96.5	55	I
<b>COROLLA II / TERCEL / CORSA (NL30)</b>																
1.5	1986.05-	1990.08	AT			Engine 1N-T	GC059023	Outer Joint			26	23	56	96.5	55	I
	1986.05-	1990.08	MT/AT			Engine 1N-T	GC059023	Outer Joint			26	23	56	96.5	55	I
<b>COROLLA II / TERCEL / CORSA (NL40)</b>																
1.5	1990.09-	1994.09	4AT			Engine 1N-T	GC059023	Outer Joint			26	23	56	96.5	55	I
	1990.09-	1994.09	5MT			Engine 1N-T	GC059023	Outer Joint			26	23	56	96.5	55	I
	1990.09-	1994.09	MT			Engine 1N-T	GC059023	Outer Joint			26	23	56	96.5	55	I
<b>COROLLA II / TERCEL / CORSA (NL50)</b>																
1.5	1994.09-	1999.08	4AT			Engine 1N-T	GC059023	Outer Joint			26	23	56	96.5	55	I
	1994.09-	1999.08	5MT			Engine 1N-T	GC059023	Outer Joint			26	23	56	96.5	55	I
<b>COROLLA III (E8)</b>																
1.3 (51 kW)	1983.06-	1987.08	MT				GC022001	Outer Joint			26	23	56	96.5	55	I
1.3 (55 kW)	1983.06-	1987.08	MT				GC022001	Outer Joint			26	23	56	96.5	55	I
1.3 (68 kW)	1983.06-	1987.08	MT				GC022001	Outer Joint			26	23	56	96.5	55	I
1.6 (62 kW)	1983.06-	1988.05	AT				GC022001	Outer Joint			26	23	56	96.5	55	I
1.6 (63 kW)	1983.06-	1988.05	AT				GC022001	Outer Joint			26	23	56	96.5	55	I
1.6 (AE82), Compact FX (53 kW)	1985-					LiftB	GC021001	Outer Joint			26	29	56	96	62	O
1.6 16V Compact FX (85 kW)	1985-	1987	AT				GC022001	Outer Joint			26	23	56	96.5	55	I
1.6 16V Compact FX (89 kW)	1985-	1987	AT				GC022001	Outer Joint			26	23	56	96.5	55	I
1.6 16V Compact FX (91 kW)	1985-	1987	AT				GC022001	Outer Joint			26	23	56	96.5	55	I
1.6 Compact FX (55 kW)	1983-	1987	AT				GC022001	Outer Joint			26	23	56	96.5	55	I
	1987-	1989	MT/AT				GC021001	Outer Joint			26	29	56	96	62	O
1.6 Compact FX (85 kW)	1983-	1987	AT				GC022001	Outer Joint			26	23	56	96.5	55	I
1.6 Compact FX (89 kW)	1983-	1987	AT				GC022001	Outer Joint			26	23	56	96.5	55	I
1.6 Compact FX (91 kW)	1983-	1987	AT				GC022001	Outer Joint			26	23	56	96.5	55	I
1.6 GT 16V Coupe (57 kW)	1983-					USA	GC022001	Outer Joint			26	23	56	96.5	55	I
1.6 GT 16V Coupe (89 kW)	1983-					USA	GC022001	Outer Joint			26	23	56	96.5	55	I
1.6 GT 16V Coupe (91 kW)	1983-	1987	AT				GC022001	Outer Joint			26	23	56	96.5	55	I
<b>COROLLA IV (E9), SW, COMPACT</b>																
1.6 16V (66 kW)	1987-	1992.04	AT				GC022001	Outer Joint			26	23	56	96.5	55	I
1.6 16V (70 kW)	1987-	1992.04	AT				GC022001	Outer Joint			26	23	56	96.5	55	I
1.6 GTi (85 kW)	1987-	1993	AT				GC022001	Outer Joint			26	23	56	96.5	55	I
1.6 GTi (92 kW)	1987-	1993	AT				GC022001	Outer Joint			26	23	56	96.5	55	I
1.6 i 4WD (74 kW)	1987-	1990.03					GC022001	Outer Joint			26	23	56	96.5	55	I
1.6 i 4WD (78 kW)	1987-	1990.03					GC022001	Outer Joint			26	23	56	96.5	55	I
1.6 i 4WD (81 kW)	1987-	1990.03					GC022001	Outer Joint			26	23	56	96.5	55	I
<b>COROLLA IV (E9), SW, COMPACT, LIFTBACK</b>																
1.6 GTi (AE92) (Exc. SW) (85-92 kW)	1987-	1993	MT/AT				GC021001	Outer Joint			26	29	56	96	62	O
<b>COROLLA LIFTBACK ( E10 )</b>																
1.6 GLi (84 kW)	1992.07-	1997.04			F	Hatchback Engine 4A-FE	GC059062	Outer Joint			26	24	56	95.5	55	I
2.0 D (53 kW)	1992.07-	1997.04			F	Hatchback Engine 2C	GC059062	Outer Joint			26	24	56	95.5	55	I
<b>COROLLA LIFTBACK ( E11 )</b>																
1.4 (71 kW)	2000.02-	2002.01			F	Hatchback Engine 4ZZ-FE	GC059020	Outer Joint			26	23	56	96.5	55	I
	2000.02-	2002.01			F	Hatchback Engine 4ZZ-FE	GC059021	Outer Joint	48T		26	23	56	96.5	55	I
1.6 (81 kW)	2000.02-	2002.01	AT		F	Hatchback Engine 3ZZ-FE	GC059020	Outer Joint			26	23	56	96.5	55	I
	2000.02-	2002.01	AT		F	Hatchback Engine 3ZZ-FE	GC059021	Outer Joint	48T		26	23	56	96.5	55	I
<b>COROLLA LIFTBACK ( E8 )</b>																
1.3 (51 kW)	1983.06-	1984.09	MT		F	Hatchback Engine 2A-L	GC022001	Outer Joint			26	23	56	96.5	55	I
1.3 (55 kW)	1985.01-	1987.08			F	Hatchback Engine 2E-L/2E-LC	GC059062	Outer Joint			26	24	56	95.5	55	I
	1985.01-	1987.08	MT		F	Hatchback Engine 2E-L/2E-LC	GC022001	Outer Joint			26	23	56	96.5	55	I
1.6 (54 kW)	1985.08-	1987.08	MT		F	Hatchback Engine 4A-LC	GC022001	Outer Joint			26	23	56	96.5	55	I
1.6 (62 kW)	1983.06-	1987.08			F	Hatchback Engine 4A-L	GC059062	Outer Joint			26	24	56	95.5	55	I
	1983.06-	1987.08	MT		F	Hatchback Engine 4A-L	GC022001	Outer Joint			26	23	56	96.5	55	I
1.6 (63 kW)	1985.07-	1988.05			F	Hatchback Engine 4A-L	GC059062	Outer Joint			26	24	56	95.5	55	I
	1985.07-	1988.05	MT		F	Hatchback Engine 4A-L	GC022001	Outer Joint			26	23	56	96.5	55	I
1.8 D (43 kW)	1983.06-	1988.05			F	Hatchback Engine 1C	GC059062	Outer Joint			26	24	56	95.5	55	I
	1983.06-	1988.05	MT		F	Hatchback Engine 1C	GC059001	Outer Joint			26	24	56	95.5	55	I
1.8 D (47 kW)	1983.06-	1987.08			F	Hatchback Engine 1C-L	GC059062	Outer Joint			26	24	56	95.5	55	I









		TRANSM	L/R	F/R		G-AP Ref.	PRODUCT	ABS	Technical Specifications															
									YEAR	A	B	C	H	L	P									
<b>TOYOTA</b>																								
<b>COROLLA LIFTBACK ( _E8_ )</b>																								
1.8 D (47 kW)	1983.06-	1987.08	MT		F	Hatchback Engine 1C-L	GC059001	Outer Joint		26	24	56	95.5	55	I									
<b>COROLLA LIFTBACK ( _E9_ )</b>																								
1.3 i (55 kW)	1987.08-	1992.04			F	Hatchback Engine 2E/2E-E	GC059062	Outer Joint		26	24	56	95.5	55	I									
1.6 (66 kW)	1987.08-	1992.04	AT		F	Hatchback Engine 4A-F	GC059019	Outer Joint	48T	26	24	56	95.5	55	I									
	1987.08-	1992.04			F	Hatchback Engine 4A-F	GC059062	Outer Joint		26	24	56	95.5	55	I									
	1987.08-	1992.04	MT		F	Hatchback Engine 4A-F	GC059001	Outer Joint		26	24	56	95.5	55	I									
	1987.08-	1992.04	AT		F	Hatchback Engine 4A-F	GC022001	Outer Joint		26	23	56	96.5	55	I									
1.6 (77 kW)	1989.08-	1992.04	MT		F	Hatchback Engine 4A-FE	GC059001	Outer Joint		26	24	56	95.5	55	I									
	1989.08-	1992.04	AT		F	Hatchback Engine 4A-FE	GC022001	Outer Joint		26	23	56	96.5	55	I									
1.6 4WD (66 kW)	1987.08-	1989.08	MT			Hatchback Engine 4A-F	GC059019	Outer Joint	48T	26	24	56	95.5	55	I									
1.6 GTi (92 kW)	1987.07-	1993.06			F	Hatchback Engine 4A-GE	GC059063	Outer Joint		26	29	56	99.5	62.5	O									
	1987.07-	1993.06	MT		F	Hatchback Engine 4A-GE	GC059019	Outer Joint	48T	26	24	56	95.5	55	I									
	1987.07-	1993.06			F	Hatchback Engine 4A-GE	GC059062	Outer Joint		26	24	56	95.5	55	I									
1.8 D (47 kW)	1987.08-	1992.04	MT		F	Hatchback Engine 1C	GC059019	Outer Joint	48T	26	24	56	95.5	55	I									
	1987.08-	1992.04			F	Hatchback Engine 1C	GC059062	Outer Joint		26	24	56	95.5	55	I									
	1987.08-	1992.04	MT		F	Hatchback Engine 1C	GC059001	Outer Joint		26	24	56	95.5	55	I									
1.8 D (49 kW)	1989.08-	1992.04	MT		F	Hatchback Engine 1C	GC059019	Outer Joint	48T	26	24	56	95.5	55	I									
	1989.08-	1992.04			F	Hatchback Engine 1C	GC059062	Outer Joint		26	24	56	95.5	55	I									
	1989.08-	1992.04	MT		F	Hatchback Engine 1C	GC059001	Outer Joint		26	24	56	95.5	55	I									
<b>COROLLA RUNX / ALLEX (NZE121)</b>																								
1.5	2001.01-		4AT			Engine 1NZ-FE	GC059036	Outer Joint		26	23	58	96	52.5	I									
<b>COROLLA RUNX / ALLEX (NZE124)</b>																								
1.5 4WD	2001.01-		4AT			Engine 1NZ-FE	GC059036	Outer Joint		26	23	58	96	52.5	I									
<b>COROLLA RUNX / ALLEX (ZZE123)</b>																								
1.8	2001.01-		4AT			Engine 2ZZ-GE	GC059047	Outer Joint		26	24	58	96	52.5	I									
	2001.01-		6MT			Engine 2ZZ-GE	GC059047	Outer Joint		26	24	58	96	52.5	I									
<b>COROLLA SR5</b>																								
-	1988-	1992			L	2WD	GDS88016	Drive Shaft		26	23	56	96.5	599.5										
	1988-	1992			R	2WD	GDS88017	Drive Shaft		26	23	56	96.5	910										
	1988-	1992				2WD	GCI88015	Inner Joint		23	23	34	61	116										
<b>COROLLA STATION WAGON ( _E9_ )</b>																								
1.3 (55 kW)	1987.12-	1992.06			F	Estate Engine 2E	GC059062	Outer Joint		26	24	56	95.5	55	I									
1.3 i (55 kW)	1989.06-	1992.06			F	Estate Engine 2E-E	GC059062	Outer Joint		26	24	56	95.5	55	I									
1.6 (66 kW)	1988.02-	1992.05	AT		F	Estate Engine 4A-F	GC059019	Outer Joint	48T	26	24	56	95.5	55	I									
	1988.02-	1992.05			F	Estate Engine 4A-F	GC059062	Outer Joint		26	24	56	95.5	55	I									
1.6 (70 kW)	1987.12-	1992.04	AT		F	Estate Engine 4A-F	GC059019	Outer Joint	48T	26	24	56	95.5	55	I									
	1987.12-	1992.04			F	Estate Engine 4A-F	GC059062	Outer Joint		26	24	56	95.5	55	I									
	1987.12-	1992.04	AT		F	Estate Engine 4A-F	GC022001	Outer Joint		26	23	56	96.5	55	I									
1.8 D (47 kW)	1987.12-	1992.06	MT		F	Estate Engine 1C	GC059019	Outer Joint	48T	26	24	56	95.5	55	I									
	1987.12-	1992.06			F	Estate Engine 1C	GC059062	Outer Joint		26	24	56	95.5	55	I									
	1987.12-	1992.06	MT		F	Estate Engine 1C	GC059001	Outer Joint		26	24	56	95.5	55	I									
1.8 D (49 kW)	1989.08-	1992.06	MT		F	Estate Engine 1C	GC059019	Outer Joint	48T	26	24	56	95.5	55	I									
	1989.08-	1992.06			F	Estate Engine 1C	GC059062	Outer Joint		26	24	56	95.5	55	I									
	1989.08-	1992.06	MT		F	Estate Engine 1C	GC059001	Outer Joint		26	24	56	95.5	55	I									
<b>COROLLA VERSO (ZDE12_ , CDE12_)</b>																								
1.8 VVT-i (99 kW)	2002.01-	2004.05			F	MPV Engine 1ZZ-FE	GC059131	Outer Joint	48T	26	24	58	96	54	I									
2.0 D-4D (66 kW)	2002.01-	2004.05			L	F	MPV Engine 1CD-FTV	GCI59073	Inner Joint		24	27	50	67	110									
	2002.01-	2004.05			R	F	MPV Engine 1CD-FTV	GCI59078	Inner Joint		24	27	40	370	105									
<b>COROLLA VERSO (ZER_ , ZZE_ , R1_)</b>																								
1.6 (81 kW)	2004.05-	2007.08			R	F	MPV Engine 3ZZ-FE	GDS59531	Drive Shaft	48T	26	20	63	95.5	924									
	2004.05-	2007.08				F	MPV Engine 3ZZ-FE	GCI99038	Inner Joint		23	23	34	60	113									
1.8 (95 kW)	2004.05-	2007.08	MT/AT		R	F	MPV Engine 1ZZ-FE	GDS59531	Drive Shaft	48T	26	20	63	95.5	924									
	2004.05-	2007.08			F	MPV Engine 1ZZ-FE	GCI99038	Inner Joint		23	23	34	60	113										
2.0 D-4D (85 kW)	2004.05-	2007.08			L		MPV Engine 1ZZ-FE	GDS59505	Drive Shaft	48T	26	20	63	95.5	650									
	2004.05-	2005.11	MT		R	F	MPV Engine 1CD-FTV	GDS59114	Drive Shaft	48T	26	24	63	100	948									
2.2 D-4D (100 kW)	2004.05-	2005.11					MPV Engine 1CD-FTV	GC059317	Outer Joint	48T	26	26	63	96	65	M								
	2005.11-	2007.08	MT	L	F	MPV Engine 2AD-FTV	GDS59445	Drive Shaft	48T	30	24	63	99	600										
	2005.11-	2007.08	MT	R	F	MPV Engine 2AD-FTV	GDS59446	Drive Shaft	48T	30	24	63	99	976										
	2005.11-	2007.08					MPV Engine 2AD-FTV	GC059233	Outer Joint	48T	30	36	63	99	67	I								
2.2 D-4D (130 kW)	2005.11-	2007.08	MT	L	F	MPV Engine 2AD-FHV	GDS59445	Drive Shaft	48T	30	24	63	99	600										
	2005.11-	2007.08	MT	R	F	MPV Engine 2AD-FHV	GDS59446	Drive Shaft	48T	30	24	63	99	976										



		TRANSM	L/R	F/R		G-AP Ref.	PRODUCT	ABS	Technical Specifications					
									YEAR	A	B	C	H	L
<b>TOYOTA</b>														
<b>COROLLA VERSO (ZER, ZZE, R1)</b>														
2.2 D-4D (130 kW)	2005.11-	2007.08			MPV Engine 2AD-FHV	GC059233	Outer Joint	48T	30	36	63	99	67	I
<b>COROLLA WAGON (_E10_)</b>														
1.6 Si (84 kW)	1992.07-	1997.04		F	Estate Engine 4A-FE	GC059062	Outer Joint		26	24	56	95.5	55	I
2.0 D (53 kW)	1992.07-	1997.04		F	Estate Engine 2C	GC059062	Outer Joint		26	24	56	95.5	55	I
<b>CORONA</b>														
-	1987-					GC099111	Outer Joint		26	24	56	95.5	55	I
	1993-					GCI59004	Inner Joint		20	23	35	363	100.5	
<b>CORONA / CARINA (AT175)</b>														
1.6 4WD	1988.08-	1992.08	MT		Engine 4A-FE	GC059011	Outer Joint		26	27	56	100	63	M
<b>CORONA / CARINA (AT210)</b>														
1.6	1996.01-	2002.01	MT/AT		Engine 4A-FE	GC059006	Outer Joint	48T	26	23	56	95.5	55	I
<b>CORONA / CARINA (AT211)</b>														
1.8	1996.01-	2002.01	MT/AT		Engine 7A-FE	GC059006	Outer Joint	48T	26	23	56	95.5	55	I
<b>CORONA / CARINA (AT212)</b>														
1.5	1996.08-	2002.01	MT/AT		Engine 5A-FE	GC059006	Outer Joint	48T	26	23	56	95.5	55	I
<b>CORONA / CARINA (ST162)</b>														
2	1985.01-	1988.01	MT&AT		Engine 3S-GE	GC059003	Outer Joint		26	25	56	95.6	61	M
	1985.08-	1989.08	MT&AT		Engine 3S-GELU	GC059003	Outer Joint		26	25	56	95.6	61	M
<b>CORONA / CARINA (ST171)</b>														
2	1985.01-	1988.01	MT&AT		Engine 3S-GELU	GC059003	Outer Joint		26	25	56	95.6	61	M
	1987.12-	1989.08	MT&AT		Engine 3S-GE	GC059003	Outer Joint		26	25	56	95.6	61	M
<b>CORONA / CARINA (ST182)</b>														
2	1989.01-	1996.08	MT		Engine 3F-FE	GC059011	Outer Joint		26	27	56	100	63	M
<b>CORONA / CARINA (ST183)</b>														
2	1989.01-	1996.01	MT		Engine 3F-FE	GC059011	Outer Joint		26	27	56	100	63	M
<b>CORONA / CARINA (ST210)</b>														
2	1996.12-	2002.01	4AT		Engine 3S-FSE	GC059012	Outer Joint	48T	26	27	56	100	63	M
<b>CORONA II</b>														
1.6 (55 kW)	1983.08-	1988			Mod. AE80. 81	GC022001	Outer Joint		26	23	56	96.5	55	I
1.8 D (43 kW)	1982.01-	1684.01			Mod. AE80. 81	GC022001	Outer Joint		26	23	56	96.5	55	I
1.8 D (48 kW)	1982.01-	1684.01			Mod. AE80. 81	GC022001	Outer Joint		26	23	56	96.5	55	I
<b>CROWN MAJESTA (UZS155, JZS153, JZS157)</b>														
- 4WD	1995-	2001				GC059370	Outer Joint	48T	30	30	56	92	59	I
<b>CURREN (ST206)</b>														
2	1994.01-	1998.07	MT/AT		Engine 3S-FE	GC059011	Outer Joint		26	27	56	100	63	M
	1994.01-	1998.07	MT/AT		Engine 3S-GE	GC059003	Outer Joint		26	25	56	95.6	61	M
<b>CURREN (ST207)</b>														
2.0 4WS	1994.01-	1997.12	MT/AT		Engine 3S-FE	GC059011	Outer Joint		26	27	56	100	63	M
<b>CYNOS (EL44)</b>														
1.5	1991.02-	1995.09	MT/AT		Engine 5E-FE FHE	GC059023	Outer Joint		26	23	56	96.5	55	I
<b>CYNOS (EL52)</b>														
1.3	1991.01-	1995.09	MT/AT		Engine 4E-FE	GC059023	Outer Joint		26	23	56	96.5	55	I
<b>CYNOS (EL54)</b>														
1.5	1991.01-	1995.09	MT/AT		Engine 5E-FE	GC059023	Outer Joint		26	23	56	96.5	55	I
<b>ESTIMA</b>														
-				L	MCR 30	GDS59162	Drive Shaft	48T	30	24	63	100.5	655	
				R	MCR 30	GDS59161	Drive Shaft	48T	30	24	63	100.5	975	
2.2	1992-		MT/AT			GC059166	Outer Joint	48T	26	27	56	96	67.5	I
2.4						GCI59022	Inner Joint		24	27	50	67	104	
						GCI59027	Inner Joint		24	27	40	369	99.5	
				L		GDS59051	Drive Shaft	48T	26	24	63	100	662	
				R		GDS59064	Drive Shaft	48T	26	24	63	100	961	
<b>ESTIMA (ACR50)</b>														
-	2006-					GC059245	Outer Joint		26	27	61.2	100	59	I
<b>ESTIMA (ACR55)</b>														
-4WD	2006-					GC059245	Outer Joint		26	27	61.2	100	59	I
<b>ESTIMA (CR50W)</b>														
2.4	2006.01-		CVT		Engine 2AR-FE	GC059383	Outer Joint		26	27	61.2	100	59.2	M
	2006.01-		CVT		Engine 2AZ-FE	GC059383	Outer Joint		26	27	61.2	100	59.2	M

		YEAR	TRANSM	L/R	F/R		G-AP Ref.	PRODUCT	ABS	Technical Specifications										
										A	B	C	H	L	P					
<b>TOYOTA</b>																				
<b>ESTIMA (CR55W)</b>																				
2.4 4WD	2006.01-		CVT			Engine 2AZ-FE	GC059383	Outer Joint			26	27	61.2	100	59.2					M
<b>ESTIMA (CXR20G)</b>																				
2.2	1992-		MT/AT			Engine 3C-T 4WD	GC059073	Outer Joint			26	27	56	96	67.5					I
<b>ESTIMA (SR50W)</b>																				
3.5	2006.01-		6AT/I			Engine 2GR-FE	GC059321	Outer Joint			30	27	61.2	100	64.5					M
<b>ESTIMA (SR55W)</b>																				
3.5	2006.01-		6AT/I			Engine 2GR-FE	GC059321	Outer Joint			30	27	61.2	100	64.5					M
3.5 4WD	2006.01-		6AT/I			Engine 2GR-FE	GC059321	Outer Joint			30	27	61.2	100	64.5					M
<b>ESTIMA PREVIA (MCR30W)</b>																				
3	1999.12-					Engine 1MZ-FE	GC059253	Outer Joint	48T		30	34	61	100	67					I
	1999.12-					Engine 1MZ-FE	GC059254	Outer Joint	48T		30	27	63	100.5	64.5					I
	1999.12-	2001.05	4AT			Engine 1MZ-FE	GC059201	Outer Joint	48T		26	27	56	98	63					M
<b>ESTIMA PREVIA (MCR40W)</b>																				
3	1999.12-	2001.05	4AT			Engine 1MZ-FE	GC059201	Outer Joint	48T		26	27	56	98	63					M
3.0 4WD	1999.12-		4AT			Engine 1MZ-FE	GC059253	Outer Joint	48T		30	34	61	100	67					I
	1999.12-		4AT			Engine 1MZ-FE	GC059254	Outer Joint	48T		30	27	63	100.5	64.5					I
<b>ESTIMA PREVIA (TCR20)</b>																				
2.4 4WD	1993.02-	1999.12	AT			Engine 2TZ-FE	GC059089	Outer Joint			26	27	56	98	63					M
	1993.02-	1999.12	AT			Engine 2TZ-FE	GC059201	Outer Joint	48T		26	27	56	98	63					M
<b>ESTIMA PREVIA (TCR21)</b>																				
2.4 4WD	1990.05-	1999.12	AT			Engine 2TZ-FE	GC059089	Outer Joint			26	27	56	98	63					M
	1990.05-	1999.12	AT			Engine 2TZ-FE	GC059201	Outer Joint	48T		26	27	56	98	63					M
<b>EXIV ED (ST182)</b>																				
2	1989.09-	1993.08	MT/AT			Engine 3S-FE	GC059011	Outer Joint			26	27	56	100	63					M
	1989.09-	1993.08	MT&AT			Engine 3S-GE	GC059003	Outer Joint			26	25	56	95.6	61					M
<b>EXIV ED (ST183)</b>																				
2.0 4WS	1989.09-	1993.09	MT/AT			Engine 3S-FE	GC059011	Outer Joint			26	27	56	100	63					M
	1989.09-	1993.08	MT&AT			Engine 3S-GE	GC059003	Outer Joint			26	25	56	95.6	61					M
<b>EXIV ED (ST202)</b>																				
2	1993.09-	1995.08	MT/AT			Engine 3S-FE	GC059011	Outer Joint			26	27	56	100	63					M
	1993.09-	1995.08	MT/AT			Engine 3S-GE	GC059003	Outer Joint			26	25	56	95.6	61					M
<b>EXIV ED (ST203)</b>																				
2.0 4WS	1993.09-	1995.08	MT/AT			Engine 3S-FE	GC059011	Outer Joint			26	27	56	100	63					M
<b>GEO</b>																				
-	1992-	1999					GCI19001	Inner Joint			23	29	34	58.5	128.5					
<b>GRAND HIACE (KCH16W)</b>																				
3.0 4WD	1999.07-	2002.04	4AT/C			Engine 1KZ-TE	GC059016	Outer Joint			26	27	60	162	65.5					M
<b>GRANVIA (KCH16W)</b>																				
3.0 4WD	1997.08-	2002.04	4AT/C			Engine 1KZ-TE	GC059016	Outer Joint			26	27	60	162	65.5					M
<b>GRANVIA (VCH16W)</b>																				
3.4 4WD	1997.08-	2002.04	4AT/C			Engine 5VZ-FE	GC059016	Outer Joint			26	27	60	162	65.5					M
<b>HARRIER</b>																				
2.2	1998-	2003		L			GDS59021	Drive Shaft	48T		26	24	56	99	663					
	1998-	2003		R			GDS59022	Drive Shaft	48T		26	24	56	99	957					
<b>HARRIER (ACU30W)</b>																				
2.4	2003.02-		4AT/F			Engine 2AZ-FE	GC059175	Outer Joint	48T		26	27	63.3	100	59					M
<b>HARRIER (ACU35W)</b>																				
2.4 4WD	2003.02-		4AT/F			Engine 2AZ-FE	GC059175	Outer Joint	48T		26	27	63.3	100	59					M
<b>HARRIER (CU10W)</b>																				
2.4	2000.11-	2003.02	4AT/I			Engine 2AZ-FE	GC059320	Outer Joint	48T		26	25	56	100	63					M
3	1999.04-	2003.02	4AT/I			Engine 1MZ-FE	GC059173	Outer Joint	48T		30	27	63.4	100	64.5					M
<b>HARRIER (CU15W)</b>																				
2.4 4WD	2000.11-	2003.02	4AT/I			Engine 2AZ-FE	GC059320	Outer Joint	48T		26	25	56	100	63					M
3.0 4WD	1999.04-	2003.02	4AT/I			Engine 1MZ-FE	GC059320	Outer Joint	48T		26	25	56	100	63					M
<b>HARRIER (HU38W)</b>																				
3.3 4WD	2005.03-		CVT/F			Engine 3MZ-FE	GC059304	Outer Joint	48T		30	34	61	100	68.5					M
<b>HARRIER (MCU30W)</b>																				
3	2003.02-		5AT/F			Engine 1MZ-FE	GC059154	Outer Joint	48T		30	27	63.4	100	64.5					M
<b>HARRIER (MCU31W)</b>																				
3	2003.02-		5AT/F			Engine 1MZ-FE	GC059154	Outer Joint	48T		30	27	63.4	100	64.5					M









		YEAR	TRANSM	L/R	F/R		G-AP Ref.	PRODUCT	ABS	Technical Specifications										
										A	B	C	H	L	P					
<b>TOYOTA</b>																				
<b>HARRIER (MCU35W)</b>																				
3.0 4WD	2003.02-		5AT/F			Engine 1MZ-FE	GC059175	Outer Joint	48T	26	27	63.3	100	59	M					
<b>HARRIER (MCU36W)</b>																				
3.0 4WD	2003.02-		5AT/F			Engine 1MZ-FE	GC059175	Outer Joint	48T	26	27	63.3	100	59	M					
<b>HARRIER (SU30W/SU31W)</b>																				
3.5	2007.01-	2008.12	5AT/F			Engine 2GR --FE	GC059304	Outer Joint	48T	30	34	61	100	68.5	M					
<b>HARRIER (SU35W/SU36W)</b>																				
3.5 4WD	2007.01-	2008.12	5AT/F			Engine 2GR --FE	GC059305	Outer Joint	48T	30	26	61	100	68.5	M					
<b>HIACE IV (LH1_)</b>																				
2.5 D-4D (65 kW)	2001.11-	2006.08		L/R	R	Box Engine 2KD-FTV	GC075002	Outer Joint	48T	30	24	63	108.5	74	I					
	2001.11-	2006.08		L/R	R	Bus Engine 2KD-FTV	GC075002	Outer Joint	48T	30	24	63	108.5	74	I					
2.5 D-4D (70 kW)	2006.08-			L/R	R	Bus Engine 2KD-FTV	GC075002	Outer Joint	48T	30	24	63	108.5	74	I					
2.5 D-4D (75 kW)	2001.11-	2006.08		L/R	R	Box Engine 2KD-FTV	GC075002	Outer Joint	48T	30	24	63	108.5	74	I					
	2001.11-	2006.08		L/R	R	Bus Engine 2KD-FTV	GC075002	Outer Joint	48T	30	24	63	108.5	74	I					
2.5 D-4D (86 kW)	2006.08-			L/R	R	Bus Engine 2KD-FTV	GC075002	Outer Joint	48T	30	24	63	108.5	74	I					
	2006.09-			L/R	R	Box Engine 2KD-FTV	GC075002	Outer Joint	48T	30	24	63	108.5	74	I					
2.5 D-4D 4WD (75 kW)	2001.11-	2006.08				Box Engine 2KD-FTV	GC059243	Outer Joint		30	27	69	121	65	I					
	2001.11-	2006.08		L/R	R	Box Engine 2KD-FTV	GC075002	Outer Joint	48T	30	24	63	108.5	74	I					
	2001.11-	2006.08		L/R	R	Bus Engine 2KD-FTV	GC075002	Outer Joint	48T	30	24	63	108.5	74	I					
2.5 D-4D 4WD (86 kW)	2006.09-			L/R	R	Box Engine 2KD-FTV	GC075002	Outer Joint	48T	30	24	63	108.5	74	I					
	2006.10-			L/R	R	Bus Engine 2KD-FTV	GC075002	Outer Joint	48T	30	24	63	108.5	74	I					
2.7 (105 kW)	1998.04-	2006.08		L/R	R	Box Engine 3RZ-FE	GC075002	Outer Joint	48T	30	24	63	108.5	74	I					
	1998.04-	2001.11		L/R	R	Bus Engine 3RZ-FE	GC075002	Outer Joint	48T	30	24	63	108.5	74	I					
<b>HIACE IV (TRH2_, KDH2_)</b>																				
2.5 D-4D (70 kW)	2006.09-			L/R	R	Box Engine 2KD-FTV	GC075002	Outer Joint	48T	30	24	63	108.5	74	I					
2.5 D-4D (86 kW)	2006.09-			L/R	R	Box Engine 2KD-FTV	GC075002	Outer Joint	48T	30	24	63	108.5	74	I					
<b>HILUX</b>																				
-						4WD	GC059092	Outer Joint		26	34	60	162	65.5	I					
	2005-						GC059199	Outer Joint		30	29	72.5	116	73	M					
<b>HILUX (MALAYSIA (KDN165))</b>																				
2.5 4WD	2003.01-		MT			Engine 2KD	GC059016	Outer Joint		26	27	60	162	65.5	M					
<b>HILUX II (RN6_, RN5_, LN6_, YN6_, YN5_, LN5_)</b>																				
2.4 D (55 kW)	1998.07-	2002.01	5MT	L/R	F	Pickup Engine 2L	GDS59036	Drive Shaft		26		60	162	532.5						
2.4 D (58 kW)	1995.03-	2005.07	MT		R	Pickup Engine 2L	GC059007	Outer Joint		30	27	62	178	63	I					
2.4 D (59 kW)	1992.01-	2005.07	MT		R	Pickup Engine 2L	GC059007	Outer Joint		30	27	62	178	63	I					
	1992.01-	2005.07	MT		R	Pickup Engine 2L	GC059050	Outer Joint		30	27	55.5	178	61	I					
2.4 D (61 kW)	1988.08-	2005.07		L/R	F	Pickup Engine 2L	GDS59036	Drive Shaft		26		60	162	532.5						
	1988.08-	2005.07	MT		R	Pickup Engine 2L	GC059007	Outer Joint		30	27	62	178	63	I					
	1988.08-	2005.07	MT		R	Pickup Engine 2L	GC059050	Outer Joint		30	27	55.5	178	61	I					
2.4 D 4WD (58 kW)	1994.01-	2005.07	MT		F	Pickup Engine 2L	GC059007	Outer Joint		30	27	62	178	63	I					
	1994.01-	2005.07	MT		F	Pickup Engine 2L	GC059050	Outer Joint		30	27	55.5	178	61	I					
2.4 D 4WD (61 kW)	1988.08-	2005.07	MT			Pickup Engine 2L	GC059007	Outer Joint		30	27	62	178	63	I					
	1988.08-	2005.07			F	Pickup Engine 2L	GC059015	Outer Joint		26	27	60	162	65.5	I					
	1988.08-	2005.07	MT		F	Pickup Engine 2L	GC059050	Outer Joint		30	27	55.5	178	61	I					
	1988.08-	2005.07		L/R	F	Pickup Engine 2L	GDS59036	Drive Shaft		26		60	162	532.5						
2.4 i 4WD (103 kW)	1997.08-	2005.07			F	Pickup Engine 2RZ-FE	GC059015	Outer Joint		26	27	60	162	65.5	I					
2.4 i 4WD (84 kW)	1989.06-	2005.07			F	Pickup Engine 22R	GC059015	Outer Joint		26	27	60	162	65.5	I					
	1989.06-	2005.07			F	Pickup Engine 22RE	GC059015	Outer Joint		26	27	60	162	65.5	I					
2.4 TD 4WD (66 kW)	1998.08-	2002.01			F	Pickup Engine 2L-T	GC059015	Outer Joint		26	27	60	162	65.5	I					
2.5 D-4D (65 kW)	2001.11-	2005.07			R	Pickup Engine 2KD-FTV	GC059242	Outer Joint		30	29	72.7	116	70	M					
2.5 D-4D 4WD (75 kW)	2001.11-	2005.07				Pickup Engine 2KD-FTV	GC059242	Outer Joint		30	29	72.7	116	70	M					
2.7 (107 kW)	2001.08-	2004.07			R	Pickup Engine 3RZ-FE	GC059243	Outer Joint		30	27	69	121	65	I					
3.0 D (67 kW)	2002.01-	2005.02			R	Pickup Engine 5L	GC059243	Outer Joint		30	27	69	121	65	I					
3.0 D 4WD (67 kW)	2002.01-	2005.07				Pickup Engine 5L	GC059243	Outer Joint		30	27	69	121	65	I					
<b>HILUX III (TGN1_, GGN2_, GGN1_, KUN2_, KUN1_)</b>																				
2.5 D 4WD (75 kW)	2005.08-					Pickup Engine 2KD-FTV	GC059199	Outer Joint		30	29	72.5	116	73	M					
	2005.08-					Pickup Engine 2KD-FTV	GC059242	Outer Joint		30	29	72.7	116	70	M					
	2005.08-			L/R		Pickup Engine 2KD-FTV	GDS59168	Drive Shaft		30	30	72.5	116	630						
2.5 D-4D (75 kW)	2006.06-				R	Pickup Engine 2KD-FTV	GC059242	Outer Joint		30	29	72.7	116	70	M					
2.5 D-4D (88 kW)	2007.12-				R	Pickup Engine 2KD-FTV	GC059242	Outer Joint		30	29	72.7	116	70	M					
2.5 D-4D 4WD (106 kW)	2007.12-					Pickup Engine 2KD-FTV	GC059199	Outer Joint		30	29	72.5	116	73	M					
2.5 D-4D 4WD (88 kW)	2007.12-					Pickup Engine 2KD-FTV	GC059199	Outer Joint		30	29	72.5	116	73	M					



		YEAR	TRANSM	L/R	F/R		G-AP Ref.	PRODUCT	ABS	Technical Specifications						
										A	B	C	H	L	P	
<b>TOYOTA</b>																
<b>HILUX III (TGN1_, GGN2_, GGN1_, KUN2_, KUN1_)</b>																
2.5 D-4D 4WD (88 kW)	2007.12-					Pickup Engine 2KD-FTV	GC059242	Outer Joint			30	29	72.7	116	70	M
	2007.12-			L/R		Pickup Engine 2KD-FTV	GDS59168	Drive Shaft			30	30	72.5	116	630	
3.0 D-4D 4WD (126 kW)	2007.12-					Pickup Engine 1KD-FTV	GC059199	Outer Joint			30	29	72.5	116	73	M
	2007.12-					Pickup Engine 1KD-FTV	GC059242	Outer Joint			30	29	72.7	116	70	M
	2007.12-			L/R		Pickup Engine 1KD-FTV	GDS59168	Drive Shaft			30	30	72.5	116	630	
<b>HILUX PICK UP</b>																
-	2000.01-	2006.12	MT	L/R		4WD	GDS59219	Drive Shaft			26		60	162	527.5	
	2000.01-	2006.12	MT	L/R		4WD	GDS59217	Drive Shaft			26		60	162	522	
<b>HILUX PICK UP (LN167)</b>																
3.0 4WD	1997.08-	2004.07	5MT/F			Engine 5L	GC059016	Outer Joint			26	27	60	162	65.5	M
<b>HILUX PICK UP (LN172H)</b>																
3.0 4WD	1997.11-	2004.07	5MT/F			Engine 5L	GC059016	Outer Joint			26	27	60	162	65.5	M
<b>HILUX PICK UP (RZN167)</b>																
3.0 4WD	1997.08-	2004.07	5MT/F			Engine 5L	GC059016	Outer Joint			26	27	60	162	65.5	M
<b>HILUX PICK UP (RZN169H)</b>																
2.7	2001.08-	2004.07	4MT/F			Engine 3RZ-FE	GC059016	Outer Joint			26	27	60	162	65.5	M
<b>HILUX PICK UP (RZN174H)</b>																
2.7 4WD	1999.08-	2004.07	4MT/F			Engine 3RZ-FE	GC059016	Outer Joint			26	27	60	162	65.5	M
<b>HILUX SURF4RUNNER (N185W)</b>																
2.7 4WD	1995.11-	2002.11	4AT/F			Engine 3RZ-FE	GC059034	Outer Joint			30	27	69	122.5	64.5	I
3.0 4WD	2000.08-	2002.11	4AT/F			Engine 1KD-FTV	GC059034	Outer Joint			30	27	69	122.5	64.5	I
3.4 4WD	1995.11-	2002.11	4AT/F			Engine 5VZ-FE	GC059034	Outer Joint			30	27	69	122.5	64.5	I
<b>HILUX SURF4RUNNER (N215W)</b>																
2.7 4WD	2002.11-		4AT/F			Engine 3RZ-FE	GC059107	Outer Joint			30	30	70	103.5	82.5	I
3.0 4WD	2002.11-		4AT/F			Engine 1KD-FTV	GC059107	Outer Joint			30	30	70	103.5	82.5	I
3.4 4WD	2002.11-		4AT/F			Engine 5VZ-FE	GC059107	Outer Joint			30	30	70	103.5	82.5	I
<b>IPSUM PICNIC (ACM21W)</b>																
2.4	2001.05-		4AT/C			Engine 2AZ-FE	GC059175	Outer Joint	48T		26	27	63.3	100	59	M
<b>IPSUM PICNIC (ACM26W)</b>																
2.4 4WD	2001.05-		4AT/C			Engine 2AZ-FE	GC059175	Outer Joint	48T		26	27	63.3	100	59	M
<b>IQ</b>																
1.3	2009.08-		CVT			Engine GJ10	GC059384	Outer Joint			26	29	55.6	96	54	I
<b>IQ (AJ1)</b>																
1.3 (72 kW)	2009.01-						GC059244	Outer Joint			26	25	55.6	95.5	57	I
1.4 D-4D (66 kW)	2009.01-						GC059244	Outer Joint			26	25	55.6	95.5	57	I
<b>IQ (KPJ1_, KGG1_, NGJ1_, NUJ1_)</b>																
1.4 D-4D (66 kW)	2009.01-					Hatchback Engine 1ND-TV	GCI59100	Inner Joint			20	25	35	63.5	118	
<b>KLUGER V (MCU20W)</b>																
3	2000.11-	2001.05	4AT			Engine 1MZ-FE	GC059201	Outer Joint	48T		26	27	56	98	63	M
	2001.05-		4AT			Engine 1MZ-FE	GC059154	Outer Joint	48T		30	27	63.4	100	64.5	M
<b>LAND CRUISER</b>																
120 Series Prado	2003.01-		MT/AT				GCI99045	Inner Joint			30	30	47	75.5	108.5	
	2003.01-		MT/AT	L/R			GDS59054	Drive Shaft			30	30	70	103.5	647	
2.5 D							GCI59039	Inner Joint			30	29	47	76	116	
							GC099125	Outer Joint			30	29	72.5	116	73	M
				L/R			GDS59004	Drive Shaft			30	30	72.5	116	630	
<b>LAND CRUISER (KDJ12_, GRJ12_)</b>																
3.0 D-4D (120 kW)	2002.12-	2005.12				Closed Off-Road Vehicle Engine 1KD-FTV	GCI59049	Inner Joint			30	30	47	75.5	125.5	
4.0 (183 kW)	2003.01-	2008.03				Closed Off-Road Vehicle Engine 1GR-FE	GCI59049	Inner Joint			30	30	47	75.5	125.5	
<b>LAND CRUISER (KDJ15_, GRJ15_)</b>																
3.0 D-4D (127 kW)	2010.03-					Closed Off-Road Vehicle Engine 1KD-FTV	GCI59049	Inner Joint			30	30	47	75.5	125.5	
3.0 D-4D (140 kW)	2010.01-					Closed Off-Road Vehicle Engine 1KD-FTV	GCI59049	Inner Joint			30	30	47	75.5	125.5	
4.0 V6 VVT-i (183 kW)	2010.01-					Closed Off-Road Vehicle Engine 1GR-FE	GCI59049	Inner Joint			30	30	47	75.5	125.5	
4.0 V6 VVT-i (207 kW)	2010.01-					Closed Off-Road Vehicle Engine 1GR-FE	GCI59049	Inner Joint			30	30	47	75.5	125.5	
<b>LAND CRUISER / HI-LUX / 4 RUNNER</b>																
2	1988-	1993	MT/AT	L/R		Truck	GDS59031	Drive Shaft			26		60	162	487	
<b>LAND CRUISER 105 SERIES</b>																
-							GC059075	Outer Joint			30	24	59	167.5	71	I
<b>LAND CRUISER 80 (_J8_)</b>																
4.0 (115 kW)	1990.01-	1992.08	AT		F	Closed Off-Road Vehicle Engine 3F-E	GC059101	Outer Joint			30	24	59	176	71	I

		TRANSM	L/R	F/R		G-AP Ref.	PRODUCT	ABS	Technical Specifications							
									YEAR	A	B	C	H	L	P	
<b>TOYOTA</b>																
<b>LAND CRUISER 80 ( _J8_ )</b>																
4.2 D (99 kW)	1990.01-	1997.12	AT		F	Closed Off-Road Vehicle Engine 1H-Z	GC059101	Outer Joint		30	24	59	176	71	I	
4.2 TD (118 kW)	1992.10-	1997.12				Closed Off-Road Vehicle Engine 1HD-T	GC059064	Outer Joint		30	24	57	169	71	I	
	1992.10-	1997.12	AT		F	Closed Off-Road Vehicle Engine 1HD-T	GC059101	Outer Joint		30	24	59	176	71	I	
	1992.10-	1997.12			F	Closed Off-Road Vehicle Engine 1HD-T	GC059041	Outer Joint	48T	30	24	59	176	71	I	
4.2 TD (123 kW)	1990.01-	1997.12	AT		F	Closed Off-Road Vehicle Engine 1HD-T	GC059101	Outer Joint		30	24	59	176	71	I	
	1990.01-	1997.12			F	Closed Off-Road Vehicle Engine 1HD-T	GC059041	Outer Joint	48T	30	24	59	176	71	I	
4.2 TD 24V (125 kW)	1995.03-	1997.12	AT		F	Closed Off-Road Vehicle Engine 1HD-FT	GC059101	Outer Joint		30	24	59	176	71	I	
	1995.03-	1997.12			F	Closed Off-Road Vehicle Engine 1HD-FT	GC059041	Outer Joint	48T	30	24	59	176	71	I	
4.5 24V (151 kW)	1992.08-	1997.12	AT		F	Closed Off-Road Vehicle Engine 1FZ-FE	GC059101	Outer Joint		30	24	59	176	71	I	
	1992.08-	1997.12			F	Closed Off-Road Vehicle Engine 1FZ-FE	GC059041	Outer Joint	48T	30	24	59	176	71	I	
<b>LAND CRUISER LEXUS LX470 (FZJ105)</b>																
4.2 4WD	1998.01-		MT/AT			Engine 1HZ	GC059046	Outer Joint		30	24	59	168.1	71.2	I	
	1998.01-		MT/AT			Engine 1HZ	GC059027	Outer Joint		30	24	59	180	71	I	
<b>LAND CRUISER LEXUS LX470 (FZJ71 / 74 / 78 / 79)</b>																
4.2	1999.08-		MT/AT			Engine 1HZ	GC059027	Outer Joint		30	24	59	180	71	I	
<b>LAND CRUISER LEXUS LX470 (HZJ105)</b>																
4.5 4WD	1998.01-		MT/AT			Engine 1FZ-FE	GC059046	Outer Joint		30	24	59	168.1	71.2	I	
	1998.01-		MT/AT			Engine 1FZ-FE	GC059027	Outer Joint		30	24	59	180	71	I	
<b>LAND CRUISER LEXUS LX470 (HZJ71 / 78 / 79)</b>																
4.5	1999.08-		MT/AT			Engine 1FZ-F	GC059027	Outer Joint		30	24	59	180	71	I	
<b>LAND CRUISER LEXUS LX570 ( _URJ202W_ )</b>																
4.6 4WD	2009.05-	2010.08	6AT/F			Engine 1UR-FE	GC059336	Outer Joint		36	30	83	120	78	I	
<b>LAND CRUISER LEXUS LX571 ( _URJ202W_ )</b>																
4.6 4WD	2010.08-	2012.01	6AT/F			Engine 1UR-FE	GC059336	Outer Joint		36	30	83	120	78	I	
<b>LAND CRUISER LEXUS LX572 ( _URJ202W_ )</b>																
4.6 4WD	2012.01-		6AT/F			Engine 1UR-FE	GC059336	Outer Joint		36	30	83	120	78	I	
<b>LAND CRUISER LEXUS LX573 ( _URJ202W_ )</b>																
4.7 4WD	2007.09-	2009.05	5AT/F			Engine 2UZ-FE	GC059336	Outer Joint		36	30	83	120	78	I	
<b>LAND CRUSER AMAZON (UZJ100)</b>																
4.7 (175 kW)	2006.01-	2007.08			L/R	F	Closed Off-Road Vehicle Engine 2UZ-FE	GC059085	Outer Joint		30	30	72.58	176	78	I
<b>LEXUS (S196)</b>																
3.5 4WD	2007.09-		6AT/F			Engine 2GR—FSE	GC059306	Outer Joint		30	30	57	82	55	M	
<b>LITEACE TOWNACE (CM40G)</b>																
2.0 4WD	1985.10-	1992.01	MT/AT			Engine 2C-T	GC059045	Outer Joint		26	27	60	140	65.5	I	
<b>LITEACE TOWNACE (CM41V)</b>																
2.0 4WD	1985.10-	1992.01	MT			Engine 2C	GC059045	Outer Joint		26	27	60	140	65.5	I	
<b>LITEACE TOWNACE (CM60)</b>																
2.0 4WD	1986.10-	1987.08	5MT			Engine 2C	GC059045	Outer Joint		26	27	60	140	65.5	I	
	1986.10-	1987.08	MT			Engine 2C	GC059045	Outer Joint		26	27	60	140	65.5	I	
<b>LITEACE TOWNACE (CM65)</b>																
2.0 4WD	1986.10-	1987.08	MT			Engine 2C	GC059045	Outer Joint		26	27	60	140	65.5	I	
<b>LITEACE TOWNACE (CR30G)</b>																
2.0 4WD	1985.10-	1993.09	MT/AT			Engine 2C-T	GC059045	Outer Joint		26	27	60	140	65.5	I	
<b>LITEACE TOWNACE (CR31)</b>																
2.2 4WD	1993.09-	1996.10	MT/AT			Engine 3C-T	GC059045	Outer Joint		26	27	60	140	65.5	I	
<b>LITEACE TOWNACE (CR36V)</b>																
2.0 4WD	1985.10-	1996.10	MT/AT			Engine 2C	GC059045	Outer Joint		26	27	60	140	65.5	I	
<b>LITEACE TOWNACE (CR37G)</b>																
2.0 4WD	1987.08-	1993.09	MT/AT			Engine 2C-T	GC059045	Outer Joint		26	27	60	140	65.5	I	
<b>LITEACE TOWNACE (CR38)</b>																
2.2 4WD	1993.09-	1996.10	MT/AT			Engine 3C-T	GC059045	Outer Joint		26	27	60	140	65.5	I	
<b>LITEACE TOWNACE (CR50)</b>																
2.2 4WD	1996.10-		4AT			Engine 3C-T	GC059089	Outer Joint		26	27	56	98	63	M	
	1996.10-		MT/AT			Engine 3C-T	GC059201	Outer Joint	48T	26	27	56	98	63	M	
<b>LITEACE TOWNACE (CR51)</b>																
2.0 4WD	1996.11-	1998.12	4AT			Engine 2C	GC059089	Outer Joint		26	27	56	98	63	M	
	1996.11-	1998.12	MT/AT			Engine 2C	GC059201	Outer Joint	48T	26	27	56	98	63	M	
<b>LITEACE TOWNACE (SR50)</b>																
2.0 4WD	1996.10-		4AT			Engine 3S-FE	GC059089	Outer Joint		26	27	56	98	63	M	
	1996.10-		MT/AT			Engine 3S-FE	GC059201	Outer Joint	48T	26	27	56	98	63	M	









		YEAR	TRANSM	L/R	F/R		G-AP Ref.	PRODUCT	ABS	Technical Specifications						
										A	B	C	H	L	P	
<b>TOYOTA</b>																
<b>LITEACE TOWNACE (YM40G)</b>																
2.0 4WD	1985.10-	1992.01	MT/AT			Engine 3Y-U	GC059045	Outer Joint			26	27	60	140	65.5	I
<b>LITEACE TOWNACE (YM60)</b>																
1.8 4WD	1986.10-	1990.08	MT			Engine 2Y	GC059045	Outer Joint			26	27	60	140	65.5	I
<b>LITEACE TOWNACE (YR30G)</b>																
2.0 4WD	1985.10-		MT/AT			Engine 3Y-EU	GC059045	Outer Joint			26	27	60	140	65.5	I
<b>LUCIDA EMINA (CXR20)</b>																
2.2 4WD	1992.01-	1993.08	MT/AT			Engine 3C-T TE	GC059089	Outer Joint			26	27	56	98	63	M
	1992.01-	1993.08	MT/AT			Engine 3C-T TE	GC059201	Outer Joint	48T		26	27	56	98	63	M
<b>LUCIDA EMINA (CXR21)</b>																
2.2 4WD	1992.01-	1993.08	MT/AT			Engine 3C-T TE	GC059089	Outer Joint			26	27	56	98	63	M
	1992.01-	1993.08	MT/AT			Engine 3C-T TE	GC059201	Outer Joint	48T		26	27	56	98	63	M
<b>LUCIDA EMINA (TCR20)</b>																
2.4 4WD	1992.01-	1999.12	MT/AT			Engine 2TZ-FE	GC059089	Outer Joint			26	27	56	98	63	M
	1992.01-	1999.12	MT/AT			Engine 2TZ-FE	GC059201	Outer Joint	48T		26	27	56	98	63	M
<b>LUCIDA EMINA (TCR21)</b>																
2.4 4WD	1992.01-	1996.10	MT/AT			Engine 2TZ-FE	GC059089	Outer Joint			26	27	56	98	63	M
	1992.01-	1996.10	MT/AT			Engine 2TZ-FE	GC059201	Outer Joint	48T		26	27	56	98	63	M
<b>MARK II BLIT (GX115, JZX115)</b>																
- 4WD	2000-	2004					GC059370	Outer Joint	48T		30	30	56	92	59	I
<b>MARK II CHASER / CRESTA (GX105)</b>																
- 4WD	1996-	2001					GC059370	Outer Joint	48T		30	30	56	92	59	I
<b>MARK II QUALIS (SXV20)</b>																
2.2	1997.04-	2002.02	4AT			Engine 5S-FE	GC059012	Outer Joint	48T		26	27	56	100	63	M
<b>MARK X ZIO (ANA15)</b>																
-4WD	2007-						GC059245	Outer Joint			26	27	61.2	100	59	I
<b>MARK X ZIO (ANA1_GGA10)</b>																
-	2007-						GC059245	Outer Joint			26	27	61.2	100	59	I
<b>MR 2 I (AW1_)</b>																
1.6 16V (85 kW)	1984.11-	1990.06			R	Coupe Engine 4A-GELC	GC059062	Outer Joint			26	24	56	95.5	55	I
1.6 16V (91 kW)	1984.11-	1990.06			R	Coupe Engine 4A-GEL	GC059062	Outer Joint			26	24	56	95.5	55	I
<b>MR 2 II</b>																
2	1990.04-	1999.11					GC059186	Outer Joint	48T		26	25	56	96	61	I
<b>MR-2 I (W1)</b>																
1.6 16V (85 kW)	1984.11-	1990.06					GC022001	Outer Joint			26	23	56	96.5	55	I
1.6 16V (89 kW)	1984.11-	1990.06					GC022001	Outer Joint			26	23	56	96.5	55	I
1.6 16V (91 kW)	1984.11-	1990.06					GC022001	Outer Joint			26	23	56	96.5	55	I
<b>PASSO (KGC10)</b>																
1	2004.05-		4AT/C			Engine 1KR-FE	GC059268	Outer Joint			24	26	47	85.5	47.5	I
<b>PASSO (KGC15)</b>																
1.0 4WD	2004.05-		4AT/C			Engine 1KR-FE	GC059268	Outer Joint			24	26	47	85.5	47.5	I
<b>PASSO (QNC10)</b>																
1.3	2004.05-		4AT/C			Engine K3-VE	GC059266	Outer Joint			24	29	47	85.5	51	I
<b>PICK UP</b>																
-						4WD	GC059198	Outer Joint			30	27	56	188.5	60	I
	1986-	1995					GCI59014	Inner Joint				24		83.3		
- 4WD							GC059198	Outer Joint			30	27	56	188.5	60	I
<b>PICNIC (_XM10)</b>																
2.0 (90 kW)	2001.01-	2001.12	MT/AT	L	F	MPV Engine 3S-FE	GDS59020	Drive Shaft	48T		26	20	56	99	630	
	2001.01-	2001.12				MPV Engine 3S-FE	GC059019	Outer Joint	48T		26	24	56	95.5	55	I
2.0 16V (94 kW)	1996.05-	2001.12	AT	L	F	MPV Engine 3S-FE	GDS59020	Drive Shaft	48T		26	20	56	99	630	
	1996.05-	2001.12				MPV Engine 3S-FE	GC059019	Outer Joint	48T		26	24	56	95.5	55	I
2.2 D (66 kW)	1997.08-	2001.12				MPV Engine 3C-TE	GC059055	Outer Joint			26	25	56	96	56	M
	1997.08-	2001.12				MPV Engine 3C-TE	GC059019	Outer Joint	48T		26	24	56	95.5	55	I
<b>PLATZ ECHO (NCP10)</b>																
1	1999.08-		MT/AT			Engine 2NZ-FE	GC059029	Outer Joint			24	22	56	90	48.5	M
1.3	1999.01-		MT/AT			Engine 2NZ-FE	GC059029	Outer Joint			24	22	56	90	48.5	M
<b>PRADO (J120W)</b>																
2.7 4WD	2002.10-		4AT/F			Engine 3RZ-FE	GC059107	Outer Joint			30	30	70	103.5	82.5	I
3.0 4WD	2002.10-		4AT/F			Engine 1KD-FTV	GC059107	Outer Joint			30	30	70	103.5	82.5	I



		YEAR	TRANSM	L/R	F/R		G-AP Ref.	PRODUCT	ABS	Technical Specifications						
										A	B	C	H	L	P	
<b>TOYOTA</b>																
<b>PRADO (J121W)</b>																
3.0 4WD	2002.10-		4AT/F			Engine 1KD-FTV	GC059107	Outer Joint		30	30	70	103.5	82.5	I	
3.4 4WD	2002.10-		4AT/F			Engine 5VZ-FE	GC059107	Outer Joint		30	30	70	103.5	82.5	I	
<b>PRADO (J125W)</b>																
2.7 4WD	2002.10-		4AT/F			Engine 3RZ-FE	GC059107	Outer Joint		30	30	70	103.5	82.5	I	
3.0 4WD	2002.10-		4AT/F			Engine 1KD-FTV	GC059107	Outer Joint		30	30	70	103.5	82.5	I	
3.4 4WD	2002.10-		4AT/F			Engine 5VZ-FE	GC059107	Outer Joint		30	30	70	103.5	82.5	I	
<b>PRADO (J90W)</b>																
3	1996.05-	2002.10	MT/AT			Engine 1KZ-TE	GC059034	Outer Joint		30	27	69	122.5	64.5	I	
3.4	1996.05-	2002.10	MT/AT			Engine 5VZ-FE	GC059034	Outer Joint		30	27	69	122.5	64.5	I	
<b>PRADO (J95W)</b>																
3	1996.05-	2002.10	MT/AT			Engine 1KZ-TE	GC059034	Outer Joint		30	27	69	122.5	64.5	I	
3.4	1996.05-	2002.10	4AT			Engine 5VZ-FE	GC059034	Outer Joint		30	27	69	122.5	64.5	I	
<b>PREMIO (AZT240)</b>																
2	2001-		CVT			Engine 1AZ-FSE	GC059294	Outer Joint	48T	26	27	63	97	60	M	
<b>PREVIA (MCR3_, ACR3_, CLR3_)</b>																
2.0 D-4D (85 kW)	2001.03-	2006.01	MT	L	F	MPV Engine 1CD-FTV	GDS59379	Drive Shaft	48T	30		63.4	99	576		
	2001.03-	2006.01		L	F	MPV Engine 1CD-FTV	GCI59073	Inner Joint		24	27	50	67	110		
2.4 (115 kW)	2000.08-	2006.01	AT		F	MPV Engine 2AZ-FE	GC059314	Outer Joint	48T	26	27	61.2	100	59.5	I	
	2000.08-	2006.01	MT	L	F	MPV Engine 2AZ-FE	GDS59379	Drive Shaft	48T	30		63.4	99	576		
	2000.08-	2006.01		L	F	MPV Engine 2AZ-FE	GCI59073	Inner Joint		24	27	50	67	110		
	2000.08-	2006.01		R	F	MPV Engine 2AZ-FE	GCI59078	Inner Joint		24	27	40	370	105		
3.0 VVTi (162 kW)	2000.08-	2005.12			F	MPV Engine 1MZ-FE	GC059431	Outer Joint	48T	30	27	61.2	100	64.5	M	
<b>PREVIA (TCR2_, TCR1_)</b>																
2.4 (97 kW)	1990.05-	2000.08			R	MPV Engine 2TZ-FE	GC059125	Outer Joint	48T	26	27	56	99.5	63	I	
	1990.05-	2000.08	MT/AT		R	MPV Engine 2TZ-FE	GC031001	Outer Joint		26	27	56	99.5	63	I	
2.4 4WD (97 kW)	1990.05-	2000.08				MPV Engine 2TZ-FE	GC059125	Outer Joint	48T	26	27	56	99.5	63	I	
	1990.05-	2000.08	MT/AT		F	MPV Engine 2TZ-FE	GC031001	Outer Joint		26	27	56	99.5	63	I	
<b>PREVIA / TARAGO (ACR50)</b>																
-	2006-						GC059245	Outer Joint		26	27	61.2	100	59	I	
<b>PRIUS</b>																
-	2001-	2003					GC059191	Outer Joint	48T	26	24	56	95.5	55	I	
<b>PRIUS (NHW11_)</b>																
1.5 (53 kW)	2000.05-	2004.01		L	F	Saloon Engine 1NZ-FXE	GDS59380	Drive Shaft	48T	26	20	58	95.5	671		
<b>PRIUS (NHW20_)</b>																
1.5 (57 kW)	2003.11-	2006.02			F	Hatchback Engine 1NZ-FXE	GC059136	Outer Joint	48T	26	23	58	96	52.5	I	
	2003.11-	2006.02		L	F	Hatchback Engine 1NZ-FXE	GDS59380	Drive Shaft	48T	26	20	58	95.5	671		
	2003.11-	2006.02		L/R	F	Hatchback Engine 1NZ-FXE	GC059288	Outer Joint	48T	26	23	58	96	52.5	I	
<b>PRIUS (ZVW3_)</b>																
1.8 HybriD (73 kW)	2009.04-		AT	L	F	Hatchback Engine 2ZR-FXE	GDS59377	Drive Shaft		26	24	55.6	95.5	623.5		
	2009.04-		AT	L	F	Hatchback Engine 2ZR-FXE	GCI59094	Inner Joint		24	25	50	67	105		
	2009.04-		AT	L	F	Hatchback Engine 2ZR-FXE	GC059340	Outer Joint		26	25	55.6	95.5	57	I	
<b>PRIUS II (2VW30)</b>																
1.8 (73 kW)	2009.01-						GC059244	Outer Joint		26	25	55.6	95.5	57	I	
<b>PROGRES (JCG15)</b>																
- 4WD	1998-	2007					GC059370	Outer Joint	48T	30	30	56	92	59	I	
<b>RAUM (EXZ10)</b>																
1	1997.05-	2003.04	4AT/C			Engine 5E-FE	GC059177	Outer Joint	48T	26	23	56	95.5	55	I	
<b>RAUM (EXZ15)</b>																
1.5 4WD	1997.05-	2003.04	4AT/C			Engine 5E-FE	GC059177	Outer Joint	48T	26	23	56	95.5	55	I	
<b>RAV 4</b>																
-	1994.01-	2000.07	MT/AT		F		GCI59012	Inner Joint		23	23	44	49.5	114.5		
	1994.01-	2000.07	MT/AT	L		AE 95 4WD	GDS59044	Drive Shaft		26	23	56	95.5	574		
	1994.01-	2000.07	MT/AT	R		AE 95 4WD	GDS59046	Drive Shaft		26	23	56	95.5	578.5		
	2000.01-			L	F	20 Series	GDS59012	Drive Shaft		26	23	63	100	595		
	2000.01-			R	F	20 Series	GDS59013	Drive Shaft		26	23	63	100	990.5		
<b>RAV 4 (SXA1_)</b>																
2.0 16V 4WD (94 kW)	1997.12-	2000.06	MT/AT		F	Open Off-Road Vehicle Engine 3S-FE	GC059120	Outer Joint	48T	26	24	56	95.5	55	I	
	1997.12-	2000.06	MT/AT			Open Off-Road Vehicle Engine 3S-FE	GC059019	Outer Joint	48T	26	24	56	95.5	55	I	
	1997.12-	2000.06	MT/AT		F	Open Off-Road Vehicle Engine 3S-FE	GC059001	Outer Joint		26	24	56	95.5	55	I	
	1997.12-	2000.06				Open Off-Road Vehicle Engine 3S-FE	GC059062	Outer Joint		26	24	56	95.5	55	I	

		TRANSM	L/R	F/R		G-AP Ref.	PRODUCT	ABS	Technical Specifications							
									YEAR	A	B	C	H	L	P	
<b>TOYOTA</b>																
<b>RAV 4 (SXA1_)</b>																
2.0 4WD (95 kW)	1994.06-	2000.06	MT/AT		F	Closed Off-Road Vehicle Engine 3S-FE	GC059120	Outer Joint	48T	26	24	56	95.5	55	I	
	1994.06-	2000.06	MT/AT			Closed Off-Road Vehicle Engine 3S-FE	GC059019	Outer Joint	48T	26	24	56	95.5	55	I	
	1994.06-	2000.06	MT/AT		F	Closed Off-Road Vehicle Engine 3S-FE	GC059001	Outer Joint		26	24	56	95.5	55	I	
	1994.06-	2000.06				Closed Off-Road Vehicle Engine 3S-FE	GC059062	Outer Joint		26	24	56	95.5	55	I	
<b>RAV 4 II (CLA2_, XA2_, ZCA2_, ACA2_)</b>																
2.0 D-4D 4WD (85 kW)	2001.09-	2005.11				Closed Off-Road Vehicle Engine 1CD-FTV	GC059081	Outer Joint		26	27	63	100	62	I	
	2001.09-	2005.11			F	Closed Off-Road Vehicle Engine 1CD-FTV	GC059167	Outer Joint	48T	26	27	63	100	62	I	
2.0 VVT-i 4WD (110 kW)	2000.06-	2005.11			F	Closed Off-Road Vehicle Engine 1AZ-FE	GC059167	Outer Joint	48T	26	27	63	100	62	I	
<b>RAV 4 II (XA2)</b>																
2.0 D-4D 4WD (66 kW)	2001.09-						GC059167	Outer Joint	48T	26	27	63	100	62	I	
2.0 D-4D 4WD (81 kW)	2001.09-						GC059167	Outer Joint	48T	26	27	63	100	62	I	
2.0 D-4D 4WD (85 kW)	2001.09-						GC059167	Outer Joint	48T	26	27	63	100	62	I	
<b>RAV 4 III (ACA3_, ACE_, ALA3_, GSA3_, ZSA3_)</b>																
2.0 (116 kW)	2008.12-				L	F	Closed Off-Road Vehicle Engine 3ZR-FAE	GCI59073	Inner Joint		24	27	50	67	110	
	2008.12-				R	F	Closed Off-Road Vehicle Engine 3ZR-FAE	GCI59078	Inner Joint		24	27	40	370	105	
2.0 4WD (116 kW)	2008.12-				L	F	Closed Off-Road Vehicle Engine 3ZR-FAE	GCI59073	Inner Joint		24	27	50	67	110	
2.0 VVT-i 4WD (112 kW)	2006.02-	2007.03			L	F	Closed Off-Road Vehicle Engine 1AZ-FE	GCI59073	Inner Joint		24	27	50	67	110	
2.2 D-4D (110 kW)	2008.12-				L	F	Closed Off-Road Vehicle Engine 2AD-FHV/2AD-FTV	GCI59073	Inner Joint		24	27	50	67	110	
2.2 D-4D 4WD (100 kW)	2006.02-	2007.03			L	F	Closed Off-Road Vehicle Engine 2AD-FTV	GCI59073	Inner Joint		24	27	50	67	110	
	2006.02-	2007.03	MT		R	F	Closed Off-Road Vehicle Engine 2AD-FTV	GDS59518	Drive Shaft		30	24	61.2	100	1006	
2.2 D-4D 4WD (110 kW)	2008.12-				L	F	Closed Off-Road Vehicle Engine 2AD-FTV/2AD-FHV	GCI59073	Inner Joint		24	27	50	67	110	
2.2 D-CAT 4WD (130 kW)	2006.02-	2007.03			L	F	Closed Off-Road Vehicle Engine 2AD-FHV	GCI59073	Inner Joint		24	27	50	67	110	
	2006.02-	2007.03	MT		R	F	Closed Off-Road Vehicle Engine 2AD-FHV	GDS59518	Drive Shaft		30	24	61.2	100	1006	
<b>RAV 4 IV (WWA4_, AVA4_, ZSA4_, ALA4_)</b>																
2.0 D4-D (91 kW)	2012.12-				L	F	Closed Off-Road Vehicle Engine 1AD-FTV	GCI59073	Inner Joint		24	27	50	67	110	
2.0 D4-D 4WD (91 kW)	2013.11-				L	F	Closed Off-Road Vehicle Engine 1AD-FTV	GCI59073	Inner Joint		24	27	50	67	110	
2.0 VVT-i 4WD (112 kW)	2015.04-				L	F	Closed Off-Road Vehicle Engine 3ZR-FAE	GCI59073	Inner Joint		24	27	50	67	110	
2.2 D4-D 4WD (110 kW)	2012.12-				L	F	Closed Off-Road Vehicle Engine 2AD-FHV/2AD-FTV	GCI59073	Inner Joint		24	27	50	67	110	
<b>RAV 4 IV (ZSA4_, ALA4_)</b>																
2.0 VVT-i 4WD (111 kW)	2012.12-				L	F	Closed Off-Road Vehicle Engine 3ZR-FAE	GCI59073	Inner Joint		24	27	50	67	110	
<b>RAV4 (ACA3_, GSA3_)</b>																
-	2005-							GC059245	Outer Joint		26	27	61.2	100	59	I
<b>RUSH (J210E)</b>																
1.5 4WD	2006.01-		4AT/I			Engine 3SZ-VE	GC099290	Outer Joint		24	22	52	89.8	81	M	
	2006.01-		5MT/F			Engine 3SZ-VE	GC099290	Outer Joint		24	22	52	89.8	81	M	
<b>SCEPTER</b>																
2.2	1998-		MT			SXV20 5S-FE	GCI59033	Inner Joint		20	24	35	63.5	115.7		
	1998-						GC059066	Outer Joint		26	32	56	101	66	I	
<b>SCEPTER (SXV10)</b>																
2.2	1992.11-	1996.08	AT			Engine 5S-FE	GC059011	Outer Joint		26	27	56	100	63	M	
	1992.11-	1996.08	AT			Engine 5S-FE	GC059087	Outer Joint		26	32	56	100	63	M	
<b>SCEPTER (SXV15)</b>																
2.2	1993.10-	1994.09	AT			Engine 5S-FE	GC059087	Outer Joint		26	32	56	100	63	M	
<b>SCEPTER (SXV15W)</b>																
2.2	1992.12-	1994.09	AT			Engine 5S-FE	GC059011	Outer Joint		26	27	56	100	63	M	
	1992.12-	1996.09	AT			Engine 5S-FE	GC059087	Outer Joint		26	32	56	100	63	M	
<b>SCION XB (AZE150)</b>																
-	2007-							GC059245	Outer Joint		26	27	61.2	100	59	I
<b>SERA (EXY10)</b>																
1.5	1990.03-	1995.12	MT/AT			Engine 5E-FHE	GC059039	Outer Joint		23	23	56	88.5	52	I	
<b>SOLUNA</b>																
1.3	2001.01-		MT/AT			Engine AL50	GC059432	Outer Joint		26	22	56	95.5	53	M	
<b>SPRINTER II (E8)</b>																
1.3 (51 kW)	1983-	1985					GC022001	Outer Joint		26	23	56	96.5	55	I	
1.3 (55 kW)	1983-	1985					GC022001	Outer Joint		26	23	56	96.5	55	I	
1.5 (52 kW)	1983-	1985					GC022001	Outer Joint		26	23	56	96.5	55	I	
1.6 (62 kW)	1983-	1985					GC022001	Outer Joint		26	23	56	96.5	55	I	
1.6 (63 kW)	1983-	1985					GC022001	Outer Joint		26	23	56	96.5	55	I	
<b>STARLET</b>																
-	1995-	1999				EL54 All	GCI59002	Inner Joint		23	23	34	58.8	102.7		









		TRANSM	L/R	F/R		G-AP Ref.	PRODUCT	ABS	Technical Specifications									
									YEAR	A	B	C	H	L	P			
<b>TOYOTA</b>																		
<b>STARLET</b>																		
-	1996.01-	1999.12	MT/AT			GCI59002	Inner Joint		23	23	34	58.8	102.7					
	1996.01-	1999.12	MT/AT	L		GDS59052	Drive Shaft		23	23	56	90.5	628					
	1996.01-	1999.12	MT/AT	R		GDS59053	Drive Shaft		23	23	56	90.5	858					
1.3	1989-	1995	MT/AT		EP81 4E-FE	GCI59002	Inner Joint		23	23	34	58.8	102.7					
	1989-	1995	AT/MT		EP81 EP83 EP91	GC059100	Outer Joint		23	23	56	90.5	55	I				
<b>STARLET (EP71)</b>																		
1.3	1984.10-	1989.12	MT/AT		Engine 2E-LU ELU	GC059039	Outer Joint		23	23	56	88.5	52	I				
	1984.10-	1989.10	MT/AT		Engine 2E-TELU	GC059039	Outer Joint		23	23	56	88.5	52	I				
<b>STARLET (EP76V)</b>																		
1.3	1984.10-	1989.12	MT		Engine 2E-LJ	GC059039	Outer Joint		23	23	56	88.5	52	I				
<b>STARLET (EP81)</b>																		
1.3	1989.01-	1995.12	MT/AT		Engine 4E-FE	GC059227	Outer Joint		23	30	56	88.5	52	M				
<b>STARLET (EP82)</b>																		
1.3	1989.12-	1995.12	MT/AT		Engine 4E-F FE	GC059039	Outer Joint		23	23	56	88.5	52	I				
	1989.12-	1992.01	MT/AT		Engine 4E-FTE	GC059039	Outer Joint		23	23	56	88.5	52	I				
	1992.01-	1996.01	MT/AT		Engine 4E-FTE TBO	GC059227	Outer Joint		23	30	56	88.5	52	M				
	1992.01-	1996.01	MT		Engine 4E-FTE	GC059227	Outer Joint		23	30	56	88.5	52	M				
	1992.01-	1996.01	MT/AT		Engine 4E-FTE/4E-FTE TBO	GC059202	Outer Joint	48T	23	30	56	88.5	52	M				
<b>STARLET (EP85)</b>																		
1.3 4WD	1990.08-	1995.12	MT/AT		Engine 4E-F FE	GC059039	Outer Joint		23	23	56	88.5	52	I				
<b>STARLET (EP91)</b>																		
1.3	1996.01-	1999.07	MT		Engine 4E-FTE TBO	GC059227	Outer Joint		23	30	56	88.5	52	M				
	1996.01-	1999.07	MT/AT		Engine 4E-FTE	GC059202	Outer Joint	48T	23	30	56	88.5	52	M				
	1996.01-	1999.07	MT		Engine 4E-FTE	GC059202	Outer Joint	48T	23	30	56	88.5	52	M				
	1996.01-	1999.07	MT/AT		Engine 4E-FE	GC059039	Outer Joint		23	23	56	88.5	52	I				
1.3 (55 kW)	1996.04-	1999.03		F	Hatchback Engine 4E-FE	GC059040	Outer Joint	48T	23	23	56	90.5	55	I				
<b>STARLET (KP6_)</b>																		
1.3 S (48 kW)	1982.08-	1984.09		R	Hatchback Engine 4K	GC059054	Outer Joint		23	23	56	87.5	55	I				
<b>STARLET (NCP42R)</b>																		
1.5			MT/AT		Engine 1NZ-FE	GC059196	Outer Joint	48T	24	23	56	90	55	I				
<b>STARLET (NP70)</b>																		
1.5	1986.12-	1989.12	MT&AT		Engine 1N	GC059039	Outer Joint		23	23	56	88.5	52	I				
<b>STARLET (NP76V)</b>																		
1.5	1986.12-	1989.12	MT		Engine 1N	GC059039	Outer Joint		23	23	56	88.5	52	I				
<b>STARLET (NP80)</b>																		
1.5	1989.12-	1995.12	MT&AT		Engine 1N	GC059039	Outer Joint		23	23	56	88.5	52	I				
<b>STARLET (NP90)</b>																		
1.5	1996.01-	1999.07	MT&AT		Engine 1N	GC059039	Outer Joint		23	23	56	88.5	52	I				
<b>STARLET (_P7_)</b>																		
1.0 (40 kW)	1984.10-	1989.12		F	Hatchback Engine 1E-L	GC059054	Outer Joint		23	23	56	87.5	55	I				
1.3 (55 kW)	1984.10-	1989.12		F	Hatchback Engine 2E-LC	GC059054	Outer Joint		23	23	56	87.5	55	I				
1.5 D (40 kW)	1986.12-	1989.12		F	Hatchback Engine 1N	GC059054	Outer Joint		23	23	56	87.5	55	I				
<b>STARLET (_P8_)</b>																		
1.0 (40 kW)	1989.12-	1992.12	MT	F	Hatchback Engine 1E	GC059013	Outer Joint		23	21	56	95	51.5	I				
1.3 12V (55 kW)	1989.12-	1992.12		F	Hatchback Engine 2E/2E-E	GC059040	Outer Joint	48T	23	23	56	90.5	55	I				
	1989.12-	1996.03		F	Hatchback Engine 2E-E	GC059040	Outer Joint	48T	23	23	56	90.5	55	I				
1.5 D (40 kW)	1989.12-	1996.03		F	Hatchback Engine 1N	GC059054	Outer Joint		23	23	56	87.5	55	I				
<b>T100</b>																		
-	1993-	1998				GCI59014	Inner Joint			24		83.3						
<b>TACOMA</b>																		
-	1995-	2005				GC059072	Outer Joint		30	34	69	123	66.5	I				
2.0 8V (80 kW)	1997.11-	2002.01				GC059071	Outer Joint		26	34	69	118.5	66.5	I				
<b>TERCEL</b>																		
-	1983-	1988				GC059053	Outer Joint		23	22	51	84	60	O				
	1993-	1994				GC059134	Outer Joint	48T	26	22	56	100.5	55	I				
1.3 (EL51)	1994.09-		MT/AT		Engine 4A-FE/4E-FE	GC059017	Outer Joint		26	22	56	95	50	M				
All Types	1991.01-	1994.12	MT/AT			GC059032	Outer Joint		26	22	56	100.5	55	I				
<b>TERCEL (AL2_)</b>																		
1.5 4WD (50 kW)	1986.05-	1988.01	MT		Hatchback Engine 3A-C	GC022001	Outer Joint		26	23	56	96.5	55	I				



		TRANSM	L/R	F/R		G-AP Ref.	PRODUCT	ABS	Technical Specifications									
									YEAR	A	B	C	H	L	P			
<b>TOYOTA</b>																		
<b>TERCEL (L1, L2)</b>																		
1.3 (48 kW)	1979.03-	1985.03				GC022001	Outer Joint		26	23	56	96.5	55	I				
1.5 4WD (52 kW)	1979.03-	1985.03			F	GC022001	Outer Joint		26	23	56	96.5	55	I				
<b>TERCEL (L1, L2)</b>																		
1.3 (48 kW)	1979.03-	1988.01		L/R	F	Hatchback Engine 2A	GC059053	Outer Joint	23	22	51	84	60	O				
	1979.03-	1988.01		L	F	Hatchback Engine 2A	GDS59049	Drive Shaft	23	20	51	84	778.1					
	1979.03-	1988.01		R	F	Hatchback Engine 2A	GDS59050	Drive Shaft	23	20	51	84	680.1					
<b>URBAN CRUISER (NSP1, NLP1, ZSP1, NCP11)</b>																		
1.4 D-4D (66 kW)	2009.04-					Hatchback Engine 1ND-TV	GCI59100	Inner Joint	20	25	35	63.5	118					
1.4 D-4D 4WD (66 kW)	2009.04-					Hatchback Engine 1ND-TV	GCI59100	Inner Joint	20	25	35	63.5	118					
<b>VEROSSA (GX115)</b>																		
- 4WD	2001-	2004					GC059370	Outer Joint	48T	30	30	56	92	59	I			
<b>VERSO (AUR2, ZGR2)</b>																		
1.8 (108 kW)	2009.04-		MT	L	F	MPV Engine 2ZR-FAE	GDS59493	Drive Shaft	26	20	61.2	95.5	658					
	2009.04-		MT	R	F	MPV Engine 2ZR-FAE	GDS59494	Drive Shaft	26	20	61.2	95.5	938					
2.0 D-4D (91 kW)	2012.11-					MPV Engine 1AD-FTV	GC059345	Outer Joint	30	25	61.2	99.5	62	M				
2.0 D-4D (93 kW)	2009.04-					MPV Engine 1AD-FTV	GC059345	Outer Joint	30	25	61.2	99.5	62	M				
<b>VERSO S (NLP12, NCP12, NSP12)</b>																		
1.4 D4-D (66 kW)	2010.11-					MPV Engine 1ND-TV	GCI59100	Inner Joint	20	25	35	63.5	118					
<b>VIGO</b>																		
3	2004.01-		MT/AT			TGN16	GC059199	Outer Joint		30	29	72.5	116	73	M			
<b>VIOS</b>																		
-				L			GDS59077	Drive Shaft	48T	24	23	56	90.5	876.5				
				R			GDS59076	Drive Shaft	48T	24	23	56	90.5	637.5				
1.5			MT/AT			Engine 1NZ-FE	GC059207	Outer Joint	24	23	56	90	55	I				
	2004-		MT/AT			Thailand NCP42R 1NZ-FE	GCI59023	Inner Joint	23	23	34	60	113					
<b>VISTA</b>																		
2.2	1998-		MT			SXV20 5S-FE	GCI59033	Inner Joint	20	24	35	63.5	115.7					
	1998-						GC059066	Outer Joint	26	32	56	101	66	I				
<b>VITZ / YARIS / ECHO</b>																		
1	2007.08-	2008.09				CVT/F	GC059308	Outer Joint	26	20	55.6	96	54	M				
1.3			MT/AT				GC059190	Outer Joint	24	22	58	90	47	I				
1.3 4WD	2007.08-	2008.09	4AT/F				GC059274	Outer Joint	26	23	55.6	96	54	I				
1.5	2007.08-	2008.09	CVT/F				GC059274	Outer Joint	26	23	55.6	96	54	I				
	2007.08-	2008.09	MT/AT				GC059274	Outer Joint	26	23	55.6	96	54	I				
<b>VITZ / YARIS / ECHO (CP10)</b>																		
1.3	2001.12-		MT/AT				GC059271	Outer Joint	48T	24	28	56	90.5	54.2	O			
1.4	2001.12-		MT/AT				GC059271	Outer Joint	48T	24	28	56	90.5	54.2	O			
1.5	2003.01-		MT/AT				GC059271	Outer Joint	48T	24	28	56	90.5	54.2	O			
<b>VITZ / YARIS / ECHO (NCP11)</b>																		
1	2002.06-		MT/AT			Engine 2NZ-FE	GC059190	Outer Joint		24	22	58	90	47	I			
<b>VITZ / YARIS / ECHO (SCP10)</b>																		
1	2000.01-		MT/AT			Engine 1SZ-FE	GC059152	Outer Joint	48T	24	19	58	91	46.5	I			
	2000.01-		MT/AT			Engine 1SZ-FE	GC059255	Outer Joint	48T	24	19	57.8	91	44.5	M			
<b>WISH</b>																		
-							GC059083	Outer Joint	26	24	58	96	54	I				
							GC059131	Outer Joint	48T	26	24	58	96	54	I			
<b>WISH (ANE10G)</b>																		
2	2003.04-		CVT/I			Engine 1AZ-FSE	GC059175	Outer Joint	48T	26	27	63.3	100	59	M			
<b>WISH (ANE10G,ANE11W)</b>																		
2	2003-		AT			Engine 1AZ-FSE	GC059294	Outer Joint	48T	26	27	63	97	60	M			
<b>WISH (ANE11W)</b>																		
2	2003.04-		CVT/I			Engine 1AZ-FSE	GC059175	Outer Joint	48T	26	27	63.3	100	59	M			
<b>WISH (ZNE10G)</b>																		
1.8	2003.01-		4AT/I			Engine 1ZZ-FE	GC059153	Outer Joint	48T	26	24	58	96	52.5	I			
<b>WISH (ZNE14G)</b>																		
1.8 4WD	2003.01-		4AT/I			Engine 1ZZ-FE	GC059153	Outer Joint	48T	26	24	58	96	52.5	I			
<b>YARIS</b>																		
1.0	2008.01-		MT/AT				GC059384	Outer Joint	26	29	55.6	96	54	I				
<b>YARIS / VITZ (CP90)</b>																		
1.3	2005.01-	2009.01	CVT			Engine 2SZ-FE	GC059385	Outer Joint	26	22	55.6	96	54	I				

		YEAR	TRANSM	L/R	F/R		G-AP Ref.	PRODUCT	ABS	Technical Specifications						
										A	B	C	H	L	P	
<b>TOYOTA</b>																
<b>YARIS / VITZ (NLP13_, NSP13_, NCP13_, KSP13_)</b>																
1.3 (70 kW)	2011.09-		MT	L	F	Hatchback Engine 1NR-FE	GDS59343	Drive Shaft		26	23	55.6	95	658		
	2011.09-		MT	R	F	Hatchback Engine 1NR-FE	GDS59345	Drive Shaft		26	23	55.6	95	897		
1.3 (73 kW)	2011.09-		MT	L	F	Hatchback Engine 1NR-FE	GDS59343	Drive Shaft		26	23	55.6	95	658		
	2011.09-		MT	R	F	Hatchback Engine 1NR-FE	GDS59345	Drive Shaft		26	23	55.6	95	897		
<b>YARIS / VITZ (SCP1_, NLP1_, NCP1_)</b>																
1.0 16V (48 kW)	2002.01-	2005.11			F	Hatchback Engine 1SZ-FE	GC099282	Outer Joint	48T	24	28	56	90	53	O	
	2002.01-	2005.11	MT	L	F	Hatchback Engine 1SZ-FE	GC059129	Outer Joint	48T	24	22	56	90	48.5	I	
	2002.01-	2005.11	MT	L	F	Hatchback Engine 1SZ-FE	GDS59057	Drive Shaft		24	23	56	90	635		
	2002.01-	2005.11	MT	L	F	Hatchback Engine 1SZ-FE	GDS59209	Drive Shaft	48T	24	23	56	90	635		
1.0 16V (50 kW)	1999.04-	2005.09			F	Hatchback Engine 1SZ-FE	GC059025	Outer Joint		24	26	58	90.5	46.5	I	
	1999.04-	2005.09			F	Hatchback Engine 1SZ-FE	GC099282	Outer Joint	48T	24	28	56	90	53	O	
	1999.04-	2005.09			F	Hatchback Engine 1SZ-FE	GC059026	Outer Joint	48T	24	26	58	90.5	46.5	I	
	1999.04-	2005.09		L	F	Hatchback Engine 1SZ-FE	GDS99181	Drive Shaft	48T	24	23	58	91	650		
	1999.04-	2005.09	MT	L	F	Hatchback Engine 1SZ-FE	GC059129	Outer Joint	48T	24	22	56	90	48.5	I	
	1999.04-	2005.09	MT	L	F	Hatchback Engine 1SZ-FE	GDS59057	Drive Shaft		24	23	56	90	635		
	1999.04-	2005.09	MT	L	F	Hatchback Engine 1SZ-FE	GDS59209	Drive Shaft	48T	24	23	56	90	635		
1.3 (64 kW)	2002.04-	2005.09			F	Hatchback Engine 2SZ-FE	GC099282	Outer Joint	48T	24	28	56	90	53	O	
	2002.04-	2005.09			F	Hatchback Engine 2SZ-FE	GC059091	Outer Joint		24	22	58	91	47	I	
1.3 16V (63 kW)	1999.11-	2005.09			F	Hatchback Engine 2NZ-FE	GC059035	Outer Joint	48T	24	22	58	91	47	I	
	1999.11-	2005.09	MT		F	Hatchback Engine 2NZ-FE	GC059091	Outer Joint		24	22	58	91	47	I	
1.4 D-4D (55 kW)	2001.12-	2005.09	5MT		F	Hatchback Engine 1ND-TV	GC059038	Outer Joint		24	23	58	91	52.5	I	
	2001.12-	2005.09	5MT		F	Hatchback Engine 1ND-TV	GC059137	Outer Joint	48T	24	23	58	91	52.5	I	
	2001.12-	2005.09	MT	R	F	Hatchback Engine 1ND-TV	GDS59011	Drive Shaft	48T	24	23	58	91	881.5		
	2001.12-	2005.09			F	Hatchback Engine 1ND-TV	GC099282	Outer Joint	48T	24	28	56	90	53	O	
1.5 TS (77 kW)	2003.01-	2005.09			F	Hatchback Engine 1NZ-FE	GC099282	Outer Joint	48T	24	28	56	90	53	O	
	2003.01-	2005.09	MT	R	F	Hatchback Engine 1NZ-FE	GDS59011	Drive Shaft	48T	24	23	58	91	881.5		
1.5 VVT-i TS (78 kW)	2001.04-	2005.09	5MT		F	Hatchback Engine 1NZ-FE	GC059038	Outer Joint		24	23	58	91	52.5	I	
	2001.04-	2005.09	5MT		F	Hatchback Engine 1NZ-FE	GC059137	Outer Joint	48T	24	23	58	91	52.5	I	
	2001.04-	2005.09	MT	R	F	Hatchback Engine 1NZ-FE	GDS59011	Drive Shaft	48T	24	23	58	91	881.5		
<b>YARIS / VITZ (SCP9_, NSP9_, KSP9_, NCP9_, ZSP9_)</b>																
1.0 VVT-i (51 kW)	2005.08-				F	Hatchback Engine 1KR-FE	GC059297	Outer Joint		26	20	55.6	95	46	I	
	2005.08-				F	Hatchback Engine 1KR-FE	GC059232	Outer Joint		26	20	55.6	95	46	M	
	2005.08-			L/R	F	Hatchback Engine 1KR-FE	GC059332	Outer Joint		26	19	55.6	95	46	M	
	2005.08-		MT	L	F	Hatchback Engine 1KR-FE	GDS59206	Drive Shaft		26	23	55.6	95	670		
	2005.08-		MT	L/R	F	Hatchback Engine 1KR-FE	GC059263	Outer Joint		26	20	55.6	95	46	M	
	2005.08-			L/R	F	Hatchback Engine 1KR-FE	GC059168	Outer Joint	48T	24	22	56	90	48.5	M	
	2005.08-		MT	R	F	Hatchback Engine 1KR-FE	GDS59208	Drive Shaft		26	23	55.6	95	884		
	2005.08-					Hatchback Engine 1KR-FE	GC059231	Outer Joint		26	19	55.6	96	46.5	I	
1.3 VVT-i (63 kW)	2005.11-		AT	L	F	Hatchback Engine 2NZ-FE	GDS59206	Drive Shaft		26	23	55.6	95	670		
	2005.11-		AT	L/R	F	Hatchback Engine 2NZ-FE	GCI59092	Inner Joint		23	20	34	60	101		
	2005.11-		AT	L/R	F	Hatchback Engine 2NZ-FE	GC059263	Outer Joint		26	20	55.6	95	46	M	
	2005.11-		AT	R	F	Hatchback Engine 2NZ-FE	GDS59208	Drive Shaft		26	23	55.6	95	884		
1.3 VVT-i (64 kW)	2005.08-				F	Hatchback Engine 2SZ-FE	GC059232	Outer Joint		26	20	55.6	95	46	M	
	2005.08-			L	F	Hatchback Engine 2SZ-FE	GDS59206	Drive Shaft		26	23	55.6	95	670		
	2005.08-			L/R	F	Hatchback Engine 2SZ-FE	GCI59092	Inner Joint		23	20	34	60	101		
	2005.08-			L/R	F	Hatchback Engine 2SZ-FE	GC059168	Outer Joint	48T	24	22	56	90	48.5	M	
	2005.08-			L/R	F	Hatchback Engine 2SZ-FE	GC059263	Outer Joint		26	20	55.6	95	46	M	
	2005.08-			R	F	Hatchback Engine 2SZ-FE	GDS59208	Drive Shaft		26	23	55.6	95	884		
1.33 VVT-i (73 kW)	2010.07-		MT	L	F	Hatchback Engine 1NR-FE	GDS59343	Drive Shaft		26	23	55.6	95	658		
	2010.07-		MT	R	F	Hatchback Engine 1NR-FE	GDS59345	Drive Shaft		26	23	55.6	95	897		
1.33 VVT-i (74 kW)	2009.03-		MT	L	F	Hatchback Engine 2NR-FE	GDS59343	Drive Shaft		26	23	55.6	95	658		
	2009.03-		MT	R	F	Hatchback Engine 2NR-FE	GDS59345	Drive Shaft		26	23	55.6	95	897		
1.4 D-4D (66 kW)	2008.02-			L/R	F	Hatchback Engine 1ND-TV	GC059270	Outer Joint		26	24	55.6	95	56	M	
	2008.02-			L	F	Hatchback Engine 1ND-TV	GDS59352	Drive Shaft		26		55.6	95	546		
	2008.02-			R	F	Hatchback Engine 1ND-TV	GDS59354	Drive Shaft		26		55.6	95	787		
1.8 VVT-i (98 kW)	2007.04-				Hatchback Engine 2ZR-FE	GCI59100	Inner Joint		20	25	35	63.5	118			
<b>YARIS II (C/SP9)</b>																
1.0 16V (48 kW)	2003.03-						GC099282	Outer Joint	48T	24	28	56	90	53	O	
1.0 16V (50 kW)	2003.03-						GC099282	Outer Joint	48T	24	28	56	90	53	O	
1.3 (64 kW)	2002.04-						GC099282	Outer Joint	48T	24	28	56	90	53	O	









		TRANSM	L/R	F/R		G-AP Ref.	PRODUCT	ABS	Technical Specifications														
									YEAR	A	B	C	H	L	P								
<b>TOYOTA</b>																							
<b>YARIS II (C/SP9)</b>																							
1.4 D-4D (55 kW)	2003.03-					GC099282	Outer Joint	48T	24	28	56	90	53	O									
1.4 D-4D (66 kW)	2006-					GC059270	Outer Joint		26	24	55.6	95	56	M									
1.5 TS (77 kW)	2003.01-				France	GC099282	Outer Joint	48T	24	28	56	90	53	O									
1.8 VVT-i (98 kW)	2007.01-					GC059244	Outer Joint		26	25	55.6	95.5	57	I									
<b>YARIS VERSO ( _NLP2_ , _NCP2_ )</b>																							
1.3 (62 kW)	2003.01-	2006.02			F	MPV Engine 2NZ-FE	GC059038	Outer Joint		24	23	58	91	52.5	I								
	2003.01-	2006.02			F	MPV Engine 2NZ-FE	GC059137	Outer Joint	48T	24	23	58	91	52.5	I								
1.3 (63 kW)	1999.08-	2005.09			F	MPV Engine 2NZ-FE	GC059038	Outer Joint		24	23	58	91	52.5	I								
	1999.08-	2005.09			F	MPV Engine 2NZ-FE	GC059137	Outer Joint	48T	24	23	58	91	52.5	I								
1.4 D-4D (55 kW)	2001.12-	2005.09	5MT		F	MPV Engine 1ND-TV	GC059038	Outer Joint		24	23	58	91	52.5	I								
	2001.12-	2005.09	5MT		F	MPV Engine 1ND-TV	GC059137	Outer Joint	48T	24	23	58	91	52.5	I								
	2001.12-	2005.09	MT	R	F	MPV Engine 1ND-TV	GDS59011	Drive Shaft	48T	24	23	58	91	881.5									
1.5 (77 kW)	2003.05-	2005.09	MT	R	F	MPV Engine 1NZ-FE	GDS59011	Drive Shaft	48T	24	23	58	91	881.5									
1.5 (78 kW)	2000.03-	2005.09	MT	R	F	MPV Engine 1NZ-FE	GDS59011	Drive Shaft	48T	24	23	58	91	881.5									
<b>VAUXHALL</b>																							
<b>ADAM</b>																							
1.2 (51 kW)	2012.10-			L	F	Hatchback Engine A12XEL	GDS44079	Drive Shaft		22	22	51	79.5	615									
	2012.10-			R	F	Hatchback Engine A12XEL	GDS44078	Drive Shaft		22	22	51	79.5	918									
	2012.10-		MT	L	F	Hatchback Engine A12XEL	GDS60023	Drive Shaft		22	22	51.2	79.5	615									
1.4 (64 kW)	2012.10-			L	F	Hatchback Engine A14XEL	GDS44079	Drive Shaft		22	22	51	79.5	615									
	2012.10-			R	F	Hatchback Engine A14XEL	GDS44078	Drive Shaft		22	22	51	79.5	918									
	2012.10-		MT	L	F	Hatchback Engine A14XEL	GDS60023	Drive Shaft		22	22	51.2	79.5	615									
1.4 (74 kW)	2012.10-			L	F	Hatchback Engine A14XER	GDS44079	Drive Shaft		22	22	51	79.5	615									
	2012.10-			R	F	Hatchback Engine A14XER	GDS44078	Drive Shaft		22	22	51	79.5	918									
	2012.10-		MT	L	F	Hatchback Engine A14XER	GDS60023	Drive Shaft		22	22	51.2	79.5	615									
1.4 LPG (64 kW)	2013.07-			L	F	Hatchback Engine A14XEL	GDS60023	Drive Shaft		22	22	51.2	79.5	615									
<b>AGILA A (H00)</b>																							
1.0 (44 kW)	2003.08-						GC099110	Outer Joint		23	20	49	78	61	M								
	2003.08-						GC044001	Outer Joint	43T	23	20	49	78	61	M								
1.0 12V (43 kW)	2000.09-						GC099110	Outer Joint		23	20	49	78	61	M								
	2000.09-						GC044001	Outer Joint	43T	23	20	49	78	61	M								
1.2 16V (55 kW)	2000.09-						GC099110	Outer Joint		23	20	49	78	61	M								
	2000.09-						GC044001	Outer Joint	43T	23	20	49	78	61	M								
1.2 16V Twinport (59 kW)	2004.07-						GC099110	Outer Joint		23	20	49	78	61	M								
	2004.07-						GC044001	Outer Joint	43T	23	20	49	78	61	M								
<b>AGILA B</b>																							
1.0 (50 kW)	2011-					Ch-AM999999	GC044085	Outer Joint		25	20	49	81.5	61	M								
1.0 12V (48 kW)	2007.09-					Ch-AM999999	GC044085	Outer Joint		25	20	49	81.5	61	M								
1.0 LPG (48 kW)	2010-					Ch-AM999999	GC044085	Outer Joint		25	20	49	81.5	61	M								
1.2 16V (63 kW)	2007.09-						GC044085	Outer Joint		25	20	49	81.5	61	M								
1.2 16V (69 kW)	2007.09-						GC044085	Outer Joint		25	20	49	81.5	61	M								
<b>AGILA I (A)</b>																							
1.0 12V (43 kW)	2000.09-	2005.08			F	Hatchback Engine Z10XE	GC044001	Outer Joint	43T	23	20	49	78	61	M								
	2000.09-	2005.08			F	Hatchback Engine Z10XE	GC099110	Outer Joint		23	20	49	78	61	M								
	2000.09-	2005.08	MT	L	F	Hatchback Engine Z10XE	GDS57087	Drive Shaft	43T	23	22	49	78	638									
1.0 12V (44 kW)	2000.02-	2006.11	MT	L	F	Hatchback Engine Z10XEP	GDS57087	Drive Shaft	43T	23	22	49	78	638									
1.2 16V (55 kW)	2000.09-	2008.03			F	Hatchback Engine Z12XE	GC044001	Outer Joint	43T	23	20	49	78	61	M								
	2000.09-	2008.03			F	Hatchback Engine Z12XE	GC099110	Outer Joint		23	20	49	78	61	M								
	2000.09-	2008.03	MT	R	F	Hatchback Engine Z12XE	GDS44043	Drive Shaft	43T	23	22	49	78	853									
<b>AGILA II (B)</b>																							
1.0 12V (48 kW)	2008.01-		MT	L	F	Hatchback Engine K10B	GDS57175	Drive Shaft		25	22	49	82	635									
	2008.01-		MT	L/R	F	Hatchback Engine K10B	GC044085	Outer Joint		25	20	49	81.5	61	M								
	2008.01-		MT	R	F	Hatchback Engine K10B	GDS57221	Drive Shaft		25	22	49	81.5	882									
1.0 i (50 kW)	2011.08-		MT	L	F	Hatchback Engine K10B	GDS57175	Drive Shaft		25	22	49	82	635									
1.2 i 16V (63 kW)	2008.01-		MT	L	F	Hatchback Engine K12B	GDS57222	Drive Shaft		25	22	49	81.5	641									
	2008.01-		MT	L/R	F	Hatchback Engine K12B	GC044085	Outer Joint		25	20	49	81.5	61	M								
	2008.01-		MT	R	F	Hatchback Engine K12B	GDS57221	Drive Shaft		25	22	49	81.5	882									
1.2 i 16V (69 kW)	2008.01-		MT	L	F	Hatchback Engine K12B	GDS57175	Drive Shaft		25	22	49	82	635									
	2008.01-		MT	L/R	F	Hatchback Engine K12B	GC044085	Outer Joint		25	20	49	81.5	61	M								
	2008.01-		MT	R	F	Hatchback Engine K12B	GDS57221	Drive Shaft		25	22	49	81.5	882									

		YEAR	TRANSM	L/R	F/R		G-AP Ref.	PRODUCT	ABS	Technical Specifications						
										A	B	C	H	L	P	
<b>VAUXHALL</b>																
<b>AGILA II (B)</b>																
1.3 CDTi (55 kW)	2008.01-		MT	L	F	Hatchback Engine Z13DTJ/D13A	GDS57223	Drive Shaft		25	26	49	81.5	629		
	2008.01-		MT	R	F	Hatchback Engine Z13DTJ/D13A	GDS57197	Drive Shaft		25	22	49	81.5	614		
	2008.01-		MT		F	Hatchback Engine Z13DTJ/D13A	GDS57210	Drive Shaft		25	26	49	81.5	630		
<b>ARENA</b>																
1.9 D (44 kW)	1998.03-	2001.08	MT	L/R	F	Bus Engine F8Q600/F8Q606	GDS44006	Drive Shaft		25	27	56.3	110.5	713.5		
2.5 D (55 kW)	1998.03-	2001.08	MT	L/R	F	Bus Engine S8U758/S8U780/S8U782	GDS44006	Drive Shaft		25	27	56.3	110.5	713.5		
<b>ARENA VAN</b>																
1.9 D (44 kW)	1998.03-	2001.08	MT	L/R	F	Box Engine F8Q600/F8Q606	GDS44006	Drive Shaft		25	27	56.3	110.5	713.5		
2.5 D (55 kW)	1998.03-	2001.08	MT	L/R	F	Box Engine S8U758/S8U780/S8U782	GDS44006	Drive Shaft		25	27	56.3	110.5	713.5		
<b>ASTRA</b>																
1.2 S (44 kW)	1982.02-	1984.08	MT		F	Hatchback Engine 12S	GCI44004	Inner Joint		22	22	34.95	57.5	72.5		
	1982.02-	1984.08	MT		F	Hatchback Engine 12S	GC044041	Outer Joint		22	22	52	95	50	O	
1.3 S (55 kW)	1979.09-	1984.08	MT		F	Estate Engine 13S	GCI44004	Inner Joint		22	22	34.95	57.5	72.5		
	1979.09-	1984.08	MT		F	Hatchback Engine 13S	GCI44004	Inner Joint		22	22	34.95	57.5	72.5		
	1979.09-	1984.08	MT		F	Estate Engine 13S	GC044041	Outer Joint		22	22	52	95	50	O	
	1979.09-	1984.08	MT		F	Hatchback Engine 13S	GC044041	Outer Joint		22	22	52	95	50	O	
1.6 D (40 kW)	1982.02-	1986.08	MT		F	Hatchback Engine 16D	GCI44002	Inner Joint		34	25	35	56.2	85.6		
	1982.02-	1986.08	MT		F	Estate Engine 16D	GC099205	Outer Joint		33	25	52	109	61	O	
	1982.03-	1986.08	MT		F	Hatchback Engine 16D	GCI44002	Inner Joint		34	25	35	56.2	85.6		
	1982.03-	1986.08	MT		F	Hatchback Engine 16D	GC099205	Outer Joint		33	25	52	109	61	O	
1.6 S (66 kW)	1981.09-	1986.08	MT		F	Estate Engine 16SH	GCI44002	Inner Joint		34	25	35	56.2	85.6		
	1981.09-	1986.08	MT		F	Hatchback Engine 16S	GCI44002	Inner Joint		34	25	35	56.2	85.6		
	1981.09-	1986.08	MT		F	Estate Engine 16SH	GC099205	Outer Joint		33	25	52	109	61	O	
	1981.09-	1986.08	MT		F	Hatchback Engine 16S	GC099205	Outer Joint		33	25	52	109	61	O	
	1981.09-	1986.08	MT		F	Estate Engine 16SH	GCI44001	Inner Joint		34	22	35	56.2	76		
	1981.09-	1986.08	MT		F	Hatchback Engine 16S	GCI44001	Inner Joint		34	22	35	56.2	76		
1.8 GTE (85 kW)	1983.03-	1986.08	MT		F	Hatchback Engine 18E	GCI44002	Inner Joint		34	25	35	56.2	85.6		
	1983.03-	1986.08	MT		F	Hatchback Engine 18E	GC099205	Outer Joint		33	25	52	109	61	O	
<b>ASTRA F</b>																
1.4	1994.01-	1998.03	AT				GC044024	Outer Joint		22	22	52.2	97	50	O	
	1994.01-	1998.03	MT				GC044024	Outer Joint		22	22	52.2	97	50	O	
1.4/1.6	1991-	1998	MT	L	F		GDS60010	Drive Shaft		22	22	52.2	97	587		
1.6	1994.01-	1998.03	MT				GC044024	Outer Joint		22	22	52.2	97	50	O	
	1994.01-	1998.03	AT				GC044024	Outer Joint		22	22	52.2	97	50	O	
<b>ASTRA F CLASSIC, SW</b>																
1.4 i (44 kW)	1998-	2004				Ch-P2732834	GC044060	Outer Joint	29T	22	22	52	98	51	O	
1.4 i (46 kW)	1998-	2004				Ch-P2732834	GC044060	Outer Joint	29T	22	22	52	98	51	O	
1.6 i 16V (55 kW)	1998-	2004					GC044006	Outer Joint	29T	33	25	52	103.5	61	O	
1.7 TD (50 kW)	1998-	2000				Ch-P8202126	GC044060	Outer Joint	29T	22	22	52	98	51	O	
1.8 i (85 kW)	1998-	2000					GC044006	Outer Joint	29T	33	25	52	103.5	61	O	
2.0 i (100 kW)	1998-	2000				Ch-P8202126	GC044060	Outer Joint	29T	22	22	52	98	51	O	
<b>ASTRA G</b>																
1.4 16V	1998.04-	2004.12	MT	R	F		GDS60014	Drive Shaft		33	22	52	108	964		
1.6 8V/16V	1998.04-	2004.12	MT/AT	R	F		GDS60014	Drive Shaft		33	22	52	108	964		
<b>ASTRA G, SW</b>																
-	1998-					Classic Ch.-No YG039154-/ 1G043744-.Exc.Italy	GC044033	Outer Joint		22	22	52	98	51	O	
1.4 (66 kW)	2003.09-	2005.01					GCI21014	Inner Joint		22	22	35	57.5	75		
1.4 16V (66 kW)	1998.02-	2005.01					GCI21014	Inner Joint		22	22	35	57.5	75		
1.6 (62 kW)	2000.09-	2005.01					GCI21014	Inner Joint		22	22	35	57.5	75		
1.6 16V (74 kW)	1998.02-	2005.01					GCI21014	Inner Joint		22	22	35	57.5	75		
1.6 16V (76 kW)	1998.02-	2005.01					GCI21014	Inner Joint		22	22	35	57.5	75		
1.6 i 16V (55 kW)	1998-	2000					GCI21014	Inner Joint		22	22	35	57.5	75		
1.7 CDTi (59 kW)	2000.02-	2005.01					GCI21014	Inner Joint		22	22	35	57.5	75		
1.7 DTi 16V (48 kW)	2000.02-	2005.01					GCI99026	Inner Joint		22	25	35	57	82.5		
	2000.02-	2005.01					GC044006	Outer Joint	29T	33	25	52	103.5	61	O	
1.7 DTi 16V (55 kW)	2000.02-	2005.01					GCI99026	Inner Joint		22	25	35	57	82.5		
	2000.02-	2005.01					GC044006	Outer Joint	29T	33	25	52	103.5	61	O	
1.7 TD (50 kW)	1998.02-	2000.08					GCI21014	Inner Joint		22	22	35	57.5	75		
1.8 16V (85 kW)	1998.02-	2005.01					GCI99026	Inner Joint		22	25	35	57	82.5		
1.8 16V (87 kW)	1998.02-	2005.01					GCI99026	Inner Joint		22	25	35	57	82.5		
1.8 16V (92 kW)	1998.02-	2005.01					GCI99026	Inner Joint		22	25	35	57	82.5		
2.0 16V (100 kW)	1998.02-	2005.01					GCI21011	Inner Joint		34	25	35	78	64		



		TRANSM	L/R	F/R		G-AP Ref.	PRODUCT	ABS	Technical Specifications							
									YEAR	A	B	C	H	L	P	
<b>VAUXHALL</b>																
<b>ASTRA G, SW</b>																
2.0 16V (100 kW)	1998.02-	2005.01				GC044006	Outer Joint	29T	33	25	52	103.5	61	O		
2.0 16V OPC (118 kW)	1999.11-	2002.09				GCI21011	Inner Joint		34	25	35	78	64			
	1999.11-	2002.09				GC044006	Outer Joint	29T	33	25	52	103.5	61	O		
2.0 Di 16V (60 kW)	1998.02-	2005.01				GC044006	Outer Joint	29T	33	25	52	103.5	61	O		
2.0 DI 16V (60 kW)	1998.02-	2005.01				GCI21011	Inner Joint		34	25	35	78	64			
2.0 DTi 16V (74 kW)	1999.08-	2005.01				GCI21011	Inner Joint		34	25	35	78	64			
	1999.08-	2005.01				GC044006	Outer Joint	29T	33	25	52	103.5	61	O		
2.2 16V (108 kW)	2001.03-	2005.01				GCI21011	Inner Joint		34	25	35	78	64			
	2001.03-	2005.01				GC044006	Outer Joint	29T	33	25	52	103.5	61	O		
<b>ASTRA GTC MK VI (J)</b>																
1.6 CDTi (100 kW)	2014.07-				Hatchback Engine B16DTH	GC099023	Outer Joint		30	26	53.8	94.5	65.5	M		
1.6 CDTi (81 kW)	2014.07-				Hatchback Engine B16DTL	GC099023	Outer Joint		30	26	53.8	94.5	65.5	M		
1.6 SiDi (125 kW)	2012.12-				Hatchback Engine A16XHT	GC099023	Outer Joint		30	26	53.8	94.5	65.5	M		
1.6 SiDi (147 kW)	2013.09-				Hatchback Engine A16SHT/B16SHT	GC099023	Outer Joint		30	26	53.8	94.5	65.5	M		
<b>ASTRA GTC VI (J)</b>																
1.4 (103 kW)	2011.10-		AT		Hatchback Engine A14NET	GC088047	Outer Joint		33	23	52.5	94	59.5	M		
1.4 (74 kW)	2011.10-		MT	L F	Hatchback Engine A14XER	GDS44064	Drive Shaft		33	22	53	95	618			
	2011.10-		MT	L F	Hatchback Engine A14XER	GCI21014	Inner Joint		22	22	35	57.5	75			
1.6 (132 kW)	2011.10-				Hatchback Engine A16LET	GC099023	Outer Joint		30	26	53.8	94.5	65.5	M		
1.7 CDTi (81 kW)	2011.10-		MT	L F	Hatchback Engine A17DTC/A17DTE/A17DTJ	GDS21076	Drive Shaft		30	25	52.5	94	601			
	2011.10-		MT	R F	Hatchback Engine A17DTC/A17DTE/A17DTJ	GDS21074	Drive Shaft		30	34	52.5	94	589			
	2011.10-				Hatchback Engine A17DTC/A17DTE/A17DTJ	GC099023	Outer Joint		30	26	53.8	94.5	65.5	M		
1.7 CDTi (96 kW)	2011.10-		MT	L F	Hatchback Engine A17DTF/A17DTS	GDS21076	Drive Shaft		30	25	52.5	94	601			
2.0 CDTi (121 kW)	2011.10-		MT	R F	Hatchback Engine A20DTH	GDS21036	Drive Shaft		30	27	55.4	100	602			
	2011.10-				Hatchback Engine A20DTH	GC099023	Outer Joint		30	26	53.8	94.5	65.5	M		
<b>ASTRA H CABRIO</b>																
1.6 (85 kW)	2006-					GC044003	Outer Joint		33	22	53	95	54.5	M		
1.6 (85 kW)	2006-					GCI21014	Inner Joint		22	22	35	57.5	75			
1.6 16V (77 kW)	2005-					GC044003	Outer Joint		33	22	53	95	54.5	M		
1.6 16V (77 kW)	2005-					GCI21014	Inner Joint		22	22	35	57.5	75			
1.6 T (132 kW)	2006-					GC044028	Outer Joint		33	24	53	93.5	63.5	M		
1.8 16V (103 kW)	2005-					GC044028	Outer Joint		33	24	53	93.5	63.5	M		
1.8 16V (92 kW)	2005-					GC044028	Outer Joint		33	24	53	93.5	63.5	M		
2.0 T (125 kW)	2005.09-					GC044027	Outer Joint		33	26	52.5	94	65.5	M		
2.0 T 16V (147 kW)	2005.09-					GC044027	Outer Joint		33	26	52.5	94	65.5	M		
<b>ASTRA H, GTC, SW</b>																
1.2 (59 kW)	2006.10-					GCI21014	Inner Joint		22	22	35	57.5	75			
	2006.10-					GC044003	Outer Joint		33	22	53	95	54.5	M		
1.3 CDTi 16V (66 kW)	2005.04-			L		GCI21011	Inner Joint		34	25	35	78	64			
	2005.04-					GC044028	Outer Joint		33	24	53	93.5	63.5	M		
1.4 (55 kW)	2004-					GCI21014	Inner Joint		22	22	35	57.5	75			
	2004-					GC044003	Outer Joint		33	22	53	95	54.5	M		
1.4 16V (66 kW)	2005.03-					GCI21014	Inner Joint		22	22	35	57.5	75			
	2005.03-					GC044003	Outer Joint		33	22	53	95	54.5	M		
1.6 16V (77 kW)	2005.03-					GCI21014	Inner Joint		22	22	35	57.5	75			
	2005.03-					GC044003	Outer Joint		33	22	53	95	54.5	M		
1.6 16V (85 kW)	2005.03-					GCI21014	Inner Joint		22	22	35	57.5	75			
	2005.03-					GC044003	Outer Joint		33	22	53	95	54.5	M		
1.6 Turbo 16V (132 kW)	2007.02-					GCI99026	Inner Joint		22	25	35	57	82.5			
	2007.02-					GC044028	Outer Joint		33	24	53	93.5	63.5	M		
1.7 CDTi (59 kW)	2005.03-					GC044028	Outer Joint		33	24	53	93.5	63.5	M		
1.7 CDTi (74 kW)	2005.03-			L		GCI21011	Inner Joint		34	25	35	78	64			
	2005.03-					GC044028	Outer Joint		33	24	53	93.5	63.5	M		
1.7 CDTi (81 kW)	2007.02-					GC044027	Outer Joint		33	26	52.5	94	65.5	M		
1.7 CDTi (92 kW)	2007.02-					GC044027	Outer Joint		33	26	52.5	94	65.5	M		
1.8 16V (103 kW)	2005.03-					GCI99026	Inner Joint		22	25	35	57	82.5			
	2005.03-					GC044028	Outer Joint		33	24	53	93.5	63.5	M		
	2007-					GCI21014	Inner Joint		22	22	35	57.5	75			





		TRANSM	L/R	F/R		G-AP Ref.	PRODUCT	ABS	Technical Specifications						
									A	B	C	H	L	P	
YEAR															
<b>VAUXHALL</b>															
<b>ASTRA H, GTC, SW</b>															
1.8 16V (103 kW)	2007-					GC044003	Outer Joint		33	22	53	95	54.5	M	
1.8 16V (92 kW)	2005.03-					GC199026	Inner Joint		22	25	35	57	82.5		
	2005.03-					GC044028	Outer Joint		33	24	53	93.5	63.5	M	
1.9 CDTi (103 kW)	2006.01-					GC044027	Outer Joint		33	26	52.5	94	65.5	M	
1.9 CDTi (74 kW)	2005.03-					GC044003	Outer Joint		33	22	53	95	54.5	M	
	2006.01-					GC044027	Outer Joint		33	26	52.5	94	65.5	M	
1.9 CDTi (88 kW)	2006.01-					GC044027	Outer Joint		33	26	52.5	94	65.5	M	
2.0 Turbo (125 kW)	2005.03-					GC044027	Outer Joint		33	26	52.5	94	65.5	M	
2.0 Turbo (147 kW)	2005.03-					GC044027	Outer Joint		33	26	52.5	94	65.5	M	
<b>ASTRA II</b>															
1.2 (44 kW)	1984.09-1988.12	MT		F	Estate Engine 12S	GC144004	Inner Joint		22	22	34.95	57.5	72.5		
	1984.09-1991.08	MT		F	Hatchback Engine 12S	GC144004	Inner Joint		22	22	34.95	57.5	72.5		
	1984.09-1988.12	MT		F	Estate Engine 12S	GC044041	Outer Joint		22	22	52	95	50	O	
	1984.09-1991.08	MT		F	Hatchback Engine 12S	GC044041	Outer Joint		22	22	52	95	50	O	
	1984.09-1988.12	MT		F	Estate Engine 12S	GC044051	Outer Joint	29T	22	22	52	95	50.5	O	
1.3 (55 kW)	1984.09-1991.08	MT		F	Hatchback Engine 12S	GC044051	Outer Joint	29T	22	22	52	95	50.5	O	
	1984.09-1991.08	MT		F	Estate Engine 13S	GCI44004	Inner Joint		22	22	34.95	57.5	72.5		
	1984.09-1991.08	MT		F	Hatchback Engine 13S	GCI44004	Inner Joint		22	22	34.95	57.5	72.5		
	1984.09-1991.08	MT/AT		F	Estate Engine 13S	GC044041	Outer Joint		22	22	52	95	50	O	
	1984.09-1991.08	MT/AT		F	Hatchback Engine 13S	GC044041	Outer Joint		22	22	52	95	50	O	
1.4 i (44 kW)	1984.09-1991.08	MT		F	Estate Engine 13S	GC044051	Outer Joint	29T	22	22	52	95	50.5	O	
	1984.09-1991.08	MT		F	Hatchback Engine 13S	GC044051	Outer Joint	29T	22	22	52	95	50.5	O	
	1990.01-1991.08	MT		F	Estate Engine 13S	GC044051	Outer Joint	29T	22	22	52	95	50.5	O	
	1990.01-1991.08	MT		F	Hatchback Engine C14NZ	GCI44004	Inner Joint		22	22	34.95	57.5	72.5		
	1990.01-1991.08	MT		F	Hatchback Engine C14NZ	GC044041	Outer Joint		22	22	52	95	50	O	
1.4 S (55 kW)	1990.01-1991.08	MT		F	Hatchback Engine C14NZ	GC044051	Outer Joint	29T	22	22	52	95	50.5	O	
	1990.01-1991.08	MT		F	Hatchback Engine 14NV	GCI44004	Inner Joint		22	22	34.95	57.5	72.5		
	1990.01-1991.08	MT		F	Hatchback Engine 14NV	GC044041	Outer Joint		22	22	52	95	50	O	
	1990.01-1991.08	MT		F	Hatchback Engine 14NV	GC044051	Outer Joint	29T	22	22	52	95	50.5	O	
	1990.01-1991.08	MT		F	Hatchback Engine 14NV	GC044051	Outer Joint	29T	22	22	52	95	50.5	O	
1.6 (60 kW)	1984.09-1991.08	MT		F	Estate Engine 16SV	GC099205	Outer Joint		33	25	52	109	61	O	
	1984.09-1991.08	MT		F	Hatchback Engine 16SV	GC099205	Outer Joint		33	25	52	109	61	O	
	1984.09-1991.08	MT		F	Estate Engine 16SV	GCI44001	Inner Joint		34	22	35	56.2	76		
	1984.09-1991.08	MT		F	Hatchback Engine 16SV	GCI44001	Inner Joint		34	22	35	56.2	76		
	1984.09-1991.08	MT		F	Hatchback Engine 16SV	GCI44001	Inner Joint		34	22	35	56.2	76		
1.6 D (40 kW)	1984.09-1989.12	MT		F	Estate Engine 16DA	GC099205	Outer Joint		33	25	52	109	61	O	
	1984.09-1989.12	MT		F	Hatchback Engine 16DA	GC099205	Outer Joint		33	25	52	109	61	O	
	1984.09-1989.12	MT		F	Estate Engine 16DA	GCI44001	Inner Joint		34	22	35	56.2	76		
	1984.09-1989.12	MT		F	Hatchback Engine 16DA	GCI44001	Inner Joint		34	22	35	56.2	76		
	1984.09-1989.12	MT		F	Estate Engine 16DA	GCI44004	Inner Joint		22	22	34.95	57.5	72.5		
	1984.09-1989.12	MT		F	Hatchback Engine 16DA	GCI44004	Inner Joint		22	22	34.95	57.5	72.5		
	1984.09-1989.12	MT		F	Estate Engine 16DA	GC044056	Outer Joint	29T	33	25	52	109	61	O	
	1984.09-1989.12	MT		F	Hatchback Engine 16DA	GC044056	Outer Joint	29T	33	25	52	109	61	O	
	1984.09-1989.12	MT		F	Estate Engine 16DA	GC044057	Outer Joint	43T	33	25	52	109	61	O	
	1984.09-1989.12	MT		F	Hatchback Engine 16DA	GC044057	Outer Joint	43T	33	25	52	109	61	O	
1.6 i (60 kW)	1987.01-1991.12	MT		F	Convertible Engine 16SV	GC099205	Outer Joint		33	25	52	109	61	O	
	1987.01-1991.12	MT		F	Convertible Engine 16SV	GCI44001	Inner Joint		34	22	35	56.2	76		
1.6 i CAT (55 kW)	1987.10-1993.02	MT		F	Convertible Engine C16LZ/C16NZ	GCI44004	Inner Joint		22	22	34.95	57.5	72.5		
	1987.10-1993.02	MT/AT		F	Convertible Engine C16LZ/C16NZ	GC044041	Outer Joint		22	22	52	95	50	O	
	1987.10-1993.02	MT		F	Convertible Engine C16LZ/C16NZ	GC044051	Outer Joint	29T	22	22	52	95	50.5	O	
	1987.10-1993.02	AT		F	Convertible Engine C16LZ/C16NZ	GC044057	Outer Joint	43T	33	25	52	109	61	O	
1.6 S (66 kW)	1984.09-1986.08	MT		F	Estate Engine 16S/16SH	GC099205	Outer Joint		33	25	52	109	61	O	
	1984.09-1986.08	MT		F	Hatchback Engine 16SH	GC099205	Outer Joint		33	25	52	109	61	O	
	1984.09-1986.08	MT		F	Estate Engine 16S/16SH	GCI44001	Inner Joint		34	22	35	56.2	76		
	1984.09-1986.08	MT		F	Hatchback Engine 16SH	GCI44001	Inner Joint		34	22	35	56.2	76		
1.7 D (42 kW)	1989.01-1991.08	MT		F	Hatchback Engine 17DR	GCI44002	Inner Joint		34	25	35	56.2	85.6		
	1989.01-1991.08	MT		F	Hatchback Engine 17DR	GC099205	Outer Joint		33	25	52	109	61	O	
	1989.01-1991.08	MT		F	Hatchback Engine 17DR	GC044056	Outer Joint	29T	33	25	52	109	61	O	
	1989.01-1991.08	MT		F	Hatchback Engine 17DR	GC044057	Outer Joint	43T	33	25	52	109	61	O	
	1989.02-1991.08	MT		F	Estate Engine 17D	GCI44002	Inner Joint		34	25	35	56.2	85.6		
	1989.02-1991.08	MT		F	Estate Engine 17D	GC099205	Outer Joint		33	25	52	109	61	O	
	1989.02-1991.08	MT		F	Estate Engine 17D	GC044056	Outer Joint	29T	33	25	52	109	61	O	
1.8 GTE (82 kW)	1989.02-1991.08	MT		F	Estate Engine 17D	GC044057	Outer Joint	43T	33	25	52	109	61	O	
	1984.09-1991.08	MT		F	Hatchback Engine 18E/18SE	GCI44002	Inner Joint		34	25	35	56.2	85.6		



		TRANSM	L/R	F/R		G-AP Ref.	PRODUCT	ABS	Technical Specifications						
									YEAR	A	B	C	H	L	P
<b>VAUXHALL</b>															
<b>ASTRA II</b>															
1.8 GTE (82 kW)	1984.09-1991.08	MT		F	Hatchback Engine 18E/18SE	GCO99205	Outer Joint		33	25	52	109	61	O	
	1984.09-1991.08	MT		F	Hatchback Engine 18E/18SE	GCO44056	Outer Joint	29T	33	25	52	109	61	O	
1.8 i (83 kW)	1990.01-1991.08	MT		F	Estate Engine 18E	GCI44002	Inner Joint		34	25	35	56.2	85.6		
	1990.01-1991.08	MT		F	Estate Engine 18E	GCO99205	Outer Joint		33	25	52	109	61	O	
	1990.01-1991.08	MT		F	Estate Engine 18E	GCO44056	Outer Joint	29T	33	25	52	109	61	O	
	1990.01-1991.08	MT		F	Estate Engine 18E	GCO44057	Outer Joint	43T	33	25	52	109	61	O	
2.0 i (85 kW)	1987.01-1991.12	MT		F	Convertible Engine 20NE	GCI44002	Inner Joint		34	25	35	56.2	85.6		
	1987.01-1991.12	MT		F	Convertible Engine 20NE	GCO99205	Outer Joint		33	25	52	109	61	O	
	1987.01-1991.12	MT		F	Convertible Engine 20NE	GCO44056	Outer Joint	29T	33	25	52	109	61	O	
	1987.01-1991.12	MT		F	Convertible Engine 20NE	GCO44057	Outer Joint	43T	33	25	52	109	61	O	
<b>ASTRA III (F)</b>															
1.4 i (44 kW)	1991.09-1998.02	MT	L	F	Estate Engine C14NZ	GDS44002	Drive Shaft	29T	22	22	52	95	585		
	1991.09-1998.02	MT	L	F	Hatchback Engine C14NZ	GDS44002	Drive Shaft	29T	22	22	52	95	585		
	1991.09-1998.02	MT		F	Estate Engine C14NZ	GCI44004	Inner Joint		22	22	34.95	57.5	72.5		
	1991.09-1998.02	MT		F	Hatchback Engine C14NZ	GCI44004	Inner Joint		22	22	34.95	57.5	72.5		
	1991.09-1998.02	MT		F	Estate Engine C14NZ	GCO44051	Outer Joint	29T	22	22	52	95	50.5	O	
	1991.09-1998.02	MT		F	Hatchback Engine C14NZ	GCO44051	Outer Joint	29T	22	22	52	95	50.5	O	
	1992.04-1998.09	MT	L	F	Saloon Engine C14NZ	GDS44002	Drive Shaft	29T	22	22	52	95	585		
	1992.04-1998.09	MT		F	Saloon Engine C14NZ	GCI44004	Inner Joint		22	22	34.95	57.5	72.5		
1.4 i (60 kW)	1992.04-1998.09	MT		F	Saloon Engine C14NZ	GCO44051	Outer Joint	29T	22	22	52	95	50.5	O	
	1991.03-1998.02	MT	L	F	Estate Engine C14SE	GDS44002	Drive Shaft	29T	22	22	52	95	585		
	1991.03-1998.02	MT		F	Estate Engine C14SE	GCI44004	Inner Joint		22	22	34.95	57.5	72.5		
	1991.03-1998.02	MT		F	Estate Engine C14SE	GCO44051	Outer Joint	29T	22	22	52	95	50.5	O	
	1992.03-1998.02	MT	L	F	Hatchback Engine C14SE	GDS44002	Drive Shaft	29T	22	22	52	95	585		
	1992.03-1998.02	MT		F	Hatchback Engine C14SE	GCI44004	Inner Joint		22	22	34.95	57.5	72.5		
	1992.03-1998.02	MT		F	Hatchback Engine C14SE	GCO44051	Outer Joint	29T	22	22	52	95	50.5	O	
	1992.04-1998.09	MT	L	F	Saloon Engine C14SE	GDS44002	Drive Shaft	29T	22	22	52	95	585		
	1992.04-1998.09	MT		F	Saloon Engine C14SE	GCI44004	Inner Joint		22	22	34.95	57.5	72.5		
	1992.04-1998.09	MT		F	Saloon Engine C14SE	GCO44051	Outer Joint	29T	22	22	52	95	50.5	O	
	1993.05-2001.03	MT	L	F	Convertible Engine C14SE	GDS44002	Drive Shaft	29T	22	22	52	95	585		
	1993.05-2001.03	MT		F	Convertible Engine C14SE	GCI44004	Inner Joint		22	22	34.95	57.5	72.5		
1.4 S (55 kW)	1993.05-2001.03	MT		F	Convertible Engine C14SE	GCO44051	Outer Joint	29T	22	22	52	95	50.5	O	
	1991.09-1998.02	MT	L	F	Estate Engine 14NV	GDS44002	Drive Shaft	29T	22	22	52	95	585		
	1991.09-1998.02	MT	L	F	Hatchback Engine 14NV	GDS44002	Drive Shaft	29T	22	22	52	95	585		
	1991.09-1998.02	MT		F	Estate Engine 14NV	GCI44004	Inner Joint		22	22	34.95	57.5	72.5		
	1991.09-1998.02	MT		F	Hatchback Engine 14NV	GCI44004	Inner Joint		22	22	34.95	57.5	72.5		
	1991.09-1998.02	MT		F	Estate Engine 14NV	GCO44051	Outer Joint	29T	22	22	52	95	50.5	O	
1.6 i (52 kW)	1991.09-1998.02	MT		F	Hatchback Engine 14NV	GCO44051	Outer Joint	29T	22	22	52	95	50.5	O	
	1993.03-1996.08	MT		F	Convertible Engine X16SZ	GCI44004	Inner Joint		22	22	34.95	57.5	72.5		
	1994.07-1998.02	MT		F	Estate Engine X16SZ	GCI44004	Inner Joint		22	22	34.95	57.5	72.5		
	1994.07-1998.02	MT		F	Hatchback Engine X16SZ	GCI44004	Inner Joint		22	22	34.95	57.5	72.5		
1.6 i (55 kW)	1994.08-1996.07	MT		F	Saloon Engine X16SZ	GCI44004	Inner Joint		22	22	34.95	57.5	72.5		
	1991.09-1998.02	MT	L	F	Estate Engine C16NZ/E16NZ	GDS44002	Drive Shaft	29T	22	22	52	95	585		
	1991.09-1998.02	MT	L	F	Hatchback Engine C16NZ/E16NZ	GDS44002	Drive Shaft	29T	22	22	52	95	585		
	1991.09-1998.02	MT		F	Estate Engine C16NZ/E16NZ	GCI44004	Inner Joint		22	22	34.95	57.5	72.5		
	1991.09-1998.02	MT		F	Hatchback Engine C16NZ/E16NZ	GCI44004	Inner Joint		22	22	34.95	57.5	72.5		
	1991.09-1998.02	MT/AT		F	Estate Engine C16NZ/E16NZ	GCO44051	Outer Joint	29T	22	22	52	95	50.5	O	
	1991.09-1998.02	MT/AT		F	Hatchback Engine C16NZ/E16NZ	GCO44051	Outer Joint	29T	22	22	52	95	50.5	O	
	1992.03-1998.09	MT	L	F	Saloon Engine C16NZ/X16SZR	GDS44002	Drive Shaft	29T	22	22	52	95	585		
1.6 i (74 kW)	1992.03-1998.09	MT		F	Saloon Engine C16NZ/X16SZR	GCI44004	Inner Joint		22	22	34.95	57.5	72.5		
	1992.03-1998.09	MT/AT		F	Saloon Engine C16NZ/X16SZR	GCO44051	Outer Joint	29T	22	22	52	95	50.5	O	
	1992.03-1998.02	MT	L	F	Hatchback Engine C16SE	GDS44002	Drive Shaft	29T	22	22	52	95	585		
	1992.03-1998.02	MT		F	Hatchback Engine C16SE	GCI44004	Inner Joint		22	22	34.95	57.5	72.5		
	1992.03-1998.02	MT		F	Hatchback Engine C16SE	GCO44051	Outer Joint	29T	22	22	52	95	50.5	O	
	1992.05-1994.12	MT	L	F	Saloon Engine C16SE	GDS44002	Drive Shaft	29T	22	22	52	95	585		
1.6 i 16V (74 kW)	1992.05-1994.12	MT		F	Saloon Engine C16SE	GCI44004	Inner Joint		22	22	34.95	57.5	72.5		
	1992.05-1994.12	MT		F	Saloon Engine C16SE	GCO44051	Outer Joint	29T	22	22	52	95	50.5	O	
	1994.01-1998.02	MT		F	Estate Engine X16XEL	GCI44004	Inner Joint		22	22	34.95	57.5	72.5		
	1994.01-1998.02	MT		F	Hatchback Engine X16XEL	GCI44004	Inner Joint		22	22	34.95	57.5	72.5		
1.6 Si (74 kW)	1994.08-1998.09	MT		F	Saloon Engine X16XEL	GCI44004	Inner Joint		22	22	34.95	57.5	72.5		
	1991.03-1994.12	MT	L	F	Estate Engine C16SE	GDS44002	Drive Shaft	29T	22	22	52	95	585		





		TRANSM	L/R	F/R		G-AP Ref.	PRODUCT	ABS	Technical Specifications									
									YEAR	A	B	C	H	L	P			
<b>VAUXHALL</b>																		
<b>ASTRA III (F)</b>																		
1.6 Si (74 kW)	1991.03-1994.12	MT		F	Estate Engine C16SE	GCI44004	Inner Joint		22	22	34.95	57.5	72.5					
	1991.03-1994.12	MT		F	Estate Engine C16SE	GC044051	Outer Joint	29T	22	22	52	95	50.5	O				
1.7 D (42 kW)	1991.12-1998.02	MT		F	Estate Engine 17D	GCI44004	Inner Joint		22	22	34.95	57.5	72.5					
	1991.12-1998.02	MT		F	Hatchback Engine 17D	GCI44004	Inner Joint		22	22	34.95	57.5	72.5					
	1991.12-1998.02	MT/AT		F	Estate Engine 17D	GC044056	Outer Joint	29T	33	25	52	109	61	O				
	1991.12-1998.02	MT/AT		F	Hatchback Engine 17D	GC044056	Outer Joint	29T	33	25	52	109	61	O				
	1992.03-1992.09	MT		F	Saloon Engine 17D	GCI44004	Inner Joint		22	22	34.95	57.5	72.5					
	1992.03-1992.09	MT/AT		F	Saloon Engine 17D	GC044056	Outer Joint	29T	33	25	52	109	61	O				
1.7 D (44 kW)	1991.03-1994.12	MT		F	Estate Engine 17DR	GCI44004	Inner Joint		22	22	34.95	57.5	72.5					
	1991.03-1994.12	MT/AT		F	Estate Engine 17DR	GC044056	Outer Joint	29T	33	25	52	109	61	O				
	1991.09-1994.12	MT		F	Hatchback Engine 17DR	GCI44004	Inner Joint		22	22	34.95	57.5	72.5					
	1991.09-1994.12	MT/AT		F	Hatchback Engine 17DR	GC044056	Outer Joint	29T	33	25	52	109	61	O				
	1992.07-1998.09	MT		F	Saloon Engine 17DR	GCI44004	Inner Joint		22	22	34.95	57.5	72.5					
	1992.07-1998.09	MT/AT		F	Saloon Engine 17DR	GC044056	Outer Joint	29T	33	25	52	109	61	O				
1.7 TD (50 kW)	1994.01-1998.02	MT/AT		F	Estate Engine X17DTL	GC044056	Outer Joint	29T	33	25	52	109	61	O				
	1994.08-1998.02	MT/AT		F	Hatchback Engine X17DTL	GC044056	Outer Joint	29T	33	25	52	109	61	O				
	1994.08-1998.09	MT/AT		F	Saloon Engine X17DTL	GC044056	Outer Joint	29T	33	25	52	109	61	O				
1.7 TD (60 kW)	1991.12-1998.02	MT		F	Estate Engine 17DT(TC4EE1)	GCI44002	Inner Joint		34	25	35	56.2	85.6					
	1991.12-1998.02	MT		F	Hatchback Engine 17DT(TC4EE1)	GCI44002	Inner Joint		34	25	35	56.2	85.6					
	1991.12-1998.09	MT		F	Saloon Engine 17DT(TC4EE1)	GCI44002	Inner Joint		34	25	35	56.2	85.6					
	1991.12-1998.02	MT	R	F	Estate Engine 17DT(TC4EE1)	GDS44059	Drive Shaft	29T	33	34	52	109	938					
	1991.12-1998.02	MT	R	F	Hatchback Engine 17DT(TC4EE1)	GDS44059	Drive Shaft	29T	33	34	52	109	938					
	1991.12-1998.09	MT	R	F	Saloon Engine 17DT(TC4EE1)	GDS44059	Drive Shaft	29T	33	34	52	109	938					
	1991.12-1998.02	MT	L	F	Estate Engine 17DT(TC4EE1)	GDS44011	Drive Shaft	29T	33	34	52	109	594.5					
	1991.12-1998.02	MT	L	F	Hatchback Engine 17DT(TC4EE1)	GDS44011	Drive Shaft	29T	33	34	52	109	594.5					
	1991.12-1998.09	MT	L	F	Saloon Engine 17DT(TC4EE1)	GDS44011	Drive Shaft	29T	33	34	52	109	594.5					
	1991.12-1998.02	MT/AT		F	Estate Engine 17DT(TC4EE1)	GC044056	Outer Joint	29T	33	25	52	109	61	O				
	1991.12-1998.02	MT/AT		F	Hatchback Engine 17DT(TC4EE1)	GC044056	Outer Joint	29T	33	25	52	109	61	O				
	1991.12-1998.09	MT/AT		F	Saloon Engine 17DT(TC4EE1)	GC044056	Outer Joint	29T	33	25	52	109	61	O				
1.8 16V (85 kW)	1994.11-2001.03		R	F	Convertible Engine C18XEL/X18XE	GDS44048	Drive Shaft		33	34	52	109	938					
	1994.11-2001.03		R	F	Convertible Engine C18XEL/X18XE	GCI21011	Inner Joint		34	25	35	78	64					
	1994.11-2001.03		R	F	Convertible Engine C18XEL/X18XE	GC044049	Outer Joint		33	25	52	109	61	O				
	1994.11-2001.03	MT		F	Convertible Engine C18XEL/X18XE	GCI44002	Inner Joint		34	25	35	56.2	85.6					
1.8 i (66 kW)	1991.09-1998.02	MT		F	Estate Engine C18NZ	GCI44002	Inner Joint		34	25	35	56.2	85.6					
	1991.09-1998.02	MT		F	Hatchback Engine C18NZ	GCI44002	Inner Joint		34	25	35	56.2	85.6					
	1991.09-1998.02	MT	R	F	Estate Engine C18NZ	GDS44059	Drive Shaft	29T	33	34	52	109	938					
	1991.09-1998.02	MT	R	F	Hatchback Engine C18NZ	GDS44059	Drive Shaft	29T	33	34	52	109	938					
	1991.09-1998.02	MT	L	F	Estate Engine C18NZ	GDS44011	Drive Shaft	29T	33	34	52	109	594.5					
	1991.09-1998.02	MT	L	F	Hatchback Engine C18NZ	GDS44011	Drive Shaft	29T	33	34	52	109	594.5					
	1991.09-1998.02	MT/AT		F	Estate Engine C18NZ	GC044056	Outer Joint	29T	33	25	52	109	61	O				
	1991.09-1998.02	MT/AT		F	Hatchback Engine C18NZ	GC044056	Outer Joint	29T	33	25	52	109	61	O				
	1992.03-1998.09	MT		F	Saloon Engine C18NZ	GCI44002	Inner Joint		34	25	35	56.2	85.6					
	1992.03-1998.09	MT	R	F	Saloon Engine C18NZ	GDS44059	Drive Shaft	29T	33	34	52	109	938					
	1992.03-1998.09	MT	L	F	Saloon Engine C18NZ	GDS44011	Drive Shaft	29T	33	34	52	109	594.5					
	1992.03-1998.09	MT/AT		F	Saloon Engine C18NZ	GC044056	Outer Joint	29T	33	25	52	109	61	O				
1.8 i 16V (85 kW)	1994.01-1996.12	MT		F	Saloon Engine C18XEL	GCI44002	Inner Joint		34	25	35	56.2	85.6					
	1994.09-1998.02	MT		F	Estate Engine C18XEL/X18XE	GCI44002	Inner Joint		34	25	35	56.2	85.6					
	1994.09-1998.02	MT		F	Hatchback Engine C18XEL	GCI44002	Inner Joint		34	25	35	56.2	85.6					
1.8 i 16V (92 kW)	1993.06-1994.10	MT		F	Saloon Engine C18XE	GCI44002	Inner Joint		34	25	35	56.2	85.6					
	1994.09-1998.02	MT		F	Estate Engine C18XE	GCI44002	Inner Joint		34	25	35	56.2	85.6					
	1994.09-1998.02	MT		F	Hatchback Engine C18XE	GCI44002	Inner Joint		34	25	35	56.2	85.6					
2.0 i (85 kW)	1991.09-1998.02	MT		F	Estate Engine C20NE	GCI44002	Inner Joint		34	25	35	56.2	85.6					
	1991.09-1998.02	MT		F	Hatchback Engine C20NE	GCI44002	Inner Joint		34	25	35	56.2	85.6					
	1991.09-1998.02	MT	R	F	Estate Engine C20NE	GDS44059	Drive Shaft	29T	33	34	52	109	938					
	1991.09-1998.02	MT	R	F	Hatchback Engine C20NE	GDS44059	Drive Shaft	29T	33	34	52	109	938					
	1991.09-1998.02	MT	L	F	Estate Engine C20NE	GDS44011	Drive Shaft	29T	33	34	52	109	594.5					
	1991.09-1998.02	MT	L	F	Hatchback Engine C20NE	GDS44011	Drive Shaft	29T	33	34	52	109	594.5					
	1991.09-1998.02	MT/AT		F	Estate Engine C20NE	GC044056	Outer Joint	29T	33	25	52	109	61	O				
	1991.09-1998.02	MT/AT		F	Hatchback Engine C20NE	GC044056	Outer Joint	29T	33	25	52	109	61	O				
	1992.03-1998.09	MT		F	Saloon Engine C20NE	GCI44002	Inner Joint		34	25	35	56.2	85.6					
	1992.03-1998.09	MT	R	F	Saloon Engine C20NE	GDS44059	Drive Shaft	29T	33	34	52	109	938					





		YEAR	TRANSM	L/R	F/R		G-AP Ref.	PRODUCT	ABS	Technical Specifications						
										A	B	C	H	L	P	
<b>VAUXHALL</b>																
<b>ASTRA III (F)</b>																
2.0 i (85 kW)	1992.03-	1998.09	MT	L	F	Saloon Engine C20NE	GDS44011	Drive Shaft	29T	33	34	52	109	594.5		
	1992.03-	1998.09	MT/AT		F	Saloon Engine C20NE	GC044056	Outer Joint	29T	33	25	52	109	61	O	
	1993.03-	1994.10	MT		F	Convertible Engine C20NE	GCI44002	Inner Joint		34	25	35	56.2	85.6		
	1993.03-	1994.10	MT	R	F	Convertible Engine C20NE	GDS44059	Drive Shaft	29T	33	34	52	109	938		
	1993.03-	1994.10	MT	L	F	Convertible Engine C20NE	GDS44011	Drive Shaft	29T	33	34	52	109	594.5		
	1993.03-	1994.10	MT/AT		F	Convertible Engine C20NE	GC044056	Outer Joint	29T	33	25	52	109	61	O	
2.0 i 16V (100 kW)	1994.01-	1998.02	MT/AT		F	Estate Engine X20XE	GC044056	Outer Joint	29T	33	25	52	109	61	O	
	1994.01-	1998.02	MT/AT		F	Hatchback Engine X20XE	GC044056	Outer Joint	29T	33	25	52	109	61	O	
	1995.02-	1998.09	MT/AT		F	Saloon Engine X20XE	GC044056	Outer Joint	29T	33	25	52	109	61	O	
2.0 i 16V (110 kW)	1991.09-	1998.02	MT		F	Hatchback Engine C20XE	GCI44002	Inner Joint		34	25	35	56.2	85.6		
	1991.09-	1998.02	MT	R	F	Hatchback Engine C20XE	GDS44059	Drive Shaft	29T	33	34	52	109	938		
	1991.09-	1998.02	MT	L	F	Hatchback Engine C20XE	GDS44011	Drive Shaft	29T	33	34	52	109	594.5		
	1991.09-	1998.02	MT		F	Hatchback Engine C20XE	GC044056	Outer Joint	29T	33	25	52	109	61	O	
<b>ASTRA IV (G)</b>																
1.2 16V (55 kW)	2000.09-	2005.05	5MT		F	Estate Engine Z12XE	GC044012	Outer Joint		33	28	52	104	54.5	O	
	2000.09-	2005.05	5MT		F	Hatchback Engine Z12XE	GC044012	Outer Joint		33	28	52	104	54.5	O	
	2000.09-	2005.05	5MT		F	Saloon Engine Z12XE	GC044012	Outer Joint		33	28	52	104	54.5	O	
1.4 16V (66 kW)	1998.02-	2005.05	MT/AT		F	Estate Engine X14XE/Z14XE	GC044030	Outer Joint		33	22	52	103	50.5	O	
	1998.02-	2005.05	MT/AT		F	Hatchback Engine X14XE/Z14XE	GC044030	Outer Joint		33	22	52	103	50.5	O	
	1998.02-	2005.05	MT	L	F	Estate Engine X14XE/Z14XE	GCI21014	Inner Joint		22	22	35	57.5	75		
	1998.02-	2005.05	MT	L	F	Estate Engine X14XE/Z14XE	GDS60013	Drive Shaft		33	22	52	103	595		
	1998.02-	2005.05	MT	L	F	Hatchback Engine X14XE/Z14XE	GCI21014	Inner Joint		22	22	35	57.5	75		
	1998.02-	2005.05	MT	L	F	Hatchback Engine X14XE/Z14XE	GDS60013	Drive Shaft		33	22	52	103	595		
	1998.02-	2005.05	MT	R	F	Estate Engine X14XE/Z14XE	GDS44033	Drive Shaft		33	22	52	103	950.5		
	1998.02-	2005.05	MT	R	F	Hatchback Engine X14XE/Z14XE	GDS44033	Drive Shaft		33	22	52	103	950.5		
	1998.09-	2005.05	MT/AT		F	Saloon Engine X14XE/Z14XE	GC044030	Outer Joint		33	22	52	103	50.5	O	
	1998.09-	2005.05	MT	L	F	Saloon Engine X14XE/Z14XE	GCI21014	Inner Joint		22	22	35	57.5	75		
1.6 (55 kW)	1998.03-	2004.04	MT/AT		F	Estate Engine X16SZR	GC044030	Outer Joint		33	22	52	103	50.5	O	
	1998.03-	2004.04	MT	L	F	Estate Engine X16SZR	GCI21014	Inner Joint		22	22	35	57.5	75		
	1998.03-	2004.04	MT	L	F	Estate Engine X16SZR	GDS60013	Drive Shaft		33	22	52	103	595		
	1998.03-	2004.04	MT	R	F	Estate Engine X16SZR	GDS44033	Drive Shaft		33	22	52	103	950.5		
	1998.03-	2004.04	MT/AT		F	Estate Engine X16SE	GC044030	Outer Joint		33	22	52	103	50.5	O	
1.6 (62 kW)	1998.03-	2004.04	MT	L	F	Estate Engine Z16SE	GCI21014	Inner Joint		22	22	35	57.5	75		
	1998.03-	2004.04	MT	L	F	Estate Engine Z16SE	GDS60013	Drive Shaft		33	22	52	103	595		
	1998.03-	2004.04	MT	R	F	Estate Engine Z16SE	GDS44033	Drive Shaft		33	22	52	103	950.5		
	2000.09-	2005.05	MT/AT		F	Hatchback Engine Z16SE	GC044030	Outer Joint		33	22	52	103	50.5	O	
	2000.09-	2005.05	MT/AT		F	Saloon Engine Z16SE	GC044030	Outer Joint		33	22	52	103	50.5	O	
	2000.09-	2005.05	MT	L	F	Hatchback Engine Z16SE	GCI21014	Inner Joint		22	22	35	57.5	75		
	2000.09-	2005.05	MT	L	F	Hatchback Engine Z16SE	GDS60013	Drive Shaft		33	22	52	103	595		
	2000.09-	2005.05	MT	L	F	Saloon Engine Z16SE	GCI21014	Inner Joint		22	22	35	57.5	75		
	2000.09-	2005.05	MT	L	F	Saloon Engine Z16SE	GDS60013	Drive Shaft		33	22	52	103	595		
	2000.09-	2005.05	MT	R	F	Hatchback Engine Z16SE	GDS44033	Drive Shaft		33	22	52	103	950.5		
	2000.09-	2005.05	MT	R	F	Saloon Engine Z16SE	GDS44033	Drive Shaft		33	22	52	103	950.5		
	2000.09-	2005.05	MT/AT		F	Saloon Engine Z16SE	GC044030	Outer Joint		33	22	52	103	50.5	O	
1.6 16V (74 kW)	1998.02-	2005.05	MT/AT		F	Hatchback Engine X16XEL/Z16XE	GC044030	Outer Joint		33	22	52	103	50.5	O	
	1998.02-	2005.05	MT	L	F	Hatchback Engine X16XEL/Z16XE	GCI21014	Inner Joint		22	22	35	57.5	75		
	1998.02-	2005.05	MT	L	F	Hatchback Engine X16XEL/Z16XE	GDS60013	Drive Shaft		33	22	52	103	595		
	1998.02-	2005.05	MT	R	F	Hatchback Engine X16XEL/Z16XE	GDS44033	Drive Shaft		33	22	52	103	950.5		
	1998.03-	2004.04	MT/AT		F	Estate Engine X16XEL/Z16XE	GC044030	Outer Joint		33	22	52	103	50.5	O	
	1998.03-	2004.04	MT	L	F	Estate Engine X16XEL/Z16XE	GCI21014	Inner Joint		22	22	35	57.5	75		
	1998.03-	2004.04	MT	L	F	Estate Engine X16XEL/Z16XE	GDS60013	Drive Shaft		33	22	52	103	595		
	1998.03-	2004.04	MT	R	F	Estate Engine X16XEL/Z16XE	GDS44033	Drive Shaft		33	22	52	103	950.5		
	1998.09-	2005.05	MT/AT		F	Saloon Engine C16SEL/X16XEL/Z16XE/Z16XEP	GC044030	Outer Joint		33	22	52	103	50.5	O	
	1998.09-	2005.05	MT	L	F	Saloon Engine C16SEL/X16XEL/Z16XE/Z16XEP	GCI21014	Inner Joint		22	22	35	57.5	75		
	1998.09-	2005.05	MT	L	F	Saloon Engine C16SEL/X16XEL/Z16XE/Z16XEP	GDS60013	Drive Shaft		33	22	52	103	595		
	1998.09-	2005.05	MT	R	F	Saloon Engine C16SEL/X16XEL/Z16XE/Z16XEP	GDS44033	Drive Shaft		33	22	52	103	950.5		
	2001.03-	2005.10	MT/AT		F	Convertible Engine Z16XE	GC044030	Outer Joint		33	22	52	103	50.5	O	
	2001.03-	2005.10	MT	L	F	Convertible Engine Z16XE	GCI21014	Inner Joint		22	22	35	57.5	75		
	2001.03-	2005.10	MT	L	F	Convertible Engine Z16XE	GDS60013	Drive Shaft		33	22	52	103	595		
	2001.03-	2005.10	MT	R	F	Convertible Engine Z16XE	GDS44033	Drive Shaft		33	22	52	103	950.5		



		YEAR	TRANSM	L/R	F/R		G-AP Ref.	PRODUCT	ABS	Technical Specifications						
										A	B	C	H	L	P	
<b>VAUXHALL</b>																
<b>ASTRA IV (G)</b>																
1.7 CDTi 16V (59 kW)	2003.04-	2005.05	MT	R	F	Estate Engine Z17DTL	GDS60035	Drive Shaft		33	22	52	109	961		
	2003.04-	2005.05	MT	R	F	Hatchback Engine Z17DTL	GDS60035	Drive Shaft		33	22	52	109	961		
	2003.04-	2005.05	MT	R	F	Saloon Engine Z17DTL	GDS60035	Drive Shaft		33	22	52	109	961		
1.7 DTi 16V (55 kW)	2000.02-	2005.05	5MT		F	Estate Engine Y17DT	GC044049	Outer Joint		33	25	52	109	61	O	
	2000.02-	2005.05	5MT		F	Hatchback Engine Y17DT	GC044049	Outer Joint		33	25	52	109	61	O	
	2000.02-	2005.05	5MT		F	Saloon Engine Y17DT	GC044049	Outer Joint		33	25	52	109	61	O	
	2000.02-	2005.05	MT	R	F	Estate Engine Y17DT	GDS60035	Drive Shaft		33	22	52	109	961		
	2000.02-	2005.05	MT	R	F	Hatchback Engine Y17DT	GDS60035	Drive Shaft		33	22	52	109	961		
	2000.02-	2005.05	MT	R	F	Saloon Engine Y17DT	GDS60035	Drive Shaft		33	22	52	109	961		
1.8 16V (85 kW)	1998.02-	2004.07			F	Saloon Engine X18XE1	GC044049	Outer Joint		33	25	52	109	61	O	
	1998.02-	2004.07	MT/AT		F	Saloon Engine X18XE1	GC044006	Outer Joint	29T	33	25	52	103.5	61	O	
	1998.02-	2004.07	MT	R	F	Saloon Engine X18XE1	GDS60035	Drive Shaft		33	22	52	109	961		
1.8 16V (92 kW)	1998.02-	2004.07			F	Saloon Engine Z18XE	GC044049	Outer Joint		33	25	52	109	61	O	
	1998.02-	2004.07	MT	R	F	Saloon Engine Z18XE	GDS60035	Drive Shaft		33	22	52	109	961		
	2000.09-	2005.05			F	Estate Engine Z18XE	GC044049	Outer Joint		33	25	52	109	61	O	
	2000.09-	2005.05			F	Hatchback Engine Z18XE	GC044049	Outer Joint		33	25	52	109	61	O	
	2000.09-	2005.05	MT	R	F	Estate Engine Z18XE	GDS60035	Drive Shaft		33	22	52	109	961		
	2000.09-	2005.05	MT	R	F	Hatchback Engine Z18XE	GDS60035	Drive Shaft		33	22	52	109	961		
	2001.03-	2005.10			F	Convertible Engine Z18XE	GC044049	Outer Joint		33	25	52	109	61	O	
1.8 16V Dualfuel (87 kW)	1998.02-	2004.07			F	Saloon Engine Z18XE	GC044049	Outer Joint		33	25	52	109	61	O	
	1998.02-	2004.07		R	F	Saloon Engine Z18XE	GDS60035	Drive Shaft		33	22	52	109	961		
	2002.09-	2005.05			F	Estate Engine Z18XE	GC044049	Outer Joint		33	25	52	109	61	O	
	2002.09-	2005.05			F	Hatchback Engine Z18XE	GC044049	Outer Joint		33	25	52	109	61	O	
	2002.09-	2005.05		R	F	Estate Engine Z18XE	GDS60035	Drive Shaft		33	22	52	109	961		
	2002.09-	2005.05		R	F	Hatchback Engine Z18XE	GDS60035	Drive Shaft		33	22	52	109	961		
2.0 (147 kW)	2002.09-	2006.07	MT	L	F	Convertible Engine Z20LET	GDS44025	Drive Shaft		33	34	55	104	593		
	2002.09-	2006.07	MT	L	F	Convertible Engine Z20LET	GCI44018	Inner Joint		34	35	35	56	119.5		
	2002.09-	2006.07	MT	L	F	Convertible Engine Z20LET	GC099061	Outer Joint		33	35	55	104	67.5	I	
	2002.09-	2006.07	MT	R	F	Convertible Engine Z20LET	GDS44082	Drive Shaft		33	34	55	104	663		
2.0 16V (100 kW)	1998.02-	2005.05	MT	L	F	Estate Engine X20XEV	GDS44044	Drive Shaft		33	34	52	103.5	595		
	1998.02-	2005.05	MT	L	F	Hatchback Engine X20XEV	GDS44044	Drive Shaft		33	34	52	103.5	595		
	1998.02-	2005.05			F	Estate Engine X20XEV	GC044049	Outer Joint		33	25	52	109	61	O	
	1998.02-	2005.05			F	Hatchback Engine X20XEV	GC044049	Outer Joint		33	25	52	109	61	O	
	1998.02-	2005.05	MT/AT		F	Estate Engine X20XEV	GC044006	Outer Joint	29T	33	25	52	103.5	61	O	
	1998.02-	2005.05	MT/AT		F	Hatchback Engine X20XEV	GC044006	Outer Joint	29T	33	25	52	103.5	61	O	
	1998.09-	2005.05			F	Saloon Engine X20XEV	GC044049	Outer Joint		33	25	52	109	61	O	
	1998.09-	2005.05	MT/AT		F	Saloon Engine X20XEV	GC044006	Outer Joint	29T	33	25	52	103.5	61	O	
	1998.09-	2005.05	MT	L	F	Saloon Engine X20XEV	GDS44044	Drive Shaft		33	34	52	103.5	595		
2.0 Di (60 kW)	1998.02-	2004.07			F	Saloon Engine X20DTL/Y20DTL	GC044049	Outer Joint		33	25	52	109	61	O	
	1998.02-	2004.07	MT/AT		F	Saloon Engine X20DTL/Y20DTL	GC044006	Outer Joint	29T	33	25	52	103.5	61	O	
	1998.02-	2004.07	MT	L	F	Saloon Engine X20DTL/Y20DTL	GDS44044	Drive Shaft		33	34	52	103.5	595		
	1998.02-	2005.05			F	Hatchback Engine X20DTL/Y20DTL	GC044049	Outer Joint		33	25	52	109	61	O	
	1998.02-	2005.05	MT/AT		F	Hatchback Engine X20DTL/Y20DTL	GC044006	Outer Joint	29T	33	25	52	103.5	61	O	
	1998.02-	2005.05	MT	L	F	Hatchback Engine X20DTL/Y20DTL	GDS44044	Drive Shaft		33	34	52	103.5	595		
	1998.03-	2004.04			F	Estate Engine X20DTL/Y20DTL	GC044049	Outer Joint		33	25	52	109	61	O	
	1998.03-	2004.04	MT/AT		F	Estate Engine X20DTL/Y20DTL	GC044006	Outer Joint	29T	33	25	52	103.5	61	O	
1998.03-	2004.04	MT	L	F	Estate Engine X20DTL/Y20DTL	GDS44044	Drive Shaft		33	34	52	103.5	595			
2.0 DTi 16V (74 kW)	1998.02-	2004.07			F	Saloon Engine X20DTH/Y20DTH	GC044049	Outer Joint		33	25	52	109	61	O	
	1998.02-	2004.07	MT	L	F	Saloon Engine X20DTH/Y20DTH	GDS44044	Drive Shaft		33	34	52	103.5	595		
	1998.03-	2004.04			F	Estate Engine X20DTH/Y20DTH	GC044049	Outer Joint		33	25	52	109	61	O	
	1998.03-	2004.04	MT	L	F	Estate Engine X20DTH/Y20DTH	GDS44044	Drive Shaft		33	34	52	103.5	595		
	1999.08-	2005.05			F	Hatchback Engine X20DTH/Y20DTH	GC044049	Outer Joint		33	25	52	109	61	O	
	1999.08-	2005.05	MT	L	F	Hatchback Engine X20DTH/Y20DTH	GDS44044	Drive Shaft		33	34	52	103.5	595		
2.0 SRI Turbo (141 kW)	2002.07-	2005.05	MT	L	F	Hatchback Engine Z20LET	GDS44025	Drive Shaft		33	34	55	104	593		
	2002.07-	2005.05	MT	L	F	Hatchback Engine Z20LET	GCI44018	Inner Joint		34	35	35	56	119.5		
	2002.07-	2005.05	MT	L	F	Hatchback Engine Z20LET	GC099061	Outer Joint		33	35	55	104	67.5	I	
	2002.07-	2005.05	MT	R	F	Hatchback Engine Z20LET	GDS44082	Drive Shaft		33	34	55	104	663		
2.0 Turbo (141 kW)	2002.03-	2005.10	MT	L	F	Convertible Engine Z20LET	GDS44025	Drive Shaft		33	34	55	104	593		
	2002.03-	2005.10	MT	L	F	Convertible Engine Z20LET	GCI44018	Inner Joint		34	35	35	56	119.5		
	2002.03-	2005.10	MT	L	F	Convertible Engine Z20LET	GC099061	Outer Joint		33	35	55	104	67.5	I	
	2002.03-	2005.10	MT	R	F	Convertible Engine Z20LET	GDS44082	Drive Shaft		33	34	55	104	663		





		YEAR	TRANSM	L/R	F/R		G-AP Ref.	PRODUCT	ABS	Technical Specifications						
										A	B	C	H	L	P	
<b>VAUXHALL</b>																
<b>ASTRA IV (G)</b>																
2.2 16V (108 kW)	2001.03-	2005.05			F	Estate Engine Z22SE	GC044049	Outer Joint			33	25	52	109	61	O
	2001.03-	2005.05			F	Hatchback Engine Z22SE	GC044049	Outer Joint			33	25	52	109	61	O
	2001.03-	2005.05	MT	L	F	Estate Engine Z22SE	GDS44044	Drive Shaft			33	34	52	103.5	595	
	2001.03-	2005.05	MT	L	F	Hatchback Engine Z22SE	GDS44044	Drive Shaft			33	34	52	103.5	595	
	2001.03-	2005.05			R	Saloon Engine Z22SE	GC044049	Outer Joint			33	25	52	109	61	O
	2001.03-	2005.05	MT	L	R	Saloon Engine Z22SE	GDS44044	Drive Shaft			33	34	52	103.5	595	
	2001.03-	2005.10			F	Convertible Engine Z22SE	GC044049	Outer Joint			33	25	52	109	61	O
	2001.03-	2005.10	MT	L	F	Convertible Engine Z22SE	GDS44044	Drive Shaft			33	34	52	103.5	595	
<b>ASTRA IV (G) (F67)</b>																
1.8 16V (85 kW)	2000.03-	2005.08			F	Coupe Engine X18XE1/Z18XEL	GC044049	Outer Joint			33	25	52	109	61	O
	2000.03-	2005.08	MT/AT		F	Coupe Engine X18XE1/Z18XEL	GC044006	Outer Joint	29T		33	25	52	103.5	61	O
	2000.03-	2005.08	MT	R	F	Coupe Engine X18XE1/Z18XEL	GDS60035	Drive Shaft			33	22	52	109	961	
1.8 16V (92 kW)	2000.09-	2005.08			F	Coupe Engine Z18XE	GC044049	Outer Joint			33	25	52	109	61	O
	2000.09-	2005.08	MT	R	F	Coupe Engine Z18XE	GDS60035	Drive Shaft			33	22	52	109	961	
1.8 16V Dualfuel (87 kW)	2002.09-	2005.08			F	Coupe Engine Z18XE	GC044049	Outer Joint			33	25	52	109	61	O
	2002.09-	2005.08			R	Coupe Engine Z18XE	GDS60035	Drive Shaft			33	22	52	109	961	
2.0 (147 kW)	2002.08-	2005.05	MT	L	F	Coupe Engine Z20LET	GDS44025	Drive Shaft			33	34	55	104	593	
	2002.08-	2005.05	MT	L	F	Coupe Engine Z20LET	GCI44018	Inner Joint			34	35	35	56	119.5	
	2002.08-	2005.05	MT	L	F	Coupe Engine Z20LET	GC099061	Outer Joint			33	35	55	104	67.5	I
	2002.08-	2005.05	MT	R	F	Coupe Engine Z20LET	GDS44082	Drive Shaft			33	34	55	104	663	
2.0 16V Turbo (140 kW)	2000.09-	2005.08	MT	L	F	Coupe Engine Z20LET	GDS44025	Drive Shaft			33	34	55	104	593	
	2000.09-	2005.08	MT	L	F	Coupe Engine Z20LET	GCI44018	Inner Joint			34	35	35	56	119.5	
	2000.09-	2005.08	MT	L	F	Coupe Engine Z20LET	GC099061	Outer Joint			33	35	55	104	67.5	I
	2000.09-	2005.08	MT	R	F	Coupe Engine Z20LET	GDS44082	Drive Shaft			33	34	55	104	663	
	2000.09-	2005.08	MT	R	F	Coupe Engine Z22SE	GC044049	Outer Joint			33	25	52	109	61	O
2.2 16V (108 kW)	2000.03-	2005.08	MT	L	F	Coupe Engine Z22SE	GDS44044	Drive Shaft			33	34	52	103.5	595	
<b>ASTRA J, GTC, SW</b>																
1.4 (103 kW)	2012-		MT				GC044028	Outer Joint			33	24	53	93.5	63.5	M
1.4 (64 kW)	2009-						GC044003	Outer Joint			33	22	53	95	54.5	M
1.4 (74 kW)	2009-						GC044003	Outer Joint			33	22	53	95	54.5	M
1.4 T (103 kW)	2009-		MT				GC044028	Outer Joint			33	24	53	93.5	63.5	M
1.4 T (88 kW)	2009-		MT				GC044028	Outer Joint			33	24	53	93.5	63.5	M
<b>ASTRA J, SW, GTC</b>																
1.6 Cabrio, Coupe (85 kW)	2009-						GC044003	Outer Joint			33	22	53	95	54.5	M
<b>ASTRA MK VI (J)</b>																
1.6 CDTi (100 kW)	2013.11-					Hatchback Engine B16DTH	GC099023	Outer Joint			30	26	53.8	94.5	65.5	M
	2014.01-					Estate Engine B16DTH	GC099023	Outer Joint			30	26	53.8	94.5	65.5	M
1.6 CDTi (81 kW)	2013.11-					Hatchback Engine B16DTL	GC099023	Outer Joint			30	26	53.8	94.5	65.5	M
	2014.01-					Estate Engine B16DTL	GC099023	Outer Joint			30	26	53.8	94.5	65.5	M
1.6 SiDi (125 kW)	2012.12-					Estate Engine A16XHT	GC099023	Outer Joint			30	26	53.8	94.5	65.5	M
	2012.12-					Hatchback Engine A16XHT	GC099023	Outer Joint			30	26	53.8	94.5	65.5	M
	2012.12-					Saloon Engine A16XHT	GC099023	Outer Joint			30	26	53.8	94.5	65.5	M
<b>ASTRA TWINTOP V (H)</b>																
1.6 (132 kW)	2006.10-	2010.11				Convertible Engine Z16LET	GC099023	Outer Joint			30	26	53.8	94.5	65.5	M
1.6 (77 kW)	2005.09-	2010.11	MT		F	Convertible Engine Z16XEP	GC044003	Outer Joint			33	22	53	95	54.5	M
	2005.09-	2010.11	MT	L	F	Convertible Engine Z16XEP	GCI21014	Inner Joint			22	22	35	57.5	75	
	2005.09-	2010.11	MT	L	F	Convertible Engine Z16XEP	GDS44028	Drive Shaft			33	22	53	95	590	
	2005.09-	2010.11	MT	R	F	Convertible Engine Z16XEP	GCI21014	Inner Joint			22	22	35	57.5	75	
	2005.09-	2010.11	MT	R	F	Convertible Engine Z16XEP	GDS44030	Drive Shaft			33	22	53	95	952	
	2005.09-	2010.11	MT	R	F	Convertible Engine Z16XEP	GDS21063	Drive Shaft			33	22	53	93.5	586	
1.8 (103 kW)	2008.05-	2010.11	MT/AT	L	F	Convertible Engine Z18XER	GDS21055	Drive Shaft			33	22	53	93.5	950	
	2008.05-	2010.11	MT/AT	R	F	Convertible Engine Z18XER	GDS21055	Drive Shaft			33	22	53	93.5	950	
1.9 CDTi (110 kW)	2006.01-	2010.11		L	F	Convertible Engine Z19DTH	GDS21071	Drive Shaft			30	25	53.8	94.5	576	
	2006.01-	2010.11		R	F	Convertible Engine Z19DTH	GDS21062	Drive Shaft			30	34	53.8	94.5	595	
	2006.01-	2010.11				Convertible Engine Z19DTH	GC099023	Outer Joint			30	26	53.8	94.5	65.5	M
2.0 (125 kW)	2006.02-	2010.11				Convertible Engine Z20LEL	GC099024	Outer Joint			33	26	52.5	94	65.5	M
2.0 Turbo (147 kW)	2006.01-	2010.11				Convertible Engine Z20LER	GC099024	Outer Joint			33	26	52.5	94	65.5	M
<b>ASTRA V (H)</b>																
1.3 CDTi (66 kW)	2004.01-	2009.05	MT	L	F	Hatchback Engine Z13DTH	GDS60020	Drive Shaft			33	25	52.5	94	561	
	2004.01-	2009.05		L	F	Hatchback Engine Z13DTH	GDS44052	Drive Shaft			33	25	53	93.5	573	
	2004.01-	2009.05		L	F	Hatchback Engine Z13DTH	GCI44008	Inner Joint			25	25	35	77.5	64	
	2004.01-	2009.05		L/R	F	Hatchback Engine Z13DTH	GC044028	Outer Joint			33	24	53	93.5	63.5	M









		YEAR	TRANSM	L/R	F/R		G-AP Ref.	PRODUCT	ABS	Technical Specifications											
										A	B	C	H	L	P						
<b>VAUXHALL</b>																					
<b>ASTRA V (H)</b>																					
1.3 CDTi (66 kW)	2004.01-	2009.05			R	F	Hatchback Engine Z13DTH	GDS44051	Drive Shaft		33	34	53	93.5	570						
	2004.01-	2009.05			R	F	Hatchback Engine Z13DTH	GCI44011	Inner Joint		34	25	37.5	46	55						
	2004.08-	2009.03	MT		L	F	Estate Engine Z13DTH	GDS60020	Drive Shaft		33	25	52.5	94	561						
	2004.08-	2009.03			L	F	Estate Engine Z13DTH	GDS44052	Drive Shaft		33	25	53	93.5	573						
	2004.08-	2009.03			L	F	Estate Engine Z13DTH	GCI44008	Inner Joint		25	25	35	77.5	64						
	2004.08-	2009.03			L/R	F	Estate Engine Z13DTH	GC044028	Outer Joint		33	24	53	93.5	63.5	M					
	2004.08-	2009.03			R	F	Estate Engine Z13DTH	GDS44051	Drive Shaft		33	34	53	93.5	570						
	2004.08-	2009.03			R	F	Estate Engine Z13DTH	GCI44011	Inner Joint		34	25	37.5	46	55						
1.4 (66 kW)	2004.01-	2009.05	MT			F	Hatchback Engine Z14XEP	GC044003	Outer Joint		33	22	53	95	54.5	M					
	2004.01-	2009.05	MT	L	F	Hatchback Engine Z14XEP	GCI21014	Inner Joint		22	22	35	57.5	75							
	2004.01-	2009.05	MT	L	F	Hatchback Engine Z14XEP	GDS44028	Drive Shaft		33	22	53	95	590							
	2004.01-	2009.05	MT	R	F	Hatchback Engine Z14XEP	GCI21014	Inner Joint		22	22	35	57.5	75							
	2004.01-	2009.05	MT	R	F	Hatchback Engine Z14XEP	GDS44030	Drive Shaft		33	22	53	95	952							
	2004.08-	2009.03	MT		F	Estate Engine Z14XEP	GC044003	Outer Joint		33	22	53	95	54.5	M						
	2004.08-	2009.03	MT	L	F	Estate Engine Z14XEP	GCI21014	Inner Joint		22	22	35	57.5	75							
	2004.08-	2009.03	MT	L	F	Estate Engine Z14XEP	GDS44028	Drive Shaft		33	22	53	95	590							
1.6 (77 kW)	2004.01-	2009.05	MT			F	Hatchback Engine Z16XEP	GC044003	Outer Joint		33	22	53	95	54.5	M					
	2004.01-	2009.05	MT	L	F	Hatchback Engine Z16XEP	GCI21014	Inner Joint		22	22	35	57.5	75							
	2004.01-	2009.05	MT	L	F	Hatchback Engine Z16XEP	GDS44028	Drive Shaft		33	22	53	95	590							
	2004.01-	2009.05	MT	R	F	Hatchback Engine Z16XEP	GCI21014	Inner Joint		22	22	35	57.5	75							
	2004.01-	2009.05	MT	R	F	Hatchback Engine Z16XEP	GDS44030	Drive Shaft		33	22	53	95	952							
	2004.08-	2009.03	MT		F	Estate Engine Z16XEP	GC044003	Outer Joint		33	22	53	95	54.5	M						
	2004.08-	2009.03	MT	L	F	Estate Engine Z16XEP	GCI21014	Inner Joint		22	22	35	57.5	75							
	2004.08-	2009.03	MT	L	F	Estate Engine Z16XEP	GDS44028	Drive Shaft		33	22	53	95	590							
1.7 CDTi (59 kW)	2004.01-	2009.05	MT			F	Hatchback Engine Z17DTL	GC044028	Outer Joint		33	24	53	93.5	63.5	M					
	2004.01-	2009.05	MT	L	F	Hatchback Engine Z17DTL	GDS21063	Drive Shaft		33	22	53	93.5	586							
	2004.01-	2009.05	MT	R	F	Hatchback Engine Z17DTL	GDS21055	Drive Shaft		33	22	53	93.5	950							
	2004.08-	2009.05	MT	L	F	Estate Engine Z17DTL	GDS21063	Drive Shaft		33	22	53	93.5	586							
1.7 CDTi (74 kW)	2004.01-	2009.05	MT/AT			F	Hatchback Engine Z17DTH	GC044028	Outer Joint		33	24	53	93.5	63.5	M					
	2004.01-	2009.05	5MT	L	F	Hatchback Engine Z17DTH	GDS44029	Drive Shaft		33	34	53	93.5	594							
	2004.01-	2009.05	MT	L	F	Hatchback Engine Z17DTH	GDS44024	Drive Shaft		33	34	53	93.5	589							
	2004.01-	2009.05	MT	L	F	Hatchback Engine Z17DTH	GDS44052	Drive Shaft		33	25	53	93.5	573							
	2004.01-	2009.05	MT	L	F	Hatchback Engine Z17DTH	GCI44008	Inner Joint		25	25	35	77.5	64							
	2004.01-	2009.05	MT	L	F	Hatchback Engine Z17DTH	GC044028	Outer Joint		33	24	53	93.5	63.5	M						
	2004.01-	2009.05	5MT/6MT	R	F	Hatchback Engine Z17DTH	GDS44031	Drive Shaft		33	34	53	93.5	559							
	2004.08-	2009.03	MT/AT			F	Estate Engine Z17DTH	GC044028	Outer Joint		33	24	53	93.5	63.5	M					
	2004.08-	2009.03	5MT	L	F	Estate Engine Z17DTH	GDS44029	Drive Shaft		33	34	53	93.5	594							
	2004.08-	2009.03	MT	L	F	Estate Engine Z17DTH	GDS44024	Drive Shaft		33	34	53	93.5	589							
	2004.08-	2009.03	MT	L	F	Estate Engine Z17DTH	GDS44052	Drive Shaft		33	25	53	93.5	573							
	2004.08-	2009.03	MT	L	F	Estate Engine Z17DTH	GCI44008	Inner Joint		25	25	35	77.5	64							
1.7 CDTi (81 kW)	2004.01-	2009.05			L	F	Hatchback Engine A17DTJ/Z17DTJ	GDS21051	Drive Shaft		33	25	52.5	94	579						
	2004.01-	2009.05					Hatchback Engine A17DTJ/Z17DTJ	GC099024	Outer Joint		33	26	52.5	94	65.5	M					
	2004.08-	2009.03			L	F	Estate Engine A17DTJ/Z17DTJ	GDS21051	Drive Shaft		33	25	52.5	94	579						
	2004.08-	2009.03					Estate Engine A17DTJ/Z17DTJ	GC099024	Outer Joint		33	26	52.5	94	65.5	M					
1.7 CDTi (92 kW)	2007.02-	2009.09			L	F	Hatchback Engine A17DTR/Z17DTR	GDS21051	Drive Shaft		33	25	52.5	94	579						
	2007.02-	2009.09					Hatchback Engine A17DTR/Z17DTR	GC099024	Outer Joint		33	26	52.5	94	65.5	M					
	2007.02-	2010.10			L	F	Estate Engine A17DTR/Z17DTR	GDS21051	Drive Shaft		33	25	52.5	94	579						
1.8 (103 kW)	2004.01-	2009.05	MT/AT	L	F	Hatchback Engine A18XER/Z18XER	GDS21063	Drive Shaft		33	22	53	93.5	586							
	2004.01-	2009.05	MT/AT	R	F	Hatchback Engine A18XER/Z18XER	GDS21055	Drive Shaft		33	22	53	93.5	950							
	2004.10-	2009.03	MT/AT	L	F	Estate Engine A18XER/Z18XER	GDS21063	Drive Shaft		33	22	53	93.5	586							
	2004.10-	2009.03	MT/AT	R	F	Estate Engine A18XER/Z18XER	GDS21055	Drive Shaft		33	22	53	93.5	950							
1.8 (92 kW)	2004.01-	2009.05	MT/AT	F	Hatchback Engine Z18XE	GC044028	Outer Joint		33	24	53	93.5	63.5	M							
	2004.01-	2009.05	MT/AT	L	F	Hatchback Engine Z18XE	GDS21063	Drive Shaft		33	22	53	93.5	586							



		YEAR	TRANSM	L/R	F/R		G-AP Ref.	PRODUCT	ABS	Technical Specifications						
										A	B	C	H	L	P	
<b>VAUXHALL</b>																
<b>ASTRA V (H)</b>																
1.8 (92 kW)	2004.01-2009.05	2009.05	MT/AT	R	F	Hatchback Engine Z18XE	GDS21055	Drive Shaft		33	22	53	93.5	950		
	2004.10-2009.03	2009.03	MT/AT		F	Estate Engine Z18XE	GC044028	Outer Joint		33	24	53	93.5	63.5	M	
	2004.10-2009.03	2009.03	MT/AT	L	F	Estate Engine Z18XE	GDS21063	Drive Shaft		33	22	53	93.5	586		
	2004.10-2009.03	2009.03	MT/AT	R	F	Estate Engine Z18XE	GDS21055	Drive Shaft		33	22	53	93.5	950		
1.9 CDTi (110 kW)	2004.01-2009.05	2009.05	MT		F	Hatchback Engine Z19DTH	GC017051	Outer Joint		30	26	53.8	94.5	65.5	M	
	2004.01-2009.05	2009.05	MT	L	F	Hatchback Engine Z19DTH	GDS21071	Drive Shaft		30	25	53.8	94.5	576		
	2004.01-2009.05	2009.05	MT	R	F	Hatchback Engine Z19DTH	GDS21062	Drive Shaft		30	34	53.8	94.5	595		
	2004.01-2009.05	2009.05				Hatchback Engine Z19DTH	GC099023	Outer Joint		30	26	53.8	94.5	65.5	M	
	2004.08-2009.03	2009.03	MT		F	Estate Engine Z19DTH	GC017051	Outer Joint		30	26	53.8	94.5	65.5	M	
	2004.08-2009.03	2009.03	MT	L	F	Estate Engine Z19DTH	GDS21071	Drive Shaft		30	25	53.8	94.5	576		
	2004.08-2009.03	2009.03	MT	R	F	Estate Engine Z19DTH	GDS21062	Drive Shaft		30	34	53.8	94.5	595		
1.9 CDTi (74 kW)	2004.08-2009.03	2009.03	MT	L	F	Estate Engine Z19DTL	GDS21051	Drive Shaft		33	25	52.5	94	579		
	2004.08-2009.03	2009.03		L	F	Estate Engine Z19DTL	GDS21073	Drive Shaft		33	25	52.5	94	578		
1.9 CDTi (88 kW)	2004.08-2009.03	2009.03				Estate Engine Z19DTL	GC099024	Outer Joint		33	26	52.5	94	65.5	M	
	2004.01-2009.05	2009.05			F	Hatchback Engine Z19DT	GC044027	Outer Joint		33	26	52.5	94	65.5	M	
	2004.01-2009.05	2009.05	MT	L	F	Hatchback Engine Z19DT	GDS21051	Drive Shaft		33	25	52.5	94	579		
	2004.01-2009.05	2009.05	MT	L	F	Hatchback Engine Z19DT	GDS21071	Drive Shaft		30	25	53.8	94.5	576		
	2004.01-2009.05	2009.05	MT	R	F	Hatchback Engine Z19DT	GDS21062	Drive Shaft		30	34	53.8	94.5	595		
	2004.01-2009.05	2009.05				Hatchback Engine Z19DT	GC099024	Outer Joint		33	26	52.5	94	65.5	M	
	2004.08-2009.03	2009.03	MT		F	Estate Engine Z19DT	GC044027	Outer Joint		33	26	52.5	94	65.5	M	
	2004.08-2009.03	2009.03	MT	L	F	Estate Engine Z19DT	GDS21051	Drive Shaft		33	25	52.5	94	579		
	2004.08-2009.03	2009.03	MT	L	F	Estate Engine Z19DT	GDS21071	Drive Shaft		30	25	53.8	94.5	576		
	2004.08-2009.03	2009.03	MT	R	F	Estate Engine Z19DT	GDS21062	Drive Shaft		30	34	53.8	94.5	595		
2004.08-2009.03	2009.03				Estate Engine Z19DT	GC099024	Outer Joint		33	26	52.5	94	65.5	M		
1.9 CDTi 16V (88 kW)	2004.01-2009.05	2009.05			F	Hatchback Engine Z19DTJ	GC044027	Outer Joint		33	26	52.5	94	65.5	M	
	2004.01-2009.05	2009.05	MT	L	F	Hatchback Engine Z19DTJ	GDS21051	Drive Shaft		33	25	52.5	94	579		
	2004.01-2009.05	2009.05	MT	L	F	Hatchback Engine Z19DTJ	GDS21071	Drive Shaft		30	25	53.8	94.5	576		
	2004.01-2009.05	2009.05	MT	R	F	Hatchback Engine Z19DTJ	GDS21062	Drive Shaft		30	34	53.8	94.5	595		
	2004.01-2009.05	2009.05				Hatchback Engine Z19DTJ	GC099024	Outer Joint		33	26	52.5	94	65.5	M	
2.0 Turbo (125 kW)	2004.01-2009.05	2009.05			F	Hatchback Engine Z20LEL	GC044027	Outer Joint		33	26	52.5	94	65.5	M	
	2004.01-2009.05	2009.05	MT	R	F	Hatchback Engine Z20LEL	GDS21056	Drive Shaft		33	34	52.5	94	595		
	2004.01-2009.05	2009.05				Hatchback Engine Z20LEL	GC099024	Outer Joint		33	26	52.5	94	65.5	M	
	2004.08-2010.10	2010.10			F	Estate Engine Z20LEL	GC044027	Outer Joint		33	26	52.5	94	65.5	M	
	2004.08-2010.10	2010.10	MT	R	F	Estate Engine Z20LEL	GDS21056	Drive Shaft		33	34	52.5	94	595		
2.0 Turbo (147 kW)	2004.08-2010.10	2010.10				Estate Engine Z20LEL	GC099024	Outer Joint		33	26	52.5	94	65.5	M	
	2004.01-2009.05	2009.05			F	Hatchback Engine Z20LER	GC044027	Outer Joint		33	26	52.5	94	65.5	M	
	2004.01-2009.05	2009.05	MT	R	F	Hatchback Engine Z20LER	GDS21056	Drive Shaft		33	34	52.5	94	595		
	2004.01-2009.05	2009.05				Hatchback Engine Z20LER	GC099024	Outer Joint		33	26	52.5	94	65.5	M	
	2004.08-2010.10	2010.10			F	Estate Engine Z20LER	GC044027	Outer Joint		33	26	52.5	94	65.5	M	
2.0 Turbo (177 kW)	2004.08-2010.10	2010.10	MT	R	F	Estate Engine Z20LER	GDS21056	Drive Shaft		33	34	52.5	94	595		
	2004.08-2010.10	2010.10				Estate Engine Z20LER	GC099024	Outer Joint		33	26	52.5	94	65.5	M	
	2004.01-2009.05	2009.05			F	Hatchback Engine Z20LEH	GC044027	Outer Joint		33	26	52.5	94	65.5	M	
	2004.01-2009.05	2009.05	MT	L	F	Hatchback Engine Z20LEH	GDS21035	Drive Shaft		30	25	53.8	94.5	581		
<b>ASTRA V (H) SPORT HATCH</b>	2004.01-2009.05	2009.05			R	Hatchback Engine Z20LEH	GDS21062	Drive Shaft		30	34	53.8	94.5	595		
	2004.01-2009.05	2009.05				Hatchback Engine Z20LEH	GC099023	Outer Joint		30	26	53.8	94.5	65.5	M	
	2005.04-2010.11	2010.11	MT	L	F	Hatchback Engine Z13DTH	GDS60020	Drive Shaft		33	25	52.5	94	561		
	2005.04-2010.11	2010.11		L	F	Hatchback Engine Z13DTH	GDS44052	Drive Shaft		33	25	53	93.5	573		
1.3 CDTi (66 kW)	2005.04-2010.11	2010.11		L	F	Hatchback Engine Z13DTH	GCI44008	Inner Joint		25	25	35	77.5	64		
	2005.04-2010.11	2010.11		L/R	F	Hatchback Engine Z13DTH	GC044028	Outer Joint		33	24	53	93.5	63.5	M	
	2005.04-2010.11	2010.11		R	F	Hatchback Engine Z13DTH	GDS44051	Drive Shaft		33	34	53	93.5	570		
	2005.04-2010.11	2010.11		R	F	Hatchback Engine Z13DTH	GCI44011	Inner Joint		34	25	37.5	46	55		
	2005.04-2010.11	2010.11				Hatchback Engine Z13DTH	GC044003	Outer Joint		33	22	53	95	54.5	M	
1.6 (77 kW)	2005.02-2010.11	2010.11	MT		F	Hatchback Engine Z16XEP	GC044003	Outer Joint		33	22	53	95	54.5	M	
	2005.02-2010.11	2010.11	MT	L	F	Hatchback Engine Z16XEP	GCI21014	Inner Joint		22	22	35	57.5	75		
	2005.02-2010.11	2010.11	MT	L	F	Hatchback Engine Z16XEP	GDS44028	Drive Shaft		33	22	53	95	590		
	2005.02-2010.11	2010.11	MT	R	F	Hatchback Engine Z16XEP	GCI21014	Inner Joint		22	22	35	57.5	75		
	2005.02-2010.11	2010.11	MT	R	F	Hatchback Engine Z16XEP	GDS44030	Drive Shaft		33	22	53	95	952		
1.7 CDTi (74 kW)	2005.02-2010.11	2010.11	MT/AT		F	Hatchback Engine Z17DTH	GC044028	Outer Joint		33	24	53	93.5	63.5	M	
	2005.02-2010.11	2010.11	5MT	L	F	Hatchback Engine Z17DTH	GDS44029	Drive Shaft		33	34	53	93.5	594		
	2005.02-2010.11	2010.11	MT	L	F	Hatchback Engine Z17DTH	GDS44024	Drive Shaft		33	34	53	93.5	589		

		TRANSM	L/R	F/R		G-AP Ref.	PRODUCT	ABS	Technical Specifications															
									YEAR	A	B	C	H	L	P									
<b>VAUXHALL</b>																								
<b>ASTRA V (H) SPORT HATCH</b>																								
1.7 CDTi (74 kW)	2005.02-	2010.11	MT	L	F	Hatchback Engine Z17DTH	GDS44052	Drive Shaft		33	25	53	93.5	573										
	2005.02-	2010.11	MT	L	F	Hatchback Engine Z17DTH	GCI44008	Inner Joint		25	25	35	77.5	64										
	2005.02-	2010.11	MT	L	F	Hatchback Engine Z17DTH	GC044028	Outer Joint		33	24	53	93.5	63.5	M									
	2005.02-	2010.11	5MT/6MT	R	F	Hatchback Engine Z17DTH	GDS44031	Drive Shaft		33	34	53	93.5	559										
1.7 CDTi (81 kW)	2007.02-	2010.11		L	F	Hatchback Engine A17DTJ	GDS21051	Drive Shaft		33	25	52.5	94	579										
1.7 CDTi (92 kW)	2007.02-			L	F	Hatchback Engine Z17DTR	GDS21051	Drive Shaft		33	25	52.5	94	579										
	2007.02-					Hatchback Engine Z17DTR	GC099024	Outer Joint		33	26	52.5	94	65.5	M									
1.8 (92 kW)	2005.02-	2010.11	MT/AT		F	Hatchback Engine Z18XE	GC044028	Outer Joint		33	24	53	93.5	63.5	M									
	2005.02-	2010.11	MT	L	F	Hatchback Engine Z18XE	GDS21063	Drive Shaft		33	22	53	93.5	586										
	2005.02-	2010.11	MT/AT	R	F	Hatchback Engine Z18XE	GDS21055	Drive Shaft		33	22	53	93.5	950										
1.8 i 16V (103 kW)	2007.03-	2010.11	MT/AT	L	F	Hatchback Engine A18XER/Z18XER	GDS21063	Drive Shaft		33	22	53	93.5	586										
	2007.03-	2010.11	MT/AT	R	F	Hatchback Engine A18XER/Z18XER	GDS21055	Drive Shaft		33	22	53	93.5	950										
1.9 CDTi (110 kW)	2005.02-	2010.11	MT		F	Hatchback Engine Z19DTH	GC017051	Outer Joint		30	26	53.8	94.5	65.5	M									
	2005.02-	2010.11	MT	L	F	Hatchback Engine Z19DTH	GDS21071	Drive Shaft		30	25	53.8	94.5	576										
	2005.02-	2010.11	MT	R	F	Hatchback Engine Z19DTH	GDS21062	Drive Shaft		30	34	53.8	94.5	595										
	2005.02-	2010.11				Hatchback Engine Z19DTH	GC099023	Outer Joint		30	26	53.8	94.5	65.5	M									
1.9 CDTi (74 kW)	2005.08-	2010.11	MT	L	F	Hatchback Engine Z19DTL	GDS21051	Drive Shaft		33	25	52.5	94	579										
	2005.08-	2010.11		L	F	Hatchback Engine Z19DTL	GDS21073	Drive Shaft		33	25	52.5	94	578										
	2005.08-	2010.11				Hatchback Engine Z19DTL	GC099024	Outer Joint		33	26	52.5	94	65.5	M									
1.9 CDTi (88 kW)	2005.02-	2010.11	MT		F	Hatchback Engine Z19DT	GC044027	Outer Joint		33	26	52.5	94	65.5	M									
	2005.02-	2010.11	MT	L	F	Hatchback Engine Z19DT	GDS21051	Drive Shaft		33	25	52.5	94	579										
	2005.02-	2010.11	MT	L	F	Hatchback Engine Z19DT	GDS21071	Drive Shaft		30	25	53.8	94.5	576										
	2005.02-	2010.11	MT	R	F	Hatchback Engine Z19DT	GDS21062	Drive Shaft		30	34	53.8	94.5	595										
	2005.02-	2010.11				Hatchback Engine Z19DT	GC099024	Outer Joint		33	26	52.5	94	65.5	M									
2.0 Turbo (125 kW)	2005.02-	2010.11			F	Hatchback Engine Z20LEL	GC044027	Outer Joint		33	26	52.5	94	65.5	M									
	2005.02-	2010.11	MT	R	F	Hatchback Engine Z20LEL	GDS21056	Drive Shaft		33	34	52.5	94	595										
	2005.02-	2010.11				Hatchback Engine Z20LEL	GC099024	Outer Joint		33	26	52.5	94	65.5	M									
2.0 VXR (176 kW)	2009.02-	2010.11	MT	L	F	Hatchback Engine Z20LEH	GDS21035	Drive Shaft		30	25	53.8	94.5	581										
	2009.02-	2010.11				Hatchback Engine Z20LEH	GC099023	Outer Joint		30	26	53.8	94.5	65.5	M									
<b>ASTRA VI (J)</b>																								
1.3 CDTi (70 kW)	2009.12-		AT			Hatchback Engine A13DTE	GC088047	Outer Joint		33	23	52.5	94	59.5	M									
	2012.06-		AT			Saloon Engine A13DTE	GC088047	Outer Joint		33	23	52.5	94	59.5	M									
1.4 (74 kW)	2009.12-		MT	L	F	Hatchback Engine A14XER	GDS44064	Drive Shaft		33	22	53	95	618										
	2009.12-		MT	L	F	Hatchback Engine A14XER	GCI21014	Inner Joint		22	22	35	57.5	75										
	2009.12-		MT	R	F	Hatchback Engine A14XER	GDS44065	Drive Shaft		33	22	53	95	983										
	2009.12-		MT	R	F	Hatchback Engine A14XER	GCI21014	Inner Joint		22	22	35	57.5	75										
	2009.12-					Hatchback Engine A14XER	GC044088	Outer Joint		33	23	52.3	94	59.5	M									
	2012.06-		MT	L	F	Saloon Engine A14XER	GDS44064	Drive Shaft		33	22	53	95	618										
	2012.06-		MT	L	F	Saloon Engine A14XER	GCI21014	Inner Joint		22	22	35	57.5	75										
	2012.06-		MT	R	F	Saloon Engine A14XER	GDS44065	Drive Shaft		33	22	53	95	983										
	2012.06-		MT	R	F	Saloon Engine A14XER	GCI21014	Inner Joint		22	22	35	57.5	75										
	2012.06-					Saloon Engine A14XER	GC044088	Outer Joint		33	23	52.3	94	59.5	M									
1.4 Turbo (103 kW)	2009.12-		AT			Hatchback Engine A14NET	GC088047	Outer Joint		33	23	52.5	94	59.5	M									
	2012.06-		AT			Saloon Engine A14NET	GC088047	Outer Joint		33	23	52.5	94	59.5	M									
1.6 (85 kW)	2009.12-		MT	L	F	Hatchback Engine A16XER	GDS44064	Drive Shaft		33	22	53	95	618										
	2009.12-		MT	L	F	Hatchback Engine A16XER	GCI21014	Inner Joint		22	22	35	57.5	75										
	2009.12-		AT	R	F	Hatchback Engine A16XER	GDS21072	Drive Shaft		33	22	52.3	94	957										
	2009.12-		MT	R	F	Hatchback Engine A16XER	GDS44065	Drive Shaft		33	22	53	95	983										
	2009.12-		MT	R	F	Hatchback Engine A16XER	GCI21014	Inner Joint		22	22	35	57.5	75										
	2009.12-		AT			Hatchback Engine A16XER	GC088047	Outer Joint		33	23	52.5	94	59.5	M									
	2009.12-		MT			Hatchback Engine A16XER	GC044088	Outer Joint		33	23	52.3	94	59.5	M									
	2012.06-		AT	R	F	Saloon Engine A16XER	GDS21072	Drive Shaft		33	22	52.3	94	957										
	2012.06-		MT	R	F	Saloon Engine A16XER	GDS44065	Drive Shaft		33	22	53	95	983										
	2012.06-		MT	R	F	Saloon Engine A16XER	GCI21014	Inner Joint		22	22	35	57.5	75										
	2012.06-		AT			Saloon Engine A16XER	GC088047	Outer Joint		33	23	52.5	94	59.5	M									
	2012.06-		MT			Saloon Engine A16XER	GC044088	Outer Joint		33	23	52.3	94	59.5	M									
	2012.06-		MT	L	F	Saloon Engine A16XER	GDS44064	Drive Shaft		33	22	53	95	618										
	2012.06-		MT	L	F	Saloon Engine A16XER	GCI21014	Inner Joint		22	22	35	57.5	75										
1.6 Turbo (132 kW)	2009.12-					Hatchback Engine A16LET	GC099023	Outer Joint		30	26	53.8	94.5	65.5	M									
	2012.06-					Saloon Engine A16LET	GC099023	Outer Joint		30	26	53.8	94.5	65.5	M									
1.7 CDTi (81 kW)	2009.12-		MT	L	F	Hatchback Engine A17DTC/A17DTE/A17DTJ	GDS21076	Drive Shaft		30	25	52.5	94	601										









		TRANSM	L/R	F/R		G-AP Ref.	PRODUCT	ABS	Technical Specifications													
									YEAR	A	B	C	H	L	P							
<b>VAUXHALL</b>																						
<b>ASTRA VI (J)</b>																						
1.7 CDTi (81 kW)	2009.12-		MT	R	F	Hatchback Engine A17DTC/A17DTE/A17DTJ	GDS21074	Drive Shaft		30	34	52.5	94	589								
	2009.12-					Hatchback Engine A17DTC/A17DTE/A17DTJ	GC099023	Outer Joint		30	26	53.8	94.5	65.5	M							
	2012.06-		MT	L	F	Saloon Engine A17DTC/A17DTE/A17DTJ	GDS21076	Drive Shaft		30	25	52.5	94	601								
	2012.06-		MT	R	F	Saloon Engine A17DTC/A17DTE/A17DTJ	GDS21074	Drive Shaft		30	34	52.5	94	589								
	2012.06-					Saloon Engine A17DTC/A17DTE/A17DTJ	GC099023	Outer Joint		30	26	53.8	94.5	65.5	M							
1.7 CDTi (92 kW)	2009.12-		MT	L	F	Hatchback Engine A17DTR	GDS21076	Drive Shaft		30	25	52.5	94	601								
	2009.12-		MT	R	F	Hatchback Engine A17DTR	GDS21074	Drive Shaft		30	34	52.5	94	589								
	2009.12-					Hatchback Engine A17DTR	GC099023	Outer Joint		30	26	53.8	94.5	65.5	M							
1.7 CDTi (96 kW)	2011.06-		MT	L	F	Hatchback Engine A17DTF/A17DTS	GDS21076	Drive Shaft		30	25	52.5	94	601								
	2011.06-		MT	R	F	Hatchback Engine A17DTF/A17DTS	GDS21074	Drive Shaft		30	34	52.5	94	589								
	2011.06-					Hatchback Engine A17DTF/A17DTS	GC099023	Outer Joint		30	26	53.8	94.5	65.5	M							
	2012.06-		MT	L	F	Saloon Engine A17DTF/A17DTS	GDS21076	Drive Shaft		30	25	52.5	94	601								
	2012.06-		MT	R	F	Saloon Engine A17DTF/A17DTS	GDS21074	Drive Shaft		30	34	52.5	94	589								
	2012.06-					Saloon Engine A17DTF/A17DTS	GC099023	Outer Joint		30	26	53.8	94.5	65.5	M							
2.0 CDTi (118 kW)	2009.12-		MT	R	F	Hatchback Engine A20DTH	GDS21036	Drive Shaft		30	27	55.4	100	602								
	2009.12-					Hatchback Engine A20DTH	GC099023	Outer Joint		30	26	53.8	94.5	65.5	M							
2.0 CDTi (121 kW)	2011.08-		MT	R	F	Hatchback Engine A20DTH	GDS21036	Drive Shaft		30	27	55.4	100	602								
	2011.08-					Hatchback Engine A20DTH	GC099023	Outer Joint		30	26	53.8	94.5	65.5	M							
<b>ASTRA VI (J) SPORTS TOURER</b>																						
1.3 CDTi (70 kW)	2010.10-		AT			Estate Engine A13DTE	GC088047	Outer Joint		33	23	52.5	94	59.5	M							
1.4 (74 kW)	2010.10-		MT	L	F	Estate Engine A14XER	GDS44064	Drive Shaft		33	22	53	95	618								
	2010.10-		MT	L	F	Estate Engine A14XER	GCI21014	Inner Joint		22	22	35	57.5	75								
	2010.10-		MT			Estate Engine A14XER	GC044088	Outer Joint		33	23	52.3	94	59.5	M							
1.4 Turbo (103 kW)	2010.10-		AT			Estate Engine A14NET	GC088047	Outer Joint		33	23	52.5	94	59.5	M							
1.6 (85 kW)	2010.10-		MT	L	F	Estate Engine A16XER	GDS44064	Drive Shaft		33	22	53	95	618								
	2010.10-		MT	L	F	Estate Engine A16XER	GCI21014	Inner Joint		22	22	35	57.5	75								
	2010.10-		AT	R	F	Estate Engine A16XER	GDS21072	Drive Shaft		33	22	52.3	94	957								
	2010.10-		MT	R	F	Estate Engine A16XER	GDS44065	Drive Shaft		33	22	53	95	983								
	2010.10-		MT	R	F	Estate Engine A16XER	GCI21014	Inner Joint		22	22	35	57.5	75								
	2010.10-		AT			Estate Engine A16XER	GC088047	Outer Joint		33	23	52.5	94	59.5	M							
1.6 Turbo (132 kW)	2010.10-					Estate Engine A16LET	GC044088	Outer Joint		33	23	52.3	94	59.5	M							
	2010.10-					Estate Engine A16LET	GC099023	Outer Joint		30	26	53.8	94.5	65.5	M							
1.7 CDTi (81 kW)	2010.10-		MT	L	F	Estate Engine A17DTC/A17DTE/A17DTJ	GDS21076	Drive Shaft		30	25	52.5	94	601								
	2010.10-		MT	R	F	Estate Engine A17DTC/A17DTE/A17DTJ	GDS21074	Drive Shaft		30	34	52.5	94	589								
	2010.10-					Estate Engine A17DTC/A17DTE/A17DTJ	GC099023	Outer Joint		30	26	53.8	94.5	65.5	M							
1.7 CDTi (92 kW)	2010.10-		MT	L	F	Estate Engine A17DTR	GDS21076	Drive Shaft		30	25	52.5	94	601								
	2010.10-		MT	R	F	Estate Engine A17DTR	GDS21074	Drive Shaft		30	34	52.5	94	589								
	2010.10-					Estate Engine A17DTR	GC099023	Outer Joint		30	26	53.8	94.5	65.5	M							
1.7 CDTi (96 kW)	2011.06-		MT	L	F	Estate Engine A17DTF/A17DTS	GDS21076	Drive Shaft		30	25	52.5	94	601								
	2011.06-		MT	R	F	Estate Engine A17DTF/A17DTS	GDS21074	Drive Shaft		30	34	52.5	94	589								
	2011.06-					Estate Engine A17DTF/A17DTS	GC099023	Outer Joint		30	26	53.8	94.5	65.5	M							
2.0 CDTi (118 kW)	2010.10-		MT	R	F	Estate Engine A20DTH	GDS21036	Drive Shaft		30	27	55.4	100	602								
	2010.10-					Estate Engine A20DTH	GC099023	Outer Joint		30	26	53.8	94.5	65.5	M							
2.0 CDTi (121 kW)	2011.08-		MT	R	F	Estate Engine A20DTH	GDS21036	Drive Shaft		30	27	55.4	100	602								
	2011.08-					Estate Engine A20DTH	GC099023	Outer Joint		30	26	53.8	94.5	65.5	M							
<b>ASTRAVAN III (F)</b>																						
1.4 i (44 kW)	1991.01-	1994.10	MT	L	F	Box Engine C14NZ	GDS44002	Drive Shaft	29T	22	22	52	95	585								
	1991.01-	1994.10	MT		F	Box Engine C14NZ	GCI44004	Inner Joint		22	22	34.95	57.5	72.5								
	1991.01-	1994.10	MT		F	Box Engine C14NZ	GC044051	Outer Joint	29T	22	22	52	95	50.5	O							
1.6 i (52 kW)	1994.02-	1996.10	MT		F	Box Engine X16SZ	GCI44004	Inner Joint		22	22	34.95	57.5	72.5								
1.6 i (55 kW)	1991.01-	1998.08	MT	L	F	Box Engine C16NZ	GDS44002	Drive Shaft	29T	22	22	52	95	585								
	1991.01-	1998.08	MT		F	Box Engine C16NZ	GCI44004	Inner Joint		22	22	34.95	57.5	72.5								
	1991.01-	1998.08	MT/AT		F	Box Engine C16NZ	GC044051	Outer Joint	29T	22	22	52	95	50.5	O							
1.7 D (44 kW)	1991.01-	1994.08	MT		F	Box Engine 17DR	GCI44004	Inner Joint		22	22	34.95	57.5	72.5								
	1991.01-	1994.08	MT/AT		F	Box Engine 17DR	GC044056	Outer Joint	29T	33	25	52	109	61	O							
<b>ASTRAVAN IV (G)</b>																						
1.7 CDTi (59 kW)	2004.04-	2006.08		R	F	Box Engine Z17DTL	GDS60035	Drive Shaft		33	22	52	109	961								
1.7 DTi 16V (55 kW)	2001.04-	2006.08		R	F	Box Engine Y17DT	GDS60035	Drive Shaft		33	22	52	109	961								
2.0 Di (60 kW)	1998.08-	2006.08			F	Box Engine X20DTL	GC044049	Outer Joint		33	25	52	109	61	O							
	1998.08-	2006.08	MT/AT		F	Box Engine X20DTL	GC044006	Outer Joint	29T	33	25	52	103.5	61	O							
2.0 DTi (74 kW)	2004.04-	2006.08			F	Box Engine Y20DTH	GC044049	Outer Joint		33	25	52	109	61	O							

		TRANSM	L/R	F/R		G-AP Ref.	PRODUCT	ABS	Technical Specifications					
									YEAR	A	B	C	H	L
<b>VAUXHALL</b>														
<b>ASTRAVAN V (H)</b>														
1.3 CDTi (66 kW)	2005.08-		MT	L	F	Box Engine Z13DTH	GDS60020	Drive Shaft	33	25	52.5	94	561	
	2005.08-			L	F	Box Engine Z13DTH	GDS44052	Drive Shaft	33	25	53	93.5	573	
	2005.08-			L	F	Box Engine Z13DTH	GCI44008	Inner Joint	25	25	35	77.5	64	
	2005.08-			L/R	F	Box Engine Z13DTH	GC044028	Outer Joint	33	24	53	93.5	63.5 M	
	2005.08-			R	F	Box Engine Z13DTH	GDS44051	Drive Shaft	33	34	53	93.5	570	
	2005.08-			R	F	Box Engine Z13DTH	GCI44011	Inner Joint	34	25	37.5	46	55	
1.7 CDTi (59 kW)	2005.03-2006.07		MT	L	F	Box Engine Z17DTL	GDS21063	Drive Shaft	33	22	53	93.5	586	
	2005.03-2006.07		MT	R	F	Box Engine Z17DTL	GDS21055	Drive Shaft	33	22	53	93.5	950	
1.7 CDTi (74 kW)	2005.03-2011.11		MT	L	F	Box Engine Z17DTH	GDS44024	Drive Shaft	33	34	53	93.5	589	
	2005.03-2011.11			L	F	Box Engine Z17DTH	GDS21073	Drive Shaft	33	25	52.5	94	578	
1.7 CDTi (81 kW)	2011.11-					Box Engine A17DTJ/Z17DTJ	GC099024	Outer Joint	33	26	52.5	94	65.5 M	
1.7 CDTi (92 kW)	2011.11-					Box Engine A17DTR/Z17DTR	GC099024	Outer Joint	33	26	52.5	94	65.5 M	
1.9 CDTi (110 kW)	2005.03-2011.11			L	F	Box Engine Z19DTH	GDS21071	Drive Shaft	30	25	53.8	94.5	576	
	2005.03-2011.11			R	F	Box Engine Z19DTH	GDS21062	Drive Shaft	30	34	53.8	94.5	595	
	2005.03-2011.11					Box Engine Z19DTH	GC099023	Outer Joint	30	26	53.8	94.5	65.5 M	
1.9 CDTi (88 kW)	2005.03-2011.11		MT	L	F	Box Engine Z19DT	GDS21051	Drive Shaft	33	25	52.5	94	579	
	2005.03-2011.11			L	F	Box Engine Z19DT	GDS21073	Drive Shaft	33	25	52.5	94	578	
	2005.03-2011.11					Box Engine Z19DT	GC099024	Outer Joint	33	26	52.5	94	65.5 M	
<b>CALIBRA</b>														
2.0 i (85 kW)	1990.06-1997.07		MT/AT		F	Coupe Engine C20NE	GC044057	Outer Joint	43T	33	25	52	109	61 O
	1990.06-1997.07		MT	L	F	Coupe Engine C20NE	GDS44014	Drive Shaft	43T	33	34	52	103.5	587
	1990.06-1997.07		MT		F	Coupe Engine C20NE	GCI44002	Inner Joint		34	25	35	56.2	85.6
	1990.06-1997.07		MT	R	F	Coupe Engine C20NE	GDS44059	Drive Shaft	29T	33	34	52	109	938
	1990.06-1997.07		MT	L	F	Coupe Engine C20NE	GDS44011	Drive Shaft	29T	33	34	52	109	594.5
	1990.06-1997.07		MT/AT		F	Coupe Engine C20NE	GC044056	Outer Joint	29T	33	25	52	109	61 O
2.0 i 16V (100 kW)	1990.06-1997.07		MT		F	Coupe Engine X20XEV	GC044057	Outer Joint	43T	33	25	52	109	61 O
	1990.06-1997.07		MT		F	Coupe Engine X20XEV	GC044056	Outer Joint	29T	33	25	52	109	61 O
2.0 i 16V (110 kW)	1990.06-1994.02		MT		F	Coupe Engine C20XE	GC044057	Outer Joint	43T	33	25	52	109	61 O
	1990.06-1994.02		MT	L	F	Coupe Engine C20XE	GDS44014	Drive Shaft	43T	33	34	52	103.5	587
	1990.06-1994.02		MT		F	Coupe Engine C20XE	GCI44002	Inner Joint		34	25	35	56.2	85.6
	1990.06-1994.02		MT		F	Coupe Engine C20XE	GCI44005	Inner Joint		34	25	35	54	47
	1990.06-1994.02		MT	L	F	Coupe Engine C20XE	GDS44011	Drive Shaft	29T	33	34	52	109	594.5
	1990.06-1994.02		MT		F	Coupe Engine C20XE	GC044056	Outer Joint	29T	33	25	52	109	61 O
2.0 i 16V 4x4 (100 kW)	1994.02-1997.07		MT			Coupe Engine X20XEV	GC044057	Outer Joint	43T	33	25	52	109	61 O
	1994.02-1997.07		MT		F	Coupe Engine X20XEV	GC044056	Outer Joint	29T	33	25	52	109	61 O
2.0 i 16V 4x4 (110 kW)	1990.06-1994.02		MT			Coupe Engine C20XE	GC044057	Outer Joint	43T	33	25	52	109	61 O
	1990.06-1994.02		MT	L	F	Coupe Engine C20XE	GDS44014	Drive Shaft	43T	33	34	52	103.5	587
	1990.06-1994.02		MT		F	Coupe Engine C20XE	GCI44002	Inner Joint		34	25	35	56.2	85.6
	1990.06-1994.02		MT		F	Coupe Engine C20XE	GCI44005	Inner Joint		34	25	35	54	47
	1990.06-1994.02		MT	L	F	Coupe Engine C20XE	GDS44011	Drive Shaft	29T	33	34	52	109	594.5
	1990.06-1994.02		MT		F	Coupe Engine C20XE	GC044056	Outer Joint	29T	33	25	52	109	61 O
2.0 i 4x4 (85 kW)	1990.06-1997.07		MT			Coupe Engine C20NE	GC044057	Outer Joint	43T	33	25	52	109	61 O
	1990.06-1997.07		MT	L	F	Coupe Engine C20NE	GDS44014	Drive Shaft	43T	33	34	52	103.5	587
	1990.06-1997.07		MT		F	Coupe Engine C20NE	GCI44002	Inner Joint		34	25	35	56.2	85.6
	1990.06-1997.07		MT		F	Coupe Engine C20NE	GCI44005	Inner Joint		34	25	35	54	47
	1990.06-1997.07		MT	L	F	Coupe Engine C20NE	GDS44011	Drive Shaft	29T	33	34	52	109	594.5
	1990.06-1997.07		MT		F	Coupe Engine C20NE	GC044056	Outer Joint	29T	33	25	52	109	61 O
2.0 i Turbo 4x4 (150 kW)	1992.03-1997.07		MT		F	Coupe Engine C20LET	GCI44002	Inner Joint		34	25	35	56.2	85.6
	1992.03-1997.07		MT		F	Coupe Engine C20LET	GCI44005	Inner Joint		34	25	35	54	47
	1992.03-1997.07		MT	L	F	Coupe Engine C20LET	GDS44011	Drive Shaft	29T	33	34	52	109	594.5
	1992.03-1997.07		MT		F	Coupe Engine C20LET	GC044056	Outer Joint	29T	33	25	52	109	61 O
2.5 i V6 (125 kW)	1993.04-1997.07		MT		F	Coupe Engine C25XE/X25XE	GCI44002	Inner Joint		34	25	35	56.2	85.6
	1993.04-1997.07		MT		F	Coupe Engine C25XE/X25XE	GCI44005	Inner Joint		34	25	35	54	47
<b>CALIBRA A (85)</b>														
2.0 i (85 kW)	1990-	1991.07	MT/AT			Ch-N5000000	GC044057	Outer Joint	43T	33	25	52	109	61 O
2.0 i 16V 4WD (100 kW)	1990.06-	1997.07			F	Ch-N5000000	GC044057	Outer Joint	43T	33	25	52	109	61 O
2.0 i 16V 4WD (110 kW)	1990.06-	1997.07			F	Ch-N5000000	GC044057	Outer Joint	43T	33	25	52	109	61 O
2.0 i 16V 4WD (115 kW)	1990.06-	1997.07			F	Ch-N5000000	GC044057	Outer Joint	43T	33	25	52	109	61 O
2.0 i 4WD (85 kW)	1990.06-	1997.07	MT/AT			Ch-N5000000	GC044057	Outer Joint	43T	33	25	52	109	61 O
2.5 i V6 (125 kW)	1993.04-	1997.07					GC044057	Outer Joint	43T	33	25	52	109	61 O



		YEAR	TRANSM	L/R	F/R		G-AP Ref.	PRODUCT	ABS	Technical Specifications						
										A	B	C	H	L	P	
<b>VAUXHALL</b>																
<b>CASCADA</b>																
1.4 (103 kW)	2013.02-					Convertible Engine A14NET	GC099023	Outer Joint		30	26	53.8	94.5	65.5	M	
1.4 (88 kW)	2013.02-					Convertible Engine A14NEL	GC099023	Outer Joint		30	26	53.8	94.5	65.5	M	
2.0 CDTi (121 kW)	2013.02-		AT			Convertible Engine A20DTH	GC099023	Outer Joint		30	26	53.8	94.5	65.5	M	
2.0 CDTi (143 kW)	2013.02-		AT			Convertible Engine A20DTR	GC099023	Outer Joint		30	26	53.8	94.5	65.5	M	
<b>CAVALIER II</b>																
1.3 N (44 kW)	1981.09-1988.08		MT		F	Saloon Engine 13N	GC044041	Outer Joint		22	22	52	95	50	O	
	1981.09-1988.08		MT		F	Saloon Engine 13N	GCI44004	Inner Joint		22	22	34.95	57.5	72.5		
1.3 S (55 kW)	1981.09-1988.08		MT		F	Estate Engine 13S	GC044041	Outer Joint		22	22	52	95	50	O	
	1981.09-1988.08		MT		F	Hatchback Engine 13S	GC044041	Outer Joint		22	22	52	95	50	O	
	1981.09-1988.08		MT		F	Saloon Engine 13S	GC044041	Outer Joint		22	22	52	95	50	O	
	1981.09-1988.08		MT		F	Estate Engine 13S	GCI44004	Inner Joint		22	22	34.95	57.5	72.5		
	1981.09-1988.08		MT		F	Hatchback Engine 13S	GCI44004	Inner Joint		22	22	34.95	57.5	72.5		
	1981.09-1988.08		MT		F	Saloon Engine 13S	GCI44004	Inner Joint		22	22	34.95	57.5	72.5		
1.6 (66 kW)	1983.10-1988.08		MT		F	Estate Engine 16SH	GC099205	Outer Joint		33	25	52	109	61	O	
	1983.10-1988.08		MT		F	Estate Engine 16SH	GCI44001	Inner Joint		34	22	35	56.2	76		
1.6 D (40 kW)	1982.03-1988.08		MT		F	Hatchback Engine 16D/16DA	GC099205	Outer Joint		33	25	52	109	61	O	
	1982.03-1988.08		MT		F	Hatchback Engine 16D/16DA	GCI44001	Inner Joint		34	22	35	56.2	76		
	1982.03-1988.08		MT		F	Saloon Engine 16D	GCI44001	Inner Joint		34	22	35	56.2	76		
1.6 i (55 kW)	1986.08-1988.08		MT		F	Saloon Engine E16NZ	GC044041	Outer Joint		22	22	52	95	50	O	
	1986.08-1988.08		MT		F	Saloon Engine E16NZ	GCI44004	Inner Joint		22	22	34.95	57.5	72.5		
1.6 i CAT (55 kW)	1986.08-1988.08		MT		F	Saloon Engine C16LZ/C16NZ	GC044041	Outer Joint		22	22	52	95	50	O	
	1986.08-1988.08		MT		F	Saloon Engine C16LZ/C16NZ	GCI44004	Inner Joint		22	22	34.95	57.5	72.5		
1.6 N (55 kW)	1981.09-1988.08		MT		F	Saloon Engine 16N	GC044041	Outer Joint		22	22	52	95	50	O	
	1981.09-1988.08		MT		F	Saloon Engine 16N	GCI44004	Inner Joint		22	22	34.95	57.5	72.5		
1.6 S (66 kW)	1981.09-1988.08		MT		F	Hatchback Engine 16SH	GC099205	Outer Joint		33	25	52	109	61	O	
	1981.09-1988.08		MT		F	Saloon Engine 16SH	GC099205	Outer Joint		33	25	52	109	61	O	
	1981.09-1988.08		MT		F	Hatchback Engine 16SH	GCI44002	Inner Joint		34	25	35	56.2	85.6		
	1981.09-1988.08		MT		F	Saloon Engine 16SH	GCI44002	Inner Joint		34	25	35	56.2	85.6		
	1981.09-1988.08		MT		F	Hatchback Engine 16SH	GCI44001	Inner Joint		34	22	35	56.2	76		
1.8 (62 kW)	1986.08-1988.08		MT		F	Saloon Engine E18NV	GC099205	Outer Joint		33	25	52	109	61	O	
	1986.08-1988.08		MT		F	Saloon Engine E18NV	GCI44002	Inner Joint		34	25	35	56.2	85.6		
1.8 i (82 kW)	1981.09-1986.08		MT		F	Estate Engine 18E/18SE	GC099205	Outer Joint		33	25	52	109	61	O	
	1981.09-1988.08		MT		F	Hatchback Engine 18SE	GC099205	Outer Joint		33	25	52	109	61	O	
	1981.09-1988.08		MT		F	Saloon Engine 18SE	GC099205	Outer Joint		33	25	52	109	61	O	
	1981.09-1986.08		MT		F	Estate Engine 18E/18SE	GCI44002	Inner Joint		34	25	35	56.2	85.6		
	1981.09-1988.08		MT		F	Hatchback Engine 18SE	GCI44002	Inner Joint		34	25	35	56.2	85.6		
	1981.09-1988.08		MT		F	Saloon Engine 18SE	GCI44002	Inner Joint		34	25	35	56.2	85.6		
	1985.03-1988.10		MT		F	Convertible Engine 18SE	GC099205	Outer Joint		33	25	52	109	61	O	
1.8 i (85 kW)	1985.03-1988.10		MT		F	Convertible Engine 18SE	GCI44002	Inner Joint		34	25	35	56.2	85.6		
	1981.09-1988.08		MT		F	Hatchback Engine 18E	GC099205	Outer Joint		33	25	52	109	61	O	
1.8 i CAT (74 kW)	1981.09-1988.08		MT		F	Saloon Engine 18E	GC099205	Outer Joint		33	25	52	109	61	O	
	1981.09-1988.08		MT		F	Hatchback Engine 18E	GCI44002	Inner Joint		34	25	35	56.2	85.6		
	1981.09-1988.08		MT		F	Saloon Engine 18E	GCI44002	Inner Joint		34	25	35	56.2	85.6		
2.0 i (85 kW)	1985.01-1986.08		MT		F	Saloon Engine C18NE	GC099205	Outer Joint		33	25	52	109	61	O	
	1985.01-1986.08		MT		F	Saloon Engine C18NE	GCI44002	Inner Joint		34	25	35	56.2	85.6		
2.0 i (90 kW)	1986.09-1988.08		MT		F	Saloon Engine 20NE	GC099205	Outer Joint		33	25	52	109	61	O	
	1986.09-1988.08		MT		F	Saloon Engine 20NE	GCI44002	Inner Joint		34	25	35	56.2	85.6		
2.0 i (90 kW)	1986.09-1988.08		MT		F	Hatchback Engine 20SE	GC099205	Outer Joint		33	25	52	109	61	O	
	1986.09-1988.08		MT		F	Saloon Engine 20SE	GC099205	Outer Joint		33	25	52	109	61	O	
	1986.09-1988.08		MT		F	Hatchback Engine 20SE	GCI44002	Inner Joint		34	25	35	56.2	85.6		
	1986.09-1988.08		MT		F	Saloon Engine 20SE	GCI44002	Inner Joint		34	25	35	56.2	85.6		
2.0 i CAT (85 kW)	1986.09-1988.08		MT		F	Hatchback Engine C20NE	GC099205	Outer Joint		33	25	52	109	61	O	
	1986.09-1988.08		MT		F	Saloon Engine C20NE	GC099205	Outer Joint		33	25	52	109	61	O	
	1986.09-1988.08		MT		F	Hatchback Engine C20NE	GCI44002	Inner Joint		34	25	35	56.2	85.6		
2.0 SRi (95 kW)	1986.09-1988.08		MT		F	Saloon Engine C20NE	GCI44002	Inner Joint		34	25	35	56.2	85.6		
	1987.03-1988.08		MT		F	Hatchback Engine 20SEH	GC099205	Outer Joint		33	25	52	109	61	O	
	1987.03-1988.08		MT		F	Saloon Engine 20SEH	GC099205	Outer Joint		33	25	52	109	61	O	
	1987.03-1988.08		MT		F	Hatchback Engine 20SEH	GCI44002	Inner Joint		34	25	35	56.2	85.6		
1987.03-1988.08		MT		F	Saloon Engine 20SEH	GCI44002	Inner Joint		34	25	35	56.2	85.6			





		TRANSM	L/R	F/R		G-AP Ref.	PRODUCT	ABS	Technical Specifications								
									YEAR	A	B	C	H	L	P		
<b>VAUXHALL</b>																	
<b>CAVALIER III</b>																	
1.4 S (55 kW)	1988.09-1995.11	MT		F	Hatchback Engine 14NV	GCO44055	Outer Joint	43T	22	22	52	95	50.5	O			
	1988.09-1995.11	MT	L	F	Hatchback Engine 14NV	GDS44002	Drive Shaft	29T	22	22	52	95	585				
	1988.09-1995.11	MT		F	Hatchback Engine 14NV	GCI44004	Inner Joint		22	22	34.95	57.5	72.5				
	1988.09-1995.11	MT		F	Hatchback Engine 14NV	GCO44051	Outer Joint	29T	22	22	52	95	50.5	O			
1.4/1.6	1988-1995	MT	L	F		GDS60010	Drive Shaft		22	22	52.2	97	587				
1.6 (60 kW)	1988.09-1993.05	MT/AT		F	Hatchback Engine 16SV	GCO44055	Outer Joint	43T	22	22	52	95	50.5	O			
	1988.09-1993.05	MT	L	F	Hatchback Engine 16SV	GDS44002	Drive Shaft	29T	22	22	52	95	585				
	1988.09-1993.05	MT		F	Hatchback Engine 16SV	GCI44004	Inner Joint		22	22	34.95	57.5	72.5				
	1988.09-1993.05	MT/AT		F	Hatchback Engine 16SV	GCO44051	Outer Joint	29T	22	22	52	95	50.5	O			
1.6 i (52 kW)	1993.09-1995.11	MT		F	Hatchback Engine X16SZ	GCI44004	Inner Joint		22	22	34.95	57.5	72.5				
1.6 i (55 kW)	1988.09-1995.11	MT/AT		F	Hatchback Engine E16NZ	GCO44055	Outer Joint	43T	22	22	52	95	50.5	O			
	1988.09-1995.11	MT	L	F	Hatchback Engine E16NZ	GDS44002	Drive Shaft	29T	22	22	52	95	585				
	1988.09-1995.11	MT		F	Hatchback Engine E16NZ	GCI44004	Inner Joint		22	22	34.95	57.5	72.5				
	1988.09-1995.11	MT/AT		F	Hatchback Engine E16NZ	GCO44051	Outer Joint	29T	22	22	52	95	50.5	O			
1.7 D (42 kW)	1988.09-1992.09	MT		F	Hatchback Engine 17D	GCI44004	Inner Joint		22	22	34.95	57.5	72.5				
	1988.09-1992.09	MT/AT		F	Hatchback Engine 17D	GCO44056	Outer Joint	29T	33	25	52	109	61	O			
	1988.09-1992.09	MT/AT		F	Hatchback Engine 17D	GCO44057	Outer Joint	43T	33	25	52	109	61	O			
1.7 D (44 kW)	1992.07-1995.11	MT		F	Hatchback Engine 17DR	GCI44004	Inner Joint		22	22	34.95	57.5	72.5				
	1992.07-1995.11	MT/AT		F	Hatchback Engine 17DR	GCO44056	Outer Joint	29T	33	25	52	109	61	O			
1.7 TD (60 kW)	1988.09-1995.11	MT	L	F	Hatchback Engine 17DT(TC4EE1)	GDS44014	Drive Shaft	43T	33	34	52	103.5	587				
	1988.09-1995.11	MT		F	Hatchback Engine 17DT(TC4EE1)	GCI44002	Inner Joint		34	25	35	56.2	85.6				
	1988.09-1995.11	MT	R	F	Hatchback Engine 17DT(TC4EE1)	GDS44059	Drive Shaft	29T	33	34	52	109	938				
	1988.09-1995.11	MT	L	F	Hatchback Engine 17DT(TC4EE1)	GDS44011	Drive Shaft	29T	33	34	52	109	594.5				
	1988.09-1995.11	MT/AT		F	Hatchback Engine 17DT(TC4EE1)	GCO44056	Outer Joint	29T	33	25	52	109	61	O			
	1988.09-1995.11	MT/AT		F	Hatchback Engine 17DT(TC4EE1)	GCO44057	Outer Joint	43T	33	25	52	109	61	O			
1.8 (66 kW)	1988.09-1990.10	MT	L	F	Hatchback Engine 18SV/C18NZ	GDS44014	Drive Shaft	43T	33	34	52	103.5	587				
	1988.09-1990.10	MT		F	Hatchback Engine 18SV/C18NZ	GCI44002	Inner Joint		34	25	35	56.2	85.6				
	1988.09-1990.10	MT	R	F	Hatchback Engine 18SV/C18NZ	GDS44059	Drive Shaft	29T	33	34	52	109	938				
	1988.09-1990.10	MT	L	F	Hatchback Engine 18SV/C18NZ	GDS44011	Drive Shaft	29T	33	34	52	109	594.5				
	1988.09-1990.10	MT/AT		F	Hatchback Engine 18SV/C18NZ	GCO44056	Outer Joint	29T	33	25	52	109	61	O			
	1988.09-1990.10	MT/AT		F	Hatchback Engine 18SV/C18NZ	GCO44057	Outer Joint	43T	33	25	52	109	61	O			
1.8 i CAT (66 kW)	1990.03-1995.11	MT	L	F	Hatchback Engine C18NZ	GDS44014	Drive Shaft	43T	33	34	52	103.5	587				
	1990.03-1995.11	MT		F	Hatchback Engine C18NZ	GCI44002	Inner Joint		34	25	35	56.2	85.6				
	1990.03-1995.11	MT	R	F	Hatchback Engine C18NZ	GDS44059	Drive Shaft	29T	33	34	52	109	938				
	1990.03-1995.11	MT	L	F	Hatchback Engine C18NZ	GDS44011	Drive Shaft	29T	33	34	52	109	594.5				
	1990.03-1995.11	MT/AT		F	Hatchback Engine C18NZ	GCO44056	Outer Joint	29T	33	25	52	109	61	O			
2.0 i (85 kW)	1988.09-1992.10	MT	L	F	Hatchback Engine 20NE	GDS44014	Drive Shaft	43T	33	34	52	103.5	587				
	1988.09-1992.10	MT		F	Hatchback Engine 20NE	GCI44002	Inner Joint		34	25	35	56.2	85.6				
	1988.09-1992.10	MT	R	F	Hatchback Engine 20NE	GDS44059	Drive Shaft	29T	33	34	52	109	938				
	1988.09-1992.10	MT	L	F	Hatchback Engine 20NE	GDS44011	Drive Shaft	29T	33	34	52	109	594.5				
	1988.09-1992.10	MT/AT		F	Hatchback Engine 20NE	GCO44056	Outer Joint	29T	33	25	52	109	61	O			
	1988.09-1992.10	MT/AT		F	Hatchback Engine 20NE	GCO44057	Outer Joint	43T	33	25	52	109	61	O			
2.0 i 16V (100 kW)	1993.09-1995.11	MT		F	Hatchback Engine X20XEV	GCI44002	Inner Joint		34	25	35	56.2	85.6				
	1993.09-1995.11	MT		F	Hatchback Engine X20XEV	GCI44005	Inner Joint		34	25	35	54	47				
2.0 i 16V (110 kW)	1988.09-1995.11	MT	L	F	Hatchback Engine C20XE	GDS44014	Drive Shaft	43T	33	34	52	103.5	587				
	1988.09-1995.11	MT		F	Hatchback Engine C20XE	GCI44002	Inner Joint		34	25	35	56.2	85.6				
	1988.09-1995.11	MT		F	Hatchback Engine C20XE	GCI44005	Inner Joint		34	25	35	54	47				
	1988.09-1995.11	MT	L	F	Hatchback Engine C20XE	GDS44011	Drive Shaft	29T	33	34	52	109	594.5				
	1988.09-1995.11	MT		F	Hatchback Engine C20XE	GCO44056	Outer Joint	29T	33	25	52	109	61	O			
	1988.09-1995.11	MT		F	Hatchback Engine C20XE	GCO44057	Outer Joint	43T	33	25	52	109	61	O			
2.0 i 16V 4x4 (110 kW)	1992.01-1993.11	MT		F	Hatchback Engine C20XE	GCI44002	Inner Joint		34	25	35	56.2	85.6				
	1992.01-1993.11	MT		F	Hatchback Engine C20XE	GCI44005	Inner Joint		34	25	35	54	47				
	1992.01-1993.11	MT		F	Hatchback Engine C20XE	GCO44056	Outer Joint	29T	33	25	52	109	61	O			
	1992.01-1993.11	MT		F	Hatchback Engine C20XE	GCO44057	Outer Joint	43T	33	25	52	109	61	O			
2.0 i 4x4 (85 kW)	1991.01-1992.10	MT		F	Hatchback Engine 20NE	GCI44002	Inner Joint		34	25	35	56.2	85.6				
	1991.01-1992.10	MT		F	Hatchback Engine 20NE	GCI44005	Inner Joint		34	25	35	54	47				
	1991.01-1992.10	MT		F	Hatchback Engine 20NE	GCO44056	Outer Joint	29T	33	25	52	109	61	O			
	1991.01-1992.10	MT		F	Hatchback Engine 20NE	GCO44057	Outer Joint	43T	33	25	52	109	61	O			
2.0 i 4x4 (95 kW)	1988.09-1992.09	MT		F	Hatchback Engine 20SEH	GCI44002	Inner Joint		34	25	35	56.2	85.6				
	1988.09-1992.09	MT		F	Hatchback Engine 20SEH	GCI44005	Inner Joint		34	25	35	54	47				



		TRANSM	L/R	F/R		G-AP Ref.	PRODUCT	ABS	Technical Specifications							
									YEAR	A	B	C	H	L	P	
<b>VAUXHALL CAVALIER III</b>																
2.0 i 4x4 (95 kW)	1988.09-	1992.09	MT		F	Hatchback Engine 20SEH	GC044056	Outer Joint	29T	33	25	52	109	61	O	
	1988.09-	1992.09	MT			Hatchback Engine 20SEH	GC044057	Outer Joint	43T	33	25	52	109	61	O	
2.0 i CAT (85 kW)	1990.09-	1995.11	MT	L	F	Hatchback Engine C20NE	GDS44014	Drive Shaft	43T	33	34	52	103.5	587		
	1990.09-	1995.11	MT		F	Hatchback Engine C20NE	GCI44002	Inner Joint		34	25	35	56.2	85.6		
	1990.09-	1995.11	MT	R	F	Hatchback Engine C20NE	GDS44059	Drive Shaft	29T	33	34	52	109	938		
	1990.09-	1995.11	MT	L	F	Hatchback Engine C20NE	GDS44011	Drive Shaft	29T	33	34	52	109	594.5		
	1990.09-	1995.11	MT/AT		F	Hatchback Engine C20NE	GC044056	Outer Joint	29T	33	25	52	109	61	O	
	1990.09-	1995.11	MT/AT		F	Hatchback Engine C20NE	GC044057	Outer Joint	43T	33	25	52	109	61	O	
2.0 SRi (95 kW)	1988.09-	1992.09	MT	L	F	Hatchback Engine 20SEH	GDS44014	Drive Shaft	43T	33	34	52	103.5	587		
	1988.09-	1992.09	MT		F	Hatchback Engine 20SEH	GCI44002	Inner Joint		34	25	35	56.2	85.6		
	1988.09-	1992.09	MT	R	F	Hatchback Engine 20SEH	GDS44059	Drive Shaft	29T	33	34	52	109	938		
	1988.09-	1992.09	MT	L	F	Hatchback Engine 20SEH	GDS44011	Drive Shaft	29T	33	34	52	109	594.5		
	1988.09-	1992.09	MT/AT		F	Hatchback Engine 20SEH	GC044056	Outer Joint	29T	33	25	52	109	61	O	
	1988.09-	1992.09	MT/AT		F	Hatchback Engine 20SEH	GC044057	Outer Joint	43T	33	25	52	109	61	O	
2.5 V6 (125 kW)	1988.09-	1994.06	MT		F	Hatchback Engine C25XE	GCI44002	Inner Joint		34	25	35	56.2	85.6		
	1988.09-	1994.06	MT		F	Hatchback Engine C25XE	GCI44005	Inner Joint		34	25	35	54	47		
<b>CAVALIER III (87)</b>																
1.4 S (55 kW)	1988.09-	1995.11	MT		F	Saloon Engine 14NV	GC044055	Outer Joint	43T	22	22	52	95	50.5	O	
	1988.09-	1995.11	MT	L	F	Saloon Engine 14NV	GDS44002	Drive Shaft	29T	22	22	52	95	585		
	1988.09-	1995.11	MT		F	Saloon Engine 14NV	GCI44004	Inner Joint		22	22	34.95	57.5	72.5		
	1988.09-	1995.11	MT		F	Saloon Engine 14NV	GC044051	Outer Joint	29T	22	22	52	95	50.5	O	
1.6 (60 kW)	1988.09-	1993.05	MT/AT		F	Saloon Engine 16SV	GC044055	Outer Joint	43T	22	22	52	95	50.5	O	
	1988.09-	1993.05	MT	L	F	Saloon Engine 16SV	GDS44002	Drive Shaft	29T	22	22	52	95	585		
	1988.09-	1993.05	MT		F	Saloon Engine 16SV	GCI44004	Inner Joint		22	22	34.95	57.5	72.5		
	1988.09-	1993.05	MT/AT		F	Saloon Engine 16SV	GC044051	Outer Joint	29T	22	22	52	95	50.5	O	
1.6 i (52 kW)	1993.09-	1995.11	MT		F	Saloon Engine X16SZ	GCI44004	Inner Joint		22	22	34.95	57.5	72.5		
1.6 i (55 kW)	1988.09-	1995.11	MT/AT		F	Saloon Engine E16NZ	GC044055	Outer Joint	43T	22	22	52	95	50.5	O	
	1988.09-	1995.11	MT	L	F	Saloon Engine E16NZ	GDS44002	Drive Shaft	29T	22	22	52	95	585		
	1988.09-	1995.11	MT		F	Saloon Engine E16NZ	GCI44004	Inner Joint		22	22	34.95	57.5	72.5		
	1988.09-	1995.11	MT/AT		F	Saloon Engine E16NZ	GC044051	Outer Joint	29T	22	22	52	95	50.5	O	
1.7 D (42 kW)	1988.09-	1992.09	MT		F	Saloon Engine 17D	GCI44004	Inner Joint		22	22	34.95	57.5	72.5		
	1988.09-	1992.09	MT/AT		F	Saloon Engine 17D	GC044056	Outer Joint	29T	33	25	52	109	61	O	
	1988.09-	1992.09	MT/AT		F	Saloon Engine 17D	GC044057	Outer Joint	43T	33	25	52	109	61	O	
1.7 D (44 kW)	1992.07-	1995.11	MT		F	Saloon Engine 17DR	GCI44004	Inner Joint		22	22	34.95	57.5	72.5		
	1992.07-	1995.11	MT/AT		F	Saloon Engine 17DR	GC044056	Outer Joint	29T	33	25	52	109	61	O	
1.7 TD (60 kW)	1988.09-	1995.11	MT	L	F	Saloon Engine 17DT(TC4EE1)	GDS44014	Drive Shaft	43T	33	34	52	103.5	587		
	1988.09-	1995.11	MT		F	Saloon Engine 17DT(TC4EE1)	GCI44002	Inner Joint		34	25	35	56.2	85.6		
	1988.09-	1995.11	MT	R	F	Saloon Engine 17DT(TC4EE1)	GDS44059	Drive Shaft	29T	33	34	52	109	938		
	1988.09-	1995.11	MT	L	F	Saloon Engine 17DT(TC4EE1)	GDS44011	Drive Shaft	29T	33	34	52	109	594.5		
	1988.09-	1995.11	MT/AT		F	Saloon Engine 17DT(TC4EE1)	GC044056	Outer Joint	29T	33	25	52	109	61	O	
	1988.09-	1995.11	MT/AT		F	Saloon Engine 17DT(TC4EE1)	GC044057	Outer Joint	43T	33	25	52	109	61	O	
1.8 (66 kW)	1988.09-	1995.08	MT	L	F	Saloon Engine 18SV/C18NZ	GDS44014	Drive Shaft	43T	33	34	52	103.5	587		
	1988.09-	1995.08	MT		F	Saloon Engine 18SV/C18NZ	GCI44002	Inner Joint		34	25	35	56.2	85.6		
	1988.09-	1995.08	MT	R	F	Saloon Engine 18SV/C18NZ	GDS44059	Drive Shaft	29T	33	34	52	109	938		
	1988.09-	1995.08	MT	L	F	Saloon Engine 18SV/C18NZ	GDS44011	Drive Shaft	29T	33	34	52	109	594.5		
	1988.09-	1995.08	MT/AT		F	Saloon Engine 18SV/C18NZ	GC044056	Outer Joint	29T	33	25	52	109	61	O	
	1988.09-	1995.08	MT/AT		F	Saloon Engine 18SV/C18NZ	GC044057	Outer Joint	43T	33	25	52	109	61	O	
1.8 i CAT (66 kW)	1990.03-	1995.11	MT	L	F	Saloon Engine C18NZ	GDS44014	Drive Shaft	43T	33	34	52	103.5	587		
	1990.03-	1995.11	MT		F	Saloon Engine C18NZ	GCI44002	Inner Joint		34	25	35	56.2	85.6		
	1990.03-	1995.11	MT	R	F	Saloon Engine C18NZ	GDS44059	Drive Shaft	29T	33	34	52	109	938		
	1990.03-	1995.11	MT	L	F	Saloon Engine C18NZ	GDS44011	Drive Shaft	29T	33	34	52	109	594.5		
	1990.03-	1995.11	MT/AT		F	Saloon Engine C18NZ	GC044056	Outer Joint	29T	33	25	52	109	61	O	
	1990.03-	1995.11	MT/AT		F	Saloon Engine C18NZ	GC044057	Outer Joint	43T	33	25	52	109	61	O	
2.0 i (85 kW)	1988.09-	1990.10	MT	L	F	Saloon Engine 20NE	GDS44014	Drive Shaft	43T	33	34	52	103.5	587		
	1988.09-	1990.10	MT		F	Saloon Engine 20NE	GCI44002	Inner Joint		34	25	35	56.2	85.6		
	1988.09-	1990.10	MT	R	F	Saloon Engine 20NE	GDS44059	Drive Shaft	29T	33	34	52	109	938		
	1988.09-	1990.10	MT	L	F	Saloon Engine 20NE	GDS44011	Drive Shaft	29T	33	34	52	109	594.5		
	1988.09-	1990.10	MT/AT		F	Saloon Engine 20NE	GC044056	Outer Joint	29T	33	25	52	109	61	O	
	1988.09-	1990.10	MT/AT		F	Saloon Engine 20NE	GC044057	Outer Joint	43T	33	25	52	109	61	O	
2.0 i 16V (110 kW)	1988.09-	1995.11	MT	L	F	Saloon Engine C20XE	GDS44014	Drive Shaft	43T	33	34	52	103.5	587		
	1988.09-	1995.11	MT		F	Saloon Engine C20XE	GCI44002	Inner Joint		34	25	35	56.2	85.6		





		TRANSM	L/R	F/R		G-AP Ref.	PRODUCT	ABS	Technical Specifications					
									YEAR	A	B	C	H	L
<b>VAUXHALL</b>														
<b>CAVALIER III (87)</b>														
2.0 i 16V (110 kW)	1988.09-1995.11	MT		F	Saloon Engine C20XE	GCI44005	Inner Joint		34	25	35	54	47	
	1988.09-1995.11	MT	L	F	Saloon Engine C20XE	GDS44011	Drive Shaft	29T	33	34	52	109	594.5	
	1988.09-1995.11	MT		F	Saloon Engine C20XE	GC044056	Outer Joint	29T	33	25	52	109	61	O
	1988.09-1995.11	MT		F	Saloon Engine C20XE	GC044057	Outer Joint	43T	33	25	52	109	61	O
2.0 i 16V 4x4 (110 kW)	1988.09-1995.11	MT		F	Saloon Engine C20XE	GCI44002	Inner Joint		34	25	35	56.2	85.6	
	1988.09-1995.11	MT		F	Saloon Engine C20XE	GCI44005	Inner Joint		34	25	35	54	47	
	1988.09-1995.11	MT		F	Saloon Engine C20XE	GC044056	Outer Joint	29T	33	25	52	109	61	O
	1988.09-1995.11	MT			Saloon Engine C20XE	GC044057	Outer Joint	43T	33	25	52	109	61	O
2.0 i 4x4 (85 kW)	1991.01-1992.10	MT		F	Saloon Engine 20NE	GCI44002	Inner Joint		34	25	35	56.2	85.6	
	1991.01-1992.10	MT		F	Saloon Engine 20NE	GCI44005	Inner Joint		34	25	35	54	47	
	1991.01-1992.10	MT		F	Saloon Engine 20NE	GC044056	Outer Joint	29T	33	25	52	109	61	O
	1991.01-1992.10	MT			Saloon Engine 20NE	GC044057	Outer Joint	43T	33	25	52	109	61	O
2.0 i 4x4 (95 kW)	1988.09-1992.09	MT		F	Saloon Engine 20SEH	GCI44002	Inner Joint		34	25	35	56.2	85.6	
	1988.09-1992.09	MT		F	Saloon Engine 20SEH	GCI44005	Inner Joint		34	25	35	54	47	
	1988.09-1992.09	MT		F	Saloon Engine 20SEH	GC044056	Outer Joint	29T	33	25	52	109	61	O
	1988.09-1992.09	MT			Saloon Engine 20SEH	GC044057	Outer Joint	43T	33	25	52	109	61	O
2.0 i CAT (85 kW)	1990.09-1995.11	MT	L	F	Saloon Engine C20NE	GDS44014	Drive Shaft	43T	33	34	52	103.5	587	
	1990.09-1995.11	MT		F	Saloon Engine C20NE	GCI44002	Inner Joint		34	25	35	56.2	85.6	
	1990.09-1995.11	MT	R	F	Saloon Engine C20NE	GDS44059	Drive Shaft	29T	33	34	52	109	938	
	1990.09-1995.11	MT	L	F	Saloon Engine C20NE	GDS44011	Drive Shaft	29T	33	34	52	109	594.5	
	1990.09-1995.11	MT/AT		F	Saloon Engine C20NE	GC044056	Outer Joint	29T	33	25	52	109	61	O
2.0 SRi (95 kW)	1988.09-1992.09	MT/AT		F	Saloon Engine C20NE	GC044057	Outer Joint	43T	33	25	52	109	61	O
	1988.09-1992.09	MT	L	F	Saloon Engine 20SEH	GDS44014	Drive Shaft	43T	33	34	52	103.5	587	
	1988.09-1992.09	MT		F	Saloon Engine 20SEH	GCI44002	Inner Joint		34	25	35	56.2	85.6	
	1988.09-1992.09	MT	R	F	Saloon Engine 20SEH	GDS44059	Drive Shaft	29T	33	34	52	109	938	
	1988.09-1992.09	MT	L	F	Saloon Engine 20SEH	GDS44011	Drive Shaft	29T	33	34	52	109	594.5	
2.0 SRi 16V (100 kW)	1988.09-1992.09	MT/AT		F	Saloon Engine 20SEH	GC044056	Outer Joint	29T	33	25	52	109	61	O
	1988.09-1992.09	MT/AT		F	Saloon Engine 20SEH	GC044057	Outer Joint	43T	33	25	52	109	61	O
2.5 V6 (125 kW)	1993.09-1995.11	MT		F	Saloon Engine X20XEV	GCI44002	Inner Joint		34	25	35	56.2	85.6	
	1993.09-1995.11	MT		F	Saloon Engine X20XEV	GCI44005	Inner Joint		34	25	35	54	47	
2.5 V6 (125 kW)	1988.08-1994.06	MT		F	Saloon Engine C25XE	GCI44002	Inner Joint		34	25	35	56.2	85.6	
	1988.08-1994.06	MT		F	Saloon Engine C25XE	GCI44005	Inner Joint		34	25	35	54	47	
<b>COMBO I (B)</b>														
1.4 (44 kW)	1994.07-2001.10	MT	L	F	Box Engine C14NZ	GDS99139	Drive Shaft		22	22	52	98	570.5	
	1994.07-2001.10	MT	R	F	Box Engine C14NZ	GDS99138	Drive Shaft		22	22	52	98	916.5	
	1994.07-2001.10				Box Engine C14NZ	GC044019	Outer Joint	29T	22	28	52	97.5	57.5	O
1.7 D (44 kW)	1994.07-2001.10	MT	L	F	Box Engine 17D(4EE1)/X17D(4EE1)	GDS99139	Drive Shaft		22	22	52	98	570.5	
	1994.07-2001.10	MT	R	F	Box Engine 17D(4EE1)/X17D(4EE1)	GDS99138	Drive Shaft		22	22	52	98	916.5	
	1994.07-2001.10				Box Engine 17D(4EE1)/X17D(4EE1)	GC044019	Outer Joint	29T	22	28	52	97.5	57.5	O
<b>COMBO II (C) (F25)</b>														
1.3 CDTi 16V (51 kW)	2004.09-2012.02		R	F	Box Body / Estate Engine Z13DT	GDS44075	Drive Shaft	29T	22	22	52	97.5	926	
	2004.09-2012.02		R	F	Box Body / Estate Engine Z13DT	GDS99205	Drive Shaft		22	22	52	97.5	930	
	2004.09-2012.02		R	F	Box Body / Estate Engine Z13DT	GCI60001	Inner Joint		22	28	34.9	57.5	96.5	
	2004.09-2012.02		R	F	Box Body / Estate Engine Z13DT	GC044043	Outer Joint		22	28	52	97.5	57.5	O
1.3 CDTi 16V (55 kW)	2005.10-2011.11		R	F	Box Body / Estate Engine Z13DTJ	GDS44075	Drive Shaft	29T	22	22	52	97.5	926	
1.4 16V (66 kW)	2001.10-2007.05	MT/AT	R	F	Box Body / Estate Engine Z14XE	GDS99205	Drive Shaft		22	22	52	97.5	930	
	2001.10-2007.05	MT/AT	R	F	Box Body / Estate Engine Z14XE	GCI60001	Inner Joint		22	28	34.9	57.5	96.5	
	2001.10-2007.05	MT/AT	R	F	Box Body / Estate Engine Z14XE	GC044043	Outer Joint		22	28	52	97.5	57.5	O
1.4 i 16V (66 kW)	2004.01-2011.11		R	F	Box Body / Estate Engine Z14XEP	GDS44075	Drive Shaft	29T	22	22	52	97.5	926	
	2004.01-2011.11		R	F	Box Body / Estate Engine Z14XEP	GDS99205	Drive Shaft		22	22	52	97.5	930	
	2004.01-2011.11		R	F	Box Body / Estate Engine Z14XEP	GCI60001	Inner Joint		22	28	34.9	57.5	96.5	
	2004.01-2011.11		R	F	Box Body / Estate Engine Z14XEP	GC044043	Outer Joint		22	28	52	97.5	57.5	O
1.6 (62 kW)	2001.08-2004.10		R	F	Box Body / Estate Engine Z16SE	GDS44075	Drive Shaft	29T	22	22	52	97.5	926	
	2001.08-2004.10		R	F	Box Body / Estate Engine Z16SE	GDS99205	Drive Shaft		22	22	52	97.5	930	
	2001.08-2004.10		R	F	Box Body / Estate Engine Z16SE	GCI60001	Inner Joint		22	28	34.9	57.5	96.5	
	2001.08-2004.10		R	F	Box Body / Estate Engine Z16SE	GC044043	Outer Joint		22	28	52	97.5	57.5	O
1.6 (64 kW)	2001.10-2011.11		R	F	Box Body / Estate Engine Z16SE	GDS44075	Drive Shaft	29T	22	22	52	97.5	926	
	2001.10-2011.11		R	F	Box Body / Estate Engine Z16SE	GDS99205	Drive Shaft		22	22	52	97.5	930	
	2001.10-2011.11		R	F	Box Body / Estate Engine Z16SE	GCI60001	Inner Joint		22	28	34.9	57.5	96.5	
	2001.10-2011.11		R	F	Box Body / Estate Engine Z16SE	GC044043	Outer Joint		22	28	52	97.5	57.5	O
1.6 CNG 16V (69 kW)	2006.06-2012.02		R	F	Box Body / Estate Engine Z16YNG	GDS44075	Drive Shaft	29T	22	22	52	97.5	926	









		TRANSM	L/R	F/R		G-AP Ref.	PRODUCT	ABS	Technical Specifications								
									YEAR	A	B	C	H	L	P		
<b>VAUXHALL</b>																	
<b>COMBO II (C) (F25)</b>																	
1.6 CNG 16V (69 kW)	2006.06-	2012.02	MT/AT	R	F	Box Body / Estate Engine Z16YNG	GDS99205	Drive Shaft		22	22	52	97.5	930			
	2006.06-	2012.02	MT/AT	R	F	Box Body / Estate Engine Z16YNG	GCI60001	Inner Joint		22	28	34.9	57.5	96.5			
	2006.06-	2012.02	MT/AT	R	F	Box Body / Estate Engine Z16YNG	GC044043	Outer Joint		22	28	52	97.5	57.5	O		
1.6 CNG 16V (71 kW)	2005.04-	2012.02		R	F	Box Body / Estate Engine Z16YNG	GDS44075	Drive Shaft	29T	22	22	52	97.5	926			
	2005.04-	2012.02	MT/AT	R	F	Box Body / Estate Engine Z16YNG	GDS99205	Drive Shaft		22	22	52	97.5	930			
	2005.04-	2012.02	MT/AT	R	F	Box Body / Estate Engine Z16YNG	GCI60001	Inner Joint		22	28	34.9	57.5	96.5			
	2005.04-	2012.02	MT/AT	R	F	Box Body / Estate Engine Z16YNG	GC044043	Outer Joint		22	28	52	97.5	57.5	O		
1.7 CDTi 16V (74 kW)	2004.12-	2011.11		L	F	Box Body / Estate Engine Z17DTH	GDS44032	Drive Shaft	29T	33	34	52	104	587.5			
	2004.12-	2011.11		L	F	Box Body / Estate Engine Z17DTH	GCI21034	Inner Joint		34	24	35	56.5	102			
	2004.12-	2011.11		L/R	F	Box Body / Estate Engine Z17DTH	GC022005	Outer Joint		33	24	52	104	64	M		
	2004.12-	2011.11		R	F	Box Body / Estate Engine Z17DTH	GDS60021	Drive Shaft	29T	33	34	52	104	612			
	2004.12-	2011.11		R	F	Box Body / Estate Engine Z17DTH	GCI60003	Inner Joint		34	24	35.5	47	70.5			
1.7 Di 16V (48 kW)	2001.09-	2011.11	MT		F	Box Body / Estate Engine Y17DTL	GC044002	Outer Joint	29T	22	23	52	97.5	61	M		
	2001.09-	2011.11	MT		F	Box Body / Estate Engine Y17DTL	GC044044	Outer Joint		22	28	52	97.5	57.5	O		
	2001.09-	2011.11		L	F	Box Body / Estate Engine Y17DTL	GDS44027	Drive Shaft	29T	22	22	52	98	580			
	2001.09-	2011.11		L	F	Box Body / Estate Engine Y17DTL	GDS44045	Drive Shaft	29T	22	22	52	97	579			
	2001.09-	2011.11		R	F	Box Body / Estate Engine Y17DTL	GDS44075	Drive Shaft	29T	22	22	52	97.5	926			
	2001.09-	2011.11		R	F	Box Body / Estate Engine Y17DTL	GDS44026	Drive Shaft	29T	22	22	52	98	930			
	2001.09-	2011.11	MT/AT	R	F	Box Body / Estate Engine Y17DTL	GDS99205	Drive Shaft		22	22	52	97.5	930			
	2001.09-	2011.11	MT/AT	R	F	Box Body / Estate Engine Y17DTL	GCI60001	Inner Joint		22	28	34.9	57.5	96.5			
	2001.09-	2011.11	MT/AT	R	F	Box Body / Estate Engine Y17DTL	GC044043	Outer Joint		22	28	52	97.5	57.5	O		
1.7 DTi 16V (55 kW)	2001.10-	2011.11	MT		F	Box Body / Estate Engine Y17DT	GC044002	Outer Joint	29T	22	23	52	97.5	61	M		
	2001.10-	2011.11		R	F	Box Body / Estate Engine Y17DT	GDS44075	Drive Shaft	29T	22	22	52	97.5	926			
	2001.10-	2011.11	MT	R	F	Box Body / Estate Engine Y17DT	GDS99205	Drive Shaft		22	22	52	97.5	930			
	2001.10-	2011.11	MT	R	F	Box Body / Estate Engine Y17DT	GCI60001	Inner Joint		22	28	34.9	57.5	96.5			
	2001.10-	2011.11	MT	R	F	Box Body / Estate Engine Y17DT	GC044043	Outer Joint		22	28	52	97.5	57.5	O		
<b>COMBO TOUR II (C) (F25)</b>																	
1.4 (66 kW)	2004.10-	2010.09	MT/AT	R	F	MPV Engine Z14XEP	GDS99205	Drive Shaft		22	22	52	97.5	930			
	2004.10-	2010.09	MT/AT	R	F	MPV Engine Z14XEP	GCI60001	Inner Joint		22	28	34.9	57.5	96.5			
	2004.10-	2010.09	MT/AT	R	F	MPV Engine Z14XEP	GC044043	Outer Joint		22	28	52	97.5	57.5	O		
1.6 (64 kW)	2001.10-	2004.06	MT/AT	R	F	MPV Engine Z16SE	GDS99205	Drive Shaft		22	22	52	97.5	930			
	2001.10-	2004.06	MT/AT	R	F	MPV Engine Z16SE	GCI60001	Inner Joint		22	28	34.9	57.5	96.5			
	2001.10-	2004.06	MT/AT	R	F	MPV Engine Z16SE	GC044043	Outer Joint		22	28	52	97.5	57.5	O		
1.6 CNG (69 kW)	2006.06-	2010.09	MT/AT	R	F	MPV Engine Z16YNG	GDS99205	Drive Shaft		22	22	52	97.5	930			
	2006.06-	2010.09	MT/AT	R	F	MPV Engine Z16YNG	GCI60001	Inner Joint		22	28	34.9	57.5	96.5			
	2006.06-	2010.09	MT/AT	R	F	MPV Engine Z16YNG	GC044043	Outer Joint		22	28	52	97.5	57.5	O		
1.6 CNG 16V (71 kW)	2005.04-	2012.02	MT/AT	R	F	MPV Engine Z16YNG	GDS99205	Drive Shaft		22	22	52	97.5	930			
	2005.04-	2012.02	MT/AT	R	F	MPV Engine Z16YNG	GCI60001	Inner Joint		22	28	34.9	57.5	96.5			
	2005.04-	2012.02	MT/AT	R	F	MPV Engine Z16YNG	GC044043	Outer Joint		22	28	52	97.5	57.5	O		
1.7 CDTi 16V (74 kW)	2004.12-	2010.09		L	F	MPV Engine Z17DTH	GDS44032	Drive Shaft	29T	33	34	52	104	587.5			
	2004.12-	2010.09		R	F	MPV Engine Z17DTH	GDS44092	Drive Shaft	29T	33	34	52	104	609			
1.7 Di 16V (48 kW)	2001.09-	2004.06		R	F	MPV Engine Y17DTL	GDS99205	Drive Shaft		22	22	52	97.5	930			
	2001.09-	2004.06		R	F	MPV Engine Y17DTL	GCI60001	Inner Joint		22	28	34.9	57.5	96.5			
	2001.09-	2004.06		R	F	MPV Engine Y17DTL	GC044043	Outer Joint		22	28	52	97.5	57.5	O		
<b>CORSA B</b>																	
1.2/1.4	1993.04-	2000.09	MT	L	F		GDS60007	Drive Shaft		22	22	52	97	563			
1.5 D/1.5 TD	1993.04-	2000.09	MT	L	F		GDS60007	Drive Shaft		22	22	52	97	563			
1.6	1993.08-	2000.09	MT				GC044024	Outer Joint		22	22	52.2	97	50	O		
1.7 D	1996.02-	2000.09	MT	L	F		GDS60007	Drive Shaft		22	22	52	97	563			
<b>CORSA B (73, 78, 79, F35)</b>																	
1.5 D (37 kW)	1993.03-	2000.09	MT				GC044060	Outer Joint	29T	22	22	52	98	51	O		
1.6 GSi 16V (80 kW)	1993.03-	2000.09					GC044060	Outer Joint	29T	22	22	52	98	51	O		
1.6 i 16V (78 kW)	1994.09-	2000.09					GC044060	Outer Joint	29T	22	22	52	98	51	O		
<b>CORSA C</b>																	
1	2000.10-			L	F		GDS60009	Drive Shaft	29T	22	22	52	97.5	559			
	2000.10-						GC044053	Outer Joint	29T	22	28	52	97.5	54.5	O		
1.2	2000.10-			L	F		GDS60004	Drive Shaft	29T	22	22	52	97.5	575			
	2000.10-						GC044053	Outer Joint	29T	22	28	52	97.5	54.5	O		
1.7 Di	2000.10-	2003.10	MT	L	F		GDS60006	Drive Shaft	29T	22	22	52	97.5	587			
1.7 DTi	2000.10-	2003.10	MT	L	F		GDS60006	Drive Shaft	29T	22	22	52	97.5	587			



		YEAR	TRANSM	L/R	F/R		G-AP Ref.	PRODUCT	ABS	Technical Specifications						
										A	B	C	H	L	P	
<b>VAUXHALL</b>																
<b>CORSA C (F08, F68)</b>																
1.0 12V (43 kW)	2000.09-						GC060001	Outer Joint		22	28	52	97.5	54.5	O	
1.0 12V (44 kW)	2000.09-						GC060001	Outer Joint		22	28	52	97.5	54.5	O	
1.2 16V (55 kW)	2000.09-						GC060001	Outer Joint		22	28	52	97.5	54.5	O	
1.2 Twinport (59 kW)	2004.07-						GC060001	Outer Joint		22	28	52	97.5	54.5	O	
1.4 16V (66 kW)	2000.09-						GC060001	Outer Joint		22	28	52	97.5	54.5	O	
1.4 Twinport (66 kW)	2003.06-						GC060001	Outer Joint		22	28	52	97.5	54.5	O	
1.7 CDTi (74 kW)	2003.06-						GC044004	Outer Joint	29T	33	24	52	104	64	M	
1.8 16V (92 kW)	2000.09-						GC044002	Outer Joint	29T	22	23	52	97.5	61	M	
<b>CORSA I</b>																
1	1997.04-	2000.09	MT	L	F		GDS60007	Drive Shaft		22	22	52	97	563		
<b>CORSA I (B)</b>																
1.0 i 12V (40 kW)	1996.11-	2000.09	5MT	L	F	Hatchback Engine X10XE	GDS44036	Drive Shaft	29T	22	22	52	95	565		
	1996.11-	2000.09	5MT	R	F	Hatchback Engine X10XE	GDS44037	Drive Shaft	29T	22	22	52	97	921		
1.6 GSi 16V (80 kW)	1993.03-	2000.09	MT		F	Hatchback Engine C16XE	GCI44004	Inner Joint		22	22	34.95	57.5	72.5		
1.6 i 16V (78 kW)	1994.09-	2000.09	MT		F	Hatchback Engine X16XE	GCI44004	Inner Joint		22	22	34.95	57.5	72.5		
<b>CORSA II (C) (W5L, F08)</b>																
1.0 12V (43 kW)	2000.09-	2003.10	5MT		F	Hatchback Engine Z10XE	GC044013	Outer Joint	29T	22	28	52	98	52	O	
	2000.09-	2003.10	MT/AT	L	F	Hatchback Engine Z10XE	GDS44045	Drive Shaft	29T	22	22	52	97	579		
	2000.09-	2003.10		R	F	Hatchback Engine Z10XE	GDS99205	Drive Shaft		22	22	52	97.5	930		
	2000.09-	2003.10		R	F	Hatchback Engine Z10XE	GCI60001	Inner Joint		22	28	34.9	57.5	96.5		
	2000.09-	2003.10		R	F	Hatchback Engine Z10XE	GC044043	Outer Joint		22	28	52	97.5	57.5	O	
1.0 12V (44 kW)	2003.11-	2006.10			F	Hatchback Engine Z10XEP	GC044013	Outer Joint	29T	22	28	52	98	52	O	
	2003.11-	2006.10			F	Hatchback Engine Z10XEP	GC044014	Outer Joint	29T	22	28	52	98	60	I	
	2003.11-	2006.10	MT/AT	R	F	Hatchback Engine Z10XEP	GDS99205	Drive Shaft		22	22	52	97.5	930		
	2003.11-	2006.10	MT/AT	R	F	Hatchback Engine Z10XEP	GCI60001	Inner Joint		22	28	34.9	57.5	96.5		
	2003.11-	2006.10	MT/AT	R	F	Hatchback Engine Z10XEP	GC044043	Outer Joint		22	28	52	97.5	57.5	O	
1.2 16V (55 kW)	2000.09-	2006.10	5MT		F	Hatchback Engine Z12XE	GC044013	Outer Joint	29T	22	28	52	98	52	O	
	2000.09-	2006.10	MT/AT	L	F	Hatchback Engine Z12XE	GDS44095	Drive Shaft	29T	22	22	52	97	566		
	2000.09-	2006.10	MT/AT	L	F	Hatchback Engine Z12XE	GDS44045	Drive Shaft	29T	22	22	52	97	579		
	2000.09-	2006.10		L	F	Hatchback Engine Z12XE	GDS99069	Drive Shaft	29T	22	22	52	97.5	584		
	2000.09-	2006.10		L/R	F	Hatchback Engine Z12XE	GC044043	Outer Joint		22	28	52	97.5	57.5	O	
	2000.09-	2006.10	MT/AT	R	F	Hatchback Engine Z12XE	GDS44096	Drive Shaft	29T	22	22	52	97	917		
	2000.09-	2006.10		R	F	Hatchback Engine Z12XE	GDS99157	Drive Shaft	29T	22	22	52	97.5	930		
	2000.09-	2006.10		R	F	Hatchback Engine Z12XE	GDS99205	Drive Shaft		22	22	52	97.5	930		
	2000.09-	2006.10		R	F	Hatchback Engine Z12XE	GCI60001	Inner Joint		22	28	34.9	57.5	96.5		
1.2 16V Dualfuel (55 kW)	2001.08-	2006.10	5MT		F	Hatchback Engine Z12XE	GC044013	Outer Joint	29T	22	28	52	98	52	O	
	2001.08-	2006.10		L	F	Hatchback Engine Z12XE	GDS44095	Drive Shaft	29T	22	22	52	97	566		
	2001.08-	2006.10		R	F	Hatchback Engine Z12XE	GDS44075	Drive Shaft	29T	22	22	52	97.5	926		
	2001.08-	2006.10	MT/AT	R	F	Hatchback Engine Z12XE	GDS99205	Drive Shaft		22	22	52	97.5	930		
	2001.08-	2006.10	MT/AT	R	F	Hatchback Engine Z12XE	GCI60001	Inner Joint		22	28	34.9	57.5	96.5		
	2001.08-	2006.10	MT/AT	R	F	Hatchback Engine Z12XE	GC044043	Outer Joint		22	28	52	97.5	57.5	O	
	2001.08-	2006.10		R	F	Hatchback Engine Z12XE	GDS44096	Drive Shaft	29T	22	22	52	97	917		
1.2 Twinport (59 kW)	2004.07-	2006.10		L	F	Hatchback Engine Z12XEP	GDS44027	Drive Shaft	29T	22	22	52	98	580		
	2004.07-	2006.10		L	F	Hatchback Engine Z12XEP	GDS44026	Drive Shaft	29T	22	22	52	98	930		
	2004.07-	2006.10		L	F	Hatchback Engine Z12XEP	GDS44045	Drive Shaft	29T	22	22	52	97	579		
	2004.07-	2006.10		R	F	Hatchback Engine Z12XEP	GDS44075	Drive Shaft	29T	22	22	52	97.5	926		
	2004.07-	2006.10	MT/AT	R	F	Hatchback Engine Z12XEP	GDS99205	Drive Shaft		22	22	52	97.5	930		
	2004.07-	2006.10	MT/AT	R	F	Hatchback Engine Z12XEP	GCI60001	Inner Joint		22	28	34.9	57.5	96.5		
	2004.07-	2006.10	MT/AT	R	F	Hatchback Engine Z12XEP	GC044043	Outer Joint		22	28	52	97.5	57.5	O	
1.3 CDTi 16V (52 kW)	2000.08-	2006.09			F	Hatchback Engine Z13DT	GCI44009	Inner Joint		22	23	35	57.5	96		
	2000.08-	2006.09		R	F	Hatchback Engine Z13DT	GDS44075	Drive Shaft	29T	22	22	52	97.5	926		
	2000.08-	2006.09	MT	R	F	Hatchback Engine Z13DT	GDS99205	Drive Shaft		22	22	52	97.5	930		
	2000.08-	2006.09	MT	R	F	Hatchback Engine Z13DT	GCI60001	Inner Joint		22	28	34.9	57.5	96.5		
	2000.08-	2006.09	MT	R	F	Hatchback Engine Z13DT	GC044043	Outer Joint		22	28	52	97.5	57.5	O	
1.3 CDTi 16V (55 kW)	2005.09-	2006.09	MT	R	F	Hatchback Engine Z13DTJ	GDS99205	Drive Shaft		22	22	52	97.5	930		
	2005.09-	2006.09	MT	R	F	Hatchback Engine Z13DTJ	GCI60001	Inner Joint		22	28	34.9	57.5	96.5		
	2005.09-	2006.09	MT	R	F	Hatchback Engine Z13DTJ	GC044043	Outer Joint		22	28	52	97.5	57.5	O	
1.4 16V (66 kW)	2000.09-	2006.10			F	Hatchback Engine Z14XE	GC044013	Outer Joint	29T	22	28	52	98	52	O	
	2000.09-	2006.10			F	Hatchback Engine Z14XE	GC044044	Outer Joint		22	28	52	97.5	57.5	O	
	2000.09-	2006.10	MT		F	Hatchback Engine Z14XE	GC044020	Outer Joint	29T	22	28	52	97.5	57.5	O	
	2000.09-	2006.10		L	F	Hatchback Engine Z14XE	GDS44001	Drive Shaft	29T	22	22	52	95	573		

		TRANSM	L/R	F/R		G-AP Ref.	PRODUCT	ABS	Technical Specifications							
									YEAR	A	B	C	H	L	P	
<b>VAUXHALL</b>																
<b>CORSA II (C) (W5L, F08)</b>																
1.4 16V (66 kW)	2000.09-	2006.10			R	F	Hatchback Engine Z14XE	GDS60002	Drive Shaft	29T	22	22	52	95	926	
	2000.09-	2006.10			R	F	Hatchback Engine Z14XE	GDS99205	Drive Shaft		22	22	52	97.5	930	
	2000.09-	2006.10			R	F	Hatchback Engine Z14XE	GCI60001	Inner Joint		22	28	34.9	57.5	96.5	
	2000.09-	2006.10			R	F	Hatchback Engine Z14XE	GC044043	Outer Joint		22	28	52	97.5	57.5	O
1.4 Twinport (66 kW)	2003.06-	2006.10			R	F	Hatchback Engine Z14XEP	GDS44075	Drive Shaft	29T	22	22	52	97.5	926	
	2003.06-	2006.10	MT/AT		R	F	Hatchback Engine Z14XEP	GDS99205	Drive Shaft		22	22	52	97.5	930	
	2003.06-	2006.10	MT/AT		R	F	Hatchback Engine Z14XEP	GCI60001	Inner Joint		22	28	34.9	57.5	96.5	
	2003.06-	2006.10	MT/AT		R	F	Hatchback Engine Z14XEP	GC044043	Outer Joint		22	28	52	97.5	57.5	O
1.6 (62 kW)	2001.08-	2004.10	MT/AT		R	F	Hatchback Engine Z16SE	GDS99205	Drive Shaft		22	22	52	97.5	930	
	2001.08-	2004.10	MT/AT		R	F	Hatchback Engine Z16SE	GCI60001	Inner Joint		22	28	34.9	57.5	96.5	
	2001.08-	2004.10	MT/AT		R	F	Hatchback Engine Z16SE	GC044043	Outer Joint		22	28	52	97.5	57.5	O
1.7 CDTi 16V (74 kW)	2000.08-	2006.09				F	Hatchback Engine Z17DTH	GC044004	Outer Joint	29T	33	24	52	104	64	M
	2000.08-	2006.09			L	F	Hatchback Engine Z17DTH	GDS44032	Drive Shaft	29T	33	34	52	104	587.5	
	2000.08-	2006.09			L	F	Hatchback Engine Z17DTH	GCI21034	Inner Joint		34	24	35	56.5	102	
	2000.08-	2006.09		L/R	F	Hatchback Engine Z17DTH	GC022005	Outer Joint		33	24	52	104	64	M	
	2000.08-	2006.09			R	F	Hatchback Engine Z17DTH	GDS60021	Drive Shaft	29T	33	34	52	104	612	
	2000.08-	2006.09			R	F	Hatchback Engine Z17DTH	GCI60003	Inner Joint		34	24	35.5	47	70.5	
1.7 Di 16V (48 kW)	2000.08-	2006.09	MT			F	Hatchback Engine Y17DTL	GC044044	Outer Joint		22	28	52	97.5	57.5	O
	2000.08-	2006.09			R	F	Hatchback Engine Y17DTL	GDS44075	Drive Shaft	29T	22	22	52	97.5	926	
	2000.08-	2006.09			R	F	Hatchback Engine Y17DTL	GDS99205	Drive Shaft		22	22	52	97.5	930	
	2000.08-	2006.09			R	F	Hatchback Engine Y17DTL	GCI60001	Inner Joint		22	28	34.9	57.5	96.5	
	2000.08-	2006.09			R	F	Hatchback Engine Y17DTL	GC044043	Outer Joint		22	28	52	97.5	57.5	O
1.7 DTi 16V (55 kW)	2000.08-	2006.09	MT			F	Hatchback Engine Y17DT	GC044044	Outer Joint		22	28	52	97.5	57.5	O
	2000.08-	2006.09	MT			F	Hatchback Engine Y17DT	GCI44009	Inner Joint		22	23	35	57.5	96	
	2000.08-	2006.09			R	F	Hatchback Engine Y17DT	GDS44075	Drive Shaft	29T	22	22	52	97.5	926	
	2000.08-	2006.09	MT/AT		R	F	Hatchback Engine Y17DT	GDS99205	Drive Shaft		22	22	52	97.5	930	
	2000.08-	2006.09	MT/AT		R	F	Hatchback Engine Y17DT	GCI60001	Inner Joint		22	28	34.9	57.5	96.5	
	2000.08-	2006.09	MT/AT		R	F	Hatchback Engine Y17DT	GC044043	Outer Joint		22	28	52	97.5	57.5	O
1.8 16V (92 kW)	2000.08-	2006.09				F	Hatchback Engine Z18XE	GC044002	Outer Joint	29T	22	23	52	97.5	61	M
	2000.08-	2006.09				F	Hatchback Engine Z18XE	GCI44009	Inner Joint		22	23	35	57.5	96	
	2000.08-	2006.09			R	F	Hatchback Engine Z18XE	GDS44075	Drive Shaft	29T	22	22	52	97.5	926	
<b>CORSA III (D) (L_8)</b>																
1.0 (44 kW)	2006.11-					F	Hatchback Engine A10XEP/Z10XEP	GC017052	Outer Joint		22	21	51.2	79.5	54	M
	2006.11-		MT		L	F	Hatchback Engine A10XEP/Z10XEP	GDS44079	Drive Shaft		22	22	51	79.5	615	
	2006.11-		MT		R	F	Hatchback Engine A10XEP/Z10XEP	GDS44078	Drive Shaft		22	22	51	79.5	918	
	2006.11-		MT		L	F	Hatchback Engine A10XEP/Z10XEP	GDS60023	Drive Shaft		22	22	51.2	79.5	615	
	2006.11-		MT		R	F	Hatchback Engine A10XEP/Z10XEP	GDS17044	Drive Shaft		22	22	51.2	79.5	919	
	2006.11-		MT		R	F	Hatchback Engine A10XEP/Z10XEP	GCI44013	Inner Joint		22	21	35	57.5	93	
	2006.11-		MT		R	F	Hatchback Engine A10XEP/Z10XEP	GC017052	Outer Joint		22	21	51.2	79.5	54	M
	2006.11-						Hatchback Engine A10XEP/Z10XEP	GC099018	Outer Joint		22	27	51	79.5	54	O
1.0 i 12V (48 kW)	2010.06-		MT		L	F	Hatchback Engine A10XEP	GDS44079	Drive Shaft		22	22	51	79.5	615	
	2010.06-		MT		R	F	Hatchback Engine A10XEP	GDS44078	Drive Shaft		22	22	51	79.5	918	
	2010.06-		MT		L	F	Hatchback Engine A10XEP	GDS60023	Drive Shaft		22	22	51.2	79.5	615	
1.2 (51 kW)	2010.06-		MT		L	F	Hatchback Engine A12XEL	GDS60023	Drive Shaft		22	22	51.2	79.5	615	
1.2 (59 kW)	2006.11-					F	Hatchback Engine Z12XEP	GC017052	Outer Joint		22	21	51.2	79.5	54	M
	2006.11-		MT		L	F	Hatchback Engine Z12XEP	GDS44079	Drive Shaft		22	22	51	79.5	615	
	2006.11-		MT		R	F	Hatchback Engine Z12XEP	GDS44078	Drive Shaft		22	22	51	79.5	918	
	2006.11-		MT		L	F	Hatchback Engine Z12XEP	GDS60023	Drive Shaft		22	22	51.2	79.5	615	
	2006.11-		MT		R	F	Hatchback Engine Z12XEP	GDS17044	Drive Shaft		22	22	51.2	79.5	919	
	2006.11-		MT		R	F	Hatchback Engine Z12XEP	GCI44013	Inner Joint		22	21	35	57.5	93	
	2006.11-		MT		R	F	Hatchback Engine Z12XEP	GC017052	Outer Joint		22	21	51.2	79.5	54	M
	2006.11-						Hatchback Engine Z12XEP	GC099018	Outer Joint		22	27	51	79.5	54	O
1.2 i 16V (63 kW)	2006.11-		MT		L	F	Hatchback Engine A12XER	GDS44079	Drive Shaft		22	22	51	79.5	615	
	2006.11-		MT		R	F	Hatchback Engine A12XER	GDS44078	Drive Shaft		22	22	51	79.5	918	
	2006.11-		MT		L	F	Hatchback Engine A12XER	GDS60023	Drive Shaft		22	22	51.2	79.5	615	
1.2 LPG (59 kW)	2009.09-		MT/AT		L	F	Hatchback Engine Z12XEP	GDS60023	Drive Shaft		22	22	51.2	79.5	615	
1.2 LPG (61 kW)	2011.06-				L	F	Hatchback Engine A12XER	GDS60023	Drive Shaft		22	22	51.2	79.5	615	
1.2 LPG (63 kW)	2011.08-		MT		L	F	Hatchback Engine A12XER	GDS60023	Drive Shaft		22	22	51.2	79.5	615	
1.3 CDTi (55 kW)	2006.11-		MT		R	F	Hatchback Engine A13DTC/Z13DTJ	GCI44017	Inner Joint		22	23	35	57.5	116	
	2006.11-		MT		R	F	Hatchback Engine A13DTC/Z13DTJ	GC017053	Outer Joint		25	23	51	84.5	60	M
	2006.11-					F	Hatchback Engine A13DTC/Z13DTJ	GC017053	Outer Joint		25	23	51	84.5	60	M









		TRANSM	L/R	F/R		G-AP Ref.	PRODUCT	ABS	Technical Specifications									
									YEAR	A	B	C	H	L	P			
<b>VAUXHALL</b>																		
<b>CORSA III (D) (L_8)</b>																		
1.3 CDTi (55 kW)	2006.11-		MT	L	F	Hatchback Engine A13DTC/Z13DTJ	GDS44040	Drive Shaft		25	22	51	84.5	616				
	2006.11-		MT	R	F	Hatchback Engine A13DTC/Z13DTJ	GDS44042	Drive Shaft		25	22	51	84.5	920				
1.3 CDTi (66 kW)	2006.11-				F	Hatchback Engine Z13DTH	GC017053	Outer Joint		25	23	51	84.5	60	M			
	2006.11-		MT	L	F	Hatchback Engine Z13DTH	GDS17070	Drive Shaft		25	25	51	84.5	576				
	2006.11-		MT	R	F	Hatchback Engine Z13DTH	GDS17071	Drive Shaft		25	25	51	84.5	952				
	2006.11-		MT	L	F	Hatchback Engine Z13DTH	GCI44014	Inner Joint		25	23	34.9	57.5	102				
	2006.11-		MT	R	F	Hatchback Engine Z13DTH	GDS17070	Drive Shaft		25	25	51	84.5	952				
1.4 (64 kW)	2009.09-		MT	L	F	Hatchback Engine A14XEL	GDS44079	Drive Shaft		22	22	51	79.5	615				
	2009.09-		MT	R	F	Hatchback Engine A14XEL	GDS44078	Drive Shaft		22	22	51	79.5	918				
	2009.09-		MT	L	F	Hatchback Engine A14XEL	GDS60023	Drive Shaft		22	22	51.2	79.5	615				
1.4 (66 kW)	2006.07-				F	Hatchback Engine Z14XEP	GC017052	Outer Joint		22	21	51.2	79.5	54	M			
	2006.07-		MT	L	F	Hatchback Engine Z14XEP	GDS44079	Drive Shaft		22	22	51	79.5	615				
	2006.07-		MT	R	F	Hatchback Engine Z14XEP	GDS44078	Drive Shaft		22	22	51	79.5	918				
	2006.07-		MT	L	F	Hatchback Engine Z14XEP	GDS60023	Drive Shaft		22	22	51.2	79.5	615				
	2006.07-		MT	R	F	Hatchback Engine Z14XEP	GDS44078	Drive Shaft		22	22	51	79.5	918				
1.4 (74 kW)	2010.07-		MT	L	F	Hatchback Engine A14XER	GDS44079	Drive Shaft		22	22	51	79.5	615				
	2010.07-		MT	R	F	Hatchback Engine A14XER	GDS44078	Drive Shaft		22	22	51	79.5	918				
	2010.07-		MT	L	F	Hatchback Engine A14XER	GDS60023	Drive Shaft		22	22	51.2	79.5	615				
1.4 LPG (64 kW)	2009.09-				L	F	Hatchback Engine A14XEL	GDS44079	Drive Shaft		22	22	51	79.5	615			
	2009.09-				R	F	Hatchback Engine A14XEL	GDS44078	Drive Shaft		22	22	51	79.5	918			
	2009.09-		MT	L	F	Hatchback Engine A14XEL	GDS60023	Drive Shaft		22	22	51.2	79.5	615				
1.4 LPG (66 kW)	2006.07-		MT/AT	L	F	Hatchback Engine Z14XEP	GDS60023	Drive Shaft		22	22	51.2	79.5	615				
1.6 SRi (110 kW)	2007.05-		MT	L	F	Hatchback Engine A16LEL/Z16LEL	GDS60025	Drive Shaft		25	25	51	84.5	579.5				
	2007.05-		MT	R	F	Hatchback Engine A16LEL/Z16LEL	GDS60024	Drive Shaft		25	34	51	84.5	608				
	2007.05-					Hatchback Engine A16LEL/Z16LEL	GC060006	Outer Joint		25	35	51	84.5	63	I			
1.6 VXR (141 kW)	2007.02-		MT	L	F	Hatchback Engine A16LER/Z16LER	GDS60025	Drive Shaft		25	25	51	84.5	579.5				
	2007.02-		MT	R	F	Hatchback Engine A16LER/Z16LER	GDS60024	Drive Shaft		25	34	51	84.5	608				
	2007.02-					Hatchback Engine A16LER/Z16LER	GC060006	Outer Joint		25	35	51	84.5	63	I			
1.6 VXR (150 kW)	2011.06-2012.03		MT	L	F	Hatchback Engine A16LES	GDS60025	Drive Shaft		25	25	51	84.5	579.5				
	2011.06-2012.03		MT	R	F	Hatchback Engine A16LES	GDS60024	Drive Shaft		25	34	51	84.5	608				
	2011.06-2012.03					Hatchback Engine A16LES	GC060006	Outer Joint		25	35	51	84.5	63	I			
1.7 CDTi (92 kW)	2006.11-					Hatchback Engine A17DTR/Z17DTR	GC060006	Outer Joint		25	35	51	84.5	63	I			
1.7 CDTi (96 kW)	2006.11-					Hatchback Engine A17DTS	GC060006	Outer Joint		25	35	51	84.5	63	I			
<b>CORSA VAN II</b>																		
1.2	2001.03-		MT				GCI60001	Inner Joint		22	28	34.9	57.5	96.5				
<b>CORSAVAN II (C)</b>																		
1.2 16V (55 kW)	2000.09-2006.06		5MT		F	Box Engine Z12XE	GC044013	Outer Joint	29T	22	28	52	98	52	O			
	2000.09-2006.06		MT/AT	L	F	Box Engine Z12XE	GDS44095	Drive Shaft	29T	22	22	52	97	566				
	2000.09-2006.06		MT/AT	L	F	Box Engine Z12XE	GDS44045	Drive Shaft	29T	22	22	52	97	579				
	2000.09-2006.06			L	F	Box Engine Z12XE	GDS99069	Drive Shaft	29T	22	22	52	97.5	584				
	2000.09-2006.06			L/R	F	Box Engine Z12XE	GC044043	Outer Joint		22	28	52	97.5	57.5	O			
	2000.09-2006.06		MT/AT	R	F	Box Engine Z12XE	GDS44096	Drive Shaft	29T	22	22	52	97	917				
	2000.09-2006.06		MT/AT	R	F	Box Engine Z12XE	GDS99205	Drive Shaft		22	22	52	97.5	930				
	2000.09-2006.06		MT/AT	R	F	Box Engine Z12XE	GCI60001	Inner Joint		22	28	34.9	57.5	96.5				
	2000.09-2006.06		MT/AT	R	F	Box Engine Z12XE	GC044043	Outer Joint		22	28	52	97.5	57.5	O			
	2000.09-2006.06		MT/AT	R	F	Box Engine Z12XE	GDS44075	Drive Shaft	29T	22	22	52	97.5	926				
	2000.09-2006.06			R	F	Box Engine Z12XE	GDS99157	Drive Shaft	29T	22	22	52	97.5	930				
	2000.09-2006.06		5MT	F	F	Box Engine Z12XE	GC044013	Outer Joint	29T	22	28	52	98	52	O			
	1.2 16V Dualfuel (55 kW)	2001.08-2006.06			L	F	Box Engine Z12XE	GDS44095	Drive Shaft	29T	22	22	52	97	566			
2001.08-2006.06				R	F	Box Engine Z12XE	GDS44075	Drive Shaft	29T	22	22	52	97.5	926				
2001.08-2006.06				R	F	Box Engine Z12XE	GDS44096	Drive Shaft	29T	22	22	52	97	917				
2001.08-2006.06				R	F	Box Engine Z12XE	GDS99205	Drive Shaft		22	22	52	97.5	930				
2001.08-2006.06				R	F	Box Engine Z12XE	GCI60001	Inner Joint		22	28	34.9	57.5	96.5				
2001.08-2006.06				R	F	Box Engine Z12XE	GC044043	Outer Joint		22	28	52	97.5	57.5	O			
2001.08-2006.06				R	F	Box Engine Z12XE	GDS44075	Drive Shaft	29T	22	22	52	97.5	926				
1.3 CDTi 16V (52 kW)	2004.04-2006.06				F	Box Engine Z13DT	GCI44009	Inner Joint		22	23	35	57.5	96				
	2004.04-2006.06				R	F	Box Engine Z13DT	GDS44075	Drive Shaft	29T	22	22	52	97.5	926			
	2004.04-2006.06		MT	R	F	Box Engine Z13DT	GDS99205	Drive Shaft		22	22	52	97.5	930				
	2004.04-2006.06		MT	R	F	Box Engine Z13DT	GCI60001	Inner Joint		22	28	34.9	57.5	96.5				
	2004.04-2006.06		MT	R	F	Box Engine Z13DT	GC044043	Outer Joint		22	28	52	97.5	57.5	O			
1.4 (66 kW)	2003.11-2006.06				R	F	Box Engine Z14XEP	GDS44075	Drive Shaft	29T	22	22	52	97.5	926			
	2003.11-2006.06				R	F	Box Engine Z14XEP	GDS99205	Drive Shaft		22	22	52	97.5	930			
	2003.11-2006.06				R	F	Box Engine Z14XEP	GCI60001	Inner Joint		22	28	34.9	57.5	96.5			
	2003.11-2006.06				R	F	Box Engine Z14XEP	GC044043	Outer Joint		22	28	52	97.5	57.5	O		
	2003.11-2006.06				R	F	Box Engine Z14XEP	GDS44075	Drive Shaft	29T	22	22	52	97.5	926			

		TRANSM	L/R	F/R		G-AP Ref.	PRODUCT	ABS	Technical Specifications						
									YEAR	A	B	C	H	L	P
<b>VAUXHALL</b>															
<b>CORSAVAN II (C)</b>															
1.7 Di 16V (48 kW)	2000.09-2006.06				F	Box Engine Y17DTL	GC044044	Outer Joint		22	28	52	97.5	57.5	O
	2000.09-2006.06			R	F	Box Engine Y17DTL	GDS44075	Drive Shaft	29T	22	22	52	97.5	926	
	2000.09-2006.06		MT	R	F	Box Engine Y17DTL	GDS99205	Drive Shaft		22	22	52	97.5	930	
	2000.09-2006.06		MT	R	F	Box Engine Y17DTL	GCI60001	Inner Joint		22	28	34.9	57.5	96.5	
	2000.09-2006.06		MT	R	F	Box Engine Y17DTL	GC044043	Outer Joint		22	28	52	97.5	57.5	O
1.7 DTi 16V (55 kW)	2000.09-2006.06				F	Box Engine Y17DT	GC044044	Outer Joint		22	28	52	97.5	57.5	O
	2000.09-2006.06				F	Box Engine Y17DT	GCI44009	Inner Joint		22	23	35	57.5	96	
	2000.09-2006.06			R	F	Box Engine Y17DT	GDS44075	Drive Shaft	29T	22	22	52	97.5	926	
	2000.09-2006.06		MT	R	F	Box Engine Y17DT	GDS99205	Drive Shaft		22	22	52	97.5	930	
	2000.09-2006.06		MT	R	F	Box Engine Y17DT	GCI60001	Inner Joint		22	28	34.9	57.5	96.5	
	2000.09-2006.06		MT	R	F	Box Engine Y17DT	GC044043	Outer Joint		22	28	52	97.5	57.5	O
<b>CORSAVAN III (D)</b>															
1.2 (51 kW)	2010.01-			L	F	Box Engine A12XEL	GDS44079	Drive Shaft		22	22	51	79.5	615	
	2010.01-				R	Box Engine A12XEL	GDS44078	Drive Shaft		22	22	51	79.5	918	
	2010.01-		MT/AT	L	F	Box Engine A12XEL	GDS60023	Drive Shaft		22	22	51.2	79.5	615	
1.2 (59 kW)	2009.07-			L	F	Box Engine Z12XEP	GDS44079	Drive Shaft		22	22	51	79.5	615	
	2009.07-			R	F	Box Engine Z12XEP	GDS44078	Drive Shaft		22	22	51	79.5	918	
	2009.07-		MT/AT	L	F	Box Engine Z12XEP	GDS60023	Drive Shaft		22	22	51.2	79.5	615	
	2009.07-		MT	R	F	Box Engine Z12XEP	GDS17044	Drive Shaft		22	22	51.2	79.5	919	
	2009.07-		MT	R	F	Box Engine Z12XEP	GCI44013	Inner Joint		22	21	35	57.5	93	
	2009.07-		MT	R	F	Box Engine Z12XEP	GC017052	Outer Joint		22	21	51.2	79.5	54	M
1.3 CDTi (55 kW)	2006.07-			L	F	Box Engine Z13DTJ	GDS44040	Drive Shaft		25	22	51	84.5	616	
	2006.07-				R	Box Engine Z13DTJ	GDS44042	Drive Shaft		25	22	51	84.5	920	
	2006.07-				R	Box Engine Z13DTJ	GCI44017	Inner Joint		22	23	35	57.5	116	
	2006.07-				R	Box Engine Z13DTJ	GC017053	Outer Joint		25	23	51	84.5	60	M
1.3 CDTi (66 kW)	2006.07-			L	F	Box Engine Z13DTH	GDS17070	Drive Shaft		25	25	51	84.5	576	
	2006.07-				R	Box Engine Z13DTH	GDS17071	Drive Shaft		25	25	51	84.5	952	
	2006.07-			L	F	Box Engine Z13DTH	GCI44014	Inner Joint		25	23	34.9	57.5	102	
<b>INSIGNIA</b>															
1.4 (103 kW)	2011.04-					Hatchback Engine A14NET	GC099023	Outer Joint		30	26	53.8	94.5	65.5	M
	2011.04-					Saloon Engine A14NET	GC099023	Outer Joint		30	26	53.8	94.5	65.5	M
1.4 LPG (103 kW)	2012.07-					Hatchback Engine A14NET	GC099023	Outer Joint		30	26	53.8	94.5	65.5	M
	2012.07-					Saloon Engine A14NET	GC099023	Outer Joint		30	26	53.8	94.5	65.5	M
1.6 Turbo (125 kW)	2013.07-		MT	L/R	F	Hatchback Engine A16XHT	GDS60027	Drive Shaft		30	27	52.5	94.5	619	
1.6 Turbo (132 kW)	2009.01-		MT		R	Hatchback Engine A16LET	GC099023	Outer Joint		30	26	53.8	94.5	65.5	M
	2009.01-		MT		R	Saloon Engine A16LET	GC099023	Outer Joint		30	26	53.8	94.5	65.5	M
1.8 (103 kW)	2008.07-2013.09		MT	L	F	Hatchback Engine A18XER	GDS21050	Drive Shaft		30	25	52	94	622	
	2008.07-2013.09		MT	L	F	Saloon Engine A18XER	GDS21050	Drive Shaft		30	25	52	94	622	
	2008.07-2013.09		MT	R	F	Hatchback Engine A18XER	GDS21054	Drive Shaft		30	25	52	94	1008	
	2008.07-2013.09		MT	R	F	Saloon Engine A18XER	GDS21054	Drive Shaft		30	25	52	94	1008	
2.0 Biturbo CDTi (143 kW)	2012.03-				F	Hatchback Engine A20DTR	GC099367	Outer Joint		30	27	58.9	94	64.5	M
	2012.03-				F	Saloon Engine A20DTR	GC099367	Outer Joint		30	27	58.9	94	64.5	M
2.0 Biturbo CDTi 4x4 (143 kW)	2012.03-		MT	L/R	F	Hatchback Engine A20DTR	GDS60027	Drive Shaft		30	27	52.5	94.5	619	
	2012.03-		MT	L/R	F	Saloon Engine A20DTR	GDS60027	Drive Shaft		30	27	52.5	94.5	619	
2.0 CDTi (103 kW)	2013.07-		MT	L/R	F	Hatchback Engine A20DTE	GDS60027	Drive Shaft		30	27	52.5	94.5	619	
	2013.07-					Hatchback Engine A20DTE	GC099023	Outer Joint		30	26	53.8	94.5	65.5	M
	2013.07-					Saloon Engine A20DTE	GC099023	Outer Joint		30	26	53.8	94.5	65.5	M
2.0 CDTi (118 kW)	2008.07-		MT	L/R	F	Hatchback Engine A20DTH	GDS60027	Drive Shaft		30	27	52.5	94.5	619	
	2008.07-		MT	L/R	F	Saloon Engine A20DTH	GDS60027	Drive Shaft		30	27	52.5	94.5	619	
	2008.07-					Hatchback Engine A20DTH	GC099023	Outer Joint		30	26	53.8	94.5	65.5	M
	2008.07-					Saloon Engine A20DTH	GC099023	Outer Joint		30	26	53.8	94.5	65.5	M
2.0 CDTi (120 kW)	2013.07-		MT	L/R	F	Hatchback Engine A20DTH	GDS60027	Drive Shaft		30	27	52.5	94.5	619	
	2013.07-		MT	L/R	F	Saloon Engine A20DTH	GDS60027	Drive Shaft		30	27	52.5	94.5	619	
	2013.07-					Hatchback Engine A20DTH	GC099023	Outer Joint		30	26	53.8	94.5	65.5	M
2.0 CDTi (140 kW)	2008.10-				F	Hatchback Engine A20DTR	GC099367	Outer Joint		30	27	58.9	94	64.5	M
	2008.11-				F	Saloon Engine A20DTR	GC099367	Outer Joint		30	27	58.9	94	64.5	M
2.0 CDTi (81 kW)	2008.07-			L	F	Hatchback Engine A20DTC	GDS60026	Drive Shaft		30	25	52.5	94.5	631	
	2008.07-			L	F	Saloon Engine A20DTC	GDS60026	Drive Shaft		30	25	52.5	94.5	631	
	2008.07-			R	F	Hatchback Engine A20DTC	GDS60027	Drive Shaft		30	27	52.5	94.5	619	
	2008.07-			R	F	Saloon Engine A20DTC	GDS60027	Drive Shaft		30	27	52.5	94.5	619	
	2008.07-					Hatchback Engine A20DTC	GC099023	Outer Joint		30	26	53.8	94.5	65.5	M



		TRANSM	L/R	F/R		G-AP Ref.	PRODUCT	ABS	Technical Specifications								
									YEAR	A	B	C	H	L	P		
<b>VAUXHALL INSIGNIA</b>																	
2.0 CDTi (81 kW)	2008.07-				Saloon Engine A20DTC	GC099023	Outer Joint		30	26	53.8	94.5	65.5	M			
2.0 CDTi (88 kW)	2012.03-		MT	L/R	F Hatchback Engine A20DTE	GDS60027	Drive Shaft		30	27	52.5	94.5	619				
	2012.03-				Hatchback Engine A20DTE	GC099023	Outer Joint		30	26	53.8	94.5	65.5	M			
	2012.03-				Saloon Engine A20DTE	GC099023	Outer Joint		30	26	53.8	94.5	65.5	M			
2.0 CDTi (96 kW)	2008.07-		MT	L	F Hatchback Engine A20DTH	GDS60026	Drive Shaft		30	25	52.5	94.5	631				
	2008.07-		MT	L	F Saloon Engine A20DTJ	GDS60026	Drive Shaft		30	25	52.5	94.5	631				
	2008.07-		MT	R	F Hatchback Engine A20DTH	GDS60027	Drive Shaft		30	27	52.5	94.5	619				
	2008.07-		MT	R	F Saloon Engine A20DTJ	GDS60027	Drive Shaft		30	27	52.5	94.5	619				
	2008.07-				Hatchback Engine A20DTH	GC099023	Outer Joint		30	26	53.8	94.5	65.5	M			
	2008.07-				Saloon Engine A20DTJ	GC099023	Outer Joint		30	26	53.8	94.5	65.5	M			
2.0 CDTi 4x4 (118 kW)	2008.07-		MT	L/R	F Hatchback Engine A20DTH	GDS60027	Drive Shaft		30	27	52.5	94.5	619				
	2008.07-		MT	L/R	F Saloon Engine A20DTH	GDS60027	Drive Shaft		30	27	52.5	94.5	619				
	2008.07-		AT		F Hatchback Engine A20DTH	GC099023	Outer Joint		30	26	53.8	94.5	65.5	M			
	2008.07-		AT		F Saloon Engine A20DTH	GC099023	Outer Joint		30	26	53.8	94.5	65.5	M			
2.0 CDTi 4x4 (140 kW)	2009.05-		MT	L/R	F Hatchback Engine A20DTR	GDS60027	Drive Shaft		30	27	52.5	94.5	619				
	2009.05-		MT	L/R	F Saloon Engine A20DTR	GDS60027	Drive Shaft		30	27	52.5	94.5	619				
2.0 Turbo (162 kW)	2008.07-		MT	L/R	F Hatchback Engine A18XER	GDS60027	Drive Shaft		30	27	52.5	94.5	619				
	2008.07-		MT	L/R	F Saloon Engine A20NHT	GDS60027	Drive Shaft		30	27	52.5	94.5	619				
	2008.07-				F Saloon Engine A20NHT	GC099023	Outer Joint		30	26	53.8	94.5	65.5	M			
	2008.07-				Hatchback Engine A18XER	GC099023	Outer Joint		30	26	53.8	94.5	65.5	M			
2.0 Turbo (184 kW)	2014.04-		MT	L/R	F Estate Engine A20NFT	GDS60027	Drive Shaft		30	27	52.5	94.5	619				
2.0 Turbo 4x4 (162 kW)	2008.07-		MT	L/R	F Hatchback Engine A20NHT	GDS60027	Drive Shaft		30	27	52.5	94.5	619				
	2008.07-				F Saloon Engine A20NHT	GC099023	Outer Joint		30	26	53.8	94.5	65.5	M			
	2008.07-				Hatchback Engine A20NHT	GC099023	Outer Joint		30	26	53.8	94.5	65.5	M			
2.0 Turbo 4x4 (184 kW)	2011.09-		MT	L/R	F Hatchback Engine A20NFT	GDS60027	Drive Shaft		30	27	52.5	94.5	619				
	2011.09-		MT	L/R	F Saloon Engine A20NFT	GDS60027	Drive Shaft		30	27	52.5	94.5	619				
2.8 V6 Turbo 4x4 (191 kW)	2008.07-				F Hatchback Engine A28NET	GC099367	Outer Joint		30	27	58.9	94	64.5	M			
	2008.07-				F Saloon Engine A28NET	GC099367	Outer Joint		30	27	58.9	94	64.5	M			
2.8 VXR (239 kW)	2009.07-				F Hatchback Engine A28NER	GC099367	Outer Joint		30	27	58.9	94	64.5	M			
	2009.07-				F Saloon Engine A28NER	GC099367	Outer Joint		30	27	58.9	94	64.5	M			
<b>INSIGNIA SPORTS TOURER</b>																	
1.4 (103 kW)	2011.04-				Estate Engine A14NET	GC099023	Outer Joint		30	26	53.8	94.5	65.5	M			
1.4 LPG (103 kW)	2012.07-				Estate Engine A14NET	GC099023	Outer Joint		30	26	53.8	94.5	65.5	M			
1.6 Turbo (125 kW)	2013.07-		MT	R	F Estate Engine A16XHT	GDS60027	Drive Shaft		30	27	52.5	94.5	619				
1.6 Turbo (132 kW)	2009.01-		MT		R Estate Engine A16LET	GC099023	Outer Joint		30	26	53.8	94.5	65.5	M			
1.8 (103 kW)	2008.07-	2013.09	MT	L	F Estate Engine A18XER	GDS21050	Drive Shaft		30	25	52	94	622				
	2008.07-	2013.09	MT	R	F Estate Engine A18XER	GDS21054	Drive Shaft		30	25	52	94	1008				
2.0 Biturbo CDTi (143 kW)	2012.03-				F Estate Engine A20DTR	GC099367	Outer Joint		30	27	58.9	94	64.5	M			
2.0 Biturbo CDTi 4x4 (143 kW)	2012.03-		MT	L/R	F Estate Engine A20DTR	GDS60027	Drive Shaft		30	27	52.5	94.5	619				
2.0 CDTi (103 kW)	2013.07-		MT	L/R	F Estate Engine A20DTE	GDS60027	Drive Shaft		30	27	52.5	94.5	619				
	2013.07-				Estate Engine A20DTE	GC099023	Outer Joint		30	26	53.8	94.5	65.5	M			
2.0 CDTi (118 kW)	2008.07-		MT	L/R	F Estate Engine A20DTH	GDS60027	Drive Shaft		30	27	52.5	94.5	619				
	2008.07-				Estate Engine A20DTH	GC099023	Outer Joint		30	26	53.8	94.5	65.5	M			
2.0 CDTi (120 kW)	2013.07-		MT	L/R	F Estate Engine A20DTH	GDS60027	Drive Shaft		30	27	52.5	94.5	619				
	2013.07-				Estate Engine A20DTH	GC099023	Outer Joint		30	26	53.8	94.5	65.5	M			
2.0 CDTi (140 kW)	2008.11-				F Estate Engine A20DTR	GC099367	Outer Joint		30	27	58.9	94	64.5	M			
2.0 CDTi (81 kW)	2008.07-			L	F Estate Engine A20DTC	GDS60026	Drive Shaft		30	25	52.5	94.5	631				
	2008.07-			R	F Estate Engine A20DTC	GDS60027	Drive Shaft		30	27	52.5	94.5	619				
	2008.07-				Estate Engine A20DTC	GC099023	Outer Joint		30	26	53.8	94.5	65.5	M			
2.0 CDTi (88 kW)	2012.03-		MT	L/R	F Estate Engine A20DTE	GDS60027	Drive Shaft		30	27	52.5	94.5	619				
	2012.03-				Estate Engine A20DTE	GC099023	Outer Joint		30	26	53.8	94.5	65.5	M			
2.0 CDTi (96 kW)	2008.07-		MT	L	F Estate Engine A20DTJ	GDS60026	Drive Shaft		30	25	52.5	94.5	631				
	2008.07-		MT	R	F Estate Engine A20DTJ	GDS60027	Drive Shaft		30	27	52.5	94.5	619				
	2008.07-				Estate Engine A20DTJ	GC099023	Outer Joint		30	26	53.8	94.5	65.5	M			
2.0 CDTi 4x4 (118 kW)	2008.07-		MT	L/R	F Estate Engine A20DTH	GDS60027	Drive Shaft		30	27	52.5	94.5	619				
	2008.07-		AT		F Estate Engine A20DTH	GC099023	Outer Joint		30	26	53.8	94.5	65.5	M			
2.0 CDTi 4x4 (120 kW)	2013.07-		MT	L/R	F Estate Engine A20DTH	GDS60027	Drive Shaft		30	27	52.5	94.5	619				
2.0 CDTi 4x4 (140 kW)	2009.05-		MT	L/R	F Estate Engine A20DTR	GDS60027	Drive Shaft		30	27	52.5	94.5	619				
2.0 Turbo (162 kW)	2008.07-				F Estate Engine A20NHT	GC099023	Outer Joint		30	26	53.8	94.5	65.5	M			
2.0 Turbo 4x4 (162 kW)	2008.07-		MT	L/R	F Estate Engine A20NHT	GDS60027	Drive Shaft		30	27	52.5	94.5	619				
	2008.07-				F Estate Engine A20NHT	GC099023	Outer Joint		30	26	53.8	94.5	65.5	M			





		YEAR	TRANSM	L/R	F/R		G-AP Ref.	PRODUCT	ABS	Technical Specifications						
										A	B	C	H	L	P	
<b>VAUXHALL</b>																
<b>INSIGNIA SPORTS TOURER</b>																
2.0 Turbo 4x4 (184 kW)	2011.09-		MT	L/R	F	Estate Engine A20NFT	GDS60027	Drive Shaft		30	27	52.5	94.5	619		
2.8 VXR (239 kW)	2009.07-				F	Estate Engine A28NER	GC099367	Outer Joint		30	27	58.9	94	64.5	M	
<b>KADETT E / ASTRA E, BELMONT</b>																
1.6 D (40 kW)	1984.09-	1989.01	MT				GC044057	Outer Joint	43T	33	25	52	109	61	O	
1.7 D (42 kW)	1989-	1991					GC044057	Outer Joint	43T	33	25	52	109	61	O	
1.8 (85 kW)	1984-	1986				Ch-F000001	GC044057	Outer Joint	43T	33	25	52	109	61	O	
2.0 GSi 16V Kat (110 kW)	1988-	1991				Ch-F000001	GC044057	Outer Joint	43T	33	25	52	109	61	O	
2.0 i Kat (85 kW)	1987-	1991				Ch-F000001	GC044057	Outer Joint	43T	33	25	52	109	61	O	
<b>KADETT E SW</b>																
1.6 D (40 kW)	1984.09-	1989.01	MT				GC044057	Outer Joint	43T	33	25	52	109	61	O	
1.7 D (42 kW)	1989.01-	1991					GC044057	Outer Joint	43T	33	25	52	109	61	O	
1.8 (85 kW)	1984-	1986				Ch-F000001	GC044057	Outer Joint	43T	33	25	52	109	61	O	
2.0 i Kat (85 kW)	1987-	1991				Ch-F000001	GC044057	Outer Joint	43T	33	25	52	109	61	O	
<b>MERIVA A</b>																
1.3 CDTi 16V (55 kW)	2003.09-						GC044002	Outer Joint	29T	22	23	52	97.5	61	M	
1.6 (64 kW)	2003.05-						GCI21014	Inner Joint		22	22	35	57.5	75		
	2003.05-						GC044005	Outer Joint	29T	22	22	52	97.5	58.5	M	
1.6 16V (74 kW)	2006.01-					Ch-44162552 Design: GKN	GC044005	Outer Joint	29T	22	22	52	97.5	58.5	M	
	2006.01-						GCI21014	Inner Joint		22	22	35	57.5	75		
1.6 16V (77 kW)	2006.01-					Ch-44162552 Design: GKN	GC044005	Outer Joint	29T	22	22	52	97.5	58.5	M	
	2006.01-						GCI21014	Inner Joint		22	22	35	57.5	75		
1.6 T (132 kW)	2007-						GC044004	Outer Joint	29T	33	24	52	104	64	M	
1.7 DTi 16V (55 kW)	2003.09-						GC044002	Outer Joint	29T	22	23	52	97.5	61	M	
1.8 16V (92 kW)	2003.05-						GC044002	Outer Joint	29T	22	23	52	97.5	61	M	
<b>MERIVA I (A)</b>																
1.3 CDTi (55 kW)	2003.01-	2009.10			F	MPV Engine Z13DTJ	GC044002	Outer Joint	29T	22	23	52	97.5	61	M	
	2003.01-	2009.10			F	MPV Engine Z13DTJ	GCI44009	Inner Joint		22	23	35	57.5	96		
1.4 16V Twinport (66 kW)	2003.01-	2009.10			F	MPV Engine Z14XEP	GC044020	Outer Joint	29T	22	28	52	97.5	57.5	O	
	2003.01-	2009.10		L	F	MPV Engine Z14XEP	GDS99069	Drive Shaft	29T	22	22	52	97.5	584		
	2003.01-	2009.10		L/R	F	MPV Engine Z14XEP	GC044043	Outer Joint		22	28	52	97.5	57.5	O	
	2003.01-	2009.10		R	F	MPV Engine Z14XEP	GDS99157	Drive Shaft	29T	22	22	52	97.5	930		
	2003.01-	2009.10		R	F	MPV Engine Z14XEP	GDS99205	Drive Shaft		22	22	52	97.5	930		
	2003.01-	2009.10		R	F	MPV Engine Z14XEP	GCI60001	Inner Joint		22	28	34.9	57.5	96.5		
1.6 i (64 kW)	2003.01-	2010.06			F	MPV Engine Z16SE	GC044005	Outer Joint	29T	22	22	52	97.5	58.5	M	
	2003.01-	2010.06		L	F	MPV Engine Z16SE	GDS99069	Drive Shaft	29T	22	22	52	97.5	584		
	2003.01-	2010.06		L/R	F	MPV Engine Z16SE	GC044043	Outer Joint		22	28	52	97.5	57.5	O	
	2003.01-	2010.06		R	F	MPV Engine Z16SE	GDS99157	Drive Shaft	29T	22	22	52	97.5	930		
1.6 i 16V (74 kW)	2003.01-	2005.09			F	MPV Engine Z16XE	GC044005	Outer Joint	29T	22	22	52	97.5	58.5	M	
	2003.01-	2005.09		L	F	MPV Engine Z16XE	GDS99069	Drive Shaft	29T	22	22	52	97.5	584		
	2003.01-	2005.09		L/R	F	MPV Engine Z16XE	GC044043	Outer Joint		22	28	52	97.5	57.5	O	
	2003.01-	2005.09		R	F	MPV Engine Z16XE	GDS99157	Drive Shaft	29T	22	22	52	97.5	930		
1.6 i 16V Twinport (77 kW)	2003.05-	2010.06			L	MPV Engine Z16XEP	GDS99069	Drive Shaft	29T	22	22	52	97.5	584		
	2003.05-	2010.06		L/R	F	MPV Engine Z16XEP	GC044043	Outer Joint		22	28	52	97.5	57.5	O	
	2003.05-	2010.06		R	F	MPV Engine Z16XEP	GDS99157	Drive Shaft	29T	22	22	52	97.5	930		
1.6 Turbo (132 kW)	2006.05-	2010.06			L	MPV Engine Z16LET	GDS44032	Drive Shaft	29T	33	34	52	104	587.5		
	2006.05-	2010.06			L	MPV Engine Z16LET	GCI21034	Inner Joint		34	24	35	56.5	102		
	2006.05-	2010.06		L/R	F	MPV Engine Z16LET	GC022005	Outer Joint		33	24	52	104	64	M	
	2006.05-	2010.06		R	F	MPV Engine Z16LET	GDS60021	Drive Shaft	29T	33	34	52	104	612		
	2006.05-	2010.06		R	F	MPV Engine Z16LET	GCI60003	Inner Joint		34	24	35.5	47	70.5		
1.7 CDTi 16V (74 kW)	2003.09-	2005.08			F	MPV Engine Z17DTH	GC044004	Outer Joint	29T	33	24	52	104	64	M	
	2003.09-	2005.08		L	F	MPV Engine Z17DTH	GDS44032	Drive Shaft	29T	33	34	52	104	587.5		
	2003.09-	2005.08		L	F	MPV Engine Z17DTH	GCI21034	Inner Joint		34	24	35	56.5	102		
	2003.09-	2005.08		L/R	F	MPV Engine Z17DTH	GC022005	Outer Joint		33	24	52	104	64	M	
	2003.09-	2005.08		R	F	MPV Engine Z17DTH	GDS60021	Drive Shaft	29T	33	34	52	104	612		
	2003.09-	2005.08		R	F	MPV Engine Z17DTH	GCI60003	Inner Joint		34	24	35.5	47	70.5		
1.7 DTi 16V (55 kW)	2003.06-	2010.06			R	MPV Engine Y17DT	GDS44093	Drive Shaft	29T	33	34	52	104	619		
	2003.06-	2010.06			R	MPV Engine Y17DT	GCI60001	Inner Joint		22	28	34.9	57.5	96.5		
	2003.06-	2010.06			R	MPV Engine Y17DT	GC044043	Outer Joint		22	28	52	97.5	57.5	O	
1.8 i 16V (92 kW)	2003.05-	2005.08			F	MPV Engine Z18XE	GC044002	Outer Joint	29T	22	23	52	97.5	61	M	
	2003.05-	2005.08			F	MPV Engine Z18XE	GCI44009	Inner Joint		22	23	35	57.5	96		



		TRANSM	L/R	F/R		G-AP Ref.	PRODUCT	ABS	Technical Specifications						
									YEAR	A	B	C	H	L	P
<b>VAUXHALL</b>															
<b>MERIVA II (B)</b>															
1.3 CDTi (55 kW)	2010.06-		MT	R	F	MPV Engine A13DTC	GDS44088	Drive Shaft		33	22	52	103.5	953	
1.3 CDTi (70 kW)	2010.06-		MT	R	F	MPV Engine A13DTE	GDS44088	Drive Shaft		33	22	52	103.5	953	
1.7 CDTi (81 kW)	2010.06-					MPV Engine A17DTC	GC099024	Outer Joint		33	26	52.5	94	65.5	M
1.7 CDTi (96 kW)	2010.06-					MPV Engine A17DTS	GC099024	Outer Joint		33	26	52.5	94	65.5	M
<b>MOVANO I (A) (JD)</b>															
1.9 DTi (59 kW)	2000.09-	2001.10				Bus Engine F9Q770	GC044026	Outer Joint	51T	28	36	65	96	71	I
1.9 DTi (60 kW)	2001.10-	2010.05	MT	L	F	Bus Engine F9Q774	GDS44005	Drive Shaft	51T	28	37.1	65	96	670	
	2001.10-	2010.05	MT	L	F	Bus Engine F9Q774	GDS50246	Drive Shaft		28	37.1	65	96	644	
	2001.10-	2010.05	MT	L	F	Bus Engine F9Q774	GDS50058	Drive Shaft	51T	28	37.1	65	96	644	
	2001.10-	2010.05	MT	L	F	Bus Engine F9Q774	GDS50010	Drive Shaft		28	37.1	67.1	93.5	669	
	2001.10-	2010.05	MT	R	F	Bus Engine F9Q774	GDS44022	Drive Shaft		28	39	67.1	93.5	1147	
	2001.10-	2010.05	MT	R	F	Bus Engine F9Q774	GDS44017	Drive Shaft	51T	28	39	67.1	93.5	1147	
	2001.10-	2010.05	MT	R	F	Bus Engine F9Q774	GDS44021	Drive Shaft		28	39	65	96	1126	
	2001.10-	2010.05	MT	R	F	Bus Engine F9Q774	GDS50060	Drive Shaft	51T	28	39	65	96	1126	
	2001.10-	2010.05				Bus Engine F9Q774	GC044026	Outer Joint	51T	28	36	65	96	71	I
2.2 DTi (66 kW)	2000.09-	2010.05	MT	L	F	Bus Engine G9T720/G9T750	GDS44005	Drive Shaft	51T	28	37.1	65	96	670	
	2000.09-	2010.05	MT	L	F	Bus Engine G9T720/G9T750	GDS50010	Drive Shaft		28	37.1	67.1	93.5	669	
	2000.09-	2010.05	MT	R	F	Bus Engine G9T720/G9T750	GDS50214	Drive Shaft		28	39	65	96	1132	
	2000.09-	2010.05	MT	R	F	Bus Engine G9T720/G9T750	GDS44016	Drive Shaft	51T	28	39	65	96	1132	
	2000.09-	2010.05				Bus Engine G9T720/G9T750	GC044026	Outer Joint	51T	28	36	65	96	71	I
2.5 CDTi (107 kW)	2006.08-	2010.05	MT/AT	L	F	Bus Engine G9U632	GDS99286	Drive Shaft	51T	28	39	65	96	700	
	2006.08-	2010.05	MT	R	F	Bus Engine G9U632	GDS50066	Drive Shaft		28	39	65	96	1142	
2.5 CDTi (74 kW)	2001.10-	2009.08	MT	L	F	Bus Engine G9U650/G9U754	GDS44012	Drive Shaft		28	37.1	65	96	663	
	2001.10-	2009.08	MT	L	F	Bus Engine G9U650/G9U754	GDS50166	Drive Shaft	51T	28	37.1	65	96	663	
	2001.10-	2009.08	MT	R	F	Bus Engine G9U650/G9U754	GDS50066	Drive Shaft		28	39	65	96	1142	
	2001.10-	2009.08	MT	R	F	Bus Engine G9U650/G9U754	GDS50249	Drive Shaft		28	39	65	96	1144	
	2001.10-	2009.08	MT	R	F	Bus Engine G9U650/G9U754	GDS99151	Drive Shaft	51T	28	39	65	96	1144	
	2001.10-	2009.08				Bus Engine G9U650/G9U754	GC044026	Outer Joint	51T	28	36	65	96	71	I
2.5 CDTi (88 kW)	2003.02-	2009.08	MT/AT	L	F	Bus Engine G9U632/G9U650	GDS99286	Drive Shaft	51T	28	39	65	96	700	
	2003.02-	2009.08	MT	R	F	Bus Engine G9U632/G9U650	GDS50066	Drive Shaft		28	39	65	96	1142	
2.5 D (59 kW)	1998.10-	2000.09	MT		F	Bus Engine S8U770	GC044008	Outer Joint	51T	28	27	67.1	93.5	64.5	I
2.5 DTi (84 kW)	2001.10-	2009.08	MT	R	F	Bus Engine G9U720/G9U750/G9U754	GDS50066	Drive Shaft		28	39	65	96	1142	
	2001.10-	2009.08	MT	R	F	Bus Engine G9U720/G9U750/G9U754	GDS44004	Drive Shaft	51T	28	39	67.1	93.5	1118	
	2001.10-	2009.08	MT	R	F	Bus Engine G9U720/G9U750/G9U754	GDS50011	Drive Shaft		28	39	67.1	93.5	1118	
	2001.10-	2009.08				Bus Engine G9U720/G9U750/G9U754	GC044026	Outer Joint	51T	28	36	65	96	71	I
	2001.10-	2009.08	MT	L	F	Bus Engine G9U720/G9U750/G9U754	GDS44005	Drive Shaft	51T	28	37.1	65	96	670	
	2001.10-	2009.08	MT	L	F	Bus Engine G9U720/G9U750/G9U754	GDS50010	Drive Shaft		28	37.1	67.1	93.5	669	
	2001.10-	2009.08	MT/AT	L	F	Bus Engine G9U720/G9U750/G9U754	GDS99286	Drive Shaft	51T	28	39	65	96	700	
2.8 DTi (84 kW)	1998.10-	2001.10				Bus Engine S9W702	GC044026	Outer Joint	51T	28	36	65	96	71	I
	1998.10-	2001.10	MT		F	Bus Engine S9W702	GC044008	Outer Joint	51T	28	27	67.1	93.5	64.5	I
<b>MOVANO I (A) CHASSIS/CAB (ED, UD, HD)</b>															
2.2 DTi (66 kW)	2000.09-	2010.05	MT	L	F	Platform/Chassis Engine G9T720/G9T722/G9T750	GDS44005	Drive Shaft	51T	28	37.1	65	96	670	
	2000.09-	2010.05	MT	L	F	Platform/Chassis Engine G9T720/G9T722/G9T750	GDS50010	Drive Shaft		28	37.1	67.1	93.5	669	
	2000.09-	2010.05	MT	R	F	Platform/Chassis Engine G9T720/G9T722/G9T750	GDS50214	Drive Shaft		28	39	65	96	1132	
	2000.09-	2010.05	MT	R	F	Platform/Chassis Engine G9T720/G9T722/G9T750	GDS44016	Drive Shaft	51T	28	39	65	96	1132	
	2000.09-	2010.05				Platform/Chassis Engine G9T720/G9T722/G9T750	GC044026	Outer Joint	51T	28	36	65	96	71	I
2.5 CDTi (107 kW)	2006.08-	2010.05	MT/AT	L	F	Platform/Chassis Engine G9U632	GDS99286	Drive Shaft	51T	28	39	65	96	700	
	2006.08-	2010.05	MT	R	F	Platform/Chassis Engine G9U632	GDS50066	Drive Shaft		28	39	65	96	1142	
2.5 CDTi (74 kW)	2004.04-	2010.05	MT/AT	L	F	Platform/Chassis Engine G9U650/G9U754	GDS99286	Drive Shaft	51T	28	39	65	96	700	
	2004.04-	2010.05	MT	R	F	Platform/Chassis Engine G9U650/G9U754	GDS50066	Drive Shaft		28	39	65	96	1142	
	2004.04-	2010.05				Platform/Chassis Engine G9U650/G9U754	GC044026	Outer Joint	51T	28	36	65	96	71	I
2.5 CDTi (88 kW)	2006.08-	2010.05	MT/AT	L	F	Platform/Chassis Engine G9U632/G9U650	GDS99286	Drive Shaft	51T	28	39	65	96	700	
	2006.08-	2010.05	MT	R	F	Platform/Chassis Engine G9U632/G9U650	GDS50066	Drive Shaft		28	39	65	96	1142	
2.5 D (59 kW)	1998.10-	2000.09	MT		F	Platform/Chassis Engine S8U770	GC044008	Outer Joint	51T	28	27	67.1	93.5	64.5	I
2.5 DTi (84 kW)	2001.10-	2010.05	MT	L	F	Platform/Chassis Engine G9U720/G9U724/G9U754	GDS44012	Drive Shaft		28	37.1	65	96	663	
	2001.10-	2010.05	MT	L	F	Platform/Chassis Engine G9U720/G9U724/G9U754	GDS50166	Drive Shaft	51T	28	37.1	65	96	663	
	2001.10-	2010.05	MT	R	F	Platform/Chassis Engine G9U720/G9U724/G9U754	GDS50066	Drive Shaft		28	39	65	96	1142	
	2001.10-	2010.05	MT	R	F	Platform/Chassis Engine G9U720/G9U724/G9U754	GDS50249	Drive Shaft		28	39	65	96	1144	
	2001.10-	2010.05	MT	R	F	Platform/Chassis Engine G9U720/G9U724/G9U754	GDS99151	Drive Shaft	51T	28	39	65	96	1144	
	2001.10-	2010.05				Platform/Chassis Engine G9U720/G9U724/G9U754	GC044026	Outer Joint	51T	28	36	65	96	71	I
	2001.10-	2010.05				Platform/Chassis Engine G9U720/G9U724/G9U754	GC044026	Outer Joint	51T	28	36	65	96	71	I
2.8 DTi (84 kW)	1998.10-	2001.10				Platform/Chassis Engine S9W702	GC044026	Outer Joint	51T	28	36	65	96	71	I





		YEAR	TRANSM	L/R	F/R		G-AP Ref.	PRODUCT	ABS	Technical Specifications											
										A	B	C	H	L	P						
<b>VAUXHALL</b>																					
<b>MOVANO I (A) CHASSIS/CAB (ED, UD, HD)</b>																					
2.8 DTi (84 kW)	1998.10-	2001.10	MT			F Platform/Chassis Engine S9W702	GC044008	Outer Joint	51T	28	27	67.1	93.5	64.5	I						
<b>MOVANO I (A) VAN (FD)</b>																					
1.9 DTi (59 kW)	2000.09-	2001.10				Box Engine F9Q770	GC044026	Outer Joint	51T	28	36	65	96	71	I						
1.9 DTi (60 kW)	2001.10-	2010.05	MT	L	F	Box Engine F9Q774	GDS50246	Drive Shaft		28	37.1	65	96	670							
	2001.10-	2010.05	MT	L	F	Box Engine F9Q774	GDS50058	Drive Shaft	51T	28	37.1	65	96	644							
	2001.10-	2010.05	MT	L	F	Box Engine F9Q774	GDS50010	Drive Shaft		28	37.1	67.1	93.5	669							
	2001.10-	2010.05	MT	R	F	Box Engine F9Q774	GDS44022	Drive Shaft		28	39	67.1	93.5	1147							
	2001.10-	2010.05	MT	R	F	Box Engine F9Q774	GDS44017	Drive Shaft	51T	28	39	67.1	93.5	1147							
	2001.10-	2010.05	MT	R	F	Box Engine F9Q774	GDS44021	Drive Shaft		28	39	65	96	1126							
	2001.10-	2010.05	MT	R	F	Box Engine F9Q774	GDS50060	Drive Shaft	51T	28	39	65	96	1126							
	2001.10-	2010.05				Box Engine F9Q774	GC044026	Outer Joint	51T	28	36	65	96	71	I						
2.2 DTi (66 kW)	2000.09-	2010.05	MT	L	F	Box Engine G9T720/G9T722/G9T750	GDS44005	Drive Shaft	51T	28	37.1	65	96	670							
	2000.09-	2010.05	MT	L	F	Box Engine G9T720/G9T722/G9T750	GDS50010	Drive Shaft		28	37.1	67.1	93.5	669							
	2000.09-	2010.05	MT	R	F	Box Engine G9T720/G9T722/G9T750	GDS50214	Drive Shaft		28	39	65	96	1132							
	2000.09-	2010.05	MT	R	F	Box Engine G9T720/G9T722/G9T750	GDS44016	Drive Shaft	51T	28	39	65	96	1132							
	2000.09-	2010.05				Box Engine G9T720/G9T722/G9T750	GC044026	Outer Joint	51T	28	36	65	96	71	I						
2.5 CDTi (107 kW)	2006.08-	2010.05	MT	L	F	Box Engine G9U632	GDS99286	Drive Shaft	51T	28	39	65	96	700							
	2006.08-	2010.05	MT	R	F	Box Engine G9U632	GDS50066	Drive Shaft		28	39	65	96	1142							
2.5 CDTi (74 kW)	2004.04-	2010.05	MT/AT	L	F	Box Engine G9U650/G9U754	GDS99286	Drive Shaft	51T	28	39	65	96	700							
	2004.04-	2010.05	MT	R	F	Box Engine G9U650/G9U754	GDS50066	Drive Shaft		28	39	65	96	1142							
	2004.04-	2010.05				Box Engine G9U650/G9U754	GC044026	Outer Joint	51T	28	36	65	96	71	I						
2.5 CDTi (88 kW)	2006.08-	2010.05	MT/AT	L	F	Box Engine G9U632/G9U650	GDS99286	Drive Shaft	51T	28	39	65	96	700							
	2006.08-	2010.05	MT	R	F	Box Engine G9U632/G9U650	GDS50066	Drive Shaft		28	39	65	96	1142							
2.5 D (59 kW)	1998.10-	2000.09	MT			F Box Engine S8U770	GC044008	Outer Joint	51T	28	27	67.1	93.5	64.5	I						
2.5 DTi (84 kW)	2001.10-	2010.05	MT	L	F	Box Engine G9U720/G9U724/G9U750/G9U754	GDS44012	Drive Shaft		28	37.1	65	96	663							
	2001.10-	2010.05	MT	L	F	Box Engine G9U720/G9U724/G9U750/G9U754	GDS50166	Drive Shaft	51T	28	37.1	65	96	663							
	2001.10-	2010.05	MT	R	F	Box Engine G9U720/G9U724/G9U750/G9U754	GDS50249	Drive Shaft		28	39	65	96	1144							
	2001.10-	2010.05	MT	R	F	Box Engine G9U720/G9U724/G9U750/G9U754	GDS99151	Drive Shaft	51T	28	39	65	96	1144							
	2001.10-	2010.05				Box Engine G9U720/G9U724/G9U750/G9U754	GC044026	Outer Joint	51T	28	36	65	96	71	I						
2.8 TDi (84 kW)	1998.10-	2001.10				F Box Engine S9W702	GC044026	Outer Joint	51T	28	36	65	96	71	I						
	1998.10-	2001.10	MT			F Box Engine S9W702	GC044008	Outer Joint	51T	28	27	67.1	93.5	64.5	I						
<b>NOVA</b>																					
1.0 (33 kW)	1982.09-	1987.10	MT			F Saloon Engine 10S	GC044046	Outer Joint		22	28	52.2	97.5	55	O						
	1983.05-	1993.03	MT			F Hatchback Engine 10S	GC044046	Outer Joint		22	28	52.2	97.5	55	O						
1.2 i (33 kW)	1985.01-	1989.10	MT			F Hatchback Engine 12NC/E12GV	GC044046	Outer Joint		22	28	52.2	97.5	55	O						
1.2 i CAT (33 kW)	1989.09-	1993.03	MT			F Hatchback Engine C12NZ	GC044046	Outer Joint		22	28	52.2	97.5	55	O						
1.2 N (33 kW)	1985.01-	1987.10	MT			F Saloon Engine 12NC/E12GV	GC044046	Outer Joint		22	28	52.2	97.5	55	O						
1.2 N (38 kW)	1990.01-	1993.03	MT			F Hatchback Engine 12NV	GC044046	Outer Joint		22	28	52.2	97.5	55	O						
1.2 S (40 kW)	1982.09-	1987.10	MT			F Saloon Engine 12ST	GC044046	Outer Joint		22	28	52.2	97.5	55	O						
	1983.05-	1990.02	MT			F Hatchback Engine 12ST	GC044046	Outer Joint		22	28	52.2	97.5	55	O						
1.2 S (43 kW)	1988.01-	1990.02	MT			F Hatchback Engine 12S/12ST	GC044046	Outer Joint		22	28	52.2	97.5	55	O						
1.3 i (44 kW)	1985.09-	1987.10	MT			F Saloon Engine 13NB	GC044046	Outer Joint		22	28	52.2	97.5	55	O						
	1985.09-	1989.10	MT			F Hatchback Engine 13NB	GC044046	Outer Joint		22	28	52.2	97.5	55	O						
1.3 i CAT (44 kW)	1989.09-	1993.03	MT			F Hatchback Engine C13N	GC044046	Outer Joint		22	28	52.2	97.5	55	O						
1.3 S (51 kW)	1982.09-	1987.10	MT			F Saloon Engine 13SB	GC044046	Outer Joint		22	28	52.2	97.5	55	O						
	1983.05-	1989.10	MT			F Hatchback Engine 13SB	GC044046	Outer Joint		22	28	52.2	97.5	55	O						
1.4 i (44 kW)	1990.01-	1993.03	MT			F Hatchback Engine C14NZ	GC044046	Outer Joint		22	28	52.2	97.5	55	O						
1.4 i S (60 kW)	1991.09-	1993.03	MT			F Hatchback Engine C14SE	GC044046	Outer Joint		22	28	52.2	97.5	55	O						
1.4 S (55 kW)	1990.01-	1993.02	MT			F Saloon Engine 14NV	GC044046	Outer Joint		22	28	52.2	97.5	55	O						
	1990.01-	1993.03	MT			F Hatchback Engine 14NV	GC044046	Outer Joint		22	28	52.2	97.5	55	O						
1.5 D (37 kW)	1987.09-	1993.02	MT			F Saloon Engine 15D	GC044046	Outer Joint		22	28	52.2	97.5	55	O						
	1987.09-	1993.03	MT			F Hatchback Engine 15D	GC044046	Outer Joint		22	28	52.2	97.5	55	O						
1.5 TD (49 kW)	1990.01-	1993.02	MT			F Saloon Engine 15DT(T4EC1)	GC044041	Outer Joint		22	22	52	95	50	O						
	1990.01-	1993.03	MT			F Hatchback Engine 15DT(T4EC1)	GC044041	Outer Joint		22	22	52	95	50	O						
	1990.01-	1993.02	MT			F Saloon Engine 15DT(T4EC1)	GCI44004	Inner Joint		22	22	34.95	57.5	72.5							
	1990.01-	1993.03	MT			F Hatchback Engine 15DT(T4EC1)	GCI44004	Inner Joint		22	22	34.95	57.5	72.5							
1.6 GSi (72 kW)	1989.09-	1993.03	MT			F Hatchback Engine C16SEI	GC044041	Outer Joint		22	22	52	95	50	O						
	1989.09-	1993.03	MT			F Hatchback Engine C16SEI	GCI44004	Inner Joint		22	22	34.95	57.5	72.5							
1.6 GSi (74 kW)	1988.05-	1992.03	MT			F Hatchback Engine E16SE	GC044041	Outer Joint		22	22	52	95	50	O						
	1988.05-	1992.03	MT			F Hatchback Engine E16SE	GCI44004	Inner Joint		22	22	34.95	57.5	72.5							









		YEAR	TRANSM	L/R	F/R		G-AP Ref.	PRODUCT	ABS	Technical Specifications										
										A	B	C	H	L	P					
<b>VAUXHALL NOVA</b>																				
1.6 GSi CAT (74 kW)	1992.02-	1993.03	MT		F	Hatchback Engine C16SE	GC044041	Outer Joint		22	22	52	95	50	O					
	1992.02-	1993.03	MT		F	Hatchback Engine C16SE	GCI44004	Inner Joint		22	22	34.95	57.5	72.5						
<b>SIGNUM</b>																				
1.8 (103 kW)	2005.08-	2008.05	MT	L	F	Hatchback Engine Z18XER	GDS44020	Drive Shaft		30	22	52.5	105	617.5						
	2005.08-	2008.05	MT	L/R	F	Hatchback Engine Z18XER	GCI99026	Inner Joint		22	25	35	57	82.5						
	2005.08-	2008.05	MT	L/R	F	Hatchback Engine Z18XER	GC017007	Outer Joint		30	25	52.5	105	62	O					
	2005.08-	2008.05	MT	R	F	Hatchback Engine Z18XER	GDS17040	Drive Shaft		30	22	52.5	105	987						
1.8 (90 kW)	2003.06-	2005.07	MT	L	F	Hatchback Engine Z18XE	GDS44020	Drive Shaft		30	22	52.5	105	617.5						
	2003.06-	2005.07	MT	L/R	F	Hatchback Engine Z18XE	GCI99026	Inner Joint		22	25	35	57	82.5						
	2003.06-	2005.07	MT	L/R	F	Hatchback Engine Z18XE	GC017007	Outer Joint		30	25	52.5	105	62	O					
	2003.06-	2005.07	MT	R	F	Hatchback Engine Z18XE	GDS17040	Drive Shaft		30	22	52.5	105	987						
1.8 16V (103 kW)	2003.05-				Ch-71009336	GC017007	Outer Joint		30	25	52.5	105	62	O						
1.8 16V (90 kW)	2003.05-				Ch-71009336	GC017007	Outer Joint		30	25	52.5	105	62	O						
1.9 CDTi (110 kW)	2004.04-						GCI99138	Inner Joint		27	28	35	78	83						
	2004.04-						GC017051	Outer Joint		30	26	53.8	94.5	65.5	M					
1.9 CDTi (74 kW)	2004.04-						GCI99138	Inner Joint		27	28	35	78	83						
	2004.04-						GC017051	Outer Joint		30	26	53.8	94.5	65.5	M					
	2004.04-																			
1.9 CDTi (88 kW)	2004.04-	2008.03	MT		F	Hatchback Engine Z19DT	GC017051	Outer Joint		30	26	53.8	94.5	65.5	M					
	2004.04-	2008.03	MT	L	F	Hatchback Engine Z19DT	GDS21092	Drive Shaft		30	25	53.8	94.5	604						
	2004.04-	2008.03	MT	L	F	Hatchback Engine Z19DT	GDS21032	Drive Shaft		30	27	53.8	94.5	605						
	2004.04-	2008.03	MT	L/R	F	Hatchback Engine Z19DT	GCI99138	Inner Joint		27	28	35	78	83						
	2004.04-	2008.03	MT	R	F	Hatchback Engine Z19DT	GDS21053	Drive Shaft		30	34	53.8	94.5	617						
	2004.04-	2008.03	MT	R	F	Hatchback Engine Z19DT	GDS21032	Drive Shaft		30	27	53.8	94.5	605						
	2004.04-						GCI99138	Inner Joint		27	28	35	78	83						
	2004.04-						GC017051	Outer Joint		30	26	53.8	94.5	65.5	M					
1.9 CDTi 16V (110 kW)	2004.04-	2008.03	MT/AT		F	Hatchback Engine Z19DTH	GC017051	Outer Joint		30	26	53.8	94.5	65.5	M					
	2004.04-	2008.03	MT	L	F	Hatchback Engine Z19DTH	GDS21032	Drive Shaft		30	27	53.8	94.5	605						
	2004.04-	2008.03	AT	L/R	F	Hatchback Engine Z19DTH	GDS44080	Drive Shaft		30	27	53.8	94.5	591						
	2004.04-	2008.03	MT	L/R	F	Hatchback Engine Z19DTH	GCI99138	Inner Joint		27	28	35	78	83						
	2004.04-	2008.03	MT	R	F	Hatchback Engine Z19DTH	GDS21053	Drive Shaft		30	34	53.8	94.5	617						
	2004.04-	2008.03	MT	R	F	Hatchback Engine Z19DTH	GDS21032	Drive Shaft		30	27	53.8	94.5	605						
	2004.04-	2008.03				Hatchback Engine Z19DTH	GC099023	Outer Joint		30	26	53.8	94.5	65.5	M					
1.9 Turbo (74 kW)	2005.01-	2008.05		L	F	Hatchback Engine Z19DTL	GDS21032	Drive Shaft		30	27	53.8	94.5	605						
	2005.01-	2008.05	MT	L	F	Hatchback Engine Z19DTL	GDS21092	Drive Shaft		30	25	53.8	94.5	604						
	2005.01-	2008.05		L/R	F	Hatchback Engine Z19DTL	GCI99138	Inner Joint		27	28	35	78	83						
	2005.01-	2008.05		R	F	Hatchback Engine Z19DTL	GDS21032	Drive Shaft		30	27	53.8	94.5	605						
	2005.01-	2008.05	MT	R	F	Hatchback Engine Z19DTL	GDS21053	Drive Shaft		30	34	53.8	94.5	617						
2.0 DTi (74 kW)	2003.05-	2008.05			F	Hatchback Engine Y20DTH	GC017007	Outer Joint		30	25	52.5	105	62	O					
	2003.05-	2008.05	MT	R	F	Hatchback Engine Y20DTH	GDS21061	Drive Shaft		30	34	52.5	105	968						
2.0 DTi 16V (74 kW)	2003.05-					GC017007	Outer Joint		30	25	52.5	105	62	O						
2.0 i Turbo (129 kW)	2002.01-	2008.10	MT		F	Hatchback Engine Z20NET	GC017051	Outer Joint		30	26	53.8	94.5	65.5	M					
	2002.01-	2008.10	MT	L/R	F	Hatchback Engine Z20NET	GCI99138	Inner Joint		27	28	35	78	83						
	2002.01-	2008.10	MT	L/R	F	Hatchback Engine Z20NET	GDS21032	Drive Shaft		30	27	53.8	94.5	605						
	2002.01-	2008.10				Hatchback Engine Z20NET	GC099023	Outer Joint		30	26	53.8	94.5	65.5	M					
2.0 Turbo 16V (129 kW)	2003.05-						GCI99138	Inner Joint		27	28	35	78	83						
	2003.05-						GC017051	Outer Joint		30	26	53.8	94.5	65.5	M					
2.2 16V (114 kW)	2003.05-					GC017007	Outer Joint		30	25	52.5	105	62	O						
2.2 DTi (92 kW)	2003.05-	2008.05	MT		F	Hatchback Engine Y22DTR	GC017051	Outer Joint		30	26	53.8	94.5	65.5	M					
	2003.05-	2008.05	MT	L/R	F	Hatchback Engine Y22DTR	GCI99138	Inner Joint		27	28	35	78	83						
	2003.05-	2008.05	MT	L/R	F	Hatchback Engine Y22DTR	GDS21032	Drive Shaft		30	27	53.8	94.5	605						
	2003.05-	2008.05				Hatchback Engine Y22DTR	GC099023	Outer Joint		30	26	53.8	94.5	65.5	M					
2.2 DTi 16V (92 kW)	2003.05-						GCI99138	Inner Joint		27	28	35	78	83						
	2003.05-						GC017051	Outer Joint		30	26	53.8	94.5	65.5	M					
2.2 i (114 kW)	2003.05-	2008.05			F	Hatchback Engine Z22YH	GC017007	Outer Joint		30	25	52.5	105	62	O					
	2003.05-	2008.05				Hatchback Engine Z22YH	GC099023	Outer Joint		30	26	53.8	94.5	65.5	M					
2.8 V6 Turbo (169 kW)	2002.04-	2008.05				Hatchback Engine Z28NEL	GC099023	Outer Joint		30	26	53.8	94.5	65.5	M					
	2005.09-		MT				GCI99138	Inner Joint		27	28	35	78	83						
2.8 V6 Turbo (184 kW)	2005.09-		MT				GCI99138	Inner Joint		27	28	35	78	83						
3.0 CDTi (130 kW)	2003.05-	2008.05	MT		F	Hatchback Engine Y30DT	GC017051	Outer Joint		30	26	53.8	94.5	65.5	M					
	2003.05-	2008.05	MT	L/R	F	Hatchback Engine Y30DT	GCI99138	Inner Joint		27	28	35	78	83						
	2003.05-	2008.05	MT	L/R	F	Hatchback Engine Y30DT	GDS21032	Drive Shaft		30	27	53.8	94.5	605						

		YEAR	TRANSM	L/R	F/R		G-AP Ref.	PRODUCT	ABS	Technical Specifications						
										A	B	C	H	L	P	
<b>VAUXHALL SIGNUM</b>																
3.0 CDTi (130 kW)	2003.05-	2008.05				Hatchback Engine Y30DT	GC099023	Outer Joint		30	26	53.8	94.5	65.5	M	
3.0 V6 CDTi (130 kW)	2003.05-						GCI199138	Inner Joint		27	28	35	78	83		
	2003.05-						GC017051	Outer Joint		30	26	53.8	94.5	65.5	M	
3.0 V6 CDTi (135 kW)	2002.04-	2008.05				Hatchback Engine Z30DT	GC099023	Outer Joint		30	26	53.8	94.5	65.5	M	
	2005.09-		MT				GCI99138	Inner Joint		27	28	35	78	83		
	2005.09-						GC017051	Outer Joint		30	26	53.8	94.5	65.5	M	
3.2 V6 (155 kW)	2003.05-	2008.05	MT		F	Hatchback Engine Z32SE	GC017051	Outer Joint		30	26	53.8	94.5	65.5	M	
	2003.05-	2008.05	MT	L/R	F	Hatchback Engine Z32SE	GCI99138	Inner Joint		27	28	35	78	83		
	2003.05-	2008.05	MT	L/R	F	Hatchback Engine Z32SE	GDS21032	Drive Shaft		30	27	53.8	94.5	605		
	2003.05-	2008.05				Hatchback Engine Z32SE	GC099023	Outer Joint		30	26	53.8	94.5	65.5	M	
	2003.05-						GCI99138	Inner Joint		27	28	35	78	83		
2003.05-						GC017051	Outer Joint		30	26	53.8	94.5	65.5	M		
<b>TIGRA</b>																
1.4 16V	1994.11-	2000.06	MT	L	F		GDS60007	Drive Shaft		22	22	52	97	563		
1.6	1994.11-	2000.06	MT				GC044024	Outer Joint		22	22	52.2	97	50	O	
<b>TIGRA B TWINTOP</b>																
1.8 16V (92 kW)	2004.06-						GC044002	Outer Joint	29T	22	23	52	97.5	61	M	
<b>TIGRA I (F07)</b>																
1.4 16V (66 kW)	1994.07-	2000.12	MT		F	Coupe Engine X14XE	GCI44003	Inner Joint		22	28	34.95	57.5	83.5		
1.6 16V (78 kW)	1994.07-	2000.12	MT		F	Coupe Engine X16XE	GCI44004	Inner Joint		22	22	34.95	57.5	72.5		
<b>TIGRA TWINTOP</b>																
1.3 CDTi (51 kW)	2004.06-	2009.08			F	Convertible Engine Z13DT	GCI44009	Inner Joint		22	23	35	57.5	96		
	2004.06-	2009.08		R	F	Convertible Engine Z13DT	GDS44075	Drive Shaft	29T	22	22	52	97.5	926		
	2004.06-	2009.08	MT	R	F	Convertible Engine Z13DT	GDS99205	Drive Shaft		22	22	52	97.5	930		
	2004.06-	2009.08	MT	R	F	Convertible Engine Z13DT	GCI60001	Inner Joint		22	28	34.9	57.5	96.5		
	2004.06-	2009.08	MT	R	F	Convertible Engine Z13DT	GC044043	Outer Joint		22	28	52	97.5	57.5	O	
1.4 (66 kW)	2004.06-	2009.08		R	F	Convertible Engine Z14XEP	GDS44075	Drive Shaft	29T	22	22	52	97.5	926		
	2004.06-	2009.08		R	F	Convertible Engine Z14XEP	GDS99205	Drive Shaft		22	22	52	97.5	930		
	2004.06-	2009.08		R	F	Convertible Engine Z14XEP	GCI60001	Inner Joint		22	28	34.9	57.5	96.5		
	2004.06-	2009.08		R	F	Convertible Engine Z14XEP	GC044043	Outer Joint		22	28	52	97.5	57.5	O	
1.8 (92 kW)	2004.06-	2009.08			F	Convertible Engine Z18XE	GC044002	Outer Joint	29T	22	23	52	97.5	61	M	
	2004.06-	2009.08			F	Convertible Engine Z18XE	GCI44009	Inner Joint		22	23	35	57.5	96		
	2004.06-	2009.08		R	F	Convertible Engine Z18XE	GDS44075	Drive Shaft	29T	22	22	52	97.5	926		
<b>VECTRA (B)</b>																
1.6 i (55 kW)	1995.08-	2001.10		L/R	F	Hatchback Engine X16SZR	GCI21014	Inner Joint		22	22	35	57.5	75		
	1995.08-	2001.10		L/R	F	Saloon Engine X16SZR	GCI21014	Inner Joint		22	22	35	57.5	75		
	1996.11-	2002.03			F	Estate Engine X16SZR	GC044011	Outer Joint	29T	33	22	52	103	50.5	O	
	1996.11-	2002.03			F	Estate Engine X16SZR	GC044039	Outer Joint		22	22	52	95	50.5	O	
	1996.11-	2002.03	MT/AT		F	Estate Engine X16SZR	GC044007	Outer Joint	29T	22	22	52	94.5	50	O	
	1996.11-	2002.03		L	F	Estate Engine X16SZR	GDS44076	Drive Shaft	29T	22	22	52	95	592		
	1996.11-	2002.03		L	F	Estate Engine X16SZR	GCI21014	Inner Joint		22	22	35	57.5	75		
	1996.11-	2002.03		R	F	Estate Engine X16SZR	GDS44077	Drive Shaft	29T	22	22	52	95	955		
1996.11-	2002.03		R	F	Estate Engine X16SZR	GCI21014	Inner Joint		22	22	35	57.5	75			
1.6 i 16V (74 kW)	1995.08-	2001.10		L/R	F	Hatchback Engine X16XEL/Y16XE/Z16XE	GCI21014	Inner Joint		22	22	35	57.5	75		
	1995.08-	2001.10		L/R	F	Saloon Engine X16XEL/Y16XE/Z16XE	GCI21014	Inner Joint		22	22	35	57.5	75		
	1996.11-	2002.03			F	Estate Engine X16XEL/Y16XE/Z16XE	GC044011	Outer Joint	29T	33	22	52	103	50.5	O	
	1996.11-	2002.03			F	Estate Engine X16XEL/Y16XE/Z16XE	GC044039	Outer Joint		22	22	52	95	50.5	O	
	1996.11-	2002.03	MT/AT		F	Estate Engine X16XEL/Y16XE/Z16XE	GC044007	Outer Joint	29T	22	22	52	94.5	50	O	
	1996.11-	2002.03		L	F	Estate Engine X16XEL/Y16XE/Z16XE	GDS44076	Drive Shaft	29T	22	22	52	95	592		
	1996.11-	2002.03		L	F	Estate Engine X16XEL/Y16XE/Z16XE	GCI21014	Inner Joint		22	22	35	57.5	75		
	1996.11-	2002.03		R	F	Estate Engine X16XEL/Y16XE/Z16XE	GDS44077	Drive Shaft	29T	22	22	52	95	955		
1996.11-	2002.03		R	F	Estate Engine X16XEL/Y16XE/Z16XE	GCI21014	Inner Joint		22	22	35	57.5	75			
1.8 i 16V (92 kW)	2000.09-	2002.03	MT/AT		F	Estate Engine Z18XE	GC044006	Outer Joint	29T	33	25	52	103.5	61	O	
	2000.09-	2002.03	MT/AT		F	Saloon Engine Z18XE	GC044006	Outer Joint	29T	33	25	52	103.5	61	O	
	2000.09-	2003.07	MT/AT		F	Hatchback Engine Z18XE	GC044006	Outer Joint	29T	33	25	52	103.5	61	O	
2.2 DTi 16V (92 kW)	1995.08-	2001.10	MT	L/R	F	Estate Engine Y22DTR	GCI99138	Inner Joint		27	28	35	78	83		
	1995.08-	2001.10	MT	L/R	F	Hatchback Engine Y22DTR	GCI99138	Inner Joint		27	28	35	78	83		
2.2 i 16V (108 kW)	2000.09-	2003.07	5MT/4AT	L	F	Hatchback Engine Z22SE	GDS44038	Drive Shaft	29T	33	34	52	103.5	595		
	2000.09-	2003.07	5MT/4AT	R	F	Hatchback Engine Z22SE	GDS44039	Drive Shaft	29T	33	34	52	103.5	959		
<b>VECTRA A (86, 87)</b>																
1.7 D (42 kW)	1988.10-	1995.11				Ch-K1000001-M1666666	GC044057	Outer Joint	43T	33	25	52	109	61	O	



		TRANSM	L/R	F/R		G-AP Ref.	PRODUCT	ABS	Technical Specifications							
									YEAR	A	B	C	H	L	P	
<b>VAUXHALL</b>																
<b>VECTRA A (86, 87)</b>																
1.7 D (44 kW)	1988.10-	1995.11				Ch-K1000001-M1666666	GC044057	Outer Joint	43T	33	25	52	109	61	O	
1.7 TD (60 kW)	1990.03-	1995.11				Ch-K1000001-M1999999	GC044057	Outer Joint	43T	33	25	52	109	61	O	
1.8 S 4WD Kat (65 kW)	1988.09-	1990.10	MT/AT			Ch-K1000001-M1999999	GC044057	Outer Joint	43T	33	25	52	109	61	O	
1.8 S 4WD Kat (66 kW)	1988.09-	1990.10	MT/AT			Ch-K1000001-M1999999	GC044057	Outer Joint	43T	33	25	52	109	61	O	
2.0 GT 16V Kat 4WD (110 kW)	1989.01-	1995.11			F	Ch-K100001-M1999999	GC044057	Outer Joint	43T	33	25	52	109	61	O	
2.0 i (74 kW)	1988.09-	1989.09	MT/AT			Ch-K1000001-M1999999	GC044057	Outer Joint	43T	33	25	52	109	61	O	
2.0 i 16V 4WD (100 kW)	1994.06-	1995.11	MT		F	Ch-K1000001-M1999999	GC044057	Outer Joint	43T	33	25	52	109	61	O	
2.0 i 4WD (85 kW)	1988.09-	1992.09				Ch-K1000001-M1999999	GC044057	Outer Joint	43T	33	25	52	109	61	O	
2.0 i 4WD (95 kW)	1988.09-	1992.09				Ch-K1000001-M1999999	GC044057	Outer Joint	43T	33	25	52	109	61	O	
2.0 i 4WD Kat (85 kW)	1989.01-	1995.11				Ch-K1000001-M1999999	GC044057	Outer Joint	43T	33	25	52	109	61	O	
<b>VECTRA B</b>																
2.0 Di	1996.08-	2002.05	MT	L	F		GDS60012	Drive Shaft	29T	33	34	52	103.5	586		
2.2 16V	2000.09-	2002.05	MT/AT	L	F		GDS60012	Drive Shaft	29T	33	34	52	103.5	586		
<b>VECTRA B (36), SW</b>																
1.6 i (55 kW)	1995.10-	2002.04				Ch-W1285446	GC044060	Outer Joint	29T	22	22	52	98	51	O	
	1995.10-	2002.04					GCI21014	Inner Joint		22	22	35	57.5	75		
1.6 i 16V (74 kW)	1995.10-	2002.04				Ch-W1285446	GC044060	Outer Joint	29T	22	22	52	98	51	O	
	1995.10-	2002.04					GCI21014	Inner Joint		22	22	35	57.5	75		
1.8 i 16V (85 kW)	1995.10-	2002.04					GCI21011	Inner Joint		34	25	35	78	64		
	1995.10-	2002.04					GC044006	Outer Joint	29T	33	25	52	103.5	61	O	
1.8 i 16V (92 kW)	1995.10-	2002.04					GCI21011	Inner Joint		34	25	35	78	64		
	1995.10-	2002.04					GC044006	Outer Joint	29T	33	25	52	103.5	61	O	
2.0 Di 16V (60 kW)	1996.11-	2002.04					GC044006	Outer Joint	29T	33	25	52	103.5	61	O	
2.0 Di 16V (60 kW)	1996.11-	2002.04					GCI21011	Inner Joint		34	25	35	78	64		
2.0 DTi 16V (74 kW)	1997.06-	2002.04					GCI21011	Inner Joint		34	25	35	78	64		
	1997.06-	2002.04					GC044006	Outer Joint	29T	33	25	52	103.5	61	O	
2.0 i 16V (100 kW)	1995.10-	2000.09					GCI21011	Inner Joint		34	25	35	78	64		
	1995.10-	2000.09					GC044006	Outer Joint	29T	33	25	52	103.5	61	O	
2.2 DTi 16V (92 kW)	2000.09-	2002.04					GC044065	Outer Joint	29T	33	35	55	104	67.5	I	
2.2 i 16V (108 kW)	2000.09-	2002.04					GCI21011	Inner Joint		34	25	35	78	64		
	2000.09-	2002.04					GC044006	Outer Joint	29T	33	25	52	103.5	61	O	
2.5 i (143 kW)	1998.05-	2000.09					GCI21011	Inner Joint		34	25	35	78	64		
	1998.05-	2000.09					GC044006	Outer Joint	29T	33	25	52	103.5	61	O	
2.5 i V6 (125 kW)	1995.10-	2000.09					GCI21011	Inner Joint		34	25	35	78	64		
	1995.10-	2000.09					GC044006	Outer Joint	29T	33	25	52	103.5	61	O	
<b>VECTRA C</b>																
2.0 DTi	2002.06-		MT/AT	L	F		GDS60015	Drive Shaft		30	34	52.5	105	628		
	2002.06-			R	F		GDS60016	Drive Shaft		30	34	52.5	105	588		
2.2 16V	2002.06-		MT/AT	L	F		GDS60015	Drive Shaft		30	34	52.5	105	628		
	2002.06-			R	F		GDS60016	Drive Shaft		30	34	52.5	105	588		
<b>VECTRA C, SW</b>																
1.6 16V (74 kW)	2004.05-					Ch-71009336	GC017007	Outer Joint		30	25	52.5	105	62	O	
1.6 16V (77 kW)	2004.05-					Ch-71009336	GC017007	Outer Joint		30	25	52.5	105	62	O	
1.8 (81 kW)	2002.04-					Ch-71009336	GC017007	Outer Joint		30	25	52.5	105	62	O	
1.8 16V (103 kW)	2002.04-						GC017007	Outer Joint		30	25	52.5	105	62	O	
1.8 16V (90 kW)	2002.04-						GC017007	Outer Joint		30	25	52.5	105	62	O	
1.9 CDTi (110 kW)	2004.04-		MT				GCI99138	Inner Joint		27	28	35	78	83		
	2004.04-						GC017051	Outer Joint		30	26	53.8	94.5	65.5	M	
1.9 CDTi (74 kW)	2004.04-		MT				GCI99138	Inner Joint		27	28	35	78	83		
	2004.04-						GC017051	Outer Joint		30	26	53.8	94.5	65.5	M	
1.9 CDTi (88 kW)	2004.04-		MT				GCI99138	Inner Joint		27	28	35	78	83		
	2004.04-						GC017051	Outer Joint		30	26	53.8	94.5	65.5	M	
2.0 DTi 16V (74 kW)	2002.04-		MT				GC017007	Outer Joint		30	25	52.5	105	62	O	
2.0 T 16V (129 kW)	2003.03-						GCI99138	Inner Joint		27	28	35	78	83		
	2003.03-						GC017051	Outer Joint		30	26	53.8	94.5	65.5	M	
2.2 16V (108 kW)	2002.04-						GC017007	Outer Joint		30	25	52.5	105	62	O	
2.2 Direct 16V (114 kW)	2003.10-					Ch-71009336	GC017007	Outer Joint		30	25	52.5	105	62	O	
2.2 DTi 16V (92 kW)	2002.04-						GCI99138	Inner Joint		27	28	35	78	83		
	2002.04-						GC017051	Outer Joint		30	26	53.8	94.5	65.5	M	
3.0 CDTi (130 kW)	2005.08-						GCI99138	Inner Joint		27	28	35	78	83		
	2005.08-						GC017051	Outer Joint		30	26	53.8	94.5	65.5	M	





		TRANSM	L/R	F/R		G-AP Ref.	PRODUCT	ABS	Technical Specifications									
									YEAR	A	B	C	H	L	P			
<b>VAUXHALL</b>																		
<b>VECTRA C, SW</b>																		
3.2 V6 (155 kW)	2002.08-		MT			GCI99138	Inner Joint		27	28	35	78	83					
	2002.08-					GC017051	Outer Joint		30	26	53.8	94.5	65.5	M				
<b>VECTRA II (C)</b>																		
1.6 (77 kW)	2006.01-	2008.07			F Saloon Engine Z16XEP	GC017007	Outer Joint		30	25	52.5	105	62	O				
1.6 16V (74 kW)	2004.06-	2008.07			F Estate Engine Z16XE	GC017007	Outer Joint		30	25	52.5	105	62	O				
	2004.06-	2008.07			F Saloon Engine Z16XE	GC017007	Outer Joint		30	25	52.5	105	62	O				
1.8 (103 kW)	2006.01-	2008.07			F Estate Engine Z18XER	GC017007	Outer Joint		30	25	52.5	105	62	O				
	2006.01-	2008.07			F Saloon Engine Z18XER	GC017007	Outer Joint		30	25	52.5	105	62	O				
	2006.01-	2008.07	MT	L	F Estate Engine Z18XER	GDS44020	Drive Shaft		30	22	52.5	105	617.5					
	2006.01-	2008.07	MT	L	F Saloon Engine Z18XER	GDS44020	Drive Shaft		30	22	52.5	105	617.5					
	2006.01-	2008.07	MT	L	F Saloon Engine Z18XER	GC199026	Inner Joint		22	25	35	57	82.5					
	2006.01-	2008.07	MT	L	F Saloon Engine Z18XER	GC017007	Outer Joint		30	25	52.5	105	62	O				
	2006.01-	2008.07	MT	L/R	F Estate Engine Z18XER	GC199026	Inner Joint		22	25	35	57	82.5					
	2006.01-	2008.07	MT	L/R	F Estate Engine Z18XER	GC017007	Outer Joint		30	25	52.5	105	62	O				
	2006.01-	2008.07	MT	R	F Estate Engine Z18XER	GDS17040	Drive Shaft		30	22	52.5	105	987					
	2006.01-	2008.07	MT/AT	R	F Saloon Engine Z18XER	GDS17040	Drive Shaft		30	22	52.5	105	987					
	2006.01-	2008.07	MT/AT	R	F Saloon Engine Z18XER	GC199026	Inner Joint		22	25	35	57	82.5					
	2006.01-	2008.07	MT/AT	R	F Saloon Engine Z18XER	GC017007	Outer Joint		30	25	52.5	105	62	O				
1.8 (81 kW)	2002.04-	2008.07			F Saloon Engine Z18XEL	GC017007	Outer Joint		30	25	52.5	105	62	O				
1.8 16V (90 kW)	2002.04-	2008.07			F Saloon Engine Z18XE	GC017007	Outer Joint		30	25	52.5	105	62	O				
	2002.04-	2008.07	MT	L	F Saloon Engine Z18XE	GDS44020	Drive Shaft		30	22	52.5	105	617.5					
	2002.04-	2008.07	MT	L/R	F Saloon Engine Z18XE	GC199026	Inner Joint		22	25	35	57	82.5					
	2002.04-	2008.07	MT	L/R	F Saloon Engine Z18XE	GC017007	Outer Joint		30	25	52.5	105	62	O				
	2002.04-	2008.07	MT	R	F Saloon Engine Z18XE	GDS17040	Drive Shaft		30	22	52.5	105	987					
	2003.10-	2005.08			F Estate Engine Z18XE	GC017007	Outer Joint		30	25	52.5	105	62	O				
	2003.10-	2005.08	MT	L	F Estate Engine Z18XE	GDS44020	Drive Shaft		30	22	52.5	105	617.5					
	2003.10-	2005.08	MT	L	F Estate Engine Z18XE	GC199026	Inner Joint		22	25	35	57	82.5					
	2003.10-	2005.08	MT	L	F Estate Engine Z18XE	GC017007	Outer Joint		30	25	52.5	105	62	O				
	2003.10-	2005.08	MT	R	F Estate Engine Z18XE	GDS17040	Drive Shaft		30	22	52.5	105	987					
	2003.10-	2005.08			F Estate Engine Z18XE	GC199026	Inner Joint		22	25	35	57	82.5					
	2003.10-	2005.08	R	F Estate Engine Z18XE	GC017007	Outer Joint		30	25	52.5	105	62	O					
	2003.10-	2005.08	R	F Estate Engine Z18XE	GC017007	Outer Joint		30	25	52.5	105	62	O					
	1.8 16V Dualfuel (90 kW)	2002.04-	2008.07			F Saloon Engine Z18XE	GC017007	Outer Joint		30	25	52.5	105	62	O			
2002.04-		2008.07	MT	L	F Saloon Engine Z18XE	GDS44020	Drive Shaft		30	22	52.5	105	617.5					
2002.04-		2008.07	MT	L/R	F Saloon Engine Z18XE	GC199026	Inner Joint		22	25	35	57	82.5					
2002.04-		2008.07	MT	L/R	F Saloon Engine Z18XE	GC017007	Outer Joint		30	25	52.5	105	62	O				
2002.04-		2008.07	MT	R	F Saloon Engine Z18XE	GDS17040	Drive Shaft		30	22	52.5	105	987					
1.9 CDTi (74 kW)	2005.10-	2008.07	MT/AT		F Saloon Engine Z19DTL	GC017051	Outer Joint		30	26	53.8	94.5	65.5	M				
1.9 CDTi (88 kW)	2002.04-	2008.09	MT		F Saloon Engine Z19DT	GC017051	Outer Joint		30	26	53.8	94.5	65.5	M				
	2002.04-	2008.09	MT	L	F Saloon Engine Z19DT	GDS21092	Drive Shaft		30	25	53.8	94.5	604					
	2002.04-	2008.09	MT	L	F Saloon Engine Z19DT	GDS21032	Drive Shaft		30	27	53.8	94.5	605					
	2002.04-	2008.09	MT	L/R	F Saloon Engine Z19DT	GC199138	Inner Joint		27	28	35	78	83					
	2002.04-	2008.09	MT	R	F Saloon Engine Z19DT	GDS21053	Drive Shaft		30	34	53.8	94.5	617					
	2002.04-	2008.09	MT	R	F Saloon Engine Z19DT	GDS21032	Drive Shaft		30	27	53.8	94.5	605					
	2004.04-	2008.07	MT		F Estate Engine Z19DT	GC017051	Outer Joint		30	26	53.8	94.5	65.5	M				
	2004.04-	2008.07	MT	L	F Estate Engine Z19DT	GDS21092	Drive Shaft		30	25	53.8	94.5	604					
	2004.04-	2008.07	MT	L	F Estate Engine Z19DT	GDS21032	Drive Shaft		30	27	53.8	94.5	605					
	2004.04-	2008.07	MT	L/R	F Estate Engine Z19DT	GC199138	Inner Joint		27	28	35	78	83					
	2004.04-	2008.07	MT	R	F Estate Engine Z19DT	GDS21053	Drive Shaft		30	34	53.8	94.5	617					
	2004.04-	2008.07	MT	R	F Estate Engine Z19DT	GDS21032	Drive Shaft		30	27	53.8	94.5	605					
	2004.04-	2008.07	MT		Estate Engine Z19DT	GC099023	Outer Joint		30	26	53.8	94.5	65.5	M				
	1.9 CDTi 16V (110 kW)	2004.04-	2008.08	MT	R	F Saloon Engine Z19DTH	GDS21032	Drive Shaft		30	27	53.8	94.5	605				
2004.04-		2008.08			Saloon Engine Z19DTH	GC099023	Outer Joint		30	26	53.8	94.5	65.5	M				
2004.04-		2008.07	MT/AT		F Estate Engine Z19DTH	GC017051	Outer Joint		30	26	53.8	94.5	65.5	M				
2004.04-		2008.07	MT	L	F Estate Engine Z19DTH	GDS21032	Drive Shaft		30	27	53.8	94.5	605					
2004.04-		2008.07	MT	L/R	F Estate Engine Z19DTH	GC199138	Inner Joint		27	28	35	78	83					
2004.04-		2008.07	Semi-AT	L/R	F Estate Engine Z19DTH	GDS44080	Drive Shaft		30	27	53.8	94.5	591					
2004.04-		2008.07	MT	R	F Estate Engine Z19DTH	GDS21032	Drive Shaft		30	27	53.8	94.5	605					
2004.04-		2008.07			Estate Engine Z19DTH	GC099023	Outer Joint		30	26	53.8	94.5	65.5	M				
2004.04-		2008.08	MT/AT		F Saloon Engine Z19DTH	GC017051	Outer Joint		30	26	53.8	94.5	65.5	M				
2004.04-		2008.08	MT	L	F Saloon Engine Z19DTH	GDS21032	Drive Shaft		30	27	53.8	94.5	605					
2004.04-	2008.08	MT	L/R	F Saloon Engine Z19DTH	GC199138	Inner Joint		27	28	35	78	83						



		YEAR	TRANSM	L/R	F/R		G-AP Ref.	PRODUCT	ABS	Technical Specifications						
										A	B	C	H	L	P	
<b>VAUXHALL</b>																
<b>VECTRA II (C)</b>																
1.9 CDTi 16V (110 kW)	2004.04-	2008.08	Semi-AT	L/R	F	Saloon Engine Z19DTH	GDS44080	Drive Shaft		30	27	53.8	94.5	591		
2.0 16V Turbo (129 kW)	2000.01-	2008.10	MT		F	Saloon Engine Z20NET	GC017051	Outer Joint		30	26	53.8	94.5	65.5	M	
	2000.01-	2008.10		L/R	F	Saloon Engine Z20NET	GDS21032	Drive Shaft		30	27	53.8	94.5	605		
	2000.01-	2008.10		L/R	F	Saloon Engine Z20NET	GCI99138	Inner Joint		27	28	35	78	83		
	2000.01-	2008.10				Saloon Engine Z20NET	GC099023	Outer Joint		30	26	53.8	94.5	65.5	M	
	2003.10-	2008.07	MT		F	Estate Engine Z20NET	GC017051	Outer Joint		30	26	53.8	94.5	65.5	M	
	2003.10-	2008.07	MT	L	F	Estate Engine Z20NET	GDS21032	Drive Shaft		30	27	53.8	94.5	605		
	2003.10-	2008.07	MT	L/R	F	Estate Engine Z20NET	GCI99138	Inner Joint		27	28	35	78	83		
	2003.10-	2008.07	MT	R	F	Estate Engine Z20NET	GDS21032	Drive Shaft		30	27	53.8	94.5	605		
2.0 DTi 16V (74 kW)	2003.10-	2008.07				Estate Engine Z20NET	GC099023	Outer Joint		30	26	53.8	94.5	65.5	M	
	2002.04-	2008.10	MT		F	Saloon Engine Y20DTH	GC017007	Outer Joint		30	25	52.5	105	62	O	
	2002.04-	2008.10	MT	R	F	Saloon Engine Y20DTH	GDS21061	Drive Shaft		30	34	52.5	105	968		
	2002.04-	2008.10	MT	R	F	Saloon Engine Y20DTH	GDS60016	Drive Shaft		30	34	52.5	105	588		
	2003.10-	2008.07	MT		F	Estate Engine Y20DTH	GC017007	Outer Joint		30	25	52.5	105	62	O	
	2003.10-	2008.07	MT	R	F	Estate Engine Y20DTH	GDS21061	Drive Shaft		30	34	52.5	105	968		
2.2 16V (108 kW)	2003.10-	2008.07				Estate Engine Y20DTH	GDS60016	Drive Shaft		30	34	52.5	105	588		
2.2 Direct (114 kW)	2002.01-	2008.10	5MT		F	Saloon Engine Z22SE	GC017007	Outer Joint		30	25	52.5	105	62	O	
	2003.10-	2008.07			F	Estate Engine Z22YH	GC017007	Outer Joint		30	25	52.5	105	62	O	
2.2 DTi 16V (92 kW)	2002.04-	2008.10	MT		F	Saloon Engine Y22DTR	GC017051	Outer Joint		30	26	53.8	94.5	65.5	M	
	2002.04-	2008.10	MT	L/R	F	Saloon Engine Y22DTR	GCI99138	Inner Joint		27	28	35	78	83		
	2002.04-	2008.10	MT	L/R	F	Saloon Engine Y22DTR	GDS21032	Drive Shaft		30	27	53.8	94.5	605		
	2002.04-	2008.10				Saloon Engine Y22DTR	GC099023	Outer Joint		30	26	53.8	94.5	65.5	M	
	2003.10-	2008.07	MT		F	Estate Engine Y22DTR	GC017051	Outer Joint		30	26	53.8	94.5	65.5	M	
	2003.10-	2008.07		L/R	F	Estate Engine Y22DTR	GDS21032	Drive Shaft		30	27	53.8	94.5	605		
	2003.10-	2008.07		L/R	F	Estate Engine Y22DTR	GCI99138	Inner Joint		27	28	35	78	83		
	2003.10-	2008.07				Estate Engine Y22DTR	GC099023	Outer Joint		30	26	53.8	94.5	65.5	M	
2.8 V6 Turbo (169 kW)	2005.08-	2008.07			F	Estate Engine Z28NEL	GC021030	Outer Joint		30	28	55.4	96	65	M	
2.8 V6 Turbo (188 kW)	2006.08-	2008.07			F	Estate Engine Z28NET	GC021030	Outer Joint		30	28	55.4	96	65	M	
3.0 CDTi (135 kW)	2005.08-	2008.07				Estate Engine Z30DT	GC099023	Outer Joint		30	26	53.8	94.5	65.5	M	
	2005.08-	2008.07				Saloon Engine Z30DT	GC099023	Outer Joint		30	26	53.8	94.5	65.5	M	
3.0 V6 CDTi (130 kW)	2003.06-	2005.08	MT		F	Saloon Engine Y30DT	GC017051	Outer Joint		30	26	53.8	94.5	65.5	M	
	2003.06-	2005.08		L/R	F	Saloon Engine Y30DT	GDS21032	Drive Shaft		30	27	53.8	94.5	605		
	2003.06-	2005.08		L/R	F	Saloon Engine Y30DT	GCI99138	Inner Joint		27	28	35	78	83		
	2003.06-	2005.08				Saloon Engine Y30DT	GC099023	Outer Joint		30	26	53.8	94.5	65.5	M	
	2003.10-	2005.08	MT		F	Estate Engine Y30DT	GC017051	Outer Joint		30	26	53.8	94.5	65.5	M	
	2003.10-	2005.08		L/R	F	Estate Engine Y30DT	GDS21032	Drive Shaft		30	27	53.8	94.5	605		
	2003.10-	2005.08		L/R	F	Estate Engine Y30DT	GCI99138	Inner Joint		27	28	35	78	83		
	2003.10-	2005.08				Estate Engine Y30DT	GC099023	Outer Joint		30	26	53.8	94.5	65.5	M	
3.2 V6 (155 kW)	2003.06-	2008.07	MT		F	Saloon Engine Z32SE	GC017051	Outer Joint		30	26	53.8	94.5	65.5	M	
	2003.06-	2008.07	MT	L/R	F	Saloon Engine Z32SE	GCI99138	Inner Joint		27	28	35	78	83		
	2003.06-	2008.07	MT	L/R	F	Saloon Engine Z32SE	GDS21032	Drive Shaft		30	27	53.8	94.5	605		
	2003.06-	2008.07				Saloon Engine Z32SE	GC099023	Outer Joint		30	26	53.8	94.5	65.5	M	
	2003.10-	2005.08	MT		F	Estate Engine Z32SE	GC017051	Outer Joint		30	26	53.8	94.5	65.5	M	
	2003.10-	2005.08	MT	L/R	F	Estate Engine Z32SE	GCI99138	Inner Joint		27	28	35	78	83		
	2003.10-	2005.08	MT	L/R	F	Estate Engine Z32SE	GDS21032	Drive Shaft		30	27	53.8	94.5	605		
	2003.10-	2005.08				Estate Engine Z32SE	GC099023	Outer Joint		30	26	53.8	94.5	65.5	M	
<b>VECTRA II (C) GTS</b>																
1.6 (77 kW)	2006.01-	2008.07			F	Hatchback Engine Z16XEP	GC017007	Outer Joint		30	25	52.5	105	62	O	
1.6 16V (74 kW)	2004.06-	2008.07			F	Hatchback Engine Z16XE	GC017007	Outer Joint		30	25	52.5	105	62	O	
1.8 (103 kW)	2006.01-	2008.07			F	Hatchback Engine Z18XER	GC017007	Outer Joint		30	25	52.5	105	62	O	
	2006.01-	2008.07	MT	L	F	Hatchback Engine Z18XER	GDS44020	Drive Shaft		30	22	52.5	105	617.5		
	2006.01-	2008.07	MT	L	F	Hatchback Engine Z18XER	GCI99026	Inner Joint		22	25	35	57	82.5		
	2006.01-	2008.07	MT	L	F	Hatchback Engine Z18XER	GC017007	Outer Joint		30	25	52.5	105	62	O	
	2006.01-	2008.07	MT	R	F	Hatchback Engine Z18XER	GDS17040	Drive Shaft		30	22	52.5	105	987		
	2006.01-	2008.07		R	F	Hatchback Engine Z18XER	GCI99026	Inner Joint		22	25	35	57	82.5		
	2006.01-	2008.07		R	F	Hatchback Engine Z18XER	GC017007	Outer Joint		30	25	52.5	105	62	O	
1.8 16V (90 kW)	2002.08-	2008.07			F	Hatchback Engine Z18XE	GC017007	Outer Joint		30	25	52.5	105	62	O	
	2002.08-	2008.07	MT	L	F	Hatchback Engine Z18XE	GDS44020	Drive Shaft		30	22	52.5	105	617.5		
	2002.08-	2008.07	MT	L	F	Hatchback Engine Z18XE	GCI99026	Inner Joint		22	25	35	57	82.5		
	2002.08-	2008.07	MT	L	F	Hatchback Engine Z18XE	GC017007	Outer Joint		30	25	52.5	105	62	O	





		YEAR	TRANSM	L/R	F/R		G-AP Ref.	PRODUCT	ABS	Technical Specifications										
										A	B	C	H	L	P					
<b>VAUXHALL VECTRA II (C) GTS</b>																				
1.8 16V (90 kW)	2002.08-	2008.07	MT	R	F	Hatchback Engine Z18XE	GDS17040	Drive Shaft		30	22	52.5	105	987						
	2002.08-	2008.07		R	F	Hatchback Engine Z18XE	GCI99026	Inner Joint		22	25	35	57	82.5						
	2002.08-	2008.07		R	F	Hatchback Engine Z18XE	GC017007	Outer Joint		30	25	52.5	105	62	O					
1.8 16V Dualfuel (90 kW)	2002.08-	2008.07			F	Hatchback Engine Z18XE	GC017007	Outer Joint		30	25	52.5	105	62	O					
	2002.08-	2008.07	MT	L	F	Hatchback Engine Z18XE	GDS44020	Drive Shaft		30	22	52.5	105	617.5						
	2002.08-	2008.07	MT	L/R	F	Hatchback Engine Z18XE	GCI99026	Inner Joint		22	25	35	57	82.5						
	2002.08-	2008.07	MT	L/R	F	Hatchback Engine Z18XE	GC017007	Outer Joint		30	25	52.5	105	62	O					
	2002.08-	2008.07	MT	R	F	Hatchback Engine Z18XE	GDS17040	Drive Shaft		30	22	52.5	105	987						
	2002.08-	2008.07	MT	R	F	Hatchback Engine Z18XE	GDS17040	Drive Shaft		30	22	52.5	105	987						
1.9 CDTi (74 kW)	2005.10-	2008.07	MT/AT		F	Hatchback Engine Z19DTL	GC017051	Outer Joint		30	26	53.8	94.5	65.5	M					
	2005.10-	2008.07	MT	L	F	Hatchback Engine Z19DTL	GDS21032	Drive Shaft		30	27	53.8	94.5	605						
	2005.10-	2008.07	MT	L/R	F	Hatchback Engine Z19DTL	GCI99138	Inner Joint		27	28	35	78	83						
	2005.10-	2008.07	MT	R	F	Hatchback Engine Z19DTL	GDS21032	Drive Shaft		30	27	53.8	94.5	605						
1.9 CDTi (88 kW)	2002.08-	2008.07	MT		F	Hatchback Engine Z19DT	GC017051	Outer Joint		30	26	53.8	94.5	65.5	M					
	2002.08-	2008.07	MT	L	F	Hatchback Engine Z19DT	GDS21092	Drive Shaft		30	25	53.8	94.5	604						
	2002.08-	2008.07	MT	L	F	Hatchback Engine Z19DT	GDS21032	Drive Shaft		30	27	53.8	94.5	605						
	2002.08-	2008.07	MT	L/R	F	Hatchback Engine Z19DT	GCI99138	Inner Joint		27	28	35	78	83						
	2002.08-	2008.07	MT	R	F	Hatchback Engine Z19DT	GDS21053	Drive Shaft		30	34	53.8	94.5	617						
	2002.08-	2008.07	MT	R	F	Hatchback Engine Z19DT	GDS21032	Drive Shaft		30	27	53.8	94.5	605						
	2002.08-	2008.07				Hatchback Engine Z19DT	GC099023	Outer Joint		30	26	53.8	94.5	65.5	M					
1.9 CDTi 16V (110 kW)	2004.04-	2008.07	MT/AT		F	Hatchback Engine Z19DTH	GC017051	Outer Joint		30	26	53.8	94.5	65.5	M					
	2004.04-	2008.07	MT	L	F	Hatchback Engine Z19DTH	GDS21032	Drive Shaft		30	27	53.8	94.5	605						
	2004.04-	2008.07	MT	L/R	F	Hatchback Engine Z19DTH	GCI99138	Inner Joint		27	28	35	78	83						
	2004.04-	2008.07	Semi-AT	L/R	F	Hatchback Engine Z19DTH	GDS44080	Drive Shaft		30	27	53.8	94.5	591						
	2004.04-	2008.07	MT	R	F	Hatchback Engine Z19DTH	GDS21032	Drive Shaft		30	27	53.8	94.5	605						
	2004.04-	2008.07				Hatchback Engine Z19DTH	GC099023	Outer Joint		30	26	53.8	94.5	65.5	M					
2.0 16V Turbo (129 kW)	2003.03-	2008.07	MT		F	Hatchback Engine Z20NET	GC017051	Outer Joint		30	26	53.8	94.5	65.5	M					
	2003.03-	2008.07	MT	L/R	F	Hatchback Engine Z20NET	GCI99138	Inner Joint		27	28	35	78	83						
	2003.03-	2008.07	MT	L/R	F	Hatchback Engine Z20NET	GDS21032	Drive Shaft		30	27	53.8	94.5	605						
	2003.03-	2008.07				Hatchback Engine Z20NET	GC099023	Outer Joint		30	26	53.8	94.5	65.5	M					
2.0 DTi 16V (74 kW)	2002.08-	2008.07	MT		F	Hatchback Engine Y20DTH	GC017007	Outer Joint		30	25	52.5	105	62	O					
2.2 16V (108 kW)	2002.08-	2008.07	5MT		F	Hatchback Engine Z22SE	GC017007	Outer Joint		30	25	52.5	105	62	O					
2.2 Direct (114 kW)	2003.10-	2005.08			F	Hatchback Engine Z22YH	GC017007	Outer Joint		30	25	52.5	105	62	O					
2.2 DTi 16V (92 kW)	2002.08-	2008.07	MT		F	Hatchback Engine Y22DTR	GC017051	Outer Joint		30	26	53.8	94.5	65.5	M					
	2002.08-	2008.07	MT	L/R	F	Hatchback Engine Y22DTR	GCI99138	Inner Joint		27	28	35	78	83						
	2002.08-	2008.07	MT	L/R	F	Hatchback Engine Y22DTR	GDS21032	Drive Shaft		30	27	53.8	94.5	605						
	2002.08-	2008.07				Hatchback Engine Y22DTR	GC099023	Outer Joint		30	26	53.8	94.5	65.5	M					
2.8 V6 Turbo (169 kW)	2005.08-	2008.07			F	Hatchback Engine Z28NEL	GC021030	Outer Joint		30	28	55.4	96	65	M					
2.8 V6 Turbo (188 kW)	2005.08-	2008.07			F	Hatchback Engine Z28NET	GC021030	Outer Joint		30	28	55.4	96	65	M					
3.0 CDTi (135 kW)	2005.08-	2008.07				Hatchback Engine Z30DT	GC099023	Outer Joint		30	26	53.8	94.5	65.5	M					
3.0 V6 CDTi (130 kW)	2003.06-	2005.08	MT		F	Hatchback Engine Y30DT	GC017051	Outer Joint		30	26	53.8	94.5	65.5	M					
	2003.06-	2005.08		L/R	F	Hatchback Engine Y30DT	GDS21032	Drive Shaft		30	27	53.8	94.5	605						
	2003.06-	2005.08		L/R	F	Hatchback Engine Y30DT	GCI99138	Inner Joint		27	28	35	78	83						
	2003.06-	2005.08				Hatchback Engine Y30DT	GC099023	Outer Joint		30	26	53.8	94.5	65.5	M					
3.2 V6 (155 kW)	2002.08-	2008.07	MT		F	Hatchback Engine Z32SE	GC017051	Outer Joint		30	26	53.8	94.5	65.5	M					
	2002.08-	2008.07	MT	L/R	F	Hatchback Engine Z32SE	GCI99138	Inner Joint		27	28	35	78	83						
	2002.08-	2008.07	MT	L/R	F	Hatchback Engine Z32SE	GDS21032	Drive Shaft		30	27	53.8	94.5	605						
	2002.08-	2008.07				Hatchback Engine Z32SE	GC099023	Outer Joint		30	26	53.8	94.5	65.5	M					
<b>VIVARO (E7)</b>																				
2.5 CDTi (107 kW)	2006.08-			R	F	Platform/Chassis Engine G9U630	GDS18301	Drive Shaft		27	39	56.6	94	1045						
	2006.08-			R	F	Platform/Chassis Engine G9U730	GDS18301	Drive Shaft		27	39	56.6	94	1045						
	2006.08-			L	F	Platform/Chassis Engine G9U630	GDS50557	Drive Shaft		27	37.1	56.5	92	634						
	2006.08-			L	F	Platform/Chassis Engine G9U730	GDS50557	Drive Shaft		27	37.1	56.5	92	634						
	2006.08-			R	F	Platform/Chassis Engine G9U630	GDS50562	Drive Shaft		27	39	56.5	92	1056						
	2006.08-			R	F	Platform/Chassis Engine G9U630	GCI50097	Inner Joint		39	35	30	409	90						
	2006.08-			R	F	Platform/Chassis Engine G9U630	GC050080	Outer Joint		27	37	56.5	92	73	I					
	2006.08-			R	F	Platform/Chassis Engine G9U730	GDS50562	Drive Shaft		27	39	56.5	92	1056						
	2006.08-			R	F	Platform/Chassis Engine G9U730	GCI50097	Inner Joint		39	35	30	409	90						
2.5 CDTi (99 kW)	2003.04-	2006.07		L	F	Platform/Chassis Engine G9U630/G9U730	GDS50557	Drive Shaft		27	37.1	56.5	92	634						
	2003.04-	2006.07		R	F	Platform/Chassis Engine G9U630/G9U730	GDS50562	Drive Shaft		27	39	56.5	92	1056						
	2003.04-	2006.07		R	F	Platform/Chassis Engine G9U630/G9U730	GCI50097	Inner Joint		39	35	30	409	90						









		TRANSM	L/R	F/R		G-AP Ref.	PRODUCT	ABS	Technical Specifications									
									YEAR	A	B	C	H	L	P			
<b>VAUXHALL</b>																		
<b>VIVARO (E7)</b>																		
2.5 CDTi (99 kW)	2003.04-	2006.07		R	F	Platform/Chassis Engine G9U630/G9U730	GC050080	Outer Joint		27	37	56.5	92	73	I			
<b>VIVARO (F7)</b>																		
1.9 Di (59 kW)	2001.08-	2006.12			F	Box Engine F9Q762	GC018105	Outer Joint		27	26	56.5	93.5	64	M			
	2001.08-	2006.12		L	F	Box Engine F9Q762	GDS44003	Drive Shaft		27	37.1	56.5	93.5	676				
	2001.08-	2006.12		R	F	Box Engine F9Q762	GDS44013	Drive Shaft		27	39	56.5	93.5	1020				
1.9 DTi (74 kW)	2001.08-	2006.12			F	Box Engine F9Q760	GC018105	Outer Joint		27	26	56.5	93.5	64	M			
	2001.08-	2006.12		L	F	Box Engine F9Q760	GDS44003	Drive Shaft		27	37.1	56.5	93.5	676				
	2001.08-	2006.12		R	F	Box Engine F9Q760	GDS44013	Drive Shaft		27	39	56.5	93.5	1020				
2.0 16V (88 kW)	2001.08-	2006.12			F	Box Engine F4R720	GC018105	Outer Joint		27	26	56.5	93.5	64	M			
	2001.08-	2006.12		L	F	Box Engine F4R720	GDS44003	Drive Shaft		27	37.1	56.5	93.5	676				
	2001.08-	2006.12		R	F	Box Engine F4R720	GDS44013	Drive Shaft		27	39	56.5	93.5	1020				
2.5 CDTi (107 kW)	2006.08-			R	F	Box Engine G9U630	GDS18301	Drive Shaft		27	39	56.6	94	1045				
	2006.08-			L	F	Box Engine G9U630	GDS50557	Drive Shaft		27	37.1	56.5	92	634				
	2006.08-			R	F	Box Engine G9U630	GDS50562	Drive Shaft		27	39	56.5	92	1056				
	2006.08-			R	F	Box Engine G9U630	GCI50097	Inner Joint		39	35	30	409	90				
	2006.08-			R	F	Box Engine G9U630	GC050080	Outer Joint		27	37	56.5	92	73	I			
2.5 DTi (99 kW)	2004.04-				F	Box Engine G9U730/G9U630	GC018105	Outer Joint		27	26	56.5	93.5	64	M			
	2004.04-			L	F	Box Engine G9U730/G9U630	GDS50557	Drive Shaft		27	37.1	56.5	92	634				
	2004.04-			R	F	Box Engine G9U730/G9U630	GDS50562	Drive Shaft		27	39	56.5	92	1056				
	2004.04-			R	F	Box Engine G9U730/G9U630	GCI50097	Inner Joint		39	35	30	409	90				
	2004.04-			R	F	Box Engine G9U730/G9U630	GC050080	Outer Joint		27	37	56.5	92	73	I			
<b>VIVARO (J7)</b>																		
1.9 Di (59 kW)	2001.08-	2006.12			F	Bus Engine F9Q762	GC018105	Outer Joint		27	26	56.5	93.5	64	M			
	2001.08-	2006.12		L	F	Bus Engine F9Q762	GDS44003	Drive Shaft		27	37.1	56.5	93.5	676				
	2001.08-	2006.12		R	F	Bus Engine F9Q762	GDS44013	Drive Shaft		27	39	56.5	93.5	1020				
1.9 DTi (74 kW)	2001.08-	2006.12			F	Bus Engine F9Q760	GC018105	Outer Joint		27	26	56.5	93.5	64	M			
	2001.08-	2006.12		L	F	Bus Engine F9Q760	GDS44003	Drive Shaft		27	37.1	56.5	93.5	676				
	2001.08-	2006.12		R	F	Bus Engine F9Q760	GDS44013	Drive Shaft		27	39	56.5	93.5	1020				
2.0 16V (88 kW)	2001.08-	2006.12			F	Bus Engine F4R720	GC018105	Outer Joint		27	26	56.5	93.5	64	M			
	2001.08-	2006.12		L	F	Bus Engine F4R720	GDS44003	Drive Shaft		27	37.1	56.5	93.5	676				
	2001.08-	2006.12		R	F	Bus Engine F4R720	GDS44013	Drive Shaft		27	39	56.5	93.5	1020				
2.5 CDTi (107 kW)	2006.01-			R	F	Bus Engine G9U630	GDS18301	Drive Shaft		27	39	56.6	94	1045				
	2006.01-			L	F	Bus Engine G9U630	GDS50557	Drive Shaft		27	37.1	56.5	92	634				
	2006.01-			R	F	Bus Engine G9U630	GDS50562	Drive Shaft		27	39	56.5	92	1056				
	2006.01-			R	F	Bus Engine G9U630	GCI50097	Inner Joint		39	35	30	409	90				
	2006.01-			R	F	Bus Engine G9U630	GC050080	Outer Joint		27	37	56.5	92	73	I			
2.5 DTi (99 kW)	2004.04-				F	Bus Engine G9U730/G9U630	GC018105	Outer Joint		27	26	56.5	93.5	64	M			
	2004.04-			L	F	Bus Engine G9U730/G9U630	GDS50557	Drive Shaft		27	37.1	56.5	92	634				
	2004.04-			R	F	Bus Engine G9U730/G9U630	GDS50562	Drive Shaft		27	39	56.5	92	1056				
	2004.04-			R	F	Bus Engine G9U730/G9U630	GCI50097	Inner Joint		39	35	30	409	90				
	2004.04-			R	F	Bus Engine G9U730/G9U630	GC050080	Outer Joint		27	37	56.5	92	73	I			
<b>VX220</b>																		
2.0 i Turbo (147 kW)	2001.03-	2005.07	MT	L	F	Convertible Engine Z20LET	GDS44025	Drive Shaft		33	34	55	104	593				
	2001.03-	2005.07	MT	L	F	Convertible Engine Z20LET	GCI44018	Inner Joint		34	35	35	56	119.5				
	2001.03-	2005.07	MT	L	F	Convertible Engine Z20LET	GC099061	Outer Joint		33	35	55	104	67.5	I			
	2001.03-	2005.07	MT	R	F	Convertible Engine Z20LET	GDS44082	Drive Shaft		33	34	55	104	663				
2.2 i (108 kW)	2000.09-	2005.07	MT	L	F	Convertible Engine Z22SE	GDS44025	Drive Shaft		33	34	55	104	593				
	2000.09-	2005.07	MT	L	F	Convertible Engine Z22SE	GCI44018	Inner Joint		34	35	35	56	119.5				
	2000.09-	2005.07	MT	L	F	Convertible Engine Z22SE	GC099061	Outer Joint		33	35	55	104	67.5	I			
	2000.09-	2005.07	MT	R	F	Convertible Engine Z22SE	GDS44082	Drive Shaft		33	34	55	104	663				
<b>ZAFIRA A (F75)</b>																		
1.6 16V (55 kW)	1999.04-	2005.06				Engine X16XEL	GC044006	Outer Joint	29T	33	25	52	103.5	61	O			
	1999.04-	2005.06					GCI21014	Inner Joint		22	22	35	57.5	75				
1.6 16V (74 kW)	1999.04-	2005.06				Engine X16XEL	GC044006	Outer Joint	29T	33	25	52	103.5	61	O			
	1999.04-	2005.06					GCI21014	Inner Joint		22	22	35	57.5	75				
1.6 CNG (71 kW)	2001.09-	2005.06					GC044006	Outer Joint	29T	33	25	52	103.5	61	O			
1.8 16V (85 kW)	1999.04-	2005.06					GCI99026	Inner Joint		22	25	35	57	82.5				
	1999.04-	2005.06					GC044006	Outer Joint	29T	33	25	52	103.5	61	O			
1.8 16V (92 kW)	1999.04-	2005.06					GCI99026	Inner Joint		22	25	35	57	82.5				
	1999.04-	2005.06					GC044006	Outer Joint	29T	33	25	52	103.5	61	O			
2.0 Di 16V (60 kW)	1999.10-	2005.06					GC044006	Outer Joint	29T	33	25	52	103.5	61	O			



		TRANSM	L/R	F/R		G-AP Ref.	PRODUCT	ABS	Technical Specifications									
									YEAR	A	B	C	H	L	P			
<b>VAUXHALL</b>																		
<b>ZAFIRA A (F75)</b>																		
2.0 Di 16V (60 kW)	1999.10-	2005.06				GCI21011	Inner Joint		34	25	35	78	64					
2.0 DTi 16V (74 kW)	2000.09-	2005.06				GCI21011	Inner Joint		34	25	35	78	64					
	2000.09-	2005.06				GC044006	Outer Joint	29T	33	25	52	103.5	61	O				
2.2 16V (108 kW)	2000.09-	2005.06				GCI21011	Inner Joint		34	25	35	78	64					
	2000.09-	2005.06				GC044006	Outer Joint	29T	33	25	52	103.5	61	O				
<b>ZAFIRA B</b>																		
1.6 (110 kW)	2006.01-					GCI21014	Inner Joint		22	22	35	57.5	75					
	2006.01-					GC044003	Outer Joint		33	22	53	95	54.5	M				
1.6 (69 kW)	2006.01-					GCI21014	Inner Joint		22	22	35	57.5	75					
	2006.01-					GC044003	Outer Joint		33	22	53	95	54.5	M				
1.6 (77 kW)	2006.01-					GCI21014	Inner Joint		22	22	35	57.5	75					
	2006.01-					GC044003	Outer Joint		33	22	53	95	54.5	M				
1.6 (85 kW)	2006.01-					GCI21014	Inner Joint		22	22	35	57.5	75					
	2006.01-					GC044003	Outer Joint		33	22	53	95	54.5	M				
1.7 CDTi 16V (81 kW)	2008.01-					GC044027	Outer Joint		33	26	52.5	94	65.5	M				
1.7 CDTi 16V (92 kW)	2008.01-					GC044027	Outer Joint		33	26	52.5	94	65.5	M				
1.8 16V (103 kW)	2005.07-					GC044028	Outer Joint		33	24	53	93.5	63.5	M				
1.9 CDTi (74 kW)	2005.07-					GC044027	Outer Joint		33	26	52.5	94	65.5	M				
1.9 CDTi (88 kW)	2005.07-					GC044027	Outer Joint		33	26	52.5	94	65.5	M				
2.0 T 16V (147 kW)	2005.07-					GC044027	Outer Joint		33	26	52.5	94	65.5	M				
2.2 (110 kW)	2005.07-					GC044028	Outer Joint		33	24	53	93.5	63.5	M				
<b>ZAFIRA I (A) (F75)</b>																		
1.6 16V (74 kW)	1999.04-	2005.08	5MT		F	MPV Engine X16XEL/Z16XE	GC044049	Outer Joint		33	25	52	109	61	O			
	1999.04-	2005.08	MT/AT		F	MPV Engine X16XEL/Z16XE	GC044006	Outer Joint	29T	33	25	52	103.5	61	O			
	1999.04-	2005.08	MT	R	F	MPV Engine X16XEL/Z16XE	GDS60035	Drive Shaft		33	22	52	109	961				
1.6 Dualfuel (74 kW)	1998.11-	2005.08	MT	R	F	MPV Engine X16XEL/Z16XE	GDS60035	Drive Shaft		33	22	52	109	961				
1.8 16V (92 kW)	2000.09-	2005.08			F	MPV Engine Z18XE	GC044049	Outer Joint		33	25	52	109	61	O			
	2000.09-	2005.08	MT	R	F	MPV Engine Z18XE	GDS60035	Drive Shaft		33	22	52	109	961				
1.8 Dualfuel (92 kW)	2000.09-	2005.08			R	F	MPV Engine Z18XE	GDS60035	Drive Shaft		33	22	52	109	961			
2.0 (147 kW)	2002.06-	2005.06	MT	L	F	MPV Engine Z20LET	GDS44025	Drive Shaft		33	34	55	104	593				
	2002.06-	2005.06	MT	L	F	MPV Engine Z20LET	GCI44018	Inner Joint		34	35	55	119.5					
	2002.06-	2005.06	MT	L	F	MPV Engine Z20LET	GC099061	Outer Joint		33	35	55	104	67.5	I			
	2002.06-	2005.06	MT	R	F	MPV Engine Z20LET	GDS44082	Drive Shaft		33	34	55	104	663				
2.0 Di 16V (60 kW)	1999.10-	2005.08	5MT		F	MPV Engine X20DTL	GC044049	Outer Joint		33	25	52	109	61	O			
	1999.10-	2005.08	MT/AT		F	MPV Engine X20DTL	GC044006	Outer Joint	29T	33	25	52	103.5	61	O			
	1999.10-	2005.08	MT	L	F	MPV Engine X20DTL	GDS44044	Drive Shaft		33	34	52	103.5	595				
2.0 DTi 16V (74 kW)	1999.04-	2005.08			F	MPV Engine Y20DTH	GC044049	Outer Joint		33	25	52	109	61	O			
	1999.04-	2005.08	MT/AT		F	MPV Engine Y20DTH	GC044006	Outer Joint	29T	33	25	52	103.5	61	O			
	1999.04-	2005.08	MT	L	F	MPV Engine Y20DTH	GDS44044	Drive Shaft		33	34	52	103.5	595				
2.0 GSi Turbo (141 kW)	2001.09-	2005.06	MT	L	F	MPV Engine Z20LET	GDS44025	Drive Shaft		33	34	55	104	593				
	2001.09-	2005.06	MT	L	F	MPV Engine Z20LET	GCI44018	Inner Joint		34	35	55	119.5					
	2001.09-	2005.06	MT	L	F	MPV Engine Z20LET	GC099061	Outer Joint		33	35	55	104	67.5	I			
	2001.09-	2005.06	MT	R	F	MPV Engine Z20LET	GDS44082	Drive Shaft		33	34	55	104	663				
2.2 16V (108 kW)	1998.11-	2004.08	5MT		F	MPV Engine Z22SE	GC044049	Outer Joint		33	25	52	109	61	O			
	1998.11-	2004.08	MT	L	F	MPV Engine Z22SE	GDS44044	Drive Shaft		33	34	52	103.5	595				
<b>ZAFIRA II (B) (M75)</b>																		
1.6 (77 kW)	2005.07-		MT		F	MPV Engine Z16XEP	GC044003	Outer Joint		33	22	53	95	54.5	M			
	2005.07-		MT	L	F	MPV Engine Z16XEP	GDS44028	Drive Shaft		33	22	53	95	590				
	2005.07-		MT	R	F	MPV Engine Z16XEP	GDS44030	Drive Shaft		33	22	53	95	952				
	2005.07-		MT	L	F	MPV Engine Z16XEP	GCI21014	Inner Joint		22	22	35	57.5	75				
	2005.07-		MT	R	F	MPV Engine Z16XEP	GCI21014	Inner Joint		22	22	35	57.5	75				
1.7 CDTi (81 kW)	2009.04-				L	F	MPV Engine Z17DTJ/A17DTJ	GDS21051	Drive Shaft		33	25	52.5	94	579			
	2009.04-		MT				MPV Engine Z17DTJ/A17DTJ	GC099024	Outer Joint		33	26	52.5	94	65.5	M		
1.7 CDTi (92 kW)	2008.01-				L	F	MPV Engine A17DTR	GDS21051	Drive Shaft		33	25	52.5	94	579			
	2008.01-						MPV Engine A17DTR	GC099024	Outer Joint		33	26	52.5	94	65.5	M		
1.8 (103 kW)	2005.04-				L	F	MPV Engine A18XER/Z18XER	GDS21063	Drive Shaft		33	22	53	93.5	586			
	2005.04-				R	F	MPV Engine A18XER/Z18XER	GDS21055	Drive Shaft		33	22	53	93.5	950			
1.9 CDTi (110 kW)	2005.07-		MT	L	F	MPV Engine Z19DTH	GDS21071	Drive Shaft		30	25	53.8	94.5	576				
	2005.07-		MT	R	F	MPV Engine Z19DTH	GDS21062	Drive Shaft		30	34	53.8	94.5	595				
	2005.07-						MPV Engine Z19DTH	GC099023	Outer Joint		30	26	53.8	94.5	65.5	M		
1.9 CDTi (74 kW)	2005.07-		MT	R	F	MPV Engine Z19DTL	GDS21056	Drive Shaft		33	34	52.5	94	595				

		YEAR	TRANSM	L/R	F/R		G-AP Ref.	PRODUCT	ABS	Technical Specifications						
										A	B	C	H	L	P	
<b>VAUXHALL</b>																
<b>ZAFIRA II (B) (M75)</b>																
1.9 CDTi (74 kW)	2005.07-		MT	R	F	MPV Engine Z19DTL	GDS21062	Drive Shaft		30	34	53.8	94.5	595		
	2005.07-		MT	L	F	MPV Engine Z19DTL	GDS21051	Drive Shaft		33	25	52.5	94	579		
	2005.07-					MPV Engine Z19DTL	GC099024	Outer Joint		33	26	52.5	94	65.5	M	
1.9 CDTi (88 kW)	2005.07-				F	MPV Engine Z19DT	GC044027	Outer Joint		33	26	52.5	94	65.5	M	
	2005.07-		MT	R	F	MPV Engine Z19DT	GDS21056	Drive Shaft		33	34	52.5	94	595		
	2005.07-		MT	L	F	MPV Engine Z19DT	GDS21051	Drive Shaft		33	25	52.5	94	579		
	2005.07-					MPV Engine Z19DT	GC099024	Outer Joint		33	26	52.5	94	65.5	M	
2.0 (147 kW)	2005.07-					MPV Engine Z20LER	GC099024	Outer Joint		33	26	52.5	94	65.5	M	
2.0 (176 kW)	2006.01-			R	F	MPV Engine Z20LEH	GDS21062	Drive Shaft		30	34	53.8	94.5	595		
	2006.01-		MT		F	MPV Engine Z20LEH	GC099023	Outer Joint		30	26	53.8	94.5	65.5	M	
2.2 (110 kW)	2005.07-		MT	R	F	MPV Engine Z22YH	GDS44051	Drive Shaft		33	34	53	93.5	570		
	2005.07-		MT	R	F	MPV Engine Z22YH	GCI44011	Inner Joint		34	25	37.5	46	55		
	2005.07-		MT	R	F	MPV Engine Z22YH	GC044028	Outer Joint		33	24	53	93.5	63.5	M	
<b>ZAFIRA III (P12)</b>																
2.0 CDTi (118 kW)	2011.10-		MT	L	F	MPV Engine A20DTH	GDS60027	Drive Shaft		30	27	52.5	94.5	619		
2.0 CDTi (121 kW)	2011.10-		MT	L	F	MPV Engine A20DTH	GDS60027	Drive Shaft		30	27	52.5	94.5	619		
2.0 CDTi (81 kW)	2011.10-			L	F	MPV Engine A20DTL	GDS60027	Drive Shaft		30	27	52.5	94.5	619		
2.0 CDTi (96 kW)	2011.10-		MT	L	F	MPV Engine A20DT/Y20DTJ/Z20DTJ	GDS60027	Drive Shaft		30	27	52.5	94.5	619		
<b>ZAFIRA MK II (B) (M75)</b>																
1.8 (88 kW)	2013.04	2014.11	MT	L	F	MPV Engine A 18 XEL	GDS21063	Drive Shaft		33	22	53	93.5	586		
<b>ZAFIRA MK III (P12)</b>																
1.6 CDTi (100 kW)	2013.03-		MT	L	F	MPV Engine B 16 DTH	GDS60027	Drive Shaft		30	27	52.5	94.5	619		
2.0 BiTurbo CDTi (143 kW)	2013.01-		MT	L	F	MPV Engine A 20 DTR	GDS60027	Drive Shaft		30	27	52.5	94.5	619		
2.0 CDTi (125 kW)	2015.01-		MT	R	F	MPV Engine B 20 DTH	GDS60027	Drive Shaft		30	27	52.5	94.5	619		
<b>VAUXHALL LCV</b>																
<b>ASTRA G VAN (F70)</b>																
1.7 DTi (55 kW)	2001-	2004					GC044006	Outer Joint	29T	33	25	52	103.5	61	O	
2.0 Di 16V (60 kW)	1999.01-	2005.04					GC044006	Outer Joint	29T	33	25	52	103.5	61	O	
2.0 DTi (74 kW)	1999-	2004					GC044006	Outer Joint	29T	33	25	52	103.5	61	O	
<b>ASTRA H VAN</b>																
1.4 16V (66 kW)	2004-						GC044003	Outer Joint		33	22	53	95	54.5	M	
1.6 16V (76 kW)	2005-						GC044003	Outer Joint		33	22	53	95	54.5	M	
1.7 CDTi (59 kW)	2005-	2006					GC044028	Outer Joint		33	24	53	93.5	63.5	M	
1.7 CDTi (74 kW)	2005-	2006					GC044028	Outer Joint		33	24	53	93.5	63.5	M	
1.7 CDTi (81 kW)	2007-						GC044027	Outer Joint		33	26	52.5	94	65.5	M	
<b>ASTRA III VAN</b>																
1.4	1991.11-	1998.10	MT	L	F		GDS60010	Drive Shaft		22	22	52.2	97	587		
<b>ASTRAMAX</b>																
1.4 i/1.6	1991.10-	1994.02	MT	L	F		GDS60010	Drive Shaft		22	22	52.2	97	587		
<b>COMBO I</b>																
1.4/1.7 TD	1993.10-	2001.09	MT	L	F		GDS60007	Drive Shaft		22	22	52	97	563		
<b>COMBO II</b>																
1.3 CDTi 16V (51 kW)	2004-						GC044002	Outer Joint	29T	22	23	52	97.5	61	M	
1.7 Di 16V (48 kW)	2001.10-						GC044002	Outer Joint	29T	22	23	52	97.5	61	M	
1.7 DTi 16V (55 kW)	2001.10-						GC044002	Outer Joint	29T	22	23	52	97.5	61	M	
<b>CORSA C VAN (F08, W5L)</b>																
1.2 (59 kW)	2005.07-						GC060001	Outer Joint		22	28	52	97.5	54.5	O	
1.2 16V (55 kW)	2000.09-						GC060001	Outer Joint		22	28	52	97.5	54.5	O	
1.4 (66 kW)	2003.08-						GC060001	Outer Joint		22	28	52	97.5	54.5	O	
1.7 CDTi (74 kW)	2003.08-						GC044004	Outer Joint	29T	33	24	52	104	64	M	
<b>CORSA I VAN</b>																
1.4/1.7 D	1994.02-	2001.02	MT	L	F		GDS60007	Drive Shaft		22	22	52	97	563		
<b>CORSA VAN II</b>																
1.2	2001.03-						GC060001	Outer Joint		22	28	52	97.5	54.5	O	
<b>MOVANO I (J9)</b>																
1.9 DTi (59 kW)	2001.10-	2010					GC044026	Outer Joint	51T	28	36	65	96	71	I	
1.9 DTi (60 kW)	2001.10-	2010					GC044026	Outer Joint	51T	28	36	65	96	71	I	
2.2 DTi (66 kW)	2000.09-	2010					GC044026	Outer Joint	51T	28	36	65	96	71	I	
2.5 CDTi (107 kW)	2006.08-	2010					GC044026	Outer Joint	51T	28	36	65	96	71	I	
2.5 CDTi (74 kW)	2006.08-	2010					GC044026	Outer Joint	51T	28	36	65	96	71	I	









		TRANSM	L/R	F/R		G-AP Ref.	PRODUCT	ABS	Technical Specifications								
									YEAR	A	B	C	H	L	P		
<b>VAUXHALL LCV</b>																	
<b>MOVANO I (J9)</b>																	
2.5 CDTi (88 kW)	2006.08-	2010				GC044026	Outer Joint	51T	28	36	65	96	71	I			
2.5 DTi (73 kW)	2001.10-	2010				GC044026	Outer Joint	51T	28	36	65	96	71	I			
2.5 DTi (84 kW)	2001.10-	2010				GC044026	Outer Joint	51T	28	36	65	96	71	I			
2.8 DTi (84 kW)	1998.07-	2001.10				GC044026	Outer Joint	51T	28	36	65	96	71	I			
3.0 CDTi (100 kW)	2003.10-	2010				GC044026	Outer Joint	51T	28	36	65	96	71	I			
<b>ZAFIRA VAN</b>																	
1.7 CDTi (81 kW)	2008-					GC044027	Outer Joint		33	26	52.5	94	65.5	M			
1.7 CDTi (92 kW)	2008-					GC044027	Outer Joint		33	26	52.5	94	65.5	M			
1.8 (103 kW)	2005.07-					GC044028	Outer Joint		33	24	53	93.5	63.5	M			
<b>VOLKSWAGEN</b>																	
<b>1500,1600</b>																	
-	1964-	1973		L/R		GDS61031	Drive Shaft					32	416.5				
<b>A2 (820)</b>																	
1.2 TDi (45 kW)	2001.03-	2005.08				GC099268	Outer Joint		20	26	43	56	45	M			
<b>AMAROK</b>																	
2.0 BiTDi 4motion (120 kW)	2010.09-		MT/AT	L/R	F	Pickup Engine CDCA	GDS61173	Drive Shaft	28		64.8	44.5	465.96				
	2010.09-		MT/AT	L/R	F	Pickup Engine CDCA	GCI99148	Inner Joint		28		34					
	2010.09-		MT/AT	L/R	F	Pickup Engine CDCA	GC061062	Outer Joint	28	27	64.8	44.5	66.5	M			
2.0 BiTDi 4motion (132 kW)	2011.11-		MT/AT	L/R	F	Pickup Engine CNEA/CSHA	GDS61173	Drive Shaft	28		64.8	44.5	465.96				
	2011.11-		MT/AT	L/R	F	Pickup Engine CNEA/CSHA	GCI99148	Inner Joint		28		34					
	2011.11-		MT/AT	L/R	F	Pickup Engine CNEA/CSHA	GC061062	Outer Joint	28	27	64.8	44.5	66.5	M			
2.0 TDi 4motion (103 kW)	2012.06-		MT	L/R	F	Pickup Engine CNFB	GCI99148	Inner Joint		28		34					
	2012.06-		MT	L/R	F	Pickup Engine CNFB	GC061062	Outer Joint	28	27	64.8	44.5	66.5	M			
2.0 TDi 4motion (90 kW)	2010.09-		MT/AT	L/R	F	Pickup Engine CDBA/CNFA	GDS61173	Drive Shaft	28		64.8	44.5	465.96				
	2010.09-		MT/AT	L/R	F	Pickup Engine CDBA/CNFA	GCI99148	Inner Joint		28		34					
	2010.09-		MT/AT	L/R	F	Pickup Engine CDBA/CNFA	GC061062	Outer Joint	28	27	64.8	44.5	66.5	M			
<b>APOLLO</b>																	
1.8	1990.01-	1992.11	MT				GC018044	Outer Joint		23	30	55	91.5	54.5	I		
<b>BORA (1J2)</b>																	
1.4 16V (55 kW)	2000.03-	2005.05			F	Saloon Engine AHW/AKQ/APE/AXP/BCA	GCI83008	Inner Joint		33		32					
	2000.03-	2005.05	MT		F	Saloon Engine AHW/AKQ/APE/AXP/BCA	GC083033	Outer Joint	36	30	53	78.5	51	I			
	2000.03-	2005.05		L	F	Saloon Engine AHW/AKQ/APE/AXP/BCA	GDS61045	Drive Shaft	36		53	78.5	555				
	2000.03-	2005.05		R	F	Saloon Engine AHW/AKQ/APE/AXP/BCA	GDS83046	Drive Shaft	36		53	78.5	822				
1.6 (74 kW)	1998.10-	2005.05			F	Saloon Engine AEH/AKL/APF	GCI83008	Inner Joint		33		32					
	1998.10-	2005.05	MT		F	Saloon Engine AEH/AKL/APF	GC083033	Outer Joint	36	30	53	78.5	51	I			
	1998.10-	2005.05	MT/AT		F	Saloon Engine AEH/AKL/APF	GCI61006	Inner Joint		30		57.6					
	1998.10-	2005.05	AT	L	F	Saloon Engine AEH/AKL/APF	GDS61156	Drive Shaft	36		53	78	554.5				
	1998.10-	2005.05	AT	L	F	Saloon Engine AEH/AKL/APF	GCI61062	Inner Joint		30		59					
	1998.10-	2005.05	MT	L	F	Saloon Engine AEH/AKL/APF	GDS61045	Drive Shaft	36		53	78.5	555				
1.6 (75 kW)	1998.10-	2005.05	MT	R	F	Saloon Engine AEH/AKL/APF	GDS83046	Drive Shaft	36		53	78.5	822				
	2000.08-	2005.05	4AT		F	Saloon Engine AVU/BFQ	GCI83008	Inner Joint		33		32					
	2000.08-	2005.05	MT/AT		F	Saloon Engine AVU/BFQ	GCI61006	Inner Joint		30		57.6					
	2000.08-	2005.05	AT	L	F	Saloon Engine AVU/BFQ	GDS61156	Drive Shaft	36		53	78	554.5				
	2000.08-	2005.05	AT	L	F	Saloon Engine AVU/BFQ	GCI61062	Inner Joint		30		59					
	2000.08-	2005.05	MT	L	F	Saloon Engine AVU/BFQ	GDS61045	Drive Shaft	36		53	78.5	555				
1.6 16V (77 kW)	2000.08-	2005.05	MT	R	F	Saloon Engine AVU/BFQ	GDS83046	Drive Shaft	36		53	78.5	822				
	2000.05-	2005.05			F	Saloon Engine ATN/AUS/AZD/BCB	GC083036	Outer Joint	36	30	53.2	77.5	61	I			
	2000.05-	2005.05	MT	L	F	Saloon Engine ATN/AUS/AZD/BCB	GDS61202	Drive Shaft	36		53.2	77.5	547				
	2000.05-	2005.05		L	F	Saloon Engine ATN/AUS/AZD/BCB	GDS61312	Drive Shaft	36		53	78	546				
1.8 (92 kW)	2000.05-	2005.05	MT	R	F	Saloon Engine ATN/AUS/AZD/BCB	GDS61203	Drive Shaft	36		53.2	77.5	810				
	1998.10-	2005.05			F	Saloon Engine AGN/BAF	GC083036	Outer Joint	36	30	53.2	77.5	61	I			
	1998.10-	2005.05	MT		F	Saloon Engine AGN/BAF	GCI53002	Inner Joint		33		34					
1.8 4motion (92 kW)	1999.02-	2005.05				Saloon Engine AGN	GC083036	Outer Joint	36	30	53.2	77.5	61	I			
	1999.02-	2005.05	MT			Saloon Engine AGN	GCI53002	Inner Joint		33		34					
	1999.02-	2005.05			F/R	Saloon Engine AGN	GCI83011	Inner Joint		33		34					
1.8 T (110 kW)	2000.05-	2005.05			F	Saloon Engine AGU/ARX/AUM/BAE	GC083036	Outer Joint	36	30	53.2	77.5	61	I			
	2000.05-	2005.05	MT/AT		F	Saloon Engine AGU/ARX/AUM/BAE	GCI61006	Inner Joint		30		57.6					
	2000.05-	2005.05	AT	L	F	Saloon Engine AGU/ARX/AUM/BAE	GDS83374	Drive Shaft	36		53	77.5	521				
	2000.05-	2005.05	MT	L	F	Saloon Engine AGU/ARX/AUM/BAE	GDS61156	Drive Shaft	36		53	78	554.5				
	2000.05-	2005.05	MT	L	F	Saloon Engine AGU/ARX/AUM/BAE	GCI61062	Inner Joint		30		59					



		TRANSM	L/R	F/R		G-AP Ref.	PRODUCT	ABS	Technical Specifications						
									YEAR	A	B	C	H	L	P
<b>VOLKSWAGEN</b>															
<b>BORA (1J2)</b>															
1.8 T (132 kW)	2002.03-	2005.05	MT		F	Saloon Engine AUQ	GC083035	Outer Joint	36	27	53	77.5	65	I	
	2002.03-	2005.05		R	F	Saloon Engine AUQ	GDS61121	Drive Shaft	36		53	77.5	806		
1.9 SDi (50 kW)	1998.10-	2005.05	MT		F	Saloon Engine AGP/AQM	GC083033	Outer Joint	36	30	53	78.5	51	I	
	1998.10-	2005.05		L	F	Saloon Engine AGP/AQM	GDS61045	Drive Shaft	36		53	78.5	555		
	1998.10-	2005.05		R	F	Saloon Engine AGP/AQM	GDS83046	Drive Shaft	36		53	78.5	822		
1.9 TDi (110 kW)	2000.05-	2005.05	MT		F	Saloon Engine ARL	GCI53002	Inner Joint		33		34			
	2000.05-	2005.05	MT		F	Saloon Engine ARL	GC083035	Outer Joint	36	27	53	77.5	65	I	
	2000.05-	2005.05		L	F	Saloon Engine ARL	GDS61123	Drive Shaft	36		53	77.5	520		
	2000.05-	2005.05		R	F	Saloon Engine ARL	GDS61121	Drive Shaft	36		53	77.5	806		
1.9 TDi (74 kW)	2000.09-	2005.05	AT		F	Saloon Engine ATD/AXR	GC083035	Outer Joint	36	27	53	77.5	65	I	
	2000.09-	2005.05	MT		F	Saloon Engine ATD/AXR	GCI83011	Inner Joint		33		34			
	2000.09-	2005.05	MT/AT		F	Saloon Engine ATD/AXR	GC083036	Outer Joint	36	30	53.2	77.5	61	I	
	2000.09-	2005.05	MT/AT		F	Saloon Engine ATD/AXR	GCI61006	Inner Joint		30		57.6			
	2000.09-	2005.05	AT	L	F	Saloon Engine ATD/AXR	GDS83374	Drive Shaft	36		53	77.5	521		
	2000.09-	2005.05	MT	L	F	Saloon Engine ATD/AXR	GDS61021	Drive Shaft	36		53.2	77.5	564.5		
	2000.09-	2005.05	MT	L	F	Saloon Engine ATD/AXR	GDS83006	Drive Shaft	36		53.2	77.5	557		
	2000.09-	2005.05	MT	R	F	Saloon Engine ATD/AXR	GDS83004	Drive Shaft	36		53.2	77.5	822		
1.9 TDi (81 kW)	1998.10-	2001.06	MT	L	F	Saloon Engine AHF/ASV	GDS61021	Drive Shaft	36		53.2	77.5	564.5		
1.9 TDi (85 kW)	1998.12-	2002.01	MT		F	Saloon Engine AJM/AUY	GCI53002	Inner Joint		33		34			
	1998.12-	2002.01	MT		F	Saloon Engine AJM/AUY	GC083035	Outer Joint	36	27	53	77.5	65	I	
	1998.12-	2002.01	MT	L	F	Saloon Engine AJM/AUY	GDS61123	Drive Shaft	36		53	77.5	520		
	1998.12-	2002.01	MT	R	F	Saloon Engine AJM/AUY	GDS61121	Drive Shaft	36		53	77.5	806		
	1998.12-	2002.01	AT	L	F	Saloon Engine AJM/AUY	GDS83374	Drive Shaft	36		53	77.5	521		
1.9 TDi (96 kW)	2000.11-	2005.05	4AT		F	Saloon Engine ASZ	GC083036	Outer Joint	36	30	53.2	77.5	61	I	
	2000.11-	2005.05	MT		F	Saloon Engine ASZ	GCI53002	Inner Joint		33		34			
	2000.11-	2005.05	MT/AT		F	Saloon Engine ASZ	GC083035	Outer Joint	36	27	53	77.5	65	I	
	2000.11-	2005.05		L	F	Saloon Engine ASZ	GDS61123	Drive Shaft	36		53	77.5	520		
	2000.11-	2005.05	AT	L	F	Saloon Engine ASZ	GDS83374	Drive Shaft	36		53	77.5	521		
	2000.11-	2005.05		R	F	Saloon Engine ASZ	GDS61121	Drive Shaft	36		53	77.5	806		
1.9 TDi 4motion (110 kW)	2000.05-	2005.05	MT			Saloon Engine ARL	GCI53002	Inner Joint		33		34			
	2000.05-	2005.05		R		Saloon Engine ARL	GDS61121	Drive Shaft	36		53	77.5	806		
	2000.05-	2005.05	MT		F	Saloon Engine ARL	GC083035	Outer Joint	36	27	53	77.5	65	I	
	2000.05-	2005.05		L	F	Saloon Engine ARL	GDS61123	Drive Shaft	36		53	77.5	520		
	2000.05-	2005.05	6MT	R	F	Saloon Engine ARL	GDS61186	Drive Shaft	36		53	77.5	653		
	2000.05-	2005.05	6MT	R	F	Saloon Engine ARL	GCI61002	Inner Joint		28		31.8			
	2000.05-	2005.05	6MT	R	F	Saloon Engine ARL	GC083035	Outer Joint	36	27	53	77.5	65	I	
	2000.05-	2005.05			R	Saloon Engine ARL	GCI83011	Inner Joint		33		34			
	1.9 TDi 4motion (66 kW)	1999.02-	2001.06	AT	L	F	Saloon Engine AGR	GDS61156	Drive Shaft	36		53	78	554.5	
	1999.02-	2001.06	AT	L	F	Saloon Engine AGR	GCI61062	Inner Joint		30		59			
1.9 TDi 4motion (74 kW)	2000.09-	2005.05	MT			Saloon Engine ATD	GCI53002	Inner Joint		33		34			
	2000.09-	2005.05	MT/AT			Saloon Engine ATD	GC083036	Outer Joint	36	30	53.2	77.5	61	I	
	2000.09-	2005.05	MT		F	Saloon Engine ATD	GC083035	Outer Joint	36	27	53	77.5	65	I	
	2000.09-	2005.05	MT/AT		F	Saloon Engine ATD	GCI61006	Inner Joint		30		57.6			
	2000.09-	2005.05	AT	L	F	Saloon Engine ATD	GDS61244	Drive Shaft	36		53	77.5	523		
	2000.09-	2005.05	MT	L	F	Saloon Engine ATD	GDS61021	Drive Shaft	36		53.2	77.5	564.5		
	2000.09-	2005.05	MT	L	F	Saloon Engine ATD	GDS83006	Drive Shaft	36		53.2	77.5	557		
	2000.09-	2005.05	MT	R	F	Saloon Engine ATD	GDS61186	Drive Shaft	36		53	77.5	653		
	2000.09-	2005.05	MT	R	F	Saloon Engine ATD	GCI61002	Inner Joint		28		31.8			
	2000.09-	2005.05	MT	R	F	Saloon Engine ATD	GC083035	Outer Joint	36	27	53	77.5	65	I	
	2000.09-	2005.05	MT	R	F	Saloon Engine ATD	GDS83004	Drive Shaft	36		53.2	77.5	822		
	2000.09-	2005.05			R	Saloon Engine ATD	GCI83011	Inner Joint		33		34			
1.9 TDi 4motion (85 kW)	1999.02-	2001.06		R	F	Saloon Engine AJM/AUY	GDS61186	Drive Shaft	36		53	77.5	653		
	1999.02-	2001.06		R	F	Saloon Engine AJM/AUY	GCI61002	Inner Joint		28		31.8			
	1999.02-	2001.06		R	F	Saloon Engine AJM/AUY	GC083035	Outer Joint	36	27	53	77.5	65	I	
1.9 TDi 4motion (96 kW)	2000.11-	2005.05	AT			Saloon Engine ASZ	GC083036	Outer Joint	36	30	53.2	77.5	61	I	
	2000.11-	2005.05	MT			Saloon Engine ASZ	GCI53002	Inner Joint		33		34			
	2000.11-	2005.05		R		Saloon Engine ASZ	GDS61121	Drive Shaft	36		53	77.5	806		
	2000.11-	2005.05	MT		F	Saloon Engine ASZ	GC083035	Outer Joint	36	27	53	77.5	65	I	
	2000.11-	2005.05		L	F	Saloon Engine ASZ	GDS61123	Drive Shaft	36		53	77.5	520		
	2000.11-	2005.05		R	F	Saloon Engine ASZ	GDS61186	Drive Shaft	36		53	77.5	653		
	2000.11-	2005.05		R	F	Saloon Engine ASZ	GCI61002	Inner Joint		28		31.8			

		TRANSM	L/R	F/R		G-AP Ref.	PRODUCT	ABS	Technical Specifications						
									YEAR	A	B	C	H	L	P
<b>VOLKSWAGEN</b>															
<b>BORA (1J2)</b>															
1.9 TDi 4motion (96 kW)	2000.11-	2005.05			R	F	Saloon Engine ASZ	GC083035	Outer Joint	36	27	53	77.5	65	I
	2000.11-	2005.05			R		Saloon Engine ASZ	GCI83011	Inner Joint		33		34		
2.0 (85 kW)	1998.10-	2005.05				F	Saloon Engine APK/AQY/AZG/AZH/AZJ/BBW	GC083036	Outer Joint	36	30	53.2	77.5	61	I
	1998.10-	2005.05	MT			F	Saloon Engine APK/AQY/AZG/AZH/AZJ/BBW	GCI83011	Inner Joint		33		34		
	1998.10-	2005.05	MT/AT			F	Saloon Engine APK/AQY/AZG/AZH/AZJ/BBW	GCI61006	Inner Joint		30		57.6		
	1998.10-	2005.05	AT	L	F	Saloon Engine APK/AQY/AZG/AZH/AZJ/BBW	GDS61156	Drive Shaft	36		53	78	554.5		
	1998.10-	2005.05	AT	L	F	Saloon Engine APK/AQY/AZG/AZH/AZJ/BBW	GCI61062	Inner Joint		30		59			
	1998.10-	2005.05	MT	R	F	Saloon Engine APK/AQY/AZG/AZH/AZJ/BBW	GDS83004	Drive Shaft	36		53.2	77.5	822		
2.0 4motion (85 kW)	2000.04-	2005.05					Saloon Engine AZH/AZJ	GC083036	Outer Joint	36	30	53.2	77.5	61	I
	2000.04-	2005.05	MT				Saloon Engine AZH/AZJ	GCI53002	Inner Joint		33		34		
	2000.04-	2005.05	MT/AT		F	Saloon Engine AZH/AZJ	GCI61006	Inner Joint		30		57.6			
	2000.04-	2005.05	AT	L	F	Saloon Engine AZH/AZJ	GDS61156	Drive Shaft	36		53	78	554.5		
	2000.04-	2005.05	AT	L	F	Saloon Engine AZH/AZJ	GCI61062	Inner Joint		30		59			
	2000.04-	2005.05	MT	L	F	Saloon Engine AZH/AZJ	GDS61021	Drive Shaft	36		53.2	77.5	564.5		
2.3 V5 (125 kW)	2000.10-	2005.05			F/R		Saloon Engine AZH/AZJ	GCI83011	Inner Joint		33		34		
	2000.10-	2005.05	MT			F	Saloon Engine AQN	GCI53002	Inner Joint		33		34		
	2000.10-	2005.05	MT		F	Saloon Engine AQN	GC083035	Outer Joint	36	27	53	77.5	65	I	
	2000.10-	2005.05	MT/AT		F	Saloon Engine AQN	GCI61006	Inner Joint		30		57.6			
	2000.10-	2005.05	AT	L	F	Saloon Engine AQN	GDS83374	Drive Shaft	36		53	77.5	521		
	2000.10-	2005.05	MT	L	F	Saloon Engine AQN	GDS61156	Drive Shaft	36		53	78	554.5		
2.3 V5 4motion (125 kW)	2000.10-	2005.05	MT				Saloon Engine AQN	GCI61062	Inner Joint		30		59		
	2000.10-	2005.05	MT		F	Saloon Engine AQN	GCI53002	Inner Joint		33		34			
	2000.10-	2005.05	MT/AT		F	Saloon Engine AQN	GC083035	Outer Joint	36	27	53	77.5	65	I	
	2000.10-	2005.05	MT/AT		F	Saloon Engine AQN	GCI61006	Inner Joint		30		57.6			
	2000.10-	2005.05		L	F	Saloon Engine AQN	GDS61123	Drive Shaft	36		53	77.5	520		
	2000.10-	2005.05		R	F	Saloon Engine AQN	GDS61186	Drive Shaft	36		53	77.5	653		
2.8 V6 4motion (150 kW)	2000.10-	2005.05			R	F	Saloon Engine AQN	GCI61002	Inner Joint		28		31.8		
	2000.10-	2005.05			R	F	Saloon Engine AQN	GC083035	Outer Joint	36	27	53	77.5	65	I
	2000.10-	2005.05			R	F	Saloon Engine AQN	GCI83011	Inner Joint		33		34		
	2000.10-	2005.05			R	F	Saloon Engine AQN	GCI53002	Inner Joint		33		34		
	2000.10-	2005.05			R	F	Saloon Engine AQN	GC083035	Outer Joint	36	27	53	77.5	65	I
	2000.10-	2005.05	6MT		R	Saloon Engine AQN	GDS61123	Drive Shaft	36		53	77.5	520		
<b>BORA (1J2, 1J6) SW</b>	1999.03-	2005.05	MT				Saloon Engine AQP/AUE/BDE	GDS61186	Drive Shaft	36		53	77.5	653	
	1999.03-	2005.05	MT		F	Saloon Engine AQP/AUE/BDE	GCI61002	Inner Joint		28		31.8			
	1999.03-	2005.05	6MT	L	F	Saloon Engine AQP/AUE/BDE	GC083035	Outer Joint	36	27	53	77.5	65	I	
	1999.03-	2005.05		R	F	Saloon Engine AQP/AUE/BDE	GCI83011	Inner Joint		33		34			
	1999.03-	2005.05		R	F	Saloon Engine AQP/AUE/BDE	GCI53002	Inner Joint		33		34			
	1999.03-	2005.05		R	F	Saloon Engine AQP/AUE/BDE	GC083035	Outer Joint	36	27	53	77.5	65	I	
1999.03-	2005.05	6MT		R	Saloon Engine AQP/AUE/BDE	GCI83011	Inner Joint		33		34				
<b>BORA (1J2, 1J6) SW</b>															
1.8 4motion (92 kW)	1999.02-	2005.05			R			GCI83011	Inner Joint		33		34		
1.9 TDi (110 kW)	2003.01-							GCI83016	Inner Joint		28		32		
1.9 TDi (74 kW)	2000.05-	2005.05	AT		R			GCI83013	Inner Joint		33		34		
1.9 TDi 4motion (110 kW)	2003.01-							GCI83016	Inner Joint		28		32		
1.9 TDi 4motion (66 kW)	1998.10-	2005.05			R			GCI83011	Inner Joint		33		34		
1.9 TDi 4motion (74 kW)	2003.01-							GCI83016	Inner Joint		28		32		
1.9 TDi 4motion (96 kW)	2003.01-							GCI83016	Inner Joint		28		32		
2.0 4motion (85 kW)	1998.10-	2005.05	MT		R			GCI83011	Inner Joint		33		34		
2.3 VR5 4motion (125 kW)	2003.01-							GCI83016	Inner Joint		28		32		
2.8 V6 4motion (150 kW)	2003.01-							GCI83016	Inner Joint		28		32		
<b>BORA (1J6)</b>															
1.4 16V (55 kW)	2001.09-	2005.05				F	Estate Engine AHW/AXP/BCA	GCI83008	Inner Joint		33		32		
	2001.09-	2005.05	MT			F	Estate Engine AHW/AXP/BCA	GC083033	Outer Joint	36	30	53	78.5	51	I
	2001.09-	2005.05		L	F	Estate Engine AHW/AXP/BCA	GDS61045	Drive Shaft	36		53	78.5	555		
	2001.09-	2005.05		R	F	Estate Engine AHW/AXP/BCA	GDS83046	Drive Shaft	36		53	78.5	822		
1.6 (74 kW)	1999.05-	2005.05				F	Estate Engine AEH/APF	GCI83008	Inner Joint		33		32		
	1999.05-	2005.05	MT			F	Estate Engine AEH/APF	GC083033	Outer Joint	36	30	53	78.5	51	I
	1999.05-	2005.05	MT/AT			F	Estate Engine AEH/APF	GCI61006	Inner Joint		30		57.6		
	1999.05-	2005.05	AT	L	F	Estate Engine AEH/APF	GDS61156	Drive Shaft	36		53	78	554.5		
	1999.05-	2005.05	AT	L	F	Estate Engine AEH/APF	GCI61062	Inner Joint		30		59			
	1999.05-	2005.05	MT	L	F	Estate Engine AEH/APF	GDS61045	Drive Shaft	36		53	78.5	555		
1.6 (75 kW)	1999.05-	2005.05	MT	R	F	Estate Engine AEH/APF	GDS83046	Drive Shaft	36		53	78.5	822		
	2000.08-	2005.05	4AT		F	Estate Engine AVU/BFQ	GCI83008	Inner Joint		33		32			
	2000.08-	2005.05	MT/AT		F	Estate Engine AVU/BFQ	GCI61006	Inner Joint		30		57.6			









		YEAR	TRANSM	L/R	F/R		G-AP Ref.	PRODUCT	ABS	Technical Specifications						
										A	B	C	H	L	P	
<b>VOLKSWAGEN</b>																
<b>BORA (1J6)</b>																
1.6 (75 kW)	2000.08-	2005.05	AT	L	F	Estate Engine AVU/BFQ	GDS61156	Drive Shaft	36		53	78	554.5			
	2000.08-	2005.05	AT	L	F	Estate Engine AVU/BFQ	GCI61062	Inner Joint		30		59				
	2000.08-	2005.05	MT	L	F	Estate Engine AVU/BFQ	GDS61045	Drive Shaft	36		53	78.5	555			
	2000.08-	2005.05	MT	R	F	Estate Engine AVU/BFQ	GDS83046	Drive Shaft	36		53	78.5	822			
1.6 16V (77 kW)	2000.02-	2005.05			F	Estate Engine ATN/AUS/AZD/BCB	GC083036	Outer Joint	36	30	53.2	77.5	61	I		
	2000.02-	2005.05	MT	L	F	Estate Engine ATN/AUS/AZD/BCB	GDS61202	Drive Shaft	36		53.2	77.5	547			
	2000.02-	2005.05		L	F	Estate Engine ATN/AUS/AZD/BCB	GDS61312	Drive Shaft	36		53	78	546			
	2000.02-	2005.05	MT	R	F	Estate Engine ATN/AUS/AZD/BCB	GDS61203	Drive Shaft	36		53.2	77.5	810			
1.8 4motion (92 kW)	1999.05-	2005.05				Estate Engine AGN	GC083036	Outer Joint	36	30	53.2	77.5	61	I		
	1999.05-	2005.05	MT			Estate Engine AGN	GCI53002	Inner Joint		33		34				
	1999.05-	2005.05			F/R	Estate Engine AGN	GCI83011	Inner Joint		33		34				
1.8 T (110 kW)	2000.05-	2005.05			F	Estate Engine AGU/ARX/AUM	GC083036	Outer Joint	36	30	53.2	77.5	61	I		
	2000.05-	2005.05	MT/AT		F	Estate Engine AGU/ARX/AUM	GCI61006	Inner Joint		30		57.6				
	2000.05-	2005.05	AT	L	F	Estate Engine AGU/ARX/AUM	GDS83374	Drive Shaft	36		53	77.5	521			
	2000.05-	2005.05	MT	L	F	Estate Engine AGU/ARX/AUM	GDS61156	Drive Shaft	36		53	78	554.5			
	2000.05-	2005.05	MT	L	F	Estate Engine AGU/ARX/AUM	GCI61062	Inner Joint		30		59				
1.8 T (132 kW)	2002.05-	2005.05	MT		F	Estate Engine AUQ	GC083035	Outer Joint	36	27	53	77.5	65	I		
	2002.05-	2005.05		L	F	Estate Engine AUQ	GDS61123	Drive Shaft	36		53	77.5	520			
	2002.05-	2005.05		R	F	Estate Engine AUQ	GDS61121	Drive Shaft	36		53	77.5	806			
1.9 TDi (110 kW)	2001.05-	2005.05	MT		F	Estate Engine ARL	GCI53002	Inner Joint		33		34				
	2001.05-	2005.05	MT		F	Estate Engine ARL	GC083035	Outer Joint	36	27	53	77.5	65	I		
	2001.05-	2005.05		L	F	Estate Engine ARL	GDS61123	Drive Shaft	36		53	77.5	520			
	2001.05-	2005.05		R	F	Estate Engine ARL	GDS61121	Drive Shaft	36		53	77.5	806			
1.9 TDi (66 kW)	2004.07-	2005.05			F	Estate Engine AGR	GC083036	Outer Joint	36	30	53.2	77.5	61	I		
	2004.07-	2005.05	MT		F	Estate Engine AGR	GCI83009	Inner Joint		33		34				
	2004.07-	2005.05	MT/AT		F	Estate Engine AGR	GCI61006	Inner Joint		30		57.6				
	2004.07-	2005.05	AT	L	F	Estate Engine AGR	GDS61156	Drive Shaft	36		53	78	554.5			
	2004.07-	2005.05	AT	L	F	Estate Engine AGR	GCI61062	Inner Joint		30		59				
	2004.07-	2005.05	MT	L	F	Estate Engine AGR	GDS61021	Drive Shaft	36		53.2	77.5	564.5			
	2004.07-	2005.05	MT	L	F	Estate Engine AGR	GDS83006	Drive Shaft	36		53.2	77.5	557			
	2004.07-	2005.05	MT	R	F	Estate Engine AGR	GDS83004	Drive Shaft	36		53.2	77.5	822			
1.9 TDi (74 kW)	2000.09-	2005.05	AT		F	Estate Engine ATD/AXR	GC083035	Outer Joint	36	27	53	77.5	65	I		
	2000.09-	2005.05	MT		F	Estate Engine ATD/AXR	GCI83011	Inner Joint		33		34				
	2000.09-	2005.05	MT/AT		F	Estate Engine ATD/AXR	GC083036	Outer Joint	36	30	53.2	77.5	61	I		
	2000.09-	2005.05	MT/AT		F	Estate Engine ATD/AXR	GCI61006	Inner Joint		30		57.6				
	2000.09-	2005.05	AT	L	F	Estate Engine ATD/AXR	GDS83374	Drive Shaft	36		53	77.5	521			
	2000.09-	2005.05	MT	L	F	Estate Engine ATD/AXR	GDS61021	Drive Shaft	36		53.2	77.5	564.5			
	2000.09-	2005.05	MT	L	F	Estate Engine ATD/AXR	GDS83006	Drive Shaft	36		53.2	77.5	557			
	2000.09-	2005.05	MT	R	F	Estate Engine ATD/AXR	GDS83004	Drive Shaft	36		53.2	77.5	822			
1.9 TDi (81 kW)	1999.05-	2001.06	MT	L	F	Estate Engine AHF/ASV	GDS61021	Drive Shaft	36		53.2	77.5	564.5			
	1999.05-	2001.06	AT	L	F	Estate Engine AHF/ASV	GDS61244	Drive Shaft	36		53	77.5	523			
1.9 TDi (85 kW)	1999.05-	2001.06	AT	L	F	Estate Engine AJM/AUY	GDS83374	Drive Shaft	36		53	77.5	521			
1.9 TDi (96 kW)	2000.11-	2005.05	4AT		F	Estate Engine ASZ	GC083036	Outer Joint	36	30	53.2	77.5	61	I		
	2000.11-	2005.05	MT		F	Estate Engine ASZ	GCI53002	Inner Joint		33		34				
	2000.11-	2005.05	MT/AT		F	Estate Engine ASZ	GC083035	Outer Joint	36	27	53	77.5	65	I		
	2000.11-	2005.05		L	F	Estate Engine ASZ	GDS61123	Drive Shaft	36		53	77.5	520			
	2000.11-	2005.05	AT	L	F	Estate Engine ASZ	GDS83374	Drive Shaft	36		53	77.5	521			
	2000.11-	2005.05		R	F	Estate Engine ASZ	GDS61121	Drive Shaft	36		53	77.5	806			
1.9 TDi 4motion (110 kW)	2001.05-	2005.05	MT			Estate Engine ARL	GCI53002	Inner Joint		33		34				
	2001.05-	2005.05		R		Estate Engine ARL	GDS61121	Drive Shaft	36		53	77.5	806			
	2001.05-	2005.05	MT		F	Estate Engine ARL	GC083035	Outer Joint	36	27	53	77.5	65	I		
	2001.05-	2005.05		L	F	Estate Engine ARL	GDS61123	Drive Shaft	36		53	77.5	520			
	2001.05-	2005.05	6MT	R	F	Estate Engine ARL	GDS61186	Drive Shaft	36		53	77.5	653			
	2001.05-	2005.05	6MT	R	F	Estate Engine ARL	GCI61002	Inner Joint		28		31.8				
	2001.05-	2005.05	6MT	R	F	Estate Engine ARL	GC083035	Outer Joint	36	27	53	77.5	65	I		
	2001.05-	2005.05		R		Estate Engine ARL	GCI83011	Inner Joint		33		34				
1.9 TDi 4motion (74 kW)	2000.09-	2005.05	MT			Estate Engine ATD	GCI53002	Inner Joint		33		34				
	2000.09-	2005.05	MT/AT			Estate Engine ATD	GC083036	Outer Joint	36	30	53.2	77.5	61	I		
	2000.09-	2005.05	MT		F	Estate Engine ATD	GC083035	Outer Joint	36	27	53	77.5	65	I		
	2000.09-	2005.05	MT/AT		F	Estate Engine ATD	GCI61006	Inner Joint		30		57.6				
	2000.09-	2005.05	MT	L	F	Estate Engine ATD	GDS61021	Drive Shaft	36		53.2	77.5	564.5			



		TRANSM	L/R	F/R		G-AP Ref.	PRODUCT	ABS	Technical Specifications								
									YEAR	A	B	C	H	L	P		
<b>VOLKSWAGEN BORA (1J6)</b>																	
1.9 TDi 4motion (74 kW)	2000.09-2005.05	MT	L	F	Estate Engine ATD	GDS83006	Drive Shaft	36		53.2	77.5	557					
	2000.09-2005.05	MT	R	F	Estate Engine ATD	GDS83004	Drive Shaft	36		53.2	77.5	822					
	2000.09-2005.05		R	F	Estate Engine ATD	GDS61186	Drive Shaft	36		53	77.5	653					
	2000.09-2005.05		R	F	Estate Engine ATD	GCI61002	Inner Joint		28		31.8						
	2000.09-2005.05		R	F	Estate Engine ATD	GC083035	Outer Joint	36	27	53	77.5	65	I				
	2000.09-2005.05			R	Estate Engine ATD	GCI83011	Inner Joint		33		34						
1.9 TDi 4motion (85 kW)	1999.05-2001.06		R	F	Estate Engine AJM/AUY	GDS61186	Drive Shaft	36		53	77.5	653					
	1999.05-2001.06		R	F	Estate Engine AJM/AUY	GCI61002	Inner Joint		28		31.8						
	1999.05-2001.06		R	F	Estate Engine AJM/AUY	GC083035	Outer Joint	36	27	53	77.5	65	I				
1.9 TDi 4motion (96 kW)	2000.11-2005.05	6MT	R	F	Estate Engine ASZ	GCI61002	Inner Joint		28		31.8						
	2000.11-2005.05	6MT	R	F	Estate Engine ASZ	GC083035	Outer Joint	36	27	53	77.5	65	I				
	2000.11-2005.05			R	Estate Engine ASZ	GCI83011	Inner Joint		33		34						
	2000.11-2005.05	AT			Estate Engine ASZ	GC083036	Outer Joint	36	30	53.2	77.5	61	I				
	2000.11-2005.05	MT			Estate Engine ASZ	GCI53002	Inner Joint		33		34						
	2000.11-2005.05		R		Estate Engine ASZ	GDS61121	Drive Shaft	36		53	77.5	806					
	2000.11-2005.05	MT		F	Estate Engine ASZ	GC083035	Outer Joint	36	27	53	77.5	65	I				
	2000.11-2005.05		L	F	Estate Engine ASZ	GDS61123	Drive Shaft	36		53	77.5	520					
	2000.11-2005.05	AT	L	F	Estate Engine ASZ	GDS61244	Drive Shaft	36		53	77.5	523					
2.0 (85 kW)	1999.05-2005.05			F	Estate Engine APK/AQY/AZH/AZJ	GC083036	Outer Joint	36	30	53.2	77.5	61	I				
	1999.05-2005.05	MT		F	Estate Engine APK/AQY/AZH/AZJ	GCI83011	Inner Joint		33		34						
	1999.05-2005.05	MT/AT		F	Estate Engine APK/AQY/AZH/AZJ	GCI61006	Inner Joint		30		57.6						
	1999.05-2005.05	AT	L	F	Estate Engine APK/AQY/AZH/AZJ	GDS61156	Drive Shaft	36		53	78	554.5					
	1999.05-2005.05	AT	L	F	Estate Engine APK/AQY/AZH/AZJ	GCI61062	Inner Joint		30		59						
	1999.05-2005.05	MT	L	F	Estate Engine APK/AQY/AZH/AZJ	GDS61021	Drive Shaft	36		53.2	77.5	564.5					
	1999.05-2005.05	MT	R	F	Estate Engine APK/AQY/AZH/AZJ	GDS83004	Drive Shaft	36		53.2	77.5	822					
2.0 4motion (85 kW)	2000.04-2005.05				Estate Engine AZH/AZJ	GC083036	Outer Joint	36	30	53.2	77.5	61	I				
	2000.04-2005.05	MT			Estate Engine AZH/AZJ	GCI53002	Inner Joint		33		34						
	2000.04-2005.05	MT/AT		F	Estate Engine AZH/AZJ	GCI61006	Inner Joint		30		57.6						
	2000.04-2005.05	AT	L	F	Estate Engine AZH/AZJ	GDS61156	Drive Shaft	36		53	78	554.5					
	2000.04-2005.05	AT	L	F	Estate Engine AZH/AZJ	GCI61062	Inner Joint		30		59						
	2000.04-2005.05	MT	L	F	Estate Engine AZH/AZJ	GDS61021	Drive Shaft	36		53.2	77.5	564.5					
2.3 V5 (125 kW)	2000.10-2005.05	MT		F	Estate Engine AQN	GCI53002	Inner Joint		33		34						
	2000.10-2005.05	MT		F	Estate Engine AQN	GC083035	Outer Joint	36	27	53	77.5	65	I				
	2000.10-2005.05	MT/AT		F	Estate Engine AQN	GCI61006	Inner Joint		30		57.6						
	2000.10-2005.05	AT	L	F	Estate Engine AQN	GDS83374	Drive Shaft	36		53	77.5	521					
	2000.10-2005.05	MT	L	F	Estate Engine AQN	GDS61156	Drive Shaft	36		53	78	554.5					
	2000.10-2005.05	MT	L	F	Estate Engine AQN	GCI61062	Inner Joint		30		59						
2.3 V5 4motion (125 kW)	2000.10-2005.05	MT			Estate Engine AQN	GCI53002	Inner Joint		33		34						
	2000.10-2005.05	MT		F	Estate Engine AQN	GC083035	Outer Joint	36	27	53	77.5	65	I				
	2000.10-2005.05	MT/AT		F	Estate Engine AQN	GCI61006	Inner Joint		30		57.6						
	2000.10-2005.05		L	F	Estate Engine AQN	GDS61123	Drive Shaft	36		53	77.5	520					
	2000.10-2005.05		R	F	Estate Engine AQN	GDS61186	Drive Shaft	36		53	77.5	653					
	2000.10-2005.05		R	F	Estate Engine AQN	GCI61002	Inner Joint		28		31.8						
	2000.10-2005.05		R	F	Estate Engine AQN	GC083035	Outer Joint	36	27	53	77.5	65	I				
2.8 V6 4motion (150 kW)	1999.05-2005.05	6MT		R	Estate Engine AQP/AUE/BDE	GCI83011	Inner Joint		33		34						
	1999.05-2005.05	MT		F	Estate Engine AQP/AUE/BDE	GCI53002	Inner Joint		33		34						
	1999.05-2005.05	MT		F	Estate Engine AQP/AUE/BDE	GC083035	Outer Joint	36	27	53	77.5	65	I				
	1999.05-2005.05	6MT	L	F	Estate Engine AQP/AUE/BDE	GDS61123	Drive Shaft	36		53	77.5	520					
	1999.05-2005.05		R	F	Estate Engine AQP/AUE/BDE	GDS61186	Drive Shaft	36		53	77.5	653					
	1999.05-2005.05		R	F	Estate Engine AQP/AUE/BDE	GCI61002	Inner Joint		28		31.8						
	1999.05-2005.05		R	F	Estate Engine AQP/AUE/BDE	GC083035	Outer Joint	36	27	53	77.5	65	I				
<b>CADDY (14)</b>																	
1.5 (51 kW)	1982.08-1983.07	MT		F	Pickup Engine JB	GC061013	Outer Joint	22	30	50	77.5	51	I				
1.6 (55 kW)	1983.01-1992.07	MT		F	Pickup Engine EW	GC061013	Outer Joint	22	30	50	77.5	51	I				
1.6 D (40 kW)	1982.08-1992.07	MT		F	Pickup Engine JK/ME	GC061013	Outer Joint	22	30	50	77.5	51	I				
1.8 (70 kW)	1985.08-1992.07	MT		F	Pickup Engine JH	GC061013	Outer Joint	22	30	50	77.5	51	I				
<b>CADDY II (9K9A)</b>																	
1.4 (44 kW)	1995.11-2004.01	MT		F	Box Engine AEX/APQ/AUD	GC053008	Outer Joint	22	30	53	78.5	51	I				

		TRANSM	L/R	F/R		G-AP Ref.	PRODUCT	ABS	Technical Specifications							
									YEAR	A	B	C	H	L	P	
<b>VOLKSWAGEN</b>																
<b>CADDY II (9K9A)</b>																
1.4 (44 kW)	1995.11-	2004.01	MT		F	Box Engine AEX/APQ/AUD	GCI53001	Inner Joint		33		32				
	1995.11-	2004.01	MT	L	F	Box Engine AEX/APQ/AUD	GDS53004	Drive Shaft	22		50	78.5	562			
1.9 D (47 kW)	1995.11-	2004.01	MT		F	Box Engine 1Y	GC053008	Outer Joint	22	30	53	78.5	51	I		
	1995.11-	2004.01	MT		F	Box Engine 1Y	GCI83004	Inner Joint		33		32				
	1995.11-	2004.01	MT	L	F	Box Engine 1Y	GDS53003	Drive Shaft	22		53	78.5	539.5			
	1995.11-	2004.01	MT	R	F	Box Engine 1Y	GDS53005	Drive Shaft	22		53	78.5	774			
1.9 SDi (47 kW)	1995.11-	2004.01	MT		F	Box Engine AEY/AYQ	GC053008	Outer Joint	22	30	53	78.5	51	I		
	1995.11-	2004.01	MT		F	Box Engine AEY/AYQ	GCI83004	Inner Joint		33		32				
	1995.11-	2004.01	MT	L	F	Box Engine AEY/AYQ	GDS53003	Drive Shaft	22		53	78.5	539.5			
	1995.11-	2004.01	MT	R	F	Box Engine AEY/AYQ	GDS53005	Drive Shaft	22		53	78.5	774			
1.9 TDi (66 kW)	1996.09-	2004.01			F	Box Engine 1Z/AHU/ALH	GC053007	Outer Joint	22	30	53.2	78	61	I		
	1996.09-	2004.01	MT		F	Box Engine 1Z/AHU/ALH	GC061018	Outer Joint	22	30	53	78.5	61	I		
	1996.09-	2004.01	MT		F	Box Engine 1Z/AHU/ALH	GCI83011	Inner Joint		33		34				
	1996.09-	2004.01	MT	R	F	Box Engine 1Z/AHU/ALH	GDS53002	Drive Shaft	22		53.2	78	769			
<b>CADDY II (9K9B)</b>																
1.9 SDi (47 kW)	1995.11-	2004.01	MT		F	Estate Engine AEY/AYQ	GC053008	Outer Joint	22	30	53	78.5	51	I		
	1995.11-	2004.01	MT	L	F	Estate Engine AEY/AYQ	GDS53003	Drive Shaft	22		53	78.5	539.5			
	1995.11-	2004.01	MT	R	F	Estate Engine AEY/AYQ	GDS53005	Drive Shaft	22		53	78.5	774			
1.9 TDi (66 kW)	1996.10-	2004.01			F	Estate Engine AHU/ALE/ALH	GC053007	Outer Joint	22	30	53.2	78	61	I		
	1996.10-	2004.01	MT		F	Estate Engine AHU/ALE/ALH	GCI53002	Inner Joint		33		34				
	1996.10-	2004.01		L	F	Estate Engine AHU/ALE/ALH	GDS53001	Drive Shaft	22		53	78.5	535			
<b>CADDY III (2KA, 2KB, 2KH, 2KJ)</b>																
2.0 TDi (103 kW)	2007.09-						GCI83016	Inner Joint		28		32				
<b>CADDY III (2KA, 2KH, 2CA, 2CH)</b>																
1.2 TSi (63 kW)	2010.09-				F	Box Engine CBZA	GC083002	Outer Joint	36	27	59.5	40	66	I		
	2010.09-				R	Box Engine CBZA	GC083100	Outer Joint	36	33	59.5	38	55	I		
	2010.09-					Box Engine CBZA	GC061059	Outer Joint	36	33	59.5	40	59.5	I		
1.2 TSi (77 kW)	2010.09-				F	Box Engine CBZB	GC083002	Outer Joint	36	27	59.5	40	66	I		
	2010.09-			L	F	Box Engine CBZB	GDS61131	Drive Shaft	36		59.5	40	515			
	2010.09-			R	F	Box Engine CBZB	GC083100	Outer Joint	36	33	59.5	38	55	I		
	2010.09-					Box Engine CBZB	GC061059	Outer Joint	36	33	59.5	40	59.5	I		
1.4 (55 kW)	2004.03-	2006.05	5MT		F	Box Engine BCA	GCI83011	Inner Joint		33		34				
1.4 16V (59 kW)	2006.05-	2010.08			F	Box Engine BUD	GCI83011	Inner Joint		33		34				
	2006.05-	2010.08			F	Box Engine BUD	GC083037	Outer Joint	36	30	59.5	40.5	55	I		
1.6 (75 kW)	2004.04-				F	Box Engine BGU/BSE/BSF	GC083002	Outer Joint	36	27	59.5	40	66	I		
	2004.04-				F	Box Engine BGU/BSE/BSF	GC083037	Outer Joint	36	30	59.5	40.5	55	I		
	2004.04-		5MT		F	Box Engine BGU/BSE/BSF	GCI83011	Inner Joint		33		34				
	2004.04-		6AT		F	Box Engine BGU/BSE/BSF	GCI61011	Inner Joint	26	32	31	68.5	85			
	2004.04-		MT		F	Box Engine BGU/BSE/BSF	GCI53002	Inner Joint		33		34				
	2004.04-		6AT	L	F	Box Engine BGU/BSE/BSF	GDS61093	Drive Shaft	36	26	59.5	40.5	587.5			
	2004.04-			R	F	Box Engine BGU/BSE/BSF	GDS61113	Drive Shaft	36		59.5	40	814			
	2004.04-		6AT	R	F	Box Engine BGU/BSE/BSF	GDS61094	Drive Shaft	36	26	59.5	40.5	884			
2004.04-			L	F	Box Engine BGU/BSE/BSF	GDS83373	Drive Shaft	36		59.5	38	511				
1.6 BiFuel (75 kW)	2011.05-			R	F	Box Engine CHGA	GDS61113	Drive Shaft	36		59.5	40	814			
1.6 TDi (55 kW)	2010.08-				F	Box Engine CAYE	GC083002	Outer Joint	36	27	59.5	40	66	I		
1.6 TDi (75 kW)	2010.08-				F	Box Engine CAYD	GC083002	Outer Joint	36	27	59.5	40	66	I		
	2010.08-		AT	L	F	Box Engine CAYD	GDS61131	Drive Shaft	36		59.5	40	515			
	2010.08-		MT	L	F	Box Engine CAYD	GDS83236	Drive Shaft	36		59.5	40	484			
1.9 TDi (55 kW)	2005.09-	2010.08	5MT		F	Box Engine BSU	GC083002	Outer Joint	36	27	59.5	40	66	I		
	2005.09-	2010.08	MT		F	Box Engine BSU	GCI53002	Inner Joint		33		34				
	2005.09-	2010.08	AT	L	F	Box Engine BSU	GDS83241	Drive Shaft	36		59.5	40	475			
	2005.09-	2010.08	MT	L	F	Box Engine BSU	GDS61131	Drive Shaft	36		59.5	40	515			
	2005.09-	2010.08	MT	L/R	F	Box Engine BSU	GCI61017	Inner Joint		33		31.8				
	2005.09-	2010.08	MT	L/R	F	Box Engine BSU	GC083002	Outer Joint	36	27	59.5	40	66	I		
	2005.09-	2010.08	MT	R	F	Box Engine BSU	GDS61101	Drive Shaft	36		59.5	40	803			
1.9 TDi (77 kW)	2004.04-	2010.08	5MT/6AT		F	Box Engine BJB/BLS	GC083002	Outer Joint	36	27	59.5	40	66	I		
	2004.04-	2010.08	6AT		F	Box Engine BJB/BLS	GCI54004	Inner Joint		34		85				
	2004.04-	2010.08	MT		F	Box Engine BJB/BLS	GCI53002	Inner Joint		33		34				
	2004.04-	2010.08	AT	L	F	Box Engine BJB/BLS	GDS83241	Drive Shaft	36		59.5	40	475			
	2004.04-	2010.08	AT	L	F	Box Engine BJB/BLS	GDS54013	Drive Shaft	36		59.5	40	479.5			
	2004.04-	2010.08	MT	L	F	Box Engine BJB/BLS	GDS61131	Drive Shaft	36		59.5	40	515			









		TRANSM	L/R	F/R		G-AP Ref.	PRODUCT	ABS	Technical Specifications												
									YEAR	A	B	C	H	L	P						
<b>VOLKSWAGEN</b>																					
<b>CADDY III (2KA, 2KH, 2CA, 2CH)</b>																					
1.9 TDi (77 kW)	2004.04-	2010.08	AT	L/R	F	Box Engine BJB/BLS	GCI61057	Inner Joint		34		86									
	2004.04-	2010.08	MT	L/R	F	Box Engine BJB/BLS	GCI61017	Inner Joint		33		31.8									
	2004.04-	2010.08	MT	L/R	F	Box Engine BJB/BLS	GC083002	Outer Joint	36	27	59.5	40	66	I							
	2004.04-	2010.08	AT	R	F	Box Engine BJB/BLS	GDS83355	Drive Shaft	36	23	59.5	40	799								
	2004.04-	2010.08	AT	R	F	Box Engine BJB/BLS	GDS54011	Drive Shaft	36		59.5	40	755								
	2004.04-	2010.08	MT	R	F	Box Engine BJB/BLS	GDS61101	Drive Shaft	36		59.5	40	803								
1.9 TDi 4motion (77 kW)	2008.11-	2010.08			L	Box Engine BLS	GDS83295	Drive Shaft	36		59.5	40	491								
	2008.11-	2010.08			R	Box Engine BLS	GDS83266	Drive Shaft	36		59.5	40	601								
	2008.11-	2010.08	MT		L	F	Box Engine BLS	GDS83236	Drive Shaft	36		59.5	40	484							
	2008.11-	2010.08			R		Box Engine BLS	GCI83016	Inner Joint		28		32								
2.0 EcoFuel (80 kW)	2006.04-				F	Box Engine BSX	GCI83011	Inner Joint		33		34									
	2006.04-				F	Box Engine BSX	GC083037	Outer Joint	36	30	59.5	40.5	55	I							
	2006.04-				R	F	Box Engine BSX	GDS61113	Drive Shaft	36		59.5	40	814							
2.0 SDi (51 kW)	2004.03-	2010.08			F	Box Engine BDJ/BST	GC083002	Outer Joint	36	27	59.5	40	66	I							
	2004.03-	2010.08			F	Box Engine BDJ/BST	GC083037	Outer Joint	36	30	59.5	40.5	55	I							
	2004.03-	2010.08	5MT		F	Box Engine BDJ/BST	GCI83011	Inner Joint		33		34									
	2004.03-	2010.08	MT		F	Box Engine BDJ/BST	GCI53002	Inner Joint		33		34									
	2004.03-	2010.08			L	F	Box Engine BDJ/BST	GDS61268	Drive Shaft	36		59.5	40	516							
	2004.03-	2010.08			R	F	Box Engine BDJ/BST	GDS61042	Drive Shaft	36		59.5	40.5	814							
2.0 TDi (103 kW)	2007.09-	2010.08			F	Box Engine BMM	GC083037	Outer Joint	36	30	59.5	40.5	55	I							
2.0 TDi (125 kW)	2012.05-		SEMI-AT		L	F	Box Engine CFJA	GDS83241	Drive Shaft	36		59.5	40	475							
	2012.05-		AT	L/R	F	Box Engine CFJA	GCI61057	Inner Joint		34		86									
2.0 TDi (81 kW)	2010.08-				L	F	Box Engine CLCA	GDS83236	Drive Shaft	36		59.5	40	484							
2.0 TDi 16V (103 kW)	2010.11-				F	Box Engine CFHC/CLCB	GC083037	Outer Joint	36	30	59.5	40.5	55	I							
	2010.11-		6AT		F	Box Engine CFHC/CLCB	GC061045	Outer Joint	36	27	59.5	40	65	M							
	2010.11-		6AT	R	F	Box Engine CFHC/CLCB	GDS54011	Drive Shaft	36		59.5	40	755								
	2010.11-		SEMI-AT		L	F	Box Engine CFHC/CLCB	GDS83241	Drive Shaft	36		59.5	40	475							
	2010.11-		6AT	L/R	F	Box Engine CFHC/CLCB	GCI61057	Inner Joint		34		86									
	2010.11-		AT	R	F	Box Engine CFHC/CLCB	GDS83355	Drive Shaft	36	23	59.5	40	799								
2.0 TDi 16V 4motion (103 kW)	2010.11-				L	F	Box Engine CFHC	GDS83241	Drive Shaft	36		59.5	40	475							
2.0 TDi 4motion (81 kW)	2010.08-				L	Box Engine CFHF	GDS83295	Drive Shaft	36		59.5	40	491								
	2010.08-				R	Box Engine CFHF	GDS83266	Drive Shaft	36		59.5	40	601								
	2010.08-				F	Box Engine CFHF	GC083002	Outer Joint	36	27	59.5	40	66	I							
	2010.08-				L	F	Box Engine CFHF	GDS83236	Drive Shaft	36		59.5	40	484							
	2010.08-				R	Box Engine CFHF	GCI83016	Inner Joint		28		32									
<b>CADDY III (2KB, 2KJ, 2CB, 2CJ)</b>																					
1.2 TSi (63 kW)	2010.09-				F	Estate Engine CBZA	GC083002	Outer Joint	36	27	59.5	40	66	I							
	2010.09-		MT		F	Estate Engine CBZA	GCI53002	Inner Joint		33		34									
	2010.09-				L	F	Estate Engine CBZA	GDS61131	Drive Shaft	36		59.5	40	515							
	2010.09-				R	F	Estate Engine CBZA	GC083100	Outer Joint	36	33	59.5	38	55	I						
	2010.09-						Estate Engine CBZA	GC061059	Outer Joint	36	33	59.5	40	59.5	I						
1.2 TSi (77 kW)	2010.09-				F	Estate Engine CBZB	GC083002	Outer Joint	36	27	59.5	40	66	I							
	2010.09-						Estate Engine CBZB	GC061059	Outer Joint	36	33	59.5	40	59.5	I						
1.4 (55 kW)	2004.03-	2006.05	5MT		F	Estate Engine BCA	GCI83011	Inner Joint		33		34									
1.4 16V (59 kW)	2006.05-	2010.08			F	Estate Engine BUD	GCI83011	Inner Joint		33		34									
	2006.05-	2010.08			F	Estate Engine BUD	GC083037	Outer Joint	36	30	59.5	40.5	55	I							
1.6 (75 kW)	2004.04-				F	Estate Engine BGU/BSE/BSF	GC083002	Outer Joint	36	27	59.5	40	66	I							
	2004.04-				F	Estate Engine BGU/BSE/BSF	GC083037	Outer Joint	36	30	59.5	40.5	55	I							
	2004.04-		5MT		F	Estate Engine BGU/BSE/BSF	GCI83011	Inner Joint		33		34									
	2004.04-		6AT		F	Estate Engine BGU/BSE/BSF	GCI61011	Inner Joint	26	32	31	68.5	85								
	2004.04-		MT		F	Estate Engine BGU/BSE/BSF	GCI53002	Inner Joint		33		34									
	2004.04-		6AT	L	F	Estate Engine BGU/BSE/BSF	GDS61093	Drive Shaft	36	26	59.5	40.5	587.5								
	2004.04-			R	F	Estate Engine BGU/BSE/BSF	GDS61113	Drive Shaft	36		59.5	40	814								
	2004.04-		6AT	R	F	Estate Engine BGU/BSE/BSF	GDS61094	Drive Shaft	36	26	59.5	40.5	884								
2004.04-			L	F	Estate Engine BGU/BSE/BSF	GDS83373	Drive Shaft	36		59.5	38	511									
1.6 BiFuel (75 kW)	2011.05-				R	F	Estate Engine CHGA	GDS61113	Drive Shaft	36		59.5	40	814							
1.6 TDi (55 kW)	2010.08-				F	Estate Engine CAYE	GC083002	Outer Joint	36	27	59.5	40	66	I							
1.6 TDi (75 kW)	2010.08-				F	Estate Engine CAYD	GC083002	Outer Joint	36	27	59.5	40	66	I							
	2010.08-		MT	L	F	Estate Engine CAYD	GDS61131	Drive Shaft	36		59.5	40	515								
1.9 TDI	2004-				L/R	F		GCI61017	Inner Joint		33		31.8								
1.9 TDi (55 kW)	2005.09-	2010.08	5MT		F	Estate Engine BSU	GC083002	Outer Joint	36	27	59.5	40	66	I							



		YEAR	TRANSM	L/R	F/R		G-AP Ref.	PRODUCT	ABS	Technical Specifications						
										A	B	C	H	L	P	
<b>VOLKSWAGEN</b>																
<b>CADDY III (2KB, 2KJ, 2CB, 2CJ)</b>																
1.9 TDi (55 kW)	2005.09-	2010.08	MT		F	Estate Engine BSU	GCI53002	Inner Joint		33		34				
	2005.09-	2010.08	AT	L	F	Estate Engine BSU	GDS83241	Drive Shaft	36		59.5	40	475			
	2005.09-	2010.08	MT	L	F	Estate Engine BSU	GDS61131	Drive Shaft	36		59.5	40	515			
	2005.09-	2010.08	MT	L/R	F	Estate Engine BSU	GCI61017	Inner Joint		33		31.8				
	2005.09-	2010.08	MT	L/R	F	Estate Engine BSU	GC083002	Outer Joint	36	27	59.5	40	66	I		
	2005.09-	2010.08	MT	R	F	Estate Engine BSU	GDS61101	Drive Shaft	36		59.5	40	803			
1.9 TDi (77 kW)	2004.04-	2010.08	5MT/6AT		F	Estate Engine BJB/BLS	GC083002	Outer Joint	36	27	59.5	40	66	I		
	2004.04-	2010.08	6AT		F	Estate Engine BJB/BLS	GCI54004	Inner Joint		34		85				
	2004.04-	2010.08	MT		F	Estate Engine BJB/BLS	GCI53002	Inner Joint		33		34				
	2004.04-	2010.08	AT	L	F	Estate Engine BJB/BLS	GDS83241	Drive Shaft	36		59.5	40	475			
	2004.04-	2010.08	AT	L	F	Estate Engine BJB/BLS	GDS54013	Drive Shaft	36		59.5	40	479.5			
	2004.04-	2010.08	MT	L	F	Estate Engine BJB/BLS	GDS61131	Drive Shaft	36		59.5	40	515			
	2004.04-	2010.08	AT	L/R	F	Estate Engine BJB/BLS	GCI61057	Inner Joint		34		86				
	2004.04-	2010.08	MT	L/R	F	Estate Engine BJB/BLS	GCI61017	Inner Joint		33		31.8				
	2004.04-	2010.08	MT	L/R	F	Estate Engine BJB/BLS	GC083002	Outer Joint	36	27	59.5	40	66	I		
	2004.04-	2010.08	AT	R	F	Estate Engine BJB/BLS	GDS83355	Drive Shaft	36	23	59.5	40	799			
	2004.04-	2010.08	AT	R	F	Estate Engine BJB/BLS	GDS54011	Drive Shaft	36		59.5	40	755			
	2004.04-	2010.08	MT	R	F	Estate Engine BJB/BLS	GDS61101	Drive Shaft	36		59.5	40	803			
1.9 TDi 4motion (77 kW)	2008.05-	2010.08	6AT			Estate Engine BLS	GCI54004	Inner Joint		34		85				
	2008.05-	2010.08	MT			Estate Engine BLS	GCI53002	Inner Joint		33		34				
	2008.05-	2010.08		L		Estate Engine BLS	GDS83295	Drive Shaft	36		59.5	40	491			
	2008.05-	2010.08	MT	R		Estate Engine BLS	GDS83266	Drive Shaft	36		59.5	40	601			
	2008.05-	2010.08			F	Estate Engine BLS	GC083002	Outer Joint	36	27	59.5	40	66	I		
	2008.05-	2010.08		L	F	Estate Engine BLS	GDS83236	Drive Shaft	36		59.5	40	484			
	2008.05-	2010.08	MT	R		Estate Engine BLS	GCI83016	Inner Joint		28		32				
2.0 EcoFuel (80 kW)	2006.04-				F	Estate Engine BSX	GCI83011	Inner Joint		33		34				
	2006.04-				F	Estate Engine BSX	GC083037	Outer Joint	36	30	59.5	40.5	55	I		
	2006.04-			R	F	Estate Engine BSX	GDS61113	Drive Shaft	36		59.5	40	814			
2.0 SDi (51 kW)	2004.03-	2010.08			F	Estate Engine BDJ/BST	GC083037	Outer Joint	36	30	59.5	40.5	55	I		
	2004.03-	2010.08	5MT		F	Estate Engine BDJ/BST	GCI83011	Inner Joint		33		34				
	2004.03-	2010.08	MT		F	Estate Engine BDJ/BST	GCI53002	Inner Joint		33		34				
	2004.03-	2010.08		L	F	Estate Engine BDJ/BST	GDS61268	Drive Shaft	36		59.5	40	516			
	2004.03-	2010.08		R	F	Estate Engine BDJ/BST	GDS61042	Drive Shaft	36		59.5	40.5	814			
2.0 TDi (103 kW)	2007.09-	2010.08			F	Estate Engine BMM	GC083037	Outer Joint	36	30	59.5	40.5	55	I		
2.0 TDi (125 kW)	2012.05-		SEMI-AT	L	F	Estate Engine CFJA	GDS83241	Drive Shaft	36		59.5	40	475			
	2012.05-			L/R	F	Estate Engine CFJA	GCI61057	Inner Joint		34		86				
2.0 TDi (81 kW)	2010.08-		MT	L	F	Estate Engine CLCA	GDS83236	Drive Shaft	36		59.5	40	484			
2.0 TDi 16V (103 kW)	2010.11-				F	Estate Engine CFHC/CLCB	GC083037	Outer Joint	36	30	59.5	40.5	55	I		
	2010.11-		6AT		F	Estate Engine CFHC/CLCB	GC061045	Outer Joint	36	27	59.5	40	65	M		
	2010.11-		6AT	R	F	Estate Engine CFHC/CLCB	GDS54011	Drive Shaft	36		59.5	40	755			
	2010.11-		SEMI-AT	L	F	Estate Engine CFHC/CLCB	GDS83241	Drive Shaft	36		59.5	40	475			
	2010.11-		6AT	L/R	F	Estate Engine CFHC/CLCB	GCI61057	Inner Joint		34		86				
	2010.11-		AT	R	F	Estate Engine CFHC/CLCB	GDS83355	Drive Shaft	36	23	59.5	40	799			
2.0 TDi 4motion (81 kW)	2010.08-			L		Estate Engine CFHF	GDS83295	Drive Shaft	36		59.5	40	491			
	2010.08-			R		Estate Engine CFHF	GDS83266	Drive Shaft	36		59.5	40	601			
	2010.08-				F	Estate Engine CFHF	GC083002	Outer Joint	36	27	59.5	40	66	I		
	2010.08-			L	F	Estate Engine CFHF	GDS83236	Drive Shaft	36		59.5	40	484			
	2010.08-			R		Estate Engine CFHF	GCI83016	Inner Joint		28		32				
<b>CADDY IV (2CA, 2CB)</b>																
1.2 TSi (63 kW)	2010.09-			L			GCI83016	Inner Joint		28		32				
1.2 TSi (77 kW)	2010.09-			L			GCI83016	Inner Joint		28		32				
1.6 TDi (55 kW)	2010.08-						GCI83016	Inner Joint		28		32				
1.6 TDi (75 kW)	2010.08-						GCI83016	Inner Joint		28		32				
<b>CC (358)</b>																
1.4 TSi (118 kW)	2011.11-		AT	L	F	Coupe Engine CKMA	GDS61281	Drive Shaft	36		59.5	40	528			
	2011.11-		MT	L	F	Coupe Engine CKMA	GDS61201	Drive Shaft	36		59.5	40.5	535			
	2011.11-		MT				GC083037	Outer Joint	36	30	59.5	40.5	55	I		
	2011.11-		MT				GC083002	Outer Joint	36	27	59.5	40	66	I		
	2011.11-						GCI83016	Inner Joint		28		32				
1.8 TSi (112 kW)	2011.11-		MT				GC083002	Outer Joint	36	27	59.5	40	66	I		
	2011.11-		MT				GCI83016	Inner Joint		28		32				

		TRANSM	L/R	F/R		G-AP Ref.	PRODUCT	ABS	Technical Specifications					
									YEAR	A	B	C	H	L
<b>VOLKSWAGEN</b>														
<b>CC (358)</b>														
1.8 TSi (118 kW)	2011.11-		7AT	L	F	Coupe Engine CDAA	GDS83236	Drive Shaft	36		59.5	40	484	
	2011.11-		MT	L	F	Coupe Engine CDAA	GDS61131	Drive Shaft	36		59.5	40	515	
	2011.11-		MT				GC083002	Outer Joint	36	27	59.5	40	66 I	
	2011.11-		MT				GCI83016	Inner Joint		28		32		
2.0 TDi (100 kW)	2011.11-		AT	L	F	Coupe Engine CFFA	GDS54013	Drive Shaft	36		59.5	40	479.5	
	2011.11-		MT	L	F	Coupe Engine CFFA	GDS83295	Drive Shaft	36		59.5	40	491	
	2011.11-		AT	R	F	Coupe Engine CFFA	GDS54011	Drive Shaft	36		59.5	40	755	
	2011.11-		MT	R	F	Coupe Engine CFFA	GDS83313	Drive Shaft	36		59.5	40	792	
	2011.11-		AT	R	F	Coupe Engine CFFA	GDS83355	Drive Shaft	36	23	59.5	40	799	
	2011.11-		MT				GCI83016	Inner Joint		28		32		
2.0 TDi (103 kW)	2011.11-		AT	L	F	Coupe Engine CFFB	GDS54013	Drive Shaft	36		59.5	40	479.5	
	2011.11-		MT	L	F	Coupe Engine CFFB	GDS83295	Drive Shaft	36		59.5	40	491	
	2011.11-		AT	R	F	Coupe Engine CFFB	GDS54011	Drive Shaft	36		59.5	40	755	
	2011.11-		MT	R	F	Coupe Engine CFFB	GDS83313	Drive Shaft	36		59.5	40	792	
	2011.11-		AT	L	F	Coupe Engine CFFB	GDS83241	Drive Shaft	36		59.5	40	475	
	2011.11-		MT	L	F	Coupe Engine CFFB	GDS83236	Drive Shaft	36		59.5	40	484	
	2011.11-		AT	R	F	Coupe Engine CFFB	GDS83355	Drive Shaft	36	23	59.5	40	799	
	2011.11-		MT	R	F	Coupe Engine CFFB	GDS61126	Drive Shaft	36		59.5	40	793	
2.0 TDi (125 kW)	2011.11-		AT	L	F	Coupe Engine CFGB/CLLA	GDS83241	Drive Shaft	36		59.5	40	475	
	2011.11-		MT	L	F	Coupe Engine CFGB/CLLA	GDS83236	Drive Shaft	36		59.5	40	484	
2.0 TDi 4motion (103 kW)	2011.11-				L	Coupe Engine CFFB	GDS83295	Drive Shaft	36		59.5	40	491	
	2011.11-				R	Coupe Engine CFFB	GDS83266	Drive Shaft	36		59.5	40	601	
	2011.11-		AT	L	F	Coupe Engine CFFB	GDS83241	Drive Shaft	36		59.5	40	475	
	2011.11-		MT	L	F	Coupe Engine CFFB	GDS83236	Drive Shaft	36		59.5	40	484	
	2011.11-				R	Coupe Engine CFFB	GCI83016	Inner Joint		28		32		
	2011.11-		MT				GC083002	Outer Joint	36	27	59.5	40	66 I	
	2011.11-						GCI83016	Inner Joint		28		32		
	2011.11-		MT				GCI83016	Inner Joint		28		32		
2.0 TDi 4motion (125 kW)	2011.11-				L	Coupe Engine CFGB	GDS54013	Drive Shaft	36		59.5	40	479.5	
	2011.11-		AT	L	F	Coupe Engine CFGB	GDS83241	Drive Shaft	36		59.5	40	475	
2.0 TSi (147 kW)	2011.11-					GCI83016	Inner Joint		28		32			
2.0 TSi (155 kW)	2011.11-					GCI83016	Inner Joint		28		32			
3.6 FSi 4motion (220 kW)	2011.11-					Ch-50N000001	GC083002	Outer Joint	36	27	59.5	40	66 I	
	2011.11-						GCI83016	Inner Joint		28		32		
<b>CORRADO (53I)</b>														
2.0 i (85 kW)	1993.04-	1995.12	MT		F	Coupe Engine 2E/ADY	GCI83006	Inner Joint		33		34		
<b>CRAFTER 30-35 (2E_)</b>														
2.5 TDi (65 kW)	2006.04-	2011.07			R	Bus Engine BJJ/CEBA	GC061009	Outer Joint	38	27	63	102	66 M	
<b>CRAFTER 30-50 (2E_)</b>														
2.5 TDi (65 kW)	2006.04-	2011.07			R	Box Engine BJJ/CEBA	GC061009	Outer Joint	38	27	63	102	66 M	
<b>CRAFTER 30-50 (2F_)</b>														
2.5 TDi (65 kW)	2006.04-	2011.07			R	Platform/Chassis Engine BJJ/CEBA	GC061009	Outer Joint	38	27	63	102	66 M	
<b>CROSS FOX</b>														
1.6 8V	2005.01-	2011.06	MT			EA111	GC061037	Outer Joint	22	30	51	78	61 I	
	2005.01-	2011.12				EA111	GC054003	Outer Joint	36	30	52	75	56 I	
<b>DERBY (86)</b>														
0.9 (29 kW)	1977.02-	1981.09	MT		F	Saloon Engine HA	GC083022	Outer Joint	20	25	45.5	74	49 I	
1.1 (37 kW)	1977.02-	1981.09	MT		F	Saloon Engine HB	GC083022	Outer Joint	20	25	45.5	74	49 I	
1.3 (44 kW)	1977.02-	1981.09	MT		F	Saloon Engine HH	GC083022	Outer Joint	20	25	45.5	74	49 I	
<b>DERBY (86C, 80)</b>														
1.0 (29 kW)	1981.10-	1984.12	MT		F	Saloon Engine GL	GC083022	Outer Joint	20	25	45.5	74	49 I	
1.1 (37 kW)	1981.10-	1983.07	MT		F	Saloon Engine HB	GC083022	Outer Joint	20	25	45.5	74	49 I	
1.3 (40 kW)	1983.08-	1984.12	MT		F	Saloon Engine HK	GC083022	Outer Joint	20	25	45.5	74	49 I	
1.3 (44 kW)	1981.08-	1983.07	MT		F	Saloon Engine HH	GC083022	Outer Joint	20	25	45.5	74	49 I	
1.3 (55 kW)	1982.09-	1984.12	MT		F	Saloon Engine GK	GC083022	Outer Joint	20	25	45.5	74	49 I	
	1982.09-	1984.12	MT		F	Saloon Engine GK	GC061002	Outer Joint	20	30	45.5	73.5	51 I	
<b>EOS (1F7, 1F8)</b>														
1.4 TSi (118 kW)	2008.05-				F	Convertible Engine CAVD/CTHD	GCI83011	Inner Joint		33		34		
	2008.05-		MT	L	F	Convertible Engine CAVD/CTHD	GDS61201	Drive Shaft	36		59.5	40.5	535	
	2008.05-					Convertible Engine CAVD/CTHD	GC061059	Outer Joint	36	33	59.5	40	59.5 I	









		TRANSM	L/R	F/R		G-AP Ref.	PRODUCT	ABS	Technical Specifications									
									YEAR	A	B	C	H	L	P			
<b>VOLKSWAGEN</b>																		
<b>EOS (1F7, 1F8)</b>																		
1.4 TSi (90 kW)	2009.11	MT				GC083037	Outer Joint		36	30	59.5	40.5	55	I				
	2007.11-			F	Convertible Engine CAXA	GCI83011	Inner Joint			33		34						
	2007.11-	MT	L	F	Convertible Engine CAXA	GDS61198	Drive Shaft		36		59.5	40.5	530					
	2007.11-				Convertible Engine CAXA	GC061059	Outer Joint		36	33	59.5	40	59.5	I				
1.6 FSi (85 kW)	2006.06-2008.05			F	Convertible Engine BLF	GC083037	Outer Joint		36	30	59.5	40.5	55	I				
	2006.06-2008.05	MT		F	Convertible Engine BLF	GCI83011	Inner Joint			33		34						
	2006.06-					GC083037	Outer Joint		36	30	59.5	40.5	55	I				
2.0 FSi (110 kW)	2006.03-2008.05			F	Convertible Engine BVY/BVZ	GC083037	Outer Joint		36	30	59.5	40.5	55	I				
	2006.03-2008.05	6AT		F	Convertible Engine BVY/BVZ	GCI61011	Inner Joint		26	32	31	68.5	85					
	2006.03-2008.05	MT		F	Convertible Engine BVY/BVZ	GCI83011	Inner Joint			33		34						
	2006.03-2008.05	6AT	L	F	Convertible Engine BVY/BVZ	GDS61093	Drive Shaft		36	26	59.5	40.5	587.5					
	2006.03-2008.05	MT	L	F	Convertible Engine BVY/BVZ	GDS61089	Drive Shaft		36		59.5	40.5	521					
	2006.03-2008.05	6AT	R	F	Convertible Engine BVY/BVZ	GDS61094	Drive Shaft		36	26	59.5	40.5	884					
	2006.03-					GC083037	Outer Joint		36	30	59.5	40.5	55	I				
2.0 TDi (100 kW)	2006.06-	MT				GCI83016	Inner Joint			28		32						
	2006.06-	MT/AT				GC083002	Outer Joint		36	27	59.5	40	66	I				
	2010.11-	AT	L	F	Convertible Engine CFFA	GDS54013	Drive Shaft		36		59.5	40	479.5					
	2010.11-	AT	R	F	Convertible Engine CFFA	GDS54011	Drive Shaft		36		59.5	40	755					
	2010.11-	MT	R	F	Convertible Engine CFFA	GDS83313	Drive Shaft		36		59.5	40	792					
	2010.11-	AT	L	F	Convertible Engine CFFA	GDS83241	Drive Shaft		36		59.5	40	475					
	2010.11-	MT	L	F	Convertible Engine CFFA	GDS83236	Drive Shaft		36		59.5	40	484					
	2010.11-	MT	R	F	Convertible Engine CFFA	GDS61126	Drive Shaft		36		59.5	40	793					
2.0 TDi (103 kW)	2006.06-2008.05	6MT/6AT		F	Convertible Engine BMM	GC083002	Outer Joint		36	27	59.5	40	66	I				
	2006.06-2008.05	AT	L	F	Convertible Engine BMM	GDS83241	Drive Shaft		36		59.5	40	475					
	2006.06-2008.05	AT	L	F	Convertible Engine BMM	GDS54013	Drive Shaft		36		59.5	40	479.5					
	2006.06-2008.05	MT	L	F	Convertible Engine BMM	GDS83236	Drive Shaft		36		59.5	40	484					
	2006.06-2008.05	MT	L	F	Convertible Engine BMM	GDS83295	Drive Shaft		36		59.5	40	491					
	2006.06-2008.05	AT	L/R	F	Convertible Engine BMM	GCI61057	Inner Joint			34		86						
	2006.06-2008.05	AT	R	F	Convertible Engine BMM	GDS83355	Drive Shaft		36	23	59.5	40	799					
	2006.06-2008.05	AT	R	F	Convertible Engine BMM	GDS54011	Drive Shaft		36		59.5	40	755					
	2006.06-2008.05	MT	R	F	Convertible Engine BMM	GDS61126	Drive Shaft		36		59.5	40	793					
	2006.06-2008.05	MT	R	F	Convertible Engine BMM	GDS83313	Drive Shaft		36		59.5	40	792					
	2006.06-	MT				GCI83016	Inner Joint			28		32						
	2006.06-	MT/AT				GC083002	Outer Joint		36	27	59.5	40	66	I				
2.0 TDi 16V (103 kW)	2008.05-			F	Convertible Engine CBAB/CFFB	GC083002	Outer Joint		36	27	59.5	40	66	I				
	2008.05-	AT	L	F	Convertible Engine CBAB/CFFB	GDS54013	Drive Shaft		36		59.5	40	479.5					
	2008.05-	AT	R	F	Convertible Engine CBAB/CFFB	GDS54011	Drive Shaft		36		59.5	40	755					
	2008.05-	MT	R	F	Convertible Engine CBAB/CFFB	GDS83313	Drive Shaft		36		59.5	40	792					
	2008.05-	AT	L	F	Convertible Engine CBAB/CFFB	GDS83241	Drive Shaft		36		59.5	40	475					
	2008.05-	MT	L	F	Convertible Engine CBAB/CFFB	GDS83236	Drive Shaft		36		59.5	40	484					
	2008.05-	AT	L/R	F	Convertible Engine CBAB/CFFB	GCI61057	Inner Joint			34		86						
	2008.05-	AT	R	F	Convertible Engine CBAB/CFFB	GDS83355	Drive Shaft		36	23	59.5	40	799					
	2008.05-	MT	R	F	Convertible Engine CBAB/CFFB	GDS61126	Drive Shaft		36		59.5	40	793					
	2008.05-	MT				GCI83016	Inner Joint			28		32						
	2008.05-	MT/AT				GC083002	Outer Joint		36	27	59.5	40	66	I				
2.0 TFSi (147 kW)	2006.03-	6MT/6AT		F	Convertible Engine BWA/CAWB/CCZA	GC083002	Outer Joint		36	27	59.5	40	66	I				
	2006.03-		L	F	Convertible Engine BWA/CAWB/CCZA	GDS83236	Drive Shaft		36		59.5	40	484					
	2006.03-		R	F	Convertible Engine BWA/CAWB/CCZA	GDS61126	Drive Shaft		36		59.5	40	793					
	2006.03-					GC083002	Outer Joint		36	27	59.5	40	66	I				
	2006.03-					GCI83016	Inner Joint			28		32						
2.0 TFSi (155 kW)	2006.03-					GC083002	Outer Joint		36	27	59.5	40	66	I				
	2006.03-					GCI83016	Inner Joint			28		32						
2.0 TSi (155 kW)	2009.11-		L	F	Convertible Engine CCZB	GDS83295	Drive Shaft		36		59.5	40	491					
	2009.11-		L	F	Convertible Engine CCZB	GDS83236	Drive Shaft		36		59.5	40	484					
	2009.11-		R	F	Convertible Engine CCZB	GDS61126	Drive Shaft		36		59.5	40	793					
3.2 V6 (184 kW)	2006.06-2009.05	6AT		F	Convertible Engine BUB/CBRA	GCI54004	Inner Joint			34		85						
	2006.06-2009.05	6AT		F	Convertible Engine BUB/CBRA	GC061045	Outer Joint		36	27	59.5	40	65	M				
	2006.06-2009.05		L/R	F	Convertible Engine BUB/CBRA	GCI61057	Inner Joint			34		86						
	2006.06-					GC083002	Outer Joint		36	27	59.5	40	66	I				
<b>FOX</b>																		
1.6 8V (EA111)	2004.01-2011.06	MT				GC061037	Outer Joint		22	30	51	78	61	I				

		YEAR	TRANSM	L/R	F/R		G-AP Ref.	PRODUCT	ABS	Technical Specifications						
										A	B	C	H	L	P	
<b>VOLKSWAGEN</b>																
<b>FOX (5Z1)</b>																
1.2 (40 kW)	2005.04-						GC054004	Outer Joint			36	30	52	75.5	47.5	I
1.2 (44 kW)	2005.04-						GC054004	Outer Joint			36	30	52	75.5	47.5	I
1.4 (55 kW)	2005.04-						GC054004	Outer Joint			36	30	52	75.5	47.5	I
1.6 TDi (51 kW)	2005.04-					SE	GC061010	Outer Joint			36	30	52	75	54.5	I
<b>FOX (5Z1, 5Z3)</b>																
1.2 (40 kW)	2005.04-				F	Hatchback Engine BMD/CHFB	GC054004	Outer Joint			36	30	52	75.5	47.5	I
	2005.04-		MT		F	Hatchback Engine BMD/CHFB	GC054002	Outer Joint			20	30	52	59.5	49.5	I
	2005.04-			L	F	Hatchback Engine BMD/CHFB	GDS83063	Drive Shaft			36		50.7	58.5	501	
	2005.04-				R	F	Hatchback Engine BMD/CHFB	GDS61063	Drive Shaft			36		50.7	58.5	751
	2005.04-			L/R	F	Hatchback Engine BMD/CHFB	GC083007	Outer Joint			22	30	51	78.7	51.1	I
	2005.04-		MT	R	F	Hatchback Engine BMD/CHFB	GDS61040	Drive Shaft			36		52	75.5	770	
1.2 (44 kW)	2010.09-				F	Hatchback Engine CHFA	GC054004	Outer Joint			36	30	52	75.5	47.5	I
	2010.09-			L/R	F	Hatchback Engine CHFA	GC083007	Outer Joint			22	30	51	78.7	51.1	I
	2010.09-				R	F	Hatchback Engine CHFA	GDS61040	Drive Shaft			36		52	75.5	770
1.4 (55 kW)	2005.04-				F	Hatchback Engine BKR	GC054004	Outer Joint			36	30	52	75.5	47.5	I
	2005.04-		MT	L/R	F	Hatchback Engine BKR	GC083007	Outer Joint			22	30	51	78.7	51.1	I
	2005.04-		MT	R	F	Hatchback Engine BKR	GDS61040	Drive Shaft			36		52	75.5	770	
1.4 TDi (51 kW)	2005.04-				F	Hatchback Engine BNM	GC061010	Outer Joint			36	30	52	75	54.5	I
	2005.04-				F	Hatchback Engine BNM	GC083024	Outer Joint			36	30	50.75	59	54.5	I
	2005.04-		MT	R	F	Hatchback Engine BNM	GDS61223	Drive Shaft			36		52	59	757	
<b>GOL</b>																
-							GC061014	Outer Joint			22	30	51	78	61	I
1							GC061019	Outer Joint			22	28	51	78.7	51.5	O+M
1.0 8V	1992.10-	1996.12	MT				GC061033	Outer Joint			22	30	51	77.5	52	I
1.0 EA111 16V Power	1997.01-	2006.12	MT				GCI99057	Inner Joint				28		32		
	1997.01-	2006.12	MT				GC061030	Outer Joint			22	28	51	77.5	50	M
	1997.01-	2006.12	MT	L			GDS61079	Drive Shaft			22		51	78.7	634	
	1997.01-	2006.12	MT	R			GDS61080	Drive Shaft			22		51	78.7	605	
	1997.01-	2006.12	MT	L/R			GC061031	Outer Joint			22	28	51	78.7	51.1	M
1.0 EA111 8V Power	1997.01-	2006.12	MT				GCI99057	Inner Joint				28		32		
	1997.01-	2006.12	MT				GC061030	Outer Joint			22	28	51	77.5	50	M
	1997.01-	2006.12	MT	L			GDS61079	Drive Shaft			22		51	78.7	634	
	1997.01-	2006.12	MT	R			GDS61080	Drive Shaft			22		51	78.7	605	
	1997.01-	2006.12	MT	L/R			GC061031	Outer Joint			22	28	51	78.7	51.1	M
1.0 Mi 8V/16V/Power 16V	1997-	2001.11		L/R			GC061031	Outer Joint			22	28	51	78.7	51.1	M
	1997-	2001.11		L			GDS61117	Drive Shaft			22		51	78.7	634	
	1997-	2001.11		R			GDS61118	Drive Shaft			22		51	78.7	605	
1.0 Turbo	2000.01-	2006.12	MT				GCI53002	Inner Joint				33		34		
	2000.01-	2006.12	MT				GC061028	Outer Joint			22	30	51	78	61	I
2.0 16V	1995.01-	2006.12	MT				GC061034	Outer Joint			33	30	64	33.5	61	I
	1995.01-	2006.12	MT				GC061023	Outer Joint	43T		33	30	64	33.5	61	I
2.0 8V	1995.01-	2006.12	MT				GC099134	Outer Joint	43T		22	30	51	78	61	I
	1996.01-	2006.12	MT				GC061028	Outer Joint			22	30	51	78	61	I
<b>GOL G IV</b>																
1.0 8V (EA111)	2005.01-	2006.12	MT				GCI99057	Inner Joint				28		32		
	2005.01-	2006.12	MT				GC061030	Outer Joint			22	28	51	77.5	50	M
	2005.01-	2006.12	MT	L			GDS61079	Drive Shaft			22		51	78.7	634	
	2005.01-	2006.12	MT	R			GDS61080	Drive Shaft			22		51	78.7	605	
	2005.01-	2006.12	MT	L/R			GC061031	Outer Joint			22	28	51	78.7	51.1	M
<b>GOL MI</b>																
1.0 8/16V	1997.01-	2006.12	MT				GCI99057	Inner Joint				28		32		
	1997.01-	2006.12	MT				GC061030	Outer Joint			22	28	51	77.5	50	M
	1997.01-	2006.12	MT	L			GDS61079	Drive Shaft			22		51	78.7	634	
	1997.01-	2006.12	MT	R			GDS61080	Drive Shaft			22		51	78.7	605	
	1997.01-	2006.12	MT	L/R			GC061031	Outer Joint			22	28	51	78.7	51.1	M
<b>GOLF</b>																
1.6 8V	1999.01-	2005.12	MT/AT				GCI53002	Inner Joint				33		34		
	1999.01-	2005.12	MT/AT				GC083070	Outer Joint			36	30	53	78	60	I
1.8 8V	1994.01-	1998.12	MT/AT				GCI61022	Inner Joint				33		34		
1.9	1999.01-	2005.12	MT/AT				GCI53002	Inner Joint				33		34		
2.0 8V	1994.01-	1998.12	AT				GCI61022	Inner Joint				33		34		



		TRANSM	L/R	F/R		G-AP Ref.	PRODUCT	ABS	Technical Specifications								
									YEAR	A	B	C	H	L	P		
<b>VOLKSWAGEN</b>																	
<b>GOLF</b>																	
2.0 8V	1994.01-	1998.12	MT			GCI61022	Inner Joint		33		34						
	1999.01-	2005.12	MT/AT			GCI53002	Inner Joint		33		34						
	1999.01-	2005.12	MT/AT			GC083070	Outer Joint	36	30	53	78	60	I				
<b>GOLF (155)</b>																	
1.5 (51 kW)	1979.01-	1983.11	MT		F	Convertible Engine JB	GC061001	Outer Joint	22	30	50	77.5	51	O			
	1979.01-	1983.11	MT		F	Convertible Engine JB	GC061013	Outer Joint	22	30	50	77.5	51	I			
	1979.01-	1983.11			F	Convertible Engine JB	GC053006	Outer Joint	22	30	50	78.5	52	I			
1.6 (53 kW)	1986.04-	1990.02	MT&AT	R	F	Convertible Engine RE	GDS61054	Drive Shaft	22		53	78.5	749				
	1986.04-	1990.02	MT	R	F	Convertible Engine RE	GDS61006	Drive Shaft	22		53.2	78	747				
1.6 (55 kW)	1983.08-	1992.04	MT&AT	R	F	Convertible Engine EW/HN	GDS61054	Drive Shaft	22		53	78.5	749				
	1983.08-	1992.04	MT	R	F	Convertible Engine EW/HN	GDS61006	Drive Shaft	22		53.2	78	747				
1.6 (81 kW)	1979.08-	1982.07	MT		F	Convertible Engine EG	GC061001	Outer Joint	22	30	50	77.5	51	O			
	1979.08-	1982.07	MT		F	Convertible Engine EG	GC061013	Outer Joint	22	30	50	77.5	51	I			
1.8 (66 kW)	1983.08-	1992.09	MT&AT	R	F	Convertible Engine EX	GDS61054	Drive Shaft	22		53	78.5	749				
	1983.08-	1992.09	MT	R	F	Convertible Engine EX	GDS61006	Drive Shaft	22		53.2	78	747				
1.8 (70 kW)	1983.08-	1993.04	MT&AT	R	F	Convertible Engine JH	GDS61054	Drive Shaft	22		53	78.5	749				
	1983.08-	1993.04	MT	R	F	Convertible Engine JH	GDS61006	Drive Shaft	22		53.2	78	747				
1.8 (72 kW)	1989.08-	1993.03	AT	R	F	Convertible Engine 2H	GDS61054	Drive Shaft	22		53	78.5	749				
	1989.08-	1993.03	MT	R	F	Convertible Engine 2H	GDS61006	Drive Shaft	22		53.2	78	747				
1.8 (82 kW)	1982.08-	1989.12	MT		F	Convertible Engine DX/EV/PB	GC061013	Outer Joint	22	30	50	77.5	51	I			
	1982.08-	1989.12	MT	R	F	Convertible Engine DX/EV/PB	GDS61006	Drive Shaft	22		53.2	78	747				
<b>GOLF (17)</b>																	
1.1 (37 kW)	1974.04-	1983.07			F	Hatchback Engine FA/GG	GC061001	Outer Joint	22	30	50	77.5	51	O			
	1974.04-	1983.07			F	Hatchback Engine FA/GG	GC061013	Outer Joint	22	30	50	77.5	51	I			
	1974.04-	1983.07			F	Hatchback Engine FA/GG	GC053006	Outer Joint	22	30	50	78.5	52	I			
1.1 (38 kW)	1976.08-	1980.07	MT		F	Hatchback Engine FJ	GC061013	Outer Joint	22	30	50	77.5	51	I			
	1976.08-	1980.07			F	Hatchback Engine FJ	GC053006	Outer Joint	22	30	50	78.5	52	I			
1.3 (44 kW)	1979.08-	1983.07	MT		F	Hatchback Engine GF	GC061001	Outer Joint	22	30	50	77.5	51	O			
	1979.08-	1983.07	MT		F	Hatchback Engine GF	GC061013	Outer Joint	22	30	50	77.5	51	I			
	1979.08-	1983.07			F	Hatchback Engine GF	GC053006	Outer Joint	22	30	50	78.5	52	I			
1.5 (51 kW)	1977.08-	1983.07	MT&AT		F	Hatchback Engine JB	GC061001	Outer Joint	22	30	50	77.5	51	O			
	1977.08-	1983.07	MT&AT		F	Hatchback Engine JB	GC061013	Outer Joint	22	30	50	77.5	51	I			
	1977.08-	1983.07			F	Hatchback Engine JB	GC053006	Outer Joint	22	30	50	78.5	52	I			
1.6 (55 kW)	1975.08-	1984.02	MT/AT		F	Hatchback Engine JP	GC061001	Outer Joint	22	30	50	77.5	51	O			
	1975.08-	1984.02			F	Hatchback Engine FP	GC053006	Outer Joint	22	30	50	78.5	52	I			
1.6 D (40 kW)	1980.08-	1983.07	MT		F	Hatchback Engine CR/JK	GC061013	Outer Joint	22	30	50	77.5	51	I			
	1980.08-	1983.07			F	Hatchback Engine CR/JK	GC053006	Outer Joint	22	30	50	78.5	52	I			
1.6 GTi (81 kW)	1976.08-	1982.07	MT		F	Hatchback Engine EG	GC061001	Outer Joint	22	30	50	77.5	51	O			
	1976.08-	1982.07	MT		F	Hatchback Engine EG	GC061013	Outer Joint	22	30	50	77.5	51	I			
1.6 TD (51 kW)	1982.03-	1983.07	MT		F	Hatchback Engine CY	GC061013	Outer Joint	22	30	50	77.5	51	I			
	1982.03-	1983.07			F	Hatchback Engine CY	GC053006	Outer Joint	22	30	50	78.5	52	I			
1.8 GTi (82 kW)	1982.08-	1983.12	MT		F	Hatchback Engine DX	GC061013	Outer Joint	22	30	50	77.5	51	I			
<b>GOLF / GLX / GTI</b>																	
-	1995-	1998.07					GC099136	Outer Joint	22	30	51	78	61	I			
<b>GOLF GTI</b>																	
2.0 8V	1994.01-	1998.12	AT				GCI61022	Inner Joint		33		34					
	1994.01-	1998.12	MT				GCI61022	Inner Joint		33		34					
	1999.01-	2005.12	MT/AT				GCI53002	Inner Joint		33		34					
	1999.01-	2005.12	MT/AT				GC083070	Outer Joint	36	30	53	78	60	I			
<b>GOLF II (19E, 1G1)</b>																	
1.0 (33 kW)	1983.11-	1985.08	MT	R	F	Hatchback Engine GN	GDS61008	Drive Shaft	22		53	78.5	774				
1.0 (37 kW)	1985.08-	1991.10	MT	R	F	Hatchback Engine HZ	GDS61008	Drive Shaft	22		53	78.5	774				
1.3 (40 kW)	1983.08-	1987.06	MT	R	F	Hatchback Engine HK/MH	GDS61008	Drive Shaft	22		53	78.5	774				
<b>GOLF III</b>																	
-	1993-						GCI61004	Inner Joint		34		59.2					
2.0 16V	1993.01-	1998.03	MT	R	F		GDS61062	Drive Shaft	36		53.2	77.5	788				
2.0 8V	1994.03-	1999.07	MT	R	F		GDS61062	Drive Shaft	36		53.2	77.5	788				
2.8 VR6	1992.02-	1998.03	MT	R	F		GDS61062	Drive Shaft	36		53.2	77.5	788				
<b>GOLF III (1E7)</b>																	
1.6 (74 kW)	1998.06-	2002.06	AT		F	Convertible Engine AFT/AKS	GC083036	Outer Joint	36	30	53.2	77.5	61	I			
	1998.06-	2002.06	MT/AT		F	Convertible Engine AFT/AKS	GCI83008	Inner Joint		33		32					





		TRANSM	L/R	F/R		G-AP Ref.	PRODUCT	ABS	Technical Specifications						
									YEAR	A	B	C	H	L	P
<b>VOLKSWAGEN</b>															
<b>GOLF III (1E7)</b>															
1.8 (55 kW)	1998.06-	2002.06	MT		F	Convertible Engine AAM/ANN	GC053007	Outer Joint	22	30	53.2	78	61	I	
1.8 (66 kW)	1998.06-	2002.06			F	Convertible Engine ADZ/ANP	GC053007	Outer Joint	22	30	53.2	78	61	I	
1.9 TDi (66 kW)	1998.06-	2002.06	MT		F	Convertible Engine AHU/ALE	GC083036	Outer Joint	36	30	53.2	77.5	61	I	
	1998.06-	2002.06	MT		F	Convertible Engine AHU/ALE	GC061018	Outer Joint	22	30	53	78.5	61	I	
1.9 TDi (81 kW)	1998.06-	2002.06	MT		F	Convertible Engine AFN/AVG	GC083036	Outer Joint	36	30	53.2	77.5	61	I	
	1998.06-	2002.06	MT		F	Convertible Engine AFN/AVG	GC061018	Outer Joint	22	30	53	78.5	61	I	
2.0 (85 kW)	1998.06-	2002.06			F	Convertible Engine AGG/AKR/ATU/AWF/AWG	GC053007	Outer Joint	22	30	53.2	78	61	I	
<b>GOLF III (1H1)</b>															
1.4 (40 kW)	1991.11-	1997.08	MT	L	F	Hatchback Engine ABD/AEX	GDS61172	Drive Shaft	22		53	78	584.5		
	1991.11-	1997.08	MT	R	F	Hatchback Engine ABD/AEX	GDS61067	Drive Shaft	22		51	78.7	781		
	1991.11-	1997.08	MT	R	F	Hatchback Engine ABD/AEX	GDS61055	Drive Shaft	22		53	78.5	796		
1.4 (44 kW)	1991.10-	1997.08	MT	L	F	Hatchback Engine ABD/AEX	GDS61172	Drive Shaft	22		53	78	584.5		
	1991.10-	1997.08	MT	R	F	Hatchback Engine ABD/AEX	GDS61067	Drive Shaft	22		51	78.7	781		
	1991.10-	1997.08	MT	R	F	Hatchback Engine ABD/AEX	GDS61055	Drive Shaft	22		53	78.5	796		
1.6 (55 kW)	1992.09-	1997.08	MT	L	F	Hatchback Engine ABU/AEA/AEE	GDS61172	Drive Shaft	22		53	78	584.5		
	1992.09-	1997.08	MT	R	F	Hatchback Engine ABU/AEA/AEE	GDS61067	Drive Shaft	22		51	78.7	781		
	1992.09-	1997.08	MT	R	F	Hatchback Engine ABU/AEA/AEE	GDS61055	Drive Shaft	22		53	78.5	796		
1.6 (74 kW)	1995.07-	1997.08	MT	R	F	Hatchback Engine AEK/AFT/AKS	GDS61055	Drive Shaft	22		53	78.5	796		
	1995.07-	1997.08	AT	L	F	Hatchback Engine AEK/AFT/AKS	GDS61011	Drive Shaft	22		53.2	78	547		
	1995.07-	1997.08	AT	R	F	Hatchback Engine AEK/AFT/AKS	GDS61028	Drive Shaft	22		53.2	78	767		
1.8 (55 kW)	1991.11-	1997.08	MT/AT	R	F	Hatchback Engine AAM	GDS61009	Drive Shaft	22		53.2	78	789		
	1991.11-	1997.08	MT		F	Hatchback Engine AAM	GCI83006	Inner Joint		33		34			
	1991.11-	1997.08	AT	L	F	Hatchback Engine AAM	GDS61011	Drive Shaft	22		53.2	78	547		
	1991.11-	1997.08	AT	R	F	Hatchback Engine AAM	GDS61028	Drive Shaft	22		53.2	78	767		
	1991.11-	1997.08	MT&AT	L	F	Hatchback Engine AAM	GDS61001	Drive Shaft	22		53.2	78	557		
1.8 (66 kW)	1991.11-	1997.08		R	F	Hatchback Engine ABS/ACC/ADZ	GDS61009	Drive Shaft	22		53.2	78	789		
	1991.11-	1997.08	MT		F	Hatchback Engine ABS/ACC/ADZ	GCI83006	Inner Joint		33		34			
	1991.11-	1997.08	AT	L	F	Hatchback Engine ABS/ACC/ADZ	GDS61011	Drive Shaft	22		53.2	78	547		
	1991.11-	1997.08	AT	R	F	Hatchback Engine ABS/ACC/ADZ	GDS61028	Drive Shaft	22		53.2	78	767		
	1991.11-	1997.08	MT&AT	L	F	Hatchback Engine ABS/ACC/ADZ	GDS61001	Drive Shaft	22		53.2	78	557		
1.9 D (48 kW)	1991.11-	1997.08	MT	R	F	Hatchback Engine 1Y	GDS61055	Drive Shaft	22		53	78.5	796		
1.9 SDi (47 kW)	1995.07-	1997.08	MT	R	F	Hatchback Engine AEY	GDS61055	Drive Shaft	22		53	78.5	796		
1.9 TD, GTD (55 kW)	1991.11-	1997.08	MT&AT	R	F	Hatchback Engine AAZ	GDS61009	Drive Shaft	22		53.2	78	789		
	1991.11-	1997.08	MT		F	Hatchback Engine AAZ	GCI83006	Inner Joint		33		34			
	1991.11-	1997.08	AT	L	F	Hatchback Engine AAZ	GDS61011	Drive Shaft	22		53.2	78	547		
	1991.11-	1997.08	AT	R	F	Hatchback Engine AAZ	GDS61028	Drive Shaft	22		53.2	78	767		
	1991.11-	1997.08	MT&AT	L	F	Hatchback Engine AAZ	GDS61001	Drive Shaft	22		53.2	78	557		
1.9 TDi (66 kW)	1993.09-	1997.08	MT	R	F	Hatchback Engine 1Z/AHU/ALE	GDS61002	Drive Shaft	22		53	78.5	793		
	1993.09-	1997.08	MT	L	F	Hatchback Engine 1Z/AHU/ALE	GDS61001	Drive Shaft	22		53.2	78	557		
1.9 TDi (81 kW)	1996.04-	1997.08	MT	R	F	Hatchback Engine AFN	GDS61002	Drive Shaft	22		53	78.5	793		
	1996.04-	1997.08	MT	L	F	Hatchback Engine AFN	GDS61001	Drive Shaft	22		53.2	78	557		
2.0 (85 kW)	1991.11-	1997.08	MT&AT	R	F	Hatchback Engine 2E/ABA/ADY/AGG/AKR	GDS61009	Drive Shaft	22		53.2	78	789		
	1991.11-	1997.08	MT		F	Hatchback Engine 2E/ABA/ADY/AGG/AKR	GCI83006	Inner Joint		33		34			
	1991.11-	1997.08	AT	L	F	Hatchback Engine 2E/ABA/ADY/AGG/AKR	GDS61011	Drive Shaft	22		53.2	78	547		
	1991.11-	1997.08	AT	R	F	Hatchback Engine 2E/ABA/ADY/AGG/AKR	GDS61028	Drive Shaft	22		53.2	78	767		
	1991.11-	1997.08	MT	L	F	Hatchback Engine 2E/ABA/ADY/AGG/AKR	GDS61001	Drive Shaft	22		53.2	78	557		
<b>GOLF III CABRIOLET (1E7)</b>															
1.8 (55 kW)	1993.07-	1998.05	MT	R	F	Convertible Engine AAM	GDS61009	Drive Shaft	22		53.2	78	789		
	1993.07-	1998.05	MT	L	F	Convertible Engine AAM	GDS61001	Drive Shaft	22		53.2	78	557		
1.8 (66 kW)	1993.07-	1998.05	MT/AT	R	F	Convertible Engine ABS/ADZ	GDS61009	Drive Shaft	22		53.2	78	789		
	1993.07-	1998.05	MT	L	F	Convertible Engine ABS/ADZ	GDS61001	Drive Shaft	22		53.2	78	557		
1.9 TDi (66 kW)	1995.08-	1998.05	MT	L	F	Convertible Engine 1Z/AHU/ALE	GDS61001	Drive Shaft	22		53.2	78	557		
	1995.08-	1998.05	MT	R	F	Convertible Engine 1Z/AHU/ALE	GDS61002	Drive Shaft	22		53	78.5	793		
1.9 TDi (81 kW)	1996.07-	1998.05	MT	L	F	Convertible Engine AFN	GDS61001	Drive Shaft	22		53.2	78	557		
	1996.07-	1998.05	MT	R	F	Convertible Engine AFN	GDS61002	Drive Shaft	22		53	78.5	793		
2.0 (85 kW)	1993.07-	1998.05	MT/AT	L	F	Convertible Engine 2E/ADY/AGG/AKR	GDS61001	Drive Shaft	22		53.2	78	557		
	1993.07-	1998.05	MT/AT	R	F	Convertible Engine 2E/ADY/AGG/AKR	GDS61009	Drive Shaft	22		53.2	78	789		
<b>GOLF III VARIANT (1H5)</b>															
1.4 (40 kW)	1993.07-	1999.04	MT	L	F	Estate Engine ABD	GDS61172	Drive Shaft	22		53	78	584.5		
	1993.07-	1999.04	MT	R	F	Estate Engine ABD	GDS61067	Drive Shaft	22		51	78.7	781		
1.4 (44 kW)	1993.07-	1999.04	MT	L	F	Estate Engine ABD/AEX/APQ	GDS61172	Drive Shaft	22		53	78	584.5		



		TRANSM	L/R	F/R		G-AP Ref.	PRODUCT	ABS	Technical Specifications								
									YEAR	A	B	C	H	L	P		
<b>VOLKSWAGEN</b>																	
<b>GOLF III VARIANT (1H5)</b>																	
1.4 (44 kW)	1993.07-	1999.04	MT	R	F	Estate Engine ABD/AEX/APQ	GDS61067	Drive Shaft	22		51	78.7	781				
1.6 (74 kW)	1994.07-	1999.04	MT	R	F	Estate Engine AEK/AFT/AKS	GDS61009	Drive Shaft	22		53.2	78	789				
	1994.07-	1999.04	MT	R	F	Estate Engine AEK/AFT/AKS	GDS61055	Drive Shaft	22		53	78.5	796				
	1994.07-	1999.04	AT	L	F	Estate Engine AEK/AFT/AKS	GDS61011	Drive Shaft	22		53.2	78	547				
	1994.07-	1999.04	AT	R	F	Estate Engine AEK/AFT/AKS	GDS61028	Drive Shaft	22		53.2	78	767				
1.8 (55 kW)	1993.07-	1999.04	MT	L	F	Estate Engine AAM/ANN	GDS61001	Drive Shaft	22		53.2	78	557				
	1993.07-	1999.04	MT	R	F	Estate Engine AAM/ANN	GDS61009	Drive Shaft	22		53.2	78	789				
	1993.07-	1999.04	AT	L	F	Estate Engine AAM/ANN	GDS61011	Drive Shaft	22		53.2	78	547				
	1993.07-	1999.04	AT	R	F	Estate Engine AAM/ANN	GDS61028	Drive Shaft	22		53.2	78	767				
1.8 (66 kW)	1993.07-	1999.04	MT&AT	L	F	Estate Engine ABS/ADZ/ANP	GDS61001	Drive Shaft	22		53.2	78	557				
	1993.07-	1999.04		R	F	Estate Engine ABS/ADZ/ANP	GDS61009	Drive Shaft	22		53.2	78	789				
	1993.07-	1999.04	AT	L	F	Estate Engine ABS/ADZ/ANP	GDS61011	Drive Shaft	22		53.2	78	547				
	1993.07-	1999.04	AT	R	F	Estate Engine ABS/ADZ/ANP	GDS61028	Drive Shaft	22		53.2	78	767				
1.8 Syncro (66 kW)	1994.10-	1999.04	MT	L	F	Estate Engine ADZ	GDS61001	Drive Shaft	22		53.2	78	557				
	1994.10-	1999.04	MT	R	F	Estate Engine ADZ	GDS61009	Drive Shaft	22		53.2	78	789				
1.9 D (48 kW)	1993.07-	1999.04	MT	R	F	Estate Engine 1Y	GDS61055	Drive Shaft	22		53	78.5	796				
1.9 SDi (47 kW)	1995.07-	1999.04	MT	R	F	Estate Engine AEY	GDS61055	Drive Shaft	22		53	78.5	796				
	1.9 TD (55 kW)	1993.07-	1999.04	MT&AT	L	F	Estate Engine AAZ	GDS61001	Drive Shaft	22		53.2	78	557			
		1993.07-	1999.04	MT&AT	R	F	Estate Engine AAZ	GDS61009	Drive Shaft	22		53.2	78	789			
		1993.07-	1999.04	AT	L	F	Estate Engine AAZ	GDS61011	Drive Shaft	22		53.2	78	547			
1.9 TDi (66 kW)	1993.07-	1999.04	AT	R	F	Estate Engine AAZ	GDS61028	Drive Shaft	22		53.2	78	767				
	1994.03-	1999.04	MT	L	F	Estate Engine 1Z/AHU/ALE	GDS61001	Drive Shaft	22		53.2	78	557				
1.9 TDi (81 kW)	1994.03-	1999.04	MT	R	F	Estate Engine 1Z/AHU/ALE	GDS61002	Drive Shaft	22		53	78.5	793				
	1996.04-	1999.04	MT	L	F	Estate Engine AFN	GDS61001	Drive Shaft	22		53.2	78	557				
2.0 (85 kW)	1996.04-	1999.04	MT	R	F	Estate Engine AFN	GDS61002	Drive Shaft	22		53	78.5	793				
	1993.07-	1999.04	MT&AT	L	F	Estate Engine 2E/ADY/AGG/AKR	GDS61001	Drive Shaft	22		53.2	78	557				
	1993.07-	1999.04	MT&AT	R	F	Estate Engine 2E/ADY/AGG/AKR	GDS61009	Drive Shaft	22		53.2	78	789				
GOLF IV (1J1)	1993.07-	1999.04	AT	L	F	Estate Engine 2E/ADY/AGG/AKR	GDS61011	Drive Shaft	22		53.2	78	547				
	1993.07-	1999.04	AT	R	F	Estate Engine 2E/ADY/AGG/AKR	GDS61028	Drive Shaft	22		53.2	78	767				
1.4 16V (55 kW)	1997.08-	2005.06	AT		F	Hatchback Engine AHW/AKQ/APE/AXP/BCA	GC083036	Outer Joint	36	30	53.2	77.5	61	I			
	1997.08-	2005.06	MT		F	Hatchback Engine AHW/AKQ/APE/AXP/BCA	GC083033	Outer Joint	36	30	53	78.5	51	I			
	1997.08-	2005.06	MT		F	Hatchback Engine AHW/AKQ/APE/AXP/BCA	GCI83004	Inner Joint		33		32					
	1997.08-	2005.06	MT/AT		F	Hatchback Engine AHW/AKQ/APE/AXP/BCA	GCI83008	Inner Joint		33		32					
	1997.08-	2005.06	MT	L	F	Hatchback Engine AHW/AKQ/APE/AXP/BCA	GDS61045	Drive Shaft	36		53	78.5	555				
	1997.08-	2005.06	MT	R	F	Hatchback Engine AHW/AKQ/APE/AXP/BCA	GDS83046	Drive Shaft	36		53	78.5	822				
1.6 (74 kW)	1997.08-	2004.05	AT		F	Hatchback Engine AEH/AKL/APF	GC083036	Outer Joint	36	30	53.2	77.5	61	I			
	1997.08-	2004.05	MT		F	Hatchback Engine AEH/AKL/APF	GC083033	Outer Joint	36	30	53	78.5	51	I			
	1997.08-	2004.05	MT		F	Hatchback Engine AEH/AKL/APF	GCI83004	Inner Joint		33		32					
	1997.08-	2004.05	MT/AT		F	Hatchback Engine AEH/AKL/APF	GCI83008	Inner Joint		33		32					
	1997.08-	2004.05	MT/AT		F	Hatchback Engine AEH/AKL/APF	GCI61006	Inner Joint		30		57.6					
	1997.08-	2004.05	AT	L	F	Hatchback Engine AEH/AKL/APF	GDS61156	Drive Shaft	36		53	78	554.5				
	1997.08-	2004.05	AT	L	F	Hatchback Engine AEH/AKL/APF	GCI61062	Inner Joint		30		59					
	1997.08-	2004.05	MT	L	F	Hatchback Engine AEH/AKL/APF	GDS61045	Drive Shaft	36		53	78.5	555				
1.6 (75 kW)	1997.08-	2004.05	MT	R	F	Hatchback Engine AEH/AKL/APF	GDS83046	Drive Shaft	36		53	78.5	822				
	2000.08-	2005.06			F	Hatchback Engine AVU/BFQ	GC083036	Outer Joint	36	30	53.2	77.5	61	I			
	2000.08-	2005.06	MT/AT		F	Hatchback Engine AVU/BFQ	GCI61006	Inner Joint		30		57.6					
	2000.08-	2005.06	AT	L	F	Hatchback Engine AVU/BFQ	GDS61156	Drive Shaft	36		53	78	554.5				
	2000.08-	2005.06	AT	L	F	Hatchback Engine AVU/BFQ	GCI61062	Inner Joint		30		59					
	2000.08-	2005.06	MT	L	F	Hatchback Engine AVU/BFQ	GDS61045	Drive Shaft	36		53	78.5	555				
1.6 16V (77 kW)	2000.08-	2005.06	MT	R	F	Hatchback Engine AVU/BFQ	GDS83046	Drive Shaft	36		53	78.5	822				
	2000.02-	2005.06			F	Hatchback Engine ATN/AUS/AZD/BCB	GC083036	Outer Joint	36	30	53.2	77.5	61	I			
	2000.02-	2005.06	5MT		F	Hatchback Engine ATN/AUS/AZD/BCB	GCI61005	Inner Joint		30		57.6					
	2000.02-	2005.06	MT	L	F	Hatchback Engine ATN/AUS/AZD/BCB	GDS61202	Drive Shaft	36		53.2	77.5	547				
	2000.02-	2005.06		L	F	Hatchback Engine ATN/AUS/AZD/BCB	GDS61312	Drive Shaft	36		53	78	546				
1.6 FSi (81 kW)	2000.02-	2005.06	MT	R	F	Hatchback Engine ATN/AUS/AZD/BCB	GDS61203	Drive Shaft	36		53.2	77.5	810				
	2002.01-	2005.06			F	Hatchback Engine BAD	GC083036	Outer Joint	36	30	53.2	77.5	61	I			
1.8 (92 kW)	2002.01-	2005.06			F	Hatchback Engine BAD	GCI61005	Inner Joint		30		57.6					
	1997.08-	2005.06	AT		F	Hatchback Engine AGN/BAF	GCI83008	Inner Joint		33		32					
	1997.08-	2005.06	MT		F	Hatchback Engine AGN/BAF	GC083036	Outer Joint	36	30	53.2	77.5	61	I			
1997.08-	2005.06	MT		F	Hatchback Engine AGN/BAF	GCI83004	Inner Joint		33		32						





		TRANSM	L/R	F/R		G-AP Ref.	PRODUCT	ABS	Technical Specifications							
									YEAR	A	B	C	H	L	P	
<b>VOLKSWAGEN</b>																
<b>GOLF IV (1J1)</b>																
1.8 (92 kW)	1997.08-	2005.06	MT		F	Hatchback Engine AGN/BAF	GCI83011	Inner Joint		33		34				
	1997.08-	2005.06	AT	L	F	Hatchback Engine AGN/BAF	GDS61156	Drive Shaft	36		53	78	554.5			
	1997.08-	2005.06	AT	L	F	Hatchback Engine AGN/BAF	GCI61062	Inner Joint		30		59				
	1997.08-	2005.06	MT	L	F	Hatchback Engine AGN/BAF	GDS61021	Drive Shaft	36		53.2	77.5	564.5			
1.8 4motion (92 kW)	1998.05-	2005.06	AT			Hatchback Engine AGN	GCI83008	Inner Joint		33		32				
	1998.05-	2005.06	MT			Hatchback Engine AGN	GC083036	Outer Joint	36	30	53.2	77.5	61	I		
	1998.05-	2005.06	MT		F	Hatchback Engine AGN	GCI83004	Inner Joint		33		32				
	1998.05-	2005.06			F/R	Hatchback Engine AGN	GCI83011	Inner Joint		33		34				
	1998.05-	2005.06	MT		R	Hatchback Engine AGN	GCI53002	Inner Joint		33		34				
1.8 T (110 kW)	1997.08-	2005.06	MT		F	Hatchback Engine AGU/AQA/ARZ/AUM/AWD	GC083036	Outer Joint	36	30	53.2	77.5	61	I		
	1997.08-	2005.06	MT/AT		F	Hatchback Engine AGU/AQA/ARZ/AUM/AWD	GCI61006	Inner Joint		30		57.6				
	1997.08-	2005.06	AT	L	F	Hatchback Engine AGU/AQA/ARZ/AUM/AWD	GDS83374	Drive Shaft	36		53	77.5	521			
	1997.08-	2005.06	MT	L	F	Hatchback Engine AGU/AQA/ARZ/AUM/AWD	GDS61156	Drive Shaft	36		53	78	554.5			
	1997.08-	2005.06	MT	L	F	Hatchback Engine AGU/AQA/ARZ/AUM/AWD	GCI61062	Inner Joint		30		59				
	1997.08-	2005.06	MT	R	F	Hatchback Engine AGU/AQA/ARZ/AUM/AWD	GDS61203	Drive Shaft	36		53.2	77.5	810			
	1997.08-	2005.06	MT	R	F	Hatchback Engine AGU/AQA/ARZ/AUM/AWD	GDS61203	Drive Shaft	36		53.2	77.5	810			
1.8 T GTi (132 kW)	2001.08-	2005.06			F	Hatchback Engine AUQ	GC083035	Outer Joint	36	27	53	77.5	65	I		
	2001.08-	2005.06			R	Hatchback Engine AUQ	GDS53010	Drive Shaft	36		59.5	40	768			
1.9 SDi (50 kW)	1997.08-	2005.06	AT		F	Hatchback Engine AGP/AQM	GC083036	Outer Joint	36	30	53.2	77.5	61	I		
	1997.08-	2005.06	MT		F	Hatchback Engine AGP/AQM	GC083033	Outer Joint	36	30	53	78.5	51	I		
	1997.08-	2005.06	MT		F	Hatchback Engine AGP/AQM	GCI83008	Inner Joint		33		32				
	1997.08-	2005.06	MT	L	F	Hatchback Engine AGP/AQM	GDS61045	Drive Shaft	36		53	78.5	555			
	1997.08-	2005.06	MT	R	F	Hatchback Engine AGP/AQM	GDS83046	Drive Shaft	36		53	78.5	822			
1.9 TDi (110 kW)	2000.05-	2005.06	MT		F	Hatchback Engine ARL	GC083036	Outer Joint	36	30	53.2	77.5	61	I		
	2000.05-	2005.06	MT/AT		F	Hatchback Engine ARL	GC083035	Outer Joint	36	27	53	77.5	65	I		
	2000.05-	2005.06			L	F	Hatchback Engine ARL	GDS61123	Drive Shaft	36		53	77.5	520		
	2000.05-	2005.06			R	F	Hatchback Engine ARL	GDS61186	Drive Shaft	36		53	77.5	653		
	2000.05-	2005.06			R	F	Hatchback Engine ARL	GCI61002	Inner Joint		28		31.8			
	2000.05-	2005.06			R	F	Hatchback Engine ARL	GC083035	Outer Joint	36	27	53	77.5	65	I	
1.9 TDi (66 kW)	1997.10-	2004.05	MT		F	Hatchback Engine AGR/ALH	GC083036	Outer Joint	36	30	53.2	77.5	61	I		
	1997.10-	2004.05	MT		F	Hatchback Engine AGR/ALH	GCI83009	Inner Joint		33		34				
	1997.10-	2004.05	MT/AT		F	Hatchback Engine AGR/ALH	GCI61006	Inner Joint		30		57.6				
	1997.10-	2004.05	AT	L	F	Hatchback Engine AGR/ALH	GDS61156	Drive Shaft	36		53	78	554.5			
	1997.10-	2004.05	AT	L	F	Hatchback Engine AGR/ALH	GCI61062	Inner Joint		30		59				
	1997.10-	2004.05	MT	L	F	Hatchback Engine AGR/ALH	GDS61021	Drive Shaft	36		53.2	77.5	564.5			
	1997.10-	2004.05	MT	L	F	Hatchback Engine AGR/ALH	GDS83006	Drive Shaft	36		53.2	77.5	557			
	1997.10-	2004.05	MT	R	F	Hatchback Engine AGR/ALH	GDS83004	Drive Shaft	36		53.2	77.5	822			
	1997.10-	2004.05	MT	R	F	Hatchback Engine AGR/ALH	GDS83004	Drive Shaft	36		53.2	77.5	822			
	1997.10-	2004.05	MT	R	F	Hatchback Engine AGR/ALH	GDS83004	Drive Shaft	36		53.2	77.5	822			
1.9 TDi (74 kW)	2000.09-	2005.06	AT		F	Hatchback Engine ATD/AXR	GC083035	Outer Joint	36	27	53	77.5	65	I		
	2000.09-	2005.06	MT		F	Hatchback Engine ATD/AXR	GCI83011	Inner Joint		33		34				
	2000.09-	2005.06	MT/AT		F	Hatchback Engine ATD/AXR	GC083036	Outer Joint	36	30	53.2	77.5	61	I		
	2000.09-	2005.06	MT/AT		F	Hatchback Engine ATD/AXR	GCI61006	Inner Joint		30		57.6				
	2000.09-	2005.06	AT	L	F	Hatchback Engine ATD/AXR	GDS61244	Drive Shaft	36		53	77.5	523			
	2000.09-	2005.06	MT	L	F	Hatchback Engine ATD/AXR	GDS61021	Drive Shaft	36		53.2	77.5	564.5			
	2000.09-	2005.06	MT	L	F	Hatchback Engine ATD/AXR	GDS83006	Drive Shaft	36		53.2	77.5	557			
	2000.09-	2005.06	MT	R	F	Hatchback Engine ATD/AXR	GDS83004	Drive Shaft	36		53.2	77.5	822			
1.9 TDi (81 kW)	1997.08-	2004.05	MT		F	Hatchback Engine AHF/ASV	GC083036	Outer Joint	36	30	53.2	77.5	61	I		
	1997.08-	2004.05	MT		F	Hatchback Engine AHF/ASV	GCI83009	Inner Joint		33		34				
	1997.08-	2004.05	MT/AT		F	Hatchback Engine AHF/ASV	GCI61006	Inner Joint		30		57.6				
	1997.08-	2004.05	MT	L	F	Hatchback Engine AHF/ASV	GDS61021	Drive Shaft	36		53.2	77.5	564.5			
	1997.08-	2004.05	MT	L	F	Hatchback Engine AHF/ASV	GDS83006	Drive Shaft	36		53.2	77.5	557			
	1997.08-	2004.05	MT	R	F	Hatchback Engine AHF/ASV	GDS83004	Drive Shaft	36		53.2	77.5	822			
1.9 TDi (85 kW)	1998.12-	2001.06	AT	L	F	Hatchback Engine AJM/AUY	GDS83374	Drive Shaft	36		53	77.5	521			
	1998.12-	2001.06	MT	L	F	Hatchback Engine AJM/AUY	GDS61021	Drive Shaft	36		53.2	77.5	564.5			
1.9 TDi (96 kW)	2000.11-	2005.06	4AT		F	Hatchback Engine ASZ	GC083036	Outer Joint	36	30	53.2	77.5	61	I		
	2000.11-	2005.06	MT/AT		F	Hatchback Engine ASZ	GC083035	Outer Joint	36	27	53	77.5	65	I		
	2000.11-	2005.06	AT	L	F	Hatchback Engine ASZ	GDS61244	Drive Shaft	36		53	77.5	523			
	2000.11-	2005.06	MT	L	F	Hatchback Engine ASZ	GDS61123	Drive Shaft	36		53	77.5	520			
	2000.11-	2005.06	AT	L/R	F	Hatchback Engine ASZ	GDS83374	Drive Shaft	36		53	77.5	521			
	2000.11-	2005.06	MT	R	F	Hatchback Engine ASZ	GDS61121	Drive Shaft	36		53	77.5	806			
1.9 TDi 4motion (110 kW)	2000.02-	2005.06	MT			Hatchback Engine ARL	GC083036	Outer Joint	36	30	53.2	77.5	61	I		
	2000.02-	2005.06	MT		F	Hatchback Engine ARL	GC083035	Outer Joint	36	27	53	77.5	65	I		
	2000.02-	2005.06			R	F	Hatchback Engine ARL	GDS61186	Drive Shaft	36		53	77.5	653		









		TRANSM	L/R	F/R		G-AP Ref.	PRODUCT	ABS	Technical Specifications								
									YEAR	A	B	C	H	L	P		
<b>VOLKSWAGEN</b>																	
<b>GOLF IV (1J1)</b>																	
1.9 TDi 4motion (110 kW)	2000.02-	2005.06			R	F	Hatchback Engine ARL	GCI61002	Inner Joint		28		31.8				
	2000.02-	2005.06			R	F	Hatchback Engine ARL	GC083035	Outer Joint	36	27	53	77.5	65	I		
	2000.02-	2005.06				R	Hatchback Engine ARL	GCI83011	Inner Joint		33		34				
	2000.02-	2005.06	MT			R	Hatchback Engine ARL	GCI53002	Inner Joint		33		34				
1.9 TDi 4motion (66 kW)	1998.07-	2002.04	MT				Hatchback Engine AGR/ALH	GC083036	Outer Joint	36	30	53.2	77.5	61	I		
	1998.07-	2002.04	MT/AT			F	Hatchback Engine AGR/ALH	GCI61006	Inner Joint		30		57.6				
	1998.07-	2002.04				F/R	Hatchback Engine AGR/ALH	GCI83011	Inner Joint		33		34				
	1998.07-	2002.04	MT			R	Hatchback Engine AGR/ALH	GCI53002	Inner Joint		33		34				
1.9 TDi 4motion (74 kW)	2000.09-	2005.06	MT/AT				Hatchback Engine ATD	GC083036	Outer Joint	36	30	53.2	77.5	61	I		
	2000.09-	2005.06	MT			F	Hatchback Engine ATD	GC083035	Outer Joint	36	27	53	77.5	65	I		
	2000.09-	2005.06	MT/AT			F	Hatchback Engine ATD	GCI61006	Inner Joint		30		57.6				
	2000.09-	2005.06	AT	L	F		Hatchback Engine ATD	GDS61156	Drive Shaft	36		53	78	554.5			
	2000.09-	2005.06	AT	L	F		Hatchback Engine ATD	GCI61062	Inner Joint		30		59				
	2000.09-	2005.06	MT	L	F		Hatchback Engine ATD	GDS61123	Drive Shaft	36		53	77.5	520			
	2000.09-	2005.06	MT	R	F		Hatchback Engine ATD	GDS61186	Drive Shaft	36		53	77.5	653			
	2000.09-	2005.06	MT	R	F		Hatchback Engine ATD	GCI61002	Inner Joint		28		31.8				
	2000.09-	2005.06	MT	R	F		Hatchback Engine ATD	GC083035	Outer Joint	36	27	53	77.5	65	I		
	2000.09-	2005.06			R		Hatchback Engine ATD	GCI83011	Inner Joint		33		34				
1.9 TDi 4motion (85 kW)	1999.09-	2001.06			R	F	Hatchback Engine AJM/AUY	GDS61186	Drive Shaft	36		53	77.5	653			
	1999.09-	2001.06			R	F	Hatchback Engine AJM/AUY	GCI61002	Inner Joint		28		31.8				
	1999.09-	2001.06			R	F	Hatchback Engine AJM/AUY	GC083035	Outer Joint	36	27	53	77.5	65	I		
	1.9 TDi 4motion (96 kW)	2000.11-	2005.06	4AT			Hatchback Engine ASZ	GC083036	Outer Joint	36	30	53.2	77.5	61	I		
2000.11-	2005.06	MT			F	Hatchback Engine ASZ	GC083035	Outer Joint	36	27	53	77.5	65	I			
2000.11-	2005.06			L	F	Hatchback Engine ASZ	GDS61123	Drive Shaft	36		53	77.5	520				
2000.11-	2005.06			R	F	Hatchback Engine ASZ	GDS61186	Drive Shaft	36		53	77.5	653				
2000.11-	2005.06			R	F	Hatchback Engine ASZ	GCI61002	Inner Joint		28		31.8					
2000.11-	2005.06			R	F	Hatchback Engine ASZ	GC083035	Outer Joint	36	27	53	77.5	65	I			
2000.11-	2005.06			R	F	Hatchback Engine ASZ	GCI83011	Inner Joint		33		34					
2000.11-	2005.06	MT			R	Hatchback Engine ASZ	GCI53002	Inner Joint		33		34					
2.0 (85 kW)	1998.07-	2004.05				F	Hatchback Engine APK/AQY/AZG/AZJ/BER	GC083036	Outer Joint	36	30	53.2	77.5	61	I		
	1998.07-	2004.05				F	Hatchback Engine APK/AQY/AZG/AZJ/BER	GCI83011	Inner Joint		33		34				
	1998.07-	2004.05	MT/AT			F	Hatchback Engine APK/AQY/AZG/AZJ/BER	GCI61006	Inner Joint		30		57.6				
	1998.07-	2004.05	AT	L	F		Hatchback Engine APK/AQY/AZG/AZJ/BER	GDS61156	Drive Shaft	36		53	78	554.5			
	1998.07-	2004.05	AT	L	F		Hatchback Engine APK/AQY/AZG/AZJ/BER	GCI61062	Inner Joint		30		59				
	1998.07-	2004.05	MT	L	F		Hatchback Engine APK/AQY/AZG/AZJ/BER	GDS61021	Drive Shaft	36		53.2	77.5	564.5			
1998.07-	2004.05	MT	R	F		Hatchback Engine APK/AQY/AZG/AZJ/BER	GDS83004	Drive Shaft	36		53.2	77.5	822				
2.0 4motion (85 kW)	2000.10-	2005.06					Hatchback Engine AZH/AZJ	GC083036	Outer Joint	36	30	53.2	77.5	61	I		
	2000.10-	2005.06	MT/AT			F	Hatchback Engine AZH/AZJ	GCI61006	Inner Joint		30		57.6				
	2000.10-	2005.06			L	F	Hatchback Engine AZH/AZJ	GDS61021	Drive Shaft	36		53.2	77.5	564.5			
	2000.10-	2005.06			F/R		Hatchback Engine AZH/AZJ	GCI83011	Inner Joint		33		34				
2000.10-	2005.06	MT			R	Hatchback Engine AZH/AZJ	GCI53002	Inner Joint		33		34					
2.3 V5 (125 kW)	2000.10-	2005.06	AT			F	Hatchback Engine AQN	GC083035	Outer Joint	36	27	53	77.5	65	I		
	2000.10-	2005.06	MT			F	Hatchback Engine AQN	GC083036	Outer Joint	36	30	53.2	77.5	61	I		
	2000.10-	2005.06	MT/AT			F	Hatchback Engine AQN	GCI61006	Inner Joint		30		57.6				
	2000.10-	2005.06	AT	L	F		Hatchback Engine AQN	GDS83374	Drive Shaft	36		53	77.5	521			
	2000.10-	2005.06	MT	L	F		Hatchback Engine AQN	GDS61156	Drive Shaft	36		53	78	554.5			
	2000.10-	2005.06	MT	L	F		Hatchback Engine AQN	GCI61062	Inner Joint		30		59				
2.3 V5 4motion (125 kW)	2000.10-	2005.06					Hatchback Engine AQN	GC083036	Outer Joint	36	30	53.2	77.5	61	I		
	2000.10-	2005.06	MT			F	Hatchback Engine AQN	GC083035	Outer Joint	36	27	53	77.5	65	I		
	2000.10-	2005.06	MT/AT			F	Hatchback Engine AQN	GCI61006	Inner Joint		30		57.6				
	2000.10-	2005.06			L	F	Hatchback Engine AQN	GDS61123	Drive Shaft	36		53	77.5	520			
	2000.10-	2005.06			R	F	Hatchback Engine AQN	GDS61186	Drive Shaft	36		53	77.5	653			
	2000.10-	2005.06			R	F	Hatchback Engine AQN	GCI61002	Inner Joint		28		31.8				
	2000.10-	2005.06			R	F	Hatchback Engine AQN	GC083035	Outer Joint	36	27	53	77.5	65	I		
	2000.10-	2005.06			R		Hatchback Engine AQN	GCI83011	Inner Joint		33		34				
	2000.10-	2005.06	MT			R	Hatchback Engine AQN	GCI53002	Inner Joint		33		34				
	2000.10-	2005.06					Hatchback Engine AQN	GC083035	Outer Joint	36	27	53	77.5	65	I		
2.8 V6 4motion (150 kW)	1999.03-	2005.06	MT			F	Hatchback Engine AQP/AUE/BDE	GC083035	Outer Joint	36	27	53	77.5	65	I		
	1999.03-	2005.06	6MT	L	F		Hatchback Engine AQP/AUE/BDE	GDS61123	Drive Shaft	36		53	77.5	520			
	1999.03-	2005.06			R	F	Hatchback Engine AQP/AUE/BDE	GDS61186	Drive Shaft	36		53	77.5	653			
	1999.03-	2005.06			R	F	Hatchback Engine AQP/AUE/BDE	GCI61002	Inner Joint		28		31.8				



		TRANSM	L/R	F/R		G-AP Ref.	PRODUCT	ABS	Technical Specifications								
									YEAR	A	B	C	H	L	P		
<b>VOLKSWAGEN</b>																	
<b>GOLF IV (1J1)</b>																	
2.8 V6 4motion (150 kW)	1999.03-	2005.06			R	F	Hatchback Engine AQP/AUE/BDE	GC083035	Outer Joint		36	27	53	77.5	65	I	
	1999.03-	2005.06	6MT		R		Hatchback Engine AQP/AUE/BDE	GCI83011	Inner Joint			33		34			
	1999.03-	2005.06	MT		R		Hatchback Engine AQP/AUE/BDE	GCI53002	Inner Joint			33		34			
3.2 R32 4motion (177 kW)	2002.09-	2005.06	6MT		R		Hatchback Engine BFH/BML	GCI83011	Inner Joint			33		34			
	2002.09-	2005.06	MT		R		Hatchback Engine BFH/BML	GCI53002	Inner Joint			33		34			
<b>GOLF IV (1J1, 1J5)</b>																	
1.4 TSi (125 kW)	2005.11-		AT					GCI83016	Inner Joint			28		32			
1.8 4motion (92 kW)	1998.05-	2005.06	MT	R				GCI83011	Inner Joint			33		34			
1.8 T (132 kW)	2003.02-		MT					GCI83016	Inner Joint			28		32			
1.9 TDi 4motion (77 kW)	2004.08-				F			GCI83016	Inner Joint			28		32			
2.0 TDi (100 kW)	2003.10-		MT					GCI83016	Inner Joint			28		32			
2.0 TDi (103 kW)	2003.10-		MT					GCI83016	Inner Joint			28		32			
2.0 TDi 16V (125 kW)	2005.11-							GCI83016	Inner Joint			28		32			
2.0 TDi 4motion (100 kW)	2003.10-							GCI83016	Inner Joint			28		32			
2.0 TDi 4motion (103 kW)	2003.10-							GCI83016	Inner Joint			28		32			
2.0 TFSi (147 kW)	2004-	2007.02						GCI83016	Inner Joint			28		32			
2.0 TFSi (169 kW)	2004-	2007.02						GCI83016	Inner Joint			28		32			
3.2 R32 4motion (184 kW)	2006-							GCI83016	Inner Joint			28		32			
<b>GOLF IV (1J5)</b>																	
1.4 16V (55 kW)	1999.05-	2006.06	AT		F		Estate Engine AHW/AKQ/APE/AXP/BCA	GC083036	Outer Joint		36	30	53.2	77.5	61	I	
	1999.05-	2006.06	MT		F		Estate Engine AHW/AKQ/APE/AXP/BCA	GC083033	Outer Joint		36	30	53	78.5	51	I	
	1999.05-	2006.06	MT		F		Estate Engine AHW/AKQ/APE/AXP/BCA	GCI83004	Inner Joint			33		32			
	1999.05-	2006.06	MT/AT		F		Estate Engine AHW/AKQ/APE/AXP/BCA	GCI83008	Inner Joint			33		32			
	1999.05-	2006.06	MT	L	F		Estate Engine AHW/AKQ/APE/AXP/BCA	GDS61045	Drive Shaft		36		53	78.5	555		
	1999.05-	2006.06	MT	R	F		Estate Engine AHW/AKQ/APE/AXP/BCA	GDS83046	Drive Shaft		36		53	78.5	822		
1.6 (74 kW)	1999.05-	2002.04	AT		F		Estate Engine AEH/AKL/APF	GC083036	Outer Joint		36	30	53.2	77.5	61	I	
	1999.05-	2002.04	MT		F		Estate Engine AEH/AKL/APF	GC083033	Outer Joint		36	30	53	78.5	51	I	
	1999.05-	2002.04	MT		F		Estate Engine AEH/AKL/APF	GCI83004	Inner Joint			33		32			
	1999.05-	2002.04	MT/AT		F		Estate Engine AEH/AKL/APF	GCI61006	Inner Joint			30		57.6			
	1999.05-	2002.04	MT/AT		F		Estate Engine AEH/AKL/APF	GCI83008	Inner Joint			33		32			
	1999.05-	2002.04	AT	L	F		Estate Engine AEH/AKL/APF	GDS61156	Drive Shaft		36		53	78	554.5		
	1999.05-	2002.04	AT	L	F		Estate Engine AEH/AKL/APF	GCI61062	Inner Joint			30		59			
	1999.05-	2002.04	MT	L	F		Estate Engine AEH/AKL/APF	GDS61045	Drive Shaft		36		53	78.5	555		
	1999.05-	2002.04	MT	R	F		Estate Engine AEH/AKL/APF	GDS83046	Drive Shaft		36		53	78.5	822		
1.6 (75 kW)	2000.08-	2006.06			F		Estate Engine AVU/BFQ	GC083036	Outer Joint		36	30	53.2	77.5	61	I	
	2000.08-	2006.06	MT/AT		F		Estate Engine AVU/BFQ	GCI61006	Inner Joint			30		57.6			
	2000.08-	2006.06	AT	L	F		Estate Engine AVU/BFQ	GDS61156	Drive Shaft		36		53	78	554.5		
	2000.08-	2006.06	AT	L	F		Estate Engine AVU/BFQ	GCI61062	Inner Joint			30		59			
	2000.08-	2006.06	MT	L	F		Estate Engine AVU/BFQ	GDS61045	Drive Shaft		36		53	78.5	555		
	2000.08-	2006.06	MT	R	F		Estate Engine AVU/BFQ	GDS83046	Drive Shaft		36		53	78.5	822		
1.6 16V (77 kW)	2000.02-	2006.06			F		Estate Engine ATN/AUS/AZD/BCB	GC083036	Outer Joint		36	30	53.2	77.5	61	I	
	2000.02-	2006.06			F		Estate Engine ATN/AUS/AZD/BCB	GCI61005	Inner Joint			30		57.6			
	2000.02-	2006.06	AT	L	F		Estate Engine ATN/AUS/AZD/BCB	GDS61202	Drive Shaft		36		53.2	77.5	547		
	2000.02-	2006.06	MT	L	F		Estate Engine ATN/AUS/AZD/BCB	GDS61021	Drive Shaft		36		53.2	77.5	564.5		
	2000.02-	2006.06	AT	R	F		Estate Engine ATN/AUS/AZD/BCB	GDS61203	Drive Shaft		36		53.2	77.5	810		
1.6 Fsi (116 kW)	2003.10-	2004.07	AT	R	F		Estate Engine BAG	GDS83349	Drive Shaft		36		59.5	40	784		
1.6 FSi (81 kW)	2002.01-	2006.06			F		Estate Engine BAD	GC083036	Outer Joint		36	30	53.2	77.5	61	I	
	2002.01-	2006.06			F		Estate Engine BAD	GCI61005	Inner Joint			30		57.6			
1.8 4motion (92 kW)	1999.05-	2006.06	AT				Estate Engine AGN	GCI83008	Inner Joint			33		32			
	1999.05-	2006.06	MT				Estate Engine AGN	GC083036	Outer Joint		36	30	53.2	77.5	61	I	
	1999.05-	2006.06	MT		F		Estate Engine AGN	GCI83004	Inner Joint			33		32			
	1999.05-	2006.06	6MT		F/R		Estate Engine AGN	GCI83011	Inner Joint			33		34			
	1999.05-	2006.06	MT		R		Estate Engine AGN	GCI53002	Inner Joint			33		34			
1.8 T (110 kW)	2000.05-	2006.06	MT		F		Estate Engine AGU/AQA/ARZ/AUM/AWD	GC083036	Outer Joint		36	30	53.2	77.5	61	I	
	2000.05-	2006.06	MT/AT		F		Estate Engine AGU/AQA/ARZ/AUM/AWD	GCI61006	Inner Joint			30		57.6			
	2000.05-	2006.06	AT	L	F		Estate Engine AGU/AQA/ARZ/AUM/AWD	GDS83374	Drive Shaft		36		53	77.5	521		
	2000.05-	2006.06	AT	L	F		Estate Engine AGU/AQA/ARZ/AUM/AWD	GDS61156	Drive Shaft		36		53	78	554.5		
	2000.05-	2006.06	AT	L	F		Estate Engine AGU/AQA/ARZ/AUM/AWD	GCI61062	Inner Joint			30		59			
1.9 SDi (50 kW)	1999.05-	2006.06	AT		F		Estate Engine AGP/AQM	GC083036	Outer Joint		36	30	53.2	77.5	61	I	
	1999.05-	2006.06	MT		F		Estate Engine AGP/AQM	GC083033	Outer Joint		36	30	53	78.5	51	I	
	1999.05-	2006.06	MT		F		Estate Engine AGP/AQM	GCI83008	Inner Joint			33		32			

		TRANSM	L/R	F/R		G-AP Ref.	PRODUCT	ABS	Technical Specifications						
									YEAR	A	B	C	H	L	P
<b>VOLKSWAGEN</b>															
<b>GOLF IV (1J5)</b>															
1.9 SDi (50 kW)	1999.05-	2006.06		L	F	Estate Engine AGP/AQM	GDS61045	Drive Shaft	36		53	78.5	555		
	1999.05-	2006.06		R	F	Estate Engine AGP/AQM	GDS83046	Drive Shaft	36		53	78.5	822		
1.9 TDi (66 kW)	1999.05-	2006.05	MT		F	Estate Engine AGR/ALH	GC083036	Outer Joint	36	30	53.2	77.5	61	I	
	1999.05-	2006.05	MT		F	Estate Engine AGR/ALH	GCI83009	Inner Joint		33		34			
	1999.05-	2006.05	MT/AT		F	Estate Engine AGR/ALH	GCI61006	Inner Joint		30		57.6			
	1999.05-	2006.05	MT	L	F	Estate Engine AGR/ALH	GDS61021	Drive Shaft	36		53.2	77.5	564.5		
	1999.05-	2006.05	MT	L	F	Estate Engine AGR/ALH	GDS83006	Drive Shaft	36		53.2	77.5	557		
	1999.05-	2006.05	MT	R	F	Estate Engine AGR/ALH	GDS83004	Drive Shaft	36		53.2	77.5	822		
	1999.05-	2006.05	MT	R	F	Estate Engine AGR/ALH	GDS83004	Drive Shaft	36		53.2	77.5	822		
1.9 TDi (74 kW)	2000.09-	2006.06	AT		F	Estate Engine ATD/AXR	GC083035	Outer Joint	36	27	53	77.5	65	I	
	2000.09-	2006.06	MT		F	Estate Engine ATD/AXR	GCI83011	Inner Joint		33		34			
	2000.09-	2006.06	MT/AT		F	Estate Engine ATD/AXR	GCI61006	Inner Joint		30		57.6			
	2000.09-	2006.06	MT/AT		F	Estate Engine ATD/AXR	GC083036	Outer Joint	36	30	53.2	77.5	61	I	
	2000.09-	2006.06	AT	L	F	Estate Engine ATD/AXR	GDS61244	Drive Shaft	36		53	77.5	523		
	2000.09-	2006.06	MT	L	F	Estate Engine ATD/AXR	GDS61021	Drive Shaft	36		53.2	77.5	564.5		
	2000.09-	2006.06	MT	L	F	Estate Engine ATD/AXR	GDS83006	Drive Shaft	36		53.2	77.5	557		
	2000.09-	2006.06	MT	R	F	Estate Engine ATD/AXR	GDS83004	Drive Shaft	36		53.2	77.5	822		
1.9 TDi (81 kW)	1999.08-	2006.05	MT		F	Estate Engine AHF/ASV	GC083036	Outer Joint	36	30	53.2	77.5	61	I	
	1999.08-	2006.05	MT		F	Estate Engine AHF/ASV	GCI83009	Inner Joint		33		34			
	1999.08-	2006.05	MT/AT		F	Estate Engine AHF/ASV	GCI61006	Inner Joint		30		57.6			
	1999.08-	2006.05	MT	L	F	Estate Engine AHF/ASV	GDS61021	Drive Shaft	36		53.2	77.5	564.5		
	1999.08-	2006.05	MT	L	F	Estate Engine AHF/ASV	GDS61156	Drive Shaft	36		53	78	554.5		
	1999.08-	2006.05	MT	L	F	Estate Engine AHF/ASV	GCI61062	Inner Joint		30		59			
	1999.08-	2006.05	MT	L	F	Estate Engine AHF/ASV	GDS83006	Drive Shaft	36		53.2	77.5	557		
	1999.08-	2006.05	MT	R	F	Estate Engine AHF/ASV	GDS83004	Drive Shaft	36		53.2	77.5	822		
1.9 TDi (85 kW)	1999.10-	2006.05	MT		F	Estate Engine AJM/AUY	GC083035	Outer Joint	36	27	53	77.5	65	I	
	1999.10-	2006.05	5MT	L	F	Estate Engine AJM/AUY	GDS61021	Drive Shaft	36		53.2	77.5	564.5		
	1999.10-	2006.05	AT	L	F	Estate Engine AJM/AUY	GDS83374	Drive Shaft	36		53	77.5	521		
	1999.10-	2006.05	MT	L	F	Estate Engine AJM/AUY	GDS61123	Drive Shaft	36		53	77.5	520		
	1999.10-	2006.05	MT	R	F	Estate Engine AJM/AUY	GDS61121	Drive Shaft	36		53	77.5	806		
1.9 TDi (96 kW)	2000.11-	2006.06	4AT		F	Estate Engine ASZ	GC083036	Outer Joint	36	30	53.2	77.5	61	I	
	2000.11-	2006.06	MT/AT		F	Estate Engine ASZ	GC083035	Outer Joint	36	27	53	77.5	65	I	
	2000.11-	2006.06	AT	L	F	Estate Engine ASZ	GDS83374	Drive Shaft	36		53	77.5	521		
	2000.11-	2006.06	MT	L	F	Estate Engine ASZ	GDS61123	Drive Shaft	36		53	77.5	520		
	2000.11-	2006.06	MT	R	F	Estate Engine ASZ	GDS61121	Drive Shaft	36		53	77.5	806		
1.9 TDi 4motion (110 kW)	2002.05-	2005.06	6MT	R	F	Estate Engine ARL	GDS61186	Drive Shaft	36		53	77.5	653		
	2002.05-	2005.06	6MT	R	F	Estate Engine ARL	GCI61002	Inner Joint		28		31.8			
	2002.05-	2005.06	6MT	R	F	Estate Engine ARL	GC083035	Outer Joint	36	27	53	77.5	65	I	
1.9 TDi 4motion (66 kW)	1999.05-	2002.04	MT			Estate Engine AGR/ALH	GC083036	Outer Joint	36	30	53.2	77.5	61	I	
	1999.05-	2002.04	MT/AT		F	Estate Engine AGR/ALH	GCI61006	Inner Joint		30		57.6			
	1999.05-	2002.04			F/R	Estate Engine AGR/ALH	GCI83011	Inner Joint		33		34			
	1999.05-	2002.04	MT		R	Estate Engine AGR/ALH	GCI53002	Inner Joint		33		34			
1.9 TDi 4motion (74 kW)	2000.09-	2006.06	MT/AT			Estate Engine ATD	GC083036	Outer Joint	36	30	53.2	77.5	61	I	
	2000.09-	2006.06	MT		F	Estate Engine ATD	GC083035	Outer Joint	36	27	53	77.5	65	I	
	2000.09-	2006.06	MT/AT		F	Estate Engine ATD	GCI61006	Inner Joint		30		57.6			
	2000.09-	2006.06	AT	L	F	Estate Engine ATD	GDS61244	Drive Shaft	36		53	77.5	523		
	2000.09-	2006.06	MT	L	F	Estate Engine ATD	GDS61021	Drive Shaft	36		53.2	77.5	564.5		
	2000.09-	2006.06	MT	L	F	Estate Engine ATD	GDS61123	Drive Shaft	36		53	77.5	520		
	2000.09-	2006.06	6MT	R	F	Estate Engine ATD	GDS61186	Drive Shaft	36		53	77.5	653		
	2000.09-	2006.06	6MT	R	F	Estate Engine ATD	GCI61002	Inner Joint		28		31.8			
	2000.09-	2006.06	6MT	R	F	Estate Engine ATD	GC083035	Outer Joint	36	27	53	77.5	65	I	
	2000.09-	2006.06			R	Estate Engine ATD	GCI83011	Inner Joint		33		34			
	2000.09-	2006.06	MT		R	Estate Engine ATD	GCI53002	Inner Joint		33		34			
1.9 TDi 4motion (85 kW)	1999.05-	2001.06	6MT	R	F	Estate Engine AJM	GDS61186	Drive Shaft	36		53	77.5	653		
	1999.05-	2001.06	6MT	R	F	Estate Engine AJM	GCI61002	Inner Joint		28		31.8			
	1999.05-	2001.06	6MT	R	F	Estate Engine AJM	GC083035	Outer Joint	36	27	53	77.5	65	I	
1.9 TDi 4motion (96 kW)	2000.11-	2006.06	4AT			Estate Engine ASZ	GC083036	Outer Joint	36	30	53.2	77.5	61	I	
	2000.11-	2006.06	MT	R		Estate Engine ASZ	GDS61121	Drive Shaft	36		53	77.5	806		
	2000.11-	2006.06	MT	F		Estate Engine ASZ	GC083035	Outer Joint	36	27	53	77.5	65	I	
	2000.11-	2006.06	AT	L	F	Estate Engine ASZ	GDS83374	Drive Shaft	36		53	77.5	521		
	2000.11-	2006.06	MT	L	F	Estate Engine ASZ	GDS61123	Drive Shaft	36		53	77.5	520		
	2000.11-	2006.06		R	F	Estate Engine ASZ	GDS61186	Drive Shaft	36		53	77.5	653		









		TRANSM	L/R	F/R		G-AP Ref.	PRODUCT	ABS	Technical Specifications							
									YEAR	A	B	C	H	L	P	
<b>VOLKSWAGEN</b>																
<b>GOLF IV (1J5)</b>																
1.9 TDi 4motion (96 kW)	2000.11-	2006.06			R	F	Estate Engine ASZ	GCI61002	Inner Joint		28		31.8			
	2000.11-	2006.06			R	F	Estate Engine ASZ	GC083035	Outer Joint	36	27	53	77.5	65	I	
	2000.11-	2006.06			R		Estate Engine ASZ	GCI83011	Inner Joint		33		34			
	2000.11-	2006.06	MT		R		Estate Engine ASZ	GCI53002	Inner Joint		33		34			
2.0 (85 kW)	1999.05-	2006.06				F	Estate Engine APK/AQY/AZJ	GC083036	Outer Joint	36	30	53.2	77.5	61	I	
	1999.05-	2006.06	MT			F	Estate Engine APK/AQY/AZJ	GCI83011	Inner Joint		33		34			
	1999.05-	2006.06	MT/AT			F	Estate Engine APK/AQY/AZJ	GCI61006	Inner Joint		30		57.6			
	1999.05-	2006.06	AT	L	F		Estate Engine APK/AQY/AZJ	GDS61156	Drive Shaft	36		53	78	554.5		
	1999.05-	2006.06	AT	L	F		Estate Engine APK/AQY/AZJ	GCI61062	Inner Joint		30		59			
	1999.05-	2006.06	MT	L	F		Estate Engine APK/AQY/AZJ	GDS61021	Drive Shaft	36		53.2	77.5	564.5		
2.0 4motion (85 kW)	2000.10-	2006.06					Estate Engine AZH/AZJ	GC083036	Outer Joint	36	30	53.2	77.5	61	I	
	2000.10-	2006.06	MT/AT			F	Estate Engine AZH/AZJ	GCI61006	Inner Joint		30		57.6			
2.0 BiFuel (85 kW)	2002.02-	2006.06				R	Estate Engine AZH/AZJ	GCI83011	Inner Joint		33		34			
	2002.02-	2006.06				F	Estate Engine BEH	GC083036	Outer Joint	36	30	53.2	77.5	61	I	
	2002.02-	2006.06			R	F	Estate Engine BEH	GDS83004	Drive Shaft	36		53.2	77.5	822		
2.3 V5 (110 kW)	1999.05-	2006.06	6MT			F	Estate Engine BEH	GCI83011	Inner Joint		33		34			
	1999.05-	2006.06	MT			F	Estate Engine AGZ	GC083036	Outer Joint	36	30	53.2	77.5	61	I	
	1999.05-	2006.06	MT/AT			F	Estate Engine AGZ	GCI61006	Inner Joint		30		57.6			
	1999.05-	2006.06	MT/AT	L	F		Estate Engine AGZ	GDS61156	Drive Shaft	36		53	78	554.5		
	1999.05-	2006.06	MT/AT	L	F		Estate Engine AGZ	GCI61062	Inner Joint		30		59			
2.3 V5 (125 kW)	2000.10-	2006.06				F	Estate Engine AGZ	GC083036	Outer Joint	36	30	53.2	77.5	61	I	
	2000.10-	2006.06	AT			F	Estate Engine AQN	GC083035	Outer Joint	36	27	53	77.5	65	I	
	2000.10-	2006.06	MT/AT			F	Estate Engine AQN	GCI61006	Inner Joint		30		57.6			
	2000.10-	2006.06	AT	L	F		Estate Engine AQN	GDS83374	Drive Shaft	36		53	77.5	521		
	2000.10-	2006.06	MT	L	F		Estate Engine AQN	GDS61156	Drive Shaft	36		53	78	554.5		
	2000.10-	2006.06	MT	L	F		Estate Engine AQN	GCI61062	Inner Joint		30		59			
2.3 V5 4motion (110 kW)	1999.05-	2006.06	MT			F	Estate Engine AQN	GC083036	Outer Joint	36	30	53.2	77.5	61	I	
	1999.05-	2006.06	MT			F	Estate Engine AGZ	GC083035	Outer Joint	36	27	53	77.5	65	I	
	1999.05-	2006.06	MT/AT			F	Estate Engine AGZ	GCI61006	Inner Joint		30		57.6			
	1999.05-	2006.06	6MT	L	F		Estate Engine AGZ	GDS61123	Drive Shaft	36		53	77.5	520		
	1999.05-	2006.06			R	F	Estate Engine AGZ	GDS61186	Drive Shaft	36		53	77.5	653		
	1999.05-	2006.06			R	F	Estate Engine AGZ	GCI61002	Inner Joint		28		31.8			
	1999.05-	2006.06			R	F	Estate Engine AGZ	GC083035	Outer Joint	36	27	53	77.5	65	I	
	1999.05-	2006.06	6MT		R		Estate Engine AGZ	GCI83011	Inner Joint		33		34			
	1999.05-	2006.06	MT		R		Estate Engine AGZ	GCI53002	Inner Joint		33		34			
	2.3 V5 4motion (125 kW)	2000.10-	2006.06				F	Estate Engine AGZ	GC083036	Outer Joint	36	30	53.2	77.5	61	I
2.8 V6 4motion (150 kW)	2000.10-	2006.06	MT			F	Estate Engine AQN	GC083035	Outer Joint	36	27	53	77.5	65	I	
	2000.10-	2006.06	MT/AT			F	Estate Engine AQN	GCI61006	Inner Joint		30		57.6			
	2000.10-	2006.06			L	F	Estate Engine AQN	GDS61123	Drive Shaft	36		53	77.5	520		
	2000.10-	2006.06	AT	L	F		Estate Engine AQN	GDS61244	Drive Shaft	36		53	77.5	523		
	2000.10-	2006.06	MT	L	F		Estate Engine AQN	GDS61156	Drive Shaft	36		53	78	554.5		
	2000.10-	2006.06	MT	L	F		Estate Engine AQN	GCI61062	Inner Joint		30		59			
	2000.10-	2006.06			R	F	Estate Engine AQN	GDS61186	Drive Shaft	36		53	77.5	653		
	2000.10-	2006.06			R	F	Estate Engine AQN	GCI61002	Inner Joint		28		31.8			
	2000.10-	2006.06			R	F	Estate Engine AQN	GC083035	Outer Joint	36	27	53	77.5	65	I	
	2000.10-	2006.06			R		Estate Engine AQN	GCI83011	Inner Joint		33		34			
	2000.10-	2006.06	MT		R		Estate Engine AQN	GCI53002	Inner Joint		33		34			
	2.8 V6 4motion (150 kW)	1999.05-	2006.06	MT			F	Estate Engine AQN	GC083035	Outer Joint	36	27	53	77.5	65	I
		1999.05-	2006.06	6MT	L	F		Estate Engine AQP/AUE/BDE	GDS61123	Drive Shaft	36		53	77.5	520	
1999.05-		2006.06			R	F	Estate Engine AQP/AUE/BDE	GDS61186	Drive Shaft	36		53	77.5	653		
1999.05-		2006.06			R	F	Estate Engine AQP/AUE/BDE	GCI61002	Inner Joint		28		31.8			
1999.05-		2006.06			R	F	Estate Engine AQP/AUE/BDE	GC083035	Outer Joint	36	27	53	77.5	65	I	
1999.05-		2006.06	6MT		R		Estate Engine AQP/AUE/BDE	GCI83011	Inner Joint		33		34			
1999.05-		2006.06	MT		R		Estate Engine AQP/AUE/BDE	GCI53002	Inner Joint		33		34			
<b>GOLF PLUS (5M1, 521)</b>																
1.2 TSi (63 kW)	2010.05-		AT	L	F		Hatchback Engine CBZA	GDS61201	Drive Shaft	36		59.5	40.5	535		
	2010.05-		MT	L	F		Hatchback Engine CBZA	GDS61198	Drive Shaft	36		59.5	40.5	530		
	2010.05-		AT				Hatchback Engine CBZA	GC083100	Outer Joint	36	33	59.5	38	55	I	

		TRANSM	L/R	F/R		G-AP Ref.	PRODUCT	ABS	Technical Specifications						
									YEAR	A	B	C	H	L	P
<b>VOLKSWAGEN</b>															
<b>GOLF PLUS (5M1, 521)</b>															
1.2 TSi (77 kW)	2009.11-		MT		F	Hatchback Engine CBZB	GCI53002	Inner Joint		33		34			
	2009.11-		AT	L	F	Hatchback Engine CBZB	GDS61198	Drive Shaft	36		59.5	40.5	530		
	2009.11-		AT			Hatchback Engine CBZB	GC083100	Outer Joint	36	33	59.5	38	55	I	
	2009.11-					Hatchback Engine CBZB	GC061059	Outer Joint	36	33	59.5	40	59.5	I	
1.4 16V (55 kW)	2005.06-2006.05				F	Hatchback Engine BCA	GCI83008	Inner Joint		33		32			
	2005.06-2006.05	MT			F	Hatchback Engine BCA	GC053001	Outer Joint	36	30	59.5	40	49	I	
	2005.06-2006.05	MT	L	F		Hatchback Engine BCA	GDS53007	Drive Shaft	36		59.5	40	559		
	2005.06-2006.05	MT	R	F		Hatchback Engine BCA	GDS53008	Drive Shaft	36		59.5	40	782		
1.4 16V (59 kW)	2006.06-2008.03				F	Hatchback Engine BUD/CGGA	GCI83008	Inner Joint		33		32			
	2006.06-2008.03	5MT			F	Hatchback Engine BUD/CGGA	GC053001	Outer Joint	36	30	59.5	40	49	I	
	2006.06-2008.03	MT	L	F		Hatchback Engine BUD/CGGA	GDS53007	Drive Shaft	36		59.5	40	559		
	2006.06-2008.03	MT	R	F		Hatchback Engine BUD/CGGA	GDS53008	Drive Shaft	36		59.5	40	782		
1.4 FSi (66 kW)	2005.07-				F	Hatchback Engine BLN	GCI83008	Inner Joint		33		32			
	2005.07-		5MT		F	Hatchback Engine BLN	GC053001	Outer Joint	36	30	59.5	40	49	I	
	2005.07-		MT	L	F	Hatchback Engine BLN	GDS53007	Drive Shaft	36		59.5	40	559		
1.4 TSi (103 kW)	2006.06-2008.03	6AT			F	Hatchback Engine BMY	GC083002	Outer Joint	36	27	59.5	40	66	I	
	2006.06-2008.03	MT			F	Hatchback Engine BMY	GCI53002	Inner Joint		33		34			
	2006.06-2008.03	MT	L	F		Hatchback Engine BMY	GDS83302	Drive Shaft	36		59.5	40	528		
	2006.06-2008.03	MT	L	F		Hatchback Engine BMY	GDS61224	Drive Shaft	36		59.5	40	536		
1.4 TSi (118 kW)	2008.06-		7AT		F	Hatchback Engine CAVD/CNWA	GC083002	Outer Joint	36	27	59.5	40	66	I	
	2008.06-		MT		F	Hatchback Engine CAVD/CNWA	GCI53002	Inner Joint		33		34			
	2008.06-		MT		F	Hatchback Engine CAVD/CNWA	GC083037	Outer Joint	36	30	59.5	40.5	55	I	
	2008.06-		AT	L	F	Hatchback Engine CAVD/CNWA	GDS61281	Drive Shaft	36		59.5	40	528		
	2008.06-		MT	L	F	Hatchback Engine CAVD/CNWA	GDS61201	Drive Shaft	36		59.5	40.5	535		
1.4 TSi (125 kW)	2006.05-2008.06	6AT			F	Hatchback Engine BLG	GC083002	Outer Joint	36	27	59.5	40	66	I	
	2006.05-2008.06	MT	L	F		Hatchback Engine BLG	GDS83302	Drive Shaft	36		59.5	40	528		
1.4 TSi (90 kW)	2007.09-				F	Hatchback Engine CAXA	GC083037	Outer Joint	36	30	59.5	40.5	55	I	
	2007.09-		Semi-AT		F	Hatchback Engine CAXA	GC083002	Outer Joint	36	27	59.5	40	66	I	
	2007.09-		MT	L	F	Hatchback Engine CAXA	GDS61198	Drive Shaft	36		59.5	40.5	530		
1.6 (75 kW)	2005.05-	6AT			F	Hatchback Engine BSE/BSF/CCSA/CMXA	GCI61011	Inner Joint	26	32	31	68.5	85		
	2005.05-		AT		F	Hatchback Engine BSE/BSF/CCSA/CMXA	GC083037	Outer Joint	36	30	59.5	40.5	55	I	
	2005.05-		MT		F	Hatchback Engine BSE/BSF/CCSA/CMXA	GCI83011	Inner Joint		33		34			
	2005.05-	6AT	L	F		Hatchback Engine BSE/BSF/CCSA/CMXA	GDS61093	Drive Shaft	36	26	59.5	40.5	587.5		
	2005.05-		AT	L	F	Hatchback Engine BSE/BSF/CCSA/CMXA	GDS83318	Drive Shaft	36	26	59.5	38	581		
	2005.05-		MT	L	F	Hatchback Engine BSE/BSF/CCSA/CMXA	GDS61097	Drive Shaft	36		59.5	40.5	543		
	2005.05-		MT	L	F	Hatchback Engine BSE/BSF/CCSA/CMXA	GDS83320	Drive Shaft	36		59.5	40	546		
	2005.05-	6AT	R	F		Hatchback Engine BSE/BSF/CCSA/CMXA	GDS61094	Drive Shaft	36	26	59.5	40.5	884		
	2005.05-		MT	R	F	Hatchback Engine BSE/BSF/CCSA/CMXA	GDS61096	Drive Shaft	36		59.5	40.5	799		
	2005.05-		AT	R	F	Hatchback Engine BSE/BSF/CCSA/CMXA	GDS83346	Drive Shaft	36	26	59.5	38	879		
	2005.05-		AT	R	F	Hatchback Engine BSE/BSF/CCSA/CMXA	GCI61011	Inner Joint	26	32	31	68.5	85		
1.6 BiFuel (75 kW)	2009.05-			L	F	Hatchback Engine CHGA	GDS83320	Drive Shaft	36		59.5	40	546		
1.6 FSi (85 kW)	2005.06-2008.03		AT		F	Hatchback Engine BLF	GC083037	Outer Joint	36	30	59.5	40.5	55	I	
	2005.06-2008.03		MT		F	Hatchback Engine BLF	GCI83011	Inner Joint		33		34			
	2005.06-2008.03	6MT	L	F		Hatchback Engine BLF	GDS83319	Drive Shaft	36		59.5	38	557		
	2005.06-2008.03	6MT	R	F		Hatchback Engine BLF	GDS61211	Drive Shaft	36		59.5	40.5	784		
1.6 MultiFuel (75 kW)	2007.11-		AT		F	Hatchback Engine CCSA/CMXA	GC083037	Outer Joint	36	30	59.5	40.5	55	I	
	2007.11-		MT		F	Hatchback Engine CCSA/CMXA	GCI53002	Inner Joint		33		34			
	2007.11-			L	F	Hatchback Engine CCSA/CMXA	GDS83320	Drive Shaft	36		59.5	40	546		
	2007.11-		6AT	L	F	Hatchback Engine CCSA/CMXA	GDS83318	Drive Shaft	36	26	59.5	38	581		
	2007.11-		MT	L	F	Hatchback Engine CCSA/CMXA	GDS61097	Drive Shaft	36		59.5	40.5	543		
	2007.11-		MT	R	F	Hatchback Engine CCSA/CMXA	GDS61096	Drive Shaft	36		59.5	40.5	799		
	2007.11-		6AT	R	F	Hatchback Engine CCSA/CMXA	GDS83346	Drive Shaft	36	26	59.5	38	879		
	2007.11-		6AT	R	F	Hatchback Engine CCSA/CMXA	GCI61011	Inner Joint	26	32	31	68.5	85		
2007.11-		6AT	R	F	Hatchback Engine CCSA/CMXA	GC083116	Outer Joint	36	30	59.5	38	55	I		
1.6 TDi (66 kW)	2009.02-			L	F	Hatchback Engine CAYB	GDS83294	Drive Shaft	36		59.5	38	519		
	2009.02-			R	F	Hatchback Engine CAYB	GDS61042	Drive Shaft	36		59.5	40.5	814		
	2009.02-		MT	L	F	Hatchback Engine CAYB	GDS61089	Drive Shaft	36		59.5	40.5	521		
1.6 TDi (77 kW)	2009.03-		MT	L	F	Hatchback Engine CAYC	GDS83294	Drive Shaft	36		59.5	38	519		
	2009.03-		MT	R	F	Hatchback Engine CAYC	GDS61042	Drive Shaft	36		59.5	40.5	814		
	2009.03-		AT	L	F	Hatchback Engine CAYC	GDS83236	Drive Shaft	36		59.5	40	484		



		TRANSM	L/R	F/R		G-AP Ref.	PRODUCT	ABS	Technical Specifications								
									YEAR	A	B	C	H	L	P		
<b>VOLKSWAGEN</b>																	
<b>GOLF PLUS (5M1, 521)</b>																	
1.6 TDi (77 kW)	2009.03-		MT	L	F	Hatchback Engine CAYC	GDS61089	Drive Shaft	36		59.5	40.5	521				
	2009.03-		AT	R	F	Hatchback Engine CAYC	GDS61280	Drive Shaft	36		59.5	40	801				
	2009.03-					Hatchback Engine CAYC	GC083100	Outer Joint	36	33	59.5	38	55	I			
	2009.03-		MT		F	Hatchback Engine CAYC	GCI53002	Inner Joint		33		34					
	2009.03-		MT		F	Hatchback Engine CAYC	GC083037	Outer Joint	36	30	59.5	40.5	55	I			
1.9 TDi (66 kW)	2005.06-2008.03				F	Hatchback Engine BRU/BXF/BXJ	GC083037	Outer Joint	36	30	59.5	40.5	55	I			
	2005.06-2008.03	MT			F	Hatchback Engine BRU/BXF/BXJ	GCI83011	Inner Joint		33		34					
	2005.06-2008.03			L	F	Hatchback Engine BRU/BXF/BXJ	GDS83294	Drive Shaft	36		59.5	38	519				
	2005.06-2008.03	MT	L	F	F	Hatchback Engine BRU/BXF/BXJ	GDS61089	Drive Shaft	36		59.5	40.5	521				
	2005.06-2008.03			R	F	Hatchback Engine BRU/BXF/BXJ	GDS61042	Drive Shaft	36		59.5	40.5	814				
1.9 TDi (77 kW)	2005.06-2008.03	6AT			F	Hatchback Engine BKC/BLS/BXE	GCI54004	Inner Joint		34		85					
	2005.06-2008.03	6MT/6AT			F	Hatchback Engine BKC/BLS/BXE	GC083037	Outer Joint	36	30	59.5	40.5	55	I			
	2005.06-2008.03	MT			F	Hatchback Engine BKC/BLS/BXE	GCI83011	Inner Joint		33		34					
	2005.06-2008.03	5MT	L	F	F	Hatchback Engine BKC/BLS/BXE	GDS83294	Drive Shaft	36		59.5	38	519				
	2005.06-2008.03	6AT	L	F	F	Hatchback Engine BKC/BLS/BXE	GDS54013	Drive Shaft	36		59.5	40	479.5				
	2005.06-2008.03	6MT	L	F	F	Hatchback Engine BKC/BLS/BXE	GDS83294	Drive Shaft	36		59.5	38	519				
	2005.06-2008.03	AT	L	F	F	Hatchback Engine BKC/BLS/BXE	GDS83241	Drive Shaft	36		59.5	40	475				
	2005.06-2008.03	MT	L	F	F	Hatchback Engine BKC/BLS/BXE	GDS61089	Drive Shaft	36		59.5	40.5	521				
	2005.06-2008.03	AT	L/R	F	F	Hatchback Engine BKC/BLS/BXE	GCI61057	Inner Joint		34		86					
	2005.06-2008.03	5MT	R	F	F	Hatchback Engine BKC/BLS/BXE	GDS61042	Drive Shaft	36		59.5	40.5	814				
	2005.06-2008.03	6AT	R	F	F	Hatchback Engine BKC/BLS/BXE	GDS54011	Drive Shaft	36		59.5	40	755				
	2005.06-2008.03	AT	R	F	F	Hatchback Engine BKC/BLS/BXE	GDS83355	Drive Shaft	36	23	59.5	40	799				
2.0 FSi (110 kW)	2005.06-2006.05				F	Hatchback Engine BLR/BLY/BVY/BVZ	GC083037	Outer Joint	36	30	59.5	40.5	55	I			
	2005.06-2006.05	6AT			F	Hatchback Engine BLR/BLY/BVY/BVZ	GCI61011	Inner Joint	26	32	31	68.5	85				
	2005.06-2006.05	MT			F	Hatchback Engine BLR/BLY/BVY/BVZ	GCI83011	Inner Joint		33		34					
	2005.06-2006.05	6AT	L	F	F	Hatchback Engine BLR/BLY/BVY/BVZ	GDS61093	Drive Shaft	36	26	59.5	40.5	587.5				
	2005.06-2006.05	MT	L	F	F	Hatchback Engine BLR/BLY/BVY/BVZ	GDS61089	Drive Shaft	36		59.5	40.5	521				
	2005.06-2006.05	6AT	R	F	F	Hatchback Engine BLR/BLY/BVY/BVZ	GDS61094	Drive Shaft	36	26	59.5	40.5	884				
	2005.06-2006.05	6MT	R	F	F	Hatchback Engine BLR/BLY/BVY/BVZ	GDS61113	Drive Shaft	36		59.5	40	814				
2.0 TDi (100 kW)	2005.05-	6AT			F	Hatchback Engine AZV/CBDA/CFHB	GCI54004	Inner Joint		34		85					
	2005.05-	MT			F	Hatchback Engine AZV/CBDA/CFHB	GC083002	Outer Joint	36	27	59.5	40	66	I			
	2005.05-	6AT	L	F	F	Hatchback Engine AZV/CBDA/CFHB	GDS54013	Drive Shaft	36		59.5	40	479.5				
	2005.05-	6MT	L	F	F	Hatchback Engine AZV/CBDA/CFHB	GDS83265	Drive Shaft	36		59.5	40	487				
	2005.05-	6MT	L	F	F	Hatchback Engine AZV/CBDA/CFHB	GDS83295	Drive Shaft	36		59.5	40	491				
	2005.05-	6MT	R	F	F	Hatchback Engine AZV/CBDA/CFHB	GDS83313	Drive Shaft	36		59.5	40	792				
	2005.05-	AT	R	F	F	Hatchback Engine AZV/CBDA/CFHB	GDS54011	Drive Shaft	36		59.5	40	755				
	2005.05-	6MT	L	F	F	Hatchback Engine AZV/CBDA/CFHB	GCI83016	Inner Joint		28		32					
	2005.05-	AT	L	F	F	Hatchback Engine AZV/CBDA/CFHB	GDS83241	Drive Shaft	36		59.5	40	475				
	2005.05-	MT	L	F	F	Hatchback Engine AZV/CBDA/CFHB	GDS83236	Drive Shaft	36		59.5	40	484				
	2005.05-	AT	L/R	F	F	Hatchback Engine AZV/CBDA/CFHB	GCI61057	Inner Joint		34		86					
	2005.05-	AT	R	F	F	Hatchback Engine AZV/CBDA/CFHB	GDS83355	Drive Shaft	36	23	59.5	40	799				
	2005.05-	MT	R	F	F	Hatchback Engine AZV/CBDA/CFHB	GDS61126	Drive Shaft	36		59.5	40	793				
	2.0 TDi (103 kW)	2006.06-2008.03	6AT			F	Hatchback Engine BMM	GCI54004	Inner Joint		34		85				
2006.06-2008.03		6MT/6AT			F	Hatchback Engine BMM	GC083002	Outer Joint	36	27	59.5	40	66	I			
2006.06-2008.03		MT			F	Hatchback Engine BMM	GCI53002	Inner Joint		33		34					
2006.06-2008.03		6MT	L	F	F	Hatchback Engine BMM	GDS83295	Drive Shaft	36		59.5	40	491				
2006.06-2008.03		AT	L	F	F	Hatchback Engine BMM	GDS83241	Drive Shaft	36		59.5	40	475				
2006.06-2008.03		AT	L	F	F	Hatchback Engine BMM	GDS54013	Drive Shaft	36		59.5	40	479.5				
2006.06-2008.03		MT	L	F	F	Hatchback Engine BMM	GDS83236	Drive Shaft	36		59.5	40	484				
2006.06-2008.03		MT	L	F	F	Hatchback Engine BMM	GCI83016	Inner Joint		28		32					
2006.06-2008.03		MT	L	F	F	Hatchback Engine BMM	GDS83265	Drive Shaft	36		59.5	40	487				
2006.06-2008.03		AT	L/R	F	F	Hatchback Engine BMM	GCI61057	Inner Joint		34		86					
2006.06-2008.03		AT	R	F	F	Hatchback Engine BMM	GDS83355	Drive Shaft	36	23	59.5	40	799				
2006.06-2008.03		AT	R	F	F	Hatchback Engine BMM	GDS54011	Drive Shaft	36		59.5	40	755				
2006.06-2008.03		MT	R	F	F	Hatchback Engine BMM	GDS61126	Drive Shaft	36		59.5	40	793				
2006.06-2008.03		MT	R	F	F	Hatchback Engine BMM	GDS83313	Drive Shaft	36		59.5	40	792				
2.0 TDi (81 kW)		2009.01-				F	Hatchback Engine CLCA/CBDC	GC083037	Outer Joint	36	30	59.5	40.5	55	I		
	2009.01-		AT		F	Hatchback Engine CLCA/CBDC	GC083002	Outer Joint	36	27	59.5	40	66	I			
	2009.01-		MT		F	Hatchback Engine CLCA/CBDC	GCI53002	Inner Joint		33		34					
	2009.01-		AT	L	F	Hatchback Engine CLCA/CBDC	GDS54013	Drive Shaft	36		59.5	40	479.5				
	2009.01-		MT	L	F	Hatchback Engine CLCA/CBDC	GDS83294	Drive Shaft	36		59.5	38	519				





		TRANSM	L/R	F/R		G-AP Ref.	PRODUCT	ABS	Technical Specifications								
									YEAR	A	B	C	H	L	P		
<b>VOLKSWAGEN</b>																	
<b>GOLF PLUS (5M1, 521)</b>																	
2.0 TDi (81 kW)	2009.01-		AT	R	F	Hatchback Engine CLCA/CBDC	GDS54011	Drive Shaft	36		59.5	40	755				
	2009.01-		MT	R	F	Hatchback Engine CLCA/CBDC	GDS61042	Drive Shaft	36		59.5	40.5	814				
	2009.01-		MT	L	F	Hatchback Engine CLCA/CBDC	GDS61089	Drive Shaft	36		59.5	40.5	521				
	2009.01-		AT	R	F	Hatchback Engine CLCA/CBDC	GDS83355	Drive Shaft	36	23	59.5	40	799				
2.0 TDi (96 kW)	2005.05-2007.05			L	F	Hatchback Engine BEE	GDS83265	Drive Shaft	36		59.5	40	487				
	2005.05-2007.05			L	F	Hatchback Engine BEE	GDS83295	Drive Shaft	36		59.5	40	491				
	2005.05-2007.05			L	F	Hatchback Engine BEE	GCI83016	Inner Joint		28		32					
	2005.05-2007.05			R	F	Hatchback Engine BEE	GDS83313	Drive Shaft	36		59.5	40	792				
2.0 TDi 16V (103 kW)	2005.01-				F	Hatchback Engine BKD/CBDB/CFHC	GC083002	Outer Joint	36	27	59.5	40	66	I			
	2005.01-		6AT		F	Hatchback Engine BKD/CBDB/CFHC	GCI54004	Inner Joint		34		85					
	2005.01-		MT		F	Hatchback Engine BKD/CBDB/CFHC	GCI53002	Inner Joint		33		34					
	2005.01-		6MT	L	F	Hatchback Engine BKD/CBDB/CFHC	GDS83265	Drive Shaft	36		59.5	40	487				
	2005.01-		6MT	L	F	Hatchback Engine BKD/CBDB/CFHC	GDS83295	Drive Shaft	36		59.5	40	491				
	2005.01-		AT	L	F	Hatchback Engine BKD/CBDB/CFHC	GDS54013	Drive Shaft	36		59.5	40	479.5				
	2005.01-		AT	R	F	Hatchback Engine BKD/CBDB/CFHC	GDS54011	Drive Shaft	36		59.5	40	755				
	2005.01-		MT	R	F	Hatchback Engine BKD/CBDB/CFHC	GDS83313	Drive Shaft	36		59.5	40	792				
	2005.01-		6MT	L	F	Hatchback Engine BKD/CBDB/CFHC	GCI83016	Inner Joint		28		32					
	2005.01-		AT	L	F	Hatchback Engine BKD/CBDB/CFHC	GDS83241	Drive Shaft	36		59.5	40	475				
	2005.01-		MT	L	F	Hatchback Engine BKD/CBDB/CFHC	GDS83236	Drive Shaft	36		59.5	40	484				
	2005.01-		AT	L/R	F	Hatchback Engine BKD/CBDB/CFHC	GCI61057	Inner Joint		34		86					
	2005.01-		AT	R	F	Hatchback Engine BKD/CBDB/CFHC	GDS83355	Drive Shaft	36	23	59.5	40	799				
	2005.01-		MT	R	F	Hatchback Engine BKD/CBDB/CFHC	GDS61126	Drive Shaft	36		59.5	40	793				
<b>GOLF SERIE III</b>																	
1.8	1991-	1997.06			R		GDS61012	Drive Shaft	22		50	78	773				
2	1991-	1997.06			R		GDS61012	Drive Shaft	22		50	78	773				
<b>GOLF SPORTSVAN</b>																	
1.4 TSi (110 kW)	2014.02-		AT	R	F	Hatchback Engine CZDA	GDS61303	Drive Shaft	36		59.5	40	795				
	2014.02-		MT			Hatchback Engine CZDA	GC083100	Outer Joint	36	33	59.5	38	55	I			
1.4 TSi (92 kW)	2014.04-		MT/AT			Hatchback Engine CZCA	GC083100	Outer Joint	36	33	59.5	38	55	I			
1.4 TSi MultiFuel (92 kW)	2014.04-		MT/AT			Hatchback Engine CPVB	GC083100	Outer Joint	36	33	59.5	38	55	I			
1.6 TDi (66 kW)	2014.02-		MT	L	F	Hatchback Engine CRKA	GDS61089	Drive Shaft	36		59.5	40.5	521				
1.6 TDi (81 kW)	2014.02-		MT	L	F	Hatchback Engine CRKB	GDS61089	Drive Shaft	36		59.5	40.5	521				
	2014.02-		AT	R	F	Hatchback Engine CRKB	GDS61280	Drive Shaft	36		59.5	40	801				
	2014.02-		AT			Hatchback Engine CRKB	GC083100	Outer Joint	36	33	59.5	38	55	I			
2.0 TDi (110 kW)	2014.02-		AT			Hatchback Engine CRLB	GC083100	Outer Joint	36	33	59.5	38	55	I			
2.0 TDi (81 kW)	2014.05-		AT	R	F	Hatchback Engine CRVA	GDS61280	Drive Shaft	36		59.5	40	801				
	2014.05-					Hatchback Engine CRVA	GC083100	Outer Joint	36	33	59.5	38	55	I			
<b>GOLF V (1K1)</b>																	
1.4 16V (55 kW)	2003.10-2006.05				F	Hatchback Engine BCA	GCI83008	Inner Joint		33		32					
	2003.10-2006.05	MT			F	Hatchback Engine BCA	GC053001	Outer Joint	36	30	59.5	40	49	I			
	2003.10-2006.05	MT	L	F	Hatchback Engine BCA	GDS53007	Drive Shaft	36		59.5	40	559					
	2003.10-2006.05	MT	R	F	Hatchback Engine BCA	GDS53008	Drive Shaft	36		59.5	40	782					
1.4 16V (59 kW)	2006.06-2007.05				F	Hatchback Engine BUD	GCI83008	Inner Joint		33		32					
	2006.06-2007.05	5MT			F	Hatchback Engine BUD	GC053001	Outer Joint	36	30	59.5	40	49	I			
	2006.06-2007.05	5MT	L	F	Hatchback Engine BUD	GDS53007	Drive Shaft	36		59.5	40	559					
	2006.06-2007.05	MT	R	F	Hatchback Engine BUD	GDS53008	Drive Shaft	36		59.5	40	782					
1.4 FSi (66 kW)	2004.02-2007.02				F	Hatchback Engine BKG/BLN	GCI83008	Inner Joint		33		32					
	2004.02-2007.02	MT			F	Hatchback Engine BKG/BLN	GC053001	Outer Joint	36	30	59.5	40	49	I			
	2004.02-2007.02	5MT	L	F	Hatchback Engine BKG/BLN	GDS53007	Drive Shaft	36		59.5	40	559					
1.4 TSi (103 kW)	2006.06-2008.03				F	Hatchback Engine BMY	GC083037	Outer Joint	36	30	59.5	40.5	55	I			
	2006.06-2008.03	6AT			F	Hatchback Engine BMY	GC083002	Outer Joint	36	27	59.5	40	66	I			
	2006.06-2008.03	MT			F	Hatchback Engine BMY	GCI83011	Inner Joint		33		34					
	2006.06-2008.03	MT	L	F	Hatchback Engine BMY	GDS61201	Drive Shaft	36		59.5	40.5	535					
1.4 TSi (125 kW)	2006.06-2008.03	6MT/6AT			F	Hatchback Engine BLG	GC083002	Outer Joint	36	27	59.5	40	66	I			
	2006.06-2008.03	MT	L	F	Hatchback Engine BLG	GDS83302	Drive Shaft	36		59.5	40	528					
1.4 TSi (90 kW)	2007.09-2008.11				F	Hatchback Engine CAXA	GC083037	Outer Joint	36	30	59.5	40.5	55	I			
	2007.09-2008.11	MT			F	Hatchback Engine CAXA	GCI83011	Inner Joint		33		34					
	2007.09-2008.11	Semi-AT			F	Hatchback Engine CAXA	GC083002	Outer Joint	36	27	59.5	40	66	I			
1.6 (75 kW)	2004.01-2008.11				F	Hatchback Engine BGU/BSE/BSF	GC083037	Outer Joint	36	30	59.5	40.5	55	I			
	2004.01-2008.11	6AT			F	Hatchback Engine BGU/BSE/BSF	GCI61011	Inner Joint	26	32	31	68.5	85				
	2004.01-2008.11	MT			F	Hatchback Engine BGU/BSE/BSF	GCI83011	Inner Joint		33		34					



		TRANSM	L/R	F/R		G-AP Ref.	PRODUCT	ABS	Technical Specifications							
									YEAR	A	B	C	H	L	P	
<b>VOLKSWAGEN</b>																
<b>GOLF V (1K1)</b>																
1.6 (75 kW)	2004.01-	2008.11	6AT	L	F	Hatchback Engine BGU/BSE/BSF	GDS61093	Drive Shaft	36	26	59.5	40.5	587.5			
	2004.01-	2008.11	AT	L	F	Hatchback Engine BGU/BSE/BSF	GDS83318	Drive Shaft	36	26	59.5	38	581			
	2004.01-	2008.11	MT	L	F	Hatchback Engine BGU/BSE/BSF	GDS61097	Drive Shaft	36		59.5	40.5	543			
	2004.01-	2008.11	MT	L	F	Hatchback Engine BGU/BSE/BSF	GDS83320	Drive Shaft	36		59.5	40	546			
	2004.01-	2008.11	6AT	R	F	Hatchback Engine BGU/BSE/BSF	GDS61094	Drive Shaft	36	26	59.5	40.5	884			
	2004.01-	2008.11	AT	R	F	Hatchback Engine BGU/BSE/BSF	GDS83346	Drive Shaft	36	26	59.5	38	879			
	2004.01-	2008.11	AT	R	F	Hatchback Engine BGU/BSE/BSF	GCI61011	Inner Joint	26	32	31	68.5	85			
	2004.01-	2008.11	AT	R	F	Hatchback Engine BGU/BSE/BSF	GC083116	Outer Joint	36	30	59.5	38	55	I		
1.6 FSi (85 kW)	2004.02-	2008.03			F	Hatchback Engine BAG/BLF/BLP	GC083037	Outer Joint	36	30	59.5	40.5	55	I		
	2004.02-	2008.03	MT		F	Hatchback Engine BAG/BLF/BLP	GCI83011	Inner Joint		33		34				
	2004.02-	2008.03	MT	L	F	Hatchback Engine BAG/BLF/BLP	GDS83319	Drive Shaft	36		59.5	38	557			
	2004.02-	2008.03	MT	R	F	Hatchback Engine BAG/BLF/BLP	GDS61211	Drive Shaft	36		59.5	40.5	784			
1.9 TDi (66 kW)	2004.05-	2008.11	MT		F	Hatchback Engine BRU/BXF/BXJ	GCI83011	Inner Joint		33		34				
	2004.05-	2008.11		L	F	Hatchback Engine BRU/BXF/BXJ	GDS83294	Drive Shaft	36		59.5	38	519			
	2004.05-	2008.11	AT	L	F	Hatchback Engine BRU/BXF/BXJ	GDS83241	Drive Shaft	36		59.5	40	475			
	2004.05-	2008.11	MT	L	F	Hatchback Engine BRU/BXF/BXJ	GDS61089	Drive Shaft	36		59.5	40.5	521			
1.9 TDi (77 kW)	2004.05-	2008.11		R	F	Hatchback Engine BRU/BXF/BXJ	GDS61042	Drive Shaft	36		59.5	40.5	814			
	2004.02-	2008.03			F	Hatchback Engine BKC/BLS/BXE	GC083037	Outer Joint	36	30	59.5	40.5	55	I		
	2004.02-	2008.03	6AT		F	Hatchback Engine BKC/BLS/BXE	GCI54004	Inner Joint		34		85				
	2004.02-	2008.03	AT		F	Hatchback Engine BKC/BLS/BXE	GC083002	Outer Joint	36	27	59.5	40	66	I		
	2004.02-	2008.03	MT		F	Hatchback Engine BKC/BLS/BXE	GCI53002	Inner Joint		33		34				
	2004.02-	2008.03	5MT	L	F	Hatchback Engine BKC/BLS/BXE	GDS83294	Drive Shaft	36		59.5	38	519			
	2004.02-	2008.03	6MT	L	F	Hatchback Engine BKC/BLS/BXE	GDS83294	Drive Shaft	36		59.5	38	519			
	2004.02-	2008.03	AT	L	F	Hatchback Engine BKC/BLS/BXE	GDS83241	Drive Shaft	36		59.5	40	475			
	2004.02-	2008.03	AT	L	F	Hatchback Engine BKC/BLS/BXE	GDS54013	Drive Shaft	36		59.5	40	479.5			
	2004.02-	2008.03	MT	L	F	Hatchback Engine BKC/BLS/BXE	GDS61089	Drive Shaft	36		59.5	40.5	521			
	2004.02-	2008.03	AT	L/R	F	Hatchback Engine BKC/BLS/BXE	GCI61057	Inner Joint		34		86				
	2004.02-	2008.03	5MT	R	F	Hatchback Engine BKC/BLS/BXE	GDS61042	Drive Shaft	36		59.5	40.5	814			
1.9 TDi 4motion (77 kW)	2004.02-	2008.03	AT	R	F	Hatchback Engine BKC/BLS/BXE	GDS83355	Drive Shaft	36	23	59.5	40	799			
	2004.02-	2008.03	AT	R	F	Hatchback Engine BKC/BLS/BXE	GDS54011	Drive Shaft	36		59.5	40	755			
	2004.08-	2008.11	6AT			Hatchback Engine BKC/BLS/BXE	GCI54004	Inner Joint		34		85				
	2004.08-	2008.11		L		Hatchback Engine BKC/BLS/BXE	GDS83295	Drive Shaft	36		59.5	40	491			
	2004.08-	2008.11		R		Hatchback Engine BKC/BLS/BXE	GDS83266	Drive Shaft	36		59.5	40	601			
	2004.08-	2008.11	AT		F	Hatchback Engine BKC/BLS/BXE	GC083002	Outer Joint	36	27	59.5	40	66	I		
	2004.08-	2008.11	MT		F	Hatchback Engine BKC/BLS/BXE	GCI83011	Inner Joint		33		34				
	2004.08-	2008.11	MT	L	F	Hatchback Engine BKC/BLS/BXE	GDS83236	Drive Shaft	36		59.5	40	484			
	2004.08-	2008.11	MT		R	Hatchback Engine BKC/BLS/BXE	GCI53002	Inner Joint		33		34				
	2004.08-	2008.11	MT	L	R	Hatchback Engine BKC/BLS/BXE	GDS61284	Drive Shaft	36		59.5	79	594			
2004.08-	2008.11	MT	R	R	Hatchback Engine BKC/BLS/BXE	GDS61293	Drive Shaft	36		59.5	40	631				
2.0 FSi (110 kW)	2004.08-	2008.11		R		Hatchback Engine BKC/BLS/BXE	GCI83016	Inner Joint		28		32				
	2004.02-	2005.07			F	Hatchback Engine AXW/BLR/BLX/BLY/BVX/BVY/BVZ	GC083037	Outer Joint	36	30	59.5	40.5	55	I		
	2004.02-	2005.07	6AT		F	Hatchback Engine AXW/BLR/BLX/BLY/BVX/BVY/BVZ	GCI61011	Inner Joint	26	32	31	68.5	85			
	2004.02-	2005.07	MT		F	Hatchback Engine AXW/BLR/BLX/BLY/BVX/BVY/BVZ	GCI83011	Inner Joint		33		34				
	2004.02-	2005.07	6AT	L	F	Hatchback Engine AXW/BLR/BLX/BLY/BVX/BVY/BVZ	GDS61093	Drive Shaft	36	26	59.5	40.5	587.5			
	2004.02-	2005.07	MT	L	F	Hatchback Engine AXW/BLR/BLX/BLY/BVX/BVY/BVZ	GDS61089	Drive Shaft	36		59.5	40.5	521			
	2004.02-	2005.07	6AT	R	F	Hatchback Engine AXW/BLR/BLX/BLY/BVX/BVY/BVZ	GDS61094	Drive Shaft	36	26	59.5	40.5	884			
2.0 FSi 4motion (110 kW)	2004.02-	2005.07	MT	R	F	Hatchback Engine AXW/BLR/BLX/BLY/BVX/BVY/BVZ	GDS61113	Drive Shaft	36		59.5	40	814			
	2004.08-	2008.11	6AT			Hatchback Engine BLX/BVX	GCI61011	Inner Joint	26	32	31	68.5	85			
	2004.08-	2008.11		L		Hatchback Engine BLX/BVX	GDS83294	Drive Shaft	36		59.5	38	519			
	2004.08-	2008.11	MT		F	Hatchback Engine BLX/BVX	GCI83011	Inner Joint		33		34				
	2004.08-	2008.11	6AT	L	F	Hatchback Engine BLX/BVX	GDS61093	Drive Shaft	36	26	59.5	40.5	587.5			
	2004.08-	2008.11	MT	L	F	Hatchback Engine BLX/BVX	GDS61089	Drive Shaft	36		59.5	40.5	521			
	2004.08-	2008.11	6AT	R	F	Hatchback Engine BLX/BVX	GDS61094	Drive Shaft	36	26	59.5	40.5	884			
2.0 GTi (147 kW)	2004.08-	2008.11	MT		R	Hatchback Engine BLX/BVX	GCI53002	Inner Joint		33		34				
	2004.10-	2009.02	6AT		F	Hatchback Engine AXX/BWA/CAWB	GCI54004	Inner Joint		34		85				
	2004.10-	2009.02	6MT		F	Hatchback Engine AXX/BWA/CAWB	GC083002	Outer Joint	36	27	59.5	40	66	I		
	2004.10-	2009.02	AT	L	F	Hatchback Engine AXX/BWA/CAWB	GDS83241	Drive Shaft	36		59.5	40	475			
	2004.10-	2009.02	AT	L	F	Hatchback Engine AXX/BWA/CAWB	GDS54013	Drive Shaft	36		59.5	40	479.5			
	2004.10-	2009.02	MT&AT	L	F	Hatchback Engine AXX/BWA/CAWB	GDS83295	Drive Shaft	36		59.5	40	491			
2004.10-	2009.02		L	F	Hatchback Engine AXX/BWA/CAWB	GDS83236	Drive Shaft	36		59.5	40	484				





		TRANSM	L/R	F/R		G-AP Ref.	PRODUCT	ABS	Technical Specifications									
									YEAR	A	B	C	H	L	P			
<b>VOLKSWAGEN</b>																		
<b>GOLF V (1K1)</b>																		
2.0 GTi (147 kW)	2004.10-2009.02		AT	L/R	F	Hatchback Engine AXX/BWA/CAWB	GCI61057	Inner Joint		34		86						
	2004.10-2009.02			R	F	Hatchback Engine AXX/BWA/CAWB	GDS61126	Drive Shaft	36		59.5	40	793					
2.0 GTi (169 kW)	2006.09-2008.12		MT		F	Hatchback Engine BYD	GC083002	Outer Joint	36	27	59.5	40	66	I				
	2006.09-2008.12			L	F	Hatchback Engine BYD	GDS83295	Drive Shaft	36		59.5	40	491					
	2006.09-2008.12			L	F	Hatchback Engine BYD	GDS83236	Drive Shaft	36		59.5	40	484					
	2006.09-2008.12			R	F	Hatchback Engine BYD	GDS61126	Drive Shaft	36		59.5	40	793					
2.0 SDi (55 kW)	2004.02-2007.05		MT		F	Hatchback Engine BDK	GCI83011	Inner Joint		33		34						
2.0 TDi (100 kW)	2003.10-2008.11		6AT		F	Hatchback Engine AZV	GCI54004	Inner Joint		34		85						
	2003.10-2008.11		6MT/6AT		F	Hatchback Engine AZV	GC083002	Outer Joint	36	27	59.5	40	66	I				
	2003.10-2008.11		AT	L	F	Hatchback Engine AZV	GDS83241	Drive Shaft	36		59.5	40	475					
	2003.10-2008.11		AT	L	F	Hatchback Engine AZV	GDS54013	Drive Shaft	36		59.5	40	479.5					
	2003.10-2008.11		MT	L	F	Hatchback Engine AZV	GCI83016	Inner Joint		28		32						
	2003.10-2008.11		MT	L	F	Hatchback Engine AZV	GDS83265	Drive Shaft	36		59.5	40	487					
	2003.10-2008.11		MT	L	F	Hatchback Engine AZV	GDS83295	Drive Shaft	36		59.5	40	491					
	2003.10-2008.11		AT	L/R	F	Hatchback Engine AZV	GCI61057	Inner Joint		34		86						
	2003.10-2008.11		AT	R	F	Hatchback Engine AZV	GDS83355	Drive Shaft	36	23	59.5	40	799					
	2003.10-2008.11		AT	R	F	Hatchback Engine AZV	GDS54011	Drive Shaft	36		59.5	40	755					
2.0 TDi (103 kW)	2004.02-2008.03				F	Hatchback Engine BMM	GC083037	Outer Joint	36	30	59.5	40.5	55	I				
	2004.02-2008.03		6AT		F	Hatchback Engine BMM	GCI54004	Inner Joint		34		85						
	2004.02-2008.03		6MT/6AT		F	Hatchback Engine BMM	GC083002	Outer Joint	36	27	59.5	40	66	I				
	2004.02-2008.03		AT	L	F	Hatchback Engine BMM	GDS83241	Drive Shaft	36		59.5	40	475					
	2004.02-2008.03		AT	L	F	Hatchback Engine BMM	GDS54013	Drive Shaft	36		59.5	40	479.5					
	2004.02-2008.03		MT	L	F	Hatchback Engine BMM	GDS83236	Drive Shaft	36		59.5	40	484					
	2004.02-2008.03		MT	L	F	Hatchback Engine BMM	GCI83016	Inner Joint		28		32						
	2004.02-2008.03		MT	L	F	Hatchback Engine BMM	GDS83265	Drive Shaft	36		59.5	40	487					
	2004.02-2008.03		MT	L	F	Hatchback Engine BMM	GDS83295	Drive Shaft	36		59.5	40	491					
	2004.02-2008.03		AT	L/R	F	Hatchback Engine BMM	GCI61057	Inner Joint		34		86						
	2004.02-2008.03		AT	R	F	Hatchback Engine BMM	GDS83355	Drive Shaft	36	23	59.5	40	799					
	2004.02-2008.03		AT	R	F	Hatchback Engine BMM	GDS54011	Drive Shaft	36		59.5	40	755					
	2004.02-2008.03		MT	R	F	Hatchback Engine BMM	GDS61126	Drive Shaft	36		59.5	40	793					
	2004.02-2008.03		MT	R	F	Hatchback Engine BMM	GDS83313	Drive Shaft	36		59.5	40	792					
2.0 TDi (125 kW)	2006.06-2008.03		6MT/6AT		F	Hatchback Engine BMN	GC061045	Outer Joint	36	27	59.5	40	65	M				
	2006.06-2008.03		AT	L	F	Hatchback Engine BMN	GDS83241	Drive Shaft	36		59.5	40	475					
	2006.06-2008.03		MT	L	F	Hatchback Engine BMN	GDS83236	Drive Shaft	36		59.5	40	484					
	2006.06-2008.03		MT	L	F	Hatchback Engine BMN	GCI83016	Inner Joint		28		32						
	2006.06-2008.03		MT	L	F	Hatchback Engine BMN	GDS83265	Drive Shaft	36		59.5	40	487					
	2006.06-2008.03		AT	L/R	F	Hatchback Engine BMN	GCI61057	Inner Joint		34		86						
	2006.06-2008.03		AT	R	F	Hatchback Engine BMN	GDS83355	Drive Shaft	36	23	59.5	40	799					
	2006.06-2008.03		AT	R	F	Hatchback Engine BMN	GDS54011	Drive Shaft	36		59.5	40	755					
	2006.06-2008.03		MT	R	F	Hatchback Engine BMN	GDS61126	Drive Shaft	36		59.5	40	793					
2.0 TDi 16V (103 kW)	2004.02-2008.03				F	Hatchback Engine BKD	GC083037	Outer Joint	36	30	59.5	40.5	55	I				
	2004.02-2008.03				F	Hatchback Engine BKD	GC083002	Outer Joint	36	27	59.5	40	66	I				
	2004.02-2008.03		6AT		F	Hatchback Engine BKD	GCI54004	Inner Joint		34		85						
	2004.02-2008.03		AT	L	F	Hatchback Engine BKD	GDS54013	Drive Shaft	36		59.5	40	479.5					
	2004.02-2008.03		MT	L	F	Hatchback Engine BKD	GDS83236	Drive Shaft	36		59.5	40	484					
	2004.02-2008.03		MT	L	F	Hatchback Engine BKD	GCI83016	Inner Joint		28		32						
	2004.02-2008.03		MT	L	F	Hatchback Engine BKD	GDS83265	Drive Shaft	36		59.5	40	487					
	2004.02-2008.03		MT	L	F	Hatchback Engine BKD	GDS83295	Drive Shaft	36		59.5	40	491					
	2004.02-2008.03			L	F	Hatchback Engine BKD	GDS83241	Drive Shaft	36		59.5	40	475					
	2004.02-2008.03		AT	L/R	F	Hatchback Engine BKD	GCI61057	Inner Joint		34		86						
	2004.02-2008.03		AT	R	F	Hatchback Engine BKD	GDS83355	Drive Shaft	36	23	59.5	40	799					
	2004.02-2008.03		AT	R	F	Hatchback Engine BKD	GDS54011	Drive Shaft	36		59.5	40	755					
	2004.02-2008.03		MT	R	F	Hatchback Engine BKD	GDS61126	Drive Shaft	36		59.5	40	793					
	2004.02-2008.03		MT	R	F	Hatchback Engine BKD	GDS83313	Drive Shaft	36		59.5	40	792					
2.0 TDi 16V 4motion (103 kW)	2004.08-2008.11		6AT			Hatchback Engine BKD	GCI54004	Inner Joint		34		85						
	2004.08-2008.11			L		Hatchback Engine BKD	GDS83295	Drive Shaft	36		59.5	40	491					
	2004.08-2008.11			R		Hatchback Engine BKD	GDS83266	Drive Shaft	36		59.5	40	601					
	2004.08-2008.11		MT		F	Hatchback Engine BKD	GC083002	Outer Joint	36	27	59.5	40	66	I				
	2004.08-2008.11		MT		R	Hatchback Engine BKD	GCI53002	Inner Joint		33		34						
	2004.08-2008.11			R		Hatchback Engine BKD	GCI83016	Inner Joint		28		32						
2.0 TDi 4motion (103 kW)	2006.06-2008.03		6AT			Hatchback Engine BMM	GCI54004	Inner Joint		34		85						









		TRANSM	L/R	F/R		G-AP Ref.	PRODUCT	ABS	Technical Specifications								
									YEAR	A	B	C	H	L	P		
<b>VOLKSWAGEN</b>																	
<b>GOLF V (1K1)</b>																	
2.0 TDi 4motion (103 kW)	2006.06-	2008.03			L	Hatchback Engine BMM	GDS83295	Drive Shaft	36		59.5	40	491				
	2006.06-	2008.03			R	Hatchback Engine BMM	GDS83266	Drive Shaft	36		59.5	40	601				
	2006.06-	2008.03	6MT		F	Hatchback Engine BMM	GC083002	Outer Joint	36	27	59.5	40	66	I			
	2006.06-	2008.03	MT	L	F	Hatchback Engine BMM	GDS83236	Drive Shaft	36		59.5	40	484				
	2006.06-	2008.03	MT		R	Hatchback Engine BMM	GCI53002	Inner Joint		33		34					
	2006.06-	2008.03	MT	L	R	Hatchback Engine BMM	GDS61284	Drive Shaft	36		59.5	79	594				
	2006.06-	2008.03	MT	R	R	Hatchback Engine BMM	GDS61293	Drive Shaft	36		59.5	40	631				
	2006.06-	2008.03			R	Hatchback Engine BMM	GCI83016	Inner Joint		28		32					
3.2 (184 kW)	2005.09-	2008.11			L	Hatchback Engine BUB	GDS83295	Drive Shaft	36		59.5	40	491				
	2005.09-	2008.11	MT		L	Hatchback Engine BUB	GDS83236	Drive Shaft	36		59.5	40	484				
	2005.09-	2008.11			R	Hatchback Engine BUB	GDS83266	Drive Shaft	36		59.5	40	601				
	2005.09-	2008.11			R	Hatchback Engine BUB	GCI83016	Inner Joint		28		32					
3.2 R32 4motion (184 kW)	2005.09-	2007.05	MT		R	Hatchback Engine BUB/CBRA	GCI53002	Inner Joint		33		34					
	2005.09-	2007.05			R	Hatchback Engine BUB/CBRA	GCI83016	Inner Joint		28		32					
	2005.09-	2007.05			L	Hatchback Engine BUB/CBRA	GDS83295	Drive Shaft	36		59.5	40	491				
	2005.09-	2007.05			R	Hatchback Engine BUB/CBRA	GDS83266	Drive Shaft	36		59.5	40	601				
	2005.09-	2007.05	6MT/6AT		F	Hatchback Engine BUB/CBRA	GC083002	Outer Joint	36	27	59.5	40	66	I			
	2005.09-	2007.05	MT&AT	L	F	Hatchback Engine BUB/CBRA	GDS83236	Drive Shaft	36		59.5	40	484				
<b>GOLF V (1K1, 1K5)</b>																	
1.4 16V (55 kW)	2003.10-						GC053001	Outer Joint	36	30	59.5	40	49	I			
1.4 16V (59 kW)	2003.10-						GC053001	Outer Joint	36	30	59.5	40	49	I			
	2006.05-						GC083002	Outer Joint	36	27	59.5	40	66	I			
1.4 FSi (66 kW)	2003.10-						GC053001	Outer Joint	36	30	59.5	40	49	I			
1.4 TSi (103 kW)	2006.05-		AT				GC083002	Outer Joint	36	27	59.5	40	66	I			
	2006.05-		MT				GC083037	Outer Joint	36	30	59.5	40.5	55	I			
1.4 TSi (125 kW)	2005.11-		AT				GC083002	Outer Joint	36	27	59.5	40	66	I			
1.4 TSi (90 kW)	2006.05-		AT				GC083002	Outer Joint	36	27	59.5	40	66	I			
	2006.05-		MT				GC083037	Outer Joint	36	30	59.5	40.5	55	I			
1.6 (75 kW)	2004.11-		MT/AT				GC083037	Outer Joint	36	30	59.5	40.5	55	I			
1.6 FSi (85 kW)	2003.10-						GC083037	Outer Joint	36	30	59.5	40.5	55	I			
1.9 TDi (66 kW)	2003.10-		AT			Engine BKC	GC083002	Outer Joint	36	27	59.5	40	66	I			
	2004.05-		MT				GC083037	Outer Joint	36	30	59.5	40.5	55	I			
1.9 TDi (77 kW)	2003.10-		AT			Engine BKC	GC083002	Outer Joint	36	27	59.5	40	66	I			
	2004.05-		MT				GC083037	Outer Joint	36	30	59.5	40.5	55	I			
1.9 TDi 4motion (77 kW)	2004.08-				F		GC083002	Outer Joint	36	27	59.5	40	66	I			
2.0 FSi (110 kW)	2004.01-		MT/AT				GC083037	Outer Joint	36	30	59.5	40.5	55	I			
2.0 FSi 4motion (110 kW)	2004.01-					RWD	GC083037	Outer Joint	36	30	59.5	40.5	55	I			
2.0 SDi (55 kW)	2004.01-						GC083037	Outer Joint	36	30	59.5	40.5	55	I			
2.0 TDi (100 kW)	2003.10-		MT/AT			Engine BKO	GC083002	Outer Joint	36	27	59.5	40	66	I			
2.0 TDi (103 kW)	2003.10-		MT/AT			Engine BKO	GC083002	Outer Joint	36	27	59.5	40	66	I			
	2004.12-					Engine BMM	GC083037	Outer Joint	36	30	59.5	40.5	55	I			
2.0 TDi 4motion (100 kW)	2003.10-						GC083002	Outer Joint	36	27	59.5	40	66	I			
2.0 TDi 4motion (103 kW)	2003.10-					RWD	GC083037	Outer Joint	36	30	59.5	40.5	55	I			
	2003.10-						GC083002	Outer Joint	36	27	59.5	40	66	I			
2.0 TFSi (147 kW)	2004-	2007.02					GC083002	Outer Joint	36	27	59.5	40	66	I			
2.0 TFSi (169 kW)	2004-	2007.02					GC083002	Outer Joint	36	27	59.5	40	66	I			
3.2 R32 4motion (184 kW)	2006-						GC083002	Outer Joint	36	27	59.5	40	66	I			
<b>GOLF V PLUS (1KP)</b>																	
1.4 16V (55 kW)	2004.10-	2008.12					GC053001	Outer Joint	36	30	59.5	40	49	I			
1.4 16V (59 kW)	2004.10-	2008.12					GC053001	Outer Joint	36	30	59.5	40	49	I			
1.4 FSi (103 kW)	2005.07-	2008.12					GC053001	Outer Joint	36	30	59.5	40	49	I			
1.4 FSi (125 kW)	2005.07-	2008.12					GC053001	Outer Joint	36	30	59.5	40	49	I			
1.4 FSi (66 kW)	2005.07-	2008.12					GC053001	Outer Joint	36	30	59.5	40	49	I			
1.4 TSi (118 kW)	2005.07-	2008.12	MT				GC083037	Outer Joint	36	30	59.5	40.5	55	I			
	2005.07-	2008.12				Double Clutch	GC083002	Outer Joint	36	27	59.5	40	66	I			
	2008.11-					Double Clutch	GCI83016	Inner Joint		28		32					
1.4 TSi (90 kW)	2005.07-	2008.12	MT				GC083037	Outer Joint	36	30	59.5	40.5	55	I			
	2005.07-	2008.12				Double Clutch	GC083002	Outer Joint	36	27	59.5	40	66	I			
	2008.11-					Double Clutch	GCI83016	Inner Joint		28		32					
1.6 (75 kW)	2005.05-	2008.12	MT/AT				GC083037	Outer Joint	36	30	59.5	40.5	55	I			
1.6 FSi (85 kW)	2007.11-	2012.08	MT/AT				GC083037	Outer Joint	36	30	59.5	40.5	55	I			



		TRANSM	L/R	F/R		G-AP Ref.	PRODUCT	ABS	Technical Specifications									
									YEAR	A	B	C	H	L	P			
<b>VOLKSWAGEN GOLF V PLUS (1KP)</b>																		
1.9 TDi (66 kW)	2005.05-	2008.12	AT		Engine BKC	GC083002	Outer Joint		36	27	59.5	40	66	I				
	2005.05-	2008.12	MT			GC083037	Outer Joint		36	30	59.5	40.5	55	I				
1.9 TDi (77 kW)	2005.05-	2008.12	AT		Engine BKC	GC083002	Outer Joint		36	27	59.5	40	66	I				
	2005.05-	2008.12	MT			GC083037	Outer Joint		36	30	59.5	40.5	55	I				
2.0 FSi (110 kW)	2005.11-	2008.12	MT/AT			GC083037	Outer Joint		36	30	59.5	40.5	55	I				
2.0 TDi (100 kW)	2005.01-	2008.12	MT/AT		Engine BKD	GC083002	Outer Joint		36	27	59.5	40	66	I				
	2005.01-	2008.12	MT		Engine BKD	GCI83016	Inner Joint			28		32						
2.0 TDi (103 kW)	2004.10-	2008.12	MT		Engine BKD	GC083037	Outer Joint		36	30	59.5	40.5	55	I				
	2005.01-	2008.12	MT/AT		Engine BKD	GC083002	Outer Joint		36	27	59.5	40	66	I				
	2005.01-	2008.12	MT		Engine BKD	GCI83016	Inner Joint			28		32						
<b>GOLF V VARIANT (1K5)</b>																		
1.4 (59 kW)	2007.06-				F Estate Engine BUD	GCI83008	Inner Joint			33		32						
	2007.06-		5MT		F Estate Engine BUD	GC053001	Outer Joint		36	30	59.5	40	49	I				
	2007.06-		MT	L	F Estate Engine BUD	GDS53007	Drive Shaft		36		59.5	40	559					
	2007.06-		MT	R	F Estate Engine BUD	GDS53008	Drive Shaft		36		59.5	40	782					
1.4 TSi (103 kW)	2007.06-				F Estate Engine BMY	GC083037	Outer Joint		36	30	59.5	40.5	55	I				
	2007.06-		6AT		F Estate Engine BMY	GC083002	Outer Joint		36	27	59.5	40	66	I				
	2007.06-		MT		F Estate Engine BMY	GCI53002	Inner Joint			33		34						
	2007.06-		MT	L	F Estate Engine BMY	GDS83302	Drive Shaft		36		59.5	40	528					
1.4 TSi (118 kW)	2008.07-				F Estate Engine CAVD	GC083037	Outer Joint		36	30	59.5	40.5	55	I				
	2008.07-		MT		F Estate Engine CAVD	GCI53002	Inner Joint			33		34						
	2008.07-		MT	L	F Estate Engine CAVD	GDS61201	Drive Shaft		36		59.5	40.5	535					
1.4 TSi (125 kW)	2007.06-		6MT/6AT		F Estate Engine BLG	GC083002	Outer Joint		36	27	59.5	40	66	I				
	2007.06-		MT	L	F Estate Engine BLG	GDS83302	Drive Shaft		36		59.5	40	528					
1.4 TSi (90 kW)	2007.06-				F Estate Engine CAXA	GC083037	Outer Joint		36	30	59.5	40.5	55	I				
	2007.06-		MT		F Estate Engine CAXA	GCI53002	Inner Joint			33		34						
	2007.06-		Semi-AT		F Estate Engine CAXA	GC083002	Outer Joint		36	27	59.5	40	66	I				
	2007.06-			L	F Estate Engine CAXA	GDS61201	Drive Shaft		36		59.5	40.5	535					
	2007.06-				Estate Engine CAXA	GC083100	Outer Joint		36	33	59.5	38	55	I				
1.6 (75 kW)	2007.06-				F Estate Engine BSE/BSF/CCSA/BGU	GC083037	Outer Joint		36	30	59.5	40.5	55	I				
	2007.06-		6AT		F Estate Engine BSE/BSF/CCSA/BGU	GCI61011	Inner Joint		26	32	31	68.5	85					
	2007.06-		MT		F Estate Engine BSE/BSF/CCSA/BGU	GCI83011	Inner Joint			33		34						
	2007.06-		6AT	L	F Estate Engine BSE/BSF/CCSA/BGU	GDS61093	Drive Shaft		36	26	59.5	40.5	587.5					
	2007.06-		MT	L	F Estate Engine BSE/BSF/CCSA/BGU	GDS83320	Drive Shaft		36		59.5	40	546					
	2007.06-		6AT	R	F Estate Engine BSE/BSF/CCSA/BGU	GDS61094	Drive Shaft		36	26	59.5	40.5	884					
	2007.06-		7AT	L	F Estate Engine BSE/BSF/CCSA/BGU	GDS61089	Drive Shaft		36		59.5	40.5	521					
	2007.06-		AT	R	F Estate Engine BSE/BSF/CCSA/BGU	GDS83346	Drive Shaft		36	26	59.5	38	879					
	2007.06-		AT	R	F Estate Engine BSE/BSF/CCSA/BGU	GCI61011	Inner Joint		26	32	31	68.5	85					
	2007.06-		AT	R	F Estate Engine BSE/BSF/CCSA/BGU	GC083116	Outer Joint		36	30	59.5	38	55	I				
1.9 TDi (77 kW)	2007.06-		6AT		F Estate Engine BLS/BXE	GC083002	Outer Joint		36	27	59.5	40	66	I				
	2007.06-		6AT		F Estate Engine BLS/BXE	GCI54004	Inner Joint			34		85						
	2007.06-		MT		F Estate Engine BLS/BXE	GCI83011	Inner Joint			33		34						
	2007.06-		MT/6MT		F Estate Engine BLS/BXE	GC083037	Outer Joint		36	30	59.5	40.5	55	I				
	2007.06-		6AT	L	F Estate Engine BLS/BXE	GDS54013	Drive Shaft		36		59.5	40	479.5					
	2007.06-		MT	L	F Estate Engine BLS/BXE	GDS83294	Drive Shaft		36		59.5	38	519					
	2007.06-		6AT	R	F Estate Engine BLS/BXE	GDS54011	Drive Shaft		36		59.5	40	755					
	2007.06-		MT	R	F Estate Engine BLS/BXE	GDS61042	Drive Shaft		36		59.5	40.5	814					
	2007.06-		AT	L	F Estate Engine BLS/BXE	GDS83241	Drive Shaft		36		59.5	40	475					
	2007.06-		MT	L	F Estate Engine BLS/BXE	GDS61089	Drive Shaft		36		59.5	40.5	521					
1.9 TDi 4motion (77 kW)	2008.01-		6AT		Estate Engine BLS	GCI54004	Inner Joint			34		85						
	2008.01-		6MT/6AT		Estate Engine BLS	GC083002	Outer Joint		36	27	59.5	40	66	I				
	2008.01-			L	Estate Engine BLS	GDS83295	Drive Shaft		36		59.5	40	491					
	2008.01-		AT	L	Estate Engine BLS	GDS54013	Drive Shaft		36		59.5	40	479.5					
	2008.01-		AT	R	Estate Engine BLS	GDS54011	Drive Shaft		36		59.5	40	755					
	2008.01-		MT	R	Estate Engine BLS	GDS83266	Drive Shaft		36		59.5	40	601					
	2008.01-		MT		F Estate Engine BLS	GCI83011	Inner Joint			33		34						
	2008.01-		MT	R	Estate Engine BLS	GCI53002	Inner Joint			33		34						
	2008.01-		6AT	L	F Estate Engine BLS	GDS83241	Drive Shaft		36		59.5	40	475					
	2008.01-		MT	L	F Estate Engine BLS	GDS83236	Drive Shaft		36		59.5	40	484					

		TRANSM	L/R	F/R		G-AP Ref.	PRODUCT	ABS	Technical Specifications								
									YEAR	A	B	C	H	L	P		
<b>VOLKSWAGEN</b>																	
<b>GOLF V VARIANT (1K5)</b>																	
1.9 TDi 4motion (77 kW)	2008.01-		AT	L/R	F	Estate Engine BLS	GCI61057	Inner Joint		34		86					
	2008.01-		MT	R		Estate Engine BLS	GCI83016	Inner Joint		28		32					
2.0 (147 kW)	2007.06-		6MT/6AT		F	Estate Engine BWA/CAWB	GC083002	Outer Joint	36	27	59.5	40	66	I			
	2007.06-			L	F	Estate Engine BWA/CAWB	GDS83236	Drive Shaft	36		59.5	40	484				
	2007.06-			R	F	Estate Engine BWA/CAWB	GDS61126	Drive Shaft	36		59.5	40	793				
2.0 TDi (100 kW)	2007.06-				F	Estate Engine AZV	GC083002	Outer Joint	36	27	59.5	40	66	I			
	2007.06-		6AT		F	Estate Engine AZV	GCI54004	Inner Joint		34		85					
	2007.06-		MT	L	F	Estate Engine AZV	GDS83295	Drive Shaft	36		59.5	40	491				
	2007.06-		MT	R	F	Estate Engine AZV	GDS83313	Drive Shaft	36		59.5	40	792				
	2007.06-		AT	L	F	Estate Engine AZV	GDS83241	Drive Shaft	36		59.5	40	475				
	2007.06-		MT	L	F	Estate Engine AZV	GDS83236	Drive Shaft	36		59.5	40	484				
	2007.06-				R	F	Estate Engine AZV	GDS61126	Drive Shaft	36		59.5	40	793			
2.0 TDi (103 kW)	2007.06-				F	Estate Engine BMM	GC083037	Outer Joint	36	30	59.5	40.5	55	I			
	2007.06-		6AT		F	Estate Engine BMM	GCI54004	Inner Joint		34		85					
	2007.06-		6MT/6AT		F	Estate Engine BMM	GC083002	Outer Joint	36	27	59.5	40	66	I			
	2007.06-		AT	L	F	Estate Engine BMM	GDS54013	Drive Shaft	36		59.5	40	479.5				
	2007.06-		MT	L	F	Estate Engine BMM	GDS83295	Drive Shaft	36		59.5	40	491				
	2007.06-		AT	R	F	Estate Engine BMM	GDS54011	Drive Shaft	36		59.5	40	755				
	2007.06-		MT	R	F	Estate Engine BMM	GDS83313	Drive Shaft	36		59.5	40	792				
	2007.06-		AT	L	F	Estate Engine BMM	GDS83241	Drive Shaft	36		59.5	40	475				
	2007.06-			L	F	Estate Engine BMM	GDS83236	Drive Shaft	36		59.5	40	484				
	2007.06-		AT	L/R	F	Estate Engine BMM	GCI61057	Inner Joint		34		86					
	2007.06-		AT	R	F	Estate Engine BMM	GDS83355	Drive Shaft	36	23	59.5	40	799				
2.0 TDi 16V (103 kW)	2007.06-				F	Estate Engine BKD/CBDB	GC083037	Outer Joint	36	30	59.5	40.5	55	I			
	2007.06-		6AT		F	Estate Engine BKD/CBDB	GCI54004	Inner Joint		34		85					
	2007.06-		6MT/6AT		F	Estate Engine BKD/CBDB	GC083002	Outer Joint	36	27	59.5	40	66	I			
	2007.06-		AT	L	F	Estate Engine BKD/CBDB	GDS54013	Drive Shaft	36		59.5	40	479.5				
	2007.06-		MT	L	F	Estate Engine BKD/CBDB	GDS83295	Drive Shaft	36		59.5	40	491				
	2007.06-		AT	R	F	Estate Engine BKD/CBDB	GDS54011	Drive Shaft	36		59.5	40	755				
	2007.06-		MT	R	F	Estate Engine BKD/CBDB	GDS83313	Drive Shaft	36		59.5	40	792				
	2007.06-		AT	L	F	Estate Engine BKD/CBDB	GDS83241	Drive Shaft	36		59.5	40	475				
	2007.06-		MT	L	F	Estate Engine BKD/CBDB	GDS83236	Drive Shaft	36		59.5	40	484				
	2007.06-		AT	L/R	F	Estate Engine BKD/CBDB	GCI61057	Inner Joint		34		86					
	2007.06-		AT	R	F	Estate Engine BKD/CBDB	GDS83355	Drive Shaft	36	23	59.5	40	799				
2.0 TDi 4motion (100 kW)	2007.06-		6AT			Estate Engine AZV	GCI54004	Inner Joint		34		85					
<b>GOLF VI (517)</b>																	
1.2 TSi (77 kW)	2011.03-	2013.11	MT	L	F	Convertible Engine CBZB	GDS61198	Drive Shaft	36		59.5	40.5	530				
	2011.03-	2013.11		L	F	Convertible Engine CBZB	GDS61201	Drive Shaft	36		59.5	40.5	535				
	2011.03-	2013.11				Convertible Engine CBZB	GC083100	Outer Joint	36	33	59.5	38	55	I			
1.4 TSi (118 kW)	2011.03-		7AT	L	F	Convertible Engine CAVD/CNWA/CTHD/CTKA	GDS61281	Drive Shaft	36		59.5	40	528				
	2011.03-		AT	L	F	Convertible Engine CAVD/CNWA/CTHD/CTKA	GDS61201	Drive Shaft	36		59.5	40.5	535				
1.4 TSi (90 kW)	2011.11-			L	F	Convertible Engine CAXA	GDS61201	Drive Shaft	36		59.5	40.5	535				
	2011.11-		AT	R	F	Convertible Engine CAXA	GDS61199	Drive Shaft	36		59.5	40.5	800				
	2011.11-				F	Convertible Engine CAXA	GC083100	Outer Joint	36	33	59.5	38	55	I			
1.6 TDi (77 kW)	2011.03-			L	F	Convertible Engine CAYC	GDS83294	Drive Shaft	36		59.5	38	519				
	2011.03-			R	F	Convertible Engine CAYC	GDS61042	Drive Shaft	36		59.5	40.5	814				
	2011.03-			L	F	Convertible Engine CAYC	GDS61089	Drive Shaft	36		59.5	40.5	521				
2.0 TDi (103 kW)	2011.11-		AT	L	F	Convertible Engine CFHC	GDS54013	Drive Shaft	36		59.5	40	479.5				
	2011.11-		MT	L	F	Convertible Engine CFHC	GDS83295	Drive Shaft	36		59.5	40	491				
	2011.11-		AT	R	F	Convertible Engine CFHC	GDS54011	Drive Shaft	36		59.5	40	755				
	2011.11-		MT	R	F	Convertible Engine CFHC	GDS83313	Drive Shaft	36		59.5	40	792				
	2011.11-		MT	L	F	Convertible Engine CFHC	GDS83236	Drive Shaft	36		59.5	40	484				
	2011.11-		AT	R	F	Convertible Engine CFHC	GDS83355	Drive Shaft	36	23	59.5	40	799				
2.0 TSi (162 kW)	2013.11-		MT		F	Hatchback Engine ABF	GC083036	Outer Joint	36	30	53.2	77.5	61	I			
<b>GOLF VI (5K1)</b>																	
1.2 TSi (63 kW)	2010.05-	2012.11	AT	L	F	Hatchback Engine CBZA	GDS61201	Drive Shaft	36		59.5	40.5	535				
	2010.05-	2012.11	MT	L	F	Hatchback Engine CBZA	GDS61198	Drive Shaft	36		59.5	40.5	530				
	2010.05-	2012.11	AT			Hatchback Engine CBZA	GC083100	Outer Joint	36	33	59.5	38	55	I			









		TRANSM	L/R	F/R		G-AP Ref.	PRODUCT	ABS	Technical Specifications									
									YEAR	A	B	C	H	L	P			
<b>VOLKSWAGEN</b>																		
<b>GOLF VI (5K1)</b>																		
1.2 TSi (63 kW)	2010.05-	2012.11				Hatchback Engine CBZA	GC061059	Outer Joint		36	33	59.5	40	59.5				
1.2 TSi (77 kW)	2009.05-	2012.11	MT		F	Hatchback Engine CBZB	GC083037	Outer Joint		36	30	59.5	40.5	55				
	2009.05-	2012.11	MT		F	Hatchback Engine CBZB	GCI53002	Inner Joint			33		34					
	2009.05-	2012.11	AT	L	F	Hatchback Engine CBZB	GDS61201	Drive Shaft		36		59.5	40.5	535				
	2009.05-	2012.11	MT	L	F	Hatchback Engine CBZB	GDS61198	Drive Shaft		36		59.5	40.5	530				
	2009.05-	2012.11	AT			Hatchback Engine CBZB	GC083100	Outer Joint		36	33	59.5	38	55				
	2009.05-	2012.11				Hatchback Engine CBZB	GC061059	Outer Joint		36	33	59.5	40	59.5				
1.4 (59 kW)	2008.10-	2012.11			F	Hatchback Engine CGGA	GCI83008	Inner Joint			33		32					
	2008.10-	2012.11			F	Hatchback Engine CGGA	GC053001	Outer Joint		36	30	59.5	40	49				
	2008.10-	2012.11	MT	L	F	Hatchback Engine CGGA	GDS53007	Drive Shaft		36		59.5	40	559				
1.4 TSi (118 kW)	2008.10-	2012.11			F	Hatchback Engine CTHD/CTKA/CNWA/CAVD	GC083037	Outer Joint		36	30	59.5	40.5	55				
	2008.10-	2012.11	AT		F	Hatchback Engine CTHD/CTKA/CNWA/CAVD	GC083002	Outer Joint		36	27	59.5	40	66				
	2008.10-	2012.11	MT		F	Hatchback Engine CTHD/CTKA/CNWA/CAVD	GCI83011	Inner Joint			33		34					
	2008.10-	2012.11	MT	L	F	Hatchback Engine CTHD/CTKA/CNWA/CAVD	GDS61201	Drive Shaft		36		59.5	40.5	535				
1.4 TSi (90 kW)	2008.10-	2012.11			F	Hatchback Engine CAXA	GC083037	Outer Joint		36	30	59.5	40.5	55				
	2008.10-	2012.11	AT		F	Hatchback Engine CAXA	GC083002	Outer Joint		36	27	59.5	40	66				
	2008.10-	2012.11	MT		F	Hatchback Engine CAXA	GCI83011	Inner Joint			33		34					
	2008.10-	2012.11	7AT	L	F	Hatchback Engine CAXA	GDS61281	Drive Shaft		36		59.5	40	528				
1.6 (75 kW)	2008.10-	2012.11			F	Hatchback Engine BSE/BSF/CCSA/CMXA	GCI83011	Inner Joint			33		34					
	2008.10-	2012.11			F	Hatchback Engine BSE/BSF/CCSA/CMXA	GC083037	Outer Joint		36	30	59.5	40.5	55				
	2008.10-	2012.11	6AT		F	Hatchback Engine BSE/BSF/CCSA/CMXA	GCI61011	Inner Joint		26	32	31	68.5	85				
	2008.10-	2012.11	MT		F	Hatchback Engine BSE/BSF/CCSA/CMXA	GCI53002	Inner Joint			33		34					
	2008.10-	2012.11	6AT	L	F	Hatchback Engine BSE/BSF/CCSA/CMXA	GDS61093	Drive Shaft		36	26	59.5	40.5	587.5				
	2008.10-	2012.11	7AT	L	F	Hatchback Engine BSE/BSF/CCSA/CMXA	GDS61089	Drive Shaft		36		59.5	40.5	521				
	2008.10-	2012.11	MT	L	F	Hatchback Engine BSE/BSF/CCSA/CMXA	GDS83320	Drive Shaft		36		59.5	40	546				
1.6 BiFuel (75 kW)	2008.10-	2012.11	6AT	R	F	Hatchback Engine BSE/BSF/CCSA/CMXA	GDS61094	Drive Shaft		36	26	59.5	40.5	884				
	2009.03-	2012.11			F	Hatchback Engine CHGA	GCI83011	Inner Joint			33		34					
	2009.03-	2012.11			F	Hatchback Engine CHGA	GC083037	Outer Joint		36	30	59.5	40.5	55				
	2009.03-	2012.11	MT		F	Hatchback Engine CHGA	GCI53002	Inner Joint			33		34					
	2009.03-	2012.11		L	F	Hatchback Engine CHGA	GDS83320	Drive Shaft		36		59.5	40	546				
	2009.03-	2012.11		L	F	Hatchback Engine CHGA	GDS83320	Drive Shaft		36		59.5	40	546				
1.6 MultiFuel (75 kW)	2008.10-	2012.11		L	F	Hatchback Engine CCSA/CMXA	GDS83320	Drive Shaft		36		59.5	40	546				
	2008.10-	2012.11	7AT	L	F	Hatchback Engine CCSA/CMXA	GDS61089	Drive Shaft		36		59.5	40.5	521				
1.6 TDi (66 kW)	2009.02-	2012.11	MT		F	Hatchback Engine CAYB	GC083037	Outer Joint		36	30	59.5	40.5	55				
	2009.02-	2012.11	MT		F	Hatchback Engine CAYB	GCI53002	Inner Joint			33		34					
	2009.02-	2012.11		L	F	Hatchback Engine CAYB	GDS83294	Drive Shaft		36		59.5	38	519				
	2009.02-	2012.11		L	F	Hatchback Engine CAYB	GDS61089	Drive Shaft		36		59.5	40.5	521				
	2009.02-	2012.11		R	F	Hatchback Engine CAYB	GDS61042	Drive Shaft		36		59.5	40.5	814				
	2009.02-	2012.11				Hatchback Engine CAYB	GC083100	Outer Joint		36	33	59.5	38	55				
1.6 TDi (77 kW)	2009.02-	2012.11			F	Hatchback Engine CAYC	GCI83011	Inner Joint			33		34					
	2009.02-	2012.11			F	Hatchback Engine CAYC	GC083002	Outer Joint		36	27	59.5	40	66				
	2009.02-	2012.11		L	F	Hatchback Engine CAYC	GDS83294	Drive Shaft		36		59.5	38	519				
	2009.02-	2012.11	AT	L	F	Hatchback Engine CAYC	GDS83236	Drive Shaft		36		59.5	40	484				
	2009.02-	2012.11	MT	L	F	Hatchback Engine CAYC	GDS61089	Drive Shaft		36		59.5	40.5	521				
	2009.02-	2012.11	MT	L	F	Hatchback Engine CAYC	GDS83294	Drive Shaft		36		59.5	38	519				
	2009.02-	2012.11		R	F	Hatchback Engine CAYC	GDS83266	Drive Shaft		36		59.5	40	601				
	2009.02-	2012.11	AT	R	F	Hatchback Engine CAYC	GDS61280	Drive Shaft		36		59.5	40	801				
	2009.02-	2012.11	MT	R	F	Hatchback Engine CAYC	GDS61042	Drive Shaft		36		59.5	40.5	814				
	2009.02-	2012.11		R	F	Hatchback Engine CAYC	GCI83016	Inner Joint			28		32					
2009.02-	2012.11	AT			Hatchback Engine CAYC	GC083100	Outer Joint		36	33	59.5	38	55					
1.8 TSi (118 kW)	2009.06-	2011.01	MT		F	Hatchback Engine CDAA	GC083037	Outer Joint		36	30	59.5	40.5	55				
	2009.06-	2011.01	7AT	L	F	Hatchback Engine CDAA	GDS83236	Drive Shaft		36		59.5	40	484				
	2009.06-	2011.01	MT	L	F	Hatchback Engine CDAA	GDS61131	Drive Shaft		36		59.5	40	515				
2.0 GTi (155 kW)	2009.04-	2012.11	MT	L	F	Hatchback Engine CCZB	GDS83295	Drive Shaft		36		59.5	40	491				
2.0 R 4motion (199 kW)	2009.11-	2012.11	MT		R	Hatchback Engine CDLF	GCI53002	Inner Joint			33		34					
2.0 TDi (100 kW)	2008.10-	2012.11		L	F	Hatchback Engine CBAA/CFFA	GDS83295	Drive Shaft		36		59.5	40	491				
	2008.10-	2012.11	AT	L	F	Hatchback Engine CBAA/CFFA	GDS83241	Drive Shaft		36		59.5	40	475				
	2008.10-	2012.11	MT	L	F	Hatchback Engine CBAA/CFFA	GDS83236	Drive Shaft		36		59.5	40	484				
	2008.10-	2012.11		R	F	Hatchback Engine CBAA/CFFA	GDS83313	Drive Shaft		36		59.5	40	792				
	2008.10-	2012.11	MT	R	F	Hatchback Engine CBAA/CFFA	GDS61126	Drive Shaft		36		59.5	40	793				
2.0 TDi (103 kW)	2008.10-	2013.05			F	Hatchback Engine CBAB/CFFB	GC083002	Outer Joint		36	27	59.5	40	66				
	2008.10-	2013.05	6AT		F	Hatchback Engine CBAB/CFFB	GCI54004	Inner Joint			34		85					



		TRANSM	L/R	F/R		G-AP Ref.	PRODUCT	ABS	Technical Specifications										
									YEAR	A	B	C	H	L	P				
<b>VOLKSWAGEN</b>																			
<b>GOLF VI (5K1)</b>																			
2.0 TDi (103 kW)	2008.10-	2013.05	AT	L	F	Hatchback Engine CBAB/CFFB	GDS83241	Drive Shaft	36		59.5	40	475						
	2008.10-	2013.05	AT	L	F	Hatchback Engine CBAB/CFFB	GDS54013	Drive Shaft	36		59.5	40	479.5						
	2008.10-	2013.05	MT	L	F	Hatchback Engine CBAB/CFFB	GDS83236	Drive Shaft	36		59.5	40	484						
	2008.10-	2013.05	MT	L	F	Hatchback Engine CBAB/CFFB	GDS83295	Drive Shaft	36		59.5	40	491						
	2008.10-	2013.05	AT	L/R	F	Hatchback Engine CBAB/CFFB	GCI61057	Inner Joint		34		86							
	2008.10-	2013.05	AT	R	F	Hatchback Engine CBAB/CFFB	GDS83355	Drive Shaft	36	23	59.5	40	799						
	2008.10-	2013.05	AT	R	F	Hatchback Engine CBAB/CFFB	GDS54011	Drive Shaft	36		59.5	40	755						
	2008.10-	2013.05	MT	R	F	Hatchback Engine CBAB/CFFB	GDS61126	Drive Shaft	36		59.5	40	793						
2.0 TDi (125 kW)	2008.10-	2013.05	MT	R	F	Hatchback Engine CBAB/CFFB	GDS83313	Drive Shaft	36		59.5	40	792						
	2009.04-	2012.11	MT	L	F	Hatchback Engine CFGB/CBBB	GDS83236	Drive Shaft	36		59.5	40	484						
	2009.04-	2012.11	MT	L	F	Hatchback Engine CFGB/CBBB	GCI83016	Inner Joint		28		32							
	2009.04-	2012.11	MT	L	F	Hatchback Engine CFGB/CBBB	GDS83265	Drive Shaft	36		59.5	40	487						
	2009.04-	2012.11	SEMI-AT	L	F	Hatchback Engine CFGB/CBBB	GDS83241	Drive Shaft	36		59.5	40	475						
	2009.04-	2012.11	AT	R	F	Hatchback Engine CFGB/CBBB	GDS83355	Drive Shaft	36	23	59.5	40	799						
2.0 TDi (81 kW)	2009.04-	2012.11	AT	R	F	Hatchback Engine CFGB/CBBB	GDS54011	Drive Shaft	36		59.5	40	755						
	2009.04-	2012.11	MT	R	F	Hatchback Engine CFGB/CBBB	GDS61126	Drive Shaft	36		59.5	40	793						
	2008.10-	2012.11			F	Hatchback Engine CBDC/CLCA	GCI83011	Inner Joint		33		34							
	2008.10-	2012.11			F	Hatchback Engine CBDC/CLCA	GC083037	Outer Joint	36	30	59.5	40.5	55	I					
	2008.10-	2012.11	6AT		F	Hatchback Engine CBDC/CLCA	GCI54004	Inner Joint		34		85							
	2008.10-	2012.11	AT		F	Hatchback Engine CBDC/CLCA	GC083002	Outer Joint	36	27	59.5	40	66	I					
	2008.10-	2012.11	MT		F	Hatchback Engine CBDC/CLCA	GCI53002	Inner Joint		33		34							
	2008.10-	2012.11	AT	L	F	Hatchback Engine CBDC/CLCA	GDS54013	Drive Shaft	36		59.5	40	479.5						
	2008.10-	2012.11	MT	L	F	Hatchback Engine CBDC/CLCA	GDS83294	Drive Shaft	36		59.5	38	519						
	2008.10-	2012.11		L	F	Hatchback Engine CBDC/CLCA	GDS61089	Drive Shaft	36		59.5	40.5	521						
2.0 TDi 4motion (103 kW)	2008.10-	2012.11	AT	L/R	F	Hatchback Engine CBDC/CLCA	GCI61057	Inner Joint		34		86							
	2008.10-	2012.11	AT	R	F	Hatchback Engine CBDC/CLCA	GDS83355	Drive Shaft	36	23	59.5	40	799						
	2008.10-	2012.11	AT	R	F	Hatchback Engine CBDC/CLCA	GDS54011	Drive Shaft	36		59.5	40	755						
	2008.10-	2012.11	MT	R	F	Hatchback Engine CBDC/CLCA	GDS61042	Drive Shaft	36		59.5	40.5	814						
	2009.05-	2012.11			R	Hatchback Engine CFFB/CBAB	GCI83011	Inner Joint		33		34							
	2009.05-	2012.11	MT		R	Hatchback Engine CFFB/CBAB	GCI53002	Inner Joint		33		34							
	2009.05-	2012.11	MT	R		Hatchback Engine CFFB/CBAB	GCI83016	Inner Joint		28		32							
	2009.05-	2012.11	MT	L		Hatchback Engine CFFB/CBAB	GDS83295	Drive Shaft	36		59.5	40	491						
	2009.05-	2012.11	MT	R		Hatchback Engine CFFB/CBAB	GDS83266	Drive Shaft	36		59.5	40	601						
	2009.05-	2012.11			F	Hatchback Engine CFFB/CBAB	GC083002	Outer Joint	36	27	59.5	40	66	I					
	2009.05-	2012.11	AT	L	F	Hatchback Engine CFFB/CBAB	GDS83241	Drive Shaft	36		59.5	40	475						
	2009.05-	2012.11	MT	L	F	Hatchback Engine CFFB/CBAB	GDS83236	Drive Shaft	36		59.5	40	484						
	<b>GOLF VI (5K1, AJ5)</b>																		
	1.2 TSi (63 kW)	2009.05-		MT				GC083037	Outer Joint	36	30	59.5	40.5	55	I				
1.2 TSi (77 kW)	2009.05-		MT				GC083037	Outer Joint	36	30	59.5	40.5	55	I					
1.4 16V (59 kW)	2008.10-						GC053001	Outer Joint	36	30	59.5	40	49	I					
1.4 TSi (118 kW)	2008.10-		MT				GC083037	Outer Joint	36	30	59.5	40.5	55	I					
	2008.10-				Double Clutch		GC083002	Outer Joint	36	27	59.5	40	66	I					
1.4 TSi (90 kW)	2008.10-		MT				GC083037	Outer Joint	36	30	59.5	40.5	55	I					
	2008.10-				Double Clutch		GC083002	Outer Joint	36	27	59.5	40	66	I					
1.6 (75 kW)	2008.10-						GC083037	Outer Joint	36	30	59.5	40.5	55	I					
1.6 LPG (75 kW)	2008.10-						GC083037	Outer Joint	36	30	59.5	40.5	55	I					
1.6 TDi (66 kW)	2009.02-						GC083037	Outer Joint	36	30	59.5	40.5	55	I					
1.6 TDi (77 kW)	2009.02-						GC083037	Outer Joint	36	30	59.5	40.5	55	I					
1.6 TDi 4motion (77 kW)	2009.02-						GC083002	Outer Joint	36	27	59.5	40	66	I					
	2009.02-	2009.02					GCI83016	Inner Joint		28		32							
1.8 TSi (118 kW)	2008.10-		MT				GC083037	Outer Joint	36	30	59.5	40.5	55	I					
	2008.10-		MT/AT				GCI83016	Inner Joint		28		32							
2.0 16V (188 kW)	2009.11-						GCI83016	Inner Joint		28		32							
2.0 R 4motion (199 kW)	2010-						GCI83016	Inner Joint		28		32							
2.0 TDi (100 kW)	2008.10-		MT				GCI83016	Inner Joint		28		32							
	2008.10-		MT				GC083002	Outer Joint	36	27	59.5	40	66	I					
2.0 TDi (103 kW)	2008.10-		AT				GC083002	Outer Joint	36	27	59.5	40	66	I					
	2008.10-		MT				GCI83016	Inner Joint		28		32							
	2008.10-		MT				GC083002	Outer Joint	36	27	59.5	40	66	I					
2.0 TDi (125 kW)	2008.10-		MT				GCI83016	Inner Joint		28		32							
	2008.10-		MT				GC083002	Outer Joint	36	27	59.5	40	66	I					

		TRANSM	L/R	F/R		G-AP Ref.	PRODUCT	ABS	Technical Specifications								
									YEAR	A	B	C	H	L	P		
<b>VOLKSWAGEN</b>																	
<b>GOLF VI (5K1, AJ5)</b>																	
2.0 TDi (81 kW)	2008.10-					GC083002	Outer Joint		36	27	59.5	40	66	I			
	2008.10-		AT			GC083037	Outer Joint		36	30	59.5	40.5	55	I			
2.0 TDi 4motion (103 kW)	2008.10-					GCI83016	Inner Joint			28		32					
	2008.10-					GC083002	Outer Joint		36	27	59.5	40	66	I			
2.0 TSi (147 kW)	2008.10-					GCI83016	Inner Joint			28		32					
	2010.01-					GC083002	Outer Joint		36	27	59.5	40	66	I			
2.0 TSi (155 kW)	2008.10-					GCI83016	Inner Joint			28		32					
	2010.01-					GC083002	Outer Joint		36	27	59.5	40	66	I			
<b>GOLF VI CONVERTIBLE (517)</b>																	
1.2 TSi 16V (77 kW)	2013.11-				Convertible Engine CJZA	GC061059	Outer Joint		36	33	59.5	40	59.5	I			
<b>GOLF VI PLUS (5M1)</b>																	
1.2 TSi (77 kW)	2009.08-					GC083037	Outer Joint		36	30	59.5	40.5	55	I			
1.4 16V (59 kW)	2009.01-					GC053001	Outer Joint		36	30	59.5	40	49	I			
1.4 TSi (118 kW)	2009.01-					GC083037	Outer Joint		36	30	59.5	40.5	55	I			
	2009.01-					GCI83016	Inner Joint			28		32					
	2009.01-					GC083002	Outer Joint		36	27	59.5	40	66	I			
1.4 TSi (90 kW)	2009.01-					GC083037	Outer Joint		36	30	59.5	40.5	55	I			
	2009.01-		MT			GCI83016	Inner Joint			28		32					
	2009.01-					GC083002	Outer Joint		36	27	59.5	40	66	I			
1.6 (75 kW)	2009.01-					GC083037	Outer Joint		36	30	59.5	40.5	55	I			
1.6 LPG (75 kW)	2008.10-					GC083037	Outer Joint		36	30	59.5	40.5	55	I			
1.6 TDi (66 kW)	2009.02-					GC083037	Outer Joint		36	30	59.5	40.5	55	I			
1.6 TDi (77 kW)	2009.02-					GC083037	Outer Joint		36	30	59.5	40.5	55	I			
	2009.02-				Double Clutch	GC083002	Outer Joint		36	27	59.5	40	66	I			
	2009.02-					GCI83016	Inner Joint			28		32					
2.0 TDi (100 kW)	2009.01-					GC083002	Outer Joint		36	27	59.5	40	66	I			
	2009.01-					GCI83016	Inner Joint			28		32					
2.0 TDi (103 kW)	2009.01-					GC083002	Outer Joint		36	27	59.5	40	66	I			
2.0 TDi (81 kW)	2009.01-					GC083002	Outer Joint		36	27	59.5	40	66	I			
	2009.01-					GC083037	Outer Joint		36	30	59.5	40.5	55	I			
<b>GOLF VI VARIANT (AJ5)</b>																	
1.2 TSi (63 kW)	2010.07-				Estate Engine CBZA	GC083037	Outer Joint		36	30	59.5	40.5	55	I			
	2010.07-				Estate Engine CBZA	GCI53002	Inner Joint			33		34					
	2010.07-			L	F Estate Engine CBZA	GDS61201	Drive Shaft		36		59.5	40.5	535				
	2010.07-			L	F Estate Engine CBZA	GDS61198	Drive Shaft		36		59.5	40.5	530				
	2010.07-				Estate Engine CBZA	GC083100	Outer Joint		36	33	59.5	38	55	I			
1.2 TSi (77 kW)	2009.08-				Estate Engine CBZB	GC083037	Outer Joint		36	30	59.5	40.5	55	I			
	2009.08-				Estate Engine CBZB	GCI53002	Inner Joint			33		34					
	2009.08-			L	F Estate Engine CBZB	GDS61201	Drive Shaft		36		59.5	40.5	535				
	2009.08-			L	F Estate Engine CBZB	GDS61198	Drive Shaft		36		59.5	40.5	530				
	2009.08-				Estate Engine CBZB	GC083100	Outer Joint		36	33	59.5	38	55	I			
	2009.08-				Estate Engine CBZB	GC061059	Outer Joint		36	33	59.5	40	59.5	I			
1.4 (59 kW)	2009.07-				Estate Engine BUD/CGGA	GCI83008	Inner Joint			33		32					
	2009.07-				Estate Engine BUD/CGGA	GDS53007	Drive Shaft		36		59.5	40	559				
1.4 TSi (118 kW)	2009.07-				Estate Engine CAVD/CNWA/CTHD/CTKA	GC083037	Outer Joint		36	30	59.5	40.5	55	I			
	2009.07-				Estate Engine CAVD/CNWA/CTHD/CTKA	GCI53002	Inner Joint			33		34					
	2009.07-			L	F Estate Engine CAVD/CNWA/CTHD/CTKA	GDS61281	Drive Shaft		36		59.5	40	528				
	2009.07-			L	F Estate Engine CAVD/CNWA/CTHD/CTKA	GDS61201	Drive Shaft		36		59.5	40.5	535				
1.4 TSi (90 kW)	2009.07-				Estate Engine CAXA	GC083037	Outer Joint		36	30	59.5	40.5	55	I			
	2009.07-				Estate Engine CAXA	GCI53002	Inner Joint			33		34					
	2009.07-			L	F Estate Engine CAXA	GDS61281	Drive Shaft		36		59.5	40	528				
	2009.07-			L	F Estate Engine CAXA	GDS61198	Drive Shaft		36		59.5	40.5	530				
1.6 (75 kW)	2009.07-				Estate Engine BSE/BSF/CCSA/CMXA	GC083037	Outer Joint		36	30	59.5	40.5	55	I			
	2009.07-				Estate Engine BSE/BSF/CCSA/CMXA	GCI53002	Inner Joint			33		34					
	2009.07-			L	F Estate Engine BSE/BSF/CCSA/CMXA	GDS83320	Drive Shaft		36		59.5	40	546				
	2009.07-			L	F Estate Engine BSE/BSF/CCSA/CMXA	GDS61089	Drive Shaft		36		59.5	40.5	521				
1.6 TDi (66 kW)	2009.12-				Estate Engine CAYB	GC083037	Outer Joint		36	30	59.5	40.5	55	I			
	2009.12-				Estate Engine CAYB	GCI53002	Inner Joint			33		34					
	2009.12-			R	F Estate Engine CAYB	GDS61042	Drive Shaft		36		59.5	40.5	814				
	2009.12-			L	F Estate Engine CAYB	GDS83236	Drive Shaft		36		59.5	40	484				
	2009.12-			L	F Estate Engine CAYB	GDS61089	Drive Shaft		36		59.5	40.5	521				









		TRANSM	L/R	F/R		G-AP Ref.	PRODUCT	ABS	Technical Specifications						
									A	B	C	H	L	P	
YEAR															
<b>VOLKSWAGEN</b>															
<b>GOLF VI VARIANT (AJ5)</b>															
1.6 TDi (66 kW)	2009.12-				Estate Engine CAYB	GC083100	Outer Joint		36	33	59.5	38	55	I	
1.6 TDi (77 kW)	2009.07-		AT	R	F	Estate Engine CAYC	GDS61042	Drive Shaft	36		59.5	40.5	814		
	2009.07-		AT	L	F	Estate Engine CAYC	GDS83236	Drive Shaft	36		59.5	40	484		
	2009.07-		MT	L	F	Estate Engine CAYC	GDS61089	Drive Shaft	36		59.5	40.5	521		
	2009.07-		AT	R	F	Estate Engine CAYC	GDS61280	Drive Shaft	36		59.5	40	801		
	2009.07-		AT			Estate Engine CAYC	GC083100	Outer Joint	36	33	59.5	38	55	I	
1.6 TDi 4motion (77 kW)	2009.07-			L		Estate Engine CAYC	GDS83295	Drive Shaft	36		59.5	40	491		
	2009.07-			R		Estate Engine CAYC	GDS83266	Drive Shaft	36		59.5	40	601		
	2009.07-		MT		R	Estate Engine CAYC	GCI53002	Inner Joint		33		34			
	2009.07-			L	F	Estate Engine CAYC	GDS83236	Drive Shaft	36		59.5	40	484		
	2009.07-			R		Estate Engine CAYC	GCI83016	Inner Joint		28		32			
2.0 TDi (103 kW)	2009.07-			L	F	Estate Engine BMM	GDS83295	Drive Shaft	36		59.5	40	491		
2.0 TDi (81 kW)	2010.01-			L	F	Estate Engine CLCA	GDS83294	Drive Shaft	36		59.5	38	519		
	2010.01-			R	F	Estate Engine CLCA	GDS61042	Drive Shaft	36		59.5	40.5	814		
	2010.01-			L	F	Estate Engine CLCA	GDS61089	Drive Shaft	36		59.5	40.5	521		
2.0 TDi 16V (103 kW)	2009.07-			L	F	Estate Engine CBDB/CFHC/CJAA/CLCB	GDS83295	Drive Shaft	36		59.5	40	491		
	2009.07-		AT	L	F	Estate Engine CBDB/CFHC/CJAA/CLCB	GDS54013	Drive Shaft	36		59.5	40	479.5		
	2009.07-		AT	R	F	Estate Engine CBDB/CFHC/CJAA/CLCB	GDS54011	Drive Shaft	36		59.5	40	755		
	2009.07-		AT	L	F	Estate Engine CBDB/CFHC/CJAA/CLCB	GDS83241	Drive Shaft	36		59.5	40	475		
	2009.07-		MT	L	F	Estate Engine CBDB/CFHC/CJAA/CLCB	GDS83236	Drive Shaft	36		59.5	40	484		
	2009.07-		AT	L/R	F	Estate Engine CBDB/CFHC/CJAA/CLCB	GCI61057	Inner Joint		34		86			
	2009.07-		AT	R	F	Estate Engine CBDB/CFHC/CJAA/CLCB	GDS83355	Drive Shaft	36	23	59.5	40	799		
2009.07-		MT	R	F	Estate Engine CBDB/CFHC/CJAA/CLCB	GDS61126	Drive Shaft	36		59.5	40	793			
2.0 TSi (147 kW)	2009.07-		MT	R	F	Estate Engine CCZA	GDS61126	Drive Shaft	36		59.5	40	793		
<b>GOLF VII (5G1)</b>															
1.2 TSi (81 kW)	2014.04-				Hatchback Engine CYVB	GC061059	Outer Joint	36	33	59.5	40	59.5	I		
1.4 TGI (81 kW)	2013.06-		6MT		Hatchback Engine CPWA/CZBA	GC061059	Outer Joint	36	33	59.5	40	59.5	I		
1.4 TSi (103 kW)	2012.11-		MT	R	F	Hatchback Engine CHPA/CPTA	GDS61283	Drive Shaft	36		59.5	40	815		
	2012.11-		AT		F	Hatchback Engine CHPA/CPTA	GC083101	Outer Joint	36	27	59.5	40	65	M	
	2012.11-		MT			Hatchback Engine CHPA/CPTA	GC083100	Outer Joint	36	33	59.5	38	55	I	
1.4 TSi (110 kW)	2014.05-		AT	L	F	Hatchback Engine CHPB/CZDA/CZEA	GDS61304	Drive Shaft	36		59.5	40	511		
	2014.05-		AT	R	F	Hatchback Engine CHPB/CZDA/CZEA	GDS61303	Drive Shaft	36		59.5	40	795		
	2014.05-		MT			Hatchback Engine CHPB/CZDA/CZEA	GC083100	Outer Joint	36	33	59.5	38	55	I	
1.4 TSi (90 kW)	2012.11-		AT	L	F	Hatchback Engine CMBA/CPVA/CUKA/CXSA	GDS61201	Drive Shaft	36		59.5	40.5	535		
	2012.11-		MT/AT			Hatchback Engine CMBA/CPVA/CUKA/CXSA	GC083100	Outer Joint	36	33	59.5	38	55	I	
	2012.11-					Hatchback Engine CMBA/CPVA/CUKA/CXSA	GC061059	Outer Joint	36	33	59.5	40	59.5	I	
1.4 TSi MultiFuel (90 kW)	2013.04-		AT	L	F	Hatchback Engine CPVA	GDS61201	Drive Shaft	36		59.5	40.5	535		
	2013.04-		MT/AT			Hatchback Engine CPVA	GC083100	Outer Joint	36	33	59.5	38	55	I	
	2013.04-					Hatchback Engine CPVA	GC061059	Outer Joint	36	33	59.5	40	59.5	I	
1.6 TDi (66 kW)	2013.04-		MT	L	F	Hatchback Engine CLHB/CRKA	GDS61089	Drive Shaft	36		59.5	40.5	521		
	2013.04-					Hatchback Engine CLHB/CRKA	GC061059	Outer Joint	36	33	59.5	40	59.5	I	
1.6 TDi (81 kW)	2013.01-		MT	L	F	Hatchback Engine CRKB/CXXB	GDS61089	Drive Shaft	36		59.5	40.5	521		
	2013.01-		AT	R	F	Hatchback Engine CRKB/CXXB	GDS61280	Drive Shaft	36		59.5	40	801		
	2013.01-		AT			Hatchback Engine CRKB/CXXB	GC083100	Outer Joint	36	33	59.5	38	55	I	
	2013.01-					Hatchback Engine CRKB/CXXB	GC061059	Outer Joint	36	33	59.5	40	59.5	I	
1.6 TDi 4motion (81 kW)	2013.01-				Hatchback Engine CRKB/CXXB	GC061059	Outer Joint	36	33	59.5	40	59.5	I		
2.0 TDi (81 kW)	2012.11-		MT		Hatchback Engine CRVA	GC061059	Outer Joint	36	33	59.5	40	59.5	I		
<b>GOLF VII (5G1, BE1)</b>															
1.2 TSi (63 kW)	2012.08-			L	F	Hatchback Engine CJZB/CYVA	GDS83373	Drive Shaft	36		59.5	38	511		
1.2 TSi (77 kW)	2012.11-		AT	R	F	Hatchback Engine CJZA	GDS61199	Drive Shaft	36		59.5	40.5	800		
	2012.11-		AT			Hatchback Engine CJZA	GC083100	Outer Joint	36	33	59.5	38	55	I	
1.4 GTE HybriD (110 kW)	2014.05-		AT	L	F	Hatchback Engine CUKB	GDS61304	Drive Shaft	36		59.5	40	511		
	2014.05-		AT	R	F	Hatchback Engine CUKB	GDS61303	Drive Shaft	36		59.5	40	795		
	2014.05-		MT			Hatchback Engine CUKB	GC083100	Outer Joint	36	33	59.5	38	55	I	
1.6 TDi (77 kW)	2012.08-			L	F	Hatchback Engine CLHA	GDS61089	Drive Shaft	36		59.5	40.5	521		
	2012.08-		AT	R	F	Hatchback Engine CLHA	GDS61280	Drive Shaft	36		59.5	40	801		
	2012.08-		AT			Hatchback Engine CLHA	GC083100	Outer Joint	36	33	59.5	38	55	I	
1.6 TDi 4motion (77 kW)	2012.11-		MT		Hatchback Engine CLHA	GC083101	Outer Joint	36	27	59.5	40	65	M		
2.0 TDi (105 kW)	2012.08-			F	Hatchback Engine CRBB/CRVC	GC083101	Outer Joint	36	27	59.5	40	65	M		
2.0 TDi (110 kW)	2012.11-			F	Hatchback Engine CKFC/CRBCCRLB/CRMB	GC083101	Outer Joint	36	27	59.5	40	65	M		
2.0 TDi 4motion (110 kW)	2012.11-		MT	F	Hatchback Engine CKFC/CRBC	GC083101	Outer Joint	36	27	59.5	40	65	M		



		YEAR	TRANSM	L/R	F/R		G-AP Ref.	PRODUCT	ABS	Technical Specifications						
										A	B	C	H	L	P	
<b>VOLKSWAGEN</b>																
<b>GOLF VII (BA5)</b>																
1.2 TSi (77 kW)	2013.05-		AT	R	F	Estate Engine CJZA	GDS61199	Drive Shaft		36		59.5	40.5	800		
	2013.05-		AT			Estate Engine CJZA	GC083100	Outer Joint	36	33	59.5	38	55	I		
1.6 TDi (77 kW)	2013.05-		AT	R	F	Estate Engine CLHA	GDS61280	Drive Shaft	36		59.5	40	801			
	2013.05-		MT	R	F	Estate Engine CLHA	GDS61200	Drive Shaft	36		59.5	40.5	820			
	2013.05-		MT/AT			Estate Engine CLHA	GC083100	Outer Joint	36	33	59.5	38	55	I		
2.0 TDi (110 kW)	2013.04-		MT		F	Estate Engine CRBC/CRLB	GC083101	Outer Joint	36	27	59.5	40	65	M		
2.0 TDi 4motion (110 kW)	2013.04-		MT			Estate Engine CRBC/CRLB	GC083101	Outer Joint	36	27	59.5	40	65	M		
<b>GOLF VII KOMBI (BA5)</b>																
1.2 TSi (81 kW)	2014.04-					Estate Engine CYVB	GC061059	Outer Joint	36	33	59.5	40	59.5	I		
1.4 TGI (81 kW)	2013.09-		MT/6MT			Estate Engine CPWA	GC061059	Outer Joint	36	33	59.5	40	59.5	I		
1.4 TSi (103 kW)	2013.05-		AT	L	F	Estate Engine CHPA	GDS61304	Drive Shaft	36		59.5	40	511			
	2013.05-		AT	R	F	Estate Engine CHPA	GDS61303	Drive Shaft	36		59.5	40	795			
	2013.05-		MT	R	F	Estate Engine CHPA	GDS61283	Drive Shaft	36		59.5	40	815			
	2013.05-		AT			Estate Engine CHPA	GC083101	Outer Joint	36	27	59.5	40	65	M		
	2013.05-		MT			Estate Engine CHPA	GC083100	Outer Joint	36	33	59.5	38	55	I		
1.4 TSi (110 kW)	2014.05-		AT	L	F	Estate Engine CHPB/CZDA	GDS61304	Drive Shaft	36		59.5	40	511			
	2014.05-		AT	R	F	Estate Engine CHPB/CZDA	GDS61303	Drive Shaft	36		59.5	40	795			
	2014.05-		MT			Estate Engine CHPB/CZDA	GC083100	Outer Joint	36	33	59.5	38	55	I		
1.4 TSi (90 kW)	2013.05-		AT	L	F	Estate Engine CPVA/CXSA	GDS61201	Drive Shaft	36		59.5	40.5	535			
	2013.05-		AT			Estate Engine CPVA/CXSA	GC083100	Outer Joint	36	33	59.5	38	55	I		
	2013.05-					Estate Engine CPVA/CXSA	GC061059	Outer Joint	36	33	59.5	40	59.5	I		
1.6 TDi (66 kW)	2013.05-		MT	L	F	Estate Engine CLHB/CRKA	GDS61089	Drive Shaft	36		59.5	40.5	521			
	2013.05-					Estate Engine CLHB/CRKA	GC061059	Outer Joint	36	33	59.5	40	59.5	I		
1.6 TDi (81 kW)	2013.05-		AT	R	F	Estate Engine CRKB	GDS61280	Drive Shaft	36		59.5	40	801			
	2013.05-		MT/AT			Estate Engine CRKB	GC083100	Outer Joint	36	33	59.5	38	55	I		
	2013.05-					Estate Engine CRKB	GC061059	Outer Joint	36	33	59.5	40	59.5	I		
1.6 TDi 4motion (77 kW)	2013.05-					Estate Engine CLHA	GC061059	Outer Joint	36	33	59.5	40	59.5	I		
2.0 TDi (81 kW)	2013.05-		MT			Estate Engine CRVA	GC061059	Outer Joint	36	33	59.5	40	59.5	I		
<b>GOLF VII (5G1, BA5)</b>																
1.2 TSi (63 kW)	2012.08-		MT				GC083037	Outer Joint	36	30	59.5	40.5	55	I		
1.2 TSi (77 kW)	2012.08-		MT				GC083037	Outer Joint	36	30	59.5	40.5	55	I		
1.4 TSi (103 kW)	2012.11-					Double Clutc	GCI83016	Inner Joint		28		32				
1.6 TDi 4motion (77 kW)	2012.08-						GCI83016	Inner Joint		28		32				
1.6 TDi 4motion (81 kW)	2012.08-						GCI83016	Inner Joint		28		32				
2.0 GTD (135 kW)	2013.04-						GCI83016	Inner Joint		28		32				
2.0 TDi (110 kW)	2012.08-						GCI83016	Inner Joint		28		32				
2.0 TDi 4motion (110 kW)	2012.08-						GCI83016	Inner Joint		28		32				
<b>ILTIS (183)</b>																
1.6 TD (51 kW)	1987.08-	1988.12	MT		F	Open Off-Road Vehicle Engine 1C	GC083003	Outer Joint	26	28	56.5	84.5	66.5	O		
1.7 (55 kW)	1979.03-	1988.12	MT		F	Open Off-Road Vehicle Engine WL/YX	GC083003	Outer Joint	26	28	56.5	84.5	66.5	O		
<b>JETTA</b>																
1.8	2002-			L	F	Turbo Gas 5 Speed	GDS61060	Drive Shaft	36		53.2	77.5	520			
	2003-			L	F	5 Speed	GDS61060	Drive Shaft	36		53.2	77.5	520			
	2004-			L	F	5 Speed	GDS61060	Drive Shaft	36		53.2	77.5	520			
	2005-			L	F	(Vin "J" or "M" 8th Digit) 5 Speed	GDS61060	Drive Shaft	36		53.2	77.5	520			
1.9	2004-			L	F	SW w/Eng Code BEW	GDS61060	Drive Shaft	36		53.2	77.5	520			
	2005-			L	F	(Vin "J" or "M" 8th Digit) SW w/Eng Code BEW	GDS61060	Drive Shaft	36		53.2	77.5	520			
2.8	2004-			L	F	5 Speed	GDS61060	Drive Shaft	36		53.2	77.5	520			
	2005-			L	F	(Vin "J" or "M" 8th Digit) 5 Speed	GDS61060	Drive Shaft	36		53.2	77.5	520			
<b>JETTA (16)</b>																
1.1 (37 kW)	1978.08-	1984.02	MT		F	Saloon Engine FA/GG	GC061001	Outer Joint	22	30	50	77.5	51	O		
	1978.08-	1984.02	MT		F	Saloon Engine FA/GG	GC061013	Outer Joint	22	30	50	77.5	51	I		
	1978.08-	1984.02			F	Saloon Engine FA/GG	GC053006	Outer Joint	22	30	50	78.5	52	I		
1.3 (44 kW)	1979.08-	1984.02	MT		F	Saloon Engine GF	GC061001	Outer Joint	22	30	50	77.5	51	O		
	1979.08-	1984.02	MT		F	Saloon Engine GF	GC061013	Outer Joint	22	30	50	77.5	51	I		
	1979.08-	1984.02			F	Saloon Engine GF	GC053006	Outer Joint	22	30	50	78.5	52	I		
1.5 (51 kW)	1978.08-	1984.02	MT/AT		F	Saloon Engine JB	GC061013	Outer Joint	22	30	50	77.5	51	I		
	1978.08-	1984.02			F	Saloon Engine JB	GC053006	Outer Joint	22	30	50	78.5	52	I		
1.5 D (37 kW)	1978.08-	1980.07			F	Saloon Engine CK	GC061013	Outer Joint	22	30	50	77.5	51	I		
	1978.08-	1980.07			F	Saloon Engine CK	GC053006	Outer Joint	22	30	50	78.5	52	I		
1.6 (63 kW)	1978.08-	1984.02	MT/AT		F	Saloon Engine FR	GC061013	Outer Joint	22	30	50	77.5	51	I		

		TRANSM	L/R	F/R		G-AP Ref.	PRODUCT	ABS	Technical Specifications						
									YEAR	A	B	C	H	L	P
<b>VOLKSWAGEN</b>															
<b>JETTA (16)</b>															
1.6 D (40 kW)	1980.08-	1984.02	MT		F	Saloon Engine CR/JK	GC061013	Outer Joint	22	30	50	77.5	51	I	
	1980.08-	1984.02			F	Saloon Engine CR/JK	GC053006	Outer Joint	22	30	50	78.5	52	I	
1.6 GLI (81 kW)	1978.08-	1982.07	MT		F	Saloon Engine EG	GC061001	Outer Joint	22	30	50	77.5	51	O	
	1978.08-	1982.07	MT		F	Saloon Engine EG	GC061013	Outer Joint	22	30	50	77.5	51	I	
1.6 TD (51 kW)	1982.03-	1984.02	MT		F	Saloon Engine CY	GC061013	Outer Joint	22	30	50	77.5	51	I	
	1982.03-	1984.02			F	Saloon Engine CY	GC053006	Outer Joint	22	30	50	78.5	52	I	
1.8 (82 kW)	1982.08-	1984.02	MT		F	Saloon Engine DX	GC061013	Outer Joint	22	30	50	77.5	51	I	
<b>JETTA II (19E, 1G2, 165)</b>															
1.3 (40 kW)	1984.01-	1987.06	MT	R	F	Saloon Engine HK/MH	GDS61008	Drive Shaft	22		53	78.5	774		
<b>JETTA III (1K2)</b>															
1.4 TSi (103 kW)	2006.07-		MT				GC083037	Outer Joint	36	30	59.5	40.5	55	I	
	2006.07-						GC083002	Outer Joint	36	27	59.5	40	66	I	
	2007.01-	2008.01			F	Saloon Engine BMY	GC083037	Outer Joint	36	30	59.5	40.5	55	I	
	2007.01-	2008.01	AT		F	Saloon Engine BMY	GC083002	Outer Joint	36	27	59.5	40	66	I	
	2007.01-	2008.01	MT		F	Saloon Engine BMY	GCI83011	Inner Joint		33		34			
	2007.01-	2008.01	MT	L	F	Saloon Engine BMY	GDS61201	Drive Shaft	36		59.5	40.5	535		
	2007.01-	2008.01	MT	L	F	Saloon Engine BMY	GDS61224	Drive Shaft	36		59.5	40	536		
1.4 TSi (118 kW)	2006.07-		MT				GC083037	Outer Joint	36	30	59.5	40.5	55	I	
	2006.07-						GC083002	Outer Joint	36	27	59.5	40	66	I	
	2008.07-	2010.10	AT		F	Saloon Engine CAVD	GC083002	Outer Joint	36	27	59.5	40	66	I	
	2008.07-	2010.10	MT		F	Saloon Engine CAVD	GCI83011	Inner Joint		33		34			
	2008.07-	2010.10	MT		F	Saloon Engine CAVD	GC083037	Outer Joint	36	30	59.5	40.5	55	I	
	2008.07-	2010.10	MT	L	F	Saloon Engine CAVD	GDS61201	Drive Shaft	36		59.5	40.5	535		
	2008.07-	2010.10	MT	L	F	Saloon Engine CAVD	GDS61224	Drive Shaft	36		59.5	40	536		
1.4 TSi (125 kW)	2006.07-						GC083002	Outer Joint	36	27	59.5	40	66	I	
	2007.01-	2008.01	6MT		F	Saloon Engine BLG	GC083002	Outer Joint	36	27	59.5	40	66	I	
	2007.01-	2008.01	MT	L	F	Saloon Engine BLG	GDS83302	Drive Shaft	36		59.5	40	528		
1.4 TSi (90 kW)	2006.07-		MT				GC083037	Outer Joint	36	30	59.5	40.5	55	I	
	2007.09-	2010.10			F	Saloon Engine CAXA	GC083037	Outer Joint	36	30	59.5	40.5	55	I	
	2007.09-	2010.10	MT		F	Saloon Engine CAXA	GCI83011	Inner Joint		33		34			
	2007.09-	2010.10	Semi-AT		F	Saloon Engine CAXA	GC083002	Outer Joint	36	27	59.5	40	66	I	
	2007.09-	2010.10	MT	L	F	Saloon Engine CAXA	GDS61198	Drive Shaft	36		59.5	40.5	530		
1.6 (75 kW)	2005.10-	2010.10			F	Saloon Engine BSE/BSF/CCSA	GC083037	Outer Joint	36	30	59.5	40.5	55	I	
	2005.10-	2010.10	6AT		F	Saloon Engine BSE/BSF/CCSA	GCI61011	Inner Joint	26	32	31	68.5	85		
	2005.10-	2010.10	MT		F	Saloon Engine BSE/BSF/CCSA	GCI83011	Inner Joint		33		34			
	2005.10-	2010.10	6AT	L	F	Saloon Engine BSE/BSF/CCSA	GDS61093	Drive Shaft	36	26	59.5	40.5	587.5		
	2005.10-	2010.10	MT	L	F	Saloon Engine BSE/BSF/CCSA	GDS83320	Drive Shaft	36		59.5	40	546		
	2005.10-	2010.10	6AT	R	F	Saloon Engine BSE/BSF/CCSA	GDS83346	Drive Shaft	36	26	59.5	38	879		
	2005.10-	2010.10	6AT	R	F	Saloon Engine BSE/BSF/CCSA	GCI61011	Inner Joint	26	32	31	68.5	85		
	2005.10-	2010.10	6AT	R	F	Saloon Engine BSE/BSF/CCSA	GC083116	Outer Joint	36	30	59.5	38	55	I	
	2005.10-	2010.10	6AT	R	F	Saloon Engine BSE/BSF/CCSA	GDS61094	Drive Shaft	36	26	59.5	40.5	884		
	2005.10-						GC083037	Outer Joint	36	30	59.5	40.5	55	I	
1.6 FSi (85 kW)	2005.09-						GC083037	Outer Joint	36	30	59.5	40.5	55	I	
	2005.11-	2007.12			F	Saloon Engine BLF	GC083037	Outer Joint	36	30	59.5	40.5	55	I	
	2005.11-	2007.12	MT		F	Saloon Engine BLF	GCI83011	Inner Joint		33		34			
	2005.11-	2007.12	6MT	L	F	Saloon Engine BLF	GDS83319	Drive Shaft	36		59.5	38	557		
	2005.11-	2007.12	6MT	R	F	Saloon Engine BLF	GDS61211	Drive Shaft	36		59.5	40.5	784		
1.6 TDi (66 kW)	2009.12-	2010.10			R	F	Saloon Engine CAYB	GDS61042	Drive Shaft	36		59.5	40.5	814	
1.6 TDi (77 kW)	2009.06-	2010.10	MT		F	Saloon Engine CAYC	GC083037	Outer Joint	36	30	59.5	40.5	55	I	
	2009.06-	2010.10	MT	R	F	Saloon Engine CAYC	GDS61042	Drive Shaft	36		59.5	40.5	814		
	2009.06-		MT				GC083037	Outer Joint	36	30	59.5	40.5	55	I	
	2009.06-						GC083002	Outer Joint	36	27	59.5	40	66	I	
1.9 TDi (77 kW)	2005.08-	2010.10			F	Saloon Engine BKC/BLS/BXE	GC083037	Outer Joint	36	30	59.5	40.5	55	I	
	2005.08-	2010.10	6AT		F	Saloon Engine BKC/BLS/BXE	GC083002	Outer Joint	36	27	59.5	40	66	I	
	2005.08-	2010.10	6AT		F	Saloon Engine BKC/BLS/BXE	GCI54004	Inner Joint		34		85			
	2005.08-	2010.10	MT		F	Saloon Engine BKC/BLS/BXE	GCI83011	Inner Joint		33		34			
	2005.08-	2010.10	6AT	L	F	Saloon Engine BKC/BLS/BXE	GDS54013	Drive Shaft	36		59.5	40	479.5		
	2005.08-	2010.10	AT	L	F	Saloon Engine BKC/BLS/BXE	GDS83241	Drive Shaft	36		59.5	40	475		
	2005.08-	2010.10	MT	L	F	Saloon Engine BKC/BLS/BXE	GDS61089	Drive Shaft	36		59.5	40.5	521		
	2005.08-	2010.10	MT	L	F	Saloon Engine BKC/BLS/BXE	GDS83294	Drive Shaft	36		59.5	38	519		
	2005.08-	2010.10	6AT	L/R	F	Saloon Engine BKC/BLS/BXE	GCI61057	Inner Joint		34		86			
	2005.08-	2010.10	6AT	R	F	Saloon Engine BKC/BLS/BXE	GDS54011	Drive Shaft	36		59.5	40	755		









		TRANSM	L/R	F/R		G-AP Ref.	PRODUCT	ABS	Technical Specifications										
									YEAR	A	B	C	H	L	P				
<b>VOLKSWAGEN</b>																			
<b>JETTA III (1K2)</b>																			
1.9 TDi (77 kW)	2005.08-	2010.10	AT	R	F	Saloon Engine BKC/BLS/BXE	GDS83355	Drive Shaft	36	23	59.5	40	799						
	2005.08-	2010.10	MT	R	F	Saloon Engine BKC/BLS/BXE	GDS61042	Drive Shaft	36		59.5	40.5	814						
	2005.08-						GC083037	Outer Joint	36	30	59.5	40.5	55	I					
2.0 FSi (110 kW)	2005.08-	2010.10	6AT		F	Saloon Engine BLR/BLY/BVY/BVZ	GCI61011	Inner Joint	26	32	31	68.5	85						
	2005.08-	2010.10	MT		F	Saloon Engine BLR/BLY/BVY/BVZ	GCI83011	Inner Joint		33		34							
	2005.08-	2010.10	MT		F	Saloon Engine BLR/BLY/BVY/BVZ	GC083037	Outer Joint	36	30	59.5	40.5	55	I					
	2005.08-	2010.10	6AT	L	F	Saloon Engine BLR/BLY/BVY/BVZ	GDS61093	Drive Shaft	36	26	59.5	40.5	587.5						
	2005.08-	2010.10	MT	L	F	Saloon Engine BLR/BLY/BVY/BVZ	GDS61089	Drive Shaft	36		59.5	40.5	521						
	2005.08-	2010.10	6AT	R	F	Saloon Engine BLR/BLY/BVY/BVZ	GDS61094	Drive Shaft	36	26	59.5	40.5	884						
	2005.08-		MT				GC083037	Outer Joint	36	30	59.5	40.5	55	I					
	2005.08-		MT				GC083002	Outer Joint	36	27	59.5	40	66	I					
2.0 TDi (100 kW)	2007.03-	2008.01	AT	R	F	Saloon Engine AZV/CBDA	GDS54011	Drive Shaft	36		59.5	40	755						
	2007.03-	2008.01	MT	R	F	Saloon Engine AZV/CBDA	GDS61126	Drive Shaft	36		59.5	40	793						
	2007.03-	2008.01	MT	R	F	Saloon Engine AZV/CBDA	GDS83313	Drive Shaft	36		59.5	40	792						
	2007.03-	2008.01	6MT/6AT		F	Saloon Engine AZV/CBDA	GC083002	Outer Joint	36	27	59.5	40	66	I					
	2007.03-	2008.01		L	F	Saloon Engine AZV/CBDA	GDS83295	Drive Shaft	36		59.5	40	491						
	2007.03-	2008.01	AT	L	F	Saloon Engine AZV/CBDA	GDS83241	Drive Shaft	36		59.5	40	475						
	2007.03-	2008.01	AT	L	F	Saloon Engine AZV/CBDA	GDS54013	Drive Shaft	36		59.5	40	479.5						
	2007.03-	2008.01	MT	L	F	Saloon Engine AZV/CBDA	GDS83236	Drive Shaft	36		59.5	40	484						
	2007.03-	2008.01	AT	L/R	F	Saloon Engine AZV/CBDA	GCI61057	Inner Joint		34		86							
	2007.03-	2008.01	AT	R	F	Saloon Engine AZV/CBDA	GDS83355	Drive Shaft	36	23	59.5	40	799						
2.0 TDi (103 kW)	2005.09-		MT				GCI83016	Inner Joint		28		32							
	2005.09-		MT				GC083037	Outer Joint	36	30	59.5	40.5	55	I					
	2005.09-		MT				GC083002	Outer Joint	36	27	59.5	40	66	I					
	2005.11-	2008.01			F	Saloon Engine BMM	GC083037	Outer Joint	36	30	59.5	40.5	55	I					
	2005.11-	2008.01	6MT/6AT		F	Saloon Engine BMM	GC083002	Outer Joint	36	27	59.5	40	66	I					
	2005.11-	2008.01		L	F	Saloon Engine BMM	GDS83295	Drive Shaft	36		59.5	40	491						
	2005.11-	2008.01	AT	L	F	Saloon Engine BMM	GDS83241	Drive Shaft	36		59.5	40	475						
	2005.11-	2008.01	AT	L	F	Saloon Engine BMM	GDS54013	Drive Shaft	36		59.5	40	479.5						
	2005.11-	2008.01	MT	L	F	Saloon Engine BMM	GDS83236	Drive Shaft	36		59.5	40	484						
	2005.11-	2008.01	AT	L/R	F	Saloon Engine BMM	GCI61057	Inner Joint		34		86							
	2005.11-	2008.01	AT	R	F	Saloon Engine BMM	GDS83355	Drive Shaft	36	23	59.5	40	799						
	2005.11-	2008.01	AT	R	F	Saloon Engine BMM	GDS54011	Drive Shaft	36		59.5	40	755						
	2005.11-	2008.01	MT	R	F	Saloon Engine BMM	GDS61126	Drive Shaft	36		59.5	40	793						
	2.0 TDi (125 kW)	2007.12-	2010.10		L	F	Saloon Engine BMN/CEGA	GDS83236	Drive Shaft	36		59.5	40	484					
		2007.12-	2010.10	MT	R	F	Saloon Engine BMN/CEGA	GDS61126	Drive Shaft	36		59.5	40	793					
2.0 TDi 16V (103 kW)	2005.08-	2010.10			F	Saloon Engine BKD/CBDB/CJAA	GC083037	Outer Joint	36	30	59.5	40.5	55	I					
	2005.08-	2010.10	6MT/6AT		F	Saloon Engine BKD/CBDB/CJAA	GC083002	Outer Joint	36	27	59.5	40	66	I					
	2005.08-	2010.10		L	F	Saloon Engine BKD/CBDB/CJAA	GDS83295	Drive Shaft	36		59.5	40	491						
	2005.08-	2010.10	AT	L	F	Saloon Engine BKD/CBDB/CJAA	GDS83241	Drive Shaft	36		59.5	40	475						
	2005.08-	2010.10	AT	L	F	Saloon Engine BKD/CBDB/CJAA	GDS54013	Drive Shaft	36		59.5	40	479.5						
	2005.08-	2010.10	MT	L	F	Saloon Engine BKD/CBDB/CJAA	GDS83236	Drive Shaft	36		59.5	40	484						
	2005.08-	2010.10	AT	L/R	F	Saloon Engine BKD/CBDB/CJAA	GCI61057	Inner Joint		34		86							
	2005.08-	2010.10	AT	R	F	Saloon Engine BKD/CBDB/CJAA	GDS83355	Drive Shaft	36	23	59.5	40	799						
	2005.08-	2010.10	AT	R	F	Saloon Engine BKD/CBDB/CJAA	GDS54011	Drive Shaft	36		59.5	40	755						
	2005.08-	2010.10	MT	R	F	Saloon Engine BKD/CBDB/CJAA	GDS61126	Drive Shaft	36		59.5	40	793						
2.0 TFSi (147 kW)	2005.08-						GC083002	Outer Joint	36	27	59.5	40	66	I					
	2005.11-	2008.01	6MT/6AT		F	Saloon Engine BPY/BWA/CAWB/CBFA/CCTA/CCZA	GC083002	Outer Joint	36	27	59.5	40	66	I					
	2005.11-	2008.01		L	F	Saloon Engine BPY/BWA/CAWB/CBFA/CCTA/CCZA	GDS83295	Drive Shaft	36		59.5	40	491						
	2005.11-	2008.01	MT	L	F	Saloon Engine BPY/BWA/CAWB/CBFA/CCTA/CCZA	GDS83236	Drive Shaft	36		59.5	40	484						
	2005.11-	2008.01	AT	R	F	Saloon Engine BPY/BWA/CAWB/CBFA/CCTA/CCZA	GDS83349	Drive Shaft	36		59.5	40	784						
	2005.11-	2008.01	MT	R	F	Saloon Engine BPY/BWA/CAWB/CBFA/CCTA/CCZA	GDS61126	Drive Shaft	36		59.5	40	793						
2.5 FSi (110 kW)	2006.01-	2010.10	MT		F	Saloon Engine BTK	GCI83011	Inner Joint		33		34							
<b>JETTA IV (162)</b>																			
1.2 TSi (77 kW)	2011-		MT				GC083037	Outer Joint	36	30	59.5	40.5	55	I					
	2011-						GC083002	Outer Joint	36	27	59.5	40	66	I					
	2011.02-		MT	L	F	Saloon Engine CBZB	GDS61198	Drive Shaft	36		59.5	40.5	530						
1.4 TSi (110 kW)	2011-		MT				GC083037	Outer Joint	36	30	59.5	40.5	55	I					
	2011-						GC083002	Outer Joint	36	27	59.5	40	66	I					
1.4 TSi (118 kW)	2011-		MT				GC083037	Outer Joint	36	30	59.5	40.5	55	I					



		TRANSM	L/R	F/R		G-AP Ref.	PRODUCT	ABS	Technical Specifications								
									YEAR	A	B	C	H	L	P		
<b>VOLKSWAGEN</b>																	
<b>JETTA IV (162)</b>																	
1.4 TSi (118 kW)	2011-					GC083002	Outer Joint		36	27	59.5	40	66	I			
1.4 TSi (90 kW)	2011-		MT			GC083037	Outer Joint		36	30	59.5	40.5	55	I			
	2011-					GC083002	Outer Joint		36	27	59.5	40	66	I			
1.6 (77 kW)	2011.05-		MT	L	F	Saloon Engine CAXA/CMSB	GDS61198	Drive Shaft	36		59.5	40.5	530				
	2011.12-		MT	L	F	Saloon Engine CFNA/CLRA	GDS83319	Drive Shaft	36		59.5	38	557				
1.6 TDi (77 kW)	2011.12-		MT	R	F	Saloon Engine CFNA/CLRA	GDS61211	Drive Shaft	36		59.5	40.5	784				
	2011-		MT			Double Clutch	GCI83016	Inner Joint		28		32					
1.6 TDi (77 kW)	2011-						GC083037	Outer Joint	36	30	59.5	40.5	55	I			
	2011-						GC083002	Outer Joint	36	27	59.5	40	66	I			
2.0 (85 kW)	2011.02-		MT	R	F	Saloon Engine CAYC	GDS61042	Drive Shaft	36		59.5	40.5	814				
	2010-		MT/AT				GC083037	Outer Joint	36	30	59.5	40.5	55	I			
2.0 TDi (103 kW)	2011-		MT				GCI83016	Inner Joint		28		32					
	2011-		MT				GC083002	Outer Joint	36	27	59.5	40	66	I			
2.0 TDi (81 kW)	2011.02-		AT	L	F	Saloon Engine CFFB/CFHC/CJAA/CLCB	GDS83241	Drive Shaft	36		59.5	40	475				
	2010-		MT				GC083037	Outer Joint	36	30	59.5	40.5	55	I			
2.0 TSi (147 kW)	2010.10-			R	F	Saloon Engine CLCA	GDS61042	Drive Shaft	36		59.5	40.5	814				
	2011-		MT			Double Clutch	GCI83016	Inner Joint		28		32					
2.5 FSi (125 kW)	2011-		MT				GC083002	Outer Joint	36	27	59.5	40	66	I			
	2010-		AT				GC083002	Outer Joint	36	27	59.5	40	66	I			
2.5 FSi (125 kW)	2010-		MT				GC083037	Outer Joint	36	30	59.5	40.5	55	I			
	2010-		MT				GC083037	Outer Joint	36	30	59.5	40.5	55	I			
<b>KAEFER</b>																	
-	1970-	1974			L/R		GDS61031	Drive Shaft					32	416.5			
<b>KOMBI</b>																	
1.6	1998.01-	2006.12	MT				GCI61013	Inner Joint		33		32					
<b>LOAD UP</b>																	
1.0 (44 kW)	12.2014-		MT	L/R	F	Box Engine CHYA	GC050170	Outer Joint	22	26	46	78	53	M			
1.0 EcoFuel (50 kW)	12.2014-		MT	L/R	F	Box Engine CPGA	GC050170	Outer Joint	22	26	46	78	53	M			
<b>LOGUS</b>																	
1.6	1993.01-	1996.12	MT				GC099154	Outer Joint	25	30	56.5	89	52	I			
1.8	1993.01-	1996.12	MT				GC018100	Outer Joint	25	30	56.5	89	56.5	I			
2	1993.01-	1996.12	MT				GC018100	Outer Joint	25	30	56.5	89	56.5	I			
<b>LUPO (6X1, 6E1)</b>																	
1.0 (37 kW)	1998.09-	2005.07	MT		F	Hatchback Engine AER/ALD/ALL/ANV/AUC	GC053005	Outer Joint	22	30	53	78.5	51	I			
1.2 TDi (45 kW)	1999.07-	2005.07			F	Hatchback Engine ANY/AYZ	GC099268	Outer Joint	20	26	43	56	45	M			
1.2 TDi 3L (45 kW)	1999.07-	2005.07					GC099268	Outer Joint	20	26	43	56	45	M			
1.4 (44 kW)	2000.10-	2005.07	MT/AT		F	Hatchback Engine AUD	GC053005	Outer Joint	22	30	53	78.5	51	I			
1.4 16V (55 kW)	1998.09-	2005.07	MT/AT		F	Hatchback Engine AHW/AKQ/APE/AUA/BBY	GC053005	Outer Joint	22	30	53	78.5	51	I			
1.4 16V (74 kW)	1999.08-	2005.07	MT/AT		F	Hatchback Engine AFK/AQQ/AUB	GC053005	Outer Joint	22	30	53	78.5	51	I			
	1999.08-	2005.07	MT	L	F	Hatchback Engine AFK/AQQ/AUB	GDS61205	Drive Shaft	22		53	78.5	525				
1.4 FSi (77 kW)	2001.02-	2005.07	MT/AT		F	Hatchback Engine ARR	GC053005	Outer Joint	22	30	53	78.5	51	I			
	2001.02-	2005.07	MT	L	F	Hatchback Engine ARR	GDS61205	Drive Shaft	22		53	78.5	525				
1.4 TDi (55 kW)	1999.01-	2005.07	5MT		F	Hatchback Engine AMF	GC061007	Outer Joint	22	30	53	78.5	60	I			
	1999.01-	2005.07	MT		F	Hatchback Engine AMF	GCI61006	Inner Joint		30		57.6					
	1999.01-	2005.07	5MT	L	F	Hatchback Engine AMF	GDS61075	Drive Shaft	22		53	78.5	525				
	1999.01-	2005.07	5MT	R	F	Hatchback Engine AMF	GDS61074	Drive Shaft	22		53	78.5	712				
	1999.01-	2005.07					GC061007	Outer Joint	22	30	53	78.5	60	I			
1.6 GTi (92 kW)	2000.09-	2005.07			F	Hatchback Engine AVY	GC061007	Outer Joint	22	30	53	78.5	60	I			
	2000.09-	2005.07					GC061007	Outer Joint	22	30	53	78.5	60	I			
1.7 SDi (44 kW)	1998.09-	2005.07	MT/AT		F	Hatchback Engine AKU	GC053005	Outer Joint	22	30	53	78.5	51	I			
<b>MAGGIOLINO (5CI, 5C7)</b>																	
1.2 TSi (77 kW)	2011.07-						GC083037	Outer Joint	36	30	59.5	40.5	55	I			
1.4 TSi (118 kW)	2011.04-		MT				GC083037	Outer Joint	36	30	59.5	40.5	55	I			
1.6 TDi (77 kW)	2011.10-		MT				GC083037	Outer Joint	36	30	59.5	40.5	55	I			
2.5 (125 kW)	2011.04-		MT				GC083037	Outer Joint	36	30	59.5	40.5	55	I			
<b>MULTIVAN MK V (7HM, 7HN, 7HF, 7EF, 7EM, 7EN)</b>																	
3.2 4motion (170 kW)	2003.11-	2006.06	5MT			MPV Engine BDL	GDS61190	Stub Shaft	26	37	50		136.5				
	2003.11-	2006.06	6MT			MPV Engine BDL	GDS61191	Stub Shaft	26	42	60		135.5				
<b>MULTIVAN V (7HM, 7HN, 7HF, 7EF, 7EM, 7EN)</b>																	
1.9 TDi (62 kW)	2006.01-	2009.11	5MT		F	MPV Engine BRR	GDS61190	Stub Shaft	26	37	50		136.5				
	2006.01-	2009.11		L	F	MPV Engine BRR	GDS61105	Drive Shaft	38		63	102.5	645				
	2006.01-	2009.11		R	F	MPV Engine BRR	GDS83246	Drive Shaft	38	26	63	102.5	858				

		TRANSM	L/R	F/R		G-AP Ref.	PRODUCT	ABS	Technical Specifications												
									YEAR	A	B	C	H	L	P						
<b>VOLKSWAGEN</b>																					
<b>MULTIVAN V (7HM, 7HN, 7HF, 7EF, 7EM, 7EN)</b>																					
1.9 TDi (62 kW)	2006.01-	2009.11	AT	R	F	MPV Engine BRR	GDS83267	Drive Shaft	38	26	63	102.5	925								
	2006.01-	2009.11	6MT		F	MPV Engine BRR	GDS61191	Stub Shaft	26	42	60		135.5								
1.9 TDi (63 kW)	2003.04-	2009.11	6MT		F	MPV Engine AXC	GDS61191	Stub Shaft	26	42	60		135.5								
	2003.04-	2009.11	AT	R	F	MPV Engine AXC	GDS83267	Drive Shaft	38	26	63	102.5	925								
	2003.04-	2009.11	5MT		F	MPV Engine AXC	GDS61190	Stub Shaft	26	37	50		136.5								
1.9 TDi (75 kW)	2006.06-	2009.11	6MT		F	MPV Engine BRS	GDS61191	Stub Shaft	26	42	60		135.5								
	2006.06-	2009.11	MT		F	MPV Engine BRS	GCI61020	Inner Joint	26	28	50	205.5	63								
	2006.06-	2009.11	MT		F	MPV Engine BRS	GCI61041	Inner Joint		28		32									
	2006.06-	2009.11		L	F	MPV Engine BRS	GDS61105	Drive Shaft	38		63	102.5	645								
	2006.06-	2009.11		R	F	MPV Engine BRS	GDS83246	Drive Shaft	38	26	63	102.5	858								
	2006.06-	2009.11	AT	R	F	MPV Engine BRS	GDS83267	Drive Shaft	38	26	63	102.5	925								
	2006.06-	2009.11	5MT		F	MPV Engine BRS	GDS61190	Stub Shaft	26	37	50		136.5								
1.9 TDi (77 kW)	2003.04-	2009.11	6MT		F	MPV Engine AXB	GDS61191	Stub Shaft	26	42	60		135.5								
	2003.04-	2009.11			F	MPV Engine AXB	GC061009	Outer Joint	38	27	63	102	66	M							
	2003.04-	2009.11	MT		F	MPV Engine AXB	GCI61020	Inner Joint	26	28	50	205.5	63								
	2003.04-	2009.11	MT		F	MPV Engine AXB	GCI61041	Inner Joint		28		32									
	2003.04-	2009.11	5MT	L	F	MPV Engine AXB	GDS61105	Drive Shaft	38		63	102.5	645								
	2003.04-	2009.11	5MT	R	F	MPV Engine AXB	GDS83246	Drive Shaft	38	26	63	102.5	858								
	2003.04-	2009.11	AT	R	F	MPV Engine AXB	GDS83267	Drive Shaft	38	26	63	102.5	925								
2.0 (85 kW)	2003.04-	2009.11	5MT		F	MPV Engine AXB	GDS61190	Stub Shaft	26	37	50		136.5								
	2003.11-		6MT		F	MPV Engine AXA	GDS61191	Stub Shaft	26	42	60		135.5								
	2003.11-				F	MPV Engine AXA	GC061009	Outer Joint	38	27	63	102	66	M							
	2003.11-		MT		F	MPV Engine AXA	GCI61020	Inner Joint	26	28	50	205.5	63								
	2003.11-		MT		F	MPV Engine AXA	GCI61041	Inner Joint		28		32									
	2003.11-		5MT	L	F	MPV Engine AXA	GDS61105	Drive Shaft	38		63	102.5	645								
	2003.11-		5MT	R	F	MPV Engine AXA	GDS83246	Drive Shaft	38	26	63	102.5	858								
2.0 BitDi (132 kW)	2003.11-		5MT		F	MPV Engine AXA	GDS61190	Stub Shaft	26	37	50		136.5								
	2009.09-		5MT		F	MPV Engine CFCA	GDS61190	Stub Shaft	26	37	50		136.5								
	2009.09-		AT		F	MPV Engine CFCA	GC061011	Outer Joint	38	29	63	102.5	70	M							
	2009.09-		AT	L	F	MPV Engine CFCA	GDS83293	Drive Shaft	38	37	63	102.5	645								
	2009.09-		6MT		F	MPV Engine CFCA	GDS61191	Stub Shaft	26	42	60		135.5								
	2.0 BitDi 4motion (132 kW)	2009.09-		5MT		MPV Engine CFCA	GDS61190	Stub Shaft	26	37	50		136.5								
	2009.09-				MPV Engine CFCA	GC061011	Outer Joint	38	29	63	102.5	70	M								
2.0 TDi (100 kW)	2009.09-		6MT		MPV Engine CFCA	GDS61191	Stub Shaft	26	42	60		135.5									
	2010.05-		AT	L	F	MPV Engine CAAE/CCHB	GDS83293	Drive Shaft	38	37	63	102.5	645								
	2010.05-		5MT		F	MPV Engine CAAE/CCHB	GDS61190	Stub Shaft	26	37	50		136.5								
	2010.05-		6MT		F	MPV Engine CAAE/CCHB	GDS61191	Stub Shaft	26	42	60		135.5								
2.0 TDi (103 kW)	2009.09-		5MT		F	MPV Engine CAAC/CCHA	GDS61190	Stub Shaft	26	37	50		136.5								
	2009.09-		6MT		F	MPV Engine CAAC/CCHA	GDS61191	Stub Shaft	26	42	60		135.5								
	2009.09-		AT		F	MPV Engine CAAC/CCHA	GC061011	Outer Joint	38	29	63	102.5	70	M							
	2009.09-		AT	L	F	MPV Engine CAAC/CCHA	GDS83293	Drive Shaft	38	37	63	102.5	645								
	2009.09-		MT	R	F	MPV Engine CAAC/CCHA	GDS83261	Drive Shaft	38	26	63	102	857								
2.0 TDi (62 kW)	2009.09-		5MT		F	MPV Engine CAAA	GDS61190	Stub Shaft	26	37	50		136.5								
	2009.09-		6MT		F	MPV Engine CAAA	GDS61191	Stub Shaft	26	42	60		135.5								
	2009.09-		5MT	R	F	MPV Engine CAAA	GDS83261	Drive Shaft	38	26	63	102	857								
2.0 TDi (75 kW)	2009.09-		5MT		F	MPV Engine CAAB	GDS61190	Stub Shaft	26	37	50		136.5								
	2009.09-		6MT		F	MPV Engine CAAB	GDS61191	Stub Shaft	26	42	60		135.5								
	2009.09-		5MT	R	F	MPV Engine CAAB	GDS83261	Drive Shaft	38	26	63	102	857								
2.0 TDi (84 kW)	2011.05-		6MT		F	MPV Engine CAAD	GDS61191	Stub Shaft	26	42	60		135.5								
	2011.05-		5MT		F	MPV Engine CAAD	GDS61190	Stub Shaft	26	37	50		136.5								
2.0 TDi 4motion (100 kW)	2010.05-		5MT		MPV Engine CAAE/CCHB	GDS61190	Stub Shaft	26	37	50		136.5									
	2010.05-		6MT		MPV Engine CAAE/CCHB	GDS61191	Stub Shaft	26	42	60		135.5									
2.0 TDi 4motion (103 kW)	2009.09-		5MT		MPV Engine CAAC/CCHA	GDS61190	Stub Shaft	26	37	50		136.5									
	2009.09-		6MT		MPV Engine CAAC/CCHA	GDS61191	Stub Shaft	26	42	60		135.5									
	2009.09-				MPV Engine CAAC/CCHA	GC061011	Outer Joint	38	29	63	102.5	70	M								
2.0 TSi (110 kW)	2012.07-		5MT		F	MPV Engine CJKB	GDS61190	Stub Shaft	26	37	50		136.5								
	2012.07-		6MT		F	MPV Engine CJKB	GDS61191	Stub Shaft	26	42	60		135.5								
2.0 TSi (150 kW)	2011.05-		6MT		F	MPV Engine CJKA	GDS61191	Stub Shaft	26	42	60		135.5								
	2011.05-		5MT		F	MPV Engine CJKA	GDS61190	Stub Shaft	26	37	50		136.5								
2.0 TSi 4motion (150 kW)	2011.07-		6MT		MPV Engine CJKA	GDS61191	Stub Shaft	26	42	60		135.5									
	2011.07-		AT	L	F	MPV Engine CJKA	GDS83293	Drive Shaft	38	37	63	102.5	645								









		YEAR	TRANSM	L/R	F/R		G-AP Ref.	PRODUCT	ABS	Technical Specifications						
										A	B	C	H	L	P	
<b>VOLKSWAGEN</b>																
<b>MULTIVAN V (7HM, 7HN, 7HF, 7EF, 7EM, 7EN)</b>																
2.0 TSi 4motion (150 kW)	2011.07-		5MT			MPV Engine CJKA	GDS61190	Stub Shaft		26	37	50		136.5		
2.5 TDi (120 kW)	2003.11-	2009.11	5MT		F	MPV Engine BLJ	GDS61190	Stub Shaft		26	37	50		136.5		
	2003.11-	2009.11	6MT		F	MPV Engine BLJ	GDS61191	Stub Shaft		26	42	60		135.5		
	2003.11-	2009.11	MT		F	MPV Engine BLJ	GCI61021	Inner Joint		26	30	50	288	78		
	2003.11-	2009.11	MT		F	MPV Engine BLJ	GCI61029	Inner Joint		26	30	46.8	53	79		
	2003.11-	2009.11		L	F	MPV Engine BLJ	GDS61084	Drive Shaft		38	26	63	102.5	613		
	2003.11-	2009.11		R	F	MPV Engine BLJ	GDS61140	Drive Shaft		38	26	63	102.5	873		
2.5 TDi (128 kW)	2003.04-	2009.11	6MT		F	MPV Engine AXE/BPC	GDS61191	Stub Shaft		26	42	60		135.5		
	2003.04-	2009.11			F	MPV Engine AXE/BPC	GC061011	Outer Joint		38	29	63	102.5	70	M	
	2003.04-	2009.11	MT		F	MPV Engine AXE/BPC	GCI61021	Inner Joint		26	30	50	288	78		
	2003.04-	2009.11	MT		F	MPV Engine AXE/BPC	GCI61029	Inner Joint		26	30	46.8	53	79		
	2003.04-	2009.11	6MT	L	F	MPV Engine AXE/BPC	GDS61084	Drive Shaft		38	26	63	102.5	613		
	2003.04-	2009.11	6AT	R	F	MPV Engine AXE/BPC	GDS61210	Drive Shaft		38	26	63	102.5	925		
	2003.04-	2009.11	6MT	R	F	MPV Engine AXE/BPC	GDS61140	Drive Shaft		38	26	63	102.5	873		
	2003.04-	2009.11	AT	R	F	MPV Engine AXE/BPC	GDS83267	Drive Shaft		38	26	63	102.5	925		
	2003.04-	2009.11	5MT		F	MPV Engine AXE/BPC	GDS61190	Stub Shaft		26	37	50		136.5		
2.5 TDi (96 kW)	2003.04-	2009.11	6MT		F	MPV Engine AXD/BNZ	GDS61191	Stub Shaft		26	42	60		135.5		
	2003.04-	2009.11			F	MPV Engine AXD/BNZ	GC061011	Outer Joint		38	29	63	102.5	70	M	
	2003.04-	2009.11	MT		F	MPV Engine AXD/BNZ	GCI61021	Inner Joint		26	30	50	288	78		
	2003.04-	2009.11	MT		F	MPV Engine AXD/BNZ	GCI61029	Inner Joint		26	30	46.8	53	79		
	2003.04-	2009.11	6MT	L	F	MPV Engine AXD/BNZ	GDS61084	Drive Shaft		38	26	63	102.5	613		
	2003.04-	2009.11	6AT	R	F	MPV Engine AXD/BNZ	GDS61210	Drive Shaft		38	26	63	102.5	925		
	2003.04-	2009.11	6MT	R	F	MPV Engine AXD/BNZ	GDS61140	Drive Shaft		38	26	63	102.5	873		
	2003.04-	2009.11	AT	R	F	MPV Engine AXD/BNZ	GDS83267	Drive Shaft		38	26	63	102.5	925		
	2003.04-	2009.11	5MT		F	MPV Engine AXD/BNZ	GDS61190	Stub Shaft		26	37	50		136.5		
2.5 TDi 4motion (128 kW)	2004.07-	2009.11	6MT			MPV Engine AXE/BPC	GDS61191	Stub Shaft		26	42	60		135.5		
	2004.07-	2009.11				MPV Engine AXE/BPC	GC061011	Outer Joint		38	29	63	102.5	70	M	
	2004.07-	2009.11	MT		F	MPV Engine AXE/BPC	GCI61029	Inner Joint		26	30	46.8	53	79		
	2004.07-	2009.11	6MT	L	F	MPV Engine AXE/BPC	GDS61084	Drive Shaft		38	26	63	102.5	613		
	2004.07-	2009.11	AT	R	F	MPV Engine AXE/BPC	GDS83267	Drive Shaft		38	26	63	102.5	925		
	2004.07-	2009.11	MT/AT	L	R	MPV Engine AXE/BPC	GDS61257	Drive Shaft		38		59	100	683		
2.5 TDi 4motion (96 kW)	2004.07-	2009.11	6MT			MPV Engine AXD/BNZ	GDS61191	Stub Shaft		26	42	60		135.5		
	2004.07-	2009.11				MPV Engine AXD/BNZ	GC061011	Outer Joint		38	29	63	102.5	70	M	
	2004.07-	2009.11	6MT	L	F	MPV Engine AXD/BNZ	GDS61084	Drive Shaft		38	26	63	102.5	613		
	2004.07-	2009.11	AT	R	F	MPV Engine AXD/BNZ	GDS83267	Drive Shaft		38	26	63	102.5	925		
	2004.07-	2009.11	MT/AT	L	R	MPV Engine AXD/BNZ	GDS61257	Drive Shaft		38		59	100	683		
	2004.07-	2009.11	5MT			MPV Engine AXD/BNZ	GDS61190	Stub Shaft		26	37	50		136.5		
3.2 V6 (170 kW)	2004.02-	2004.06	6MT		F	MPV Engine BDL	GDS61191	Stub Shaft		26	42	60		135.5		
	2004.02-	2004.06	AT		F	MPV Engine BDL	GC061011	Outer Joint		38	29	63	102.5	70	M	
	2004.02-	2004.06	5MT		F	MPV Engine BDL	GDS61190	Stub Shaft		26	37	50		136.5		
3.2 V6 (173 kW)	2004.02-	2009.11	6MT		F	MPV Engine BKK/CFLA	GDS61191	Stub Shaft		26	42	60		135.5		
	2004.02-	2009.11	AT		F	MPV Engine BKK/CFLA	GC061011	Outer Joint		38	29	63	102.5	70	M	
	2004.02-	2009.11	5MT		F	MPV Engine BKK/CFLA	GDS61190	Stub Shaft		26	37	50		136.5		
3.2 V6 4motion (173 kW)	2004.07-	2009.11	6MT			MPV Engine BKK/CFLA	GDS61191	Stub Shaft		26	42	60		135.5		
	2004.07-	2009.11				MPV Engine BKK/CFLA	GC061011	Outer Joint		38	29	63	102.5	70	M	
	2004.07-	2009.11	MT/AT	L	R	MPV Engine BKK/CFLA	GDS61257	Drive Shaft		38		59	100	683		
	2004.07-	2009.11	MT/AT	R	R	MPV Engine BKK/CFLA	GDS61258	Drive Shaft		38		59	100	743		
	2004.07-	2009.11	5MT			MPV Engine BKK/CFLA	GDS61190	Stub Shaft		26	37	50		136.5		
<b>NEW BEETLE (1Y7)</b>																
1.4 (55 kW)	2003.01-	2010.09	5MT		F	Convertible Engine BCA	GCI83008	Inner Joint			33		32			
1.6 (75 kW)	2003.01-	2010.09			F	Convertible Engine BFS	GC083036	Outer Joint		36	30	53.2	77.5	61	I	
	2003.01-	2010.09	5MT		F	Convertible Engine BFS	GCI83011	Inner Joint			33		34			
	2003.01-	2010.09	MT		F	Convertible Engine BFS	GCI53002	Inner Joint			33		34			
	2003.01-	2010.09	MT	L	F	Convertible Engine BFS	GDS61021	Drive Shaft		36		53.2	77.5	564.5		
1.8 T (110 kW)	2004.01-	2007.05			F	Convertible Engine AWU/AWV/BKF	GC083036	Outer Joint		36	30	53.2	77.5	61	I	
	2004.01-	2007.05	MT	L	F	Convertible Engine AWU/AWV/BKF	GDS61156	Drive Shaft		36		53	78	554.5		
	2004.01-	2007.05	MT	L	F	Convertible Engine AWU/AWV/BKF	GCI61062	Inner Joint			30		59			
1.9 TDi (74 kW)	2003.06-	2010.09			F	Convertible Engine AXR	GCI83011	Inner Joint			33		34			
	2003.06-	2010.09	MT/AT		F	Convertible Engine AXR	GC083036	Outer Joint		36	30	53.2	77.5	61	I	
	2003.06-	2010.09	MT	L	F	Convertible Engine AXR	GDS61021	Drive Shaft		36		53.2	77.5	564.5		



		YEAR	TRANSM	L/R	F/R		G-AP Ref.	PRODUCT	ABS	Technical Specifications						
										A	B	C	H	L	P	
<b>VOLKSWAGEN</b>																
<b>NEW BEETLE (1Y7)</b>																
1.9 TDi (74 kW)	2003.06-	2010.09	MT	L	F	Convertible Engine AXR	GDS83006	Drive Shaft		36		53.2	77.5	557		
1.9 TDi (77 kW)	2005.07-	2010.09	4AT		F	Convertible Engine BSW	GC083036	Outer Joint		36	30	53.2	77.5	61	I	
	2005.07-	2010.09	MT	L	F	Convertible Engine BSW	GDS61021	Drive Shaft		36		53.2	77.5	564.5		
2.0 (85 kW)	2002.09-	2010.10			F	Convertible Engine AZJ/BEV	GC083036	Outer Joint		36	30	53.2	77.5	61	I	
	2002.09-	2010.10	MT		F	Convertible Engine AZJ/BEV	GCI83011	Inner Joint			33		34			
	2002.09-	2010.10	MT	L	F	Convertible Engine AZJ/BEV	GDS61021	Drive Shaft		36		53.2	77.5	564.5		
<b>NEW BEETLE (9C1, 1C1)</b>																
1.4 (55 kW)	2001.11-				F	Hatchback Engine BCA	GCI83008	Inner Joint			33		32			
1.6 (75 kW)	2000.06-		MT	L	F	Hatchback Engine AYD/BFS	GDS61021	Drive Shaft		36		53.2	77.5	564.5		
1.8 T (132 kW)	2001.11-	2005.06			F	Hatchback Engine AWP/BNU	GC083035	Outer Joint		36	27	53	77.5	65	I	
1.9 TDi (66 kW)	1998.01-	2004.06			F	Hatchback Engine ALH	GC083036	Outer Joint		36	30	53.2	77.5	61	I	
	1998.01-	2004.06	MT		F	Hatchback Engine ALH	GCI83009	Inner Joint			33		34			
	1998.01-	2004.06	MT	L	F	Hatchback Engine ALH	GDS83006	Drive Shaft		36		53.2	77.5	557		
	1998.01-	2004.06	MT	R	F	Hatchback Engine ALH	GDS83004	Drive Shaft		36		53.2	77.5	822		
1.9 TDi (74 kW)	2001.02-		MT		F	Hatchback Engine ATD/BEW	GCI83011	Inner Joint			33		34			
	2001.02-		MT/AT		F	Hatchback Engine ATD/BEW	GC083036	Outer Joint		36	30	53.2	77.5	61	I	
	2001.02-		MT	L	F	Hatchback Engine ATD/BEW	GDS83006	Drive Shaft		36		53.2	77.5	557		
	2001.02-		MT	L	F	Hatchback Engine ATD/BEW	GDS61021	Drive Shaft		36		53.2	77.5	564.5		
1.9 TDi (77 kW)	2005.07-		4AT		F	Hatchback Engine BSW	GC083036	Outer Joint		36	30	53.2	77.5	61	I	
	2005.07-			L	F	Hatchback Engine BSW	GDS61021	Drive Shaft		36		53.2	77.5	564.5		
2.3 V5 (125 kW)	2000.10-			L	F	Hatchback Engine AQN	GDS61156	Drive Shaft		36		53	78	554.5		
	2000.10-			L	F	Hatchback Engine AQN	GCI61062	Inner Joint			30		59			
<b>NEW BEETLE (9C1, 1C1, 1Y7)</b>																
1.9 TDi (66 kW)	1998.01-	2004.06			R		GCI83013	Inner Joint			33		34			
1.9 TDi (74 kW)	1998.01-	2004.06			R		GCI83013	Inner Joint			33		34			
<b>PARATI</b>																
1.0 Mi 16V	1997-	2001.11		L			GDS61117	Drive Shaft		22		51	78.7	634		
	1997-	2001.11		R			GDS61118	Drive Shaft		22		51	78.7	605		
	1997-	2001.11		L/R			GC061031	Outer Joint		22	28	51	78.7	51.1	M	
1.0 Turbo	2000.01-	2006.12	MT				GCI53002	Inner Joint			33		34			
	2000.01-	2006.12	MT				GC061028	Outer Joint		22	30	51	78	61	I	
2.0 16V	1996.01-	2006.12	MT				GC061034	Outer Joint		33	30	64	33.5	61	I	
	1996.01-	2006.12	MT				GC061023	Outer Joint	43T	33	30	64	33.5	61	I	
2.0 8V	1996.01-	2006.12	MT				GC099134	Outer Joint	43T	22	30	51	78	61	I	
	1996.01-	2006.12	MT				GC061028	Outer Joint		22	30	51	78	61	I	
<b>PARATI MI</b>																
1.0 16V	1997.01-	2006.12	MT				GCI18019	Inner Joint			33		32			
	1997.01-	2006.12	MT				GC061030	Outer Joint		22	28	51	77.5	50	M	
	1997.01-	2006.12	MT	L			GDS61079	Drive Shaft		22		51	78.7	634		
	1997.01-	2006.12	MT	R			GDS61080	Drive Shaft		22		51	78.7	605		
	1997.01-	2006.12	MT	L/R			GC061031	Outer Joint		22	28	51	78.7	51.1	M	
<b>PASSAT</b>																
1.6			MT/AT				GC083045	Outer Joint		33	30	53	30	62	I	
1.8			MT/AT				GC083045	Outer Joint		33	30	53	30	62	I	
	1988.04-	1996.08			F		GC053004	Outer Joint		22	30	51	78	61	I	
1.9			MT/AT				GC083045	Outer Joint		33	30	53	30	62	I	
1.9 TD (55 kW)	1992.09-	1996.09			F		GC053004	Outer Joint		22	30	51	78	61	I	
1.9 TDi (66 kW)	1993.10-	1996.09			F		GC053004	Outer Joint		22	30	51	78	61	I	
2.0 16V (100 kW)	1988.04-	1996.10			F		GC053004	Outer Joint		22	30	51	78	61	I	
2.0 8V (85 kW)	1990.08-	1996.09			F		GC053004	Outer Joint		22	30	51	78	61	I	
<b>PASSAT (32)</b>																
1.3 (44 kW)	1973.05-	1978.01			F	Hatchback Engine ZF	GC083038	Outer Joint		22	30	51	78.7	51.1	O	
1.5 (63 kW)	1973.05-	1975.12			F	Hatchback Engine ZC	GC083038	Outer Joint		22	30	51	78.7	51.1	O	
<b>PASSAT (32B)</b>																
1.8 (82 kW)	1983.12-	1988.03	MT/AT	L	F	Hatchback Engine DZ	GDS61001	Drive Shaft		22		53.2	78	557		
	1983.12-	1988.03	MT/AT	R	F	Hatchback Engine DZ	GDS61002	Drive Shaft		22		53	78.5	793		
1.9 (85 kW)	1981.01-	1983.07	MT/AT		F	Hatchback Engine WN	GCI83006	Inner Joint			33		34			
2.2 (100 kW)	1985.01-	1988.03	MT		F	Hatchback Engine KV	GC083031	Outer Joint		22	25	51	78	61	O	
2.2 (85 kW)	1985.01-	1988.03	MT/AT		F	Saloon Engine KX	GCI83006	Inner Joint			33		34			
	1985.08-	1988.03	MT/AT		F	Hatchback Engine KX	GCI83006	Inner Joint			33		34			

		TRANSM	L/R	F/R		G-AP Ref.	PRODUCT	ABS	Technical Specifications					
									YEAR	A	B	C	H	L
<b>VOLKSWAGEN</b>														
<b>PASSAT (362)</b>														
1.4 TSi (118 kW)	2012.11-		7AT	L	F	Saloon Engine CTHD	GDS61281	Drive Shaft	36		59.5	40	528	
	2012.11-		MT	L	F	Saloon Engine CTHD	GDS61201	Drive Shaft	36		59.5	40.5	535	
1.4 TSi (90 kW)	2010.08-		AT	L	F	Saloon Engine CAXA	GDS61201	Drive Shaft	36		59.5	40.5	535	
	2010.08-		MT	L	F	Saloon Engine CAXA	GDS61198	Drive Shaft	36		59.5	40.5	530	
	2010.08-		MT/AT			Saloon Engine CAXA	GC083100	Outer Joint	36	33	59.5	38	55	I
	2010.08-					Saloon Engine CAXA	GC061059	Outer Joint	36	33	59.5	40	59.5	I
1.4 TSi EcoFuel (110 kW)	2010.08-		AT	L	F	Saloon Engine CDGA	GDS61281	Drive Shaft	36		59.5	40	528	
	2010.08-		MT	L	F	Saloon Engine CDGA	GDS61201	Drive Shaft	36		59.5	40.5	535	
1.4 TSi MultiFuel (118 kW)	2010.11-		AT	L	F	Saloon Engine CKMA	GDS61281	Drive Shaft	36		59.5	40	528	
	2010.11-		MT	L	F	Saloon Engine CKMA	GDS61201	Drive Shaft	36		59.5	40.5	535	
1.6 TDi (77 kW)	2010.08-		MT	R	F	Saloon Engine CAYC	GDS61200	Drive Shaft	36		59.5	40.5	820	
	2010.08-					Saloon Engine CAYC	GC083100	Outer Joint	36	33	59.5	38	55	I
1.8 TSi (118 kW)	2010.08-		7AT	L	F	Saloon Engine CDAA	GDS83236	Drive Shaft	36		59.5	40	484	
	2010.08-		MT	L	F	Saloon Engine CDAA	GDS61131	Drive Shaft	36		59.5	40	515	
2.0 TDi (100 kW)	2010.08-			L	F	Saloon Engine CFFA	GDS83295	Drive Shaft	36		59.5	40	491	
	2010.08-			R	F	Saloon Engine CFFA	GDS83313	Drive Shaft	36		59.5	40	792	
	2010.08-		MT	L	F	Saloon Engine CFFA	GDS83236	Drive Shaft	36		59.5	40	484	
	2010.08-		MT	R	F	Saloon Engine CFFA	GDS61126	Drive Shaft	36		59.5	40	793	
2.0 TDi (103 kW)	2010.08-		AT	L	F	Saloon Engine CFFB	GDS54013	Drive Shaft	36		59.5	40	479.5	
	2010.08-		AT	R	F	Saloon Engine CFFB	GDS54011	Drive Shaft	36		59.5	40	755	
	2010.08-		MT	R	F	Saloon Engine CFFB	GDS83313	Drive Shaft	36		59.5	40	792	
	2010.08-		AT	L	F	Saloon Engine CFFB	GDS83241	Drive Shaft	36		59.5	40	475	
	2010.08-		MT	L	F	Saloon Engine CFFB	GDS83236	Drive Shaft	36		59.5	40	484	
	2010.08-		MT	R	F	Saloon Engine CFFB	GDS61126	Drive Shaft	36		59.5	40	793	
2.0 TDi (125 kW)	2010.08-		AT	L	F	Saloon Engine CFGB/CLLA	GDS83241	Drive Shaft	36		59.5	40	475	
	2010.08-		MT	L	F	Saloon Engine CFGB/CLLA	GDS83236	Drive Shaft	36		59.5	40	484	
	2010.08-		MT	R	F	Saloon Engine CFGB/CLLA	GDS61126	Drive Shaft	36		59.5	40	793	
2.0 TDi 4motion (103 kW)	2010.08-		MT	L		Saloon Engine CFFB	GDS83295	Drive Shaft	36		59.5	40	491	
	2010.08-		MT	R		Saloon Engine CFFB	GDS83266	Drive Shaft	36		59.5	40	601	
	2010.08-		AT	L	F	Saloon Engine CFFB	GDS83241	Drive Shaft	36		59.5	40	475	
	2010.08-		MT	L	F	Saloon Engine CFFB	GDS83236	Drive Shaft	36		59.5	40	484	
	2010.08-		MT	R		Saloon Engine CFFB	GCI83016	Inner Joint		28		32		
2.0 TDi 4motion (125 kW)	2010.08-		AT	L		Saloon Engine CFGB/CLLA	GDS54013	Drive Shaft	36		59.5	40	479.5	
	2010.08-		AT	L	F	Saloon Engine CFGB/CLLA	GDS83241	Drive Shaft	36		59.5	40	475	
	2010.08-		MT	L	F	Saloon Engine CFGB/CLLA	GDS83236	Drive Shaft	36		59.5	40	484	
2.0 TDi 4motion (130 kW)	2013.01-		AT	L		Saloon Engine CFGC	GDS54013	Drive Shaft	36		59.5	40	479.5	
<b>PASSAT (3A2, 35I)</b>														
1.6 (74 kW)	1994.10-	1996.08	MT	L	F	Saloon Engine AEK/AFT	GDS61001	Drive Shaft	22		53.2	78	557	
	1994.10-	1996.08	MT	R	F	Saloon Engine AEK/AFT	GDS61002	Drive Shaft	22		53	78.5	793	
1.6 TD (59 kW)	1988.08-	1993.09	MT	L	F	Saloon Engine RA/SB	GDS61001	Drive Shaft	22		53.2	78	557	
	1988.08-	1993.09	MT	R	F	Saloon Engine RA/SB	GDS61002	Drive Shaft	22		53	78.5	793	
1.8 (55 kW)	1990.08-	1996.08	MT/AT	L	F	Saloon Engine AAM	GDS61001	Drive Shaft	22		53.2	78	557	
	1990.08-	1996.08	MT/AT	R	F	Saloon Engine AAM	GDS61002	Drive Shaft	22		53	78.5	793	
1.8 (66 kW)	1988.02-	1996.08	MT/AT	L	F	Saloon Engine ABS/ADZ/RP	GDS61001	Drive Shaft	22		53.2	78	557	
	1988.02-	1996.08	MT/AT	R	F	Saloon Engine ABS/ADZ/RP	GDS61002	Drive Shaft	22		53	78.5	793	
1.8 (79 kW)	1988.04-	1993.07	MT	L	F	Saloon Engine PF	GDS61001	Drive Shaft	22		53.2	78	557	
	1988.04-	1993.07	MT/AT	R	F	Saloon Engine PF	GDS61002	Drive Shaft	22		53	78.5	793	
1.8 (82 kW)	1988.04-	1992.07	MT	L	F	Saloon Engine PB	GDS61001	Drive Shaft	22		53.2	78	557	
	1988.04-	1992.07	MT/AT	R	F	Saloon Engine PB	GDS61002	Drive Shaft	22		53	78.5	793	
1.8 16V (100 kW)	1988.04-	1989.12		L	F	Saloon Engine KR	GDS61001	Drive Shaft	22		53.2	78	557	
	1988.04-	1989.12	MT/AT	R	F	Saloon Engine KR	GDS61002	Drive Shaft	22		53	78.5	793	
1.9 D (50 kW)	1989.05-	1993.10	MT	L	F	Saloon Engine 1Y	GDS61001	Drive Shaft	22		53.2	78	557	
	1989.05-	1993.10	MT	R	F	Saloon Engine 1Y	GDS61002	Drive Shaft	22		53	78.5	793	
1.9 TD (55 kW)	1991.03-	1996.08	MT/AT	L	F	Saloon Engine AAZ	GDS61001	Drive Shaft	22		53.2	78	557	
	1991.03-	1996.08	MT/AT	R	F	Saloon Engine AAZ	GDS61002	Drive Shaft	22		53	78.5	793	
1.9 TDi (66 kW)	1993.10-	1996.08	MT	L	F	Saloon Engine 1Z/AHU	GDS61001	Drive Shaft	22		53.2	78	557	
	1993.10-	1996.08	MT	R	F	Saloon Engine 1Z/AHU	GDS61002	Drive Shaft	22		53	78.5	793	
2.0 (79 kW)	1995.03-	1996.08	MT	L	F	Saloon Engine AEP	GDS61001	Drive Shaft	22		53.2	78	557	
	1995.03-	1996.08	MT	R	F	Saloon Engine AEP	GDS61002	Drive Shaft	22		53	78.5	793	
2.0 (85 kW)	1990.02-	1996.08	MT	L	F	Saloon Engine 2E/ADY/AGG	GDS61001	Drive Shaft	22		53.2	78	557	
	1990.02-	1996.08	MT	R	F	Saloon Engine 2E/ADY/AGG	GDS61002	Drive Shaft	22		53	78.5	793	









		TRANSM	L/R	F/R		G-AP Ref.	PRODUCT	ABS	Technical Specifications							
									YEAR	A	B	C	H	L	P	
<b>VOLKSWAGEN</b>																
<b>PASSAT (3A2, 35I)</b>																
2.0 16V (100 kW)	1988.08-	1993.09	MT/AT	L	F	Saloon Engine 9A	GDS61001	Drive Shaft	22		53.2	78	557			
	1988.08-	1993.09	MT/AT	R	F	Saloon Engine 9A	GDS61002	Drive Shaft	22		53	78.5	793			
<b>PASSAT (3B3)</b>																
1.6 (75 kW)	2000.11-	2005.05	MT		F	Saloon Engine ALZ	GCI83002	Inner Joint		33		32				
	2000.11-	2005.05	MT		F	Saloon Engine ALZ	GC061012	Outer Joint	45W	33	30	53	30	62	I	
	2000.11-	2005.05		L	F	Saloon Engine ALZ	GDS83002	Drive Shaft	45W	33		53	30	614		
	2000.11-	2005.05		R	F	Saloon Engine ALZ	GDS99111	Drive Shaft	45W	33		53	30	636		
1.8 T 20V (110 kW)	2000.11-	2005.05	AT		F	Saloon Engine AWL/AWT	GC083019	Outer Joint	45W	38	27	59.5	34.5	63	I	
	2000.11-	2005.05	MT		F	Saloon Engine AWL/AWT	GC061012	Outer Joint	45W	33	30	53	30	62	I	
	2000.11-	2005.05	5AT	L	F	Saloon Engine AWL/AWT	GDS83036	Drive Shaft	45W	33		53	30	524		
	2000.11-	2005.05	MT	L	F	Saloon Engine AWL/AWT	GDS83005	Drive Shaft	45W	33		53	30	614		
	2000.11-	2005.05	MT	L	F	Saloon Engine AWL/AWT	GDS61122	Drive Shaft	45W	33		53	30	602		
	2000.11-	2005.05		L/R	F	Saloon Engine AWL/AWT	GCI61033	Inner Joint			34		85			
	2000.11-	2005.05	MT	R	F	Saloon Engine AWL/AWT	GDS83001	Drive Shaft	45W	33		53	30	634		
	2000.11-	2005.05	MT	R	F	Saloon Engine AWL/AWT	GDS83007	Drive Shaft	45W	33		53	30	622		
1.9 TDi (74 kW)	2000.11-	2005.05	AT		F	Saloon Engine AVB	GC083019	Outer Joint	45W	38	27	59.5	34.5	63	I	
	2000.11-	2005.05	MT		F	Saloon Engine AVB	GC083021	Outer Joint	45W	33	27	53	30	63	I	
	2000.11-	2005.05	MT	L	F	Saloon Engine AVB	GDS61083	Drive Shaft	45W	33		53	30	603		
	2000.11-	2005.05	MT	L/R	F	Saloon Engine AVB	GCI50019	Inner Joint			34		59.5			
	2000.11-	2005.05	MT	L/R	F	Saloon Engine AVB	GC083050	Outer Joint		33	27	53	30	63	I	
	2000.11-	2005.05		L/R	F	Saloon Engine AVB	GCI61033	Inner Joint			34		85			
	2000.11-	2005.05	MT	R	F	Saloon Engine AVB	GDS61082	Drive Shaft	45W	33		53	30	620		
1.9 TDi (96 kW)	2000.11-	2005.05	MT/AT		F	Saloon Engine AVF/AWX	GC083019	Outer Joint	45W	38	27	59.5	34.5	63	I	
	2000.11-	2005.05	MT	L	F	Saloon Engine AVF/AWX	GDS61157	Drive Shaft	45W	38		59.5	34.5	601		
	2000.11-	2005.05	MT	L	F	Saloon Engine AVF/AWX	GDS83008	Drive Shaft	45W	38		59.5	34.5	603		
	2000.11-	2005.05		L/R	F	Saloon Engine AVF/AWX	GCI61033	Inner Joint			34		85			
	2000.11-	2005.05		R	F	Saloon Engine AVF/AWX	GDS61019	Drive Shaft	45W	38		59.5	34.5	624		
1.9 TDi 4motion (96 kW)	2000.11-	2005.05	MT	L	F	Saloon Engine AVF	GDS61157	Drive Shaft	45W	38		59.5	34.5	601		
	2000.11-	2005.05		L/R	F	Saloon Engine AVF	GCI61033	Inner Joint			34		85			
	2000.11-	2005.05	MT/AT		F	Saloon Engine AVF	GC083019	Outer Joint	45W	38	27	59.5	34.5	63	I	
2.0 (85 kW)	2000.11-	2005.05	AT		F	Saloon Engine AZM/BFF	GC061012	Outer Joint	45W	33	30	53	30	62	I	
	2000.11-	2005.05	MT		F	Saloon Engine AZM/BFF	GC083018	Outer Joint	45W	33	30	53	30	62	I	
	2000.11-	2005.05	MT		F	Saloon Engine AZM/BFF	GCI83001	Inner Joint			28		32			
	2000.11-	2005.05	AT	L	F	Saloon Engine AZM/BFF	GDS83012	Drive Shaft	45W	33		53	30	498		
	2000.11-	2005.05	MT	L	F	Saloon Engine AZM/BFF	GDS83005	Drive Shaft	45W	33		53	30	614		
	2000.11-	2005.05		L/R	F	Saloon Engine AZM/BFF	GCI61033	Inner Joint			34		85			
	2000.11-	2005.05	AT	R	F	Saloon Engine AZM/BFF	GDS99108	Drive Shaft	45W	33		53	30	586		
	2000.11-	2005.05	MT	R	F	Saloon Engine AZM/BFF	GDS83001	Drive Shaft	45W	33		53	30	634		
	2000.11-	2005.05	MT		F	Saloon Engine AZM/BFF	GC083045	Outer Joint		33	30	53	30	62	I	
2.0 (96 kW)	2001.11-	2005.05	MT		F	Saloon Engine ALT	GCI83002	Inner Joint			33		32			
	2001.11-	2005.05	MT		F	Saloon Engine ALT	GC061012	Outer Joint	45W	33	30	53	30	62	I	
	2001.11-	2005.05	MT	L	F	Saloon Engine ALT	GDS61122	Drive Shaft	45W	33		53	30	602		
	2001.11-	2005.05		L/R	F	Saloon Engine ALT	GCI61033	Inner Joint			34		85			
	2001.11-	2005.05	MT	R	F	Saloon Engine ALT	GDS83007	Drive Shaft	45W	33		53	30	622		
2.0 4motion (85 kW)	2000.11-	2005.05	MT		F	Saloon Engine AZM	GC061012	Outer Joint	45W	33	30	53	30	62	I	
2.0 TDi (100 kW)	2003.12-	2005.05			F	Saloon Engine BGW	GC083019	Outer Joint	45W	38	27	59.5	34.5	63	I	
	2003.12-	2005.05	MT	L	F	Saloon Engine BGW	GDS83236	Drive Shaft		36		59.5	40	484		
	2003.12-	2005.05	MT	L	F	Saloon Engine BGW	GDS83008	Drive Shaft	45W	38		59.5	34.5	603		
	2003.12-	2005.05		L/R	F	Saloon Engine BGW	GCI61033	Inner Joint			34		85			
	2003.12-	2005.05	MT	R	F	Saloon Engine BGW	GDS61126	Drive Shaft		36		59.5	40	793		
2.3 V5 (125 kW)	2000.11-	2005.05	MT/AT		F	Saloon Engine AZX	GC083019	Outer Joint	45W	38	27	59.5	34.5	63	I	
	2000.11-	2005.05	MT	L	F	Saloon Engine AZX	GDS83008	Drive Shaft	45W	38		59.5	34.5	603		
	2000.11-	2005.05		L/R	F	Saloon Engine AZX	GCI61033	Inner Joint			34		85			
	2000.11-	2005.05	MT	R	F	Saloon Engine AZX	GDS61019	Drive Shaft	45W	38		59.5	34.5	624		
2.3 V5 4motion (125 kW)	2000.11-	2005.05	MT			Saloon Engine AZX	GC083019	Outer Joint	45W	38	27	59.5	34.5	63	I	
	2000.11-	2005.05		L/R	F	Saloon Engine AZX	GCI61033	Inner Joint			34		85			
2.5 TDi (110 kW)	2000.11-	2005.05			F	Saloon Engine AFB/AKN	GCI50019	Inner Joint			34		59.5			
	2000.11-	2005.05	MT&AT		F	Saloon Engine AFB/AKN	GC083019	Outer Joint	45W	38	27	59.5	34.5	63	I	
	2000.11-	2005.05	MT	L	F	Saloon Engine AFB/AKN	GDS83008	Drive Shaft	45W	38		59.5	34.5	603		
	2000.11-	2005.05		L/R	F	Saloon Engine AFB/AKN	GCI61033	Inner Joint			34		85			



		TRANSM	L/R	F/R		G-AP Ref.	PRODUCT	ABS	Technical Specifications											
									YEAR	A	B	C	H	L	P					
<b>VOLKSWAGEN PASSAT (3B3)</b>																				
2.5 TDi (110 kW)	2000.11-	2005.05	MT	R	F	Saloon Engine AFB/AKN	GDS60035	Drive Shaft		33	22	52	109	961						
	2000.11-	2005.05	MT	R	F	Saloon Engine AFB/AKN	GDS61019	Drive Shaft	45W	38		59.5	34.5	624						
2.5 TDi (120 kW)	2003.05-	2005.05	MT		F	Saloon Engine BDG	GC083019	Outer Joint	45W	38	27	59.5	34.5	63	I					
	2003.05-	2005.05	MT	L	F	Saloon Engine BDG	GDS83008	Drive Shaft	45W	38		59.5	34.5	603						
	2003.05-	2005.05		L/R	F	Saloon Engine BDG	GCI61033	Inner Joint			34		85							
	2003.05-	2005.05	MT	R	F	Saloon Engine BDG	GDS61019	Drive Shaft	45W	38		59.5	34.5	624						
	2003.05-	2005.05	MT		F	Saloon Engine BDG	GDS61019	Drive Shaft	45W	38		59.5	34.5	624						
2.5 TDi 4motion (110 kW)	2000.11-	2005.05	AT		F	Saloon Engine AFB/AKN	GC083020	Outer Joint	45W	38	30	59.5	34	59.5	I					
	2000.11-	2005.05	MT		F	Saloon Engine AFB/AKN	GC083019	Outer Joint	45W	38	27	59.5	34.5	63	I					
	2000.11-	2005.05	MT	L	F	Saloon Engine AFB/AKN	GDS83008	Drive Shaft	45W	38		59.5	34.5	603						
	2000.11-	2005.05		L/R	F	Saloon Engine AFB/AKN	GCI61033	Inner Joint			34		85							
	2000.11-	2005.05	MT	R	F	Saloon Engine AFB/AKN	GDS61019	Drive Shaft	45W	38		59.5	34.5	624						
	2000.11-	2005.05	AT		F	Saloon Engine AFB/AKN	GC083049	Outer Joint		38	30	59.5	34	59.5	I					
2.5 TDi 4motion (132 kW)	2003.01-	2005.05	AT		F	Saloon Engine BAU/BDH	GC083019	Outer Joint	45W	38	27	59.5	34.5	63	I					
	2003.01-	2005.05	MT	L	F	Saloon Engine BAU/BDH	GDS83008	Drive Shaft	45W	38		59.5	34.5	603						
	2003.01-	2005.05		L/R	F	Saloon Engine BAU/BDH	GCI61033	Inner Joint			34		85							
	2003.01-	2005.05	MT	R	F	Saloon Engine BAU/BDH	GDS61019	Drive Shaft	45W	38		59.5	34.5	624						
2.8 4motion (142 kW)	2000.11-	2005.05			F	Saloon Engine AMX/ATQ	GCI50019	Inner Joint			34		59.5							
	2000.11-	2005.05	MT		F	Saloon Engine AMX/ATQ	GC083019	Outer Joint	45W	38	27	59.5	34.5	63	I					
	2000.11-	2005.05		L/R	F	Saloon Engine AMX/ATQ	GCI61033	Inner Joint			34		85							
	2000.11-	2005.05	MT	R	F	Saloon Engine AMX/ATQ	GDS83362	Drive Shaft	45W	38		59.5	34	621						
4.0 W8 4motion (202 kW)	2001.09-	2004.09	AT		F	Saloon Engine BDN	GC083019	Outer Joint	45W	38	27	59.5	34.5	63	I					
	2001.09-	2004.09		L/R	F	Saloon Engine BDN	GCI61033	Inner Joint			34		85							
<b>PASSAT (3C2)</b>																				
1.4 TSi (90 kW)	2007.05-	2010.07	MT		F	Saloon Engine CAXA	GCI83011	Inner Joint			33		34							
	2007.05-	2010.07	Semi-AT		F	Saloon Engine CAXA	GC083002	Outer Joint		36	27	59.5	40	66	I					
	2007.05-	2010.07	MT	L	F	Saloon Engine CAXA	GDS61198	Drive Shaft		36		59.5	40.5	530						
	2007.05-	2010.07			F	Saloon Engine CAXA	GC083100	Outer Joint		36	33	59.5	38	55	I					
1.4 TSi EcoFuel (110 kW)	2009.01-	2010.07	MT		F	Saloon Engine CDGA	GCI53002	Inner Joint			33		34							
	2009.01-	2010.07	AT	L	F	Saloon Engine CDGA	GDS61281	Drive Shaft		36		59.5	40	528						
	2009.01-	2010.07	MT	L	F	Saloon Engine CDGA	GDS61201	Drive Shaft		36		59.5	40.5	535						
1.6 (75 kW)	2005.05-	2010.07			F	Saloon Engine BSE/BSF	GCI83011	Inner Joint			33		34							
	2005.05-	2010.07	6AT		F	Saloon Engine BSE/BSF	GCI61011	Inner Joint		26	32	31	68.5	85						
	2005.05-	2010.07	MT		F	Saloon Engine BSE/BSF	GCI53002	Inner Joint			33		34							
	2005.05-	2010.07	6AT	L	F	Saloon Engine BSE/BSF	GDS61093	Drive Shaft		36	26	59.5	40.5	587.5						
	2005.05-	2010.07		L	F	Saloon Engine BSE/BSF	GDS83373	Drive Shaft		36		59.5	38	511						
	2005.05-	2010.07		R	F	Saloon Engine BSE/BSF	GDS61113	Drive Shaft		36		59.5	40	814						
	2005.05-	2010.07	6AT	R	F	Saloon Engine BSE/BSF	GDS61094	Drive Shaft		36	26	59.5	40.5	884						
1.6 FSi (85 kW)	2005.05-	2007.11			F	Saloon Engine BLF	GC083037	Outer Joint		36	30	59.5	40.5	55	I					
	2005.05-	2007.11	MT		F	Saloon Engine BLF	GCI53002	Inner Joint			33		34							
1.6 TDi (77 kW)	2009.08-	2010.07		R	F	Saloon Engine CAYC	GDS61200	Drive Shaft		36		59.5	40.5	820						
	2009.08-	2010.07			F	Saloon Engine CAYC	GC083100	Outer Joint		36	33	59.5	38	55	I					
1.8 TSi (118 kW)	2007.05-	2010.07	MT		F	Saloon Engine BZB/CDAA	GC083002	Outer Joint		36	27	59.5	40	66	I					
	2007.05-	2010.07	7AT	L	F	Saloon Engine BZB/CDAA	GDS83236	Drive Shaft		36		59.5	40	484						
1.9 TDi (77 kW)	2005.03-	2008.11			F	Saloon Engine BKC/BLS/BXE	GC083037	Outer Joint		36	30	59.5	40.5	55	I					
	2005.03-	2008.11			F	Saloon Engine BKC/BLS/BXE	GCI83011	Inner Joint			33		34							
	2005.03-	2008.11	MT		F	Saloon Engine BKC/BLS/BXE	GCI53002	Inner Joint			33		34							
	2005.03-	2008.11	AT	L	F	Saloon Engine BKC/BLS/BXE	GDS83241	Drive Shaft		36		59.5	40	475						
	2005.03-	2008.11	MT	L	F	Saloon Engine BKC/BLS/BXE	GDS61089	Drive Shaft		36		59.5	40.5	521						
	2005.03-	2008.11	AT	L/R	F	Saloon Engine BKC/BLS/BXE	GCI61057	Inner Joint			34		86							
2.0 BlueTDi (105 kW)	2009.01-				F	Saloon Engine CBAC	GC083002	Outer Joint		36	27	59.5	40	66	I					
	2009.01-		AT	L	F	Saloon Engine CBAC	GDS54013	Drive Shaft		36		59.5	40	479.5						
	2009.01-		MT	L	F	Saloon Engine CBAC	GDS83295	Drive Shaft		36		59.5	40	491						
	2009.01-		AT	R	F	Saloon Engine CBAC	GDS54011	Drive Shaft		36		59.5	40	755						
	2009.01-		MT	R	F	Saloon Engine CBAC	GDS83313	Drive Shaft		36		59.5	40	792						
	2009.01-		AT	L	F	Saloon Engine CBAC	GDS83241	Drive Shaft		36		59.5	40	475						
	2009.01-		AT	R	F	Saloon Engine CBAC	GDS83355	Drive Shaft		36	23	59.5	40	799						
2.0 FSi (110 kW)	2005.03-	2010.07			F	Saloon Engine BLR/BLY/BVY/BVZ	GC083037	Outer Joint		36	30	59.5	40.5	55	I					
	2005.03-	2010.07	6AT		F	Saloon Engine BLR/BLY/BVY/BVZ	GCI61011	Inner Joint		26	32	31	68.5	85						
	2005.03-	2010.07	MT		F	Saloon Engine BLR/BLY/BVY/BVZ	GCI83011	Inner Joint			33		34							
	2005.03-	2010.07	6AT	L	F	Saloon Engine BLR/BLY/BVY/BVZ	GDS61093	Drive Shaft		36	26	59.5	40.5	587.5						

		TRANSM	L/R	F/R		G-AP Ref.	PRODUCT	ABS	Technical Specifications									
									YEAR	A	B	C	H	L	P			
<b>VOLKSWAGEN</b>																		
<b>PASSAT (3C2)</b>																		
2.0 FSi (110 kW)	2005.03-	2010.07	MT	L	F	Saloon Engine BLR/BLY/BVY/BVZ	GDS61089	Drive Shaft	36		59.5	40.5	521					
	2005.03-	2010.07	6AT	R	F	Saloon Engine BLR/BLY/BVY/BVZ	GDS61094	Drive Shaft	36	26	59.5	40.5	884					
2.0 FSi (147 kW)	2005.07-	2010.07	6MT		F	Saloon Engine AXX/BPY/BWA/CAWB/CBFA/CCTA/CCZA	GC083002	Outer Joint	36	27	59.5	40	66	I				
	2005.07-	2010.07	MT	L	F	Saloon Engine AXX/BPY/BWA/CAWB/CBFA/CCTA/CCZA	GDS83236	Drive Shaft	36		59.5	40	484					
	2005.07-	2010.07	MT	R	F	Saloon Engine AXX/BPY/BWA/CAWB/CBFA/CCTA/CCZA	GDS61126	Drive Shaft	36		59.5	40	793					
2.0 FSi 4motion (110 kW)	2005.09-	2010.07				Saloon Engine BLX/BLY/BVX	GC083037	Outer Joint	36	30	59.5	40.5	55	I				
	2005.09-	2010.07	6AT			Saloon Engine BLX/BLY/BVX	GCI61011	Inner Joint	26	32	31	68.5	85					
	2005.09-	2010.07		L		Saloon Engine BLX/BLY/BVX	GDS83294	Drive Shaft	36		59.5	38	519					
	2005.09-	2010.07	6AT	L	F	Saloon Engine BLX/BLY/BVX	GDS61093	Drive Shaft	36	26	59.5	40.5	587.5					
	2005.09-	2010.07	MT	L	F	Saloon Engine BLX/BLY/BVX	GDS61089	Drive Shaft	36		59.5	40.5	521					
	2005.09-	2010.07	6AT	R	F	Saloon Engine BLX/BLY/BVX	GDS61094	Drive Shaft	36	26	59.5	40.5	884					
	2005.09-	2010.07			F/R	Saloon Engine BLX/BLY/BVX	GCI83011	Inner Joint		33		34						
	2005.09-	2010.07	MT	R		Saloon Engine BLX/BLY/BVX	GCI53002	Inner Joint		33		34						
	2.0 TDi (100 kW)	2005.03-	2010.11	6AT		F	Saloon Engine BMA/CBAA	GCI54004	Inner Joint		34		85					
2005.03-		2010.11	6MT/6AT		F	Saloon Engine BMA/CBAA	GC083002	Outer Joint	36	27	59.5	40	66	I				
2005.03-		2010.11	AT	L	F	Saloon Engine BMA/CBAA	GDS83241	Drive Shaft	36		59.5	40	475					
2005.03-		2010.11	AT	L	F	Saloon Engine BMA/CBAA	GDS54013	Drive Shaft	36		59.5	40	479.5					
2005.03-		2010.11	MT	L	F	Saloon Engine BMA/CBAA	GDS83236	Drive Shaft	36		59.5	40	484					
2005.03-		2010.11	MT	L	F	Saloon Engine BMA/CBAA	GCI83016	Inner Joint		28		32						
2005.03-		2010.11	MT	L	F	Saloon Engine BMA/CBAA	GDS83265	Drive Shaft	36		59.5	40	487					
2005.03-		2010.11	MT	L	F	Saloon Engine BMA/CBAA	GDS83295	Drive Shaft	36		59.5	40	491					
2005.03-		2010.11	AT	L/R	F	Saloon Engine BMA/CBAA	GCI61057	Inner Joint		34		86						
2005.03-		2010.11	AT	R	F	Saloon Engine BMA/CBAA	GDS54011	Drive Shaft	36		59.5	40	755					
2005.03-		2010.11	MT	R	F	Saloon Engine BMA/CBAA	GDS61126	Drive Shaft	36		59.5	40	793					
2005.03-		2010.11	MT	R	F	Saloon Engine BMA/CBAA	GDS83313	Drive Shaft	36		59.5	40	792					
2.0 TDi (103 kW)		2005.05-	2007.11	6AT		F	Saloon Engine BMP	GCI54004	Inner Joint		34		85					
		2005.05-	2007.11	6MT/6AT		F	Saloon Engine BMP	GC083002	Outer Joint	36	27	59.5	40	66	I			
	2005.05-	2007.11	AT	L	F	Saloon Engine BMP	GDS83241	Drive Shaft	36		59.5	40	475					
	2005.05-	2007.11	AT	L	F	Saloon Engine BMP	GDS54013	Drive Shaft	36		59.5	40	479.5					
	2005.05-	2007.11	MT	L	F	Saloon Engine BMP	GCI83016	Inner Joint		28		32						
	2005.05-	2007.11	MT	L	F	Saloon Engine BMP	GDS83265	Drive Shaft	36		59.5	40	487					
	2005.05-	2007.11	MT	L	F	Saloon Engine BMP	GDS83295	Drive Shaft	36		59.5	40	491					
	2005.05-	2007.11		L	F	Saloon Engine BMP	GDS83236	Drive Shaft	36		59.5	40	484					
	2005.05-	2007.11	AT	L/R	F	Saloon Engine BMP	GCI61057	Inner Joint		34		86						
	2005.05-	2007.11	AT	R	F	Saloon Engine BMP	GDS83355	Drive Shaft	36	23	59.5	40	799					
	2005.05-	2007.11	AT	R	F	Saloon Engine BMP	GDS54011	Drive Shaft	36		59.5	40	755					
	2005.05-	2007.11	MT	R	F	Saloon Engine BMP	GDS83313	Drive Shaft	36		59.5	40	792					
	2005.05-	2007.11		R	F	Saloon Engine BMP	GDS61126	Drive Shaft	36		59.5	40	793					
	2.0 TDi (125 kW)	2005.08-		6MT/6AT		F	Saloon Engine BMR/CBBB	GC061045	Outer Joint	36	27	59.5	40	65	M			
2005.08-			AT	L	F	Saloon Engine BMR/CBBB	GDS83241	Drive Shaft	36		59.5	40	475					
2005.08-			MT	L	F	Saloon Engine BMR/CBBB	GDS83236	Drive Shaft	36		59.5	40	484					
2005.08-			MT	R	F	Saloon Engine BMR/CBBB	GDS61126	Drive Shaft	36		59.5	40	793					
2.0 TDi (81 kW)	2008.11-	2010.07			F	Saloon Engine CBDC	GCI83011	Inner Joint		33		34						
	2008.11-	2010.07			F	Saloon Engine CBDC	GC083002	Outer Joint	36	27	59.5	40	66	I				
	2008.11-	2010.07	MT		F	Saloon Engine CBDC	GCI53002	Inner Joint		33		34						
	2008.11-	2010.07	MT	R	F	Saloon Engine CBDC	GDS61200	Drive Shaft	36		59.5	40.5	820					
	2008.11-	2010.07				Saloon Engine CBDC	GC083100	Outer Joint	36	33	59.5	38	55	I				
2.0 TDi (88 kW)	2005.11-	2007.05	AT	L	F	Saloon Engine BWV	GDS83241	Drive Shaft	36		59.5	40	475					
	2005.11-	2007.05	AT	L	F	Saloon Engine BWV	GDS54013	Drive Shaft	36		59.5	40	479.5					
	2005.11-	2007.05	MT	L	F	Saloon Engine BWV	GDS83295	Drive Shaft	36		59.5	40	491					
	2005.11-	2007.05		L	F	Saloon Engine BWV	GDS83236	Drive Shaft	36		59.5	40	484					
	2005.11-	2007.05	AT	L/R	F	Saloon Engine BWV	GCI61057	Inner Joint		34		86						
	2005.11-	2007.05	AT	R	F	Saloon Engine BWV	GDS83355	Drive Shaft	36	23	59.5	40	799					
	2005.11-	2007.05	AT	R	F	Saloon Engine BWV	GDS54011	Drive Shaft	36		59.5	40	755					
	2005.11-	2007.05	MT	R	F	Saloon Engine BWV	GDS83313	Drive Shaft	36		59.5	40	792					
2.0 TDi 16V (103 kW)	2005.05-	2007.11	6AT		F	Saloon Engine BKP/CBAB	GCI54004	Inner Joint		34		85						
	2005.05-	2007.11	6MT		F	Saloon Engine BKP/CBAB	GC083002	Outer Joint	36	27	59.5	40	66	I				
	2005.05-	2007.11	AT	L	F	Saloon Engine BKP/CBAB	GDS54013	Drive Shaft	36		59.5	40	479.5					
	2005.05-	2007.11	MT	L	F	Saloon Engine BKP/CBAB	GCI83016	Inner Joint		28		32						
	2005.05-	2007.11	MT	L	F	Saloon Engine BKP/CBAB	GDS83265	Drive Shaft	36		59.5	40	487					
	2005.05-	2007.11	MT	L	F	Saloon Engine BKP/CBAB	GDS83295	Drive Shaft	36		59.5	40	491					









		YEAR	TRANSM	L/R	F/R		G-AP Ref.	PRODUCT	ABS	Technical Specifications						
										A	B	C	H	L	P	
<b>VOLKSWAGEN</b>																
<b>PASSAT (3C2)</b>																
2.0 TDi 16V (103 kW)	2005.05-	2007.11		L	F	Saloon Engine BKP/CBAB	GDS83236	Drive Shaft		36		59.5	40	484		
	2005.05-	2007.11	AT	L/R	F	Saloon Engine BKP/CBAB	GCI61057	Inner Joint			34		86			
	2005.05-	2007.11	AT	R	F	Saloon Engine BKP/CBAB	GDS83355	Drive Shaft		36	23	59.5	40	799		
	2005.05-	2007.11	AT	R	F	Saloon Engine BKP/CBAB	GDS54011	Drive Shaft		36		59.5	40	755		
	2005.05-	2007.11	MT	R	F	Saloon Engine BKP/CBAB	GDS83313	Drive Shaft		36		59.5	40	792		
	2005.05-	2007.11		R	F	Saloon Engine BKP/CBAB	GDS61126	Drive Shaft		36		59.5	40	793		
	2005.05-	2007.11	MT	L	R	Saloon Engine BKP/CBAB	GDS61284	Drive Shaft		36		59.5	79	594		
	2005.05-	2007.11	MT	R	R	Saloon Engine BKP/CBAB	GDS61293	Drive Shaft		36		59.5	40	631		
2.0 TDi 16V 4motion (103 kW)	2005.03-		6AT			Saloon Engine BKP/CBAB	GCI54004	Inner Joint			34		85			
	2005.03-			L		Saloon Engine BKP/CBAB	GDS83295	Drive Shaft		36		59.5	40	491		
	2005.03-		MT	R		Saloon Engine BKP/CBAB	GDS83266	Drive Shaft		36		59.5	40	601		
	2005.03-		6MT/6AT		F	Saloon Engine BKP/CBAB	GC083002	Outer Joint		36	27	59.5	40	66	I	
	2005.03-				R	Saloon Engine BKP/CBAB	GCI83011	Inner Joint			33		34			
	2005.03-		MT	R		Saloon Engine BKP/CBAB	GCI53002	Inner Joint			33		34			
	2005.03-		MT	L	F	Saloon Engine BKP/CBAB	GDS83236	Drive Shaft		36		59.5	40	484		
	2005.03-		MT	L	R	Saloon Engine BKP/CBAB	GDS61284	Drive Shaft		36		59.5	79	594		
	2005.03-		MT	R	R	Saloon Engine BKP/CBAB	GDS61293	Drive Shaft		36		59.5	40	631		
	2005.03-		MT	R		Saloon Engine BKP/CBAB	GCI83016	Inner Joint			28		32			
2.0 TDi 4motion (103 kW)	2005.03-		6AT			Saloon Engine BMP	GCI54004	Inner Joint			34		85			
	2005.03-			L		Saloon Engine BMP	GDS83295	Drive Shaft		36		59.5	40	491		
	2005.03-				R	Saloon Engine BMP	GDS83266	Drive Shaft		36		59.5	40	601		
	2005.03-		6MT/6AT		F	Saloon Engine BMP	GC083002	Outer Joint		36	27	59.5	40	66	I	
	2005.03-				R	Saloon Engine BMP	GCI83011	Inner Joint			33		34			
	2005.03-		MT	R		Saloon Engine BMP	GCI53002	Inner Joint			33		34			
	2005.03-		MT	L	F	Saloon Engine BMP	GDS83236	Drive Shaft		36		59.5	40	484		
	2005.03-		MT	L	R	Saloon Engine BMP	GDS61284	Drive Shaft		36		59.5	79	594		
	2005.03-		MT	R	R	Saloon Engine BMP	GDS61293	Drive Shaft		36		59.5	40	631		
	2005.03-				R	Saloon Engine BMP	GCI83016	Inner Joint			28		32			
2.0 TDi 4motion (125 kW)	2009.05-			L		Saloon Engine CBBB	GDS54013	Drive Shaft		36		59.5	40	479.5		
	2009.05-		MT	R		Saloon Engine CBBB	GCI53002	Inner Joint			33		34			
	2009.05-		AT	L	F	Saloon Engine CBBB	GDS83241	Drive Shaft		36		59.5	40	475		
	2009.05-		MT	L	F	Saloon Engine CBBB	GDS83236	Drive Shaft		36		59.5	40	484		
	2009.05-		MT	L	R	Saloon Engine CBBB	GDS61284	Drive Shaft		36		59.5	79	594		
	2009.05-		MT	R	R	Saloon Engine CBBB	GDS61293	Drive Shaft		36		59.5	40	631		
3.2 FSi 4motion (184 kW)	2005.11-	2010.07		L		Saloon Engine AXZ	GDS54013	Drive Shaft		36		59.5	40	479.5		
	2005.11-	2010.07	MT	L		Saloon Engine AXZ	GDS83295	Drive Shaft		36		59.5	40	491		
	2005.11-	2010.07		R		Saloon Engine AXZ	GDS83266	Drive Shaft		36		59.5	40	601		
	2005.11-	2010.07	6AT		F	Saloon Engine AXZ	GC083002	Outer Joint		36	27	59.5	40	66	I	
	2005.11-	2010.07	AT	L	F	Saloon Engine AXZ	GDS83236	Drive Shaft		36		59.5	40	484		
	2005.11-	2010.07	AT	L	F	Saloon Engine AXZ	GDS83241	Drive Shaft		36		59.5	40	475		
	2005.11-	2010.07	MT/AT	L/R	F	Saloon Engine AXZ	GCI61057	Inner Joint			34		86			
	2005.11-	2010.07			R	Saloon Engine AXZ	GCI83011	Inner Joint			33		34			
	2005.11-	2010.07	MT	R		Saloon Engine AXZ	GCI53002	Inner Joint			33		34			
	2005.11-	2010.07			R	Saloon Engine AXZ	GCI83016	Inner Joint			28		32			
3.6 R36 4motion (220 kW)	2007.04-	2010.07	MT			Saloon Engine BWS	GCI53002	Inner Joint			33		34			
	2007.04-	2010.07	AT	L	F	Saloon Engine BWS	GDS83236	Drive Shaft		36		59.5	40	484		
	2007.04-	2010.07			R	Saloon Engine BWS	GCI83011	Inner Joint			33		34			
<b>PASSAT ALEMAO</b>																
2	1988.01-	1997.12	MT/AT				GCI61022	Inner Joint			33		34			
2.0 16V	1988.01-	1997.12	MT				GCI61022	Inner Joint			33		34			
	1990.01-	1997.12	AT				GCI61022	Inner Joint			33		34			
2.8	1988.01-	1997.12	MT/AT				GCI61022	Inner Joint			33		34			
<b>PASSAT ALLTRACK (365)</b>																
1.8 TSi (112 kW)	2012.01-		MT	L	F	Estate Engine CDAB	GDS61131	Drive Shaft		36		59.5	40	515		
	2012.01-		AT	R	F	Estate Engine CDAB	GDS61126	Drive Shaft		36		59.5	40	793		
1.8 TSi (118 kW)	2012.01-		MT	L	F	Estate Engine CDAA	GDS61131	Drive Shaft		36		59.5	40	515		
	2012.01-		AT	R	F	Estate Engine CDAA	GDS61126	Drive Shaft		36		59.5	40	793		
2.0 TDi (103 kW)	2012.01-			L	F	Estate Engine CFFB	GDS83295	Drive Shaft		36		59.5	40	491		
	2012.01-			R	F	Estate Engine CFFB	GDS83313	Drive Shaft		36		59.5	40	792		
2.0 TDi 4motion (103 kW)	2012.01-			L		Estate Engine CFFB	GDS83295	Drive Shaft		36		59.5	40	491		
	2012.01-		MT	L	F	Estate Engine CFFB	GDS83236	Drive Shaft		36		59.5	40	484		



		YEAR	TRANSM	L/R	F/R		G-AP Ref.	PRODUCT	ABS	Technical Specifications											
										A	B	C	H	L	P						
<b>VOLKSWAGEN</b>																					
<b>PASSAT ALLTRACK (365)</b>																					
2.0 TDi 4motion (125 kW)	2012.01-				L	Estate Engine CFGB	GDS54013	Drive Shaft		36		59.5	40	479.5							
	2012.01-		AT	L	F	Estate Engine CFGB	GDS83241	Drive Shaft		36		59.5	40	475							
2.0 TDi 4motion (130 kW)	2013.01-		AT	L		Estate Engine CFGC	GDS54013	Drive Shaft		36		59.5	40	479.5							
	2013.01-		AT	L	F	Estate Engine CFGC	GDS83241	Drive Shaft		36		59.5	40	475							
<b>PASSAT CC (357)</b>																					
1.4 TSi MultiFuel (118 kW)	2011.01-		AT	L	F	Coupe Engine CKMA	GDS61281	Drive Shaft		36		59.5	40	528							
	2011.01-		MT	L	F	Coupe Engine CKMA	GDS61201	Drive Shaft		36		59.5	40.5	535							
1.8 TSi (118 kW)	2008.06-	2010.11	MT		F	Coupe Engine BZB/CDA	GC083002	Outer Joint		36	27	59.5	40	66	I						
	2008.06-	2010.11	7AT	L	F	Coupe Engine BZB/CDA	GDS83236	Drive Shaft		36		59.5	40	484							
	2008.06-	2010.11	MT	L	F	Coupe Engine BZB/CDA	GDS61131	Drive Shaft		36		59.5	40	515							
	2008.06-	2010.11	MT	L	F	Coupe Engine BZB/CDA	GDS83295	Drive Shaft		36		59.5	40	491							
2.0 BlueTDi (105 kW)	2009.05-	2010.11	AT	L	F	Coupe Engine CBAC	GDS83241	Drive Shaft		36		59.5	40	475							
	2009.05-	2010.11	AT	L	F	Coupe Engine CBAC	GDS54013	Drive Shaft		36		59.5	40	479.5							
	2009.05-	2010.11	MT	L	F	Coupe Engine CBAC	GDS83295	Drive Shaft		36		59.5	40	491							
	2009.05-	2010.11	AT	R	F	Coupe Engine CBAC	GDS83355	Drive Shaft		36	23	59.5	40	799							
	2009.05-	2010.11	AT	R	F	Coupe Engine CBAC	GDS54011	Drive Shaft		36		59.5	40	755							
	2009.05-	2010.11	MT	R	F	Coupe Engine CBAC	GDS83313	Drive Shaft		36		59.5	40	792							
2.0 TDi (100 kW)	2008.06-	2011.05			F	Coupe Engine CBAA/CFFA	GC083002	Outer Joint		36	27	59.5	40	66	I						
	2008.06-	2011.05	6AT		F	Coupe Engine CBAA/CFFA	GCI54004	Inner Joint			34		85								
	2008.06-	2011.05	AT	L	F	Coupe Engine CBAA/CFFA	GDS54013	Drive Shaft		36		59.5	40	479.5							
	2008.06-	2011.05	MT	L	F	Coupe Engine CBAA/CFFA	GDS83236	Drive Shaft		36		59.5	40	484							
	2008.06-	2011.05	MT	L	F	Coupe Engine CBAA/CFFA	GDS83295	Drive Shaft		36		59.5	40	491							
	2008.06-	2011.05	AT	L/R	F	Coupe Engine CBAA/CFFA	GCI61057	Inner Joint			34		86								
	2008.06-	2011.05	AT	R	F	Coupe Engine CBAA/CFFA	GDS83355	Drive Shaft		36	23	59.5	40	799							
	2008.06-	2011.05	AT	R	F	Coupe Engine CBAA/CFFA	GDS54011	Drive Shaft		36		59.5	40	755							
	2008.06-	2011.05	MT	R	F	Coupe Engine CBAA/CFFA	GDS61126	Drive Shaft		36		59.5	40	793							
	2008.06-	2011.05	MT	R	F	Coupe Engine CBAA/CFFA	GDS83313	Drive Shaft		36		59.5	40	792							
2.0 TDi (103 kW)	2008.06-		6AT		F	Coupe Engine CBAB/CFFB	GCI54004	Inner Joint			34		85								
	2008.06-		MT		F	Coupe Engine CBAB/CFFB	GC083002	Outer Joint		36	27	59.5	40	66	I						
	2008.06-		AT	L	F	Coupe Engine CBAB/CFFB	GDS54013	Drive Shaft		36		59.5	40	479.5							
	2008.06-		AT	R	F	Coupe Engine CBAB/CFFB	GDS54011	Drive Shaft		36		59.5	40	755							
	2008.06-		MT	R	F	Coupe Engine CBAB/CFFB	GDS83313	Drive Shaft		36		59.5	40	792							
	2008.06-		AT	L	F	Coupe Engine CBAB/CFFB	GDS83241	Drive Shaft		36		59.5	40	475							
	2008.06-		MT	L	F	Coupe Engine CBAB/CFFB	GDS83236	Drive Shaft		36		59.5	40	484							
	2008.06-		AT	L/R	F	Coupe Engine CBAB/CFFB	GCI61057	Inner Joint			34		86								
	2008.06-		AT	R	F	Coupe Engine CBAB/CFFB	GDS83355	Drive Shaft		36	23	59.5	40	799							
	2008.06-		MT	R	F	Coupe Engine CBAB/CFFB	GDS61126	Drive Shaft		36		59.5	40	793							
2.0 TDi (125 kW)	2008.06-				F	Coupe Engine CBBB/CFGB/CLLA	GC061045	Outer Joint		36	27	59.5	40	65	M						
	2008.06-		AT	L	F	Coupe Engine CBBB/CFGB/CLLA	GDS83241	Drive Shaft		36		59.5	40	475							
	2008.06-		MT	L	F	Coupe Engine CBBB/CFGB/CLLA	GDS83236	Drive Shaft		36		59.5	40	484							
	2008.06-		MT	R	F	Coupe Engine CBBB/CFGB/CLLA	GDS61126	Drive Shaft		36		59.5	40	793							
2.0 TDi 4motion (103 kW)	2009.08-				L	Coupe Engine CBAB/CFFB	GDS83295	Drive Shaft		36		59.5	40	491							
	2009.08-				R	Coupe Engine CBAB/CFFB	GDS83266	Drive Shaft		36		59.5	40	601							
	2009.08-		MT		R	Coupe Engine CBAB/CFFB	GCI53002	Inner Joint			33		34								
	2009.08-		AT	L	F	Coupe Engine CBAB/CFFB	GDS83241	Drive Shaft		36		59.5	40	475							
	2009.08-		MT	L	F	Coupe Engine CBAB/CFFB	GDS83236	Drive Shaft		36		59.5	40	484							
	2009.08-				R	Coupe Engine CBAB/CFFB	GCI83016	Inner Joint			28		32								
2.0 TDi 4motion (125 kW)	2009.11-		AT	L	F	Coupe Engine CFGB/CBBB	GDS83241	Drive Shaft		36		59.5	40	475							
	2009.11-		MT	L	F	Coupe Engine CFGB/CBBB	GDS83236	Drive Shaft		36		59.5	40	484							
	2009.11-				L	Coupe Engine CFGB/CBBB	GDS54013	Drive Shaft		36		59.5	40	479.5							
2.0 TSi (147 kW)	2008.06-				F	Coupe Engine CAWB/CCZA	GC083002	Outer Joint		36	27	59.5	40	66	I						
	2008.06-		MT	L	F	Coupe Engine CAWB/CCZA	GDS83236	Drive Shaft		36		59.5	40	484							
	2008.06-		MT	R	F	Coupe Engine CAWB/CCZA	GDS61126	Drive Shaft		36		59.5	40	793							
3.6 FSi 4motion (220 kW)	2008.06-	2010.05	AT	L	F	Coupe Engine BWS	GDS83236	Drive Shaft		36		59.5	40	484							
	2008.06-	2010.05			R	Coupe Engine BWS	GCI83011	Inner Joint			33		34								
	2008.06-	2010.05	MT		R	Coupe Engine BWS	GCI53002	Inner Joint			33		34								
<b>PASSAT VARIANT (32B)</b>																					
1.8 Syncro (66 kW)	1986.01-	1988.03	MT		F/R	Estate Engine DS/JN	GCI83006	Inner Joint			33		34								
1.9 (85 kW)	1981.01-	1983.07	MT/AT		F	Estate Engine WN	GCI83006	Inner Joint			33		34								
2.0 Syncro (85 kW)	1984.05-	1988.03	MT		F/R	Estate Engine JS	GCI83006	Inner Joint			33		34								
2.2 (100 kW)	1985.01-	1988.03	MT		F	Estate Engine KV	GC083031	Outer Joint		22	25	51	78	61	O						

		TRANSM	L/R	F/R		G-AP Ref.	PRODUCT	ABS	Technical Specifications						
									YEAR	A	B	C	H	L	P
<b>VOLKSWAGEN</b>															
<b>PASSAT VARIANT (32B)</b>															
2.2 (85 kW)	1985.08-	1988.03	MT/AT		F	Estate Engine KX	GCI83006	Inner Joint		33		34			
2.2 Syncro (88 kW)	1985.08-	1988.03	MT		F/R	Estate Engine JT	GCI83006	Inner Joint		33		34			
<b>PASSAT VARIANT (33)</b>															
1.3 (44 kW)	1973.10-	1978.01			F	Estate Engine ZF	GC083038	Outer Joint	22	30	51	78.7	51.1	O	
1.5 (63 kW)	1973.10-	1975.12			F	Estate Engine ZC	GC083038	Outer Joint	22	30	51	78.7	51.1	O	
<b>PASSAT VARIANT (365)</b>															
1.4 TSi (90 kW)	2010.08-		MT	L	F	Estate Engine CAXA	GDS61198	Drive Shaft	36		59.5	40.5	530		
	2010.08-					Estate Engine CAXA	GC083100	Outer Joint	36	33	59.5	38	55	I	
1.4 TSi EcoFuel (110 kW)	2010.08-		AT	L	F	Estate Engine CDGA	GDS61281	Drive Shaft	36		59.5	40	528		
	2010.08-		MT	L	F	Estate Engine CDGA	GDS61201	Drive Shaft	36		59.5	40.5	535		
1.4 TSi MultiFuel (118 kW)	2010.11-		AT	L	F	Estate Engine CKMA	GDS61281	Drive Shaft	36		59.5	40	528		
	2010.11-		MT	L	F	Estate Engine CKMA	GDS61201	Drive Shaft	36		59.5	40.5	535		
1.6 TDi (77 kW)	2010.08-				R	F	Estate Engine CAYC	GDS61200	Drive Shaft	36		59.5	40.5	820	
	2010.08-				F	Estate Engine CAYC	GC083100	Outer Joint	36	33	59.5	38	55	I	
	2010.08-					Estate Engine CAYC	GC061059	Outer Joint	36	33	59.5	40	59.5	I	
1.8 TSi (118 kW)	2010.08-		7AT	L	F	Estate Engine CDAA	GDS83236	Drive Shaft	36		59.5	40	484		
	2010.08-		MT	L	F	Estate Engine CDAA	GDS61131	Drive Shaft	36		59.5	40	515		
2.0 TDi (100 kW)	2010.08-				L	F	Estate Engine CFFA	GDS83295	Drive Shaft	36		59.5	40	491	
	2010.08-				R	F	Estate Engine CFFA	GDS83313	Drive Shaft	36		59.5	40	792	
2.0 TDi (103 kW)	2010.08-		AT	L	F	Estate Engine CFFB	GDS54013	Drive Shaft	36		59.5	40	479.5		
	2010.08-		AT	R	F	Estate Engine CFFB	GDS54011	Drive Shaft	36		59.5	40	755		
	2010.08-		MT	R	F	Estate Engine CFFB	GDS83313	Drive Shaft	36		59.5	40	792		
	2010.08-		AT	L	F	Estate Engine CFFB	GDS83241	Drive Shaft	36		59.5	40	475		
	2010.08-		MT	L	F	Estate Engine CFFB	GDS83236	Drive Shaft	36		59.5	40	484		
	2010.08-		MT	R	F	Estate Engine CFFB	GDS61126	Drive Shaft	36		59.5	40	793		
2.0 TDi (125 kW)	2010.08-		AT	L	F	Estate Engine CFGB/CLLA	GDS83241	Drive Shaft	36		59.5	40	475		
	2010.08-		MT	L	F	Estate Engine CFGB/CLLA	GDS83236	Drive Shaft	36		59.5	40	484		
	2010.08-		MT	R	F	Estate Engine CFGB/CLLA	GDS61126	Drive Shaft	36		59.5	40	793		
2.0 TDi 4motion (103 kW)	2010.08-		MT	L		Estate Engine CFFB	GDS83295	Drive Shaft	36		59.5	40	491		
	2010.08-		MT	R		Estate Engine CFFB	GDS83266	Drive Shaft	36		59.5	40	601		
	2010.08-		AT	L	F	Estate Engine CFFB	GDS83241	Drive Shaft	36		59.5	40	475		
	2010.08-		MT	L	F	Estate Engine CFFB	GDS83236	Drive Shaft	36		59.5	40	484		
	2010.08-		MT	R		Estate Engine CFFB	GCI83016	Inner Joint		28		32			
2.0 TDi 4motion (125 kW)	2010.08-		AT	L		Estate Engine CLLA/CFGB	GDS54013	Drive Shaft	36		59.5	40	479.5		
	2010.08-		AT	L	F	Estate Engine CLLA/CFGB	GDS83241	Drive Shaft	36		59.5	40	475		
	2010.08-		MT	L	F	Estate Engine CLLA/CFGB	GDS83236	Drive Shaft	36		59.5	40	484		
2.0 TDi 4motion (130 kW)	2013.01-		AT	L		Estate Engine CFGC	GDS54013	Drive Shaft	36		59.5	40	479.5		
<b>PASSAT VARIANT (3A5, 35I)</b>															
1.6 (74 kW)	1994.07-	1995.12	MT	L	F	Estate Engine AEK/AFT	GDS61001	Drive Shaft	22		53.2	78	557		
	1994.07-	1995.12	MT	R	F	Estate Engine AEK/AFT	GDS61002	Drive Shaft	22		53	78.5	793		
1.6 TD (59 kW)	1988.08-	1993.09	MT	L	F	Estate Engine RA/SB	GDS61001	Drive Shaft	22		53.2	78	557		
	1988.08-	1993.09	MT	R	F	Estate Engine RA/SB	GDS61002	Drive Shaft	22		53	78.5	793		
1.8 (55 kW)	1990.08-	1997.05	MT/AT	L	F	Estate Engine AAM	GDS61001	Drive Shaft	22		53.2	78	557		
	1990.08-	1997.05	MT/AT	R	F	Estate Engine AAM	GDS61002	Drive Shaft	22		53	78.5	793		
1.8 (66 kW)	1988.02-	1997.05	MT/AT	L	F	Estate Engine ABS/ADZ/RP	GDS61001	Drive Shaft	22		53.2	78	557		
	1988.02-	1997.05	MT/AT	R	F	Estate Engine ABS/ADZ/RP	GDS61002	Drive Shaft	22		53	78.5	793		
1.8 (79 kW)	1988.04-	1990.07	MT/AT	L	F	Estate Engine PF	GDS61001	Drive Shaft	22		53.2	78	557		
	1988.04-	1990.07	MT/AT	R	F	Estate Engine PF	GDS61002	Drive Shaft	22		53	78.5	793		
1.8 (82 kW)	1988.04-	1992.07	MT/AT	L	F	Estate Engine PB	GDS61001	Drive Shaft	22		53.2	78	557		
	1988.04-	1992.07	MT/AT	R	F	Estate Engine PB	GDS61002	Drive Shaft	22		53	78.5	793		
1.8 16V (100 kW)	1988.04-	1989.12		L	F	Estate Engine KR	GDS61001	Drive Shaft	22		53.2	78	557		
	1988.04-	1989.12	MT/AT	R	F	Estate Engine KR	GDS61002	Drive Shaft	22		53	78.5	793		
1.9 D (50 kW)	1989.05-	1993.10	MT	L	F	Estate Engine 1Y	GDS61001	Drive Shaft	22		53.2	78	557		
	1989.05-	1993.10	MT	R	F	Estate Engine 1Y	GDS61002	Drive Shaft	22		53	78.5	793		
1.9 TD (55 kW)	1991.03-	1997.05	MT/AT	L	F	Estate Engine AAZ	GDS61001	Drive Shaft	22		53.2	78	557		
	1991.03-	1997.05	MT/AT	R	F	Estate Engine AAZ	GDS61002	Drive Shaft	22		53	78.5	793		
1.9 TDi (66 kW)	1993.10-	1997.05	MT	L	F	Estate Engine 1Z/AHU	GDS61001	Drive Shaft	22		53.2	78	557		
	1993.10-	1997.05	MT	R	F	Estate Engine 1Z/AHU	GDS61002	Drive Shaft	22		53	78.5	793		
2.0 (79 kW)	1995.03-	1996.08	MT	L	F	Estate Engine AEP	GDS61001	Drive Shaft	22		53.2	78	557		
	1995.03-	1996.08	MT	R	F	Estate Engine AEP	GDS61002	Drive Shaft	22		53	78.5	793		
2.0 (85 kW)	1990.02-	1997.05	MT	L	F	Estate Engine 2E/ADY/AGG	GDS61001	Drive Shaft	22		53.2	78	557		









		YEAR	TRANSM	L/R	F/R		G-AP Ref.	PRODUCT	ABS	Technical Specifications						
										A	B	C	H	L	P	
<b>VOLKSWAGEN</b>																
<b>PASSAT VARIANT (3A5, 35I)</b>																
2.0 (85 kW)	1990.02-	1997.05	MT	R	F	Estate Engine 2E/ADY/AGG	GDS61002	Drive Shaft		22		53	78.5	793		
2.0 16V (100 kW)	1988.08-	1993.09	MT/AT	L	F	Estate Engine 9A	GDS61001	Drive Shaft		22		53.2	78	557		
	1988.08-	1993.09	MT/AT	R	F	Estate Engine 9A	GDS61002	Drive Shaft		22		53	78.5	793		
<b>PASSAT VARIANT (3B6)</b>																
1.6 (75 kW)	2000.11-	2005.05	MT		F	Estate Engine ALZ	GCI83002	Inner Joint			33		32			
	2000.11-	2005.05	MT		F	Estate Engine ALZ	GC061012	Outer Joint	45W	33	30	53	30	62	I	
	2000.11-	2005.05		L	F	Estate Engine ALZ	GDS83002	Drive Shaft	45W	33		53	30	614		
	2000.11-	2005.05		R	F	Estate Engine ALZ	GDS99111	Drive Shaft	45W	33		53	30	636		
1.8 T 20V (110 kW)	2000.11-	2005.05	AT		F	Estate Engine AWT	GC083019	Outer Joint	45W	38	27	59.5	34.5	63	I	
	2000.11-	2005.05	MT		F	Estate Engine AWT	GCI83001	Inner Joint			28		32			
	2000.11-	2005.05	MT		F	Estate Engine AWT	GC061012	Outer Joint	45W	33	30	53	30	62	I	
	2000.11-	2005.05	5AT	L	F	Estate Engine AWT	GDS83036	Drive Shaft	45W	33		53	30	524		
	2000.11-	2005.05	MT	L	F	Estate Engine AWT	GDS83005	Drive Shaft	45W	33		53	30	614		
	2000.11-	2005.05	MT	L	F	Estate Engine AWT	GDS61122	Drive Shaft	45W	33		53	30	602		
	2000.11-	2005.05		L/R	F	Estate Engine AWT	GCI61033	Inner Joint			34		85			
	2000.11-	2005.05	MT	R	F	Estate Engine AWT	GDS83001	Drive Shaft	45W	33		53	30	634		
	2000.11-	2005.05	MT	R	F	Estate Engine AWT	GDS83007	Drive Shaft	45W	33		53	30	622		
	1.9 TDi (74 kW)	2000.11-	2005.05	AT		F	Estate Engine AVB	GC083019	Outer Joint	45W	38	27	59.5	34.5	63	I
2000.11-		2005.05	MT		F	Estate Engine AVB	GC083021	Outer Joint	45W	33	27	53	30	63	I	
2000.11-		2005.05	MT	L	F	Estate Engine AVB	GDS61083	Drive Shaft	45W	33		53	30	603		
2000.11-		2005.05	MT	L/R	F	Estate Engine AVB	GCI50019	Inner Joint			34		59.5			
2000.11-		2005.05	MT	L/R	F	Estate Engine AVB	GC083050	Outer Joint		33	27	53	30	63	I	
2000.11-		2005.05		L/R	F	Estate Engine AVB	GCI61033	Inner Joint			34		85			
2000.11-		2005.05	MT	R	F	Estate Engine AVB	GDS61082	Drive Shaft	45W	33		53	30	620		
1.9 TDi (96 kW)	2000.11-	2005.05			F	Estate Engine AVF/AWX	GC083019	Outer Joint	45W	38	27	59.5	34.5	63	I	
	2000.11-	2005.05		L	F	Estate Engine AVF/AWX	GDS83008	Drive Shaft	45W	38		59.5	34.5	603		
	2000.11-	2005.05	MT	L	F	Estate Engine AVF/AWX	GDS61157	Drive Shaft	45W	38		59.5	34.5	601		
	2000.11-	2005.05		L/R	F	Estate Engine AVF/AWX	GCI61033	Inner Joint			34		85			
	2000.11-	2005.05		R	F	Estate Engine AVF/AWX	GDS61019	Drive Shaft	45W	38		59.5	34.5	624		
1.9 TDi 4motion (96 kW)	2000.11-	2005.05			F	Estate Engine AVF	GC083019	Outer Joint	45W	38	27	59.5	34.5	63	I	
	2000.11-	2005.05	MT	L	F	Estate Engine AVF	GDS61157	Drive Shaft	45W	38		59.5	34.5	601		
	2000.11-	2005.05		L/R	F	Estate Engine AVF	GCI61033	Inner Joint			34		85			
2.0 (85 kW)	2000.11-	2005.05	AT		F	Estate Engine AZM	GC061012	Outer Joint	45W	33	30	53	30	62	I	
	2000.11-	2005.05	MT		F	Estate Engine AZM	GC083018	Outer Joint	45W	33	30	53	30	62	I	
	2000.11-	2005.05	MT		F	Estate Engine AZM	GCI83001	Inner Joint			28		32			
	2000.11-	2005.05	AT	L	F	Estate Engine AZM	GDS83012	Drive Shaft	45W	33		53	30	498		
	2000.11-	2005.05	MT	L	F	Estate Engine AZM	GDS83005	Drive Shaft	45W	33		53	30	614		
	2000.11-	2005.05		L/R	F	Estate Engine AZM	GCI61033	Inner Joint			34		85			
	2000.11-	2005.05	AT	R	F	Estate Engine AZM	GDS99108	Drive Shaft	45W	33		53	30	586		
	2000.11-	2005.05	MT	R	F	Estate Engine AZM	GDS83001	Drive Shaft	45W	33		53	30	634		
	2000.11-	2005.05	MT		F	Estate Engine AZM	GC083045	Outer Joint		33	30	53	30	62	I	
2.0 (96 kW)	2001.11-	2005.05	MT		F	Estate Engine ALT	GCI83002	Inner Joint			33		32			
	2001.11-	2005.05	MT		F	Estate Engine ALT	GC061012	Outer Joint	45W	33	30	53	30	62	I	
	2001.11-	2005.05	MT	L	F	Estate Engine ALT	GDS61122	Drive Shaft	45W	33		53	30	602		
	2001.11-	2005.05	MT	R	F	Estate Engine ALT	GDS83007	Drive Shaft	45W	33		53	30	622		
2.0 4motion (85 kW)	2000.11-	2005.05	MT		F	Estate Engine AZM	GC061012	Outer Joint	45W	33	30	53	30	62	I	
2.0 TDi (100 kW)	2003.12-	2005.05			F	Estate Engine BGW	GC083019	Outer Joint	45W	38	27	59.5	34.5	63	I	
	2003.12-	2005.05		L/R	F	Estate Engine BGW	GCI61033	Inner Joint			34		85			
2.3 VR5 (125 kW)	2000.11-	2005.05	MT/AT		F	Estate Engine AZX	GC083019	Outer Joint	45W	38	27	59.5	34.5	63	I	
	2000.11-	2005.05	MT	L	F	Estate Engine AZX	GDS83008	Drive Shaft	45W	38		59.5	34.5	603		
	2000.11-	2005.05		L/R	F	Estate Engine AZX	GCI61033	Inner Joint			34		85			
	2000.11-	2005.05	MT	R	F	Estate Engine AZX	GDS61019	Drive Shaft	45W	38		59.5	34.5	624		
2.3 VR5 4motion (125 kW)	2000.11-	2005.05	MT		F	Estate Engine AZX	GC083019	Outer Joint	45W	38	27	59.5	34.5	63	I	
	2000.11-	2005.05		L/R	F	Estate Engine AZX	GCI61033	Inner Joint			34		85			
2.5 TDi (110 kW)	2000.11-	2005.05	MT&AT		F	Estate Engine AFB/AKN	GC083019	Outer Joint	45W	38	27	59.5	34.5	63	I	
	2000.11-	2005.05	MT	L	F	Estate Engine AFB/AKN	GDS83008	Drive Shaft	45W	38		59.5	34.5	603		
	2000.11-	2005.05		L/R	F	Estate Engine AFB/AKN	GCI61033	Inner Joint			34		85			
	2000.11-	2005.05	MT	R	F	Estate Engine AFB/AKN	GDS61019	Drive Shaft	45W	38		59.5	34.5	624		
2.5 TDi (120 kW)	2003.05-	2005.05	MT		F	Estate Engine BDG	GC083019	Outer Joint	45W	38	27	59.5	34.5	63	I	
	2003.05-	2005.05	MT	L	F	Estate Engine BDG	GDS83008	Drive Shaft	45W	38		59.5	34.5	603		
	2003.05-	2005.05	MT	R	F	Estate Engine BDG	GDS61019	Drive Shaft	45W	38		59.5	34.5	624		



		TRANSM	L/R	F/R		G-AP Ref.	PRODUCT	ABS	Technical Specifications											
									YEAR	A	B	C	H	L	P					
<b>VOLKSWAGEN</b>																				
<b>PASSAT VARIANT (3B6)</b>																				
2.5 TDi 4motion (110 kW)	2000.11-	2005.05	AT		F	Estate Engine AFB/AKN	GC083020	Outer Joint	45W	38	30	59.5	34	59.5	I					
	2000.11-	2005.05	MT		F	Estate Engine AFB/AKN	GC083019	Outer Joint	45W	38	27	59.5	34.5	63	I					
	2000.11-	2005.05	MT	L	F	Estate Engine AFB/AKN	GDS83008	Drive Shaft	45W	38		59.5	34.5	603						
	2000.11-	2005.05		L/R	F	Estate Engine AFB/AKN	GCI61033	Inner Joint			34		85							
	2000.11-	2005.05	MT	R	F	Estate Engine AFB/AKN	GDS61019	Drive Shaft	45W	38		59.5	34.5	624						
	2000.11-	2005.05	AT			Estate Engine AFB/AKN	GC083049	Outer Joint		38	30	59.5	34	59.5	I					
2.5 TDi 4motion (132 kW)	2003.01-	2005.05	AT		F	Estate Engine BAU/BDH	GC083019	Outer Joint	45W	38	27	59.5	34.5	63	I					
	2003.01-	2005.05	MT	L	F	Estate Engine BAU/BDH	GDS83008	Drive Shaft	45W	38		59.5	34.5	603						
	2003.01-	2005.05		L/R	F	Estate Engine BAU/BDH	GCI61033	Inner Joint			34		85							
2.8 4motion (142 kW)	2000.11-	2005.05	MT		F	Estate Engine AMX/ATQ	GC083019	Outer Joint	45W	38	27	59.5	34.5	63	I					
	2000.11-	2005.05		L/R	F	Estate Engine AMX/ATQ	GCI61033	Inner Joint			34		85							
	2000.11-	2005.05	MT	R	F	Estate Engine AMX/ATQ	GDS83362	Drive Shaft	45W	38		59.5	34	621						
4.0 W8 4motion (202 kW)	2001.09-	2004.09	AT		F	Estate Engine BDN/BDP	GC083019	Outer Joint	45W	38	27	59.5	34.5	63	I					
<b>PASSAT VARIANT (3C5)</b>																				
1.4 TSi (90 kW)	2007.05-	2010.11	MT		F	Estate Engine CAXA	GCI83011	Inner Joint			33		34							
	2007.05-	2010.11	Semi-AT		F	Estate Engine CAXA	GC083002	Outer Joint		36	27	59.5	40	66	I					
	2007.05-	2010.11	AT	L	F	Estate Engine CAXA	GDS61201	Drive Shaft		36		59.5	40.5	535						
	2007.05-	2010.11	MT	L	F	Estate Engine CAXA	GDS61198	Drive Shaft		36		59.5	40.5	530						
	2007.05-	2010.11				Estate Engine CAXA	GC083100	Outer Joint		36	33	59.5	38	55	I					
1.4 TSi EcoFuel (110 kW)	2009.01-	2010.11	MT		F	Estate Engine CDGA	GCI53002	Inner Joint			33		34							
	2009.01-	2010.11	AT	L	F	Estate Engine CDGA	GDS61281	Drive Shaft		36		59.5	40	528						
	2009.01-	2010.11	MT	L	F	Estate Engine CDGA	GDS61201	Drive Shaft		36		59.5	40.5	535						
1.6 (75 kW)	2005.08-	2010.11			F	Estate Engine BSE/BSF	GCI83011	Inner Joint			33		34							
	2005.08-	2010.11	6AT		F	Estate Engine BSE/BSF	GCI61011	Inner Joint		26	32	31	68.5	85						
	2005.08-	2010.11	MT		F	Estate Engine BSE/BSF	GCI53002	Inner Joint			33		34							
	2005.08-	2010.11	6AT	L	F	Estate Engine BSE/BSF	GDS61093	Drive Shaft		36	26	59.5	40.5	587.5						
	2005.08-	2010.11		L	F	Estate Engine BSE/BSF	GDS83373	Drive Shaft		36		59.5	38	511						
	2005.08-	2010.11		R	F	Estate Engine BSE/BSF	GDS61113	Drive Shaft		36		59.5	40	814						
1.6 FSi (85 kW)	2005.08-	2008.06			F	Estate Engine BLF	GDS61094	Drive Shaft		36	26	59.5	40.5	884						
	2005.08-	2008.06	6AT	R	F	Estate Engine BLF	GC083037	Outer Joint		36	30	59.5	40.5	55	I					
	2005.08-	2008.06	MT		F	Estate Engine BLF	GCI53002	Inner Joint			33		34							
1.6 TDi (77 kW)	2009.08-	2010.11			R	F	Estate Engine CAYC	GDS61200	Drive Shaft		36		59.5	40.5	820					
	2009.08-	2010.11			F	Estate Engine CAYC	GC083100	Outer Joint		36	33	59.5	38	55	I					
1.8 TSi (118 kW)	2007.05-	2011.10	MT		F	Estate Engine BZB/CDA	GC083002	Outer Joint		36	27	59.5	40	66	I					
	2007.05-	2011.10	7AT	L	F	Estate Engine BZB/CDA	GDS83236	Drive Shaft		36		59.5	40	484						
	2007.05-	2011.10	MT	L	F	Estate Engine BZB/CDA	GDS61131	Drive Shaft		36		59.5	40	515						
1.9 TDi (77 kW)	2005.08-	2008.11			F	Estate Engine BKC/BLS/BXE	GC083037	Outer Joint		36	30	59.5	40.5	55	I					
	2005.08-	2008.11			F	Estate Engine BKC/BLS/BXE	GCI83011	Inner Joint			33		34							
	2005.08-	2008.11	MT		F	Estate Engine BKC/BLS/BXE	GCI53002	Inner Joint			33		34							
	2005.08-	2008.11	AT	L	F	Estate Engine BKC/BLS/BXE	GDS83241	Drive Shaft		36		59.5	40	475						
	2005.08-	2008.11	AT	L	F	Estate Engine BKC/BLS/BXE	GDS54013	Drive Shaft		36		59.5	40	479.5						
	2005.08-	2008.11	MT	L	F	Estate Engine BKC/BLS/BXE	GDS61089	Drive Shaft		36		59.5	40.5	521						
	2005.08-	2008.11	AT	L/R	F	Estate Engine BKC/BLS/BXE	GCI61057	Inner Joint			34		86							
	2005.08-	2008.11		R	F	Estate Engine BKC/BLS/BXE	GDS61042	Drive Shaft		36		59.5	40.5	814						
	2005.08-	2008.11	AT	R	F	Estate Engine BKC/BLS/BXE	GDS54011	Drive Shaft		36		59.5	40	755						
2.0 BlueTDi (105 kW)	2009.01-				F	Estate Engine CBAC	GC083002	Outer Joint		36	27	59.5	40	66	I					
	2009.01-		AT	L	F	Estate Engine CBAC	GDS54013	Drive Shaft		36		59.5	40	479.5						
	2009.01-		MT	L	F	Estate Engine CBAC	GDS83295	Drive Shaft		36		59.5	40	491						
	2009.01-		AT	R	F	Estate Engine CBAC	GDS54011	Drive Shaft		36		59.5	40	755						
	2009.01-		MT	R	F	Estate Engine CBAC	GDS83313	Drive Shaft		36		59.5	40	792						
	2009.01-		AT	L	F	Estate Engine CBAC	GDS83241	Drive Shaft		36		59.5	40	475						
	2009.01-		MT	L	F	Estate Engine CBAC	GDS83236	Drive Shaft		36		59.5	40	484						
	2009.01-		AT	R	F	Estate Engine CBAC	GDS83355	Drive Shaft		36	23	59.5	40	799						
	2009.01-		MT	R	F	Estate Engine CBAC	GDS61126	Drive Shaft		36		59.5	40	793						
2.0 FSi (110 kW)	2005.08-	2010.11			F	Estate Engine BLR/BLY/BVY/BVZ	GC083037	Outer Joint		36	30	59.5	40.5	55	I					
	2005.08-	2010.11	6AT		F	Estate Engine BLR/BLY/BVY/BVZ	GCI61011	Inner Joint		26	32	31	68.5	85						
	2005.08-	2010.11	MT		F	Estate Engine BLR/BLY/BVY/BVZ	GCI83011	Inner Joint			33		34							
	2005.08-	2010.11	6AT	L	F	Estate Engine BLR/BLY/BVY/BVZ	GDS61093	Drive Shaft		36	26	59.5	40.5	587.5						
	2005.08-	2010.11	MT	L	F	Estate Engine BLR/BLY/BVY/BVZ	GDS61089	Drive Shaft		36		59.5	40.5	521						
	2005.08-	2010.11	6AT	R	F	Estate Engine BLR/BLY/BVY/BVZ	GDS61094	Drive Shaft		36	26	59.5	40.5	884						

		TRANSM	L/R	F/R		G-AP Ref.	PRODUCT	ABS	Technical Specifications									
									YEAR	A	B	C	H	L	P			
<b>VOLKSWAGEN</b>																		
<b>PASSAT VARIANT (3C5)</b>																		
2.0 FSi (147 kW)	2005.08-	2010.11	6MT		F	Estate Engine AXB/BPY/BWA/CAWB/CBFA/CCTA/CCZA	GC083002	Outer Joint		36	27	59.5	40	66	I			
	2005.08-	2010.11	MT	L	F	Estate Engine AXB/BPY/BWA/CAWB/CBFA/CCTA/CCZA	GDS83236	Drive Shaft		36		59.5	40	484				
	2005.08-	2010.11	MT	L	F	Estate Engine AXB/BPY/BWA/CAWB/CBFA/CCTA/CCZA	GDS83295	Drive Shaft		36		59.5	40	491				
	2005.08-	2010.11	MT	R	F	Estate Engine AXB/BPY/BWA/CAWB/CBFA/CCTA/CCZA	GDS61126	Drive Shaft		36		59.5	40	793				
2.0 FSi 4motion (110 kW)	2005.09-	2010.11				Estate Engine BLX/BLY/BVX	GC083037	Outer Joint		36	30	59.5	40.5	55	I			
	2005.09-	2010.11	6AT			Estate Engine BLX/BLY/BVX	GCI61011	Inner Joint		26	32	31	68.5	85				
	2005.09-	2010.11		L		Estate Engine BLX/BLY/BVX	GDS83294	Drive Shaft		36		59.5	38	519				
	2005.09-	2010.11	6AT	L	F	Estate Engine BLX/BLY/BVX	GDS61093	Drive Shaft		36	26	59.5	40.5	587.5				
	2005.09-	2010.11	MT	L	F	Estate Engine BLX/BLY/BVX	GDS61089	Drive Shaft		36		59.5	40.5	521				
	2005.09-	2010.11	6AT	R	F	Estate Engine BLX/BLY/BVX	GDS61094	Drive Shaft		36	26	59.5	40.5	884				
	2005.09-	2010.11			F/R	Estate Engine BLX/BLY/BVX	GCI83011	Inner Joint			33		34					
	2005.09-	2010.11	MT		R	Estate Engine BLX/BLY/BVX	GCI53002	Inner Joint			33		34					
2.0 TDi (100 kW)	2005.08-	2010.11	6AT		F	Estate Engine BMA/CBAA	GCI54004	Inner Joint			34		85					
	2005.08-	2010.11	6MT/6AT		F	Estate Engine BMA/CBAA	GC083002	Outer Joint		36	27	59.5	40	66	I			
	2005.08-	2010.11	AT	L	F	Estate Engine BMA/CBAA	GDS54013	Drive Shaft		36		59.5	40	479.5				
	2005.08-	2010.11	MT	L	F	Estate Engine BMA/CBAA	GCI83016	Inner Joint			28		32					
	2005.08-	2010.11	MT	L	F	Estate Engine BMA/CBAA	GDS83265	Drive Shaft		36		59.5	40	487				
	2005.08-	2010.11	MT	L	F	Estate Engine BMA/CBAA	GDS83295	Drive Shaft		36		59.5	40	491				
	2005.08-	2010.11		L	F	Estate Engine BMA/CBAA	GDS83236	Drive Shaft		36		59.5	40	484				
	2005.08-	2010.11	AT	L/R	F	Estate Engine BMA/CBAA	GCI61057	Inner Joint			34		86					
	2005.08-	2010.11	AT	R	F	Estate Engine BMA/CBAA	GDS83355	Drive Shaft		36	23	59.5	40	799				
	2005.08-	2010.11	AT	R	F	Estate Engine BMA/CBAA	GDS54011	Drive Shaft		36		59.5	40	755				
	2005.08-	2010.11	MT	R	F	Estate Engine BMA/CBAA	GDS83313	Drive Shaft		36		59.5	40	792				
	2005.08-	2010.11		R	F	Estate Engine BMA/CBAA	GDS61126	Drive Shaft		36		59.5	40	793				
	2.0 TDi (103 kW)	2005.08-		6AT		F	Estate Engine BMP	GCI54004	Inner Joint			34		85				
		2005.08-		6MT/6AT		F	Estate Engine BMP	GC083002	Outer Joint		36	27	59.5	40	66	I		
2005.08-			AT	L	F	Estate Engine BMP	GDS54013	Drive Shaft		36		59.5	40	479.5				
2005.08-			MT	L	F	Estate Engine BMP	GDS83265	Drive Shaft		36		59.5	40	487				
2005.08-			MT	L	F	Estate Engine BMP	GDS83295	Drive Shaft		36		59.5	40	491				
2005.08-			AT	R	F	Estate Engine BMP	GDS54011	Drive Shaft		36		59.5	40	755				
2005.08-			MT	R	F	Estate Engine BMP	GDS83313	Drive Shaft		36		59.5	40	792				
2005.08-			AT	L	F	Estate Engine BMP	GDS83241	Drive Shaft		36		59.5	40	475				
2005.08-			MT	L	F	Estate Engine BMP	GCI83016	Inner Joint			28		32					
2005.08-				L	F	Estate Engine BMP	GDS83236	Drive Shaft		36		59.5	40	484				
2005.08-			AT	L/R	F	Estate Engine BMP	GCI61057	Inner Joint			34		86					
2005.08-			AT	R	F	Estate Engine BMP	GDS83355	Drive Shaft		36	23	59.5	40	799				
2005.08-				R	F	Estate Engine BMP	GDS61126	Drive Shaft		36		59.5	40	793				
2.0 TDi (125 kW)		2005.08-		6MT/6AT		F	Estate Engine BMR/CBBB	GC061045	Outer Joint		36	27	59.5	40	65	M		
	2005.08-		AT	L	F	Estate Engine BMR/CBBB	GDS83241	Drive Shaft		36		59.5	40	475				
	2005.08-		MT	L	F	Estate Engine BMR/CBBB	GDS83236	Drive Shaft		36		59.5	40	484				
	2005.08-		MT	R	F	Estate Engine BMR/CBBB	GDS61126	Drive Shaft		36		59.5	40	793				
2.0 TDi (81 kW)	2008.11-	2010.11			F	Estate Engine CBDC	GCI83011	Inner Joint			33		34					
	2008.11-	2010.11			F	Estate Engine CBDC	GC083002	Outer Joint		36	27	59.5	40	66	I			
	2008.11-	2010.11	MT		F	Estate Engine CBDC	GCI53002	Inner Joint			33		34					
	2008.11-	2010.11	MT	R	F	Estate Engine CBDC	GDS61200	Drive Shaft		36		59.5	40.5	820				
	2008.11-	2010.11				Estate Engine CBDC	GC083100	Outer Joint		36	33	59.5	38	55	I			
2.0 TDi (88 kW)	2005.11-	2007.05	AT	L	F	Estate Engine BWV	GDS54013	Drive Shaft		36		59.5	40	479.5				
	2005.11-	2007.05	MT	L	F	Estate Engine BWV	GDS83295	Drive Shaft		36		59.5	40	491				
	2005.11-	2007.05		L	F	Estate Engine BWV	GDS83236	Drive Shaft		36		59.5	40	484				
	2005.11-	2007.05	AT	L/R	F	Estate Engine BWV	GCI61057	Inner Joint			34		86					
	2005.11-	2007.05	AT	R	F	Estate Engine BWV	GDS83355	Drive Shaft		36	23	59.5	40	799				
	2005.11-	2007.05	AT	R	F	Estate Engine BWV	GDS54011	Drive Shaft		36		59.5	40	755				
	2005.11-	2007.05	MT	R	F	Estate Engine BWV	GDS83313	Drive Shaft		36		59.5	40	792				
	2005.11-	2007.05		R	F	Estate Engine BWV	GDS61126	Drive Shaft		36		59.5	40	793				
2.0 TDi (90 kW)	2005.08-	2006.02	6AT		F	Estate Engine BVE	GCI54004	Inner Joint			34		85					
	2005.08-	2006.02	6MT/6AT		F	Estate Engine BVE	GC083002	Outer Joint		36	27	59.5	40	66	I			
	2005.08-	2006.02	AT	L	F	Estate Engine BVE	GDS54013	Drive Shaft		36		59.5	40	479.5				
	2005.08-	2006.02	MT	L	F	Estate Engine BVE	GDS83295	Drive Shaft		36		59.5	40	491				
	2005.08-	2006.02	AT	L/R	F	Estate Engine BVE	GCI61057	Inner Joint			34		86					
	2005.08-	2006.02	AT	R	F	Estate Engine BVE	GDS83355	Drive Shaft		36	23	59.5	40	799				
	2005.08-	2006.02	AT	R	F	Estate Engine BVE	GDS54011	Drive Shaft		36		59.5	40	755				









		TRANSM	L/R	F/R		G-AP Ref.	PRODUCT	ABS	Technical Specifications											
									YEAR	A	B	C	H	L	P					
<b>VOLKSWAGEN</b>																				
<b>PASSAT VARIANT (3C5)</b>																				
2.0 TDi (90 kW)	2005.08-	2006.02	MT	R	F	Estate Engine BVE	GDS83313	Drive Shaft	36		59.5	40	792							
2.0 TDi 16V (103 kW)	2005.08-		6AT		F	Estate Engine BKP/CBAB	GCI54004	Inner Joint		34		85								
	2005.08-		6MT/6AT		F	Estate Engine BKP/CBAB	GC083002	Outer Joint	36	27	59.5	40	66	I						
	2005.08-		AT	L	F	Estate Engine BKP/CBAB	GDS54013	Drive Shaft	36		59.5	40	479.5							
	2005.08-		MT	L	F	Estate Engine BKP/CBAB	GDS83265	Drive Shaft	36		59.5	40	487							
	2005.08-		MT	L	F	Estate Engine BKP/CBAB	GDS83295	Drive Shaft	36		59.5	40	491							
	2005.08-		AT	R	F	Estate Engine BKP/CBAB	GDS54011	Drive Shaft	36		59.5	40	755							
	2005.08-		MT	R	F	Estate Engine BKP/CBAB	GDS83313	Drive Shaft	36		59.5	40	792							
	2005.08-		AT	L	F	Estate Engine BKP/CBAB	GDS83241	Drive Shaft	36		59.5	40	475							
	2005.08-		MT	L	F	Estate Engine BKP/CBAB	GCI83016	Inner Joint		28		32								
	2005.08-			L	F	Estate Engine BKP/CBAB	GDS83236	Drive Shaft	36		59.5	40	484							
	2005.08-		AT	L/R	F	Estate Engine BKP/CBAB	GCI61057	Inner Joint		34		86								
	2005.08-			R	F	Estate Engine BKP/CBAB	GDS61126	Drive Shaft	36		59.5	40	793							
2.0 TDi 16V 4motion (103 kW)	2005.08-		6AT			Estate Engine BKP/CBAB	GCI54004	Inner Joint		34		85								
	2005.08-		MT	L		Estate Engine BKP/CBAB	GDS83295	Drive Shaft	36		59.5	40	491							
	2005.08-			R		Estate Engine BKP/CBAB	GDS83266	Drive Shaft	36		59.5	40	601							
	2005.08-		6MT/6AT		F	Estate Engine BKP/CBAB	GC083002	Outer Joint	36	27	59.5	40	66	I						
	2005.08-			R		Estate Engine BKP/CBAB	GCI83011	Inner Joint		33		34								
	2005.08-		MT		R	Estate Engine BKP/CBAB	GCI53002	Inner Joint		33		34								
	2005.08-		MT	L	F	Estate Engine BKP/CBAB	GDS83236	Drive Shaft	36		59.5	40	484							
	2005.08-		AT	R	F	Estate Engine BKP/CBAB	GDS83355	Drive Shaft	36	23	59.5	40	799							
	2005.08-		MT	L	R	Estate Engine BKP/CBAB	GDS61284	Drive Shaft	36		59.5	79	594							
	2005.08-		MT	R	R	Estate Engine BKP/CBAB	GDS61293	Drive Shaft	36		59.5	40	631							
	2005.08-			R		Estate Engine BKP/CBAB	GCI83016	Inner Joint		28		32								
	2.0 TDi 4motion (103 kW)	2005.08-		6AT			Estate Engine BMP	GCI54004	Inner Joint		34		85							
2005.08-				L		Estate Engine BMP	GDS83295	Drive Shaft	36		59.5	40	491							
2005.08-			MT	R		Estate Engine BMP	GDS83266	Drive Shaft	36		59.5	40	601							
2005.08-			6MT/6AT		F	Estate Engine BMP	GC083002	Outer Joint	36	27	59.5	40	66	I						
2005.08-				R		Estate Engine BMP	GCI83011	Inner Joint		33		34								
2005.08-			MT		R	Estate Engine BMP	GCI53002	Inner Joint		33		34								
2005.08-			AT	L	F	Estate Engine BMP	GDS83241	Drive Shaft	36		59.5	40	475							
2005.08-			MT	L	F	Estate Engine BMP	GDS83236	Drive Shaft	36		59.5	40	484							
2005.08-			MT	L	R	Estate Engine BMP	GDS61284	Drive Shaft	36		59.5	79	594							
2005.08-			MT	R	R	Estate Engine BMP	GDS61293	Drive Shaft	36		59.5	40	631							
2005.08-			MT	R		Estate Engine BMP	GCI83016	Inner Joint		28		32								
2.0 TDi 4motion (125 kW)		2009.05-		MT	R	R	Estate Engine CBBB	GDS61293	Drive Shaft	36		59.5	40	631						
	2009.05-			L		Estate Engine CBBB	GDS54013	Drive Shaft	36		59.5	40	479.5							
	2009.05-		MT		R	Estate Engine CBBB	GCI53002	Inner Joint		33		34								
	2009.05-		AT	L	F	Estate Engine CBBB	GDS83241	Drive Shaft	36		59.5	40	475							
	2009.05-		MT	L	R	Estate Engine CBBB	GDS61284	Drive Shaft	36		59.5	79	594							
3.2 FSi 4motion (184 kW)	2005.11-	2007.11		L		Estate Engine AXZ	GDS54013	Drive Shaft	36		59.5	40	479.5							
	2005.11-	2007.11		L		Estate Engine AXZ	GDS83295	Drive Shaft	36		59.5	40	491							
	2005.11-	2007.11	MT	R		Estate Engine AXZ	GDS83266	Drive Shaft	36		59.5	40	601							
	2005.11-	2007.11	6AT		F	Estate Engine AXZ	GC083002	Outer Joint	36	27	59.5	40	66	I						
	2005.11-	2007.11	AT	L	F	Estate Engine AXZ	GDS83236	Drive Shaft	36		59.5	40	484							
	2005.11-	2007.11	AT	L	F	Estate Engine AXZ	GDS83241	Drive Shaft	36		59.5	40	475							
	2005.11-	2007.11	MT/AT	L/R	F	Estate Engine AXZ	GCI61057	Inner Joint		34		86								
	2005.11-	2007.11		R		Estate Engine AXZ	GCI83011	Inner Joint		33		34								
	2005.11-	2007.11	MT		R	Estate Engine AXZ	GCI53002	Inner Joint		33		34								
	2005.11-	2007.11	MT	R		Estate Engine AXZ	GCI83016	Inner Joint		28		32								
3.6 R36 4motion (220 kW)	2007.04-	2010.11	MT			Estate Engine BWS	GCI53002	Inner Joint		33		34								
	2007.04-	2010.11	AT	L	F	Estate Engine BWS	GDS83236	Drive Shaft	36		59.5	40	484							
	2007.04-	2010.11			R	Estate Engine BWS	GCI83011	Inner Joint		33		34								
<b>PASSAT VI (3C2, 3C5)</b>																				
1.4 FSi (90 kW)	2007.05-	2010					GC083037	Outer Joint	36	30	59.5	40.5	55	I						
1.4 TSi (110 kW)	2009.01-	2010.11	MT				GC083037	Outer Joint	36	30	59.5	40.5	55	I						
1.6 (75 kW)	2005.07-	2010.11	MT				GC083037	Outer Joint	36	30	59.5	40.5	55	I						
1.6 FSi (85 kW)	2005.03-	2010.11					GC083037	Outer Joint	36	30	59.5	40.5	55	I						
1.6 TDi (77 kW)		2009.10					GC083002	Outer Joint	36	27	59.5	40	66	I						
1.8 TFSi (118 kW)	2007.05-	2009.11	MT				GCI83016	Inner Joint		28		32								
	2007.05-	2009.11	MT/AT				GC083002	Outer Joint	36	27	59.5	40	66	I						



		TRANSM	L/R	F/R		G-AP Ref.	PRODUCT	ABS	Technical Specifications								
									YEAR	A	B	C	H	L	P		
<b>VOLKSWAGEN</b>																	
<b>PASSAT VI (3C2, 3C5)</b>																	
1.9 TDi (77 kW)	2005.03-	2011.10				GC083037	Outer Joint		36	30	59.5	40.5	55	I			
2.0 FSi (110 kW)	2005.03-	2011.10	MT/AT			GC083037	Outer Joint		36	30	59.5	40.5	55	I			
2.0 FSi 4motion (110 kW)	2005.03-	2011.10	MT/AT			GC083037	Outer Joint		36	30	59.5	40.5	55	I			
2.0 TDi (100 kW)	2005.03-	2010.11	MT			GCI83016	Inner Joint			28		32					
	2005.03-	2010.11	MT/AT			GC083002	Outer Joint		36	27	59.5	40	66	I			
2.0 TDi (103 kW)	2005.03-	2010.11	MT			GCI83016	Inner Joint			28		32					
	2005.03-	2010.11	MT/AT			GC083002	Outer Joint		36	27	59.5	40	66	I			
2.0 TDi (105 kW)	2005.03-	2010.11	MT			GCI83016	Inner Joint			28		32					
	2005.03-	2010.11	MT/AT			GC083002	Outer Joint		36	27	59.5	40	66	I			
2.0 TDi (81 kW)	2005.03-	2010.11	MT/AT			GC083002	Outer Joint		36	27	59.5	40	66	I			
2.0 TDi (90 kW)	2005.03-	2010.11	MT			GCI83016	Inner Joint			28		32					
	2005.03-	2010.11	MT/AT			GC083002	Outer Joint		36	27	59.5	40	66	I			
2.0 TDi 4motion (103 kW)	2005.03-	2010.11				GCI83016	Inner Joint			28		32					
	2005.03-	2010.11				GC083002	Outer Joint		36	27	59.5	40	66	I			
2.0 TFSi (125 kW)	2008.05-	2009.05				GC083002	Outer Joint		36	27	59.5	40	66	I			
2.0 TFSi (147 kW)	2008.05-	2009.05				GC083002	Outer Joint		36	27	59.5	40	66	I			
3.2 FSi (184 kW)	2005.11-	2010.11				GC083002	Outer Joint		36	27	59.5	40	66	I			
3.2 FSi 4motion (184 kW)	2005.11-	2010.11				GC083002	Outer Joint		36	27	59.5	40	66	I			
<b>PASSAT VII (357),CC</b>																	
1.8 TSi (112 kW)	2008.06-		MT			GC083002	Outer Joint		36	27	59.5	40	66	I			
	2008.06-		MT		Double Clutch	GCI83016	Inner Joint			28		32					
1.8 TSi (118 kW)	2008.06-		MT			GC083002	Outer Joint		36	27	59.5	40	66	I			
	2008.06-		MT		Double Clutch	GCI83016	Inner Joint			28		32					
2.0 FSi (147 kW)	2009.11-		MT			GCI83016	Inner Joint			28		32					
	2009.11-		MT			GC083002	Outer Joint		36	27	59.5	40	66	I			
	2009.11-		MT			GCI83016	Inner Joint			28		32					
2.0 TDi (100 kW)	2008.06-					GC083002	Outer Joint		36	27	59.5	40	66	I			
2.0 TDi (103 kW)	2008.06-					GCI83016	Inner Joint			28		32					
	2008.06-					GC083002	Outer Joint		36	27	59.5	40	66	I			
2.0 TDi (105 kW)	2008.06-					GC083002	Outer Joint		36	27	59.5	40	66	I			
2.0 TDi 4motion (103 kW)	2009.05-					GCI83016	Inner Joint			28		32					
	2009.05-					GC083002	Outer Joint		36	27	59.5	40	66	I			
2.0 TDi 4motion (125 kW)	2009.11-					GC083002	Outer Joint		36	27	59.5	40	66	I			
2.0 TFSi (147 kW)	2008.06-		MT			GCI83016	Inner Joint			28		32					
	2010-		MT			GC083002	Outer Joint		36	27	59.5	40	66	I			
2.0 TFSi (155 kW)	2008.06-		MT			GCI83016	Inner Joint			28		32					
	2010-		MT			GC083002	Outer Joint		36	27	59.5	40	66	I			
<b>PASSAT VII (362, 365)</b>																	
1.4 TSi (110 kW)	2010-		MT			GC083037	Outer Joint		36	30	59.5	40.5	55	I			
	2010-				Double Clutch	GCI83016	Inner Joint			28		32					
	2010-				Double Clutch	GC083002	Outer Joint		36	27	59.5	40	66	I			
1.4 TSi (118 kW)	2010-		MT			GC083037	Outer Joint		36	30	59.5	40.5	55	I			
	2010-				Double Clutch	GCI83016	Inner Joint			28		32					
	2010-				Double Clutch	GC083002	Outer Joint		36	27	59.5	40	66	I			
1.8 TSi (112 kW)	2011-					GC083002	Outer Joint		36	27	59.5	40	66	I			
1.8 TSi (118 kW)	2011-					GC083002	Outer Joint		36	27	59.5	40	66	I			
1.8 TSi(112 kW)	2011-					GCI83016	Inner Joint			28		32					
1.8 TSi(118 kW)	2011-					GCI83016	Inner Joint			28		32					
2.0 TDi (100 kW)	2010-		MT			GC083002	Outer Joint		36	27	59.5	40	66	I			
	2010-		MT			GCI83016	Inner Joint			28		32					
2.0 TDi (103 kW)	2010-		MT			GC083002	Outer Joint		36	27	59.5	40	66	I			
	2010-					GCI83016	Inner Joint			28		32					
2.0 TDi 4motion (103 kW)	2011-					GC083002	Outer Joint		36	27	59.5	40	66	I			
	2011-					GCI83016	Inner Joint			28		32					
2.0 TDi 4motion (125 kW)	2011-					GC083002	Outer Joint		36	27	59.5	40	66	I			
3.6 FSi 4motion (220 kW)	2011.01-					GCI83016	Inner Joint			28		32					
<b>PHAETON (3D_)</b>																	
3.0 V6 TDi 4motion (165 kW)	2004.10-	2008.04			Saloon Engine BMK	GC083099	Outer Joint		38	27	59.5	34.5	64	M			
3.0 V6 TDi 4motion (171 kW)	2007.06-				Saloon Engine CARA	GC083099	Outer Joint		38	27	59.5	34.5	64	M			
3.0 V6 TDi 4motion (176 kW)	2008.11-				Saloon Engine CARB/CEXA	GC083099	Outer Joint		38	27	59.5	34.5	64	M			
4.2 V8 4motion (246 kW)	2003.12-	2008.04			Saloon Engine BGH/BGJ	GC083099	Outer Joint		38	27	59.5	34.5	64	M			

		TRANSM	L/R	F/R		G-AP Ref.	PRODUCT	ABS	Technical Specifications							
									YEAR	A	B	C	H	L	P	
<b>VOLKSWAGEN POINTER</b>																
1.8	1993.01-	1996.12	MT			GC018100	Outer Joint		25	30	56.5	89	56.5	I		
2	1993.01-	1996.12	MT			GC018100	Outer Joint		25	30	56.5	89	56.5	I		
<b>POLO</b>																
1.4			AT	L		GDS61022	Drive Shaft		36		52	75	513			
			AT	R		GDS61023	Drive Shaft		36		52	75	747			
1.6			AT	L		GDS61024	Drive Shaft		36		52	75	517.5			
			AT	R		GDS61025	Drive Shaft		36		52	75	773.5			
1.6 8V (EA111)	2003.01-	2011.06	MT			GC061037	Outer Joint		22	30	51	78	61	I		
1.6/2.0 8V	2003.01-	2011.12				GC054003	Outer Joint		36	30	52	75	56	I		
2.0 8V	2003.01-	2011.06	MT			GC061037	Outer Joint		22	30	51	78	61	I		
<b>POLO (6KV2)</b>																
1.9 SDi (50 kW)	1999.08-	2002.01			F	Saloon Engine AGP/AQM	GC053008	Outer Joint	22	30	53	78.5	51	I		
	1999.08-	2002.01	MT		F	Saloon Engine AGP/AQM	GCI83008	Inner Joint		33		32				
1.9 TDi (81 kW)	1998.06-	2002.01			F	Saloon Engine AFN/ASV	GCI83011	Inner Joint		33		34				
	1998.06-	2002.01	MT		F	Saloon Engine AFN/ASV	GC053007	Outer Joint	22	30	53.2	78	61	I		
<b>POLO (6N1)</b>																
1.0 (33 kW)	1994.10-	1996.09	MT	L	F	Hatchback Engine AEV	GDS61007	Drive Shaft	22		53	78.5	517			
	1994.10-	1996.09	MT	R	F	Hatchback Engine AEV	GDS61010	Drive Shaft	22		53	78.5	740			
1.0 (37 kW)	1996.09-	1999.10	MT	L	F	Hatchback Engine AER/ALL	GDS61007	Drive Shaft	22		53	78.5	517			
	1996.09-	1999.10	MT	R	F	Hatchback Engine AER/ALL	GDS61010	Drive Shaft	22		53	78.5	740			
1.3 (40 kW)	1994.10-	1995.07	MT	L	F	Hatchback Engine ADX	GDS61007	Drive Shaft	22		53	78.5	517			
	1994.10-	1995.07	MT	R	F	Hatchback Engine ADX	GDS61010	Drive Shaft	22		53	78.5	740			
1.4 (40 kW)	1995.08-	1999.10	MT	L	F	Hatchback Engine AEX	GDS61007	Drive Shaft	22		53	78.5	517			
	1995.08-	1999.10	MT	R	F	Hatchback Engine AEX	GDS61010	Drive Shaft	22		53	78.5	740			
1.4 (44 kW)	1995.07-	1999.10	MT	L	F	Hatchback Engine AEX/AKV/APQ	GDS61007	Drive Shaft	22		53	78.5	517			
	1995.07-	1999.10	MT	R	F	Hatchback Engine AEX/AKV/APQ	GDS61010	Drive Shaft	22		53	78.5	740			
1.4 16V (74 kW)	1996.04-	1999.10		L	F	Hatchback Engine AFH	GDS61007	Drive Shaft	22		53	78.5	517			
	1996.04-	1999.10		R	F	Hatchback Engine AFH	GDS61010	Drive Shaft	22		53	78.5	740			
1.6 (55 kW)	1994.10-	1999.10	MT	L	F	Hatchback Engine AEA/AEE	GDS61007	Drive Shaft	22		53	78.5	517			
	1994.10-	1999.10	MT	R	F	Hatchback Engine AEA/AEE	GDS61010	Drive Shaft	22		53	78.5	740			
1.7 SDi (42 kW)	1997.04-	1999.10	MT	L	F	Hatchback Engine AHG	GDS61007	Drive Shaft	22		53	78.5	517			
	1997.04-	1999.10	MT	R	F	Hatchback Engine AHG	GDS61010	Drive Shaft	22		53	78.5	740			
1.7 SDi (44 kW)	1997.08-	1999.10	MT	L	F	Hatchback Engine AKU	GDS61007	Drive Shaft	22		53	78.5	517			
	1997.08-	1999.10	MT	R	F	Hatchback Engine AKU	GDS61010	Drive Shaft	22		53	78.5	740			
1.9 D (47 kW)	1994.10-	1999.10	MT	L	F	Hatchback Engine AEF	GDS61007	Drive Shaft	22		53	78.5	517			
	1994.10-	1999.10	MT	R	F	Hatchback Engine AEF	GDS61010	Drive Shaft	22		53	78.5	740			
1.9 SDi (47 kW)	1996.07-	1999.10	MT	L	F	Hatchback Engine AGD	GDS61007	Drive Shaft	22		53	78.5	517			
	1996.07-	1999.10	MT	R	F	Hatchback Engine AGD	GDS61010	Drive Shaft	22		53	78.5	740			
<b>POLO (6N2)</b>																
1.0 (37 kW)	1999.10-	2001.09	MT	L	F	Hatchback Engine ALD/AUC	GDS61205	Drive Shaft	22		53	78.5	525			
	1999.10-	2001.09		L	F	Hatchback Engine ALD/AUC	GDS61007	Drive Shaft	22		53	78.5	517			
	1999.10-	2001.09		R	F	Hatchback Engine ALD/AUC	GDS61010	Drive Shaft	22		53	78.5	740			
1.4 (40 kW)	1999.10-	2001.09	MT	L	F	Hatchback Engine AKP/ANX	GDS61205	Drive Shaft	22		53	78.5	525			
	1999.10-	2001.09	MT	L	F	Hatchback Engine AKP/ANX	GDS61007	Drive Shaft	22		53	78.5	517			
	1999.10-	2001.09	MT	R	F	Hatchback Engine AKP/ANX	GDS61010	Drive Shaft	22		53	78.5	740			
1.4 (44 kW)	1999.10-	2001.09	MT	L	F	Hatchback Engine AKK/AUD	GDS61007	Drive Shaft	22		53	78.5	517			
	1999.10-	2001.09	MT	R	F	Hatchback Engine AKK/AUD	GDS61010	Drive Shaft	22		53	78.5	740			
1.4 16V (74 kW)	1999.10-	2001.09		L	F	Hatchback Engine AFK/AQQ/AUB	GDS61205	Drive Shaft	22		53	78.5	525			
	1999.10-	2001.09		L	F	Hatchback Engine AFK/AQQ/AUB	GDS61007	Drive Shaft	22		53	78.5	517			
	1999.10-	2001.09		R	F	Hatchback Engine AFK/AQQ/AUB	GDS61010	Drive Shaft	22		53	78.5	740			
1.9 D (47 kW)	1999.10-	2001.09	MT	L	F	Hatchback Engine AEF	GDS61205	Drive Shaft	22		53	78.5	525			
1.9 SDi (47 kW)	1999.10-	2001.09	MT	L	F	Hatchback Engine AGD/ASX	GDS61205	Drive Shaft	22		53	78.5	525			
<b>POLO (6NF)</b>																
1.0 (33 kW)	1994.10-	1999.12	MT	L	F	Box Engine AAU	GDS61007	Drive Shaft	22		53	78.5	517			
	1994.10-	1999.12	MT	R	F	Box Engine AAU	GDS61010	Drive Shaft	22		53	78.5	740			
1.4 (44 kW)	1998.05-	1999.12	MT	L	F	Box Engine AEX/APQ	GDS61007	Drive Shaft	22		53	78.5	517			
	1998.05-	1999.12	MT	R	F	Box Engine AEX/APQ	GDS61010	Drive Shaft	22		53	78.5	740			
1.7 SDi (44 kW)	1997.08-	1999.12	MT	L	F	Box Engine AKU	GDS61007	Drive Shaft	22		53	78.5	517			
	1997.08-	1999.12	MT	R	F	Box Engine AKU	GDS61010	Drive Shaft	22		53	78.5	740			
1.9 D (47 kW)	1994.10-	1999.12	MT	L	F	Box Engine AEF	GDS61007	Drive Shaft	22		53	78.5	517			
	1994.10-	1999.12	MT	R	F	Box Engine AEF	GDS61010	Drive Shaft	22		53	78.5	740			









		TRANSM	L/R	F/R		G-AP Ref.	PRODUCT	ABS	Technical Specifications									
									YEAR	A	B	C	H	L	P			
<b>VOLKSWAGEN</b>																		
<b>POLO (6NF)</b>																		
1.9 SDi (47 kW)	1996.07-	1999.12	MT	L	F	Box Engine AGD	GDS61007	Drive Shaft		22		53	78.5	517				
	1996.07-	1999.12	MT	R	F	Box Engine AGD	GDS61010	Drive Shaft		22		53	78.5	740				
<b>POLO (6R, 6C)</b>																		
1.2 (44 kW)	2009.06-			L	F	Hatchback Engine CGPB	GDS83330	Drive Shaft		36		50.7	58.5	515				
	2009.06-			R	F	Hatchback Engine CGPB	GDS61267	Drive Shaft		36		50.7	58.5	765				
1.2 (51 kW)	2009.06-			L	F	Hatchback Engine CGPA	GDS83330	Drive Shaft		36		50.7	58.5	515				
	2009.06-			R	F	Hatchback Engine CGPA	GDS61267	Drive Shaft		36		50.7	58.5	765				
1.2 TDi (55 kW)	2009.10-		MT		F	Hatchback Engine CFWA	GCI53002	Inner Joint			33		34					
	2009.10-		MT	L	F	Hatchback Engine CFWA	GDS61184	Drive Shaft		36		52	59	496				
	2009.10-		MT	L/R	F	Hatchback Engine CFWA	GC054006	Outer Joint		36	30	52	59	55.5	I			
	2009.10-			R	F	Hatchback Engine CFWA	GDS61185	Drive Shaft		36		52	59	785				
1.2 TSi (66 kW)	2011.05-			L	F	Hatchback Engine CBZC	GDS61263	Drive Shaft		36		52	59	514				
1.2 TSi (77 kW)	2009.11-		MT		F	Hatchback Engine CBZB	GCI53002	Inner Joint			33		34					
	2009.11-		MT	L	F	Hatchback Engine CBZB	GDS61263	Drive Shaft		36		52	59	514				
	2009.11-			L	F	Hatchback Engine CBZB	GDS61274	Drive Shaft		36		50.5	59	514				
1.2 TSi 16V (66 kW)	2014.02-			L	F	Hatchback Engine CJZC	GDS61263	Drive Shaft		36		52	59	514				
1.4 (63 kW)	2009.06-		AT		F	Hatchback Engine CGGB	GCI83011	Inner Joint			33		34					
	2009.06-		MT		F	Hatchback Engine CGGB	GCI53002	Inner Joint			33		34					
	2009.06-		MT	L	F	Hatchback Engine CGGB	GDS83330	Drive Shaft		36		50.7	58.5	515				
	2009.06-		MT	R	F	Hatchback Engine CGGB	GDS61267	Drive Shaft		36		50.7	58.5	765				
1.4 BiFuel (60 kW)	2010.03-	2011.01		L	F	Hatchback Engine CMAA	GDS83330	Drive Shaft		36		50.7	58.5	515				
	2010.03-	2011.01		R	F	Hatchback Engine CMAA	GDS61267	Drive Shaft		36		50.7	58.5	765				
1.4 GTi (132 kW)	2010.05-		AT	L	F	Hatchback Engine CTHE/CAVE	GDS61260	Drive Shaft		36		52	75	498				
	2010.05-		AT	R	F	Hatchback Engine CTHE/CAVE	GDS61261	Drive Shaft		36		52	75	785				
1.4 TSi (103 kW)	2012.10-		AT	L	F	Hatchback Engine CPTA	GDS61260	Drive Shaft		36		52	75	498				
	2012.10-		AT	R	F	Hatchback Engine CPTA	GDS61261	Drive Shaft		36		52	75	785				
1.4 TSi (110 kW)	2014.05-		AT	L	F	Hatchback Engine CZEA	GDS61260	Drive Shaft		36		52	75	498				
	2014.05-		AT	R	F	Hatchback Engine CZEA	GDS61261	Drive Shaft		36		52	75	785				
1.6 (81 kW)	2014.07-			L	F	Hatchback Engine CWVA	GDS61263	Drive Shaft		36		52	59	514				
1.6 BiFuel (60 kW)	2011.01-			L	F	Hatchback Engine CNKA	GDS61263	Drive Shaft		36		52	59	514				
1.6 TDi (55 kW)	2009.06-				F	Hatchback Engine CAYA	GCI83011	Inner Joint			33		34					
	2009.06-		MT		F	Hatchback Engine CAYA	GCI53002	Inner Joint			33		34					
	2009.06-		MT	L	F	Hatchback Engine CAYA	GDS61184	Drive Shaft		36		52	59	496				
	2009.06-		MT	L/R	F	Hatchback Engine CAYA	GC054006	Outer Joint		36	30	52	59	55.5	I			
	2009.06-			R	F	Hatchback Engine CAYA	GDS61185	Drive Shaft		36		52	59	785				
1.6 TDi (66 kW)	2009.06-		MT		F	Hatchback Engine CAYB	GCI83011	Inner Joint			33		34					
	2009.06-		AT	L	F	Hatchback Engine CAYB	GDS61260	Drive Shaft		36		52	75	498				
	2009.06-		MT	L	F	Hatchback Engine CAYB	GDS61184	Drive Shaft		36		52	59	496				
	2009.06-		MT	L/R	F	Hatchback Engine CAYB	GC054006	Outer Joint		36	30	52	59	55.5	I			
	2009.06-		MT	R	F	Hatchback Engine CAYB	GDS61261	Drive Shaft		36		52	75	785				
	2009.06-			R	F	Hatchback Engine CAYB	GDS61185	Drive Shaft		36		52	59	785				
1.6 TDi (77 kW)	2009.06-				F	Hatchback Engine CLNA/CAYC	GCI83011	Inner Joint			33		34					
	2009.06-		MT		F	Hatchback Engine CLNA/CAYC	GCI53002	Inner Joint			33		34					
	2009.06-		MT	L	F	Hatchback Engine CLNA/CAYC	GDS61184	Drive Shaft		36		52	59	496				
	2009.06-		MT	L/R	F	Hatchback Engine CLNA/CAYC	GC054006	Outer Joint		36	30	52	59	55.5	I			
	2009.06-			R	F	Hatchback Engine CLNA/CAYC	GDS61185	Drive Shaft		36		52	59	785				
<b>POLO (86)</b>																		
0.9 (29 kW)	1975.09-	1981.09	MT		F	Hatchback Engine HA	GC083022	Outer Joint		20	25	45.5	74	49	I			
	1975.09-	1981.09	MT		F	Hatchback Engine HA	GC061002	Outer Joint		20	30	45.5	73.5	51	I			
1.1 (37 kW)	1975.03-	1981.09	MT		F	Hatchback Engine HB	GC083022	Outer Joint		20	25	45.5	74	49	I			
1.1 (44 kW)	1975.03-	1981.09	MT		F	Hatchback Engine HC	GC083022	Outer Joint		20	25	45.5	74	49	I			
1.3 (44 kW)	1976.12-	1981.09	MT		F	Hatchback Engine HH	GC083022	Outer Joint		20	25	45.5	74	49	I			
<b>POLO (86C, 80)</b>																		
0.9 (29 kW)	1981.10-	1981.12	MT		F	Hatchback Engine HA	GC083022	Outer Joint		20	25	45.5	74	49	I			
1.0 (29 kW)	1981.10-	1986.10	MT		F	Hatchback Engine GL	GC083022	Outer Joint		20	25	45.5	74	49	I			
	1981.10-	1986.10			F	Hatchback Engine GL	GC061002	Outer Joint		20	30	45.5	73.5	51	I			
	1982.05-	1986.10	MT		F	Coupe Engine GL	GC083022	Outer Joint		20	25	45.5	74	49	I			
	1982.05-	1986.10			F	Coupe Engine GL	GC061002	Outer Joint		20	30	45.5	73.5	51	I			
	1985.01-	1986.10			F	Saloon Engine GL	GC061002	Outer Joint		20	30	45.5	73.5	51	I			
1.0 (33 kW)	1985.01-	1994.09			F	Saloon Engine AAK/AAU/HZ	GC061002	Outer Joint		20	30	45.5	73.5	51	I			
	1985.08-	1992.01			F	Hatchback Engine HZ	GC061002	Outer Joint		20	30	45.5	73.5	51	I			



		TRANSM	L/R	F/R		G-AP Ref.	PRODUCT	ABS	Technical Specifications							
									YEAR	A	B	C	H	L	P	
<b>VOLKSWAGEN</b>																
<b>POLO (86C, 80)</b>																
1.0 (33 kW)	1985.08-	1992.01			F Coupe Engine HZ	GC061002	Outer Joint		20	30	45.5	73.5	51	I		
1.0 CAT (33 kW)	1989.08-	1994.09			F Coupe Engine AAK/AAU/ACM	GC061002	Outer Joint		20	30	45.5	73.5	51	I		
	1989.08-	1994.09			F Hatchback Engine AAK/AAU/ACM	GC061002	Outer Joint		20	30	45.5	73.5	51	I		
1.1 (37 kW)	1981.10-	1983.07	MT		F Coupe Engine HB	GC083022	Outer Joint		20	25	45.5	74	49	I		
	1981.10-	1989.09	MT		F Hatchback Engine HB	GC083022	Outer Joint		20	25	45.5	74	49	I		
	1981.10-	1983.07	MT		F Coupe Engine HB	GC061002	Outer Joint		20	30	45.5	73.5	51	I		
	1981.10-	1989.09			F Hatchback Engine HB	GC061002	Outer Joint		20	30	45.5	73.5	51	I		
1.3 (44 kW)	1981.10-	1983.07	MT		F Coupe Engine HH	GC083022	Outer Joint		20	25	45.5	74	49	I		
	1981.10-	1983.07	MT		F Hatchback Engine HH	GC083022	Outer Joint		20	25	45.5	74	49	I		
1.3 (55 kW)	1982.09-	1989.09	MT		F Coupe Engine GK	GC083022	Outer Joint		20	25	45.5	74	49	I		
	1982.09-	1989.09	MT		F Hatchback Engine GK	GC083022	Outer Joint		20	25	45.5	74	49	I		
1.3 D (33 kW)	1986.08-	1990.07			F Hatchback Engine MN	GC061002	Outer Joint		20	30	45.5	73.5	51	I		
	1986.08-	1990.08			F Coupe Engine MN	GC061002	Outer Joint		20	30	45.5	73.5	51	I		
	1986.08-	1988.12			F Saloon Engine MN	GC061002	Outer Joint		20	30	45.5	73.5	51	I		
1.3 G40 (83 kW)	1990.08-	1994.09			F Coupe Engine PY	GC061002	Outer Joint		20	30	45.5	73.5	51	I		
1.3 G40 (85 kW)	1987.01-	1990.08			F Coupe Engine PY	GC061002	Outer Joint		20	30	45.5	73.5	51	I		
1.4 D (35 kW)	1990.08-	1994.09	MT		F Coupe Engine 1W	GC061002	Outer Joint		20	30	45.5	73.5	51	I		
	1990.10-	1994.09			F Hatchback Engine 1W	GC061002	Outer Joint		20	30	45.5	73.5	51	I		
	1990.10-	1994.09			F Saloon Engine 1W	GC061002	Outer Joint		20	30	45.5	73.5	51	I		
<b>POLO (9A4)</b>																
1.4 (55 kW)	2003.07-				F Saloon Engine BBY/BKY	GCI61005	Inner Joint			30		57.6				
	2003.07-		AT		F Saloon Engine BBY/BKY	GC083024	Outer Joint		36	30	50.75	59	54.5	I		
	2003.07-		MT		F Saloon Engine BBY/BKY	GC083027	Outer Joint		36	30	50.7	58.5	47.5	I		
	2003.07-		MT	L	F Saloon Engine BBY/BKY	GDS83063	Drive Shaft		36		50.7	58.5	501			
	2003.07-		MT	R	F Saloon Engine BBY/BKY	GDS61063	Drive Shaft		36		50.7	58.5	751			
	2003.07-		AT	R	F Saloon Engine BBY/BKY	GDS61252	Drive Shaft		36		53.7	58.5	730			
	2003.07-		AT	R	F Saloon Engine BBY/BKY	GCI61005	Inner Joint			30		57.6				
	2003.07-		AT	R	F Saloon Engine BBY/BKY	GC061070	Outer Joint		36	30	53.7	58.5	55	I		
1.4 (74 kW)	2003.11-		MT		F Saloon Engine BBZ	GC083027	Outer Joint		36	30	50.7	58.5	47.5	I		
	2003.11-			L	F Saloon Engine BBZ	GDS83063	Drive Shaft		36		50.7	58.5	501			
	2003.11-			R	F Saloon Engine BBZ	GDS61063	Drive Shaft		36		50.7	58.5	751			
1.4 TDi (55 kW)	2003.07-		MT		F Saloon Engine BAY	GC083024	Outer Joint		36	30	50.75	59	54.5	I		
	2003.07-		MT/AT		F Saloon Engine BAY	GCI61006	Inner Joint			30		57.6				
	2003.07-		MT	L	F Saloon Engine BAY	GDS61098	Drive Shaft		36		50.5	59	472			
	2003.07-		MT	R	F Saloon Engine BAY	GDS61099	Drive Shaft		36		50.5	59	759			
	2003.07-			L	F Saloon Engine BAY	GDS61135	Drive Shaft		36		52	59	475			
	2003.07-			R	F Saloon Engine BAY	GDS61136	Drive Shaft		36		52	59	763			
	2003.07-			R	F Saloon Engine BAY	GCI61062	Inner Joint			30		59				
1.9 SDi (47 kW)	2002.09-		MT		F Saloon Engine ASY	GC083027	Outer Joint		36	30	50.7	58.5	47.5	I		
	2002.09-			L	F Saloon Engine ASY	GDS83063	Drive Shaft		36		50.7	58.5	501			
	2002.09-			R	F Saloon Engine ASY	GDS61063	Drive Shaft		36		50.7	58.5	751			
<b>POLO (9N_)</b>																
1.2 (40 kW)	2002.01-	2007.05	MT		F Hatchback Engine AWY/BMD	GC054002	Outer Joint		20	30	52	59.5	49.5	I		
	2002.01-	2007.05	MT		F Hatchback Engine AWY/BMD	GC083027	Outer Joint		36	30	50.7	58.5	47.5	I		
	2002.01-	2007.05	5MT	L	F Hatchback Engine AWY/BMD	GDS83063	Drive Shaft		36		50.7	58.5	501			
	2002.01-	2007.05	5MT	R	F Hatchback Engine AWY/BMD	GDS61063	Drive Shaft		36		50.7	58.5	751			
1.2 (44 kW)	2007.05-	2009.11	MT		F Hatchback Engine BBM	GC054002	Outer Joint		20	30	52	59.5	49.5	I		
	2007.05-	2009.11	MT		F Hatchback Engine BBM	GC083027	Outer Joint		36	30	50.7	58.5	47.5	I		
	2007.05-	2009.11	MT	L	F Hatchback Engine BBM	GDS83063	Drive Shaft		36		50.7	58.5	501			
1.2 12V (47 kW)	2001.10-	2007.07	MT		F Hatchback Engine AZQ/BME	GC083027	Outer Joint		36	30	50.7	58.5	47.5	I		
	2001.10-	2007.07	5MT	L	F Hatchback Engine AZQ/BME	GDS83063	Drive Shaft		36		50.7	58.5	501			
	2001.10-	2007.07	5MT	R	F Hatchback Engine AZQ/BME	GDS61063	Drive Shaft		36		50.7	58.5	751			
1.2 12V (51 kW)	2007.05-	2009.11	MT		F Hatchback Engine BZG	GC083027	Outer Joint		36	30	50.7	58.5	47.5	I		
	2007.05-	2009.11	MT	L	F Hatchback Engine BZG	GDS83063	Drive Shaft		36		50.7	58.5	501			
	2007.05-	2009.11	MT	R	F Hatchback Engine BZG	GDS61063	Drive Shaft		36		50.7	58.5	751			
1.4 16V (55 kW)	2001.10-	2008.05	AT		F Hatchback Engine AUA/BBY/BKY	GC083024	Outer Joint		36	30	50.75	59	54.5	I		
	2001.10-	2008.05	MT		F Hatchback Engine AUA/BBY/BKY	GC083027	Outer Joint		36	30	50.7	58.5	47.5	I		
	2001.10-	2008.05	5MT	L	F Hatchback Engine AUA/BBY/BKY	GDS83063	Drive Shaft		36		50.7	58.5	501			
	2001.10-	2008.05	5MT	R	F Hatchback Engine AUA/BBY/BKY	GDS61063	Drive Shaft		36		50.7	58.5	751			
	2001.10-	2008.05	AT	R	F Hatchback Engine AUA/BBY/BKY	GDS61252	Drive Shaft		36		53.7	58.5	730			

		TRANSM	L/R	F/R		G-AP Ref.	PRODUCT	ABS	Technical Specifications							
									YEAR	A	B	C	H	L	P	
<b>VOLKSWAGEN</b>																
<b>POLO (9N_)</b>																
1.4 16V (55 kW)	2001.10-	2008.05	AT	R	F	Hatchback Engine AUA/BBY/BKY	GCI61005	Inner Joint		30		57.6				
	2001.10-	2008.05	AT	R	F	Hatchback Engine AUA/BBY/BKY	GC061070	Outer Joint	36	30	53.7	58.5	55	I		
1.4 16V (59 kW)	2006.06-	2007.11	MT		F	Hatchback Engine BUD	GC083027	Outer Joint	36	30	50.7	58.5	47.5	I		
	2006.06-	2007.11	AT	L	F	Hatchback Engine BUD	GDS61206	Drive Shaft	36	26	52	59	536			
	2006.06-	2007.11	AT	L	F	Hatchback Engine BUD	GCI61039	Inner Joint	26	22	31	68.5	88.5			
	2006.06-	2007.11	MT	L	F	Hatchback Engine BUD	GDS83063	Drive Shaft	36		50.7	58.5	501			
	2006.06-	2007.11	MT	R	F	Hatchback Engine BUD	GDS61063	Drive Shaft	36		50.7	58.5	751			
	2006.06-	2007.11	MT	R	F	Hatchback Engine BUD	GDS61063	Drive Shaft	36		50.7	58.5	751			
1.4 16V (74 kW)	2001.10-	2008.05	MT		F	Hatchback Engine AUB/BBZ	GC083027	Outer Joint	36	30	50.7	58.5	47.5	I		
	2001.10-	2008.05	5MT	L	F	Hatchback Engine AUB/BBZ	GDS83063	Drive Shaft	36		50.7	58.5	501			
	2001.10-	2008.05	5MT	R	F	Hatchback Engine AUB/BBZ	GDS61063	Drive Shaft	36		50.7	58.5	751			
1.4 FSi (63 kW)	2002.02-	2006.07	MT		F	Hatchback Engine AXU	GC083027	Outer Joint	36	30	50.7	58.5	47.5	I		
	2002.02-	2006.07	5MT	L	F	Hatchback Engine AXU	GDS83063	Drive Shaft	36		50.7	58.5	501			
	2002.02-	2006.07	5MT	R	F	Hatchback Engine AXU	GDS61063	Drive Shaft	36		50.7	58.5	751			
1.4 TDi (51 kW)	2005.06-	2007.06	MT		F	Hatchback Engine BNM/BWB	GC083024	Outer Joint	36	30	50.75	59	54.5	I		
	2005.06-	2007.06	MT	R	F	Hatchback Engine BNM/BWB	GDS61223	Drive Shaft	36		52	59	757			
1.4 TDi (55 kW)	2001.10-	2005.06	MT		F	Hatchback Engine AMF/BAY	GCI61006	Inner Joint		30		57.6				
	2001.10-	2005.06	MT		F	Hatchback Engine AMF/BAY	GC083024	Outer Joint	36	30	50.75	59	54.5	I		
	2001.10-	2005.06	5MT	L	F	Hatchback Engine AMF/BAY	GDS61098	Drive Shaft	36		50.5	59	472			
	2001.10-	2005.06		L	F	Hatchback Engine AMF/BAY	GDS61135	Drive Shaft	36		52	59	475			
	2001.10-	2005.06	5MT	R	F	Hatchback Engine AMF/BAY	GDS61099	Drive Shaft	36		50.5	59	759			
	2001.10-	2005.06		R	F	Hatchback Engine AMF/BAY	GDS61136	Drive Shaft	36		52	59	763			
1.4 TDi (59 kW)	2001.10-	2005.06		R	F	Hatchback Engine AMF/BAY	GCI61062	Inner Joint		30		59				
	2005.06-	2007.06	MT		F	Hatchback Engine BMS/BNV	GC083024	Outer Joint	36	30	50.75	59	54.5	I		
	2005.06-	2007.06	MT/AT		F	Hatchback Engine BMS/BNV	GCI61006	Inner Joint		30		57.6				
	2005.06-	2007.06	MT	L	F	Hatchback Engine BMS/BNV	GDS61098	Drive Shaft	36		50.5	59	472			
	2005.06-	2007.06		L	F	Hatchback Engine BMS/BNV	GDS61135	Drive Shaft	36		52	59	475			
	2005.06-	2007.06	MT	R	F	Hatchback Engine BMS/BNV	GDS61099	Drive Shaft	36		50.5	59	759			
1.6 (74 kW)	2005.06-	2007.06		R	F	Hatchback Engine BMS/BNV	GDS61136	Drive Shaft	36		52	59	763			
	2005.06-	2007.06		R	F	Hatchback Engine BMS/BNV	GDS61136	Drive Shaft	36		52	59	763			
	2005.06-	2007.06		R	F	Hatchback Engine BMS/BNV	GCI61062	Inner Joint		30		59				
	2005.06-	2007.06		R	F	Hatchback Engine BMS/BNV	GCI61062	Inner Joint		30		59				
	2005.06-	2007.06		R	F	Hatchback Engine BMS/BNV	GCI61062	Inner Joint		30		59				
	2005.06-	2007.06		R	F	Hatchback Engine BMS/BNV	GCI61062	Inner Joint		30		59				
1.6 (74 kW)	2002.08-	2005.05	MT		F	Hatchback Engine BAH	GC083024	Outer Joint	36	30	50.75	59	54.5	I		
1.6 16V (77 kW)	2006.06-	2007.06	MT		F	Hatchback Engine BTS	GCI83011	Inner Joint		33		34				
	2006.06-	2007.06	MT		F	Hatchback Engine BTS	GC083024	Outer Joint	36	30	50.75	59	54.5	I		
1.8 GTi (110 kW)	2006.03-	2007.06	MT		F	Hatchback Engine BJX	GCI83011	Inner Joint		33		34				
	2006.03-	2007.06	MT		F	Hatchback Engine BJX	GC083024	Outer Joint	36	30	50.75	59	54.5	I		
	2006.03-	2007.06	MT	L	F	Hatchback Engine BJX	GDS61302	Drive Shaft	36		50.5	59	479			
	2006.03-	2007.06	MT	R	F	Hatchback Engine BJX	GDS61301	Drive Shaft	36		50.5	59	771			
1.8 GTi Cup Edition (132 kW)	2006.05-	2009.11	MT		F	Hatchback Engine BBU	GCI83011	Inner Joint		33		34				
	2006.05-	2009.11	MT		F	Hatchback Engine BBU	GC083024	Outer Joint	36	30	50.75	59	54.5	I		
	2006.05-	2009.11		L	F	Hatchback Engine BBU	GDS61302	Drive Shaft	36		50.5	59	479			
	2006.05-	2009.11		R	F	Hatchback Engine BBU	GDS61301	Drive Shaft	36		50.5	59	771			
1.9 SDi (47 kW)	2001.10-	2009.11	MT		F	Hatchback Engine ASY	GC083027	Outer Joint	36	30	50.7	58.5	47.5	I		
	2001.10-	2009.11	5MT	L	F	Hatchback Engine ASY	GDS83063	Drive Shaft	36		50.7	58.5	501			
	2001.10-	2009.11	5MT	R	F	Hatchback Engine ASY	GDS61063	Drive Shaft	36		50.7	58.5	751			
1.9 TDi (74 kW)	2001.10-	2009.11	MT		F	Hatchback Engine ATD/AXR/BMT	GC083024	Outer Joint	36	30	50.75	59	54.5	I		
	2001.10-	2009.11	MT/AT		F	Hatchback Engine ATD/AXR/BMT	GCI61006	Inner Joint		30		57.6				
	2001.10-	2009.11	5MT	L	F	Hatchback Engine ATD/AXR/BMT	GDS61098	Drive Shaft	36		50.5	59	472			
	2001.10-	2009.11	MT	L	F	Hatchback Engine ATD/AXR/BMT	GDS61135	Drive Shaft	36		52	59	475			
	2001.10-	2009.11	5MT	R	F	Hatchback Engine ATD/AXR/BMT	GDS61099	Drive Shaft	36		50.5	59	759			
	2001.10-	2009.11	MT	R	F	Hatchback Engine ATD/AXR/BMT	GDS61136	Drive Shaft	36		52	59	763			
	2001.10-	2009.11	MT	R	F	Hatchback Engine ATD/AXR/BMT	GCI61062	Inner Joint		30		59				
1.9 TDi (96 kW)	2004.07-	2006.05			F	Hatchback Engine ASZ/BLT	GC053002	Outer Joint	36	27	50.75	75	65	I		
	2004.07-	2006.05	6MT	R	F	Hatchback Engine ASZ/BLT	GDS61183	Drive Shaft	36		50.5	75	769			
<b>POLO CLASSIC</b>																
-	1996-						GC099136	Outer Joint	22	30	51	78	61	I		
1.8	1997.01-	2002.05	MT				GC061018	Outer Joint	22	30	53	78.5	61	I		
<b>POLO III (6KV2, 6KV5)</b>																
1.6 (53 kW)	1995.12-	2001.09	MT	R		France	GCI83011	Inner Joint		33		34				
1.6 (55 kW)	1995.12-	2001.09	MT	R		France	GCI83011	Inner Joint		33		34				
1.6 (74 kW)	1995.12-	2001.09	MT	R		France	GCI83011	Inner Joint		33		34				
1.9 TDi (66 kW)	1996.09-	2001.09	MT	R			GCI83011	Inner Joint		33		34				
1.9 TDi (81 kW)	1996.09-	2001.09	MT	R			GCI83011	Inner Joint		33		34				









		TRANSM	L/R	F/R		G-AP Ref.	PRODUCT	ABS	Technical Specifications							
									YEAR	A	B	C	H	L	P	
<b>VOLKSWAGEN</b>																
<b>POLO IV (6KV2, 6KV5)</b>																
1.6 (53 kW)	1995.12-	2001.09	MT	R	France	GCI83011	Inner Joint			33		34				
1.6 (55 kW)	1995.12-	2001.09	MT	R	France	GCI83011	Inner Joint			33		34				
1.6 (74 kW)	1995.12-	2001.09	MT	R	France	GCI83011	Inner Joint			33		34				
1.9 TDi (66 kW)	1996.09-	2001.09	MT	R		GCI83011	Inner Joint			33		34				
1.9 TDi (81 kW)	1996.09-	2001.09	MT	R		GCI83011	Inner Joint			33		34				
<b>POLO IV (6N2)</b>																
1.4 TDi (55 kW)	1999.10-	2001.09				GC061007	Outer Joint		22	30	53	78.5	60	I		
1.6 16V GTi (92 kW)	1999.10-	2001.09				GC061007	Outer Joint		22	30	53	78.5	60	I		
<b>POLO SEDAN</b>																
1.6 8V (EA111)	2003.01-	2011.06	MT			GC061037	Outer Joint		22	30	51	78	61	I		
1.6/2.0 8V	2003.01-	2011.12				GC054003	Outer Joint		36	30	52	75	56	I		
2.0 8V	2003.01-	2011.06	MT			GC061037	Outer Joint		22	30	51	78	61	I		
<b>POLO V (9N)</b>																
1.2 (40 kW)	2002.01-					GC083027	Outer Joint		36	30	50.7	58.5	47.5	I		
1.2 (44 kW)	2002.01-					GC083027	Outer Joint		36	30	50.7	58.5	47.5	I		
1.2 12V (47 kW)	2001.01-					GC083027	Outer Joint		36	30	50.7	58.5	47.5	I		
1.2 12V (51 kW)	2001.01-					GC083027	Outer Joint		36	30	50.7	58.5	47.5	I		
1.4 16V (55 kW)	2001.10-	2008.05	MT			GC083027	Outer Joint		36	30	50.7	58.5	47.5	I		
1.4 16V (59 kW)	2001.10-	2008.05	MT			GC083027	Outer Joint		36	30	50.7	58.5	47.5	I		
1.4 16V (74 kW)	2001.10-	2008.05	MT			GC083027	Outer Joint		36	30	50.7	58.5	47.5	I		
1.4 FSi (63 kW)	2002.05-	2006.07				GC083027	Outer Joint		36	30	50.7	58.5	47.5	I		
1.6 16V (77 kW)	2006.05-		AT		SE.Ch6L9033001	GC061010	Outer Joint		36	30	52	75	54.5	I		
1.9 SDi (47 kW)	2001.10-					GC083027	Outer Joint		36	30	50.7	58.5	47.5	I		
<b>POLO VI (6R)</b>																
1.2 12V (44 kW)	2009.06-					GC083027	Outer Joint		36	30	50.7	58.5	47.5	I		
1.2 12V (51 kW)	2009.06-					GC083027	Outer Joint		36	30	50.7	58.5	47.5	I		
1.4 (60 kW)	2009.06-		MT			GC083027	Outer Joint		36	30	50.7	58.5	47.5	I		
1.4 (63 kW)	2009.06-		MT			GC083027	Outer Joint		36	30	50.7	58.5	47.5	I		
1.6 TDi (55 kW)	2009.05-		AT			GCI83016	Inner Joint			28		32				
1.6 TDi (66 kW)	2009.05-		AT			GCI83016	Inner Joint			28		32				
<b>QUANTUM</b>																
1.8	1992.11-	2002.12	MT/AT			GC061028	Outer Joint		22	30	51	78	61	I		
	1992.11-	2002.12	MT/AT			GCI18018	Inner Joint				33		32			
	1993.01-	2002.12	MT/AT			GC099134	Outer Joint	43T	22	30	51	78	61	I		
	1993.01-	2002.12	MT/AT			GCI18018	Inner Joint				33		32			
	1996.01-	2002.12	MT/AT			GC099134	Outer Joint	43T	22	30	51	78	61	I		
2.0 8V	1996.01-	2002.12	MT/AT			GC061028	Outer Joint		22	30	51	78	61	I		
	1992.11-	2002.12	MT/AT			GC061028	Outer Joint		22	30	51	78	61	I		
	1992.11-	2002.12	MT/AT			GCI18018	Inner Joint				33		32			
	1993.01-	2002.12	MT/AT			GC099134	Outer Joint	43T	22	30	51	78	61	I		
	1993.01-	2002.12	MT/AT			GCI18018	Inner Joint				33		32			
1996.01-	2002.12	MT/AT				GC099134	Outer Joint	43T	22	30	51	78	61	I		
	2002.12	MT/AT				GC061028	Outer Joint		22	30	51	78	61	I		
<b>SANTANA</b>																
1.8	1996.01-	2006.12	MT/AT			GC099134	Outer Joint	43T	22	30	51	78	61	I		
	1996.01-	2006.12	MT/AT			GC061028	Outer Joint		22	30	51	78	61	I		
2	1996.01-	2006.12	MT/AT			GC099134	Outer Joint	43T	22	30	51	78	61	I		
	1996.01-	2006.12	MT/AT			GC061028	Outer Joint		22	30	51	78	61	I		
<b>SAVEIRO</b>																
2	1996.01-	2006.12	MT			GC061028	Outer Joint		22	30	51	78	61	I		
<b>SCIROCCO (137)</b>																
1.4 TSi (118 kW)	2008.05-			F	Coupe Engine CAVD/CNWA/CTHD/CTKA	GC083037	Outer Joint		36	30	59.5	40.5	55	I		
	2008.05-		MT	F	Coupe Engine CAVD/CNWA/CTHD/CTKA	GCI83011	Inner Joint			33		34				
	2008.05-		MT	L	F Coupe Engine CAVD/CNWA/CTHD/CTKA	GDS61201	Drive Shaft		36		59.5	40.5	535			
	2008.05-				Coupe Engine CAVD/CNWA/CTHD/CTKA	GC083100	Outer Joint		36	33	59.5	38	55	I		
1.4 TSi (90 kW)	2008.08-			F	Coupe Engine CAXA/CMSB	GC083037	Outer Joint		36	30	59.5	40.5	55	I		
	2008.08-		MT	F	Coupe Engine CAXA/CMSB	GCI53002	Inner Joint			33		34				
	2008.08-		MT	L	F Coupe Engine CAXA/CMSB	GDS61198	Drive Shaft		36		59.5	40.5	530			
	2008.08-				Coupe Engine CAXA/CMSB	GC083100	Outer Joint		36	33	59.5	38	55	I		
2.0 R (188 kW)	2009.11-		MT	L	F Coupe Engine CDLC	GDS83236	Drive Shaft		36		59.5	40	484			
	2009.11-		MT	R	F Coupe Engine CDLC	GDS61126	Drive Shaft		36		59.5	40	793			



		TRANSM	L/R	F/R		G-AP Ref.	PRODUCT	ABS	Technical Specifications											
									YEAR	A	B	C	H	L	P					
<b>VOLKSWAGEN SCIROCCO (137)</b>																				
2.0 R (195 kW)	2009.11-		MT	L	F	Coupe Engine CDLA	GDS83236	Drive Shaft	36		59.5	40	484							
	2009.11-		MT	R	F	Coupe Engine CDLA	GDS61126	Drive Shaft	36		59.5	40	793							
2.0 TDi (100 kW)	2010.11-		AT	L	F	Coupe Engine CFHB	GDS54013	Drive Shaft	36		59.5	40	479.5							
	2010.11-		MT	L	F	Coupe Engine CFHB	GDS83295	Drive Shaft	36		59.5	40	491							
	2010.11-		AT	R	F	Coupe Engine CFHB	GDS54011	Drive Shaft	36		59.5	40	755							
	2010.11-		MT	R	F	Coupe Engine CFHB	GDS83313	Drive Shaft	36		59.5	40	792							
	2010.11-		AT	L	F	Coupe Engine CFHB	GDS83241	Drive Shaft	36		59.5	40	475							
	2010.11-		MT	L	F	Coupe Engine CFHB	GDS83236	Drive Shaft	36		59.5	40	484							
	2010.11-		AT	R	F	Coupe Engine CFHB	GDS83355	Drive Shaft	36	23	59.5	40	799							
	2010.11-		MT	R	F	Coupe Engine CFHB	GDS61126	Drive Shaft	36		59.5	40	793							
2.0 TDi (103 kW)	2008.08-		6AT		F	Coupe Engine CBDB/CFHC	GCI54004	Inner Joint		34		85								
	2008.08-		AT	L	F	Coupe Engine CBDB/CFHC	GDS54013	Drive Shaft	36		59.5	40	479.5							
	2008.08-		MT	L	F	Coupe Engine CBDB/CFHC	GDS83295	Drive Shaft	36		59.5	40	491							
	2008.08-		AT	R	F	Coupe Engine CBDB/CFHC	GDS54011	Drive Shaft	36		59.5	40	755							
	2008.08-		MT	R	F	Coupe Engine CBDB/CFHC	GDS83313	Drive Shaft	36		59.5	40	792							
	2008.08-		AT	L	F	Coupe Engine CBDB/CFHC	GDS83241	Drive Shaft	36		59.5	40	475							
	2008.08-		MT	L	F	Coupe Engine CBDB/CFHC	GDS83236	Drive Shaft	36		59.5	40	484							
	2008.08-		AT	L/R	F	Coupe Engine CBDB/CFHC	GCI61057	Inner Joint		34		86								
	2008.08-		AT	R	F	Coupe Engine CBDB/CFHC	GDS83355	Drive Shaft	36	23	59.5	40	799							
	2008.08-		MT	R	F	Coupe Engine CBDB/CFHC	GDS61126	Drive Shaft	36		59.5	40	793							
2.0 TDi (125 kW)	2009.05-		MT	L	F	Coupe Engine CBBB/CFGB	GDS83265	Drive Shaft	36		59.5	40	487							
	2009.05-		AT	R	F	Coupe Engine CBBB/CFGB	GDS54011	Drive Shaft	36		59.5	40	755							
	2009.05-		MT	L	F	Coupe Engine CBBB/CFGB	GDS83236	Drive Shaft	36		59.5	40	484							
	2009.05-		MT	L	F	Coupe Engine CBBB/CFGB	GCI83016	Inner Joint		28		32								
	2009.05-		SEMI-AT	L	F	Coupe Engine CBBB/CFGB	GDS83241	Drive Shaft	36		59.5	40	475							
	2009.05-		AT	R	F	Coupe Engine CBBB/CFGB	GDS83355	Drive Shaft	36	23	59.5	40	799							
	2009.05-		MT	R	F	Coupe Engine CBBB/CFGB	GDS61126	Drive Shaft	36		59.5	40	793							
	2009.05-		MT	R	F	Coupe Engine CBBB/CFGB	GDS54013	Drive Shaft	36		59.5	40	479.5							
2.0 TDi (130 kW)	2013.01-		AT	L	F	Coupe Engine CFGC	GDS54013	Drive Shaft	36		59.5	40	479.5							
	2013.01-		AT	R	F	Coupe Engine CFGC	GDS54011	Drive Shaft	36		59.5	40	755							
	2013.01-		MT	L	F	Coupe Engine CFGC	GDS83236	Drive Shaft	36		59.5	40	484							
	2013.01-		MT	R	F	Coupe Engine CFGC	GDS61126	Drive Shaft	36		59.5	40	793							
2.0 TSi (147 kW)	2008.05-2009.11				F	Coupe Engine CAWB	GC083002	Outer Joint	36	27	59.5	40	66	I						
	2008.05-2009.11		MT	L	F	Coupe Engine CAWB	GDS83295	Drive Shaft	36		59.5	40	491							
	2008.05-2009.11		MT&AT	L	F	Coupe Engine CAWB	GDS83236	Drive Shaft	36		59.5	40	484							
	2008.05-2009.11		MT	R	F	Coupe Engine CAWB	GDS61126	Drive Shaft	36		59.5	40	793							
2.0 TSi (155 kW)	2009.11-2011.05		AT	L	F	Coupe Engine CCZB	GDS83236	Drive Shaft	36		59.5	40	484							
	2009.11-2011.05		AT	L	F	Coupe Engine CCZB	GDS83295	Drive Shaft	36		59.5	40	491							
<b>SCIROCCO (53)</b>																				
1.5 (55 kW)	1974.02-1975.08				F	Coupe Engine YJ/ZB	GC061001	Outer Joint	22	30	50	77.5	51	O						
1.5 (63 kW)	1974.02-1977.12				F	Coupe Engine FD	GC061001	Outer Joint	22	30	50	77.5	51	O						
<b>SCIROCCO (53B)</b>																				
1.3 (44 kW)	1980.08-1983.12		MT		F	Coupe Engine GF	GC061013	Outer Joint	22	30	50	77.5	51	I						
	1980.08-1983.12				F	Coupe Engine GF	GC053006	Outer Joint	22	30	50	78.5	52	I						
1.6 (53 kW)	1986.04-1990.07		MT	R	F	Coupe Engine RE	GDS61054	Drive Shaft	22		53	78.5	749							
1.6 (55 kW)	1983.01-1989.12		MT	R	F	Coupe Engine EW	GDS61054	Drive Shaft	22		53	78.5	749							
	1983.01-1989.12				F	Coupe Engine EW	GC053006	Outer Joint	22	30	50	78.5	52	I						
1.6 (63 kW)	1980.08-1984.04		MT		F	Coupe Engine FR	GC061013	Outer Joint	22	30	50	77.5	51	I						
	1980.08-1984.04				F	Coupe Engine FR	GC053006	Outer Joint	22	30	50	78.5	52	I						
1.6 (81 kW)	1980.08-1982.07		MT		F	Coupe Engine EG	GC061013	Outer Joint	22	30	50	77.5	51	I						
	1980.08-1982.07				F	Coupe Engine EG	GC053006	Outer Joint	22	30	50	78.5	52	I						
1.8 (66 kW)	1983.08-1992.07		AT		F	Coupe Engine EX	GC061013	Outer Joint	22	30	50	77.5	51	I						
	1983.08-1992.07		MT&AT	R	F	Coupe Engine EX	GDS61054	Drive Shaft	22		53	78.5	749							
	1983.08-1992.07		MT	R	F	Coupe Engine EX	GDS61006	Drive Shaft	22		53.2	78	747							
	1983.08-1992.07				F	Coupe Engine EX	GC053006	Outer Joint	22	30	50	78.5	52	I						
1.8 (70 kW)	1985.11-1992.07		MT		F	Coupe Engine JH	GC061013	Outer Joint	22	30	50	77.5	51	I						
	1985.11-1992.07		MT	R	F	Coupe Engine JH	GDS61006	Drive Shaft	22		53.2	78	747							
1.8 (82 kW)	1982.08-1989.12		MT		F	Coupe Engine DX/EV/PB	GC061013	Outer Joint	22	30	50	77.5	51	I						
	1982.08-1989.12		MT	R	F	Coupe Engine DX/EV/PB	GDS61006	Drive Shaft	22		53.2	78	747							
1.8 16V (102 kW)	1985.10-1989.07		MT	R	F	Coupe Engine KR	GDS61006	Drive Shaft	22		53.2	78	747							
1.8 16V (95 kW)	1986.03-1992.07		MT	R	F	Coupe Engine PL	GDS61006	Drive Shaft	22		53.2	78	747							

		TRANSM	L/R	F/R		G-AP Ref.	PRODUCT	ABS	Technical Specifications								
									YEAR	A	B	C	H	L	P		
<b>VOLKSWAGEN SCIROCCO III (137)</b>																	
1.4 TFSi (118 kW)	2008.09-					GC083002	Outer Joint		36	27	59.5	40	66	I			
1.4 TSi (118 kW)	2008.09-		MT			GC083037	Outer Joint		36	30	59.5	40.5	55	I			
	2008.09-					GCI83016	Inner Joint			28		32					
1.4 TSi (90 kW)	2008.09-		MT			GC083037	Outer Joint		36	30	59.5	40.5	55	I			
2.0 TDi (103 kW)	2008.09-					GC083002	Outer Joint		36	27	59.5	40	66	I			
2.0 TDi (125 kW)	2009.05-		MT			GCI83016	Inner Joint			28		32					
2.0 TSi (147 kW)		2009.12				GC083002	Outer Joint		36	27	59.5	40	66	I			
		2008.12-				GCI83016	Inner Joint			28		32					
2.0 TSi (155 kW)		2009.12				GC083002	Outer Joint		36	27	59.5	40	66	I			
		2008.12-				GCI83016	Inner Joint			28		32					
<b>SHARAN</b>																	
-	2000.02-					GDS61193	Stub Shaft		37		60		322				
	2000.02-					GDS61192	Stub Shaft		26	37	60		129.5				
1.8 T 20V	1997.11-	2000.05	MT			GC018040	Outer Joint		38	27	60	34.5	65	I			
	1997.11-	2000.05	MT	L		GDS83024	Drive Shaft	48W	38	26	60	34.5	617				
	1997.11-	2000.05	MT	R		GDS83027	Drive Shaft	48W	38	35	60	34.5	561				
	1997.11-	2000.05	MT	L		GDS83064	Drive Shaft		38	26	60	34.5	617				
1.9 TDi	1995.08-	2000.05	MT			GC018040	Outer Joint		38	27	60	34.5	65	I			
	1995.08-	2000.05	MT	L		GDS83024	Drive Shaft	48W	38	26	60	34.5	617				
	1995.08-	2000.05	MT	R		GDS83027	Drive Shaft	48W	38	35	60	34.5	561				
	1995.08-	2000.05	MT	L		GDS83064	Drive Shaft		38	26	60	34.5	617				
2.0 i	1995.08-	2000.05				GC018040	Outer Joint		38	27	60	34.5	65	I			
	1995.08-	2000.05	MT	L		GDS83024	Drive Shaft	48W	38	26	60	34.5	617				
	1995.08-	2000.05	MT	R		GDS83027	Drive Shaft	48W	38	35	60	34.5	561				
	1995.08-	2000.05	MT	L		GDS83064	Drive Shaft		38	26	60	34.5	617				
2.8 i V6	1996.11-	2000.05	AT			GC018040	Outer Joint		38	27	60	34.5	65	I			
2.8 i VR6	1995.09-	2000.05				GC018040	Outer Joint		38	27	60	34.5	65	I			
	1995.09-	2000.05	MT	L		GDS83024	Drive Shaft	48W	38	26	60	34.5	617				
	1995.09-	2000.05	MT	R		GDS83027	Drive Shaft	48W	38	35	60	34.5	561				
	1995.09-	2000.05	MT	L		GDS83064	Drive Shaft		38	26	60	34.5	617				
<b>SHARAN (7M8, 7M9, 7M6)</b>																	
1.8 T 20V (110 kW)	1997.09-	2010.03			F	MPV Engine AJH/AWC	GC018025	Outer Joint	48W	38	36	60	34	72.5	I		
	1997.09-	2010.03	MT/AT		F	MPV Engine AJH/AWC	GC018026	Outer Joint	48W	38	27	60	34.5	65	I		
	1997.09-	2010.03	MT/AT		F	MPV Engine AJH/AWC	GCI61044	Inner Joint		34		85					
	1997.09-	2010.03	AT	L	F	MPV Engine AJH/AWC	GDS61085	Drive Shaft	48W	38		60	34.5	513			
	1997.09-	2010.03	MT	L	F	MPV Engine AJH/AWC	GCI99053	Inner Joint		26	28	40	77.5	82.5			
	1997.09-	2010.03	MT	L	F	MPV Engine AJH/AWC	GDS18009	Drive Shaft	48W	38	26	60	34.5	620			
	1997.09-	2010.03	AT	L/R	F	MPV Engine AJH/AWC	GC018039	Outer Joint		38	36	60	34	72.5	I		
	1997.09-	2010.03	AT	L/R	F	MPV Engine AJH/AWC	GDS83022	Drive Shaft	48W	38		60	34	486			
	1997.09-	2010.03	MT	L/R	F	MPV Engine AJH/AWC	GDS83023	Drive Shaft	48W	38		60	34	507			
	1997.09-	2010.03		L/R	F	MPV Engine AJH/AWC	GCI61033	Inner Joint		34		85					
	1997.09-	2010.03	AT	R	F	MPV Engine AJH/AWC	GDS61104	Drive Shaft	48W	38		60	34	544			
	1997.09-	2010.03	AT	R	F	MPV Engine AJH/AWC	GCI50019	Inner Joint		34		59.5					
	1997.09-	2010.03	AT	R	F	MPV Engine AJH/AWC	GC018025	Outer Joint	48W	38	36	60	34	72.5	I		
	1997.09-	2010.03	AT	R	F	MPV Engine AJH/AWC	GDS61065	Drive Shaft	48W	38		60	34.5	544			
	1997.09-	2010.03	MT	R	F	MPV Engine AJH/AWC	GCI61028	Inner Joint		35	28	42	48	52			
	1997.09-	2010.03	MT	R	F	MPV Engine AJH/AWC	GDS18008	Drive Shaft	48W	38	35	60	34.5	559			
	1997.09-	2010.03	6MT			MPV Engine AJH/AWC	GDS61192	Stub Shaft		26	37	60		129.5			
	1997.09-	2010.03	6MT			MPV Engine AJH/AWC	GDS61193	Stub Shaft		37		60		322			
	1.9 TDi (110 kW)	2005.06-	2010.03	MT/AT		F	MPV Engine BTB	GCI61044	Inner Joint		34		85				
		2005.06-	2010.03		L/R	F	MPV Engine BTB	GDS83023	Drive Shaft	48W	38		60	34	507		
2005.06-		2010.03	6MT			MPV Engine BTB	GDS61192	Stub Shaft		26	37	60		129.5			
2005.06-		2010.03	6MT			MPV Engine BTB	GDS61193	Stub Shaft		37		60		322			
1.9 TDi (66 kW)	1995.09-	2010.03			F	MPV Engine 1Z/AHU/ANU	GC018025	Outer Joint	48W	38	36	60	34	72.5	I		
	1995.09-	2010.03	MT		F	MPV Engine 1Z/AHU/ANU	GC018026	Outer Joint	48W	38	27	60	34.5	65	I		
	1995.09-	2010.03	MT		F	MPV Engine 1Z/AHU/ANU	GCI61044	Inner Joint		34		85					
	1995.09-	2010.03	MT	L	F	MPV Engine 1Z/AHU/ANU	GCI99053	Inner Joint		26	28	40	77.5	82.5			
	1995.09-	2010.03	MT	L	F	MPV Engine 1Z/AHU/ANU	GDS18009	Drive Shaft	48W	38	26	60	34.5	620			
	1995.09-	2010.03	6MT	L/R	F	MPV Engine 1Z/AHU/ANU	GDS61087	Drive Shaft	48W	38		60	34.5	506			
	1995.09-	2010.03	6MT	L/R	F	MPV Engine 1Z/AHU/ANU	GCI61032	Inner Joint		27		34					
	1995.09-	2010.03	6MT	L/R	F	MPV Engine 1Z/AHU/ANU	GC061022	Outer Joint		38	27	60	34.5	65	M		









		TRANSM	L/R	F/R		G-AP Ref.	PRODUCT	ABS	Technical Specifications								
									YEAR	A	B	C	H	L	P		
<b>VOLKSWAGEN</b>																	
<b>SHARAN (7M8, 7M9, 7M6)</b>																	
1.9 TDi (66 kW)	1995.09-	2010.03	MT	L/R	F	MPV Engine 1Z/AHU/ANU	GDS83023	Drive Shaft	48W	38		60	34	507			
	1995.09-	2010.03	AT	R	F	MPV Engine 1Z/AHU/ANU	GDS61104	Drive Shaft	48W	38		60	34	544			
	1995.09-	2010.03	AT	R	F	MPV Engine 1Z/AHU/ANU	GCI50019	Inner Joint			34		59.5				
	1995.09-	2010.03	AT	R	F	MPV Engine 1Z/AHU/ANU	GC018025	Outer Joint	48W	38	36	60	34	72.5	I		
	1995.09-	2010.03	MT	R	F	MPV Engine 1Z/AHU/ANU	GDS83065	Drive Shaft		38	35	60	34.5	561			
	1995.09-	2010.03	MT	R	F	MPV Engine 1Z/AHU/ANU	GCI61028	Inner Joint		35	28	42	48	52			
	1995.09-	2010.03	MT	R	F	MPV Engine 1Z/AHU/ANU	GDS18008	Drive Shaft	48W	38	35	60	34.5	559			
	1995.09-	2010.03	6MT			MPV Engine 1Z/AHU/ANU	GDS61192	Stub Shaft		26	37	60		129.5			
1.9 TDi (81 kW)	1996.09-	2000.04	6MT			MPV Engine AFN/AVG	GDS61192	Stub Shaft		26	37	60		129.5			
	1996.09-	2000.04	6MT			MPV Engine AFN/AVG	GDS61193	Stub Shaft		37		60		322			
1.9 TDi (85 kW)	2000.04-	2010.03	6MT		F	MPV Engine AUY/BVK	GC018025	Outer Joint	48W	38	36	60	34	72.5	I		
	2000.04-	2010.03	MT/AT		F	MPV Engine AUY/BVK	GCI61044	Inner Joint			34		85				
	2000.04-	2010.03	5AT	L/R	F	MPV Engine AUY/BVK	GC018039	Outer Joint		38	36	60	34	72.5	I		
	2000.04-	2010.03	5AT	L/R	F	MPV Engine AUY/BVK	GDS83022	Drive Shaft	48W	38		60	34	486			
	2000.04-	2010.03	MT	L/R	F	MPV Engine AUY/BVK	GDS61087	Drive Shaft	48W	38		60	34.5	506			
	2000.04-	2010.03	MT	L/R	F	MPV Engine AUY/BVK	GCI61032	Inner Joint			27		34				
	2000.04-	2010.03	MT	L/R	F	MPV Engine AUY/BVK	GC061022	Outer Joint		38	27	60	34.5	65	M		
	2000.04-	2010.03	MT	L/R	F	MPV Engine AUY/BVK	GDS83023	Drive Shaft	48W	38		60	34	507			
	2000.04-	2010.03	6MT			MPV Engine AUY/BVK	GDS61192	Stub Shaft		26	37	60		129.5			
1.9 TDi (96 kW)	2002.11-	2010.03			F	MPV Engine ASZ	GC018025	Outer Joint	48W	38	36	60	34	72.5	I		
	2002.11-	2010.03	MT/AT		F	MPV Engine ASZ	GCI61044	Inner Joint			34		85				
	2002.11-	2010.03	MT	L/R	F	MPV Engine ASZ	GDS83023	Drive Shaft	48W	38		60	34	507			
	2002.11-	2010.03	6MT			MPV Engine ASZ	GDS61192	Stub Shaft		26	37	60		129.5			
1.9 TDi 4motion (85 kW)	2000.04-	2010.03	6MT			MPV Engine AUY/BVK	GC018025	Outer Joint	48W	38	36	60	34	72.5	I		
	2000.04-	2010.03	MT/AT		F	MPV Engine AUY/BVK	GCI61044	Inner Joint			34		85				
2.0 (85 kW)	2000.04-	2010.03	MT	L/R	F	MPV Engine AUY/BVK	GDS83023	Drive Shaft	48W	38		60	34	507			
	1995.09-	2010.03			F	MPV Engine ADY/ATM	GC018025	Outer Joint	48W	38	36	60	34	72.5	I		
	1995.09-	2010.03	MT/AT		F	MPV Engine ADY/ATM	GC018026	Outer Joint	48W	38	27	60	34.5	65	I		
	1995.09-	2010.03	MT/AT		F	MPV Engine ADY/ATM	GCI61044	Inner Joint			34		85				
	1995.09-	2010.03	AT	L	F	MPV Engine ADY/ATM	GDS61085	Drive Shaft	48W	38		60	34.5	513			
	1995.09-	2010.03	MT	L	F	MPV Engine ADY/ATM	GCI99053	Inner Joint		26	28	40	77.5	82.5			
	1995.09-	2010.03	MT	L	F	MPV Engine ADY/ATM	GDS18009	Drive Shaft	48W	38	26	60	34.5	620			
	1995.09-	2010.03	MT	L/R	F	MPV Engine ADY/ATM	GDS61087	Drive Shaft	48W	38		60	34.5	506			
	1995.09-	2010.03	MT	L/R	F	MPV Engine ADY/ATM	GCI61032	Inner Joint			27		34				
	1995.09-	2010.03	MT	L/R	F	MPV Engine ADY/ATM	GC061022	Outer Joint		38	27	60	34.5	65	M		
	1995.09-	2010.03	MT	L/R	F	MPV Engine ADY/ATM	GDS83023	Drive Shaft	48W	38		60	34	507			
	1995.09-	2010.03		L/R	F	MPV Engine ADY/ATM	GCI61033	Inner Joint			34		85				
	1995.09-	2010.03	AT	R	F	MPV Engine ADY/ATM	GDS61104	Drive Shaft	48W	38		60	34	544			
	1995.09-	2010.03	AT	R	F	MPV Engine ADY/ATM	GCI50019	Inner Joint			34		59.5				
	1995.09-	2010.03	AT	R	F	MPV Engine ADY/ATM	GC018025	Outer Joint	48W	38	36	60	34	72.5	I		
	1995.09-	2010.03	AT	R	F	MPV Engine ADY/ATM	GDS61065	Drive Shaft	48W	38		60	34.5	544			
	1995.09-	2010.03	MT	R	F	MPV Engine ADY/ATM	GDS83065	Drive Shaft		38	35	60	34.5	561			
	1995.09-	2010.03	MT	R	F	MPV Engine ADY/ATM	GCI61028	Inner Joint		35	28	42	48	52			
	1995.09-	2010.03	MT	R	F	MPV Engine ADY/ATM	GDS18008	Drive Shaft	48W	38	35	60	34.5	559			
	1995.09-	2010.03	6MT			MPV Engine ADY/ATM	GDS61192	Stub Shaft		26	37	60		129.5			
1995.09-	2010.03	6MT			MPV Engine ADY/ATM	GDS61193	Stub Shaft		37		60		322				
2.0 16V (110 kW)	1995.09-	2000.02	6MT			MPV Engine ABF	GDS61192	Stub Shaft		26	37	60		129.5			
	1995.09-	2000.02	6MT			MPV Engine ABF	GDS61193	Stub Shaft		37		60		322			
2.0 LPG (85 kW)	2006.04-	2010.03			F	MPV Engine ATM	GC018025	Outer Joint	48W	38	36	60	34	72.5	I		
	2006.04-	2010.03	MT/AT	L/R	F	MPV Engine ATM	GDS61087	Drive Shaft	48W	38		60	34.5	506			
	2006.04-	2010.03	MT/AT	L/R	F	MPV Engine ATM	GCI61032	Inner Joint			27		34				
	2006.04-	2010.03	MT/AT	L/R	F	MPV Engine ATM	GC061022	Outer Joint		38	27	60	34.5	65	M		
	2006.04-	2010.03	6MT			MPV Engine ATM	GDS61192	Stub Shaft		26	37	60		129.5			
2.0 TDi (100 kW)	2006.04-	2010.03	6MT			MPV Engine ATM	GDS61193	Stub Shaft		37		60		322			
	2005.11-	2010.03	6MT			MPV Engine BVH	GDS61192	Stub Shaft		26	37	60		129.5			
2.0 TDi (103 kW)	2005.11-	2008.02			F	MPV Engine BRT	GC018025	Outer Joint	48W	38	36	60	34	72.5	I		
	2005.11-	2008.02	MT/AT		F	MPV Engine BRT	GCI61044	Inner Joint			34		85				

		TRANSM	L/R	F/R		G-AP Ref.	PRODUCT	ABS	Technical Specifications						
									YEAR	A	B	C	H	L	P
<b>VOLKSWAGEN</b>															
<b>SHARAN (7M8, 7M9, 7M6)</b>															
2.0 TDi (103 kW)	2005.11-	2008.02		L/R	F	MPV Engine BRT	GDS83023	Drive Shaft	48W	38		60	34	507	
	2005.11-	2008.02	6MT			MPV Engine BRT	GDS61192	Stub Shaft		26	37	60		129.5	
	2005.11-	2008.02	6MT			MPV Engine BRT	GDS61193	Stub Shaft		37		60		322	
2.8 V6 24V (150 kW)	2000.04-	2010.03	6MT		F	MPV Engine AYL	GC018025	Outer Joint	48W	38	36	60	34	72.5	I
	2000.04-	2010.03	MT/AT		F	MPV Engine AYL	GCI61044	Inner Joint			34		85		
	2000.04-	2010.03	5AT	L	F	MPV Engine AYL	GC018039	Outer Joint		38	36	60	34	72.5	I
	2000.04-	2010.03	5AT	L	F	MPV Engine AYL	GDS83022	Drive Shaft	48W	38		60	34	486	
	2000.04-	2010.03	MT	L/R	F	MPV Engine AYL	GDS83023	Drive Shaft	48W	38		60	34	507	
	2000.04-	2010.03	5AT	R	F	MPV Engine AYL	GDS99120	Drive Shaft	48W	38	30	60	34	561	
	2000.04-	2010.03	6MT			MPV Engine AYL	GDS61192	Stub Shaft		26	37	60		129.5	
	2000.04-	2010.03	6MT			MPV Engine AYL	GDS61193	Stub Shaft		37		60		322	
2.8 V6 24V 4motion (150 kW)	2000.04-	2010.03	6MT		F	MPV Engine AYL	GC018025	Outer Joint	48W	38	36	60	34	72.5	I
	2000.04-	2010.03	MT/AT		F	MPV Engine AYL	GCI61044	Inner Joint			34		85		
	2000.04-	2010.03	MT	L/R	F	MPV Engine AYL	GDS83023	Drive Shaft	48W	38		60	34	507	
2.8 VR6 (128 kW)	1995.09-	2000.04	AT	L/R	F	MPV Engine AAA/AMY	GDS18010	Drive Shaft	48W	38		60	34.5	550	
	1995.09-	2000.04	6MT			MPV Engine AAA/AMY	GDS61192	Stub Shaft		26	37	60		129.5	
	1995.09-	2000.04	6MT			MPV Engine AAA/AMY	GDS61193	Stub Shaft		37		60		322	
2.8 VR6 Syncro (128 kW)	1996.11-	2000.04	AT	L/R	F	MPV Engine AAA/AMY	GDS18010	Drive Shaft	48W	38		60	34.5	550	
<b>SHARAN (7N)</b>															
1.4 TSi (110 kW)	2010.05-			L	F	MPV Engine CAVA	GDS61188	Drive Shaft		36		59.5	40	487	
	2010.05-					MPV Engine CAVA	GC083095	Outer Joint		36	28	59.5	40	66	I
2.0 TDi (100 kW)	2010.05-			L	F	MPV Engine CFFA	GDS61188	Drive Shaft		36		59.5	40	487	
	2010.05-					MPV Engine CFFA	GC083095	Outer Joint		36	28	59.5	40	66	I
2.0 TDi (103 kW)	2010.05-				F	MPV Engine CFFB	GC018025	Outer Joint	48W	38	36	60	34	72.5	I
	2010.05-			L	F	MPV Engine CFFB	GDS61188	Drive Shaft		36		59.5	40	487	
	2010.05-					MPV Engine CFFB	GC083095	Outer Joint		36	28	59.5	40	66	I
2.0 TDi (125 kW)	2010.08-				MPV Engine CFGB	GC083095	Outer Joint		36	28	59.5	40	66	I	
2.0 TDi (130 kW)	2013.01-				MPV Engine CFGC	GC083095	Outer Joint		36	28	59.5	40	66	I	
2.0 TDi (85 kW)	2011.05-			L	F	MPV Engine CFFE	GDS61188	Drive Shaft		36		59.5	40	487	
	2011.05-					MPV Engine CFFE	GC083095	Outer Joint		36	28	59.5	40	66	I
2.0 TDi 4motion (100 kW)	2011.05-	2012.05			MPV Engine CFFA	GC083095	Outer Joint		36	28	59.5	40	66	I	
2.0 TDi 4motion (103 kW)	2011.05-				MPV Engine CFFB	GC083095	Outer Joint		36	28	59.5	40	66	I	
2.0 TSi (147 kW)	2010.12-			L	F	MPV Engine CCZA	GDS61188	Drive Shaft		36		59.5	40	487	
	2010.12-					MPV Engine CCZA	GC083095	Outer Joint		36	28	59.5	40	66	I
<b>SHARAN I (7M8, 7M9, 7M6)</b>															
1.9 TDi (66 kW)	1995.09-	2000.05		L			GCI99053	Inner Joint		26	28	40	77.5	82.5	
	1995.09-	2000.05		R			GCI61028	Inner Joint		35	28	42	48	52	
2.0 (85 kW)	1995.09-	2000.04		R			GCI61028	Inner Joint		35	28	42	48	52	
	1995.09-	2000.09		L			GCI99053	Inner Joint		26	28	40	77.5	82.5	
2.8 VR6 (128 kW)	1995.05-	2000.04		R			GCI61028	Inner Joint		35	28	42	48	52	
	1995.05-	2000.09		L			GCI99053	Inner Joint		26	28	40	77.5	82.5	
<b>SPACEFOX</b>															
1.6 8V (EA111)	2007.01-	2011.06	MT				GC061037	Outer Joint		22	30	51	78	61	I
<b>SYNCRO</b>															
-	1989-	1992				4WD	GC061017	Outer Joint		26	25	65	104	69.5	O
<b>TIGUAN (5N_)</b>															
1.4 TSi (110 kW)	2008.05-		MT	L	F	Closed Off-Road Vehicle Engine BWK/CAVA/CTHA	GDS61146	Drive Shaft		36		59.5	40	490	
	2008.05-		MT	L	F	Closed Off-Road Vehicle Engine BWK/CAVA/CTHA	GCI83016	Inner Joint			28		32		
	2008.05-		MT	R	F	Closed Off-Road Vehicle Engine BWK/CAVA/CTHA	GDS61147	Drive Shaft		36		59.5	40	795	
	2008.05-		MT	R	F	Closed Off-Road Vehicle Engine BWK/CAVA/CTHA	GCI83016	Inner Joint			28		32		
1.4 TSi (118 kW)	2011.05-		MT	L	F	Closed Off-Road Vehicle Engine CAVD/CTHD	GDS61146	Drive Shaft		36		59.5	40	490	
	2011.05-		MT	L	F	Closed Off-Road Vehicle Engine CAVD/CTHD	GCI83016	Inner Joint			28		32		
	2011.05-		MT	R	F	Closed Off-Road Vehicle Engine CAVD/CTHD	GDS61147	Drive Shaft		36		59.5	40	795	
	2011.05-		MT	R	F	Closed Off-Road Vehicle Engine CAVD/CTHD	GCI83016	Inner Joint			28		32		
1.4 TSi (90 kW)	2010.08-		MT	L	F	Closed Off-Road Vehicle Engine CAXA	GDS61146	Drive Shaft		36		59.5	40	490	
	2010.08-		MT	L	F	Closed Off-Road Vehicle Engine CAXA	GCI83016	Inner Joint			28		32		
	2010.08-		MT	R	F	Closed Off-Road Vehicle Engine CAXA	GDS61147	Drive Shaft		36		59.5	40	795	
	2010.08-		MT	R	F	Closed Off-Road Vehicle Engine CAXA	GCI83016	Inner Joint			28		32		
1.4 TSi 4motion (110 kW)	2007.10-		MT		F	Closed Off-Road Vehicle Engine BWK/CAVA/CTHA	GC083002	Outer Joint		36	27	59.5	40	66	I
	2007.10-				R	Closed Off-Road Vehicle Engine BWK/CAVA/CTHA	GCI83011	Inner Joint			33		34		
	2007.10-		MT		R	Closed Off-Road Vehicle Engine BWK/CAVA/CTHA	GCI53002	Inner Joint			33		34		



		YEAR	TRANSM	L/R	F/R		G-AP Ref.	PRODUCT	ABS	Technical Specifications										
										A	B	C	H	L	P					
<b>VOLKSWAGEN TIGUAN (5N_)</b>																				
2.0 TDi (103 kW)	2008.03-				F	Closed Off-Road Vehicle Engine CBAB/CFFB	GC083037	Outer Joint		36	30	59.5	40.5	55	I					
	2008.03-		MT	L	F	Closed Off-Road Vehicle Engine CBAB/CFFB	GDS61146	Drive Shaft		36		59.5	40	490						
	2008.03-		MT	L	F	Closed Off-Road Vehicle Engine CBAB/CFFB	GCI83016	Inner Joint			28		32							
	2008.03-		MT	R	F	Closed Off-Road Vehicle Engine CBAB/CFFB	GDS61147	Drive Shaft		36		59.5	40	795						
	2008.03-		MT	R	F	Closed Off-Road Vehicle Engine CBAB/CFFB	GCI83016	Inner Joint			28		32							
2.0 TDi (81 kW)	2010.05-		MT	L	F	Closed Off-Road Vehicle Engine CFFD	GDS61146	Drive Shaft		36		59.5	40	490						
	2010.05-		MT	L	F	Closed Off-Road Vehicle Engine CFFD	GCI83016	Inner Joint			28		32							
2.0 TDi 4motion (100 kW)	2007.11-		AT		F	Closed Off-Road Vehicle Engine CFFA/CBAA	GC083002	Outer Joint		36	27	59.5	40	66	I					
	2007.11-				R	Closed Off-Road Vehicle Engine CFFA/CBAA	GCI83011	Inner Joint			33		34							
	2007.11-		MT		R	Closed Off-Road Vehicle Engine CFFA/CBAA	GCI53002	Inner Joint			33		34							
	2007.11-		AT	R	F	Closed Off-Road Vehicle Engine CFFA/CBAA	GDS83270	Drive Shaft		36	40	59.5	40	593						
2.0 TDi 4motion (103 kW)	2007.10-					Closed Off-Road Vehicle Engine CBAB/CFFB/CLJA	GC083037	Outer Joint		36	30	59.5	40.5	55	I					
	2007.10-		MT		F	Closed Off-Road Vehicle Engine CBAB/CFFB/CLJA	GC083002	Outer Joint		36	27	59.5	40	66	I					
	2007.10-				R	Closed Off-Road Vehicle Engine CBAB/CFFB/CLJA	GCI83011	Inner Joint			33		34							
	2007.10-		MT		R	Closed Off-Road Vehicle Engine CBAB/CFFB/CLJA	GCI53002	Inner Joint			33		34							
	2007.10-		AT	R	F	Closed Off-Road Vehicle Engine CBAB/CFFB/CLJA	GDS83270	Drive Shaft		36	40	59.5	40	593						
	2007.10-		AT	R	F	Closed Off-Road Vehicle Engine CBAB/CFFB/CLJA	GCI61048	Inner Joint		40	34	46.9	47	80.5						
2.0 TDi 4motion (120 kW)	2008.02-	2009.08	MT	R	F	Closed Off-Road Vehicle Engine CBBA	GDS83269	Drive Shaft		36	40	59.5	40	605						
2.0 TDi 4motion (125 kW)	2007.10-					Closed Off-Road Vehicle Engine CBBB/CFGB	GC083037	Outer Joint		36	30	59.5	40.5	55	I					
	2007.10-		MT		F	Closed Off-Road Vehicle Engine CBBB/CFGB	GC083002	Outer Joint		36	27	59.5	40	66	I					
	2007.10-		MT		R	Closed Off-Road Vehicle Engine CBBB/CFGB	GCI53002	Inner Joint			33		34							
	2007.10-		MT	R	F	Closed Off-Road Vehicle Engine CBBB/CFGB	GDS83269	Drive Shaft		36	40	59.5	40	605						
2.0 TDi 4motion (130 kW)	2012.11-		MT	R	F	Closed Off-Road Vehicle Engine CFGC	GDS83269	Drive Shaft		36	40	59.5	40	605						
2.0 TFSi 4motion (125 kW)	2007.10-		MT		F	Closed Off-Road Vehicle Engine CAWA/CCZC	GC083002	Outer Joint		36	27	59.5	40	66	I					
	2007.10-		MT		R	Closed Off-Road Vehicle Engine CAWA/CCZC	GCI53002	Inner Joint			33		34							
2.0 TFSi 4motion (147 kW)	2007.10-		MT		F	Closed Off-Road Vehicle Engine CAWB/CCTA/CCZA	GC083002	Outer Joint		36	27	59.5	40	66	I					
	2007.10-				R	Closed Off-Road Vehicle Engine CAWB/CCTA/CCZA	GCI83011	Inner Joint			33		34							
	2007.10-		MT		R	Closed Off-Road Vehicle Engine CAWB/CCTA/CCZA	GCI53002	Inner Joint			33		34							
<b>TIGUAN I (5N1)</b>																				
1.4 TSi (110 kW)	2007.09-	2011.05					GCI83016	Inner Joint			28		32							
1.4 TSi 4motion (110 kW)	2007.09-	2011.05					GC083002	Outer Joint		36	27	59.5	40	66	I					
2.0 TSi 4motion (125 kW)	2007.09-	2011.05	MT/AT				GC083002	Outer Joint		36	27	59.5	40	66	I					
2.0 TSi 4motion (147 kW)	2007.09-	2011.05	MT/AT				GC083002	Outer Joint		36	27	59.5	40	66	I					
<b>TIGUAN II (5N2)</b>																				
1.4 TSi (110 kW)	2011.05-						GCI83016	Inner Joint			28		32							
1.4 TSi (118 kW)	2011.05-						GCI83016	Inner Joint			28		32							
1.4 TSi (90 kW)	2011.05-						GCI83016	Inner Joint			28		32							
1.4 TSi 4motion (110 kW)	2011.05-						GC083002	Outer Joint		36	27	59.5	40	66	I					
1.4 TSi 4motion (118 kW)	2011.05-						GC083002	Outer Joint		36	27	59.5	40	66	I					
2.0 TDi (103 kW)	2011.05-						GCI83016	Inner Joint			28		32							
2.0 TDi (81 kW)	2011.05-						GCI83016	Inner Joint			28		32							
2.0 TDi 4motion (100 kW)	2011.05-		MT/AT				GC083002	Outer Joint		36	27	59.5	40	66	I					
2.0 TDi 4motion (103 kW)	2011.05-		MT/AT				GC083002	Outer Joint		36	27	59.5	40	66	I					
2.0 TDi 4motion (155 kW)	2011.05-		MT				GC083002	Outer Joint		36	27	59.5	40	66	I					
2.0 TSi (125 kW)	2011.05-		MT				GC083002	Outer Joint		36	27	59.5	40	66	I					
2.0 TSi (132 kW)	2011.05-		MT				GC083002	Outer Joint		36	27	59.5	40	66	I					
2.0 TSi (147 kW)	2011.05-		MT				GC083002	Outer Joint		36	27	59.5	40	66	I					
<b>TOUAREG (7LA, 7L6, 7L7)</b>																				
2.5 R5 TDi (128 kW)	2003.01-	2010.05				Closed Off-Road Vehicle Engine BAC/BPE	GC061042	Outer Joint		38	27	63.9	102.5	63	M					
	2003.01-	2010.05	6MT/6AT	L/R		Closed Off-Road Vehicle Engine BAC/BPE	GCI83027	Inner Joint			28		28							
	2003.01-	2010.05	6MT/6AT	L/R	F	Closed Off-Road Vehicle Engine BAC/BPE	GDS83300	Drive Shaft		38		63.9	102.5	523						
	2003.01-	2010.05	6MT/6AT		F	Closed Off-Road Vehicle Engine BAC/BPE	GCI99148	Inner Joint			28		34							
	2003.01-	2010.05	6MT/6AT	L/R	R	Closed Off-Road Vehicle Engine BAC/BPE	GCI35051	Inner Joint			30		30.5							
	2003.01-	2010.05	MT/AT	L/R	R	Closed Off-Road Vehicle Engine BAC/BPE	GDS35087	Drive Shaft		38		63	102	723						
3.0 V6 TDi (165 kW)	2004.10-	2008.02	6MT/6AT			Closed Off-Road Vehicle Engine BKS/CATA	GC061050	Outer Joint		30	27	64	103.5	63.5	M					
	2004.10-	2008.02	6MT/6AT	L/R		Closed Off-Road Vehicle Engine BKS/CATA	GCI83027	Inner Joint			28		28							
	2004.10-	2008.02	6MT/6AT	L/R	F	Closed Off-Road Vehicle Engine BKS/CATA	GDS99213	Drive Shaft		30		64	103.5	523						
	2004.10-	2008.02	6MT/6AT	L/R	F	Closed Off-Road Vehicle Engine BKS/CATA	GCI99148	Inner Joint			28		34							
	2004.10-	2008.02	6MT/6AT	L/R	R	Closed Off-Road Vehicle Engine BKS/CATA	GDS61236	Drive Shaft		30		64	103.5	734						
	2004.10-	2008.02	6MT/6AT	L/R	R	Closed Off-Road Vehicle Engine BKS/CATA	GCI61064	Inner Joint		30	28	64	103.5	64						
	2004.10-	2008.02	6MT/6AT	L/R	R	Closed Off-Road Vehicle Engine BKS/CATA	GCI61066	Inner Joint			28		28							





		TRANSM	L/R	F/R		G-AP Ref.	PRODUCT	ABS	Technical Specifications									
									YEAR	A	B	C	H	L	P			
<b>VOLKSWAGEN</b> <b>TOUAREG (7LA, 7L6, 7L7)</b>																		
3.0 V6 TDi (165 kW)	2004.10-	2008.02	MT/AT	L/R	R	Closed Off-Road Vehicle Engine BKS/CATA	GDS35086	Drive Shaft	30		64.3	103.5	724					
3.0 V6 TDi (176 kW)	2007.11-	2010.05		L/R	R	Closed Off-Road Vehicle Engine CASA/CASC	GCI161066	Inner Joint		28		28						
	2007.11-	2010.05			F	Closed Off-Road Vehicle Engine CASA/CASC	GC061050	Outer Joint	30	27	64	103.5	63.5	M				
	2007.11-	2010.05		L/R	F	Closed Off-Road Vehicle Engine CASA/CASC	GDS99213	Drive Shaft	30		64	103.5	523					
	2007.11-	2010.05		L/R	R	Closed Off-Road Vehicle Engine CASA/CASC	GDS61236	Drive Shaft	30		64	103.5	734					
	2007.11-	2010.05		L/R	R	Closed Off-Road Vehicle Engine CASA/CASC	GCI161064	Inner Joint	30	28	64	103.5	64					
3.2 V6 (162 kW)	2002.10-	2006.11	6MT/6AT			Closed Off-Road Vehicle Engine AZZ/BKJ/BMV/BMX/BRJ	GC061050	Outer Joint	30	27	64	103.5	63.5	M				
	2002.10-	2006.11	6MT/6AT	L/R		Closed Off-Road Vehicle Engine AZZ/BKJ/BMV/BMX/BRJ	GCI83027	Inner Joint		28		28						
	2002.10-	2006.11	6MT/6AT	L/R	F	Closed Off-Road Vehicle Engine AZZ/BKJ/BMV/BMX/BRJ	GDS99213	Drive Shaft	30		64	103.5	523					
	2002.10-	2006.11	6MT/6AT	L/R	F	Closed Off-Road Vehicle Engine AZZ/BKJ/BMV/BMX/BRJ	GCI99148	Inner Joint		28		34						
	2002.10-	2006.11	6MT/6AT	L/R	R	Closed Off-Road Vehicle Engine AZZ/BKJ/BMV/BMX/BRJ	GDS61236	Drive Shaft	30		64	103.5	734					
	2002.10-	2006.11	6MT/6AT	L/R	R	Closed Off-Road Vehicle Engine AZZ/BKJ/BMV/BMX/BRJ	GCI161064	Inner Joint	30	28	64	103.5	64					
	2002.10-	2006.11	6MT/6AT	L/R	R	Closed Off-Road Vehicle Engine AZZ/BKJ/BMV/BMX/BRJ	GCI161066	Inner Joint		28		28						
	2002.10-	2006.11	MT/AT	L/R	R	Closed Off-Road Vehicle Engine AZZ/BKJ/BMV/BMX/BRJ	GDS35086	Drive Shaft	30		64.3	103.5	724					
3.2 V6 (177 kW)	2004.11-	2006.11	6AT			Closed Off-Road Vehicle Engine BMV	GC061050	Outer Joint	30	27	64	103.5	63.5	M				
	2004.11-	2006.11	6AT		F	Closed Off-Road Vehicle Engine BMV	GCI99148	Inner Joint		28		34						
	2004.11-	2006.11	MT/AT	L/R	F	Closed Off-Road Vehicle Engine BMV	GDS99213	Drive Shaft	30		64	103.5	523					
	2004.11-	2006.11	MT		F	Closed Off-Road Vehicle Engine BMV	GDS99213	Drive Shaft	30		64	103.5	523					
	2004.11-	2006.11	MT/AT	L/R	R	Closed Off-Road Vehicle Engine BMV	GDS35086	Drive Shaft	30		64.3	103.5	724					
3.6 V6 FSi (206 kW)	2005.10-	2010.05	6MT/6AT			Closed Off-Road Vehicle Engine BHK/BHL	GC061050	Outer Joint	30	27	64	103.5	63.5	M				
	2005.10-	2010.05	6MT/6AT	L/R		Closed Off-Road Vehicle Engine BHK/BHL	GCI83027	Inner Joint		28		28						
	2005.10-	2010.05	6MT/6AT	L/R	F	Closed Off-Road Vehicle Engine BHK/BHL	GDS99213	Drive Shaft	30		64	103.5	523					
	2005.10-	2010.05	6MT/6AT	L/R	F	Closed Off-Road Vehicle Engine BHK/BHL	GCI99148	Inner Joint		28		34						
	2005.10-	2010.05	6MT/6AT	L/R	R	Closed Off-Road Vehicle Engine BHK/BHL	GDS61236	Drive Shaft	30		64	103.5	734					
	2005.10-	2010.05	6MT/6AT	L/R	R	Closed Off-Road Vehicle Engine BHK/BHL	GCI161064	Inner Joint	30	28	64	103.5	64					
	2005.10-	2010.05	6MT/6AT	L/R	R	Closed Off-Road Vehicle Engine BHK/BHL	GCI161066	Inner Joint		28		28						
	2005.10-	2010.05	MT/AT	L/R	R	Closed Off-Road Vehicle Engine BHK/BHL	GDS35086	Drive Shaft	30		64.3	103.5	724					
4.2 V8 (228 kW)	2002.12-	2006.11		L/R		Closed Off-Road Vehicle Engine AXQ	GCI83027	Inner Joint		28		28						
	2002.12-	2006.11		L/R	F	Closed Off-Road Vehicle Engine AXQ	GDS99213	Drive Shaft	30		64	103.5	523					
	2002.12-	2006.11		L/R	F	Closed Off-Road Vehicle Engine AXQ	GCI99148	Inner Joint		28		34						
	2002.12-	2006.11		L/R	R	Closed Off-Road Vehicle Engine AXQ	GDS61236	Drive Shaft	30		64	103.5	734					
	2002.12-	2006.11		L/R	R	Closed Off-Road Vehicle Engine AXQ	GCI161064	Inner Joint	30	28	64	103.5	64					
4.2 V8 FSi (257 kW)	2006.06-	2010.05	AT	L/R		Closed Off-Road Vehicle Engine BAR	GCI83027	Inner Joint		28		28						
	2006.06-	2010.05	AT	L/R	F	Closed Off-Road Vehicle Engine BAR	GCI99148	Inner Joint		28		34						
	2006.06-	2010.05		L/R	F	Closed Off-Road Vehicle Engine BAR	GDS99213	Drive Shaft	30		64	103.5	523					
	2006.06-	2010.05	AT	L/R	R	Closed Off-Road Vehicle Engine BAR	GCI35051	Inner Joint		30		30.5						
	2006.06-	2010.05	MT/AT	L/R	R	Closed Off-Road Vehicle Engine BAR	GDS35086	Drive Shaft	30		64.3	103.5	724					
	2006.06-	2010.05		L/R	R	Closed Off-Road Vehicle Engine BAR	GDS61236	Drive Shaft	30		64	103.5	734					
	2006.06-	2010.05		L/R	R	Closed Off-Road Vehicle Engine BAR	GCI161064	Inner Joint	30	28	64	103.5	64					
	2006.06-	2010.05		L/R	R	Closed Off-Road Vehicle Engine BAR	GCI161066	Inner Joint		28		28						
5.0 R50 TDi (257 kW)	2007.08-	2010.05			F	Closed Off-Road Vehicle Engine CBWA	GC083085	Outer Joint	30	29	64	103	72.5	M				
	2007.08-	2010.05		L/R	F	Closed Off-Road Vehicle Engine CBWA	GDS99213	Drive Shaft	30		64	103.5	523					
	2007.08-	2010.05	6MT/6AT	L/R	R	Closed Off-Road Vehicle Engine CBWA	GCI35051	Inner Joint		30		30.5						
	2007.08-	2010.05	MT/AT	L/R	R	Closed Off-Road Vehicle Engine CBWA	GDS35086	Drive Shaft	30		64.3	103.5	724					
5.0 V10 TDi (230 kW)	2002.10-	2010.05		L/R		Closed Off-Road Vehicle Engine AYH/BLE/BWF	GCI83027	Inner Joint		28		28						
	2002.10-	2010.05			F	Closed Off-Road Vehicle Engine AYH/BLE/BWF	GC083085	Outer Joint	30	29	64	103	72.5	M				
	2002.10-	2010.05		L/R	F	Closed Off-Road Vehicle Engine AYH/BLE/BWF	GDS99213	Drive Shaft	30		64	103.5	523					
	2002.10-	2010.05	6MT/6AT	L/R	R	Closed Off-Road Vehicle Engine AYH/BLE/BWF	GDS61236	Drive Shaft	30		64	103.5	734					
	2002.10-	2010.05	6MT/6AT	L/R	R	Closed Off-Road Vehicle Engine AYH/BLE/BWF	GCI161064	Inner Joint	30	28	64	103.5	64					
	2002.10-	2010.05	6MT/6AT	L/R	R	Closed Off-Road Vehicle Engine AYH/BLE/BWF	GCI161066	Inner Joint		28		28						
6.0 W12 (331 kW)	2004.08-	2010.05		L/R		Closed Off-Road Vehicle Engine BJN/CFRA	GCI83027	Inner Joint		28		28						
	2004.08-	2010.05			F	Closed Off-Road Vehicle Engine BJN/CFRA	GC083085	Outer Joint	30	29	64	103	72.5	M				
	2004.08-	2010.05		L/R	F	Closed Off-Road Vehicle Engine BJN/CFRA	GDS99213	Drive Shaft	30		64	103.5	523					
	2004.08-	2010.05		L/R	F	Closed Off-Road Vehicle Engine BJN/CFRA	GCI99148	Inner Joint		28		34						
	2004.08-	2010.05	6MT/6AT	L/R	R	Closed Off-Road Vehicle Engine BJN/CFRA	GDS61236	Drive Shaft	30		64	103.5	734					
	2004.08-	2010.05	6MT/6AT	L/R	R	Closed Off-Road Vehicle Engine BJN/CFRA	GCI161064	Inner Joint	30	28	64	103.5	64					
	2004.08-	2010.05	6MT/6AT	L/R	R	Closed Off-Road Vehicle Engine BJN/CFRA	GCI161066	Inner Joint		28		28						



		TRANSM	L/R	F/R		G-AP Ref.	PRODUCT	ABS	Technical Specifications										
									YEAR	A	B	C	H	L	P				
<b>VOLKSWAGEN</b>																			
<b>TOUAREG (7P5)</b>																			
3.0 V6 TDi (150 kW)	2010.01-		AT	L/R	F	Closed Off-Road Vehicle Engine CASD/CJMA	GCI99148	Inner Joint		28		34							
3.0 V6 TDi (165 kW)	2010.06-			L/R	F	Closed Off-Road Vehicle Engine CATA	GCI99148	Inner Joint		28		34							
3.0 V6 TDi (176 kW)	2010.01-			L/R	F	Closed Off-Road Vehicle Engine CASA/CNRB	GCI99148	Inner Joint		28		34							
3.0 V6 TDi (180 kW)	2011.05-			L/R	F	Closed Off-Road Vehicle Engine CJGD/CRCA	GCI99148	Inner Joint		28		34							
3.0 V6 TSi HybriD (245 kW)	2010.04-			L/R	F	Closed Off-Road VehicleHybrid Engine CGEA/CGFA	GCI99148	Inner Joint		28		34							
3.6 V6 FSi (206 kW)	2010.04-			L/R	F	Closed Off-Road Vehicle Engine CGRA	GCI99148	Inner Joint		28		34							
4.2 V8 FSi (265 kW)	2011.01-			L/R	F	Closed Off-Road Vehicle Engine CGNA	GCI99148	Inner Joint		28		34							
4.2 V8 TDi (250 kW)	2010.01-			L/R	F	Closed Off-Road Vehicle Engine CKDA	GCI99148	Inner Joint		28		34							
<b>TOUAREG I (7LA, 7L6, 7L7)</b>																			
2.5 R5 TDi (120 kW)	2003.01-	2010.05				Ch-7L4035000	GC061042	Outer Joint	38	27	63.9	102.5	63	M					
2.5 R5 TDi (128 kW)	2003.01-	2010.05				Ch-7L4035000	GC061042	Outer Joint	38	27	63.9	102.5	63	M					
3.0 TDi (155 kW)	2006-	2010					GC061050	Outer Joint	30	27	64	103.5	63.5	M					
3.0 TDi V6 (165 kW)	2004.11-	2010.05					GC061050	Outer Joint	30	27	64	103.5	63.5	M					
3.0 TDi V6 (176 kW)	2004.11-	2010.05					GC061050	Outer Joint	30	27	64	103.5	63.5	M					
3.2 V6 (162 kW)	2006-	2010					GC061050	Outer Joint	30	27	64	103.5	63.5	M					
3.2 V6 (177 kW)	2006-	2010					GC061050	Outer Joint	30	27	64	103.5	63.5	M					
3.6 V6 FSi (206 kW)	2006-	2010					GC061050	Outer Joint	30	27	64	103.5	63.5	M					
4.2 V8 (228 kW)	2002.12-	2006.11				Ch-7L4035000	GC061042	Outer Joint	38	27	63.9	102.5	63	M					
4.2 V8 FSi (257 kW)	2006.11-	2010					GC061050	Outer Joint	30	27	64	103.5	63.5	M					
5.0 V10 TDi (230 kW)	2007.06-						GC061050	Outer Joint	30	27	64	103.5	63.5	M					
6.0 W12 (331 kW)	2004.08-	2006.11					GC061042	Outer Joint	38	27	63.9	102.5	63	M					
	2007.06-						GC061050	Outer Joint	30	27	64	103.5	63.5	M					
<b>TOURAN (1T1, 1T2)</b>																			
1.4 TSi (103 kW)	2006.02-	2010.05	MT				GC083037	Outer Joint	36	30	59.5	40.5	55	I					
	2006.02-	2010.05				Double Clutch	GC083002	Outer Joint	36	27	59.5	40	66	I					
	2006.02-	2010.05					GCI83016	Inner Joint		28		32							
1.4 TSi (110 kW)	2006.02-	2010.05	MT				GC083037	Outer Joint	36	30	59.5	40.5	55	I					
	2006.02-	2010.05				Double Clutch	GC083002	Outer Joint	36	27	59.5	40	66	I					
	2006.02-	2010.05					GCI83016	Inner Joint		28		32							
1.4 TSi (125 kW)	2006.02-	2010.05				Double Clutch	GC083002	Outer Joint	36	27	59.5	40	66	I					
	2006.02-	2010.05					GCI83016	Inner Joint		28		32							
1.4 TSi EcoFuel (110 kW)	2009.05-		MT				GC083037	Outer Joint	36	30	59.5	40.5	55	I					
	2009.05-						GCI83016	Inner Joint		28		32							
	2009.05-						GC083002	Outer Joint	36	27	59.5	40	66	I					
1.6 (75 kW)	2003.07-	2010.05	MT				GC083037	Outer Joint	36	30	59.5	40.5	55	I					
1.6 FSi (75 kW)	2003.02-	2010.05	MT/AT			Engine BGA/ BL	GC083037	Outer Joint	36	30	59.5	40.5	55	I					
1.6 FSi (85 kW)	2003.02-	2010.05	MT/AT			Engine BGA/ BL	GC083037	Outer Joint	36	30	59.5	40.5	55	I					
1.9 TDi (66 kW)	2003.02-	2010.05	MT				GC083037	Outer Joint	36	30	59.5	40.5	55	I					
1.9 TDi (74 kW)	2003.02-	2010.05	MT				GC083037	Outer Joint	36	30	59.5	40.5	55	I					
1.9 TDi (77 kW)	2003.02-	2010.05	AT				GC083002	Outer Joint	36	27	59.5	40	66	I					
	2003.02-	2010.05	MT				GC083037	Outer Joint	36	30	59.5	40.5	55	I					
2.0 EcoFuel (80 kW)	2006.02-	2010.05					GC083037	Outer Joint	36	30	59.5	40.5	55	I					
2.0 FSi (110 kW)	2003.10-		AT			Engine BLX	GC083037	Outer Joint	36	30	59.5	40.5	55	I					
	2003.10-		MT/AT			Engine BLX	GC083037	Outer Joint	36	30	59.5	40.5	55	I					
2.0 TDi (100 kW)	2003.02-	2006.11	MT/AT				GC083002	Outer Joint	36	27	59.5	40	66	I					
	2003.02-	2006.11					GCI83016	Inner Joint		28		32							
2.0 TDi (103 kW)	2003.02-	2006.11	MT/AT				GC083002	Outer Joint	36	27	59.5	40	66	I					
	2003.02-	2006.11					GCI83016	Inner Joint		28		32							
2.0 TDi (125 kW)	2003.02-	2006.11	MT/AT				GC083002	Outer Joint	36	27	59.5	40	66	I					
	2003.02-	2006.11					GCI83016	Inner Joint		28		32							
<b>TOURAN (1T1, 1T2)</b>																			
1.4 FSi (125 kW)	2006.11-	2010.05			F	MPV Engine CAVB/BLG	GC083002	Outer Joint	36	27	59.5	40	66	I					
	2006.11-	2010.05	MT	L	F	MPV Engine CAVB/BLG	GDS83302	Drive Shaft	36		59.5	40	528						
1.4 TSi (103 kW)	2006.06-	2010.05			F	MPV Engine BMY/CAVC	GC083037	Outer Joint	36	30	59.5	40.5	55	I					
	2006.06-	2010.05	AT		F	MPV Engine BMY/CAVC	GC083002	Outer Joint	36	27	59.5	40	66	I					
	2006.06-	2010.05	MT		F	MPV Engine BMY/CAVC	GCI83011	Inner Joint		33		34							
	2006.06-	2010.05	MT	L	F	MPV Engine BMY/CAVC	GDS61201	Drive Shaft	36		59.5	40.5	535						
	2006.06-	2010.05	MT	L	F	MPV Engine BMY/CAVC	GDS61224	Drive Shaft	36		59.5	40	536						
1.4 TSi EcoFuel (110 kW)	2009.05-	2010.05	MT	L	F	MPV Engine CDGA	GDS61201	Drive Shaft	36		59.5	40.5	535						
1.6 (75 kW)	2003.08-	2010.05			F	MPV Engine BGU/BSE/BSF	GC083037	Outer Joint	36	30	59.5	40.5	55	I					
	2003.08-	2010.05			F	MPV Engine BGU/BSE/BSF	GCI83011	Inner Joint		33		34							





		TRANSM	L/R	F/R		G-AP Ref.	PRODUCT	ABS	Technical Specifications									
									YEAR	A	B	C	H	L	P			
<b>VOLKSWAGEN TOURAN (1T1, 1T2)</b>																		
1.6 (75 kW)	2003.08-2010.05	6AT		F	MPV Engine BGU/BSE/BSF	GCI61011	Inner Joint		26	32	31	68.5	85					
	2003.08-2010.05	MT		F	MPV Engine BGU/BSE/BSF	GCI53002	Inner Joint			33		34						
	2003.08-2010.05	6AT	L	F	MPV Engine BGU/BSE/BSF	GDS61093	Drive Shaft	36	26	59.5	40.5	587.5						
	2003.08-2010.05		L	F	MPV Engine BGU/BSE/BSF	GDS83373	Drive Shaft	36		59.5	38	511						
	2003.08-2010.05	6AT		R	F	MPV Engine BGU/BSE/BSF	GDS61094	Drive Shaft	36	26	59.5	40.5	884					
1.6 FSi (85 kW)	2003.08-2007.01			F	MPV Engine BAG/BLF/BLP	GC083037	Outer Joint	36	30	59.5	40.5	55	I					
	2003.08-2007.01			F	MPV Engine BAG/BLF/BLP	GCI83011	Inner Joint		33		34							
	2003.08-2007.01	MT		F	MPV Engine BAG/BLF/BLP	GCI53002	Inner Joint		33		34							
	2003.08-2007.01	MT	L	F	MPV Engine BAG/BLF/BLP	GDS61089	Drive Shaft	36		59.5	40.5	521						
1.9 TDi (66 kW)	2004.11-2010.05			F	MPV Engine BRU/BXF/BXJ	GC083037	Outer Joint	36	30	59.5	40.5	55	I					
	2004.11-2010.05			F	MPV Engine BRU/BXF/BXJ	GCI83011	Inner Joint		33		34							
	2004.11-2010.05	MT		F	MPV Engine BRU/BXF/BXJ	GCI53002	Inner Joint		33		34							
	2004.11-2010.05		L	F	MPV Engine BRU/BXF/BXJ	GDS83294	Drive Shaft	36		59.5	38	519						
	2004.11-2010.05		L	F	MPV Engine BRU/BXF/BXJ	GDS83295	Drive Shaft	36		59.5	40	491						
	2004.11-2010.05		R	F	MPV Engine BRU/BXF/BXJ	GDS83313	Drive Shaft	36		59.5	40	792						
1.9 TDi (74 kW)	2003.08-2010.05			F	MPV Engine AVQ	GC083037	Outer Joint	36	30	59.5	40.5	55	I					
	2003.08-2010.05			F	MPV Engine AVQ	GCI83011	Inner Joint		33		34							
	2003.08-2010.05	MT		F	MPV Engine AVQ	GCI53002	Inner Joint		33		34							
	2003.08-2010.05		L	F	MPV Engine AVQ	GDS83294	Drive Shaft	36		59.5	38	519						
	2003.08-2010.05	AT	L	F	MPV Engine AVQ	GDS83241	Drive Shaft	36		59.5	40	475						
	2003.08-2010.05	MT	L	F	MPV Engine AVQ	GDS61089	Drive Shaft	36		59.5	40.5	521						
	2003.08-2010.05		R	F	MPV Engine AVQ	GDS61042	Drive Shaft	36		59.5	40.5	814						
1.9 TDi (77 kW)	2003.08-2010.05	6AT		F	MPV Engine BKC/BLS/BXE	GCI54004	Inner Joint		34		85							
	2003.08-2010.05	AT		F	MPV Engine BKC/BLS/BXE	GC083002	Outer Joint	36	27	59.5	40	66	I					
	2003.08-2010.05	MT		F	MPV Engine BKC/BLS/BXE	GCI83011	Inner Joint		33		34							
	2003.08-2010.05	MT/6MT		F	MPV Engine BKC/BLS/BXE	GC083037	Outer Joint	36	30	59.5	40.5	55	I					
	2003.08-2010.05	AT	L	F	MPV Engine BKC/BLS/BXE	GDS83241	Drive Shaft	36		59.5	40	475						
	2003.08-2010.05	AT	L	F	MPV Engine BKC/BLS/BXE	GDS54013	Drive Shaft	36		59.5	40	479.5						
	2003.08-2010.05	MT	L	F	MPV Engine BKC/BLS/BXE	GDS61089	Drive Shaft	36		59.5	40.5	521						
	2003.08-2010.05	MT	L	F	MPV Engine BKC/BLS/BXE	GDS83294	Drive Shaft	36		59.5	38	519						
	2003.08-2010.05	MT	L	F	MPV Engine BKC/BLS/BXE	GDS83295	Drive Shaft	36		59.5	40	491						
	2003.08-2010.05	AT	L/R	F	MPV Engine BKC/BLS/BXE	GCI61057	Inner Joint		34		86							
	2003.08-2010.05	6AT	R	F	MPV Engine BKC/BLS/BXE	GDS54011	Drive Shaft	36		59.5	40	755						
	2003.08-2010.05	AT	R	F	MPV Engine BKC/BLS/BXE	GDS83355	Drive Shaft	36	23	59.5	40	799						
	2003.08-2010.05	MT	R	F	MPV Engine BKC/BLS/BXE	GDS83313	Drive Shaft	36		59.5	40	792						
	2003.08-2010.05	MT	R	F	MPV Engine BKC/BLS/BXE	GDS61042	Drive Shaft	36		59.5	40.5	814						
2.0 EcoFuel (80 kW)	2006.02-2009.05			F	MPV Engine BSX	GC083037	Outer Joint	36	30	59.5	40.5	55	I					
	2006.02-2009.05			F	MPV Engine BSX	GCI83011	Inner Joint		33		34							
	2006.02-2009.05	MT		F	MPV Engine BSX	GCI53002	Inner Joint		33		34							
	2006.02-2009.05		L	F	MPV Engine BSX	GDS83373	Drive Shaft	36		59.5	38	511						
2.0 FSi (110 kW)	2004.01-2006.12			F	MPV Engine AXW/BLR/BLX/BLY/BVY/BVZ	GC083037	Outer Joint	36	30	59.5	40.5	55	I					
	2004.01-2006.12	6AT		F	MPV Engine AXW/BLR/BLX/BLY/BVY/BVZ	GCI61011	Inner Joint	26	32	31	68.5	85						
	2004.01-2006.12	MT		F	MPV Engine AXW/BLR/BLX/BLY/BVY/BVZ	GCI83011	Inner Joint		33		34							
	2004.01-2006.12	6AT	L	F	MPV Engine AXW/BLR/BLX/BLY/BVY/BVZ	GDS61093	Drive Shaft	36	26	59.5	40.5	587.5						
	2004.01-2006.12	MT	L	F	MPV Engine AXW/BLR/BLX/BLY/BVY/BVZ	GDS61089	Drive Shaft	36		59.5	40.5	521						
	2004.01-2006.12	6AT	R	F	MPV Engine AXW/BLR/BLX/BLY/BVY/BVZ	GDS61094	Drive Shaft	36	26	59.5	40.5	884						
2.0 TDi (100 kW)	2003.08-2010.05	MT		F	MPV Engine AZV	GC083002	Outer Joint	36	27	59.5	40	66	I					
	2003.08-2010.05		L	F	MPV Engine AZV	GDS83265	Drive Shaft	36		59.5	40	487						
	2003.08-2010.05	AT	L	F	MPV Engine AZV	GDS83241	Drive Shaft	36		59.5	40	475						
	2003.08-2010.05	MT	L	F	MPV Engine AZV	GDS83236	Drive Shaft	36		59.5	40	484						
	2003.08-2010.05	MT	L	F	MPV Engine AZV	GDS83295	Drive Shaft	36		59.5	40	491						
	2003.08-2010.05		L	F	MPV Engine AZV	GCI83016	Inner Joint		28		32							
	2003.08-2010.05		R	F	MPV Engine AZV	GDS83313	Drive Shaft	36		59.5	40	792						
	2003.08-2010.05	MT	R	F	MPV Engine AZV	GDS61126	Drive Shaft	36		59.5	40	793						
2.0 TDi (103 kW)	2006.12-2010.05	6AT		F	MPV Engine BMM	GCI54004	Inner Joint		34		85							
	2006.12-2010.05	6MT/6AT		F	MPV Engine BMM	GC083002	Outer Joint	36	27	59.5	40	66	I					
	2006.12-2010.05	AT	L	F	MPV Engine BMM	GDS83241	Drive Shaft	36		59.5	40	475						
	2006.12-2010.05	AT	L	F	MPV Engine BMM	GDS54013	Drive Shaft	36		59.5	40	479.5						
	2006.12-2010.05	MT	L	F	MPV Engine BMM	GCI83016	Inner Joint		28		32							









		TRANSM	L/R	F/R		G-AP Ref.	PRODUCT	ABS	Technical Specifications									
									YEAR	A	B	C	H	L	P			
<b>VOLKSWAGEN</b>																		
<b>TOURAN (1T1, 1T2)</b>																		
2.0 TDi (103 kW)	2006.12-	2010.05	MT	L	F	MPV Engine BMM	GDS83265	Drive Shaft	36		59.5	40	487					
	2006.12-	2010.05	MT	L	F	MPV Engine BMM	GDS83295	Drive Shaft	36		59.5	40	491					
	2006.12-	2010.05	AT	R	F	MPV Engine BMM	GDS83355	Drive Shaft	36	23	59.5	40	799					
	2006.12-	2010.05	AT	R	F	MPV Engine BMM	GDS54011	Drive Shaft	36		59.5	40	755					
	2006.12-	2010.05	MT	R	F	MPV Engine BMM	GDS83313	Drive Shaft	36		59.5	40	792					
2.0 TDi (125 kW)	2006.06-	2010.05	6MT/6AT		F	MPV Engine BMN/CFJA	GC061045	Outer Joint	36	27	59.5	40	65	M				
	2006.06-	2010.05	AT	L	F	MPV Engine BMN/CFJA	GDS83241	Drive Shaft	36		59.5	40	475					
	2006.06-	2010.05	MT	L	F	MPV Engine BMN/CFJA	GDS83236	Drive Shaft	36		59.5	40	484					
	2006.06-	2010.05	MT	L	F	MPV Engine BMN/CFJA	GCI83016	Inner Joint		28		32						
	2006.06-	2010.05	MT	L	F	MPV Engine BMN/CFJA	GDS83265	Drive Shaft	36		59.5	40	487					
	2006.06-	2010.05	AT	L/R	F	MPV Engine BMN/CFJA	GCI61057	Inner Joint		34		86						
	2006.06-	2010.05	AT	R	F	MPV Engine BMN/CFJA	GDS83355	Drive Shaft	36	23	59.5	40	799					
	2006.06-	2010.05	AT	R	F	MPV Engine BMN/CFJA	GDS54011	Drive Shaft	36		59.5	40	755					
	2006.06-	2010.05	MT	R	F	MPV Engine BMN/CFJA	GDS61126	Drive Shaft	36		59.5	40	793					
2.0 TDi 16V (103 kW)	2003.08-	2010.05	6AT		F	MPV Engine BKD	GCI54004	Inner Joint		34		85						
	2003.08-	2010.05	AT		F	MPV Engine BKD	GC083002	Outer Joint	36	27	59.5	40	66	I				
	2003.08-	2010.05	AT	L	F	MPV Engine BKD	GDS54013	Drive Shaft	36		59.5	40	479.5					
	2003.08-	2010.05	MT	L	F	MPV Engine BKD	GCI83016	Inner Joint		28		32						
	2003.08-	2010.05	MT	L	F	MPV Engine BKD	GDS83265	Drive Shaft	36		59.5	40	487					
	2003.08-	2010.05	MT	L	F	MPV Engine BKD	GDS83295	Drive Shaft	36		59.5	40	491					
	2003.08-	2010.05		L	F	MPV Engine BKD	GDS83241	Drive Shaft	36		59.5	40	475					
	2003.08-	2010.05	AT	L/R	F	MPV Engine BKD	GCI61057	Inner Joint		34		86						
	2003.08-	2010.05	AT	R	F	MPV Engine BKD	GDS83355	Drive Shaft	36	23	59.5	40	799					
	2003.08-	2010.05	AT	R	F	MPV Engine BKD	GDS54011	Drive Shaft	36		59.5	40	755					
	2003.08-	2010.05	MT	R	F	MPV Engine BKD	GDS83313	Drive Shaft	36		59.5	40	792					
	<b>TOURAN (1T3)</b>																	
	1.2 TSi (77 kW)	2010.05-		MT	L	F	MPV Engine CBZB	GDS61198	Drive Shaft	36		59.5	40.5	530				
2010.05-							GC083037	Outer Joint	36	30	59.5	40.5	55	I				
1.4 TSi (103 kW)	2010.05-		MT	L	F	MPV Engine CAVC/CTHC	GDS61201	Drive Shaft	36		59.5	40.5	535					
	2010.05-		MT				GC083037	Outer Joint	36	30	59.5	40.5	55	I				
	2010.05-					Double Clutch	GC083002	Outer Joint	36	27	59.5	40	66	I				
	2010.05-					Double Clutch	GCI83016	Inner Joint		28		32						
1.4 TSi (125 kW)	2010.05-		MT	L	F	MPV Engine CAVB/CTHB	GDS83302	Drive Shaft	36		59.5	40	528					
	2010.05-					Double Clutch	GC083002	Outer Joint	36	27	59.5	40	66	I				
	2010.05-					Double Clutch	GCI83016	Inner Joint		28		32						
1.4 TSi EcoFuel (110 kW)	2010.05-		MT	L	F	MPV Engine CDGA	GDS61201	Drive Shaft	36		59.5	40.5	535					
	2010.05-		MT				GC083037	Outer Joint	36	30	59.5	40.5	55	I				
	2010.05-					Double Clutch	GC083002	Outer Joint	36	27	59.5	40	66	I				
	2010.05-					Double Clutch	GCI83016	Inner Joint		28		32						
1.6 TDi (66 kW)	2010.05-		MT	R	F	MPV Engine CAYB	GDS61200	Drive Shaft	36		59.5	40.5	820					
	2010.05-		MT			MPV Engine CAYB	GC083100	Outer Joint	36	33	59.5	38	55	I				
	2010.05-					Double Clutch	GC083002	Outer Joint	36	27	59.5	40	66	I				
	2010.05-					Double Clutch	GCI83016	Inner Joint		28		32						
	2010.05-					MPV Engine CAYB	GC061059	Outer Joint	36	33	59.5	40	59.5	I				
1.6 TDi (77 kW)	2010.05-			L	F	MPV Engine CAYC	GDS83236	Drive Shaft	36		59.5	40	484					
	2010.05-		MT	R	F	MPV Engine CAYC	GDS61200	Drive Shaft	36		59.5	40.5	820					
	2010.05-		MT			MPV Engine CAYC	GC083100	Outer Joint	36	33	59.5	38	55	I				
	2010.05-					Double Clutch	GC083002	Outer Joint	36	27	59.5	40	66	I				
	2010.05-					Double Clutch	GCI83016	Inner Joint		28		32						
	2010.05-					MPV Engine CAYC	GC061059	Outer Joint	36	33	59.5	40	59.5	I				
2.0 TDi (103 kW)	2010.05-		AT	L	F	MPV Engine CFHC	GDS54013	Drive Shaft	36		59.5	40	479.5					
	2010.05-		MT	L	F	MPV Engine CFHC	GDS83295	Drive Shaft	36		59.5	40	491					
	2010.05-		AT	R	F	MPV Engine CFHC	GDS54011	Drive Shaft	36		59.5	40	755					
	2010.05-		MT	R	F	MPV Engine CFHC	GDS83313	Drive Shaft	36		59.5	40	792					
	2010.05-		MT	L	F	MPV Engine CFHC	GDS83236	Drive Shaft	36		59.5	40	484					
	2010.05-			L	F	MPV Engine CFHC	GDS83241	Drive Shaft	36		59.5	40	475					
	2010.05-		AT	R	F	MPV Engine CFHC	GDS83355	Drive Shaft	36	23	59.5	40	799					
	2010.05-		MT	R	F	MPV Engine CFHC	GDS61126	Drive Shaft	36		59.5	40	793					
	2010.11-		MT				GCI83016	Inner Joint		28		32						
	2010.11-		MT				GC083002	Outer Joint	36	27	59.5	40	66	I				
2.0 TDi (125 kW)	2010.05-	2013.01	AT	L	F	MPV Engine CFJA	GDS83241	Drive Shaft	36		59.5	40	475					



		TRANSM	L/R	F/R		G-AP Ref.	PRODUCT	ABS	Technical Specifications							
									YEAR	A	B	C	H	L	P	
<b>VOLKSWAGEN</b>																
<b>TOURAN (1T3)</b>																
2.0 TDi (125 kW)	2010.05-	2013.01	MT	L	F	MPV Engine CFJA	GDS83236	Drive Shaft	36		59.5	40	484			
	2010.05-	2013.01		R	F	MPV Engine CFJA	GDS54011	Drive Shaft	36		59.5	40	755			
	2010.05-	2013.01	AT	R	F	MPV Engine CFJA	GDS83355	Drive Shaft	36	23	59.5	40	799			
	2010.05-	2013.01	MT	R	F	MPV Engine CFJA	GDS61126	Drive Shaft	36		59.5	40	793			
2.0 TDi (81 kW)	2010.11-		AT	L	F	MPV Engine CLCA/CFHF	GDS54013	Drive Shaft	36		59.5	40	479.5			
	2010.11-		MT	L	F	MPV Engine CLCA/CFHF	GDS83294	Drive Shaft	36		59.5	38	519			
	2010.11-		AT	R	F	MPV Engine CLCA/CFHF	GDS54011	Drive Shaft	36		59.5	40	755			
	2010.11-		MT	R	F	MPV Engine CLCA/CFHF	GDS61042	Drive Shaft	36		59.5	40.5	814			
	2010.11-		AT	L	F	MPV Engine CLCA/CFHF	GDS83241	Drive Shaft	36		59.5	40	475			
	2010.11-		MT	L	F	MPV Engine CLCA/CFHF	GDS61089	Drive Shaft	36		59.5	40.5	521			
	2010.11-		AT	R	F	MPV Engine CLCA/CFHF	GDS83355	Drive Shaft	36	23	59.5	40	799			
	2010.11-		MT				GC083037	Outer Joint	36	30	59.5	40.5	55	I		
	2010.11-		MT				GC083002	Outer Joint	36	27	59.5	40	66	I		
<b>TRANSPORTER / CARAVELLE III</b>																
1.6 (37 kW)	1979.05-	1982.12	MT/AT		R	Bus Engine CT	GCI61003	Inner Joint			33		32			
1.6 D (37 kW)	1981.01-	1987.07	MT	L/R	R	Bus Engine CS	GDS61005	Drive Shaft					32	540		
	1981.01-	1987.07	MT		R	Bus Engine CS	GCI61003	Inner Joint			33		32			
1.6 TD (51 kW)	1984.08-	1992.07	MT	L/R	R	Bus Engine JX	GDS61005	Drive Shaft					32	540		
	1984.08-	1992.07	MT		R	Bus Engine JX	GCI61003	Inner Joint			33		32			
1.6 TD Syncro (51 kW)	1986.03-	1992.07	MT	L/R	R	Bus Engine JX	GDS61005	Drive Shaft					32	540		
	1986.03-	1992.07	MT		R	Bus Engine JX	GCI61003	Inner Joint			33		32			
	1986.03-	1992.07	MT	L/R	F	Bus Engine JX	GDS61092	Drive Shaft	26		65	104	712			
1.7 D (42 kW)	1986.10-	1992.07	MT	L/R	R	Bus Engine KY	GDS61005	Drive Shaft					32	540		
	1986.10-	1992.07	MT		R	Bus Engine KY	GCI61003	Inner Joint			33		32			
1.9 (44 kW)	1982.08-	1992.07	MT	L/R	R	Bus Engine DF	GDS61005	Drive Shaft					32	540		
	1982.08-	1992.07	MT/AT		R	Bus Engine DF	GCI61003	Inner Joint			33		32			
1.9 (57 kW)	1982.08-	1992.07	MT	L/R	R	Bus Engine DG	GDS61005	Drive Shaft					32	540		
	1982.08-	1992.07	MT/AT		R	Bus Engine DG	GCI61003	Inner Joint			33		32			
1.9 (61 kW)	1983.01-	1985.07	MT	L/R	R	Bus Engine DH	GDS61005	Drive Shaft					32	540		
	1983.01-	1985.07	MT/AT		R	Bus Engine DH	GCI61003	Inner Joint			33		32			
1.9 (66 kW)	1983.08-	1985.07	MT	L/R	R	Bus Engine GW	GDS61005	Drive Shaft					32	540		
	1983.08-	1985.07	MT/AT		R	Bus Engine GW	GCI61003	Inner Joint			33		32			
1.9 Syncro (57 kW)	1985.02-	1992.07	MT	L/R	F	Bus Engine DG	GDS61092	Drive Shaft	26		65	104	712			
	1985.02-	1992.07	MT	L/R	R	Bus Engine DG	GDS61005	Drive Shaft					32	540		
	1985.02-	1992.07	MT		R	Bus Engine DG	GCI61003	Inner Joint			33		32			
2.0 (51 kW)	1979.05-	1982.12	MT/AT		R	Bus Engine CU/CV	GCI61003	Inner Joint			33		32			
2.1 (64 kW)	1986.10-	1992.07	MT	L/R	R	Bus Engine SR	GDS61005	Drive Shaft					32	540		
	1986.10-	1992.07	MT/AT		R	Bus Engine SR	GCI61003	Inner Joint			33		32			
2.1 (70 kW)	1985.08-	1992.07	MT	L/R	R	Bus Engine MV	GDS61005	Drive Shaft					32	540		
	1985.08-	1992.07	MT/AT		R	Bus Engine MV	GCI61003	Inner Joint			33		32			
2.1 (82 kW)	1985.08-	1992.07	MT	L/R	R	Bus Engine DJ	GDS61005	Drive Shaft					32	540		
	1985.08-	1992.07	MT/AT		R	Bus Engine DJ	GCI61003	Inner Joint			33		32			
2.1 CAT (70 kW)	1989.06-	1992.07	MT	L/R	R	Bus Engine MV	GDS61005	Drive Shaft					32	540		
	1989.06-	1992.07	MT/AT		R	Bus Engine MV	GCI61003	Inner Joint			33		32			
2.1 i (68 kW)	1989.07-	1992.07	MT	L/R	R	Bus Engine SS	GDS61005	Drive Shaft					32	540		
	1989.07-	1992.07	MT/AT		R	Bus Engine SS	GCI61003	Inner Joint			33		32			
2.1 Syncro (64 kW)	1986.10-	1992.07	MT	L/R	F	Bus Engine SR	GDS61092	Drive Shaft	26		65	104	712			
	1986.10-	1992.07	MT	L/R	R	Bus Engine SR	GDS61005	Drive Shaft					32	540		
	1986.10-	1992.07	MT		R	Bus Engine SR	GCI61003	Inner Joint			33		32			
2.1 Syncro (70 kW)	1985.08-	1992.07	MT	L/R	F	Bus Engine MV	GDS61092	Drive Shaft	26		65	104	712			
	1985.08-	1992.07	MT	L/R	R	Bus Engine MV	GDS61005	Drive Shaft					32	540		
	1985.08-	1992.07	MT		R	Bus Engine MV	GCI61003	Inner Joint			33		32			
2.1 Syncro (82 kW)	1986.01-	1992.07	MT	L/R	F	Bus Engine DJ	GDS61092	Drive Shaft	26		65	104	712			
	1986.01-	1992.07	MT	L/R	R	Bus Engine DJ	GDS61005	Drive Shaft					32	540		
	1986.01-	1992.07	MT		R	Bus Engine DJ	GCI61003	Inner Joint			33		32			
<b>TRANSPORTER / CARAVELLE IV (70XB, 70XC, 7DB, 7DW)</b>																
1.9 TD (50 kW)	1992.10-	2003.04			F	Bus Engine ABL	GCI61001	Inner Joint			33		31.8			
	1992.10-	2003.04	MT		F	Bus Engine ABL	GC061003	Outer Joint	38	33	60.2	34.5	65	I		
	1992.10-	2003.04	MT		F	Bus Engine ABL	GC061004	Outer Joint	48T	38	33	60.2	34.5	65	I	
	1992.10-	2003.04	MT		F	Bus Engine ABL	GCI61002	Inner Joint			28		31.8			
	1992.10-	2003.04	MT		F	Bus Engine ABL	GC061005	Outer Joint			38	27	60.2	34.5	65	I

		YEAR	TRANSM	L/R	F/R		G-AP Ref.	PRODUCT	ABS	Technical Specifications										
										A	B	C	H	L	P					
<b>VOLKSWAGEN</b>																				
<b>TRANSPORTER / CARAVELLE IV (70XB, 70XC, 7DB, 7DW)</b>																				
1.9 TD (50 kW)	1992.10-	2003.04	MT		F	Bus Engine ABL	GC061006	Outer Joint	48T	38	27	60.2	34.5	65	I					
	1992.10-	2003.04	MT	L/R	F	Bus Engine ABL	GDS61003	Drive Shaft		38		60.2	34.5	540.8						
	1992.10-	2003.04	MT	L/R	F	Bus Engine ABL	GDS61119	Drive Shaft		38		60.2	34.5	527						
	1992.10-	2003.04	MT	L/R	F	Bus Engine ABL	GDS61004	Drive Shaft	48T	38		60.2	34.5	540.8						
2.0 (62 kW)	1990.09-	2003.04	MT		F	Bus Engine AAC	GC061003	Outer Joint		38	33	60.2	34.5	65	I					
	1990.09-	2003.04	MT		F	Bus Engine AAC	GC061004	Outer Joint	48T	38	33	60.2	34.5	65	I					
	1990.09-	2003.04	MT		F	Bus Engine AAC	GCI61002	Inner Joint			28		31.8							
	1990.09-	2003.04	MT		F	Bus Engine AAC	GC061005	Outer Joint		38	27	60.2	34.5	65	I					
	1990.09-	2003.04	MT		F	Bus Engine AAC	GC061006	Outer Joint	48T	38	27	60.2	34.5	65	I					
	1990.09-	2003.04	MT/AT		F	Bus Engine AAC	GCI61001	Inner Joint			33		31.8							
	1990.09-	2003.04	MT	L/R	F	Bus Engine AAC	GDS61003	Drive Shaft		38		60.2	34.5	540.8						
	1990.09-	2003.04	MT	L/R	F	Bus Engine AAC	GDS61119	Drive Shaft		38		60.2	34.5	527						
2.4 D (55 kW)	1997.08-	2003.04	MT/AT		F	Bus Engine AJA	GDS61004	Drive Shaft	48T	38		60.2	34.5	540.8						
	1997.08-	2003.04	MT/AT		F	Bus Engine AJA	GCI61002	Inner Joint			28		31.8							
	1997.08-	2003.04	MT/AT		F	Bus Engine AJA	GC061005	Outer Joint		38	27	60.2	34.5	65	I					
	1997.08-	2003.04	MT/AT		F	Bus Engine AJA	GC061006	Outer Joint	48T	38	27	60.2	34.5	65	I					
	1997.08-	2003.04	MT	L/R	F	Bus Engine AJA	GDS61003	Drive Shaft		38		60.2	34.5	540.8						
	1997.08-	2003.04	MT	L/R	F	Bus Engine AJA	GDS61004	Drive Shaft	48T	38		60.2	34.5	540.8						
	1997.08-	2003.04	AT	R	F	Bus Engine AJA	GDS61003	Drive Shaft		38		60.2	34.5	540.8						
2.5 (81 kW)	1990.11-	2003.04	MT/AT		F	Bus Engine AAF/ACU/AEN/AEU	GDS61004	Drive Shaft		38		60.2	34.5	540.8						
	1990.11-	2003.04	MT/AT		F	Bus Engine AAF/ACU/AEN/AEU	GC061003	Outer Joint		38	33	60.2	34.5	65	I					
	1990.11-	2003.04	MT/AT		F	Bus Engine AAF/ACU/AEN/AEU	GC061004	Outer Joint	48T	38	33	60.2	34.5	65	I					
	1990.11-	2003.04	MT/AT		F	Bus Engine AAF/ACU/AEN/AEU	GCI61001	Inner Joint			33		31.8							
	1990.11-	2003.04	MT/AT		F	Bus Engine AAF/ACU/AEN/AEU	GCI61002	Inner Joint			28		31.8							
	1990.11-	2003.04	MT/AT		F	Bus Engine AAF/ACU/AEN/AEU	GC061005	Outer Joint		38	27	60.2	34.5	65	I					
	1990.11-	2003.04	MT/AT		F	Bus Engine AAF/ACU/AEN/AEU	GC061006	Outer Joint	48T	38	27	60.2	34.5	65	I					
	1990.11-	2003.04	MT	L	F	Bus Engine AAF/ACU/AEN/AEU	GDS61003	Drive Shaft		38		60.2	34.5	540.8						
	1990.11-	2003.04	MT	L	F	Bus Engine AAF/ACU/AEN/AEU	GDS61119	Drive Shaft		38		60.2	34.5	527						
	1990.11-	2003.04	MT	L	F	Bus Engine AAF/ACU/AEN/AEU	GDS61004	Drive Shaft	48T	38		60.2	34.5	540.8						
2.5 (85 kW)	1990.11-	2003.04	MT/AT	R	F	Bus Engine AAF/ACU/AEN/AEU	GDS61003	Drive Shaft		38		60.2	34.5	540.8						
	1990.11-	2003.04	MT/AT	R	F	Bus Engine AAF/ACU/AEN/AEU	GDS61119	Drive Shaft		38		60.2	34.5	527						
	1990.11-	2003.04	MT/AT	R	F	Bus Engine AAF/ACU/AEN/AEU	GDS61004	Drive Shaft	48T	38		60.2	34.5	540.8						
	1996.08-	2003.04	MT/AT		F	Bus Engine AET/APL/AVT	GCI61002	Inner Joint			28		31.8							
	1996.08-	2003.04	MT/AT		F	Bus Engine AET/APL/AVT	GC061005	Outer Joint		38	27	60.2	34.5	65	I					
	1996.08-	2003.04	MT/AT		F	Bus Engine AET/APL/AVT	GC061006	Outer Joint	48T	38	27	60.2	34.5	65	I					
2.5 Syncro (81 kW)	1996.08-	2003.04	MT	L/R	F	Bus Engine AET/APL/AVT	GDS61003	Drive Shaft		38		60.2	34.5	540.8						
	1996.08-	2003.04	MT	L/R	F	Bus Engine AET/APL/AVT	GDS61004	Drive Shaft	48T	38		60.2	34.5	540.8						
	1992.11-	2003.04	MT/AT		F	Bus Engine AAF/ACU/AEN/AEU	GC061003	Outer Joint		38	33	60.2	34.5	65	I					
	1992.11-	2003.04	MT/AT		F	Bus Engine AAF/ACU/AEN/AEU	GC061004	Outer Joint	48T	38	33	60.2	34.5	65	I					
	1992.11-	2003.04	MT/AT		F	Bus Engine AAF/ACU/AEN/AEU	GCI61002	Inner Joint			28		31.8							
2.5 Syncro (85 kW)	1992.11-	2003.04	MT/AT		F	Bus Engine AAF/ACU/AEN/AEU	GC061005	Outer Joint		38	27	60.2	34.5	65	I					
	1992.11-	2003.04	MT/AT		F	Bus Engine AAF/ACU/AEN/AEU	GC061006	Outer Joint	48T	38	27	60.2	34.5	65	I					
	1996.07-	2003.04	MT/AT		F	Bus Engine AET/APL/AVT	GCI61002	Inner Joint			28		31.8							
	1996.07-	2003.04	MT/AT		F	Bus Engine AET/APL/AVT	GC061005	Outer Joint		38	27	60.2	34.5	65	I					
2.5 TDi (111 kW)	1996.07-	2003.04	MT/AT		F	Bus Engine AET/APL/AVT	GC061006	Outer Joint	48T	38	27	60.2	34.5	65	I					
	1998.05-	2003.04	5MT		F	Bus Engine AHY/AXG	GCI61030	Inner Joint			30		32							
	1998.05-	2003.04	5MT		F	Bus Engine AHY/AXG	GC061006	Outer Joint	48T	38	27	60.2	34.5	65	I					
2.5 TDi (65 kW)	1998.05-	2003.04	MT		F	Bus Engine AJT/AYY	GCI61002	Inner Joint			28		31.8							
	1998.05-	2003.04	MT		F	Bus Engine AJT/AYY	GC061005	Outer Joint		38	27	60.2	34.5	65	I					
	1998.05-	2003.04	MT		F	Bus Engine AJT/AYY	GC061006	Outer Joint	48T	38	27	60.2	34.5	65	I					
	1998.05-	2003.04	MT	L/R	F	Bus Engine AJT/AYY	GDS61003	Drive Shaft		38		60.2	34.5	540.8						
	1998.05-	2003.04	MT	L/R	F	Bus Engine AJT/AYY	GDS61004	Drive Shaft	48T	38		60.2	34.5	540.8						
2.5 TDi (75 kW)	1995.09-	2003.04	MT/AT		F	Bus Engine AYC/AUF/ACV	GCI61002	Inner Joint			28		31.8							
	1995.09-	2003.04	MT/AT		F	Bus Engine AYC/AUF/ACV	GC061005	Outer Joint		38	27	60.2	34.5	65	I					
	1995.09-	2003.04	MT/AT		F	Bus Engine AYC/AUF/ACV	GC061006	Outer Joint	48T	38	27	60.2	34.5	65	I					
	1995.09-	2003.04	MT	L/R	F	Bus Engine AYC/AUF/ACV	GDS61003	Drive Shaft		38		60.2	34.5	540.8						
	1995.09-	2003.04	MT	L/R	F	Bus Engine AYC/AUF/ACV	GDS61004	Drive Shaft	48T	38		60.2	34.5	540.8						
	1995.09-	2003.04	MT	L/R	F	Bus Engine AYC/AUF/ACV	GDS61052	Drive Shaft	48T	38		60.2	34.5	529						
	1995.09-	2003.04	MT	L/R	F	Bus Engine AYC/AUF/ACV	GDS61034	Drive Shaft		38		60.2	34.5	529						
1995.09-	2003.04	MT/AT	R	F	Bus Engine AYC/AUF/ACV	GDS61003	Drive Shaft		38		60.2	34.5	540.8							
1995.09-	2003.04	MT/AT	R	F	Bus Engine AYC/AUF/ACV	GDS61004	Drive Shaft	48T	38		60.2	34.5	540.8							









		YEAR	TRANSM	L/R	F/R		G-AP Ref.	PRODUCT	ABS	Technical Specifications										
										A	B	C	H	L	P					
<b>VOLKSWAGEN</b>																				
<b>TRANSPORTER / CARAVELLE IV (70XB, 70XC, 7DB, 7DW)</b>																				
2.5 TDi Syncro (75 kW)	1996.01-	2003.04	MT/AT		F	Bus Engine ACV/AXL	GCI61002	Inner Joint		28		31.8								
	1996.01-	2003.04	MT/AT		F	Bus Engine ACV/AXL	GC061005	Outer Joint	38	27	60.2	34.5	65	I						
	1996.01-	2003.04	MT/AT		F	Bus Engine ACV/AXL	GC061006	Outer Joint	48T	38	27	60.2	34.5	65	I					
2.8 VR6 (150 kW)	2000.04-	2003.04			F	Bus Engine AMV	GC061006	Outer Joint	48T	38	27	60.2	34.5	65	I					
	2000.04-	2003.04			F	Bus Engine AMV	GCI61030	Inner Joint		30		32								
<b>TRANSPORTER / CARAVELLE MK V (7HB, 7HJ, 7EB, 7EJ, 7EF)</b>																				
3.2 4motion (170 kW)	2003.11-	2006.06	5MT			Bus Engine BDL	GDS61190	Stub Shaft	26	37	50		136.5							
	2003.11-	2006.06	6MT			Bus Engine BDL	GDS61191	Stub Shaft	26	42	60		135.5							
<b>TRANSPORTER / CARAVELLE V (7HB, 7HJ, 7EB, 7EJ, 7EF)</b>																				
1.9 TDi (62 kW)	2006.01-	2009.11	MT		F	Bus Engine BRR	GCI61041	Inner Joint		28		32								
	2006.01-	2009.11	MT		F	Bus Engine BRR	GCI61020	Inner Joint	26	28	50	205.5	63							
	2006.01-	2009.11		L	F	Bus Engine BRR	GDS61105	Drive Shaft	38		63	102.5	645							
	2006.01-	2009.11		R	F	Bus Engine BRR	GDS83246	Drive Shaft	38	26	63	102.5	858							
	2006.01-	2009.11	AT	R	F	Bus Engine BRR	GDS83267	Drive Shaft	38	26	63	102.5	925							
	2006.01-	2009.11	6MT		F	Bus Engine BRR	GDS61191	Stub Shaft	26	42	60		135.5							
	2006.01-	2009.11	5MT		F	Bus Engine BRR	GDS61190	Stub Shaft	26	37	50		136.5							
1.9 TDi (63 kW)	2003.04-	2009.11	6MT		F	Bus Engine AXC	GDS61191	Stub Shaft	26	42	60		135.5							
	2003.04-	2009.11			F	Bus Engine AXC	GC061009	Outer Joint	38	27	63	102	66	M						
	2003.04-	2009.11	MT		F	Bus Engine AXC	GCI61041	Inner Joint		28		32								
	2003.04-	2009.11	MT		F	Bus Engine AXC	GCI61020	Inner Joint	26	28	50	205.5	63							
	2003.04-	2009.11	5MT	L	F	Bus Engine AXC	GDS61105	Drive Shaft	38		63	102.5	645							
	2003.04-	2009.11	5MT	R	F	Bus Engine AXC	GDS83246	Drive Shaft	38	26	63	102.5	858							
	2003.04-	2009.11	AT	R	F	Bus Engine AXC	GDS83267	Drive Shaft	38	26	63	102.5	925							
	2003.04-	2009.11	5MT		F	Bus Engine AXC	GDS61190	Stub Shaft	26	37	50		136.5							
	2003.04-	2009.11	6MT		F	Bus Engine AXC	GDS61191	Stub Shaft	26	42	60		135.5							
	2003.04-	2009.11	5MT		F	Bus Engine AXC	GDS61190	Stub Shaft	26	37	50		136.5							
1.9 TDi (75 kW)	2006.06-	2009.11	6MT		F	Bus Engine BRS	GDS61191	Stub Shaft	26	42	60		135.5							
	2006.06-	2009.11	MT		F	Bus Engine BRS	GCI61041	Inner Joint		28		32								
	2006.06-	2009.11	MT		F	Bus Engine BRS	GCI61020	Inner Joint	26	28	50	205.5	63							
	2006.06-	2009.11		L	F	Bus Engine BRS	GDS61105	Drive Shaft	38		63	102.5	645							
	2006.06-	2009.11		R	F	Bus Engine BRS	GDS83246	Drive Shaft	38	26	63	102.5	858							
	2006.06-	2009.11	AT	R	F	Bus Engine BRS	GDS83267	Drive Shaft	38	26	63	102.5	925							
	2006.06-	2009.11	5MT		F	Bus Engine BRS	GDS61190	Stub Shaft	26	37	50		136.5							
1.9 TDi (77 kW)	2003.04-	2009.11	6MT		F	Bus Engine AXB	GDS61191	Stub Shaft	26	42	60		135.5							
	2003.04-	2009.11			F	Bus Engine AXB	GC061009	Outer Joint	38	27	63	102	66	M						
	2003.04-	2009.11	MT		F	Bus Engine AXB	GCI61041	Inner Joint		28		32								
	2003.04-	2009.11	MT		F	Bus Engine AXB	GCI61020	Inner Joint	26	28	50	205.5	63							
	2003.04-	2009.11	5MT	L	F	Bus Engine AXB	GDS61105	Drive Shaft	38		63	102.5	645							
	2003.04-	2009.11	5MT	R	F	Bus Engine AXB	GDS83246	Drive Shaft	38	26	63	102.5	858							
	2003.04-	2009.11	AT	R	F	Bus Engine AXB	GDS83267	Drive Shaft	38	26	63	102.5	925							
	2003.04-	2009.11	5MT		F	Bus Engine AXB	GDS61190	Stub Shaft	26	37	50		136.5							
	2003.04-	2009.11	6MT		F	Bus Engine AXB	GDS61191	Stub Shaft	26	42	60		135.5							
	2003.04-	2009.11	5MT		F	Bus Engine AXB	GDS61190	Stub Shaft	26	37	50		136.5							
2.0 (85 kW)	2003.11-		6MT		F	Bus Engine AXA	GDS61191	Stub Shaft	26	42	60		135.5							
	2003.11-				F	Bus Engine AXA	GC061009	Outer Joint	38	27	63	102	66	M						
	2003.11-		MT		F	Bus Engine AXA	GCI61041	Inner Joint		28		32								
	2003.11-		MT		F	Bus Engine AXA	GCI61020	Inner Joint	26	28	50	205.5	63							
	2003.11-		5MT	L	F	Bus Engine AXA	GDS61105	Drive Shaft	38		63	102.5	645							
	2003.11-		5MT	R	F	Bus Engine AXA	GDS83246	Drive Shaft	38	26	63	102.5	858							
	2003.11-		5MT		F	Bus Engine AXA	GDS61190	Stub Shaft	26	37	50		136.5							
2.0 BiTDi (132 kW)	2009.09-		5MT		F	Bus Engine CFCA	GDS61190	Stub Shaft	26	37	50		136.5							
	2009.09-		AT		F	Bus Engine CFCA	GC061011	Outer Joint	38	29	63	102.5	70	M						
	2009.09-		AT	L	F	Bus Engine CFCA	GDS83293	Drive Shaft	38	37	63	102.5	645							
	2009.09-		6MT		F	Bus Engine CFCA	GDS61191	Stub Shaft	26	42	60		135.5							
2.0 BiTDi 4motion (132 kW)	2009.09-		5MT			Bus Engine CFCA	GDS61190	Stub Shaft	26	37	50		136.5							
	2009.09-					Bus Engine CFCA	GC061011	Outer Joint	38	29	63	102.5	70	M						
	2009.09-		AT	L	F	Bus Engine CFCA	GDS83293	Drive Shaft	38	37	63	102.5	645							
	2009.09-		6MT			Bus Engine CFCA	GDS61191	Stub Shaft	26	42	60		135.5							
2.0 TDi (100 kW)	2010.05-		5MT		F	Bus Engine CAAE/CCHB	GDS61190	Stub Shaft	26	37	50		136.5							
	2010.05-		6MT		F	Bus Engine CAAE/CCHB	GDS61191	Stub Shaft	26	42	60		135.5							
2.0 TDi (103 kW)	2009.09-		5MT		F	Bus Engine CAAC/CCHA	GDS61190	Stub Shaft	26	37	50		136.5							
	2009.09-		AT		F	Bus Engine CAAC/CCHA	GC061011	Outer Joint	38	29	63	102.5	70	M						
	2009.09-		AT	L	F	Bus Engine CAAC/CCHA	GDS83293	Drive Shaft	38	37	63	102.5	645							
	2009.09-		MT	R	F	Bus Engine CAAC/CCHA	GDS83261	Drive Shaft	38	26	63	102	857							
	2009.09-		6MT		F	Bus Engine CAAC/CCHA	GDS61191	Stub Shaft	26	42	60		135.5							

		YEAR	TRANSM	L/R	F/R		G-AP Ref.	PRODUCT	ABS	Technical Specifications										
										A	B	C	H	L	P					
<b>VOLKSWAGEN</b>																				
<b>TRANSPORTER / CARAVELLE V (7HB, 7HJ, 7EB, 7EJ, 7EF)</b>																				
2.0 TDi (62 kW)	2009.09-		5MT		F	Bus Engine CAAA	GDS61190	Stub Shaft		26	37	50		136.5						
	2009.09-		6MT		F	Bus Engine CAAA	GDS61191	Stub Shaft		26	42	60		135.5						
	2009.09-		5MT	R	F	Bus Engine CAAA	GDS83261	Drive Shaft		38	26	63	102	857						
2.0 TDi (75 kW)	2009.09-		5MT		F	Bus Engine CAAB	GDS61190	Stub Shaft		26	37	50		136.5						
	2009.09-		5MT	R	F	Bus Engine CAAB	GDS83261	Drive Shaft		38	26	63	102	857						
	2009.09-		6MT		F	Bus Engine CAAB	GDS61191	Stub Shaft		26	42	60		135.5						
2.0 TDi (84 kW)	2011.05-		6MT		F	Bus Engine CAAD	GDS61191	Stub Shaft		26	42	60		135.5						
	2011.05-		MT	R	F	Bus Engine CAAD	GDS83261	Drive Shaft		38	26	63	102	857						
	2011.05-		5MT		F	Bus Engine CAAD	GDS61190	Stub Shaft		26	37	50		136.5						
2.0 TDi 4motion (100 kW)	2010.05-		5MT			Bus Engine CAAE/CCHB	GDS61190	Stub Shaft		26	37	50		136.5						
	2010.05-		6MT			Bus Engine CAAE/CCHB	GDS61191	Stub Shaft		26	42	60		135.5						
2.0 TDi 4motion (103 kW)	2009.09-		5MT			Bus Engine CAAC/CCHA	GDS61190	Stub Shaft		26	37	50		136.5						
	2009.09-					Bus Engine CAAC/CCHA	GC061011	Outer Joint		38	29	63	102.5	70	M					
	2009.09-		AT	L	F	Bus Engine CAAC/CCHA	GDS83293	Drive Shaft		38	37	63	102.5	645						
	2009.09-		6MT			Bus Engine CAAC/CCHA	GDS61191	Stub Shaft		26	42	60		135.5						
2.0 TSi (110 kW)	2012.07-		5MT		F	Bus Engine CJKB	GDS61190	Stub Shaft		26	37	50		136.5						
	2012.07-		6MT		F	Bus Engine CJKB	GDS61191	Stub Shaft		26	42	60		135.5						
2.0 TSi (150 kW)	2011.05-		6MT		F	Bus Engine CJKA	GDS61191	Stub Shaft		26	42	60		135.5						
	2011.05-		5MT		F	Bus Engine CJKA	GDS61190	Stub Shaft		26	37	50		136.5						
2.0 TSi 4motion (150 kW)	2011.07-		6MT			Bus Engine CJKA	GDS61191	Stub Shaft		26	42	60		135.5						
	2011.07-		AT	L	F	Bus Engine CJKA	GDS83293	Drive Shaft		38	37	63	102.5	645						
	2011.07-		5MT			Bus Engine CJKA	GDS61190	Stub Shaft		26	37	50		136.5						
2.5 TDi (120 kW)	2003.11-2009.11		6MT		F	Bus Engine BLJ	GDS61191	Stub Shaft		26	42	60		135.5						
	2003.11-2009.11		MT		F	Bus Engine BLJ	GCI61021	Inner Joint		26	30	50	288	78						
	2003.11-2009.11		MT		F	Bus Engine BLJ	GCI61029	Inner Joint		26	30	46.8	53	79						
	2003.11-2009.11			L	F	Bus Engine BLJ	GDS61084	Drive Shaft		38	26	63	102.5	613						
	2003.11-2009.11			R	F	Bus Engine BLJ	GDS61140	Drive Shaft		38	26	63	102.5	873						
	2003.11-2009.11		5MT		F	Bus Engine BLJ	GDS61190	Stub Shaft		26	37	50		136.5						
2.5 TDi (128 kW)	2003.04-2009.11		6MT		F	Bus Engine AXE/BPC	GDS61191	Stub Shaft		26	42	60		135.5						
	2003.04-2009.11				F	Bus Engine AXE/BPC	GC061011	Outer Joint		38	29	63	102.5	70	M					
	2003.04-2009.11		MT		F	Bus Engine AXE/BPC	GCI61021	Inner Joint		26	30	50	288	78						
	2003.04-2009.11		MT		F	Bus Engine AXE/BPC	GCI61029	Inner Joint		26	30	46.8	53	79						
	2003.04-2009.11		MT	L	F	Bus Engine AXE/BPC	GDS61084	Drive Shaft		38	26	63	102.5	613						
	2003.04-2009.11		AT	R	F	Bus Engine AXE/BPC	GDS61210	Drive Shaft		38	26	63	102.5	925						
	2003.04-2009.11		MT	R	F	Bus Engine AXE/BPC	GDS61140	Drive Shaft		38	26	63	102.5	873						
	2003.04-2009.11		5MT		F	Bus Engine AXE/BPC	GDS61190	Stub Shaft		26	37	50		136.5						
2.5 TDi (96 kW)	2003.04-2009.11		6MT		F	Bus Engine AXD/BNZ	GDS61191	Stub Shaft		26	42	60		135.5						
	2003.04-2009.11				F	Bus Engine AXD/BNZ	GC061011	Outer Joint		38	29	63	102.5	70	M					
	2003.04-2009.11		6MT	L	F	Bus Engine AXD/BNZ	GDS61084	Drive Shaft		38	26	63	102.5	613						
	2003.04-2009.11		6AT	R	F	Bus Engine AXD/BNZ	GDS61210	Drive Shaft		38	26	63	102.5	925						
	2003.04-2009.11		6MT	R	F	Bus Engine AXD/BNZ	GDS61140	Drive Shaft		38	26	63	102.5	873						
	2003.04-2009.11		AT	R	F	Bus Engine AXD/BNZ	GDS83267	Drive Shaft		38	26	63	102.5	925						
	2003.04-2009.11		5MT		F	Bus Engine AXD/BNZ	GDS61190	Stub Shaft		26	37	50		136.5						
	2003.04-2009.11				F	Bus Engine AXD/BNZ	GDS61191	Stub Shaft		26	42	60		135.5						
2.5 TDi 4motion (128 kW)	2004.07-2009.11		6MT			Bus Engine AXE/BPC	GDS61191	Stub Shaft		26	42	60		135.5						
	2004.07-2009.11					Bus Engine AXE/BPC	GC061011	Outer Joint		38	29	63	102.5	70	M					
	2004.07-2009.11		MT		F	Bus Engine AXE/BPC	GCI61029	Inner Joint		26	30	46.8	53	79						
	2004.07-2009.11		6MT	L	F	Bus Engine AXE/BPC	GDS61084	Drive Shaft		38	26	63	102.5	613						
	2004.07-2009.11			R	F	Bus Engine AXE/BPC	GDS61210	Drive Shaft		38	26	63	102.5	925						
	2004.07-2009.11		MT/AT	L	R	Bus Engine AXE/BPC	GDS61257	Drive Shaft		38		59	100	683						
	2004.07-2009.11		5MT			Bus Engine AXE/BPC	GDS61190	Stub Shaft		26	37	50		136.5						
	2004.07-2009.11					Bus Engine AXE/BPC	GDS61191	Stub Shaft		26	42	60		135.5						
2.5 TDi 4motion (96 kW)	2004.07-2009.11		6MT			Bus Engine AXD/BNZ	GDS61191	Stub Shaft		26	42	60		135.5						
	2004.07-2009.11					Bus Engine AXD/BNZ	GC061011	Outer Joint		38	29	63	102.5	70	M					
	2004.07-2009.11		MT		F	Bus Engine AXD/BNZ	GCI61029	Inner Joint		26	30	46.8	53	79						
	2004.07-2009.11		6MT	L	F	Bus Engine AXD/BNZ	GDS61084	Drive Shaft		38	26	63	102.5	613						
	2004.07-2009.11		MT/AT	L	R	Bus Engine AXD/BNZ	GDS61257	Drive Shaft		38		59	100	683						
	2004.07-2009.11		5MT			Bus Engine AXD/BNZ	GDS61190	Stub Shaft		26	37	50		136.5						
3.2 V6 (170 kW)	2004.02-2004.06		6MT		F	Bus Engine BDL	GDS61191	Stub Shaft		26	42	60		135.5						
	2004.02-2004.06		AT		F	Bus Engine BDL	GC061011	Outer Joint		38	29	63	102.5	70	M					
	2004.02-2004.06		AT	R	F	Bus Engine BDL	GDS83267	Drive Shaft		38	26	63	102.5	925						
	2004.02-2004.06		5MT		F	Bus Engine BDL	GDS61190	Stub Shaft		26	37	50		136.5						
3.2 V6 (173 kW)	2004.02-2009.11		6MT		F	Bus Engine BKK/CFLA	GDS61191	Stub Shaft		26	42	60		135.5						



		YEAR	TRANSM	L/R	F/R		G-AP Ref.	PRODUCT	ABS	Technical Specifications										
										A	B	C	H	L	P					
<b>VOLKSWAGEN</b>																				
<b>TRANSPORTER / CARAVELLE V (7HB, 7HJ, 7EB, 7EJ, 7EF)</b>																				
3.2 V6 (173 kW)	2004.02-	2009.11	AT		F	Bus Engine BKK/CFLA	GCO61011	Outer Joint		38	29	63	102.5	70	M					
	2004.02-	2009.11	5MT		F	Bus Engine BKK/CFLA	GDS61190	Stub Shaft		26	37	50			136.5					
3.2 V6 4motion (173 kW)	2003.11-	2009.11	6MT			Bus Engine BKK/CFLA	GDS61191	Stub Shaft		26	42	60			135.5					
	2003.11-	2009.11				Bus Engine BKK/CFLA	GCO61011	Outer Joint		38	29	63	102.5	70	M					
	2003.11-	2009.11		L	R	Bus Engine BKK/CFLA	GDS61257	Drive Shaft		38		59	100		683					
	2003.11-	2009.11	5MT			Bus Engine BKK/CFLA	GDS61190	Stub Shaft		26	37	50			136.5					
<b>TRANSPORTER II</b>																				
1.6 (34 kW)	1967.08-	1970.07	MT/AT		R	Bus Engine AF	GCI61003	Inner Joint			33		32							
1.6 (37 kW)	1968.08-	1979.07	MT/AT		R	Platform/Chassis Engine AD/AS	GCI61003	Inner Joint			33		32							
	1970.08-	1979.04	MT/AT		R	Box Engine AD/AE/AS	GCI61003	Inner Joint			33		32							
1.7 (49 kW)	1971.08-	1973.10	MT/AT		R	Bus Engine CA/CB	GCI61003	Inner Joint			33		32							
	1971.08-	1973.12	MT/AT		R	Box Engine CA/CB	GCI61003	Inner Joint			33		32							
1.8 (50 kW)	1973.11-	1975.07	MT/AT		R	Box Engine AP	GCI61003	Inner Joint			33		32							
2.0 (51 kW)	1975.08-	1979.07	MT/AT		R	Box Engine CJ/GD/GE	GCI61003	Inner Joint			33		32							
<b>TRANSPORTER III</b>																				
1.6 (37 kW)	1979.05-	1982.12	MT/AT		R	Box Engine CT	GCI61003	Inner Joint			33		32							
1.6 D (37 kW)	1981.01-	1987.07	MT	L/R	R	Box Engine CS	GDS61005	Drive Shaft					32	540						
	1981.01-	1987.07	MT	L/R	R	Platform/Chassis Engine CS	GDS61005	Drive Shaft					32	540						
	1981.01-	1987.07	MT		R	Box Engine CS	GCI61003	Inner Joint			33		32							
	1981.01-	1987.07	MT		R	Platform/Chassis Engine CS	GCI61003	Inner Joint			33		32							
1.6 TD (51 kW)	1984.10-	1992.07	MT	L/R	R	Box Engine JX	GDS61005	Drive Shaft					32	540						
	1984.10-	1992.07	MT	L/R	R	Platform/Chassis Engine JX	GDS61005	Drive Shaft					32	540						
	1984.10-	1992.07	MT		R	Box Engine JX	GCI61003	Inner Joint			33		32							
	1984.10-	1992.07	MT		R	Platform/Chassis Engine JX	GCI61003	Inner Joint			33		32							
1.6 TD Syncro (51 kW)	1986.03-	1992.07	MT	L/R	R	Box Engine JX	GDS61005	Drive Shaft					32	540						
	1986.03-	1992.07	MT	L/R	R	Platform/Chassis Engine JX	GDS61005	Drive Shaft					32	540						
	1986.03-	1992.07	MT		R	Box Engine JX	GCI61003	Inner Joint			33		32							
	1986.03-	1992.07	MT		R	Platform/Chassis Engine JX	GCI61003	Inner Joint			33		32							
	1986.03-	1992.07	MT	L/R	F	Box Engine JX	GDS61092	Drive Shaft	26		65	104	712							
	1986.03-	1992.07	MT	L/R	F	Platform/Chassis Engine JX	GDS61092	Drive Shaft	26		65	104	712							
1.7 D (42 kW)	1989.07-	1992.07	MT	L/R	R	Box Engine KY	GDS61005	Drive Shaft					32	540						
	1989.07-	1992.07	MT	L/R	R	Platform/Chassis Engine KY	GDS61005	Drive Shaft					32	540						
	1989.07-	1992.07	MT		R	Box Engine KY	GCI61003	Inner Joint			33		32							
	1989.07-	1992.07	MT		R	Platform/Chassis Engine KY	GCI61003	Inner Joint			33		32							
1.9 (44 kW)	1982.09-	1992.07	MT	L/R	R	Platform/Chassis Engine DF	GDS61005	Drive Shaft					32	540						
	1982.09-	1992.07	MT/AT		R	Platform/Chassis Engine DF	GCI61003	Inner Joint			33		32							
	1982.10-	1992.07	MT	L/R	R	Box Engine DF	GDS61005	Drive Shaft					32	540						
	1982.10-	1992.07	MT/AT		R	Box Engine DF	GCI61003	Inner Joint			33		32							
1.9 (57 kW)	1982.08-	1992.07	MT	L/R	R	Platform/Chassis Engine DG	GDS61005	Drive Shaft					32	540						
	1982.08-	1992.07	MT/AT		R	Platform/Chassis Engine DG	GCI61003	Inner Joint			33		32							
	1982.10-	1992.07	MT	L/R	R	Box Engine DG	GDS61005	Drive Shaft					32	540						
	1982.10-	1992.07	MT/AT		R	Box Engine DG	GCI61003	Inner Joint			33		32							
1.9 (61 kW)	1984.10-	1989.02	MT	L/R	R	Box Engine DH	GDS61005	Drive Shaft					32	540						
	1984.10-	1989.02	MT	L/R	R	Platform/Chassis Engine DH	GDS61005	Drive Shaft					32	540						
	1984.10-	1989.02	MT/AT		R	Box Engine DH	GCI61003	Inner Joint			33		32							
	1984.10-	1989.02	MT/AT		R	Platform/Chassis Engine DH	GCI61003	Inner Joint			33		32							
1.9 (66 kW)	1983.08-	1989.02	MT	L/R	R	Box Engine GW	GDS61005	Drive Shaft					32	540						
	1983.08-	1989.02	MT/AT		R	Box Engine GW	GCI61003	Inner Joint			33		32							
1.9 Syncro (57 kW)	1984.11-	1992.07	MT	L/R	R	Box Engine DG	GDS61005	Drive Shaft					32	540						
	1984.11-	1992.07	MT		R	Box Engine DG	GCI61003	Inner Joint			33		32							
	1984.11-	1992.07	MT	L/R	F	Box Engine DG	GDS61092	Drive Shaft	26		65	104	712							
	1984.12-	1992.07	MT	L/R	F	Platform/Chassis Engine DG	GDS61092	Drive Shaft	26		65	104	712							
	1984.12-	1992.07	MT	L/R	R	Platform/Chassis Engine DG	GDS61005	Drive Shaft					32	540						
	1984.12-	1992.07	MT		R	Platform/Chassis Engine DG	GCI61003	Inner Joint			33		32							
2.0 (51 kW)	1979.05-	1986.04	MT/AT		R	Box Engine CU	GCI61003	Inner Joint			33		32							
	1979.05-	1986.04	MT/AT		R	Platform/Chassis Engine CU	GCI61003	Inner Joint			33		32							
2.1 (70 kW)	1985.08-	1992.07	MT	L/R	R	Box Engine MV	GDS61005	Drive Shaft					32	540						
	1985.08-	1992.07	MT	L/R	R	Platform/Chassis Engine MV	GDS61005	Drive Shaft					32	540						
	1985.08-	1992.07	MT/AT		R	Box Engine MV	GCI61003	Inner Joint			33		32							
	1985.08-	1992.07	MT/AT		R	Platform/Chassis Engine MV	GCI61003	Inner Joint			33		32							
2.1 (82 kW)	1986.03-	1992.07	MT	L/R	R	Box Engine DJ	GDS61005	Drive Shaft					32	540						





		TRANSM	L/R	F/R		G-AP Ref.	PRODUCT	ABS	Technical Specifications						
									YEAR	A	B	C	H	L	P
<b>VOLKSWAGEN TRANSPORTER III</b>															
2.1 (82 kW)	1986.03-	1992.07	MT	L/R	R	Platform/Chassis Engine DJ	GDS61005	Drive Shaft				32	540		
	1986.03-	1992.07	MT/AT		R	Box Engine DJ	GCI61003	Inner Joint		33		32			
	1986.03-	1992.07	MT/AT		R	Platform/Chassis Engine DJ	GCI61003	Inner Joint		33		32			
2.1 i (68 kW)	1989.07-	1992.07	MT	L/R	R	Box Engine SS	GDS61005	Drive Shaft				32	540		
	1989.07-	1992.07	MT	L/R	R	Platform/Chassis Engine SS	GDS61005	Drive Shaft				32	540		
	1989.07-	1992.07	MT/AT		R	Box Engine SS	GCI61003	Inner Joint		33		32			
	1989.07-	1992.07	MT/AT		R	Platform/Chassis Engine SS	GCI61003	Inner Joint		33		32			
2.1 Syncro (70 kW)	1985.08-	1992.07	MT	L/R	F	Box Engine MV	GDS61092	Drive Shaft	26		65	104	712		
	1985.08-	1992.07	MT	L/R	F	Platform/Chassis Engine MV	GDS61092	Drive Shaft	26		65	104	712		
	1985.08-	1992.07	MT	L/R	R	Box Engine MV	GDS61005	Drive Shaft				32	540		
	1985.08-	1992.07	MT	L/R	R	Platform/Chassis Engine MV	GDS61005	Drive Shaft				32	540		
	1985.08-	1992.07	MT		R	Box Engine MV	GCI61003	Inner Joint		33		32			
	1985.08-	1992.07	MT		R	Platform/Chassis Engine MV	GCI61003	Inner Joint		33		32			
2.1 Syncro (82 kW)	1986.03-	1992.07	MT	L/R	F	Box Engine DJ	GDS61092	Drive Shaft	26		65	104	712		
	1986.03-	1992.07	MT	L/R	F	Platform/Chassis Engine DJ	GDS61092	Drive Shaft	26		65	104	712		
	1986.03-	1992.07	MT	L/R	R	Box Engine DJ	GDS61005	Drive Shaft				32	540		
	1986.03-	1992.07	MT	L/R	R	Platform/Chassis Engine DJ	GDS61005	Drive Shaft				32	540		
	1986.03-	1992.07	MT		R	Box Engine DJ	GCI61003	Inner Joint		33		32			
	1986.03-	1992.07	MT		R	Platform/Chassis Engine DJ	GCI61003	Inner Joint		33		32			
	1986.03-	1992.07	MT		R	Platform/Chassis Engine DJ	GCI61003	Inner Joint		33		32			
<b>TRANSPORTER IV (70XA)</b>															
1.9 TD (50 kW)	1992.10-	2003.04			F	Box Engine ABL	GCI61001	Inner Joint		33		31.8			
	1992.10-	2003.04			F	Box Engine ABL	GCI48002	Inner Joint		28		32			
	1992.10-	2003.04	MT		F	Box Engine ABL	GC061003	Outer Joint	38	33	60.2	34.5	65	I	
	1992.10-	2003.04	MT		F	Box Engine ABL	GC061004	Outer Joint	48T	38	33	60.2	34.5	65	I
	1992.10-	2003.04	MT		F	Box Engine ABL	GCI61002	Inner Joint		28		31.8			
	1992.10-	2003.04	MT		F	Box Engine ABL	GC061005	Outer Joint	38	27	60.2	34.5	65	I	
	1992.10-	2003.04	MT		F	Box Engine ABL	GC061006	Outer Joint	48T	38	27	60.2	34.5	65	I
	1992.10-	2003.04	MT	L/R	F	Box Engine ABL	GDS61003	Drive Shaft	38		60.2	34.5	540.8		
	1992.10-	2003.04	MT	L/R	F	Box Engine ABL	GDS61119	Drive Shaft	38		60.2	34.5	527		
	1992.10-	2003.04	MT	L/R	F	Box Engine ABL	GDS61004	Drive Shaft	48T	38		60.2	34.5	540.8	
2.0 (62 kW)	1990.07-	2003.04			F	Box Engine AAC	GCI48002	Inner Joint		28		32			
	1990.07-	2003.04	MT		F	Box Engine AAC	GC061003	Outer Joint	38	33	60.2	34.5	65	I	
	1990.07-	2003.04	MT		F	Box Engine AAC	GC061004	Outer Joint	48T	38	33	60.2	34.5	65	I
	1990.07-	2003.04	MT		F	Box Engine AAC	GCI61002	Inner Joint		28		31.8			
	1990.07-	2003.04	MT		F	Box Engine AAC	GC061005	Outer Joint	38	27	60.2	34.5	65	I	
	1990.07-	2003.04	MT		F	Box Engine AAC	GC061006	Outer Joint	48T	38	27	60.2	34.5	65	I
	1990.07-	2003.04	MT/AT		F	Box Engine AAC	GCI61001	Inner Joint		33		31.8			
	1990.07-	2003.04	MT	L/R	F	Box Engine AAC	GDS61003	Drive Shaft	38		60.2	34.5	540.8		
	1990.07-	2003.04	MT	L/R	F	Box Engine AAC	GDS61119	Drive Shaft	38		60.2	34.5	527		
	1990.07-	2003.04	MT	L/R	F	Box Engine AAC	GDS61004	Drive Shaft	48T	38		60.2	34.5	540.8	
2.4 D (55 kW)	1997.08-	2003.04			F	Box Engine AJA	GCI48002	Inner Joint		28		32			
	1997.08-	2003.04	MT/AT		F	Box Engine AJA	GCI61002	Inner Joint		28		31.8			
	1997.08-	2003.04	MT/AT		F	Box Engine AJA	GC061005	Outer Joint	38	27	60.2	34.5	65	I	
	1997.08-	2003.04	MT/AT		F	Box Engine AJA	GC061006	Outer Joint	48T	38	27	60.2	34.5	65	I
	1997.08-	2003.04	MT	L/R	F	Box Engine AJA	GDS61003	Drive Shaft	38		60.2	34.5	540.8		
	1997.08-	2003.04	MT	L/R	F	Box Engine AJA	GDS61004	Drive Shaft	48T	38		60.2	34.5	540.8	
	1997.08-	2003.04	AT	R	F	Box Engine AJA	GDS61003	Drive Shaft	38		60.2	34.5	540.8		
	1997.08-	2003.04	AT	R	F	Box Engine AJA	GDS61004	Drive Shaft	48T	38		60.2	34.5	540.8	
2.5 (81 kW)	1990.11-	2003.04			F	Box Engine AAF/ACU/AEN/AEU	GCI48002	Inner Joint		28		32			
	1990.11-	2003.04	MT/AT		F	Box Engine AAF/ACU/AEN/AEU	GC061003	Outer Joint	38	33	60.2	34.5	65	I	
	1990.11-	2003.04	MT/AT		F	Box Engine AAF/ACU/AEN/AEU	GC061004	Outer Joint	48T	38	33	60.2	34.5	65	I
	1990.11-	2003.04	MT/AT		F	Box Engine AAF/ACU/AEN/AEU	GCI61001	Inner Joint		33		31.8			
	1990.11-	2003.04	MT/AT		F	Box Engine AAF/ACU/AEN/AEU	GCI61002	Inner Joint		28		31.8			
	1990.11-	2003.04	MT/AT		F	Box Engine AAF/ACU/AEN/AEU	GC061005	Outer Joint	38	27	60.2	34.5	65	I	
	1990.11-	2003.04	MT/AT		F	Box Engine AAF/ACU/AEN/AEU	GC061006	Outer Joint	48T	38	27	60.2	34.5	65	I
	1990.11-	2003.04	MT	L	F	Box Engine AAF/ACU/AEN/AEU	GDS61003	Drive Shaft	38		60.2	34.5	540.8		
	1990.11-	2003.04	MT	L	F	Box Engine AAF/ACU/AEN/AEU	GDS61119	Drive Shaft	38		60.2	34.5	527		
	1990.11-	2003.04	MT	L	F	Box Engine AAF/ACU/AEN/AEU	GDS61004	Drive Shaft	48T	38		60.2	34.5	540.8	
	1990.11-	2003.04	MT/AT	R	F	Box Engine AAF/ACU/AEN/AEU	GDS61003	Drive Shaft	38		60.2	34.5	540.8		
	1990.11-	2003.04	MT/AT	R	F	Box Engine AAF/ACU/AEN/AEU	GDS61119	Drive Shaft	38		60.2	34.5	527		
1990.11-	2003.04	MT/AT	R	F	Box Engine AAF/ACU/AEN/AEU	GDS61004	Drive Shaft	48T	38		60.2	34.5	540.8		



		TRANSM	L/R	F/R		G-AP Ref.	PRODUCT	ABS	Technical Specifications								
									YEAR	A	B	C	H	L	P		
<b>VOLKSWAGEN</b>																	
<b>TRANSPORTER IV (70XA)</b>																	
2.5 (85 kW)	1996.08-	2003.04	MT/AT		F	Box Engine AET/APL/AVT	GCI61002	Inner Joint		28		31.8					
	1996.08-	2003.04	MT/AT		F	Box Engine AET/APL/AVT	GC061005	Outer Joint	38	27	60.2	34.5	65	I			
	1996.08-	2003.04	MT/AT		F	Box Engine AET/APL/AVT	GC061006	Outer Joint	48T	38	27	60.2	34.5	65	I		
	1996.08-	2003.04	MT	L/R	F	Box Engine AET/APL/AVT	GDS61003	Drive Shaft		38		60.2	34.5	540.8			
	1996.08-	2003.04	MT	L/R	F	Box Engine AET/APL/AVT	GDS61004	Drive Shaft	48T	38		60.2	34.5	540.8			
2.5 Syncro (81 kW)	1992.10-	2003.04	MT/AT		F	Box Engine AAF/ACU/AEN/AEU	GC061003	Outer Joint		38	33	60.2	34.5	65	I		
	1992.10-	2003.04	MT/AT		F	Box Engine AAF/ACU/AEN/AEU	GC061004	Outer Joint	48T	38	33	60.2	34.5	65	I		
	1992.10-	2003.04	MT/AT		F	Box Engine AAF/ACU/AEN/AEU	GCI61002	Inner Joint		28		31.8					
	1992.10-	2003.04	MT/AT		F	Box Engine AAF/ACU/AEN/AEU	GC061005	Outer Joint		38	27	60.2	34.5	65	I		
	1992.10-	2003.04	MT/AT		F	Box Engine AAF/ACU/AEN/AEU	GC061006	Outer Joint	48T	38	27	60.2	34.5	65	I		
2.5 Syncro (85 kW)	1996.08-	2003.04				Box Engine AET/APL/AVT	GCI48002	Inner Joint		28		32					
	1996.08-	2003.04	MT/AT		F	Box Engine AET/APL/AVT	GCI61002	Inner Joint		28		31.8					
	1996.08-	2003.04	MT/AT		F	Box Engine AET/APL/AVT	GC061005	Outer Joint	38	27	60.2	34.5	65	I			
	1996.08-	2003.04	MT/AT		F	Box Engine AET/APL/AVT	GC061006	Outer Joint	48T	38	27	60.2	34.5	65	I		
2.5 TDi (111 kW)	2000.09-	2003.04			F	Box Engine AXG	GCI48002	Inner Joint		28		32					
	2000.09-	2003.04			F	Box Engine AXG	GCI61030	Inner Joint		30		32					
	2000.09-	2003.04			F	Box Engine AXG	GC061006	Outer Joint	48T	38	27	60.2	34.5	65	I		
2.5 TDi (65 kW)	1998.12-	2003.04			F	Box Engine AJT/AYY	GCI48002	Inner Joint		28		32					
	1998.12-	2003.04	MT		F	Box Engine AJT/AYY	GCI61002	Inner Joint		28		31.8					
	1998.12-	2003.04	MT		F	Box Engine AJT/AYY	GC061005	Outer Joint	38	27	60.2	34.5	65	I			
	1998.12-	2003.04	MT		F	Box Engine AJT/AYY	GC061006	Outer Joint	48T	38	27	60.2	34.5	65	I		
	1998.12-	2003.04	MT	L/R	F	Box Engine AJT/AYY	GDS61003	Drive Shaft		38		60.2	34.5	540.8			
	1998.12-	2003.04	MT	L/R	F	Box Engine AJT/AYY	GDS61004	Drive Shaft	48T	38		60.2	34.5	540.8			
2.5 TDi (75 kW)	1995.09-	2003.04			F	Box Engine ACV/AUF/AYC	GCI48002	Inner Joint		28		32					
	1995.09-	2003.04	MT/AT		F	Box Engine ACV/AUF/AYC	GCI61002	Inner Joint		28		31.8					
	1995.09-	2003.04	MT/AT		F	Box Engine ACV/AUF/AYC	GC061005	Outer Joint	38	27	60.2	34.5	65	I			
	1995.09-	2003.04	MT/AT		F	Box Engine ACV/AUF/AYC	GC061006	Outer Joint	48T	38	27	60.2	34.5	65	I		
	1995.09-	2003.04	MT	L/R	F	Box Engine ACV/AUF/AYC	GDS61003	Drive Shaft		38		60.2	34.5	540.8			
	1995.09-	2003.04	MT	L/R	F	Box Engine ACV/AUF/AYC	GDS61004	Drive Shaft	48T	38		60.2	34.5	540.8			
	1995.09-	2003.04	MT	L/R	F	Box Engine ACV/AUF/AYC	GDS61052	Drive Shaft	48T	38		60.2	34.5	529			
	1995.09-	2003.04	MT	L/R	F	Box Engine ACV/AUF/AYC	GDS61034	Drive Shaft		38		60.2	34.5	529			
	1995.09-	2003.04	MT/AT	R	F	Box Engine ACV/AUF/AYC	GDS61003	Drive Shaft		38		60.2	34.5	540.8			
2.5 TDi Syncro (75 kW)	1995.09-	2003.04	MT/AT		F	Box Engine ACV/AXL	GCI61002	Inner Joint		28		31.8					
	1995.09-	2003.04	MT/AT		F	Box Engine ACV/AXL	GC061005	Outer Joint	38	27	60.2	34.5	65	I			
	1995.09-	2003.04	MT/AT		F	Box Engine ACV/AXL	GC061006	Outer Joint	48T	38	27	60.2	34.5	65	I		
2.8 VR6 (150 kW)	2000.06-	2003.04	MT	L/R	F	Box Engine AMV	GDS61003	Drive Shaft		38		60.2	34.5	540.8			
	2000.06-	2003.04	MT	L/R	F	Box Engine AMV	GDS61004	Drive Shaft	48T	38		60.2	34.5	540.8			
<b>TRANSPORTER IV (70XD)</b>																	
1.9 TD (50 kW)	1992.10-	2003.04			F	Platform/Chassis Engine ABL	GCI61001	Inner Joint		33		31.8					
	1992.10-	2003.04	MT		F	Platform/Chassis Engine ABL	GC061006	Outer Joint	48T	38	27	60.2	34.5	65	I		
	1992.10-	2003.04	MT		F	Platform/Chassis Engine ABL	GC061003	Outer Joint		38	33	60.2	34.5	65	I		
	1992.10-	2003.04	MT		F	Platform/Chassis Engine ABL	GC061004	Outer Joint	48T	38	33	60.2	34.5	65	I		
	1992.10-	2003.04	MT		F	Platform/Chassis Engine ABL	GCI61002	Inner Joint		28		31.8					
	1992.10-	2003.04	MT		F	Platform/Chassis Engine ABL	GC061005	Outer Joint		38	27	60.2	34.5	65	I		
	1992.10-	2003.04	MT	L/R	F	Platform/Chassis Engine ABL	GDS61119	Drive Shaft		38		60.2	34.5	527			
	1992.10-	2003.04	MT	L/R	F	Platform/Chassis Engine ABL	GDS61003	Drive Shaft		38		60.2	34.5	540.8			
	1992.10-	2003.04	MT	L/R	F	Platform/Chassis Engine ABL	GDS61004	Drive Shaft	48T	38		60.2	34.5	540.8			
2.0 (62 kW)	1990.07-	2003.04	MT		F	Platform/Chassis Engine AAC	GC061006	Outer Joint	48T	38	27	60.2	34.5	65	I		
	1990.07-	2003.04	MT		F	Platform/Chassis Engine AAC	GC061003	Outer Joint		38	33	60.2	34.5	65	I		
	1990.07-	2003.04	MT		F	Platform/Chassis Engine AAC	GC061004	Outer Joint	48T	38	33	60.2	34.5	65	I		
	1990.07-	2003.04	MT		F	Platform/Chassis Engine AAC	GCI61002	Inner Joint		28		31.8					
	1990.07-	2003.04	MT		F	Platform/Chassis Engine AAC	GC061005	Outer Joint		38	27	60.2	34.5	65	I		
	1990.07-	2003.04	MT/AT		F	Platform/Chassis Engine AAC	GCI61001	Inner Joint		33		31.8					
	1990.07-	2003.04	MT	L/R	F	Platform/Chassis Engine AAC	GDS61119	Drive Shaft		38		60.2	34.5	527			
	1990.07-	2003.04	MT	L/R	F	Platform/Chassis Engine AAC	GDS61003	Drive Shaft		38		60.2	34.5	540.8			
	1990.07-	2003.04	MT	L/R	F	Platform/Chassis Engine AAC	GDS61004	Drive Shaft	48T	38		60.2	34.5	540.8			
2.4 D (55 kW)	1997.08-	2003.04	MT/AT		F	Platform/Chassis Engine AJA	GC061006	Outer Joint	48T	38	27	60.2	34.5	65	I		
	1997.08-	2003.04	MT/AT		F	Platform/Chassis Engine AJA	GCI61002	Inner Joint		28		31.8					
	1997.08-	2003.04	MT/AT		F	Platform/Chassis Engine AJA	GC061005	Outer Joint		38	27	60.2	34.5	65	I		
1997.08-	2003.04	MT	L/R	F	Platform/Chassis Engine AJA	GDS61003	Drive Shaft		38		60.2	34.5	540.8				





		YEAR	TRANSM	L/R	F/R		G-AP Ref.	PRODUCT	ABS	Technical Specifications					
										A	B	C	H	L	P
<b>VOLKSWAGEN</b>															
<b>TRANSPORTER IV (70XD)</b>															
2.4 D (55 kW)	1997.08-	2003.04	MT	L/R	F	Platform/Chassis Engine AJA	GDS61004	Drive Shaft	48T	38		60.2	34.5	540.8	
	1997.08-	2003.04	AT	R	F	Platform/Chassis Engine AJA	GDS61003	Drive Shaft		38		60.2	34.5	540.8	
2.5 (81 kW)	1990.11-	2003.04	MT/AT		F	Platform/Chassis Engine AAF/ACU/AEN/AEU	GC061006	Outer Joint	48T	38	27	60.2	34.5	65	I
	1990.11-	2003.04	MT/AT		F	Platform/Chassis Engine AAF/ACU/AEN/AEU	GC061003	Outer Joint		38	33	60.2	34.5	65	I
	1990.11-	2003.04	MT/AT		F	Platform/Chassis Engine AAF/ACU/AEN/AEU	GC061004	Outer Joint	48T	38	33	60.2	34.5	65	I
	1990.11-	2003.04	MT/AT		F	Platform/Chassis Engine AAF/ACU/AEN/AEU	GCI61001	Inner Joint			33		31.8		
	1990.11-	2003.04	MT/AT		F	Platform/Chassis Engine AAF/ACU/AEN/AEU	GCI61002	Inner Joint			28		31.8		
	1990.11-	2003.04	MT/AT		F	Platform/Chassis Engine AAF/ACU/AEN/AEU	GC061005	Outer Joint		38	27	60.2	34.5	65	I
	1990.11-	2003.04	MT	L	F	Platform/Chassis Engine AAF/ACU/AEN/AEU	GDS61119	Drive Shaft		38		60.2	34.5	527	
	1990.11-	2003.04	MT	L	F	Platform/Chassis Engine AAF/ACU/AEN/AEU	GDS61003	Drive Shaft		38		60.2	34.5	540.8	
	1990.11-	2003.04	MT	L	F	Platform/Chassis Engine AAF/ACU/AEN/AEU	GDS61004	Drive Shaft	48T	38		60.2	34.5	540.8	
	1990.11-	2003.04	MT/AT	R	F	Platform/Chassis Engine AAF/ACU/AEN/AEU	GDS61119	Drive Shaft		38		60.2	34.5	527	
	1990.11-	2003.04	MT/AT	R	F	Platform/Chassis Engine AAF/ACU/AEN/AEU	GDS61003	Drive Shaft		38		60.2	34.5	540.8	
	1990.11-	2003.04	MT/AT	R	F	Platform/Chassis Engine AAF/ACU/AEN/AEU	GDS61004	Drive Shaft	48T	38		60.2	34.5	540.8	
2.5 (85 kW)	1996.08-	2003.04	MT/AT		F	Platform/Chassis Engine AET/APL/AVT	GC061006	Outer Joint	48T	38	27	60.2	34.5	65	I
	1996.08-	2003.04	MT/AT		F	Platform/Chassis Engine AET/APL/AVT	GCI61002	Inner Joint			28		31.8		
	1996.08-	2003.04	MT/AT		F	Platform/Chassis Engine AET/APL/AVT	GC061005	Outer Joint		38	27	60.2	34.5	65	I
	1996.08-	2003.04	MT	L/R	F	Platform/Chassis Engine AET/APL/AVT	GDS61003	Drive Shaft		38		60.2	34.5	540.8	
	1996.08-	2003.04	MT	L/R	F	Platform/Chassis Engine AET/APL/AVT	GDS61004	Drive Shaft	48T	38		60.2	34.5	540.8	
2.5 Syncro (81 kW)	1992.10-	2003.04	MT/AT		F	Platform/Chassis Engine AAF/ACU/AEN/AEU	GC061006	Outer Joint	48T	38	27	60.2	34.5	65	I
	1992.10-	2003.04	MT/AT		F	Platform/Chassis Engine AAF/ACU/AEN/AEU	GC061003	Outer Joint		38	33	60.2	34.5	65	I
	1992.10-	2003.04	MT/AT		F	Platform/Chassis Engine AAF/ACU/AEN/AEU	GC061004	Outer Joint	48T	38	33	60.2	34.5	65	I
	1992.10-	2003.04	MT/AT		F	Platform/Chassis Engine AAF/ACU/AEN/AEU	GCI61002	Inner Joint			28		31.8		
	1992.10-	2003.04	MT/AT		F	Platform/Chassis Engine AAF/ACU/AEN/AEU	GC061005	Outer Joint		38	27	60.2	34.5	65	I
2.5 Syncro (85 kW)	1996.08-	2003.04	MT/AT		F	Platform/Chassis Engine AET/APL/AVT	GC061006	Outer Joint	48T	38	27	60.2	34.5	65	I
	1996.08-	2003.04	MT/AT		F	Platform/Chassis Engine AET/APL/AVT	GCI61002	Inner Joint			28		31.8		
	1996.08-	2003.04	MT/AT		F	Platform/Chassis Engine AET/APL/AVT	GC061005	Outer Joint		38	27	60.2	34.5	65	I
2.5 TDi (65 kW)	1998.05-	2003.04	MT		F	Platform/Chassis Engine AJT/AYY	GC061006	Outer Joint	48T	38	27	60.2	34.5	65	I
	1998.05-	2003.04	MT		F	Platform/Chassis Engine AJT/AYY	GCI61002	Inner Joint			28		31.8		
	1998.05-	2003.04	MT		F	Platform/Chassis Engine AJT/AYY	GC061005	Outer Joint		38	27	60.2	34.5	65	I
	1998.05-	2003.04	MT	L/R	F	Platform/Chassis Engine AJT/AYY	GDS61003	Drive Shaft		38		60.2	34.5	540.8	
	1998.05-	2003.04	MT	L/R	F	Platform/Chassis Engine AJT/AYY	GDS61004	Drive Shaft	48T	38		60.2	34.5	540.8	
2.5 TDi (75 kW)	1995.09-	2003.04	MT/AT		F	Platform/Chassis Engine ACV/AUF/AYC	GC061006	Outer Joint	48T	38	27	60.2	34.5	65	I
	1995.09-	2003.04	MT/AT		F	Platform/Chassis Engine ACV/AUF/AYC	GCI61002	Inner Joint			28		31.8		
	1995.09-	2003.04	MT/AT		F	Platform/Chassis Engine ACV/AUF/AYC	GC061005	Outer Joint		38	27	60.2	34.5	65	I
	1995.09-	2003.04	MT	L/R	F	Platform/Chassis Engine ACV/AUF/AYC	GDS61003	Drive Shaft		38		60.2	34.5	540.8	
	1995.09-	2003.04	MT	L/R	F	Platform/Chassis Engine ACV/AUF/AYC	GDS61004	Drive Shaft	48T	38		60.2	34.5	540.8	
	1995.09-	2003.04	MT	L/R	F	Platform/Chassis Engine ACV/AUF/AYC	GDS61052	Drive Shaft	48T	38		60.2	34.5	529	
	1995.09-	2003.04	MT	L/R	F	Platform/Chassis Engine ACV/AUF/AYC	GDS61034	Drive Shaft		38		60.2	34.5	529	
	1995.09-	2003.04	MT/AT	R	F	Platform/Chassis Engine ACV/AUF/AYC	GDS61003	Drive Shaft		38		60.2	34.5	540.8	
	1995.09-	2003.04	MT/AT	R	F	Platform/Chassis Engine ACV/AUF/AYC	GDS61004	Drive Shaft	48T	38		60.2	34.5	540.8	
2.5 TDi Syncro (75 kW)	1998.05-	2003.04	MT/AT		F	Platform/Chassis Engine ACV/AXL	GC061006	Outer Joint	48T	38	27	60.2	34.5	65	I
	1998.05-	2003.04	MT/AT		F	Platform/Chassis Engine ACV/AXL	GCI61002	Inner Joint			28		31.8		
	1998.05-	2003.04	MT/AT		F	Platform/Chassis Engine ACV/AXL	GC061005	Outer Joint		38	27	60.2	34.5	65	I
<b>TRANSPORTER MK V (7HA, 7HH, 7EA, 7EH)</b>															
3.2 4motion (170 kW)	2003.11-	2006.06	5MT			Box Engine BDL	GDS61190	Stub Shaft		26	37	50		136.5	
	2003.11-	2006.06	6MT			Box Engine BDL	GDS61191	Stub Shaft		26	42	60		135.5	
<b>TRANSPORTER MK V (7JD, 7JE, 7JL, 7JY, 7JZ)</b>															
3.2 4motion (170 kW)	2003.11-	2009.11	5MT			Platform/Chassis Engine BDL	GDS61190	Stub Shaft		26	37	50		136.5	
	2003.11-	2009.11	6MT			Platform/Chassis Engine BDL	GDS61191	Stub Shaft		26	42	60		135.5	
<b>TRANSPORTER V (7HA, 7HH, 7EA, 7EH)</b>															
1.9 TDi (62 kW)	2006.01-	2009.11	MT		F	Box Engine BRR	GCI61041	Inner Joint			28		32		
	2006.01-	2009.11	MT		F	Box Engine BRR	GCI61020	Inner Joint		26	28	50	205.5	63	
	2006.01-	2009.11		L	F	Box Engine BRR	GDS61105	Drive Shaft		38		63	102.5	645	
	2006.01-	2009.11		R	F	Box Engine BRR	GDS83246	Drive Shaft		38	26	63	102.5	858	
	2006.01-	2009.11	AT	R	F	Box Engine BRR	GDS83267	Drive Shaft		38	26	63	102.5	925	
	2006.01-	2009.11	6MT		F	Box Engine BRR	GDS61191	Stub Shaft		26	42	60		135.5	
	2006.01-	2009.11	5MT		F	Box Engine BRR	GDS61190	Stub Shaft		26	37	50		136.5	
1.9 TDi (63 kW)	2003.04-	2009.11			F	Box Engine AXC	GC061009	Outer Joint		38	27	63	102	66	M
	2003.04-	2009.11	MT		F	Box Engine AXC	GCI61041	Inner Joint			28		32		
	2003.04-	2009.11	MT		F	Box Engine AXC	GCI61020	Inner Joint		26	28	50	205.5	63	





		TRANSM	L/R	F/R		G-AP Ref.	PRODUCT	ABS	Technical Specifications								
									YEAR	A	B	C	H	L	P		
<b>VOLKSWAGEN</b>																	
<b>TRANSPORTER V (7HA, 7HH, 7EA, 7EH)</b>																	
1.9 TDi (63 kW)	2003.04-2009.11	5MT	L	F	Box Engine AXC	GDS61105	Drive Shaft		38		63	102.5	645				
	2003.04-2009.11	5MT	R	F	Box Engine AXC	GDS83246	Drive Shaft		38	26	63	102.5	858				
	2003.04-2009.11	AT	R	F	Box Engine AXC	GDS83267	Drive Shaft		38	26	63	102.5	925				
	2003.04-2009.11	6MT		F	Box Engine AXC	GDS61191	Stub Shaft		26	42	60		135.5				
	2003.04-2009.11	5MT		F	Box Engine AXC	GDS61190	Stub Shaft		26	37	50		136.5				
1.9 TDi (75 kW)	2006.06-2009.11	MT		F	Box Engine BRS	GCI61041	Inner Joint			28		32					
	2006.06-2009.11	MT		F	Box Engine BRS	GCI61020	Inner Joint		26	28	50	205.5	63				
	2006.06-2009.11		L	F	Box Engine BRS	GDS61105	Drive Shaft		38		63	102.5	645				
	2006.06-2009.11		R	F	Box Engine BRS	GDS83246	Drive Shaft		38	26	63	102.5	858				
	2006.06-2009.11	AT	R	F	Box Engine BRS	GDS83267	Drive Shaft		38	26	63	102.5	925				
	2006.06-2009.11	6MT		F	Box Engine BRS	GDS61191	Stub Shaft		26	42	60		135.5				
	2006.06-2009.11	5MT		F	Box Engine BRS	GDS61190	Stub Shaft		26	37	50		136.5				
1.9 TDi (77 kW)	2003.04-2009.11			F	Box Engine AXB	GC061009	Outer Joint		38	27	63	102	66	M			
	2003.04-2009.11	MT		F	Box Engine AXB	GCI61041	Inner Joint			28		32					
	2003.04-2009.11	MT		F	Box Engine AXB	GCI61020	Inner Joint		26	28	50	205.5	63				
	2003.04-2009.11	5MT	L	F	Box Engine AXB	GDS61105	Drive Shaft		38		63	102.5	645				
	2003.04-2009.11	5MT	R	F	Box Engine AXB	GDS83246	Drive Shaft		38	26	63	102.5	858				
	2003.04-2009.11	AT	R	F	Box Engine AXB	GDS83267	Drive Shaft		38	26	63	102.5	925				
	2003.04-2009.11	6MT		F	Box Engine AXB	GDS61191	Stub Shaft		26	42	60		135.5				
	2003.04-2009.11	5MT		F	Box Engine AXB	GDS61190	Stub Shaft		26	37	50		136.5				
2.0 (85 kW)	2003.11-			F	Box Engine AXA	GC061009	Outer Joint		38	27	63	102	66	M			
	2003.11-	MT		F	Box Engine AXA	GCI61041	Inner Joint			28		32					
	2003.11-	MT		F	Box Engine AXA	GCI61020	Inner Joint		26	28	50	205.5	63				
	2003.11-	5MT	L	F	Box Engine AXA	GDS61105	Drive Shaft		38		63	102.5	645				
	2003.11-	5MT	R	F	Box Engine AXA	GDS83246	Drive Shaft		38	26	63	102.5	858				
	2003.11-	6MT		F	Box Engine AXA	GDS61191	Stub Shaft		26	42	60		135.5				
	2003.11-	5MT		F	Box Engine AXA	GDS61190	Stub Shaft		26	37	50		136.5				
2.0 BitDi (132 kW)	2009.09-	5MT		F	Box Engine CFCA	GDS61190	Stub Shaft		26	37	50		136.5				
	2009.09-	AT		F	Box Engine CFCA	GC061011	Outer Joint		38	29	63	102.5	70	M			
	2009.09-	AT	L	F	Box Engine CFCA	GDS83293	Drive Shaft		38	37	63	102.5	645				
	2009.09-	MT	R	F	Box Engine CFCA	GDS83261	Drive Shaft		38	26	63	102	857				
	2009.09-	6MT		F	Box Engine CFCA	GDS61191	Stub Shaft		26	42	60		135.5				
2.0 BitDi 4motion (132 kW)	2009.09-	5MT			Box Engine CFCA	GDS61190	Stub Shaft		26	37	50		136.5				
	2009.09-				Box Engine CFCA	GC061011	Outer Joint		38	29	63	102.5	70	M			
	2009.09-	AT	L	F	Box Engine CFCA	GDS83293	Drive Shaft		38	37	63	102.5	645				
	2009.09-	6MT			Box Engine CFCA	GDS61191	Stub Shaft		26	42	60		135.5				
2.0 TDi (100 kW)	2010.05-	AT	L	F	Box Engine CAAE/CCHB	GDS83293	Drive Shaft		38	37	63	102.5	645				
	2010.05-	6MT		F	Box Engine CAAE/CCHB	GDS61191	Stub Shaft		26	42	60		135.5				
	2010.05-	5MT		F	Box Engine CAAE/CCHB	GDS61190	Stub Shaft		26	37	50		136.5				
2.0 TDi (103 kW)	2009.09-	5MT		F	Box Engine CAAC/CCHA	GDS61190	Stub Shaft		26	37	50		136.5				
	2009.09-	AT		F	Box Engine CAAC/CCHA	GC061011	Outer Joint		38	29	63	102.5	70	M			
	2009.09-	AT	L	F	Box Engine CAAC/CCHA	GDS83293	Drive Shaft		38	37	63	102.5	645				
	2009.09-	6MT		F	Box Engine CAAC/CCHA	GDS61191	Stub Shaft		26	42	60		135.5				
2.0 TDi (62 kW)	2009.09-	5MT		F	Box Engine CAAA	GDS61190	Stub Shaft		26	37	50		136.5				
	2009.09-	5MT	R	F	Box Engine CAAA	GDS83261	Drive Shaft		38	26	63	102	857				
	2009.09-	6MT		F	Box Engine CAAA	GDS61191	Stub Shaft		26	42	60		135.5				
2.0 TDi (75 kW)	2009.09-	5MT		F	Box Engine CAAB	GDS61190	Stub Shaft		26	37	50		136.5				
	2009.09-	5MT	R	F	Box Engine CAAB	GDS83261	Drive Shaft		38	26	63	102	857				
	2009.09-	6MT		F	Box Engine CAAB	GDS61191	Stub Shaft		26	42	60		135.5				
2.0 TDi (84 kW)	2011.05-	5MT	R	F	Box Engine CAAD	GDS83261	Drive Shaft		38	26	63	102	857				
	2011.05-	6MT		F	Box Engine CAAD	GDS61191	Stub Shaft		26	42	60		135.5				
	2011.05-	5MT		F	Box Engine CAAD	GDS61190	Stub Shaft		26	37	50		136.5				
2.0 TDi 4motion (100 kW)	2010.05-	6MT			Box Engine CAAE/CCHB	GDS61191	Stub Shaft		26	42	60		135.5				
	2010.05-	5MT			Box Engine CAAE/CCHB	GDS61190	Stub Shaft		26	37	50		136.5				
2.0 TDi 4motion (103 kW)	2009.09-	5MT			Box Engine CAAC/CCHA	GDS61190	Stub Shaft		26	37	50		136.5				
	2009.09-				Box Engine CAAC/CCHA	GC061011	Outer Joint		38	29	63	102.5	70	M			
	2009.09-	AT	L	F	Box Engine CAAC/CCHA	GDS83293	Drive Shaft		38	37	63	102.5	645				
	2009.09-	6MT			Box Engine CAAC/CCHA	GDS61191	Stub Shaft		26	42	60		135.5				
2.0 TSi (110 kW)	2012.07-	5MT		F	Box Engine CJKB	GDS61190	Stub Shaft		26	37	50		136.5				
	2012.07-	6MT		F	Box Engine CJKB	GDS61191	Stub Shaft		26	42	60		135.5				
2.0 TSi (150 kW)	2011.05-	6MT		F	Box Engine CJKB	GDS61191	Stub Shaft		26	42	60		135.5				



	 YEAR	TRANSM	L/R	F/R		G-AP Ref.	PRODUCT	ABS	Technical Specifications							
									A	B	C	H	L	P		
<b>VOLKSWAGEN</b>																
<b>TRANSPORTER V (7HA, 7HH, 7EA, 7EH)</b>																
2.0 TSi (150 kW)	2011.05-	5MT		F	Box Engine CJK	GDS61190	Stub Shaft		26	37	50		136.5			
2.0 TSi 4motion (150 kW)	2011.07-	AT	L	F	Box Engine CJK	GDS83293	Drive Shaft		38	37	63	102.5	645			
	2011.07-	6MT			Box Engine CJK	GDS61191	Stub Shaft		26	42	60		135.5			
	2011.07-	5MT			Box Engine CJK	GDS61190	Stub Shaft		26	37	50		136.5			
2.5 TDi (128 kW)	2003.04-2009.11	6MT		F	Box Engine AXE/BPC	GDS61191	Stub Shaft		26	42	60		135.5			
	2003.04-2009.11			F	Box Engine AXE/BPC	GC061011	Outer Joint		38	29	63	102.5	70	M		
	2003.04-2009.11	MT		F	Box Engine AXE/BPC	GCI61021	Inner Joint		26	30	50	288	78			
	2003.04-2009.11	MT		F	Box Engine AXE/BPC	GCI61029	Inner Joint		26	30	46.8	53	79			
	2003.04-2009.11	MT/6MT	L	F	Box Engine AXE/BPC	GDS61084	Drive Shaft		38	26	63	102.5	613			
	2003.04-2009.11	AT	R	F	Box Engine AXE/BPC	GDS61210	Drive Shaft		38	26	63	102.5	925			
	2003.04-2009.11	MT/6MT	R	F	Box Engine AXE/BPC	GDS61140	Drive Shaft		38	26	63	102.5	873			
	2003.04-2009.11	5MT		F	Box Engine AXE/BPC	GDS61190	Stub Shaft		26	37	50		136.5			
2.5 TDi (96 kW)	2003.04-2009.11	6MT		F	Box Engine AXD/BNZ	GDS61191	Stub Shaft		26	42	60		135.5			
	2003.04-2009.11			F	Box Engine AXD/BNZ	GC061011	Outer Joint		38	29	63	102.5	70	M		
	2003.04-2009.11	6MT	L	F	Box Engine AXD/BNZ	GDS61084	Drive Shaft		38	26	63	102.5	613			
	2003.04-2009.11	6AT	R	F	Box Engine AXD/BNZ	GDS61210	Drive Shaft		38	26	63	102.5	925			
	2003.04-2009.11	6MT	R	F	Box Engine AXD/BNZ	GDS61140	Drive Shaft		38	26	63	102.5	873			
	2003.04-2009.11	AT	R	F	Box Engine AXD/BNZ	GDS83267	Drive Shaft		38	26	63	102.5	925			
	2003.04-2009.11	5MT		F	Box Engine AXD/BNZ	GDS61190	Stub Shaft		26	37	50		136.5			
2.5 TDi 4motion (128 kW)	2004.07-2009.11	6MT			Box Engine AXE/BPC	GDS61191	Stub Shaft		26	42	60		135.5			
	2004.07-2009.11				Box Engine AXE/BPC	GC061011	Outer Joint		38	29	63	102.5	70	M		
	2004.07-2009.11	MT		F	Box Engine AXE/BPC	GCI61029	Inner Joint		26	30	46.8	53	79			
	2004.07-2009.11	6MT	L	F	Box Engine AXE/BPC	GDS61084	Drive Shaft		38	26	63	102.5	613			
	2004.07-2009.11	MT/AT	L	R	Box Engine AXE/BPC	GDS61257	Drive Shaft		38		59	100	683			
	2004.07-2009.11	MT/AT	R	R	Box Engine AXE/BPC	GDS61258	Drive Shaft		38		59	100	743			
	2004.07-2009.11	5MT			Box Engine AXE/BPC	GDS61190	Stub Shaft		26	37	50		136.5			
	2004.07-2009.11	6MT			Box Engine AXD/BNZ	GDS61191	Stub Shaft		26	42	60		135.5			
2.5 TDi 4motion (96 kW)	2004.07-2009.11	6MT			Box Engine AXD/BNZ	GDS61191	Stub Shaft		26	42	60		135.5			
	2004.07-2009.11				Box Engine AXD/BNZ	GC061011	Outer Joint		38	29	63	102.5	70	M		
	2004.07-2009.11	MT		F	Box Engine AXD/BNZ	GCI61029	Inner Joint		26	30	46.8	53	79			
	2004.07-2009.11	6MT	L	F	Box Engine AXD/BNZ	GDS61084	Drive Shaft		38	26	63	102.5	613			
	2004.07-2009.11	MT/AT	L	R	Box Engine AXD/BNZ	GDS61257	Drive Shaft		38		59	100	683			
	2004.07-2009.11	MT/AT	R	R	Box Engine AXD/BNZ	GDS61258	Drive Shaft		38		59	100	743			
	2004.07-2009.11	5MT			Box Engine AXD/BNZ	GDS61190	Stub Shaft		26	37	50		136.5			
	2004.07-2009.11	6MT			Box Engine BKK/CFLA	GDS61191	Stub Shaft		26	42	60		135.5			
3.2 4motion (173 kW)	2003.11-2009.11				Box Engine BKK/CFLA	GC061011	Outer Joint		38	29	63	102.5	70	M		
	2003.11-2009.11		L	R	Box Engine BKK/CFLA	GDS61257	Drive Shaft		38		59	100	683			
	2003.11-2009.11	5MT			Box Engine BKK/CFLA	GDS61190	Stub Shaft		26	37	50		136.5			
	2003.11-2009.11	6MT		F	Box Engine BDL	GDS61191	Stub Shaft		26	42	60		135.5			
3.2 V6 (170 kW)	2003.04-2004.06	AT		F	Box Engine BDL	GC061011	Outer Joint		38	29	63	102.5	70	M		
	2003.04-2004.06	AT	R	F	Box Engine BDL	GDS83267	Drive Shaft		38	26	63	102.5	925			
	2003.04-2004.06	5MT		F	Box Engine BDL	GDS61190	Stub Shaft		26	37	50		136.5			
	2003.04-2004.06	6MT		F	Box Engine BDL	GDS61191	Stub Shaft		26	42	60		135.5			
3.2 V6 (173 kW)	2004.02-2009.11	6MT		F	Box Engine BKK/CFLA	GDS61191	Stub Shaft		26	42	60		135.5			
	2004.02-2009.11	AT		F	Box Engine BKK/CFLA	GC061011	Outer Joint		38	29	63	102.5	70	M		
	2004.02-2009.11	AT	R	F	Box Engine BKK/CFLA	GDS83267	Drive Shaft		38	26	63	102.5	925			
	2004.02-2009.11	5MT		F	Box Engine BKK/CFLA	GDS61190	Stub Shaft		26	37	50		136.5			
<b>TRANSPORTER V (7JD, 7JE, 7JL, 7JY, 7JZ)</b>																
1.9 TDi (62 kW)	2006.01-2009.11	6MT		F	Platform/Chassis Engine BRR	GDS61191	Stub Shaft		26	42	60		135.5			
	2006.01-2009.11	MT		F	Platform/Chassis Engine BRR	GCI61041	Inner Joint			28		32				
	2006.01-2009.11	MT		F	Platform/Chassis Engine BRR	GCI61020	Inner Joint		26	28	50	205.5	63			
	2006.01-2009.11		L	F	Platform/Chassis Engine BRR	GDS61105	Drive Shaft		38		63	102.5	645			
	2006.01-2009.11		R	F	Platform/Chassis Engine BRR	GDS83246	Drive Shaft		38	26	63	102.5	858			
	2006.01-2009.11	AT	R	F	Platform/Chassis Engine BRR	GDS83267	Drive Shaft		38	26	63	102.5	925			
	2006.01-2009.11	5MT		F	Platform/Chassis Engine BRR	GDS61190	Stub Shaft		26	37	50		136.5			
1.9 TDi (63 kW)	2003.04-2009.11	6MT		F	Platform/Chassis Engine AXC	GDS61191	Stub Shaft		26	42	60		135.5			
	2003.04-2009.11			F	Platform/Chassis Engine AXC	GC061009	Outer Joint		38	27	63	102	66	M		
	2003.04-2009.11	MT		F	Platform/Chassis Engine AXC	GCI61041	Inner Joint			28		32				
	2003.04-2009.11	MT		F	Platform/Chassis Engine AXC	GCI61020	Inner Joint		26	28	50	205.5	63			
	2003.04-2009.11	5MT	L	F	Platform/Chassis Engine AXC	GDS61105	Drive Shaft		38		63	102.5	645			
	2003.04-2009.11	5MT	R	F	Platform/Chassis Engine AXC	GDS83246	Drive Shaft		38	26	63	102.5	858			
	2003.04-2009.11	AT	R	F	Platform/Chassis Engine AXC	GDS83267	Drive Shaft		38	26	63	102.5	925			
	2003.04-2009.11	5MT		F	Platform/Chassis Engine AXC	GDS61190	Stub Shaft		26	37	50		136.5			





		TRANSM	L/R	F/R		G-AP Ref.	PRODUCT	ABS	Technical Specifications								
									YEAR	A	B	C	H	L	P		
<b>VOLKSWAGEN</b>																	
<b>TRANSPORTER V (7JD, 7JE, 7JL, 7JY, 7JZ)</b>																	
1.9 TDi (75 kW)	2006.06-	2009.11	6MT		F	Platform/Chassis Engine BRS	GDS61191	Stub Shaft	26	42	60		135.5				
	2006.06-	2009.11	MT		F	Platform/Chassis Engine BRS	GC161041	Inner Joint		28		32					
	2006.06-	2009.11	MT		F	Platform/Chassis Engine BRS	GC161020	Inner Joint	26	28	50	205.5	63				
	2006.06-	2009.11		L	F	Platform/Chassis Engine BRS	GDS61105	Drive Shaft	38		63	102.5	645				
	2006.06-	2009.11		R	F	Platform/Chassis Engine BRS	GDS83246	Drive Shaft	38	26	63	102.5	858				
	2006.06-	2009.11	AT	R	F	Platform/Chassis Engine BRS	GDS83267	Drive Shaft	38	26	63	102.5	925				
	2006.06-	2009.11	5MT		F	Platform/Chassis Engine BRS	GDS61190	Stub Shaft	26	37	50		136.5				
1.9 TDi (77 kW)	2003.04-	2009.11	6MT		F	Platform/Chassis Engine AXB	GDS61191	Stub Shaft	26	42	60		135.5				
	2003.04-	2009.11			F	Platform/Chassis Engine AXB	GC061009	Outer Joint	38	27	63	102	66	M			
	2003.04-	2009.11	MT		F	Platform/Chassis Engine AXB	GC161041	Inner Joint		28		32					
	2003.04-	2009.11	MT		F	Platform/Chassis Engine AXB	GC161020	Inner Joint	26	28	50	205.5	63				
	2003.04-	2009.11	5MT	L	F	Platform/Chassis Engine AXB	GDS61105	Drive Shaft	38		63	102.5	645				
	2003.04-	2009.11	5MT	R	F	Platform/Chassis Engine AXB	GDS83246	Drive Shaft	38	26	63	102.5	858				
	2003.04-	2009.11	AT	R	F	Platform/Chassis Engine AXB	GDS83267	Drive Shaft	38	26	63	102.5	925				
	2003.04-	2009.11	5MT		F	Platform/Chassis Engine AXB	GDS61190	Stub Shaft	26	37	50		136.5				
2.0 (85 kW)	2003.11-		6MT		F	Platform/Chassis Engine AXA	GDS61191	Stub Shaft	26	42	60		135.5				
	2003.11-				F	Platform/Chassis Engine AXA	GC061009	Outer Joint	38	27	63	102	66	M			
	2003.11-		MT		F	Platform/Chassis Engine AXA	GC161041	Inner Joint		28		32					
	2003.11-		MT		F	Platform/Chassis Engine AXA	GC161020	Inner Joint	26	28	50	205.5	63				
	2003.11-		5MT	L	F	Platform/Chassis Engine AXA	GDS61105	Drive Shaft	38		63	102.5	645				
	2003.11-		5MT	R	F	Platform/Chassis Engine AXA	GDS83246	Drive Shaft	38	26	63	102.5	858				
2.0 BitDi (132 kW)	2009.09-		5MT		F	Platform/Chassis Engine CFCA	GDS61190	Stub Shaft	26	37	50		136.5				
	2009.09-		6MT		F	Platform/Chassis Engine CFCA	GDS61191	Stub Shaft	26	42	60		135.5				
	2009.09-		AT	L	F	Platform/Chassis Engine CFCA	GDS83293	Drive Shaft	38	37	63	102.5	645				
	2009.09-			R	F	Platform/Chassis Engine CFCA	GDS83261	Drive Shaft	38	26	63	102	857				
2.0 BitDi 4motion (132 kW)	2009.09-		5MT			Platform/Chassis Engine CFCA	GDS61190	Stub Shaft	26	37	50		136.5				
	2009.09-		6MT			Platform/Chassis Engine CFCA	GDS61191	Stub Shaft	26	42	60		135.5				
	2009.09-					Platform/Chassis Engine CFCA	GC061011	Outer Joint	38	29	63	102.5	70	M			
	2009.09-		AT	L	F	Platform/Chassis Engine CFCA	GDS83293	Drive Shaft	38	37	63	102.5	645				
2.0 TDi (100 kW)	2010.05-		6MT		F	Platform/Chassis Engine CAAE	GDS61191	Stub Shaft	26	42	60		135.5				
	2010.05-		AT	L	F	Platform/Chassis Engine CAAE	GDS83293	Drive Shaft	38	37	63	102.5	645				
	2010.05-		5MT		F	Platform/Chassis Engine CAAE	GDS61190	Stub Shaft	26	37	50		136.5				
2.0 TDi (103 kW)	2009.09-		5MT		F	Platform/Chassis Engine CAAC	GDS61190	Stub Shaft	26	37	50		136.5				
	2009.09-		6MT		F	Platform/Chassis Engine CAAC	GDS61191	Stub Shaft	26	42	60		135.5				
	2009.09-		AT		F	Platform/Chassis Engine CAAC	GC061011	Outer Joint	38	29	63	102.5	70	M			
	2009.09-		AT	L	F	Platform/Chassis Engine CAAC	GDS83293	Drive Shaft	38	37	63	102.5	645				
	2009.09-		MT	R	F	Platform/Chassis Engine CAAC	GDS83261	Drive Shaft	38	26	63	102	857				
2.0 TDi (62 kW)	2009.09-		5MT		F	Platform/Chassis Engine CAAA	GDS61190	Stub Shaft	26	37	50		136.5				
	2009.09-		6MT		F	Platform/Chassis Engine CAAA	GDS61191	Stub Shaft	26	42	60		135.5				
	2009.09-		5MT	R	F	Platform/Chassis Engine CAAA	GDS83261	Drive Shaft	38	26	63	102	857				
2.0 TDi (75 kW)	2009.09-		5MT		F	Platform/Chassis Engine CAAB	GDS61190	Stub Shaft	26	37	50		136.5				
	2009.09-		6MT		F	Platform/Chassis Engine CAAB	GDS61191	Stub Shaft	26	42	60		135.5				
	2009.09-		5MT	R	F	Platform/Chassis Engine CAAB	GDS83261	Drive Shaft	38	26	63	102	857				
2.0 TDi (84 kW)	2011.05-		6MT		F	Platform/Chassis Engine CAAD	GDS61191	Stub Shaft	26	42	60		135.5				
	2011.05-		MT	R	F	Platform/Chassis Engine CAAD	GDS83261	Drive Shaft	38	26	63	102	857				
	2011.05-		5MT		F	Platform/Chassis Engine CAAD	GDS61190	Stub Shaft	26	37	50		136.5				
2.0 TDi 4motion (100 kW)	2010.05-		5MT			Platform/Chassis Engine CAAE/CCHB	GDS61190	Stub Shaft	26	37	50		136.5				
	2010.05-		6MT			Platform/Chassis Engine CAAE/CCHB	GDS61191	Stub Shaft	26	42	60		135.5				
2.0 TDi 4motion (103 kW)	2009.09-		5MT			Platform/Chassis Engine CAAC	GDS61190	Stub Shaft	26	37	50		136.5				
	2009.09-		6MT			Platform/Chassis Engine CAAC	GDS61191	Stub Shaft	26	42	60		135.5				
	2009.09-					Platform/Chassis Engine CAAC	GC061011	Outer Joint	38	29	63	102.5	70	M			
	2009.09-		AT	L	F	Platform/Chassis Engine CAAC	GDS83293	Drive Shaft	38	37	63	102.5	645				
2.0 TSi (110 kW)	2012.07-		5MT		F	Platform/Chassis Engine CJKB	GDS61190	Stub Shaft	26	37	50		136.5				
	2012.07-		6MT		F	Platform/Chassis Engine CJKB	GDS61191	Stub Shaft	26	42	60		135.5				
2.5 TDi (128 kW)	2003.04-	2009.11	6MT		F	Platform/Chassis Engine AXE/BPC	GDS61191	Stub Shaft	26	42	60		135.5				
	2003.04-	2009.11			F	Platform/Chassis Engine AXE/BPC	GC061011	Outer Joint	38	29	63	102.5	70	M			
	2003.04-	2009.11	MT		F	Platform/Chassis Engine AXE/BPC	GC161021	Inner Joint	26	30	50	288	78				
	2003.04-	2009.11	MT		F	Platform/Chassis Engine AXE/BPC	GC161029	Inner Joint	26	30	46.8	53	79				
	2003.04-	2009.11	6MT	L	F	Platform/Chassis Engine AXE/BPC	GDS61084	Drive Shaft	38	26	63	102.5	613				
	2003.04-	2009.11	6AT	R	F	Platform/Chassis Engine AXE/BPC	GDS61210	Drive Shaft	38	26	63	102.5	925				









		YEAR	TRANSM	L/R	F/R		G-AP Ref.	PRODUCT	ABS	Technical Specifications						
										A	B	C	H	L	P	
<b>VOLKSWAGEN</b>																
<b>TRANSPORTER V (7JD, 7JE, 7JL, 7JY, 7JZ)</b>																
2.5 TDi (128 kW)	2003.04-	2009.11	6MT	R	F	Platform/Chassis Engine AXE/BPC	GDS61140	Drive Shaft		38	26	63	102.5	873		
	2003.04-	2009.11	AT	R	F	Platform/Chassis Engine AXE/BPC	GDS83267	Drive Shaft		38	26	63	102.5	925		
	2003.04-	2009.11	5MT		F	Platform/Chassis Engine AXE/BPC	GDS61190	Stub Shaft		26	37	50		136.5		
2.5 TDi (96 kW)	2003.04-	2009.11	6MT		F	Platform/Chassis Engine AXD/BNZ	GDS61191	Stub Shaft		26	42	60		135.5		
	2003.04-	2009.11			F	Platform/Chassis Engine AXD/BNZ	GC061011	Outer Joint		38	29	63	102.5	70	M	
	2003.04-	2009.11	MT		F	Platform/Chassis Engine AXD/BNZ	GCI61021	Inner Joint		26	30	50	288	78		
	2003.04-	2009.11	MT		F	Platform/Chassis Engine AXD/BNZ	GCI61029	Inner Joint		26	30	46.8	53	79		
	2003.04-	2009.11	6MT	L	F	Platform/Chassis Engine AXD/BNZ	GDS61084	Drive Shaft		38	26	63	102.5	613		
	2003.04-	2009.11	6AT	R	F	Platform/Chassis Engine AXD/BNZ	GDS61210	Drive Shaft		38	26	63	102.5	925		
	2003.04-	2009.11	6MT	R	F	Platform/Chassis Engine AXD/BNZ	GDS61140	Drive Shaft		38	26	63	102.5	873		
	2003.04-	2009.11	AT	R	F	Platform/Chassis Engine AXD/BNZ	GDS83267	Drive Shaft		38	26	63	102.5	925		
	2003.04-	2009.11	5MT		F	Platform/Chassis Engine AXD/BNZ	GDS61190	Stub Shaft		26	37	50		136.5		
2.5 TDi 4motion (128 kW)	2004.04-	2009.11	5MT			Platform/Chassis Engine AXE/BPC	GDS61190	Stub Shaft		26	37	50		136.5		
	2004.04-	2009.11	6MT			Platform/Chassis Engine AXE/BPC	GDS61191	Stub Shaft		26	42	60		135.5		
	2004.04-	2009.11	MT		F	Platform/Chassis Engine AXE/BPC	GCI61029	Inner Joint		26	30	46.8	53	79		
	2004.04-	2009.11		L	F	Platform/Chassis Engine AXE/BPC	GDS61084	Drive Shaft		38	26	63	102.5	613		
	2004.04-	2009.11		L	R	Platform/Chassis Engine AXE/BPC	GDS61257	Drive Shaft		38		59	100	683		
2.5 TDi 4motion (96 kW)	2004.07-	2009.11	6MT			Platform/Chassis Engine AXD/BNZ	GDS61191	Stub Shaft		26	42	60		135.5		
	2004.07-	2009.11				Platform/Chassis Engine AXD/BNZ	GC061011	Outer Joint		38	29	63	102.5	70	M	
	2004.07-	2009.11	MT		F	Platform/Chassis Engine AXD/BNZ	GCI61029	Inner Joint		26	30	46.8	53	79		
	2004.07-	2009.11	6MT	L	F	Platform/Chassis Engine AXD/BNZ	GDS61084	Drive Shaft		38	26	63	102.5	613		
	2004.07-	2009.11	AT	R	F	Platform/Chassis Engine AXD/BNZ	GDS83267	Drive Shaft		38	26	63	102.5	925		
	2004.07-	2009.11	MT/AT	L	R	Platform/Chassis Engine AXD/BNZ	GDS61257	Drive Shaft		38		59	100	683		
	2004.07-	2009.11	5MT			Platform/Chassis Engine AXD/BNZ	GDS61190	Stub Shaft		26	37	50		136.5		
3.2 V6 (170 kW)	2004.02-	2009.11	6MT		F	Platform/Chassis Engine BDL	GDS61191	Stub Shaft		26	42	60		135.5		
	2004.02-	2009.11	AT		F	Platform/Chassis Engine BDL	GC061011	Outer Joint		38	29	63	102.5	70	M	
	2004.02-	2009.11	AT	R	F	Platform/Chassis Engine BDL	GDS83267	Drive Shaft		38	26	63	102.5	925		
	2004.02-	2009.11	5MT		F	Platform/Chassis Engine BDL	GDS61190	Stub Shaft		26	37	50		136.5		
3.2 V6 (173 kW)	2003.08-	2006.05	AT		F	Platform/Chassis Engine BKK	GC061011	Outer Joint		38	29	63	102.5	70	M	
	2003.08-	2006.05	AT	R	F	Platform/Chassis Engine BKK	GDS83267	Drive Shaft		38	26	63	102.5	925		
	2003.08-	2006.05	6MT			Platform/Chassis Engine BKK	GDS61191	Stub Shaft		26	42	60		135.5		
	2003.08-	2006.05	5MT			Platform/Chassis Engine BKK	GDS61190	Stub Shaft		26	37	50		136.5		
<b>TRANSPORTER V 1.9 TDI</b>																
—	2003-	2009		L	F		GDS83278	Drive Shaft		38		63	102	643		
<b>TRANSPORTER VI 2.0</b>																
—	2011-			L	F		GDS83278	Drive Shaft		38		63	102	643		
<b>UP</b>																
1.0 (44 kW)	2011.12-			L	F	Hatchback Engine CHYA	GDS50567	Drive Shaft		22	28	46	78	650		
	2011.12-		MT	L/R	F	Hatchback Engine CHYA	GC050170	Outer Joint		22	26	46	78	53	M	
	2011.12-			R	F	Hatchback Engine CHYA	GDS50543	Drive Shaft		22	28	46	78	814		
1.0 (55 kW)	2011.12-			L	F	Hatchback Engine CHYB	GDS50567	Drive Shaft		22	28	46	78	650		
	2011.12-			L/R	F	Hatchback Engine CHYB	GC050170	Outer Joint		22	26	46	78	53	M	
	2011.12-			R	F	Hatchback Engine CHYB	GDS50543	Drive Shaft		22	28	46	78	814		
1.0 EcoFuel (50 kW)	2012.11-			L	F	Hatchback Engine CPGA	GDS50567	Drive Shaft		22	28	46	78	650		
	2012.11-		MT	L/R	F	Hatchback Engine CPGA	GC050170	Outer Joint		22	26	46	78	53	M	
	2012.11-			R	F	Hatchback Engine CPGA	GDS50543	Drive Shaft		22	28	46	78	814		
	2012.11-					Hatchback Engine CPGA	GC050153	Outer Joint		22	26	46	78	55	M	
<b>VARIANT ALEMAO</b>																
2	1988.01-	1997.12	MT/AT				GCI61022	Inner Joint			33		34			
2.0 16V	1983.01-	1997.12	MT				GCI61022	Inner Joint			33		34			
	1990.01-	1997.12	AT				GCI61022	Inner Joint			33		34			
2.8	1988.01-	1997.12	MT/AT				GCI61022	Inner Joint			33		34			
<b>VENTO</b>																
1.8 CL GT	1991.11-			R			GDS61012	Drive Shaft		22		50	78	773		
1.9 TDi	1991.11-			R			GDS61012	Drive Shaft		22		50	78	773		
2	1992.10-	1998.01	MT	R	F		GDS61062	Drive Shaft		36		53.2	77.5	788		
2.0 GT	1991.11-			R			GDS61012	Drive Shaft		22		50	78	773		
2.8 V6	1992.10-	1998.01	MT	R	F		GDS61062	Drive Shaft		36		53.2	77.5	788		
<b>VENTO (1H2)</b>																
1.4 (40 kW)	1991.11-	1998.09	MT	L	F	Saloon Engine ABD/AEX	GDS61172	Drive Shaft		22		53	78	584.5		
	1991.11-	1998.09	MT	R	F	Saloon Engine ABD/AEX	GDS61067	Drive Shaft		22		51	78.7	781		

		TRANSM	L/R	F/R		G-AP Ref.	PRODUCT	ABS	Technical Specifications											
									YEAR	A	B	C	H	L	P					
<b>VOLKSWAGEN</b>																				
<b>VENTO (1H2)</b>																				
1.4 (40 kW)	1991.11-	1998.09	MT	R	F	Saloon Engine ABD/AEX	GDS61055	Drive Shaft	22		53	78.5	796							
1.4 (44 kW)	1991.11-	1998.09	MT	L	F	Saloon Engine ABD/AEX	GDS61172	Drive Shaft	22		53	78	584.5							
	1991.11-	1998.09	MT	R	F	Saloon Engine ABD/AEX	GDS61067	Drive Shaft	22		51	78.7	781							
	1991.11-	1998.09	MT	R	F	Saloon Engine ABD/AEX	GDS61055	Drive Shaft	22		53	78.5	796							
1.6 (55 kW)	1992.09-	1998.09	MT	L	F	Saloon Engine ABU/AEA/AEE	GDS61172	Drive Shaft	22		53	78	584.5							
	1992.09-	1998.09	MT	R	F	Saloon Engine ABU/AEA/AEE	GDS61067	Drive Shaft	22		51	78.7	781							
	1992.09-	1998.09	MT	R	F	Saloon Engine ABU/AEA/AEE	GDS61055	Drive Shaft	22		53	78.5	796							
1.6 (74 kW)	1994.10-	1998.09	MT	R	F	Saloon Engine AEK/AFT	GDS61055	Drive Shaft	22		53	78.5	796							
	1994.10-	1998.09	AT	L	F	Saloon Engine AEK/AFT	GDS61011	Drive Shaft	22		53.2	78	547							
	1994.10-	1998.09	AT	R	F	Saloon Engine AEK/AFT	GDS61028	Drive Shaft	22		53.2	78	767							
1.8 (55 kW)	1991.11-	1998.09	MT	R	F	Saloon Engine AAM	GDS61009	Drive Shaft	22		53.2	78	789							
	1991.11-	1998.09	MT	L	F	Saloon Engine AAM	GDS61001	Drive Shaft	22		53.2	78	557							
1.8 (66 kW)	1991.11-	1998.09		R	F	Saloon Engine ABS/ADZ	GDS61009	Drive Shaft	22		53.2	78	789							
	1991.11-	1998.09	MT&AT	L	F	Saloon Engine ABS/ADZ	GDS61001	Drive Shaft	22		53.2	78	557							
	1991.11-	1998.09	AT	L	F	Saloon Engine ABS/ADZ	GDS61011	Drive Shaft	22		53.2	78	547							
	1991.11-	1998.09	AT	R	F	Saloon Engine ABS/ADZ	GDS61028	Drive Shaft	22		53.2	78	767							
1.9 D (48 kW)	1991.11-	1998.09	MT	R	F	Saloon Engine 1Y	GDS61055	Drive Shaft	22		53	78.5	796							
1.9 TD (55 kW)	1991.11-	1998.09	MT&AT	R	F	Saloon Engine AAZ	GDS61009	Drive Shaft	22		53.2	78	789							
	1991.11-	1998.09	MT&AT	L	F	Saloon Engine AAZ	GDS61001	Drive Shaft	22		53.2	78	557							
	1991.11-	1998.09	AT	L	F	Saloon Engine AAZ	GDS61011	Drive Shaft	22		53.2	78	547							
	1991.11-	1998.09	AT	R	F	Saloon Engine AAZ	GDS61028	Drive Shaft	22		53.2	78	767							
1.9 TDi (66 kW)	1993.09-	1998.09	MT	L	F	Saloon Engine 1Z/AHU/ALE	GDS61001	Drive Shaft	22		53.2	78	557							
	1993.09-	1998.09	MT	R	F	Saloon Engine 1Z/AHU/ALE	GDS61002	Drive Shaft	22		53	78.5	793							
1.9 TDi (81 kW)	1996.04-	1998.09	MT	L	F	Saloon Engine AFN	GDS61001	Drive Shaft	22		53.2	78	557							
	1996.04-	1998.09	MT	R	F	Saloon Engine AFN	GDS61002	Drive Shaft	22		53	78.5	793							
2.0 (85 kW)	1991.11-	1998.09	MT/AT	R	F	Saloon Engine 2E/ADY/AGG/AKR	GDS61009	Drive Shaft	22		53.2	78	789							
	1991.11-	1998.09	MT&AT	L	F	Saloon Engine 2E/ADY/AGG/AKR	GDS61001	Drive Shaft	22		53.2	78	557							
	1991.11-	1998.09	AT	L	F	Saloon Engine 2E/ADY/AGG/AKR	GDS61011	Drive Shaft	22		53.2	78	547							
	1991.11-	1998.09	AT	R	F	Saloon Engine 2E/ADY/AGG/AKR	GDS61028	Drive Shaft	22		53.2	78	767							
<b>VOLKSWAGEN LCV</b>																				
<b>CADDY II</b>																				
1.9 SDi	1996.04-		MT	L	F		GDS61030	Drive Shaft	22		50	77.5	539.7							
<b>CADDY II (9K9)</b>																				
1.9 TDi (66 kW)	1996.09-	2004.01		R			GCI83011	Inner Joint			33		34							
<b>CADDY III (2KA, 2KB, 2KH, 2KJ)</b>																				
1.4 16V (55 kW)	2004.05-						GC083037	Outer Joint	36	30	59.5	40.5	55	I						
1.4 16V (59 kW)	2004.05-						GC083037	Outer Joint	36	30	59.5	40.5	55	I						
1.6 (75 kW)	2004.04-						GC083037	Outer Joint	36	30	59.5	40.5	55	I						
1.9 SDi (55 kW)	2004.04-						GC083002	Outer Joint	36	27	59.5	40	66	I						
1.9 TDi (77 kW)	2004.04-						GC083002	Outer Joint	36	27	59.5	40	66	I						
2.0 EcoFuel (80 kW)	2006.04-						GC083037	Outer Joint	36	30	59.5	40.5	55	I						
2.0 SDi (51 kW)	2004.03-						GC083037	Outer Joint	36	30	59.5	40.5	55	I						
<b>CADDY IV (2CA, 2CB)</b>																				
1.2 TSi (63 kW)	2010.09-			L			GC083002	Outer Joint	36	27	59.5	40	66	I						
1.2 TSi (77 kW)	2010.09-			L			GC083002	Outer Joint	36	27	59.5	40	66	I						
1.6 (75 kW)		2011.05					GC083037	Outer Joint	36	30	59.5	40.5	55	I						
		2011.05-					GC083002	Outer Joint	36	27	59.5	40	66	I						
1.6 LPG (75 kW)		2011.05					GC083037	Outer Joint	36	30	59.5	40.5	55	I						
		2011.05-					GC083002	Outer Joint	36	27	59.5	40	66	I						
1.6 TDi (55 kW)	2010.08-			R			GC083002	Outer Joint	36	27	59.5	40	66	I						
1.6 TDi (75 kW)	2010.08-			R			GC083002	Outer Joint	36	27	59.5	40	66	I						
2.0 Ecofuel (80 kW)	2010.10-			L			GC083002	Outer Joint	36	27	59.5	40	66	I						
	2010.10-			R			GC083037	Outer Joint	36	30	59.5	40.5	55	I						
2.0 TDi 16V (103 kW)	2010.11-			R			GC083002	Outer Joint	36	27	59.5	40	66	I						
2.0 TDi 16V (62 kW)	2010.11-			R			GC083002	Outer Joint	36	27	59.5	40	66	I						
<b>MULTIVAN V (7HM, 7HF)</b>																				
2.5 TDi (120 kW)	2003-			L			GCI61029	Inner Joint	26	30	46.8	53	79							
2.5 TDi 4motion (128 kW)	2003.04-			L			GCI61029	Inner Joint	26	30	46.8	53	79							
2.5 TDi 4motion (96 kW)	2003.04-			L			GCI61029	Inner Joint	26	30	46.8	53	79							



		TRANSM	L/R	F/R		G-AP Ref.	PRODUCT	ABS	Technical Specifications												
									YEAR	A	B	C	H	L	P						
<b>VOLKSWAGEN LCV</b>																					
<b>TRANSPORTER V (7HA/B/H/J, JD/EL)</b>																					
2.5 TDi 4motion (120 kW)	2003.04-	2009.11																			
2.5 TDi 4motion (128 kW)	2003.04-	2009.11																			
2.5 TDi 4motion (96 kW)	2003.04-	2009.11																			
<b>VOLVO</b>																					
<b>440 K (445)</b>																					
1.7 (64 kW)	1988.09-	1996.12	MT		F	Hatchback Engine B18KP	GC062006	Outer Joint		22	22	50	83	52	O						
	1988.09-	1996.12	MT		F	Hatchback Engine B18KP	GC062007	Outer Joint	44T	22	22	50	83	52	O						
1.7 (70 kW)	1988.08-	1989.07	MT		F	Hatchback Engine B18F	GC062006	Outer Joint		22	22	50	83	52	O						
	1988.08-	1989.07	MT		F	Hatchback Engine B18F	GC062007	Outer Joint	44T	22	22	50	83	52	O						
1.7 (75 kW)	1989.08-	1996.12	MT		F	Hatchback Engine B18FP	GC062006	Outer Joint		22	22	50	83	52	O						
	1989.08-	1996.12	MT		F	Hatchback Engine B18FP	GC062007	Outer Joint	44T	22	22	50	83	52	O						
1.7 Turbo (88 kW)	1988.08-	1996.07	MT		F	Hatchback Engine B18FT	GC062004	Outer Joint		22	25	50	83	61	O						
	1988.08-	1996.07	MT		F	Hatchback Engine B18FT	GC062005	Outer Joint	44T	22	25	50	83	61	O						
1.7 Turbo (90 kW)	1991.01-	1996.12	MT		F	Hatchback Engine B18FT	GC062004	Outer Joint		22	25	50	83	61	O						
	1991.01-	1996.12	MT		F	Hatchback Engine B18FT	GC062005	Outer Joint	44T	22	25	50	83	61	O						
1.8 (66 kW)	1991.08-	1996.07	MT		F	Hatchback Engine B18U	GC062006	Outer Joint		22	22	50	83	52	O						
	1991.08-	1996.07	MT		F	Hatchback Engine B18U	GC062007	Outer Joint	44T	22	22	50	83	52	O						
2.0 (80 kW)	1993.08-	1996.07	MT		F	Hatchback Engine B20F	GC062006	Outer Joint		22	22	50	83	52	O						
	1993.08-	1996.07	MT		F	Hatchback Engine B20F	GC062007	Outer Joint	44T	22	22	50	83	52	O						
2.0 (81 kW)	1992.08-	1995.07	MT		F	Hatchback Engine B20F	GC062006	Outer Joint		22	22	50	83	52	O						
	1992.08-	1995.07	MT		F	Hatchback Engine B20F	GC062007	Outer Joint	44T	22	22	50	83	52	O						
<b>460 L (464)</b>																					
1.7 (64 kW)	1988.09-	1996.07	MT		F	Saloon Engine B18KP	GC062006	Outer Joint		22	22	50	83	52	O						
	1988.09-	1996.07	MT		F	Saloon Engine B18KP	GC062007	Outer Joint	44T	22	22	50	83	52	O						
1.7 (75 kW)	1989.08-	1992.07	MT		F	Saloon Engine B18EP	GC062006	Outer Joint		22	22	50	83	52	O						
	1989.08-	1992.07	MT		F	Saloon Engine B18EP	GC062007	Outer Joint	44T	22	22	50	83	52	O						
1.7 Turbo (88 kW)	1989.08-	1996.07	MT		F	Saloon Engine B18FT	GC062004	Outer Joint		22	25	50	83	61	O						
	1989.08-	1996.07	MT		F	Saloon Engine B18FT	GC062005	Outer Joint	44T	22	25	50	83	61	O						
1.7 Turbo (90 kW)	1991.01-	1996.07	MT		F	Saloon Engine B18FT	GC062004	Outer Joint		22	25	50	83	61	O						
	1991.01-	1996.07	MT		F	Saloon Engine B18FT	GC062005	Outer Joint	44T	22	25	50	83	61	O						
<b>480 E</b>																					
1.7 (70 kW)	1987.08-	1989.07	MT		F	Coupe Engine B18F	GC062006	Outer Joint		22	22	50	83	52	O						
	1987.08-	1989.07	MT		F	Coupe Engine B18F	GC062007	Outer Joint	44T	22	22	50	83	52	O						
1.7 (75 kW)	1989.08-	1996.07	MT		F	Coupe Engine B18EP	GC062006	Outer Joint		22	22	50	83	52	O						
	1989.08-	1996.07	MT		F	Coupe Engine B18EP	GC062007	Outer Joint	44T	22	22	50	83	52	O						
1.7 (78 kW)	1986.04-	1989.07	MT		F	Coupe Engine B18E	GC062006	Outer Joint		22	22	50	83	52	O						
	1986.04-	1989.07	MT		F	Coupe Engine B18E	GC062007	Outer Joint	44T	22	22	50	83	52	O						
1.7 (80 kW)	1986.08-	1988.07	MT		F	Coupe Engine B18E	GC062006	Outer Joint		22	22	50	83	52	O						
	1986.08-	1988.07	MT		F	Coupe Engine B18E	GC062007	Outer Joint	44T	22	22	50	83	52	O						
1.7 Turbo (88 kW)	1987.08-	1996.07	MT		F	Coupe Engine B18FT	GC062004	Outer Joint		22	25	50	83	61	O						
	1987.08-	1996.07	MT		F	Coupe Engine B18FT	GC062005	Outer Joint	44T	22	25	50	83	61	O						
1.7 Turbo (90 kW)	1991.01-	1996.07	MT		F	Coupe Engine B18FT	GC062004	Outer Joint		22	25	50	83	61	O						
	1991.01-	1996.07	MT		F	Coupe Engine B18FT	GC062005	Outer Joint	44T	22	25	50	83	61	O						
<b>C30</b>																					
1.6 (74 kW)	2006.10-	2008.02	MT	L	F	Hatchback Engine B4164S3	GDS18189	Drive Shaft		36	23	56	48	601							
	2006.10-	2008.02	MT	L	F	Hatchback Engine B4164S3	GCI18168	Inner Joint		23	22	40	61	90							
	2006.10-	2008.02	MT	L	F	Hatchback Engine B4164S3	GC018264	Outer Joint		36	25	51.6	48	58	O						
	2006.10-	2008.02	MT	R	F	Hatchback Engine B4164S3	GDS18206	Drive Shaft		36	23	56	48	906							
	2006.10-	2008.02		R	F	Hatchback Engine B4164S3	GDS18337	Drive Shaft		36	23	51.6	48	908							
1.8 (92 kW)	2006.10-	2008.02	5MT	L	F	Hatchback Engine B4184S11	GDS18328	Drive Shaft		36	26	55.3	48	580							
	2006.10-	2008.02	5MT	R	F	Hatchback Engine B4184S11	GDS18329	Drive Shaft		36	26	55.3	48	920							
1.8 FlexFuel (92 kW)	2007.01-	2012.12	5MT	L	F	Hatchback Engine B4184S8	GDS18328	Drive Shaft		36	26	55.3	48	580							
	2007.01-	2012.12	5MT	R	F	Hatchback Engine B4184S8	GDS18329	Drive Shaft		36	26	55.3	48	920							
2.0 (107 kW)	2006.10-	2008.02	5MT	L	F	Hatchback Engine B4204S3	GDS18328	Drive Shaft		36	26	55.3	48	580							
	2006.10-	2008.02	5MT	R	F	Hatchback Engine B4204S3	GDS18329	Drive Shaft		36	26	55.3	48	920							
2.0 D (100 kW)	2006.10-	2008.02	AT	L	F	Hatchback Engine D4204T	GDS18367	Drive Shaft		36	28	56	48	570							
	2006.10-	2008.02	MT	L	F	Hatchback Engine D4204T	GDS18194	Drive Shaft		36	26	56	48	568							
2.4 D5 (120 kW)	2006.10-	2012.12		L	F	Hatchback Engine D5244T9	GDS62060	Drive Shaft		36	26	56	48	519							
	2006.10-	2012.12	AT	R	F	Hatchback Engine D5244T9	GDS18192	Drive Shaft		36	26	56	48	949							
	2006.10-	2012.12		R	F	Hatchback Engine D5244T9	GDS62063	Drive Shaft		36	26	56	48	947							
2.4 D5 (132 kW)	2006.10-	2008.02	AT	L	F	Hatchback Engine D5244T13/D5244T8	GDS62060	Drive Shaft		36	26	56	48	519							





		YEAR	TRANSM	L/R	F/R		G-AP Ref.	PRODUCT	ABS	Technical Specifications										
										A	B	C	H	L	P					
<b>VOLVO</b>																				
<b>C30</b>																				
2.4 D5 (132 kW)	2006.10-	2008.02	AT	R	F	Hatchback Engine D5244T13/D5244T8	GDS62063	Drive Shaft		36	26	56	48	947						
2.4 i (125 kW)	2006.10-	2008.02	Semi-AT	L	F	Hatchback Engine B5244S4	GDS62060	Drive Shaft		36	26	56	48	519						
	2006.10-	2008.02	AT	R	F	Hatchback Engine B5244S4	GDS18192	Drive Shaft		36	26	56	48	949						
	2006.10-	2008.02	Semi-AT	R	F	Hatchback Engine B5244S4	GDS62063	Drive Shaft		36	26	56	48	947						
2.5 T5 (162 kW)	2006.10-	2008.02	Semi-AT	L	F	Hatchback Engine B5254T3	GDS62060	Drive Shaft		36	26	56	48	519						
	2006.10-	2008.02	AT	R	F	Hatchback Engine B5254T3	GDS18192	Drive Shaft		36	26	56	48	949						
2.5 T5 (169 kW)	2007.07-	2012.12		L	F	Hatchback Engine B5254T7	GDS62060	Drive Shaft		36	26	56	48	519						
	2007.07-	2012.12	AT	R	F	Hatchback Engine B5254T7	GDS18192	Drive Shaft		36	26	56	48	949						
<b>C70 I</b>																				
2.0 (132 kW)	1997.03-	2002.09			F	Coupe Engine B5204T2	GC062014	Outer Joint		26	25	56.5	98.5	56	O					
	1997.03-	2002.09	MT		F	Coupe Engine B5204T2	GC162015	Inner Joint		26	25	40	531.5	66.5						
	1997.03-	2002.09	MT/AT		F	Coupe Engine B5204T2	GC062010	Outer Joint	48T	36	33	56.5	48	58	M					
	1997.03-	2002.09	MT/AT		F	Coupe Engine B5204T2	GC062001	Outer Joint	48T	26	25	56.5	98.5	56	O					
	1997.03-	2002.09	AT	L	F	Coupe Engine B5204T2	GDS62001	Drive Shaft	48T	26	26	56.5	98.5	574.5						
	1997.03-	2002.09	AT	R	F	Coupe Engine B5204T2	GDS62002	Drive Shaft	48T	26	26	56.5	98.5	1028						
	1998.03-	2005.10			F	Convertible Engine B5204T2	GC062014	Outer Joint		26	25	56.5	98.5	56	O					
	1998.03-	2005.10	MT/AT		F	Convertible Engine B5204T2	GC062010	Outer Joint	48T	36	33	56.5	48	58	M					
2.0 T (120 kW)	1998.03-	2005.10	MT/AT		F	Convertible Engine B5204T2	GC062001	Outer Joint	48T	26	25	56.5	98.5	56	O					
	2000.03-	2002.09			F	Coupe Engine B5204T4	GC062016	Outer Joint		26	28	56.5	97.5	66	O					
	2000.03-	2002.09	MT		F	Coupe Engine B5204T4	GC062009	Outer Joint	48T	36	27	56.5	48	66	M					
	2000.03-	2002.09	MT/AT		F	Coupe Engine B5204T4	GC062010	Outer Joint	48T	36	33	56.5	48	58	M					
	2000.03-	2005.10			F	Convertible Engine B5204T4	GC062016	Outer Joint		26	28	56.5	97.5	66	O					
	2000.03-	2005.10	MT		F	Convertible Engine B5204T4	GC062009	Outer Joint	48T	36	27	56.5	48	66	M					
2.0 T (166 kW)	2000.03-	2005.10	MT/AT		F	Convertible Engine B5204T4	GC062010	Outer Joint	48T	36	33	56.5	48	58	M					
	1997.03-	2002.09			F	Coupe Engine B5204T3	GC062016	Outer Joint		26	28	56.5	97.5	66	O					
	1997.03-	2002.09	MT		F	Coupe Engine B5204T3	GC062009	Outer Joint	48T	36	27	56.5	48	66	M					
	1997.03-	2002.09	MT/AT		F	Coupe Engine B5204T3	GC062002	Outer Joint	48T	26	28	56.5	97.5	66	O					
	1998.03-	2005.10			F	Convertible Engine B5204T3	GC062016	Outer Joint		26	28	56.5	97.5	66	O					
	1998.03-	2005.10	MT		F	Convertible Engine B5204T3	GC062009	Outer Joint	48T	36	27	56.5	48	66	M					
2.3 T5 (176 kW)	1998.03-	2005.10	MT/AT		F	Convertible Engine B5204T3	GC062002	Outer Joint	48T	26	28	56.5	97.5	66	O					
	1997.03-	2002.09			F	Coupe Engine B5234T3	GC062016	Outer Joint		26	28	56.5	97.5	66	O					
	1997.03-	2002.09	MT		F	Coupe Engine B5234T3	GC062009	Outer Joint	48T	36	27	56.5	48	66	M					
	1997.03-	2002.09	MT/AT		F	Coupe Engine B5234T3	GC062002	Outer Joint	48T	26	28	56.5	97.5	66	O					
	1997.03-	2002.09	MT	R	F	Coupe Engine B5234T3	GDS62028	Drive Shaft	48T	36	26	56.5	48	990						
	1997.03-	2002.09	MT	R	F	Coupe Engine B5234T3	GC162030	Inner Joint		26	25	40	526	92.5						
2.3 T5 (180 kW)	1997.03-	2002.09	MT	R	F	Coupe Engine B5234T3	GC062040	Outer Joint	48T	36	25	56.5	48	58	M					
	1998.03-	2005.10			F	Convertible Engine B5234T3	GC062016	Outer Joint		26	28	56.5	97.5	66	O					
	1998.03-	2005.10	MT		F	Convertible Engine B5234T3	GC062009	Outer Joint	48T	36	27	56.5	48	66	M					
	1998.03-	2005.10	MT/AT		F	Convertible Engine B5234T3	GC062002	Outer Joint	48T	26	28	56.5	97.5	66	O					
	2002.07-	2005.10			F	Convertible Engine B5234T9	GC062016	Outer Joint		26	28	56.5	97.5	66	O					
	2002.07-	2005.10			F	Convertible Engine B5234T9	GC052008	Outer Joint	29T	33	27	59	98	65	I					
2.4 T (147 kW)	2002.07-	2005.10	MT		F	Convertible Engine B5234T9	GC062009	Outer Joint	48T	36	27	56.5	48	66	M					
	2002.07-	2005.10	MT	R	F	Convertible Engine B5234T9	GDS62028	Drive Shaft	48T	36	26	56.5	48	990						
	2002.07-	2005.10	MT	R	F	Convertible Engine B5234T9	GC162030	Inner Joint		26	25	40	526	92.5						
	2002.07-	2005.10	MT	R	F	Convertible Engine B5234T9	GC062040	Outer Joint	48T	36	25	56.5	48	58	M					
2.5 (121 kW)	1999.04-	2002.08			F	Convertible Engine B5244T7	GC062016	Outer Joint		26	28	56.5	97.5	66	O					
	1999.04-	2002.08	MT		F	Convertible Engine B5244T7	GC062009	Outer Joint	48T	36	27	56.5	48	66	M					
2.5 (125 kW)	1999.03-	2002.09	MT	R	F	Coupe Engine B5254S	GDS62028	Drive Shaft	48T	36	26	56.5	48	990						
	1999.03-	2002.09	MT	R	F	Coupe Engine B5254S	GC162030	Inner Joint		26	25	40	526	92.5						
	1999.03-	2002.09	MT	R	F	Coupe Engine B5254S	GC062040	Outer Joint	48T	36	25	56.5	48	58	M					
	1999.03-	2002.09	MT/AT		F	Coupe Engine B5254S	GC062010	Outer Joint	48T	36	33	56.5	48	58	M					
2.5 T (142 kW)	1998.06-	2005.10			F	Convertible Engine B5254S	GC062014	Outer Joint		26	25	56.5	98.5	56	O					
	1998.06-	2005.10	MT		F	Convertible Engine B5254S	GC062009	Outer Joint	48T	36	27	56.5	48	66	M					
	1998.06-	2005.10	MT/AT		F	Convertible Engine B5254S	GC062010	Outer Joint	48T	36	33	56.5	48	58	M					
	1999.05-	2002.09			F	Coupe Engine B5244S/B5254S	GC062014	Outer Joint		26	25	56.5	98.5	56	O					
	1999.05-	2002.09	MT/AT		F	Coupe Engine B5244S/B5254S	GC062010	Outer Joint	48T	36	33	56.5	48	58	M					
	1999.05-	2002.09	MT	R	F	Coupe Engine B5244S/B5254S	GDS62028	Drive Shaft	48T	36	26	56.5	48	990						
	1999.05-	2002.09	MT	R	F	Coupe Engine B5244S/B5254S	GC162030	Inner Joint		26	25	40	526	92.5						
2.5 T (142 kW)	1999.05-	2002.09	MT	R	F	Coupe Engine B5244S/B5254S	GC062040	Outer Joint	48T	36	25	56.5	48	58	M					
	1997.03-	2002.09			F	Coupe Engine B5244T/B5254T	GC062016	Outer Joint		26	28	56.5	97.5	66	O					
	1997.03-	2002.09	MT		F	Coupe Engine B5244T/B5254T	GC062009	Outer Joint	48T	36	27	56.5	48	66	M					



		YEAR	TRANSM	L/R	F/R		G-AP Ref.	PRODUCT	ABS	Technical Specifications						
										A	B	C	H	L	P	
<b>VOLVO</b>																
<b>C70 I</b>																
2.5 T (142 kW)	1997.03-	2002.09	MT/AT		F	Coupe Engine B5244T/B5254T	GC062002	Outer Joint	48T	26	28	56.5	97.5	66	O	
	1997.03-	2002.09	MT	R	F	Coupe Engine B5244T/B5254T	GDS62028	Drive Shaft	48T	36	26	56.5	48	990		
	1997.03-	2002.09	MT	R	F	Coupe Engine B5244T/B5254T	GC162030	Inner Joint		26	25	40	526	92.5		
	1997.03-	2002.09	MT	R	F	Coupe Engine B5244T/B5254T	GC062040	Outer Joint	48T	36	25	56.5	48	58	M	
	1998.03-	2005.10			F	Convertible Engine B5244T/B5254T	GC062016	Outer Joint		26	28	56.5	97.5	66	O	
	1998.03-	2005.10	MT		F	Convertible Engine B5244T/B5254T	GC062009	Outer Joint	48T	36	27	56.5	48	66	M	
	1998.03-	2005.10	MT/AT		F	Convertible Engine B5244T/B5254T	GC062002	Outer Joint	48T	26	28	56.5	97.5	66	O	
<b>C70 II</b>																
2.0 D (100 kW)	2008.01-		AT	L	F	Convertible Engine D4204T	GDS18367	Drive Shaft		36	28	56	48	570		
	2008.01-		MT	L	F	Convertible Engine D4204T	GDS18194	Drive Shaft		36	26	56	48	568		
2.4 (103 kW)	2006.03-		Semi-AT	L	F	Convertible Engine B5244S5	GDS62060	Drive Shaft		36	26	56	48	519		
	2006.03-		AT	R	F	Convertible Engine B5244S5	GDS18192	Drive Shaft		36	26	56	48	949		
	2006.03-		Semi-AT	R	F	Convertible Engine B5244S5	GDS62063	Drive Shaft		36	26	56	48	947		
2.4 D (120 kW)	2007.03-			L	F	Convertible Engine D5244T9	GDS62060	Drive Shaft		36	26	56	48	519		
	2007.03-		AT	R	F	Convertible Engine D5244T9	GDS18192	Drive Shaft		36	26	56	48	949		
	2007.03-			R	F	Convertible Engine D5244T9	GDS62063	Drive Shaft		36	26	56	48	947		
2.4 D5 (132 kW)	2006.06-	2007.04		L	F	Convertible Engine D5244T8/D5244T13	GDS62060	Drive Shaft		36	26	56	48	519		
	2006.06-	2007.04	AT	R	F	Convertible Engine D5244T8/D5244T13	GDS18192	Drive Shaft		36	26	56	48	949		
	2006.06-	2007.04		R	F	Convertible Engine D5244T8/D5244T13	GDS62063	Drive Shaft		36	26	56	48	947		
2.4 i (125 kW)	2006.03-			L	F	Convertible Engine B5244S4	GDS62060	Drive Shaft		36	26	56	48	519		
	2006.03-		AT	R	F	Convertible Engine B5244S4	GDS18192	Drive Shaft		36	26	56	48	949		
	2006.03-		Semi-AT	R	F	Convertible Engine B5244S4	GDS62063	Drive Shaft		36	26	56	48	947		
2.5 T5 (162 kW)	2006.03-		MT	L	F	Convertible Engine B5254T3	GDS62060	Drive Shaft		36	26	56	48	519		
	2006.03-		AT	R	F	Convertible Engine B5254T3	GDS18192	Drive Shaft		36	26	56	48	949		
	2006.03-		MT	R	F	Convertible Engine B5254T3	GDS62063	Drive Shaft		36	26	56	48	947		
2.5 T5 (169 kW)	2007.03-			L	F	Convertible Engine B5254T7	GDS62060	Drive Shaft		36	26	56	48	519		
	2007.03-		AT	R	F	Convertible Engine B5254T7	GDS18192	Drive Shaft		36	26	56	48	949		
	2007.03-		Semi-AT	R	F	Convertible Engine B5254T7	GDS62063	Drive Shaft		36	26	56	48	947		
<b>S40</b>																
1.6 (80 kW)	1999-	2003					GC062024	Outer Joint	43T	26	27	56.5	98	66.5	M	
<b>S40 I (VS)</b>																
1.6 (80 kW)	1999.03-	2003.12	MT		F	Saloon Engine B4164S2	GC039021	Outer Joint		25	29	54	94.5	64.5	O	
	1999.03-	2003.12	MT/AT		F	Saloon Engine B4164S2	GC062008	Outer Joint	43T	25	33	54	95	61	M	
	1999.03-	2003.12	MT	L	F	Saloon Engine B4164S2	GDS39097	Drive Shaft	43T	25	25	54	95.5	614		
	1999.03-	2003.12	MT	R	F	Saloon Engine B4164S2	GDS39096	Drive Shaft	43T	25	25	54	95.5	937		
	1999.03-	2003.12	MT	R	F	Saloon Engine B4164S2	GDS50421	Drive Shaft	43T	25	23	54	94.5	813		
	1999.03-	2003.12				Saloon Engine B4164S2	GC039100	Outer Joint	43T	25	23	54	95.5	64	M	
	1999.03-	2003.12				Saloon Engine B4164S2	GC099230	Outer Joint	43T	25	29	54	95	60	O	
	1999.03-	2003.12			F	Saloon Engine B4184S2/B4184S9	GC039021	Outer Joint		25	29	54	94.5	64.5	O	
1.8 (90 kW)	1999.03-	2003.12	MT/AT		F	Saloon Engine B4184S2/B4184S9	GC062008	Outer Joint	43T	25	33	54	95	61	M	
	1999.03-	2003.12	AT	L	F	Saloon Engine B4184S2/B4184S9	GDS62072	Drive Shaft	43T	25	26	54	95	599		
	1999.03-	2003.12	MT	L	F	Saloon Engine B4184S2/B4184S9	GDS39097	Drive Shaft	43T	25	25	54	95.5	614		
	1999.03-	2003.12	AT	R	F	Saloon Engine B4184S2/B4184S9	GDS62035	Drive Shaft	43T	25	26	54	95	948		
	1999.03-	2003.12	MT	R	F	Saloon Engine B4184S2/B4184S9	GDS39096	Drive Shaft	43T	25	25	54	95.5	937		
	1999.03-	2003.12	MT	R	F	Saloon Engine B4184S2/B4184S9	GDS50421	Drive Shaft	43T	25	23	54	94.5	813		
	1999.03-	2003.12	MT	R	F	Saloon Engine B4184S2/B4184S9	GDS62021	Drive Shaft	43T	25	26	54	95	945		
	1999.03-	2003.12	AT			Saloon Engine B4184S2/B4184S9	GC099262	Outer Joint	43T	25	25	54	95	61	O	
	1999.03-	2003.12	MT			Saloon Engine B4184S2/B4184S9	GC039100	Outer Joint	43T	25	23	54	95.5	64	M	
	1999.03-	2003.12				Saloon Engine B4184S2/B4184S9	GC099230	Outer Joint	43T	25	29	54	95	60	O	
	1.8 i (90 kW)	2001.06-	2003.12			F	Saloon Engine B4184SJ	GC039021	Outer Joint		25	29	54	94.5	64.5	O
		2001.06-	2003.12	MT/AT		F	Saloon Engine B4184SJ	GC062011	Outer Joint	43T	25	33	56.3	99	61.5	M
2001.06-		2003.12	AT	L	F	Saloon Engine B4184SJ	GDS62072	Drive Shaft	43T	25	26	54	95	599		
2001.06-		2003.12	MT	L	F	Saloon Engine B4184SJ	GDS39097	Drive Shaft	43T	25	25	54	95.5	614		
2001.06-		2003.12	AT	R	F	Saloon Engine B4184SJ	GDS62035	Drive Shaft	43T	25	26	54	95	948		
2001.06-		2003.12	MT	R	F	Saloon Engine B4184SJ	GDS39096	Drive Shaft	43T	25	25	54	95.5	937		
2001.06-		2003.12	MT	R	F	Saloon Engine B4184SJ	GDS50421	Drive Shaft	43T	25	23	54	94.5	813		
2001.06-		2003.12	MT	R	F	Saloon Engine B4184SJ	GDS62021	Drive Shaft	43T	25	26	54	95	945		
2001.06-		2003.12	AT			Saloon Engine B4184SJ	GC099262	Outer Joint	43T	25	25	54	95	61	O	
2001.06-		2003.12	MT			Saloon Engine B4184SJ	GC039100	Outer Joint	43T	25	23	54	95.5	64	M	
2001.06-	2003.12				Saloon Engine B4184SJ	GC099230	Outer Joint	43T	25	29	54	95	60	O		
1.8 i (92 kW)	1998.03-	2003.12			F	Saloon Engine B4184SM	GC039021	Outer Joint		25	29	54	94.5	64.5	O	





		YEAR	TRANSM	L/R	F/R		G-AP Ref.	PRODUCT	ABS	Technical Specifications						
										A	B	C	H	L	P	
<b>VOLVO</b>																
<b>S40 I (VS)</b>																
1.8 i (92 kW)	1998.03-	2003.12	MT/AT		F	Saloon Engine B4184SM	GC062008	Outer Joint	43T	25	33	54	95	61	M	
	1998.03-	2003.12	AT	L	F	Saloon Engine B4184SM	GDS62072	Drive Shaft	43T	25	26	54	95	599		
	1998.03-	2003.12	AT	R	F	Saloon Engine B4184SM	GDS62035	Drive Shaft	43T	25	26	54	95	948		
	1998.03-	2003.12	AT			Saloon Engine B4184SM	GC099262	Outer Joint	43T	25	25	54	95	61	O	
	1998.03-	2003.12	MT			Saloon Engine B4184SM	GC039100	Outer Joint	43T	25	23	54	95.5	64	M	
1.9 Di (75 kW)	2000.07-	2003.12			F	Saloon Engine D4192T4	GC039021	Outer Joint		25	29	54	94.5	64.5	O	
	2000.07-	2003.12	MT/AT		F	Saloon Engine D4192T4	GC062012	Outer Joint	43T	26	27	56.5	98	66.5	M	
	2000.07-	2003.12	MT	L	F	Saloon Engine D4192T4	GDS62064	Drive Shaft	43T	26	26	56.5	98	607		
1.9 Di (85 kW)	2000.07-	2003.12	MT/AT		F	Saloon Engine D4192T3	GC062012	Outer Joint	43T	26	27	56.5	98	66.5	M	
	2000.07-	2003.12	MT	L	F	Saloon Engine D4192T3	GDS62064	Drive Shaft	43T	26	26	56.5	98	607		
2.0 (100 kW)	1995.07-	2003.12			F	Saloon Engine B4204S/B4204S2	GC039021	Outer Joint		25	29	54	94.5	64.5	O	
	1995.07-	2003.12	MT/AT		F	Saloon Engine B4204S/B4204S2	GC062003	Outer Joint	43T	25	25	54	95	61	O	
	1995.07-	2003.12	AT	L	F	Saloon Engine B4204S/B4204S2	GDS62072	Drive Shaft	43T	25	26	54	95	599		
	1995.07-	2003.12	MT	L	F	Saloon Engine B4204S/B4204S2	GDS62023	Drive Shaft	43T	25	29.95	54	95	628.7		
	1995.07-	2003.12	AT	R	F	Saloon Engine B4204S/B4204S2	GDS62035	Drive Shaft	43T	25	26	54	95	948		
	1995.07-	2003.12	MT	R	F	Saloon Engine B4204S/B4204S2	GDS50421	Drive Shaft	43T	25	23	54	94.5	813		
2.0 T (118 kW)	1995.07-	2003.12				Saloon Engine B4204S/B4204S2	GC099262	Outer Joint	43T	25	25	54	95	61	O	
	1997.10-	2003.12	MT/AT		F	Saloon Engine B4204T	GC062012	Outer Joint	43T	26	27	56.5	98	66.5	M	
2.0 T4 (147 kW)	2000.07-	2003.12	MT/AT		F	Saloon Engine B4204T5	GC062012	Outer Joint	43T	26	27	56.5	98	66.5	M	
<b>S40 II (MS)</b>																
1.6 (74 kW)	2004.11-	2007.04	MT	L	F	Saloon Engine B4164S3	GDS18189	Drive Shaft		36	23	56	48	601		
	2004.11-	2007.04	MT	L	F	Saloon Engine B4164S3	GCI18168	Inner Joint		23	22	40	61	90		
	2004.11-	2007.04	MT	L	F	Saloon Engine B4164S3	GC018264	Outer Joint		36	25	51.6	48	58	O	
	2004.11-	2007.04	MT	R	F	Saloon Engine B4164S3	GDS18206	Drive Shaft		36	23	56	48	906		
	2004.11-	2007.04		R	F	Saloon Engine B4164S3	GDS18337	Drive Shaft		36	23	51.6	48	908		
1.6 D (81 kW)	2004.11-	2007.04		R	F	Saloon Engine D4164T	GDS18219	Drive Shaft		36	26	56.3	48	921		
1.6 D2 (84 kW)	2010.10-			R	F	Saloon Engine D4162T	GDS62053	Drive Shaft		36	26	56.3	48	917		
1.8 (92 kW)	2004.01-	2008.02	5MT	L	F	Saloon Engine B4184S11	GDS18328	Drive Shaft		36	26	55.3	48	580		
	2004.01-	2008.02	5MT	R	F	Saloon Engine B4184S11	GDS18329	Drive Shaft		36	26	55.3	48	920		
1.8 FlexFuel (92 kW)	2006.01-		5MT	L	F	Saloon Engine B4184S8	GDS18328	Drive Shaft		36	26	55.3	48	580		
	2006.01-		5MT	R	F	Saloon Engine B4184S8	GDS18329	Drive Shaft		36	26	55.3	48	920		
2.0 (107 kW)	2004.06-	2007.06	5MT	L	F	Saloon Engine B4204S3	GDS18328	Drive Shaft		36	26	55.3	48	580		
	2004.06-	2007.06	5MT	R	F	Saloon Engine B4204S3	GDS18329	Drive Shaft		36	26	55.3	48	920		
2.0 D (100 kW)	2004.01-	2007.06	AT	L	F	Saloon Engine D4204T	GDS18367	Drive Shaft		36	28	56	48	570		
	2004.01-	2007.06	MT	L	F	Saloon Engine D4204T	GDS18194	Drive Shaft		36	26	56	48	568		
	2004.01-	2007.06	MT	R	F	Saloon Engine D4204T	GDS18280	Drive Shaft		36	26	56	48	918		
2.4 (103 kW)	2004.01-		Semi-AT	L	F	Saloon Engine B5244S5	GDS62060	Drive Shaft		36	26	56	48	519		
	2004.01-		AT	R	F	Saloon Engine B5244S5	GDS18192	Drive Shaft		36	26	56	48	949		
	2004.01-		Semi-AT	R	F	Saloon Engine B5244S5	GDS62063	Drive Shaft		36	26	56	48	947		
2.4 (125 kW)	2004.01-	2007.04	Semi-AT	L	F	Saloon Engine B5244S	GDS62060	Drive Shaft		36	26	56	48	519		
	2004.01-	2007.04	AT	R	F	Saloon Engine B5244S	GDS18192	Drive Shaft		36	26	56	48	949		
	2004.01-	2007.04	Semi-AT	R	F	Saloon Engine B5244S	GDS62063	Drive Shaft		36	26	56	48	947		
2.4 D5 (132 kW)	2006.04-	2007.06		L	F	Saloon Engine D5244T8	GDS62060	Drive Shaft		36	26	56	48	519		
	2006.04-	2007.06	AT	R	F	Saloon Engine D5244T8	GDS18192	Drive Shaft		36	26	56	48	949		
	2006.04-	2007.06		R	F	Saloon Engine D5244T8	GDS62063	Drive Shaft		36	26	56	48	947		
2.5 T5 (162 kW)	2004.01-	2007.04	Semi-AT	L	F	Saloon Engine B5254T3	GDS62060	Drive Shaft		36	26	56	48	519		
	2004.01-	2007.04	AT	R	F	Saloon Engine B5254T3	GDS18192	Drive Shaft		36	26	56	48	949		
	2004.01-	2007.04	Semi-AT	R	F	Saloon Engine B5254T3	GDS62063	Drive Shaft		36	26	56	48	947		
2.5 T5 (169 kW)	2007.05-	2008.02	AT	L	F	Saloon Engine B5254T7	GDS62060	Drive Shaft		36	26	56	48	519		
	2007.05-	2008.02	AT	R	F	Saloon Engine B5254T7	GDS62063	Drive Shaft		36	26	56	48	947		
2.5 T5 AWD (162 kW)	2004.04-			L	F	Saloon Engine B5254T3	GDS62060	Drive Shaft		36	26	56	48	519		
	2004.04-			R	F	Saloon Engine B5254T3	GDS62063	Drive Shaft		36	26	56	48	947		
<b>S40I / V40 (VS, VW), SW</b>																
1.9 Di (85 kW)	2000.07-	2003.12					GC062024	Outer Joint	43T	26	27	56.5	98	66.5	M	
2.0 T (120 kW)	2000-	2003					GC062024	Outer Joint	43T	26	27	56.5	98	66.5	M	
2.0 T (121 kW)	2000-	2003					GC062024	Outer Joint	43T	26	27	56.5	98	66.5	M	
<b>S60</b>																
2.0 T (132 kW)	2001.09-	2010.04	MT/AT		F	Saloon Engine B5204T5	GC062010	Outer Joint	48T	36	33	56.5	48	58	M	
	2001.09-	2010.04	AT	L	F	Saloon Engine B5204T5	GDS62022	Drive Shaft	48T	36	26	56.5	48	527		
	2001.09-	2010.04	AT	L	F	Saloon Engine B5204T5	GCI99109	Inner Joint		26	26	31	50	105		





		TRANSM	L/R	F/R		G-AP Ref.	PRODUCT	ABS	Technical Specifications								
									YEAR	A	B	C	H	L	P		
<b>VOLVO</b>																	
<b>S60</b>																	
2.0 T (132 kW)	2001.09-	2010.04	AT	L	F	Saloon Engine B5204T5	GC062019	Outer Joint		36	27	56.5	48	66	M		
	2001.09-	2010.04	MT	L	F	Saloon Engine B5204T5	GDS62029	Drive Shaft	48T	36	26	56.5	48	540			
	2001.09-	2010.04	MT	L	F	Saloon Engine B5204T5	GCI62028	Inner Joint		26	25	40	67.5	94			
	2001.09-	2010.04	MT	L	F	Saloon Engine B5204T5	GC062038	Outer Joint		36	25	56.5	48	58	M		
	2001.09-	2010.04	MT	R	F	Saloon Engine B5204T5	GDS62028	Drive Shaft	48T	36	26	56.5	48	990			
	2001.09-	2010.04	MT	R	F	Saloon Engine B5204T5	GCI62029	Inner Joint		26	26	31	513	93.5			
	2001.09-	2010.04	MT	R	F	Saloon Engine B5204T5	GCI62030	Inner Joint		26	25	40	526	92.5			
	2001.09-	2010.04	MT	R	F	Saloon Engine B5204T5	GC062009	Outer Joint	48T	36	27	56.5	48	66	M		
	2001.09-	2010.04	MT	R	F	Saloon Engine B5204T5	GC062040	Outer Joint	48T	36	25	56.5	48	58	M		
2.3 T5 (184 kW)	2000.11-	2010.04	MT/AT		F	Saloon Engine B5234T3	GC062009	Outer Joint	48T	36	27	56.5	48	66	M		
	2000.11-	2010.04	AT	L	F	Saloon Engine B5234T3	GDS62022	Drive Shaft	48T	36	26	56.5	48	527			
	2000.11-	2010.04	AT	L	F	Saloon Engine B5234T3	GCI99109	Inner Joint		26	26	31	50	105			
	2000.11-	2010.04	AT	L	F	Saloon Engine B5234T3	GC062019	Outer Joint		36	27	56.5	48	66	M		
	2000.11-	2010.04	MT	L	F	Saloon Engine B5234T3	GDS62029	Drive Shaft	48T	36	26	56.5	48	540			
	2000.11-	2010.04	MT	L	F	Saloon Engine B5234T3	GCI62028	Inner Joint		26	25	40	67.5	94			
	2000.11-	2010.04	MT	L	F	Saloon Engine B5234T3	GC062038	Outer Joint		36	25	56.5	48	58	M		
	2000.11-	2010.04	AT	R	F	Saloon Engine B5234T3	GDS62017	Drive Shaft	48T	36	26	56.5	48	978.5			
	2000.11-	2010.04	AT	R	F	Saloon Engine B5234T3	GCI62029	Inner Joint		26	26	31	513	93.5			
	2000.11-	2010.04	AT	R	F	Saloon Engine B5234T3	GC062009	Outer Joint	48T	36	27	56.5	48	66	M		
	2000.11-	2010.04	MT	R	F	Saloon Engine B5234T3	GDS62028	Drive Shaft	48T	36	26	56.5	48	990			
	2000.11-	2010.04	MT	R	F	Saloon Engine B5234T3	GCI62030	Inner Joint		26	25	40	526	92.5			
	2000.11-	2010.04	MT	R	F	Saloon Engine B5234T3	GC062040	Outer Joint	48T	36	25	56.5	48	58	M		
2.4 (103 kW)	2000.11-	2010.04	MT/AT		F	Saloon Engine B5244S2	GC062010	Outer Joint	48T	36	33	56.5	48	58	M		
	2000.11-	2010.04	MT	L	F	Saloon Engine B5244S2	GDS62029	Drive Shaft	48T	36	26	56.5	48	540			
	2000.11-	2010.04	MT	L	F	Saloon Engine B5244S2	GCI62028	Inner Joint		26	25	40	67.5	94			
	2000.11-	2010.04	MT	L	F	Saloon Engine B5244S2	GC062038	Outer Joint		36	25	56.5	48	58	M		
	2000.11-	2010.04	AT	R	F	Saloon Engine B5244S2	GDS62017	Drive Shaft	48T	36	26	56.5	48	978.5			
	2000.11-	2010.04	AT	R	F	Saloon Engine B5244S2	GCI62029	Inner Joint		26	26	31	513	93.5			
	2000.11-	2010.04	AT	R	F	Saloon Engine B5244S2	GC062009	Outer Joint	48T	36	27	56.5	48	66	M		
	2000.11-	2010.04	MT	R	F	Saloon Engine B5244S2	GDS62028	Drive Shaft	48T	36	26	56.5	48	990			
	2000.11-	2010.04	MT	R	F	Saloon Engine B5244S2	GCI62030	Inner Joint		26	25	40	526	92.5			
2.4 (125 kW)	2000.11-	2010.04	MT/AT		F	Saloon Engine B5244S	GC062010	Outer Joint	48T	36	33	56.5	48	58	M		
	2000.11-	2010.04	MT	L	F	Saloon Engine B5244S	GDS62029	Drive Shaft	48T	36	26	56.5	48	540			
	2000.11-	2010.04	MT	L	F	Saloon Engine B5244S	GCI62028	Inner Joint		26	25	40	67.5	94			
	2000.11-	2010.04	MT	L	F	Saloon Engine B5244S	GC062038	Outer Joint		36	25	56.5	48	58	M		
	2000.11-	2010.04	AT	R	F	Saloon Engine B5244S	GDS62017	Drive Shaft	48T	36	26	56.5	48	978.5			
	2000.11-	2010.04	AT	R	F	Saloon Engine B5244S	GCI62029	Inner Joint		26	26	31	513	93.5			
	2000.11-	2010.04	AT	R	F	Saloon Engine B5244S	GC062009	Outer Joint	48T	36	27	56.5	48	66	M		
	2000.11-	2010.04	MT	R	F	Saloon Engine B5244S	GDS62028	Drive Shaft	48T	36	26	56.5	48	990			
	2000.11-	2010.04	MT	R	F	Saloon Engine B5244S	GCI62030	Inner Joint		26	25	40	526	92.5			
2.4 Bifuel (103 kW)	2002.06-	2010.04	MT	L	F	Saloon Engine B5244SG2	GDS62029	Drive Shaft	48T	36	26	56.5	48	540			
	2002.06-	2010.04	MT	L	F	Saloon Engine B5244SG2	GCI62028	Inner Joint		26	25	40	67.5	94			
	2002.06-	2010.04	MT	L	F	Saloon Engine B5244SG2	GC062038	Outer Joint		36	25	56.5	48	58	M		
	2002.06-	2010.04	AT	R	F	Saloon Engine B5244SG2	GDS62017	Drive Shaft	48T	36	26	56.5	48	978.5			
	2002.06-	2010.04	AT	R	F	Saloon Engine B5244SG2	GCI62029	Inner Joint		26	26	31	513	93.5			
	2002.06-	2010.04	AT	R	F	Saloon Engine B5244SG2	GC062009	Outer Joint	48T	36	27	56.5	48	66	M		
	2002.06-	2010.04	MT	R	F	Saloon Engine B5244SG2	GDS62028	Drive Shaft	48T	36	26	56.5	48	990			
	2002.06-	2010.04	MT	R	F	Saloon Engine B5244SG2	GCI62030	Inner Joint		26	25	40	526	92.5			
	2002.06-	2010.04	MT	R	F	Saloon Engine B5244SG2	GC062040	Outer Joint	48T	36	25	56.5	48	58	M		
	2002.06-	2010.04	MT/AT		F	Saloon Engine B5244SG	GC062010	Outer Joint	48T	36	33	56.5	48	58	M		
	2002.06-	2010.04	MT	L	F	Saloon Engine B5244SG	GDS62029	Drive Shaft	48T	36	26	56.5	48	540			
	2002.06-	2010.04	MT	L	F	Saloon Engine B5244SG	GCI62028	Inner Joint		26	25	40	67.5	94			
	2002.06-	2010.04	MT	L	F	Saloon Engine B5244SG	GC062038	Outer Joint		36	25	56.5	48	58	M		
	2002.06-	2010.04	AT	R	F	Saloon Engine B5244SG	GDS62017	Drive Shaft	48T	36	26	56.5	48	978.5			
	2002.06-	2010.04	AT	R	F	Saloon Engine B5244SG	GCI62029	Inner Joint		26	26	31	513	93.5			
	2002.06-	2010.04	AT	R	F	Saloon Engine B5244SG	GC062009	Outer Joint	48T	36	27	56.5	48	66	M		
	2002.06-	2010.04	MT	R	F	Saloon Engine B5244SG	GDS62028	Drive Shaft	48T	36	26	56.5	48	990			
2002.06-	2010.04	MT	R	F	Saloon Engine B5244SG	GCI62030	Inner Joint		26	25	40	526	92.5				
	2002.06-	2010.04	MT	R	F	Saloon Engine B5244SG	GC062040	Outer Joint	48T	36	25	56.5	48	58	M		



		YEAR	TRANSM	L/R	F/R		G-AP Ref.	PRODUCT	ABS	Technical Specifications									
										A	B	C	H	L	P				
<b>VOLVO</b>																			
<b>S60</b>																			
2.4 D (120 kW)	2005.09-	2009.01	MT	L	F	Saloon Engine D5244T5	GDS62029	Drive Shaft	48T	36	26	56.5	48	540					
	2005.09-	2009.01	MT	L	F	Saloon Engine D5244T5	GCI62028	Inner Joint		26	25	40	67.5	94					
	2005.09-	2009.01	MT	L	F	Saloon Engine D5244T5	GC062038	Outer Joint		36	25	56.5	48	58	M				
	2005.09-	2009.01	5AT	R	F	Saloon Engine D5244T5	GDS62017	Drive Shaft	48T	36	26	56.5	48	978.5					
	2005.09-	2009.01	5AT	R	F	Saloon Engine D5244T5	GCI62029	Inner Joint		26	26	31	513	93.5					
	2005.09-	2009.01	5AT	R	F	Saloon Engine D5244T5	GC062009	Outer Joint	48T	36	27	56.5	48	66	M				
	2005.09-	2009.01	MT	R	F	Saloon Engine D5244T5	GDS62028	Drive Shaft	48T	36	26	56.5	48	990					
	2005.09-	2009.01	MT	R	F	Saloon Engine D5244T5	GCI62030	Inner Joint		26	25	40	526	92.5					
	2005.09-	2009.01	MT	R	F	Saloon Engine D5244T5	GC062040	Outer Joint	48T	36	25	56.5	48	58	M				
	2005.09-	2009.01	6MT/6AT			Saloon Engine D5244T5	GC062037	Outer Joint	48T	36	27	56.5	48	66	M				
2.4 D (93 kW)	2005.09-	2010.04		R	F	Saloon Engine D5244T7	GDS62031	Drive Shaft	48T	36	26	56.5	48	992					
2.4 D (96 kW)	2001.12-	2010.04	MT/AT		F	Saloon Engine D5244T2	GC062009	Outer Joint	48T	36	27	56.5	48	66	M				
	2001.12-	2010.04	AT	L	F	Saloon Engine D5244T2	GDS62022	Drive Shaft	48T	36	26	56.5	48	527					
	2001.12-	2010.04	AT	L	F	Saloon Engine D5244T2	GCI99109	Inner Joint		26	26	31	50	105					
	2001.12-	2010.04	AT	L	F	Saloon Engine D5244T2	GC062019	Outer Joint		36	27	56.5	48	66	M				
	2001.12-	2010.04	MT	R	F	Saloon Engine D5244T2	GDS62031	Drive Shaft	48T	36	26	56.5	48	992					
2.4 D5 (120 kW)	2001.07-	2010.04	MT/AT		F	Saloon Engine D5244T	GC062009	Outer Joint	48T	36	27	56.5	48	66	M				
	2001.07-	2010.04	AT	L	F	Saloon Engine D5244T	GDS62022	Drive Shaft	48T	36	26	56.5	48	527					
	2001.07-	2010.04	AT	L	F	Saloon Engine D5244T	GCI99109	Inner Joint		26	26	31	50	105					
	2001.07-	2010.04	AT	L	F	Saloon Engine D5244T	GC062019	Outer Joint		36	27	56.5	48	66	M				
	2001.07-	2010.04	MT	L	F	Saloon Engine D5244T	GDS62029	Drive Shaft	48T	36	26	56.5	48	540					
	2001.07-	2010.04	MT	L	F	Saloon Engine D5244T	GCI62028	Inner Joint		26	25	40	67.5	94					
	2001.07-	2010.04	MT	L	F	Saloon Engine D5244T	GC062038	Outer Joint		36	25	56.5	48	58	M				
	2001.07-	2010.04	AT	R	F	Saloon Engine D5244T	GDS62017	Drive Shaft	48T	36	26	56.5	48	978.5					
	2001.07-	2010.04	AT	R	F	Saloon Engine D5244T	GCI62029	Inner Joint		26	26	31	513	93.5					
	2001.07-	2010.04	AT	R	F	Saloon Engine D5244T	GC062009	Outer Joint	48T	36	27	56.5	48	66	M				
	2001.07-	2010.04	MT	R	F	Saloon Engine D5244T	GDS62028	Drive Shaft	48T	36	26	56.5	48	990					
	2001.07-	2010.04	MT	R	F	Saloon Engine D5244T	GCI62030	Inner Joint		26	25	40	526	92.5					
	2001.07-	2010.04	MT	R	F	Saloon Engine D5244T	GC062040	Outer Joint	48T	36	25	56.5	48	58	M				
	2001.07-	2010.04	6MT/6AT			Saloon Engine D5244T	GC062037	Outer Joint	48T	36	27	56.5	48	66	M				
2.4 D5 (136 kW)	2005.05-	2007.11	MT	L	F	Saloon Engine D5244T4	GDS62029	Drive Shaft	48T	36	26	56.5	48	540					
	2005.05-	2007.11	MT	L	F	Saloon Engine D5244T4	GCI62028	Inner Joint		26	25	40	67.5	94					
	2005.05-	2007.11	MT	L	F	Saloon Engine D5244T4	GC062038	Outer Joint		36	25	56.5	48	58	M				
	2005.05-	2007.11	MT	R	F	Saloon Engine D5244T4	GDS62028	Drive Shaft	48T	36	26	56.5	48	990					
	2005.05-	2007.11	MT	R	F	Saloon Engine D5244T4	GCI62030	Inner Joint		26	25	40	526	92.5					
	2005.05-	2007.11	MT	R	F	Saloon Engine D5244T4	GC062040	Outer Joint	48T	36	25	56.5	48	58	M				
	2005.05-	2007.11	6MT/6AT			Saloon Engine D5244T4	GC062037	Outer Joint	48T	36	27	56.5	48	66	M				
2.4 T (147 kW)	2000.11-	2010.04	MT/AT		F	Saloon Engine B5244T3	GC062009	Outer Joint	48T	36	27	56.5	48	66	M				
	2000.11-	2010.04	AT	L	F	Saloon Engine B5244T3	GDS62022	Drive Shaft	48T	36	26	56.5	48	527					
	2000.11-	2010.04	AT	L	F	Saloon Engine B5244T3	GCI99109	Inner Joint		26	26	31	50	105					
	2000.11-	2010.04	AT	L	F	Saloon Engine B5244T3	GC062019	Outer Joint		36	27	56.5	48	66	M				
	2000.11-	2010.04	MT	L	F	Saloon Engine B5244T3	GDS62029	Drive Shaft	48T	36	26	56.5	48	540					
	2000.11-	2010.04	MT	L	F	Saloon Engine B5244T3	GCI62028	Inner Joint		26	25	40	67.5	94					
	2000.11-	2010.04	MT	L	F	Saloon Engine B5244T3	GC062038	Outer Joint		36	25	56.5	48	58	M				
	2000.11-	2010.04	AT	R	F	Saloon Engine B5244T3	GDS62017	Drive Shaft	48T	36	26	56.5	48	978.5					
	2000.11-	2010.04	AT	R	F	Saloon Engine B5244T3	GCI62029	Inner Joint		26	26	31	513	93.5					
	2000.11-	2010.04	AT	R	F	Saloon Engine B5244T3	GC062009	Outer Joint	48T	36	27	56.5	48	66	M				
	2000.11-	2010.04	MT	R	F	Saloon Engine B5244T3	GDS62028	Drive Shaft	48T	36	26	56.5	48	990					
	2000.11-	2010.04	MT	R	F	Saloon Engine B5244T3	GCI62030	Inner Joint		26	25	40	526	92.5					
	2000.11-	2010.04	MT	R	F	Saloon Engine B5244T3	GC062040	Outer Joint	48T	36	25	56.5	48	58	M				
2.4 T AWD (147 kW)	2001.11-	2010.04	MT/AT		F	Saloon Engine B5244T3	GC062009	Outer Joint	48T	36	27	56.5	48	66	M				
	2001.11-	2010.04	AT	L	F	Saloon Engine B5244T3	GDS62022	Drive Shaft	48T	36	26	56.5	48	527					
	2001.11-	2010.04	AT	L	F	Saloon Engine B5244T3	GCI99109	Inner Joint		26	26	31	50	105					
	2001.11-	2010.04	AT	L	F	Saloon Engine B5244T3	GC062019	Outer Joint		36	27	56.5	48	66	M				
	2001.11-	2010.04	MT	R	F	Saloon Engine B5244T3	GDS62031	Drive Shaft	48T	36	26	56.5	48	992					
2.4 T5 (191 kW)	2004.05-	2007.11	MT/AT		F	Saloon Engine B5244T5	GC062009	Outer Joint	48T	36	27	56.5	48	66	M				
	2004.05-	2007.11	AT	L	F	Saloon Engine B5244T5	GDS62022	Drive Shaft	48T	36	26	56.5	48	527					
	2004.05-	2007.11	AT	L	F	Saloon Engine B5244T5	GCI99109	Inner Joint		26	26	31	50	105					
	2004.05-	2007.11	AT	L	F	Saloon Engine B5244T5	GC062019	Outer Joint		36	27	56.5	48	66	M				
	2004.05-	2007.11	MT	L	F	Saloon Engine B5244T5	GDS62029	Drive Shaft	48T	36	26	56.5	48	540					
	2004.05-	2007.11	MT	L	F	Saloon Engine B5244T5	GCI62028	Inner Joint		26	25	40	67.5	94					





		TRANSM	L/R	F/R		G-AP Ref.	PRODUCT	ABS	Technical Specifications					
									YEAR	A	B	C	H	L
<b>VOLVO</b>														
<b>S60</b>														
2.4 T5 (191 kW)	2004.05-2007.11	MT	L	F	Saloon Engine B5244T5	GC062038	Outer Joint		36	25	56.5	48	58	M
	2004.05-2007.11	AT	R	F	Saloon Engine B5244T5	GDS62017	Drive Shaft	48T	36	26	56.5	48	978.5	
	2004.05-2007.11	AT	R	F	Saloon Engine B5244T5	GC162029	Inner Joint		26	26	31	513	93.5	
	2004.05-2007.11	AT	R	F	Saloon Engine B5244T5	GC062009	Outer Joint	48T	36	27	56.5	48	66	M
	2004.05-2007.11	MT	R	F	Saloon Engine B5244T5	GDS62028	Drive Shaft	48T	36	26	56.5	48	990	
	2004.05-2007.11	MT	R	F	Saloon Engine B5244T5	GCI62030	Inner Joint		26	25	40	526	92.5	
	2004.05-2007.11	MT	R	F	Saloon Engine B5244T5	GC062040	Outer Joint	48T	36	25	56.5	48	58	M
2.5 AWD (224 kW)	2003.09-2010.04	MT	L	F	Saloon Engine B5254T4	GDS62029	Drive Shaft	48T	36	26	56.5	48	540	
	2003.09-2010.04	MT	L	F	Saloon Engine B5254T4	GCI62028	Inner Joint		26	25	40	67.5	94	
	2003.09-2010.04	MT	L	F	Saloon Engine B5254T4	GC062038	Outer Joint		36	25	56.5	48	58	M
2.5 T (154 kW)	2003.03-2007.11	AT	R	F	Saloon Engine B5254T2	GDS62017	Drive Shaft	48T	36	26	56.5	48	978.5	
	2003.03-2007.11	AT	R	F	Saloon Engine B5254T2	GC162029	Inner Joint		26	26	31	513	93.5	
	2003.03-2007.11	AT	R	F	Saloon Engine B5254T2	GC062009	Outer Joint	48T	36	27	56.5	48	66	M
	2003.03-2007.11	MT	R	F	Saloon Engine B5254T2	GDS62028	Drive Shaft	48T	36	26	56.5	48	990	
	2003.03-2007.11	MT	R	F	Saloon Engine B5254T2	GCI62030	Inner Joint		26	25	40	526	92.5	
	2003.03-2007.11	MT	R	F	Saloon Engine B5254T2	GC062040	Outer Joint	48T	36	25	56.5	48	58	M
	2003.03-2007.11	MT/AT		F	Saloon Engine B5254T2	GC062009	Outer Joint	48T	36	27	56.5	48	66	M
	2003.03-2007.11	MT	L	F	Saloon Engine B5254T2	GDS62029	Drive Shaft	48T	36	26	56.5	48	540	
	2003.03-2007.11	MT	L	F	Saloon Engine B5254T2	GCI62028	Inner Joint		26	25	40	67.5	94	
2.5 T AWD (154 kW)	2004.04-2010.04	MT/AT		F	Saloon Engine B5254T2	GC062009	Outer Joint	48T	36	27	56.5	48	66	M
	2004.04-2010.04	MT/AT	L	F	Saloon Engine B5254T2	GDS62022	Drive Shaft	48T	36	26	56.5	48	527	
	2004.04-2010.04	MT/AT	L	F	Saloon Engine B5254T2	GCI99109	Inner Joint		26	26	31	50	105	
	2004.04-2010.04	MT/AT	L	F	Saloon Engine B5254T2	GC062019	Outer Joint		36	27	56.5	48	66	M
R 2,5 T AWD (221 kW)	2003.03-2010.04	MT/AT		F	Saloon Engine B5254T4	GC062009	Outer Joint	48T	36	27	56.5	48	66	M
	2003.03-2010.04	MT	L	F	Saloon Engine B5254T4	GDS62029	Drive Shaft	48T	36	26	56.5	48	540	
	2003.03-2010.04	MT	L	F	Saloon Engine B5254T4	GCI62028	Inner Joint		26	25	40	67.5	94	
	2003.03-2010.04	MT	L	F	Saloon Engine B5254T4	GC062038	Outer Joint		36	25	56.5	48	58	M
<b>S60 II</b>														
2.0 D3 (120 kW)	2010.04-2012.04	AT	L	F	Saloon Engine D5204T2/D5204T3	GDS59443	Drive Shaft		40	31	57.4	52	528	
	2010.04-2012.04	AT	R	F	Saloon Engine D5204T2/D5204T3	GDS59444	Drive Shaft		40	28	57.4	52	994	
2.0 D4 (120 kW)	2012.05-	AT	L	F	Saloon Engine D5204T3	GDS59443	Drive Shaft		40	31	57.4	52	528	
	2012.05-	AT	R	F	Saloon Engine D5204T3	GDS59444	Drive Shaft		40	28	57.4	52	994	
2.4 D5 (151 kW)	2010.04-	AT			Saloon Engine D5244T10	GC059344	Outer Joint		40	26	57.4	52	63.5	M
2.4 D5 (158 kW)	2011.06-	AT			Saloon Engine D5244T11/D5244T15	GC059344	Outer Joint		40	26	57.4	52	63.5	M
2.4 D5 AWD (151 kW)	2010.04-	AT	L	F	Saloon Engine D5244T10	GDS59443	Drive Shaft		40	31	57.4	52	528	
	2010.04-	AT			Saloon Engine D5244T10	GC059344	Outer Joint		40	26	57.4	52	63.5	M
2.4 D5 AWD (158 kW)	2011.06-	AT	L	F	Saloon Engine D5244T11/D5244T15	GDS59443	Drive Shaft		40	31	57.4	52	528	
	2011.06-	AT			Saloon Engine D5244T11/D5244T15	GC059344	Outer Joint		40	26	57.4	52	63.5	M
3.0 T6 AWD (224 kW)	2010.04-				Saloon Engine B6304T4	GC059285	Outer Joint		40	27	57.4	52	63.5	M
<b>S80 I (TS, XY)</b>														
2.0 (120 kW)	1998.06-2006.07			F	Saloon Engine B5204T4	GC062001	Outer Joint	48T	26	25	56.5	98.5	56	O
	1998.06-2006.07	MT/AT		F	Saloon Engine B5204T4	GC062010	Outer Joint	48T	36	33	56.5	48	58	M
2.0 T (132 kW)	1999.12-2006.07	MT/AT		F	Saloon Engine B5204T5	GC062010	Outer Joint	48T	36	33	56.5	48	58	M
	1999.12-2006.07	MT	L	F	Saloon Engine B5204T5	GDS62029	Drive Shaft	48T	36	26	56.5	48	540	
	1999.12-2006.07	MT	L	F	Saloon Engine B5204T5	GCI62028	Inner Joint		26	25	40	67.5	94	
	1999.12-2006.07	MT	L	F	Saloon Engine B5204T5	GC062038	Outer Joint		36	25	56.5	48	58	M
	1999.12-2006.07	AT	R	F	Saloon Engine B5204T5	GDS62017	Drive Shaft	48T	36	26	56.5	48	978.5	
	1999.12-2006.07	AT	R	F	Saloon Engine B5204T5	GC162029	Inner Joint		26	26	31	513	93.5	
	1999.12-2006.07	AT	R	F	Saloon Engine B5204T5	GC062009	Outer Joint	48T	36	27	56.5	48	66	M
	1999.12-2006.07	MT	R	F	Saloon Engine B5204T5	GDS62028	Drive Shaft	48T	36	26	56.5	48	990	
	1999.12-2006.07	MT	R	F	Saloon Engine B5204T5	GCI62030	Inner Joint		26	25	40	526	92.5	
	1999.12-2006.07	MT	R	F	Saloon Engine B5204T5	GC062040	Outer Joint	48T	36	25	56.5	48	58	M
	1999.12-2006.07	MT/AT		F	Saloon Engine B5204T3	GC062009	Outer Joint	48T	36	27	56.5	48	66	M
2.0 T (166 kW)	1998.06-2006.07	MT/AT		F	Saloon Engine B5204T3	GC062009	Outer Joint	48T	36	27	56.5	48	66	M
2.4 (103 kW)	1999.01-2006.07	MT/AT		F	Saloon Engine B5244S2	GC062010	Outer Joint	48T	36	33	56.5	48	58	M
2.4 (125 kW)	1999.01-2006.07	MT/AT		F	Saloon Engine B5244S	GC062010	Outer Joint	48T	36	33	56.5	48	58	M
2.4 Bifuel (103 kW)	2001.09-2006.07	MT/AT		F	Saloon Engine B5244SG2	GC062010	Outer Joint	48T	36	33	56.5	48	58	M
	2001.09-2006.07	MT	L	F	Saloon Engine B5244SG	GDS62029	Drive Shaft	48T	36	26	56.5	48	540	
	2001.09-2006.07	MT	L	F	Saloon Engine B5244SG	GCI62028	Inner Joint		26	25	40	67.5	94	
	2001.09-2006.07	MT	L	F	Saloon Engine B5244SG	GC062038	Outer Joint		36	25	56.5	48	58	M
	2001.09-2006.07	MT	L	F	Saloon Engine B5244SG2	GDS62029	Drive Shaft	48T	36	26	56.5	48	540	





		TRANSM	L/R	F/R		G-AP Ref.	PRODUCT	ABS	Technical Specifications						
									YEAR	A	B	C	H	L	P
<b>VOLVO</b> <b>S80 I (TS, XY)</b>	2.4 Bifuel (103 kW)	2001.09-2006.07	MT	L	F	Saloon Engine B5244SG2	GCI62028	Inner Joint		26	25	40	67.5	94	
		2001.09-2006.07	MT	L	F	Saloon Engine B5244SG2	GC062038	Outer Joint		36	25	56.5	48	58	M
		2001.09-2006.07	AT	R	F	Saloon Engine B5244SG	GDS62017	Drive Shaft	48T	36	26	56.5	48	978.5	
		2001.09-2006.07	AT	R	F	Saloon Engine B5244SG	GCI62029	Inner Joint		26	26	31	513	93.5	
		2001.09-2006.07	AT	R	F	Saloon Engine B5244SG	GC062009	Outer Joint	48T	36	27	56.5	48	66	M
		2001.09-2006.07	AT	R	F	Saloon Engine B5244SG2	GDS62017	Drive Shaft	48T	36	26	56.5	48	978.5	
		2001.09-2006.07	AT	R	F	Saloon Engine B5244SG2	GCI62029	Inner Joint		26	26	31	513	93.5	
		2001.09-2006.07	AT	R	F	Saloon Engine B5244SG2	GC062009	Outer Joint	48T	36	27	56.5	48	66	M
		2001.09-2006.07	MT	R	F	Saloon Engine B5244SG	GDS62028	Drive Shaft	48T	36	26	56.5	48	990	
		2001.09-2006.07	MT	R	F	Saloon Engine B5244SG	GCI62030	Inner Joint		26	25	40	526	92.5	
		2001.09-2006.07	MT	R	F	Saloon Engine B5244SG	GC062040	Outer Joint	48T	36	25	56.5	48	58	M
		2001.09-2006.07	MT	R	F	Saloon Engine B5244SG2	GDS62028	Drive Shaft	48T	36	26	56.5	48	990	
		2001.09-2006.07	MT	R	F	Saloon Engine B5244SG2	GCI62030	Inner Joint		26	25	40	526	92.5	
		2001.09-2006.07	MT	R	F	Saloon Engine B5244SG2	GC062040	Outer Joint	48T	36	25	56.5	48	58	M
2.4 D (96 kW)	2001.10-2006.07	MT/AT		F	Saloon Engine D5244T2	GC062009	Outer Joint	48T	36	27	56.5	48	66	M	
	2001.10-2006.07	MT	L	F	Saloon Engine D5244T2	GDS62029	Drive Shaft	48T	36	26	56.5	48	540		
	2001.10-2006.07	MT	L	F	Saloon Engine D5244T2	GCI62028	Inner Joint		26	25	40	67.5	94		
	2001.10-2006.07	MT	L	F	Saloon Engine D5244T2	GC062038	Outer Joint		36	25	56.5	48	58	M	
	2001.10-2006.07	AT	R	F	Saloon Engine D5244T2	GDS62017	Drive Shaft	48T	36	26	56.5	48	978.5		
	2001.10-2006.07	AT	R	F	Saloon Engine D5244T2	GCI62029	Inner Joint		26	26	31	513	93.5		
	2001.10-2006.07	AT	R	F	Saloon Engine D5244T2	GC062009	Outer Joint	48T	36	27	56.5	48	66	M	
	2001.10-2006.07	MT	R	F	Saloon Engine D5244T2	GDS62028	Drive Shaft	48T	36	26	56.5	48	990		
	2001.10-2006.07	MT	R	F	Saloon Engine D5244T2	GCI62030	Inner Joint		26	25	40	526	92.5		
	2001.10-2006.07	MT	R	F	Saloon Engine D5244T2	GC062040	Outer Joint	48T	36	25	56.5	48	58	M	
2.4 D5 (120 kW)	2001.08-2006.07	MT/AT		F	Saloon Engine D5244T	GC062009	Outer Joint	48T	36	27	56.5	48	66	M	
	2001.08-2006.07	MT	L	F	Saloon Engine D5244T	GDS62029	Drive Shaft	48T	36	26	56.5	48	540		
	2001.08-2006.07	MT	L	F	Saloon Engine D5244T	GCI62028	Inner Joint		26	25	40	67.5	94		
	2001.08-2006.07	MT	L	F	Saloon Engine D5244T	GC062038	Outer Joint		36	25	56.5	48	58	M	
	2001.08-2006.07	AT	R	F	Saloon Engine D5244T	GDS62017	Drive Shaft	48T	36	26	56.5	48	978.5		
	2001.08-2006.07	AT	R	F	Saloon Engine D5244T	GCI62029	Inner Joint		26	26	31	513	93.5		
	2001.08-2006.07	AT	R	F	Saloon Engine D5244T	GC062009	Outer Joint	48T	36	27	56.5	48	66	M	
	2001.08-2006.07	MT	R	F	Saloon Engine D5244T	GDS62028	Drive Shaft	48T	36	26	56.5	48	990		
	2001.08-2006.07	MT	R	F	Saloon Engine D5244T	GCI62030	Inner Joint		26	25	40	526	92.5		
2001.08-2006.07	MT	R	F	Saloon Engine D5244T	GC062040	Outer Joint	48T	36	25	56.5	48	58	M		
2.4 T (147 kW)	2000.06-2006.07	MT/AT		F	Saloon Engine B5244T3	GC062009	Outer Joint	48T	36	27	56.5	48	66	M	
	2000.06-2006.07	MT	L	F	Saloon Engine B5244T3	GDS62029	Drive Shaft	48T	36	26	56.5	48	540		
	2000.06-2006.07	MT	L	F	Saloon Engine B5244T3	GCI62028	Inner Joint		26	25	40	67.5	94		
	2000.06-2006.07	MT	L	F	Saloon Engine B5244T3	GC062038	Outer Joint		36	25	56.5	48	58	M	
	2000.06-2006.07	AT	R	F	Saloon Engine B5244T3	GDS62017	Drive Shaft	48T	36	26	56.5	48	978.5		
	2000.06-2006.07	AT	R	F	Saloon Engine B5244T3	GCI62029	Inner Joint		26	26	31	513	93.5		
	2000.06-2006.07	AT	R	F	Saloon Engine B5244T3	GC062009	Outer Joint	48T	36	27	56.5	48	66	M	
	2000.06-2006.07	MT	R	F	Saloon Engine B5244T3	GDS62028	Drive Shaft	48T	36	26	56.5	48	990		
	2000.06-2006.07	MT	R	F	Saloon Engine B5244T3	GCI62030	Inner Joint		26	25	40	526	92.5		
	2000.06-2006.07	MT	R	F	Saloon Engine B5244T3	GC062040	Outer Joint	48T	36	25	56.5	48	58	M	
2.4 T5 AWD (147 kW)	2000.04-2003.09	MT	L	F	Saloon Engine B5244T3	GDS62029	Drive Shaft	48T	36	26	56.5	48	540		
	2000.04-2003.09	MT	L	F	Saloon Engine B5244T3	GCI62028	Inner Joint		26	25	40	67.5	94		
	2000.04-2003.09	MT	L	F	Saloon Engine B5244T3	GC062038	Outer Joint		36	25	56.5	48	58	M	
2.5 T (154 kW)	2003.03-2006.02	MT	L	F	Saloon Engine B5254T2	GDS62029	Drive Shaft	48T	36	26	56.5	48	540		
	2003.03-2006.02	MT	L	F	Saloon Engine B5254T2	GCI62028	Inner Joint		26	25	40	67.5	94		
	2003.03-2006.02	MT	L	F	Saloon Engine B5254T2	GC062038	Outer Joint		36	25	56.5	48	58	M	
	2003.03-2006.02	AT	R	F	Saloon Engine B5254T2	GDS62017	Drive Shaft	48T	36	26	56.5	48	978.5		
	2003.03-2006.02	AT	R	F	Saloon Engine B5254T2	GCI62029	Inner Joint		26	26	31	513	93.5		
	2003.03-2006.02	AT	R	F	Saloon Engine B5254T2	GC062009	Outer Joint	48T	36	27	56.5	48	66	M	
	2003.03-2006.02	MT	R	F	Saloon Engine B5254T2	GDS62028	Drive Shaft	48T	36	26	56.5	48	990		
	2003.03-2006.02	MT	R	F	Saloon Engine B5254T2	GCI62030	Inner Joint		26	25	40	526	92.5		
	2003.03-2006.02	MT	R	F	Saloon Engine B5254T2	GC062040	Outer Joint	48T	36	25	56.5	48	58	M	
2.5 T AWD (154 kW)	2003.07-2006.07	MT/AT		F	Saloon Engine B5254T2	GC062009	Outer Joint	48T	36	27	56.5	48	66	M	
2.5 TDi (103 kW)	1999.01-2006.07	MT/AT		F	Saloon Engine D5252T	GC062009	Outer Joint	48T	36	27	56.5	48	66	M	
	1999.01-2006.07	MT	L	F	Saloon Engine D5252T	GDS62029	Drive Shaft	48T	36	26	56.5	48	540		
	1999.01-2006.07	MT	L	F	Saloon Engine D5252T	GCI62028	Inner Joint		26	25	40	67.5	94		
	1999.01-2006.07	MT	L	F	Saloon Engine D5252T	GC062038	Outer Joint		36	25	56.5	48	58	M	



		TRANSM	L/R	F/R		G-AP Ref.	PRODUCT	ABS	Technical Specifications						
									YEAR	A	B	C	H	L	P
<b>VOLVO</b>															
<b>S80 I (TS, XY)</b>															
2.5 TDi (103 kW)	1999.01-	2006.07	MT	R	F	Saloon Engine D5252T	GDS62028	Drive Shaft	48T	36	26	56.5	48	990	
	1999.01-	2006.07	MT	R	F	Saloon Engine D5252T	GCI62030	Inner Joint		26	25	40	526	92.5	
	1999.01-	2006.07	MT	R	F	Saloon Engine D5252T	GC062040	Outer Joint	48T	36	25	56.5	48	58	M
2.8 T6 (200 kW)	1998.05-	2006.07	MT/AT		F	Saloon Engine B6284T	GC062009	Outer Joint	48T	36	27	56.5	48	66	M
2.9 (147 kW)	1999.03-	2006.07	MT/AT		F	Saloon Engine B6294S	GC062009	Outer Joint	48T	36	27	56.5	48	66	M
	1999.03-	2006.07	MT	L	F	Saloon Engine B6294S	GDS62029	Drive Shaft	48T	36	26	56.5	48	540	
	1999.03-	2006.07	MT	L	F	Saloon Engine B6294S	GCI62028	Inner Joint		26	25	40	67.5	94	
	1999.03-	2006.07	MT	L	F	Saloon Engine B6294S	GC062038	Outer Joint		36	25	56.5	48	58	M
	1999.03-	2006.07		R	F	Saloon Engine B6294S	GDS62028	Drive Shaft	48T	36	26	56.5	48	990	
	1999.03-	2006.07		R	F	Saloon Engine B6294S	GCI62030	Inner Joint		26	25	40	526	92.5	
	1999.03-	2006.07		R	F	Saloon Engine B6294S	GC062040	Outer Joint	48T	36	25	56.5	48	58	M
2.9 (150 kW)	1998.05-	2006.07	MT/AT		F	Saloon Engine B6304S3	GC062009	Outer Joint	48T	36	27	56.5	48	66	M
	1998.05-	2006.07	MT	L	F	Saloon Engine B6304S3	GDS62029	Drive Shaft	48T	36	26	56.5	48	540	
	1998.05-	2006.07	MT	L	F	Saloon Engine B6304S3	GCI62028	Inner Joint		26	25	40	67.5	94	
	1998.05-	2006.07	MT	L	F	Saloon Engine B6304S3	GC062038	Outer Joint		36	25	56.5	48	58	M
	1998.05-	2006.07		R	F	Saloon Engine B6304S3	GDS62028	Drive Shaft	48T	36	26	56.5	48	990	
	1998.05-	2006.07		R	F	Saloon Engine B6304S3	GCI62030	Inner Joint		26	25	40	526	92.5	
	1998.05-	2006.07		R	F	Saloon Engine B6304S3	GC062040	Outer Joint	48T	36	25	56.5	48	58	M
3.0 (144 kW)	2001.06-	2006.07	MT/AT		F	Saloon Engine B6294S2	GC062009	Outer Joint	48T	36	27	56.5	48	66	M
3.0 T6 (200 kW)	2001.06-	2006.07	MT/AT		F	Saloon Engine B6294T	GC062009	Outer Joint	48T	36	27	56.5	48	66	M
<b>S80 II (AS)</b>															
2.4 D (120 kW)	2006.03-	2007.01	AT			Saloon Engine D5244T/D5244T5	GC059344	Outer Joint		40	26	57.4	52	63.5	M
	2006.03-	2007.01	MT			Saloon Engine D5244T/D5244T5	GC059285	Outer Joint		40	27	57.4	52	63.5	M
2.4 D (129 kW)	2010.01-		AT	L	F	Saloon Engine D5244T14	GDS59443	Drive Shaft		40	31	57.4	52	528	
	2010.01-		AT	R	F	Saloon Engine D5244T14	GDS59444	Drive Shaft		40	28	57.4	52	994	
	2010.01-		AT			Saloon Engine D5244T14	GC059344	Outer Joint		40	26	57.4	52	63.5	M
2.4 D5 (136 kW)	2006.03-	2007.01	AT	L	F	Saloon Engine D5244T4	GDS59443	Drive Shaft		40	31	57.4	52	528	
	2006.03-	2007.01	AT	R	F	Saloon Engine D5244T4	GDS59444	Drive Shaft		40	28	57.4	52	994	
	2006.03-	2007.01	AT			Saloon Engine D5244T4	GC059344	Outer Joint		40	26	57.4	52	63.5	M
2.4 D5 (151 kW)	2010.01-		AT	L	F	Saloon Engine D5244T10	GDS59443	Drive Shaft		40	31	57.4	52	528	
	2010.01-		AT	R	F	Saloon Engine D5244T10	GDS59444	Drive Shaft		40	28	57.4	52	994	
2.4 D5 (158 kW)	2011.06-		AT	L	F	Saloon Engine D5244T11/D5244T15	GDS59443	Drive Shaft		40	31	57.4	52	528	
	2011.06-		AT	R	F	Saloon Engine D5244T11/D5244T15	GDS59444	Drive Shaft		40	28	57.4	52	994	
2.4 D5 AWD (136 kW)	2007.01-		AT	L	F	Saloon Engine D5244T4	GDS59443	Drive Shaft		40	31	57.4	52	528	
	2007.01-		AT			Saloon Engine D5244T4	GC059344	Outer Joint		40	26	57.4	52	63.5	M
2.4 D5 AWD (151 kW)	2010.01-		AT	L	F	Saloon Engine D5244T10	GDS59443	Drive Shaft		40	31	57.4	52	528	
2.4 D5 AWD (158 kW)	2011.06-		AT	L	F	Saloon Engine D5244T11/D5244T15	GDS59443	Drive Shaft		40	31	57.4	52	528	
2.5 T (147 kW)	2006.03-	2007.01				Saloon Engine B5254T6	GC059344	Outer Joint		40	26	57.4	52	63.5	M
2.5 T (170 kW)	2010.01-					Saloon Engine B5254T10	GC059344	Outer Joint		40	26	57.4	52	63.5	M
2.5 T AWD (147 kW)	2006.10-					Saloon Engine B5254T6	GC059344	Outer Joint		40	26	57.4	52	63.5	M
2.5 T FlexFuel (147 kW)	2008.05-					Saloon Engine B5254T8	GC059344	Outer Joint		40	26	57.4	52	63.5	M
2.5 T FlexFuel (170 kW)	2010.01-					Saloon Engine B5254T11	GC059344	Outer Joint		40	26	57.4	52	63.5	M
3.0 T6 AWD (210 kW)	2007.01-					Saloon Engine B6304T2	GC059285	Outer Joint		40	27	57.4	52	63.5	M
3.0 T6 AWD (224 kW)	2010.10-					Saloon Engine B6304T4	GC059285	Outer Joint		40	27	57.4	52	63.5	M
3.2 (175 kW)	2006.03-	2007.01				Saloon Engine B6324S	GC059285	Outer Joint		40	27	57.4	52	63.5	M
3.2 AWD (175 kW)	2007.01-					Saloon Engine B6324S	GC059285	Outer Joint		40	27	57.4	52	63.5	M
3.2 AWD (179 kW)	2010.01-					Saloon Engine B6324S5	GC059285	Outer Joint		40	27	57.4	52	63.5	M
4.4 V8 4WD (232 kW)	2006.03-					Transmission Cardanic	GCI35009	Inner Joint		20		21			
4.4 V8 AWD (232 kW)	2006.03-	2007.01				Saloon Engine B8444S	GC059344	Outer Joint		40	26	57.4	52	63.5	M
<b>V40</b>															
1.6 (80 kW)	1999-	2003					GC062024	Outer Joint	43T	26	27	56.5	98	66.5	M
1.6 D2 (84 kW)	2012.03-			L	F	Hatchback Engine D4162T	GDS34224	Drive Shaft		36	26	56.1	48	581	
1.6 T4 GTDi (132 kW)	2012.03-		MT	L	F	Hatchback Engine B4164T	GDS34224	Drive Shaft		36	26	56.1	48	581	
T3 GTDi (110 kW)	2012.03-		MT	L	F	Hatchback Engine B4164T3	GDS34224	Drive Shaft		36	26	56.1	48	581	
<b>V40 (VW)</b>															
1.6 (80 kW)	1999.03-	2004.06	MT		F	Estate Engine B4164S2	GC039021	Outer Joint		25	29	54	94.5	64.5	O
	1999.03-	2004.06	MT/AT		F	Estate Engine B4164S2	GC062008	Outer Joint	43T	25	33	54	95	61	M
	1999.03-	2004.06	MT	L	F	Estate Engine B4164S2	GDS39097	Drive Shaft	43T	25	25	54	95.5	614	
	1999.03-	2004.06	MT	R	F	Estate Engine B4164S2	GDS39096	Drive Shaft	43T	25	25	54	95.5	937	
	1999.03-	2004.06	MT	R	F	Estate Engine B4164S2	GDS50421	Drive Shaft	43T	25	23	54	94.5	813	
	1999.03-	2004.06				Estate Engine B4164S2	GC039100	Outer Joint	43T	25	23	54	95.5	64	M





		TRANSM	L/R	F/R		G-AP Ref.	PRODUCT	ABS	Technical Specifications									
									YEAR	A	B	C	H	L	P			
<b>VOLVO</b>																		
<b>V40 (VW)</b>																		
1.6 (80 kW)	1999.03-	2004.06			Estate Engine B4164S2	GC099230	Outer Joint	43T	25	29	54	95	60	O				
1.8 (90 kW)	1999.03-	2004.06			F Estate Engine B4184S2/B4184S9	GC039021	Outer Joint		25	29	54	94.5	64.5	O				
	1999.03-	2004.06	MT/AT		F Estate Engine B4184S2/B4184S9	GC062008	Outer Joint	43T	25	33	54	95	61	M				
	1999.03-	2004.06	AT	L	F Estate Engine B4184S2/B4184S9	GDS62072	Drive Shaft	43T	25	26	54	95	599					
	1999.03-	2004.06	MT	L	F Estate Engine B4184S2/B4184S9	GDS39097	Drive Shaft	43T	25	25	54	95.5	614					
	1999.03-	2004.06	AT	R	F Estate Engine B4184S2/B4184S9	GDS62035	Drive Shaft	43T	25	26	54	95	948					
	1999.03-	2004.06	MT	R	F Estate Engine B4184S2/B4184S9	GDS39096	Drive Shaft	43T	25	25	54	95.5	937					
	1999.03-	2004.06	MT	R	F Estate Engine B4184S2/B4184S9	GDS50421	Drive Shaft	43T	25	23	54	94.5	813					
	1999.03-	2004.06	MT	R	F Estate Engine B4184S2/B4184S9	GDS62021	Drive Shaft	43T	25	26	54	95	945					
	1999.03-	2004.06			Estate Engine B4184S2/B4184S9	GC039100	Outer Joint	43T	25	23	54	95.5	64	M				
1.8 i (90 kW)	1999.03-	2004.06			Estate Engine B4184S2/B4184S9	GC099230	Outer Joint	43T	25	29	54	95	60	O				
	2001.06-	2004.06			F Estate Engine B4184SJ	GC039021	Outer Joint		25	29	54	94.5	64.5	O				
	2001.06-	2004.06	MT/AT		F Estate Engine B4184SJ	GC062011	Outer Joint	43T	25	33	56.3	99	61.5	M				
	2001.06-	2004.06	AT	L	F Estate Engine B4184SJ	GDS62072	Drive Shaft	43T	25	26	54	95	599					
	2001.06-	2004.06	MT	L	F Estate Engine B4184SJ	GDS39097	Drive Shaft	43T	25	25	54	95.5	614					
	2001.06-	2004.06	AT	R	F Estate Engine B4184SJ	GDS62035	Drive Shaft	43T	25	26	54	95	948					
	2001.06-	2004.06	MT	R	F Estate Engine B4184SJ	GDS39096	Drive Shaft	43T	25	25	54	95.5	937					
	2001.06-	2004.06	MT	R	F Estate Engine B4184SJ	GDS50421	Drive Shaft	43T	25	23	54	94.5	813					
	2001.06-	2004.06	MT	R	F Estate Engine B4184SJ	GDS62021	Drive Shaft	43T	25	26	54	95	945					
1.8 i (92 kW)	2001.06-	2004.06			Estate Engine B4184SJ	GC039100	Outer Joint	43T	25	23	54	95.5	64	M				
	2001.06-	2004.06			Estate Engine B4184SJ	GC099230	Outer Joint	43T	25	29	54	95	60	O				
	1998.03-	2004.06			F Estate Engine B4184SM	GC039021	Outer Joint		25	29	54	94.5	64.5	O				
	1998.03-	2004.06	MT/AT		F Estate Engine B4184SM	GC062008	Outer Joint	43T	25	33	54	95	61	M				
	1998.03-	2004.06	AT	L	F Estate Engine B4184SM	GDS62072	Drive Shaft	43T	25	26	54	95	599					
	1998.03-	2004.06	MT	L	F Estate Engine B4184SM	GDS39097	Drive Shaft	43T	25	25	54	95.5	614					
	1998.03-	2004.06	AT	R	F Estate Engine B4184SM	GDS62035	Drive Shaft	43T	25	26	54	95	948					
	1998.03-	2004.06	MT	R	F Estate Engine B4184SM	GDS39096	Drive Shaft	43T	25	25	54	95.5	937					
	1998.03-	2004.06	MT	R	F Estate Engine B4184SM	GDS50421	Drive Shaft	43T	25	23	54	94.5	813					
1.9 Di (75 kW)	1998.03-	2004.06	MT	R	F Estate Engine B4184SM	GDS62021	Drive Shaft	43T	25	26	54	95	945					
	1998.03-	2004.06	MT	R	F Estate Engine B4184SM	GC039100	Outer Joint	43T	25	23	54	95.5	64	M				
	1998.03-	2004.06			Estate Engine B4184SM	GC099230	Outer Joint	43T	25	29	54	95	60	O				
	2000.07-	2004.06			F Estate Engine D4192T4	GC039021	Outer Joint		25	29	54	94.5	64.5	O				
	2000.07-	2004.06	MT/AT		F Estate Engine D4192T4	GC062012	Outer Joint	43T	26	27	56.5	98	66.5	M				
	2000.07-	2004.06	MT	L	F Estate Engine D4192T4	GDS62064	Drive Shaft	43T	26	26	56.5	98	607					
	1.9 Di (85 kW)	2000.07-	2004.06	MT/AT		F Estate Engine D4192T3	GC062012	Outer Joint	43T	26	27	56.5	98	66.5	M			
		2000.07-	2004.06	MT	L	F Estate Engine D4192T3	GDS62064	Drive Shaft	43T	26	26	56.5	98	607				
	2.0 (100 kW)	1995.07-	2004.06			F Estate Engine B4204S/B4204S2	GC039021	Outer Joint		25	29	54	94.5	64.5	O			
1995.07-		2004.06	MT/AT		F Estate Engine B4204S/B4204S2	GC062003	Outer Joint	43T	25	25	54	95	61	O				
1995.07-		2004.06	AT	L	F Estate Engine B4204S/B4204S2	GDS62072	Drive Shaft	43T	25	26	54	95	599					
1995.07-		2004.06	MT	L	F Estate Engine B4204S/B4204S2	GDS62004	Drive Shaft	43T	25	29.95	54	95	628.7					
1995.07-		2004.06	AT	R	F Estate Engine B4204S/B4204S2	GDS62035	Drive Shaft	43T	25	26	54	95	948					
1995.07-		2004.06	MT	R	F Estate Engine B4204S/B4204S2	GDS50421	Drive Shaft	43T	25	23	54	94.5	813					
1995.07-		2004.06	AT		Estate Engine B4204S/B4204S2	GC099262	Outer Joint	43T	25	25	54	95	61	O				
2.0 T (118 kW)	1995.07-	2004.06			Estate Engine B4204S/B4204S2	GC099230	Outer Joint	43T	25	29	54	95	60	O				
	1997.10-	2004.01			F Estate Engine B4204T	GC062003	Outer Joint	43T	25	25	54	95	61	O				
2.0 T (121 kW)	1997.10-	2004.01	MT/AT		F Estate Engine B4204T	GC062012	Outer Joint	43T	26	27	56.5	98	66.5	M				
2.0 T4 (147 kW)	1999.07-	2004.06	MT/AT		F Estate Engine B4204T2	GC062012	Outer Joint	43T	26	27	56.5	98	66.5	M				
2.0 T4 (147 kW)	2000.07-	2004.06	MT/AT		F Estate Engine B4204T5	GC062012	Outer Joint	43T	26	27	56.5	98	66.5	M				
<b>V50 (MW)</b>																		
1.6 (74 kW)	2007.02-	2007.04	MT	L	F Estate Engine B4164S3	GDS18189	Drive Shaft		36	23	56	48	601					
	2007.02-	2007.04	MT	L	F Estate Engine B4164S3	GCI18168	Inner Joint		23	22	40	61	90					
	2007.02-	2007.04	MT	L	F Estate Engine B4164S3	GC018264	Outer Joint		36	25	51.6	48	58	O				
	2007.02-	2007.04	MT	R	F Estate Engine B4164S3	GDS18206	Drive Shaft		36	23	56	48	906					
	2007.02-	2007.04			R F Estate Engine B4164S3	GDS18337	Drive Shaft		36	23	51.6	48	908					
1.6 D2 (84 kW)	2010.01-				R F Estate Engine D4162T	GDS62053	Drive Shaft		36	26	56.3	48	917					
1.8 (92 kW)	2004.04-		5MT	L	F Estate Engine B4184S11	GDS18328	Drive Shaft		36	26	55.3	48	580					
	2004.04-		5MT	R	F Estate Engine B4184S11	GDS18329	Drive Shaft		36	26	55.3	48	920					
1.8 FlexFuel (92 kW)	2005.01-		5MT	L	F Estate Engine B4184S8	GDS18328	Drive Shaft		36	26	55.3	48	580					
	2005.01-		5MT	R	F Estate Engine B4184S8	GDS18329	Drive Shaft		36	26	55.3	48	920					
2.0 (107 kW)	2006.10-		5MT	L	F Estate Engine B4204S3	GDS18328	Drive Shaft		36	26	55.3	48	580					
	2006.10-		5MT	R	F Estate Engine B4204S3	GDS18329	Drive Shaft		36	26	55.3	48	920					





		TRANSM	L/R	F/R		G-AP Ref.	PRODUCT	ABS	Technical Specifications								
									YEAR	A	B	C	H	L	P		
<b>VOLVO</b>																	
<b>V50 (MW)</b>																	
2.0 D (100 kW)	2004.04-		AT	L	F	Estate Engine D4204T	GDS18367	Drive Shaft		36	28	56	48	570			
	2004.04-		MT	L	F	Estate Engine D4204T	GDS18194	Drive Shaft		36	26	56	48	568			
2.4 (103 kW)	2004.04-		Semi-AT	L	F	Estate Engine B5244S5	GDS62060	Drive Shaft		36	26	56	48	519			
	2004.04-		AT	R	F	Estate Engine B5244S5	GDS18192	Drive Shaft		36	26	56	48	949			
	2004.04-		Semi-AT	R	F	Estate Engine B5244S5	GDS62063	Drive Shaft		36	26	56	48	947			
2.4 (125 kW)	2004.04-		Semi-AT	L	F	Estate Engine B5244S4	GDS62060	Drive Shaft		36	26	56	48	519			
	2004.04-		AT	R	F	Estate Engine B5244S4	GDS18192	Drive Shaft		36	26	56	48	949			
	2004.04-		Semi-AT	R	F	Estate Engine B5244S4	GDS62063	Drive Shaft		36	26	56	48	947			
2.4 D5 (132 kW)	2006.04-	2008.02	AT	L	F	Estate Engine D5244T8/D5244T13	GDS62060	Drive Shaft		36	26	56	48	519			
	2006.04-	2008.02	AT	R	F	Estate Engine D5244T8/D5244T13	GDS62063	Drive Shaft		36	26	56	48	947			
2.4 TDi (120 kW)	2007.05-			L	F	Estate Engine D5244T9	GDS62060	Drive Shaft		36	26	56	48	519			
	2007.05-			R	F	Estate Engine D5244T9	GDS62063	Drive Shaft		36	26	56	48	947			
2.5 T5 (162 kW)	2004.04-		Semi-AT	L	F	Estate Engine B5254T3	GDS62060	Drive Shaft		36	26	56	48	519			
	2004.04-		AT	R	F	Estate Engine B5254T3	GDS18192	Drive Shaft		36	26	56	48	949			
	2004.04-		Semi-AT	R	F	Estate Engine B5254T3	GDS62063	Drive Shaft		36	26	56	48	947			
2.5 T5 (169 kW)	2007.05-	2008.02	Semi-AT	L	F	Estate Engine B5254T7	GDS62060	Drive Shaft		36	26	56	48	519			
	2007.05-	2008.02	AT	R	F	Estate Engine B5254T7	GDS62063	Drive Shaft		36	26	56	48	947			
<b>V60</b>																	
2.0 D3/D4 (120 kW)	2010.09-		AT	R	F	Estate Engine D5204T2/D5204T3	GDS59444	Drive Shaft		40	28	57.4	52	994			
2.4 D5 (151 kW)	2010.09-		AT	R	F	Estate Engine D5244T10	GDS59444	Drive Shaft		40	28	57.4	52	994			
2.4 D5 (158 kW)	2011.06-		AT	R	F	Estate Engine D5244T11/D5244T15	GDS59444	Drive Shaft		40	28	57.4	52	994			
	2011.06-		AT			Estate Engine D5244T11/D5244T15	GC059344	Outer Joint		40	26	57.4	52	63.5	M		
2.4 D5 AWD (151 kW)	2010.09-					Estate Engine D5244T10	GC059344	Outer Joint		40	26	57.4	52	63.5	M		
2.4 D5 AWD (158 kW)	2011.06-					Estate Engine D5244T11/D5244T15	GC059344	Outer Joint		40	26	57.4	52	63.5	M		
2.4 Hybrid AWD (158 kW)	2012.06-					Estate Engine D5244T15/D82PHEV	GC059344	Outer Joint		40	26	57.4	52	63.5	M		
D3 (100 kW)	2012.12-		AT	R	F	Estate Engine D 5204 T7	GDS59444	Drive Shaft		40	28	57.4	52	994			
<b>V70 II (SW)</b>																	
2.0 T (132 kW)	2001.07-	2007.08	MT/AT		F	Estate Engine B5204T5	GC062010	Outer Joint	48T	36	33	56.5	48	58	M		
	2001.07-	2007.08	AT	L	F	Estate Engine B5204T5	GDS62022	Drive Shaft	48T	36	26	56.5	48	527			
	2001.07-	2007.08	AT	L	F	Estate Engine B5204T5	GCI99109	Inner Joint		26	26	31	50	105			
	2001.07-	2007.08	AT	L	F	Estate Engine B5204T5	GC062019	Outer Joint		36	27	56.5	48	66	M		
	2001.07-	2007.08	MT	L	F	Estate Engine B5204T5	GDS62029	Drive Shaft	48T	36	26	56.5	48	540			
	2001.07-	2007.08	MT	L	F	Estate Engine B5204T5	GCI62028	Inner Joint		26	25	40	67.5	94			
	2001.07-	2007.08	MT	L	F	Estate Engine B5204T5	GC062038	Outer Joint		36	25	56.5	48	58	M		
	2001.07-	2007.08	MT	R	F	Estate Engine B5204T5	GDS62028	Drive Shaft	48T	36	26	56.5	48	990			
	2001.07-	2007.08	MT	R	F	Estate Engine B5204T5	GCI62029	Inner Joint		26	26	31	513	93.5			
	2001.07-	2007.08	MT	R	F	Estate Engine B5204T5	GCI62030	Inner Joint		26	25	40	526	92.5			
	2001.07-	2007.08	MT	R	F	Estate Engine B5204T5	GC062009	Outer Joint	48T	36	27	56.5	48	66	M		
	2001.07-	2007.08	MT	R	F	Estate Engine B5204T5	GC062040	Outer Joint	48T	36	25	56.5	48	58	M		
2.3 (195 kW)	2000.10-	2004.09		L	F	Estate Engine B5234T7	GDS62022	Drive Shaft	48T	36	26	56.5	48	527			
	2000.10-	2004.09		L	F	Estate Engine B5234T7	GCI99109	Inner Joint		26	26	31	50	105			
	2000.10-	2004.09		L	F	Estate Engine B5234T7	GC062019	Outer Joint		36	27	56.5	48	66	M		
2.3 T5 (184 kW)	2000.03-	2007.08	MT/AT		F	Estate Engine B5234T3/B5234T4	GC062009	Outer Joint	48T	36	27	56.5	48	66	M		
	2000.03-	2007.08	AT	L	F	Estate Engine B5234T3/B5234T4	GDS62022	Drive Shaft	48T	36	26	56.5	48	527			
	2000.03-	2007.08	AT	L	F	Estate Engine B5234T3/B5234T4	GCI99109	Inner Joint		26	26	31	50	105			
	2000.03-	2007.08	AT	L	F	Estate Engine B5234T3/B5234T4	GC062019	Outer Joint		36	27	56.5	48	66	M		
	2000.03-	2007.08	MT	R	F	Estate Engine B5234T3/B5234T4	GDS62028	Drive Shaft	48T	36	26	56.5	48	990			
	2000.03-	2007.08	MT	R	F	Estate Engine B5234T3/B5234T4	GCI62030	Inner Joint		26	25	40	526	92.5			
	2000.03-	2007.08	MT	R	F	Estate Engine B5234T3/B5234T4	GC062040	Outer Joint	48T	36	25	56.5	48	58	M		
2.4 (103 kW)	2000.03-	2007.08	MT/AT		F	Estate Engine B5244S2	GC062010	Outer Joint	48T	36	33	56.5	48	58	M		
	2000.03-	2007.08	MT	L	F	Estate Engine B5244S2	GDS62029	Drive Shaft	48T	36	26	56.5	48	540			
	2000.03-	2007.08	MT	L	F	Estate Engine B5244S2	GCI62028	Inner Joint		26	25	40	67.5	94			
	2000.03-	2007.08	MT	L	F	Estate Engine B5244S2	GC062038	Outer Joint		36	25	56.5	48	58	M		
	2000.03-	2007.08	MT	R	F	Estate Engine B5244S2	GDS62028	Drive Shaft	48T	36	26	56.5	48	990			
	2000.03-	2007.08	MT	R	F	Estate Engine B5244S2	GCI62030	Inner Joint		26	25	40	526	92.5			
	2000.03-	2007.08	MT	R	F	Estate Engine B5244S2	GC062040	Outer Joint	48T	36	25	56.5	48	58	M		
2.4 (125 kW)	2000.03-	2007.08	MT/AT		F	Estate Engine B5244S	GC062010	Outer Joint	48T	36	33	56.5	48	58	M		
	2000.03-	2007.08	MT	L	F	Estate Engine B5244S	GDS62029	Drive Shaft	48T	36	26	56.5	48	540			
	2000.03-	2007.08	MT	L	F	Estate Engine B5244S	GCI62028	Inner Joint		26	25	40	67.5	94			
	2000.03-	2007.08	MT	L	F	Estate Engine B5244S	GC062038	Outer Joint		36	25	56.5	48	58	M		
	2000.03-	2007.08	MT	R	F	Estate Engine B5244S	GDS62028	Drive Shaft	48T	36	26	56.5	48	990			
	2000.03-	2007.08	MT	R	F	Estate Engine B5244S	GCI62030	Inner Joint		26	25	40	526	92.5			
	2000.03-	2007.08	MT	R	F	Estate Engine B5244S	GC062040	Outer Joint	48T	36	25	56.5	48	58	M		



		YEAR	TRANSM	L/R	F/R		G-AP Ref.	PRODUCT	ABS	Technical Specifications										
										A	B	C	H	L	P					
<b>VOLVO</b>																				
<b>V70 II (SW)</b>																				
2.4 (125 kW)	2000.03-	2007.08	MT	R	F	Estate Engine B5244S	GCI62030	Inner Joint		26	25	40	526	92.5						
	2000.03-	2007.08	MT	R	F	Estate Engine B5244S	GC062040	Outer Joint	48T	36	25	56.5	48	58	M					
2.4 Bifuel (103 kW)	2001.09-	2007.08	MT/AT		F	Estate Engine B5244SG2	GC062010	Outer Joint	48T	36	33	56.5	48	58	M					
	2001.09-	2007.08	MT	L	F	Estate Engine B5244SG	GDS62029	Drive Shaft	48T	36	26	56.5	48	540						
	2001.09-	2007.08	MT	L	F	Estate Engine B5244SG	GCI62028	Inner Joint		26	25	40	67.5	94						
	2001.09-	2007.08	MT	L	F	Estate Engine B5244SG	GC062038	Outer Joint		36	25	56.5	48	58	M					
	2001.09-	2007.08	MT	L	F	Estate Engine B5244SG2	GDS62029	Drive Shaft	48T	36	26	56.5	48	540						
	2001.09-	2007.08	MT	L	F	Estate Engine B5244SG2	GCI62028	Inner Joint		26	25	40	67.5	94						
	2001.09-	2007.08	MT	L	F	Estate Engine B5244SG2	GC062038	Outer Joint		36	25	56.5	48	58	M					
	2001.09-	2007.08	MT	R	F	Estate Engine B5244SG	GDS62028	Drive Shaft	48T	36	26	56.5	48	990						
	2001.09-	2007.08	MT	R	F	Estate Engine B5244SG	GCI62030	Inner Joint		26	25	40	526	92.5						
	2001.09-	2007.08	MT	R	F	Estate Engine B5244SG	GC062040	Outer Joint	48T	36	25	56.5	48	58	M					
	2001.09-	2007.08	MT	R	F	Estate Engine B5244SG2	GDS62028	Drive Shaft	48T	36	26	56.5	48	990						
	2001.09-	2007.08	MT	R	F	Estate Engine B5244SG2	GCI62030	Inner Joint		26	25	40	526	92.5						
	2001.09-	2007.08	MT	R	F	Estate Engine B5244SG2	GC062040	Outer Joint	48T	36	25	56.5	48	58	M					
2.4 D (93 kW)	2005.05-	2007.08	MT	L	F	Estate Engine D5244T7	GDS62029	Drive Shaft	48T	36	26	56.5	48	540						
	2005.05-	2007.08	MT	L	F	Estate Engine D5244T7	GCI62028	Inner Joint		26	25	40	67.5	94						
	2005.05-	2007.08	MT	L	F	Estate Engine D5244T7	GC062038	Outer Joint		36	25	56.5	48	58	M					
	2005.05-	2007.08	AT	R	F	Estate Engine D5244T7	GDS62017	Drive Shaft	48T	36	26	56.5	48	978.5						
	2005.05-	2007.08	AT	R	F	Estate Engine D5244T7	GCI62029	Inner Joint		26	26	31	513	93.5						
	2005.05-	2007.08	AT	R	F	Estate Engine D5244T7	GC062009	Outer Joint	48T	36	27	56.5	48	66	M					
	2005.05-	2007.08	MT	R	F	Estate Engine D5244T7	GDS62028	Drive Shaft	48T	36	26	56.5	48	990						
	2005.05-	2007.08	MT	R	F	Estate Engine D5244T7	GCI62030	Inner Joint		26	25	40	526	92.5						
	2005.05-	2007.08	MT	R	F	Estate Engine D5244T7	GC062040	Outer Joint	48T	36	25	56.5	48	58	M					
2.4 D (96 kW)	2001.12-	2007.08	MT/AT		F	Estate Engine D5244T2	GC062009	Outer Joint	48T	36	27	56.5	48	66	M					
	2001.12-	2007.08	AT	L	F	Estate Engine D5244T2	GDS62022	Drive Shaft	48T	36	26	56.5	48	527						
	2001.12-	2007.08	AT	L	F	Estate Engine D5244T2	GCI99109	Inner Joint		26	26	31	50	105						
	2001.12-	2007.08	AT	L	F	Estate Engine D5244T2	GC062019	Outer Joint		36	27	56.5	48	66	M					
	2001.12-	2007.08	MT	L	F	Estate Engine D5244T2	GDS62029	Drive Shaft	48T	36	26	56.5	48	540						
	2001.12-	2007.08	MT	L	F	Estate Engine D5244T2	GCI62028	Inner Joint		26	25	40	67.5	94						
	2001.12-	2007.08	MT	L	F	Estate Engine D5244T2	GC062038	Outer Joint		36	25	56.5	48	58	M					
	2001.12-	2007.08	AT	R	F	Estate Engine D5244T2	GDS62017	Drive Shaft	48T	36	26	56.5	48	978.5						
	2001.12-	2007.08	AT	R	F	Estate Engine D5244T2	GCI62029	Inner Joint		26	26	31	513	93.5						
	2001.12-	2007.08	AT	R	F	Estate Engine D5244T2	GC062009	Outer Joint	48T	36	27	56.5	48	66	M					
	2001.12-	2007.08	MT	R	F	Estate Engine D5244T2	GDS62028	Drive Shaft	48T	36	26	56.5	48	990						
	2001.12-	2007.08	MT	R	F	Estate Engine D5244T2	GCI62030	Inner Joint		26	25	40	526	92.5						
	2001.12-	2007.08	MT	R	F	Estate Engine D5244T2	GC062040	Outer Joint	48T	36	25	56.5	48	58	M					
2.4 D5 (120 kW)	2001.08-	2007.08	MT/AT		F	Estate Engine D5244T/D5244T5	GC062009	Outer Joint	48T	36	27	56.5	48	66	M					
	2001.08-	2007.08	AT	L	F	Estate Engine D5244T/D5244T5	GDS62022	Drive Shaft	48T	36	26	56.5	48	527						
	2001.08-	2007.08	AT	L	F	Estate Engine D5244T/D5244T5	GCI99109	Inner Joint		26	26	31	50	105						
	2001.08-	2007.08	AT	L	F	Estate Engine D5244T/D5244T5	GC062019	Outer Joint		36	27	56.5	48	66	M					
	2001.08-	2007.08	5AT	R	F	Estate Engine D5244T/D5244T5	GDS62017	Drive Shaft	48T	36	26	56.5	48	978.5						
	2001.08-	2007.08	5AT	R	F	Estate Engine D5244T/D5244T5	GCI62029	Inner Joint		26	26	31	513	93.5						
	2001.08-	2007.08	5AT	R	F	Estate Engine D5244T/D5244T5	GC062009	Outer Joint	48T	36	27	56.5	48	66	M					
	2001.08-	2007.08	MT	R	F	Estate Engine D5244T/D5244T5	GDS62028	Drive Shaft	48T	36	26	56.5	48	990						
	2001.08-	2007.08	MT	R	F	Estate Engine D5244T/D5244T5	GCI62030	Inner Joint		26	25	40	526	92.5						
	2001.08-	2007.08	MT	R	F	Estate Engine D5244T/D5244T5	GC062040	Outer Joint	48T	36	25	56.5	48	58	M					
2001.08-	2007.08	6MT/6AT			Estate Engine D5244T/D5244T5	GC062037	Outer Joint	48T	36	27	56.5	48	66	M						
2.4 D5 (136 kW)	2005.05-	2007.04	MT	L	F	Estate Engine D5244T4	GDS62029	Drive Shaft	48T	36	26	56.5	48	540						
	2005.05-	2007.04	MT	L	F	Estate Engine D5244T4	GCI62028	Inner Joint		26	25	40	67.5	94						
	2005.05-	2007.04	MT	L	F	Estate Engine D5244T4	GC062038	Outer Joint		36	25	56.5	48	58	M					
	2005.05-	2007.04	5AT	R	F	Estate Engine D5244T4	GDS62017	Drive Shaft	48T	36	26	56.5	48	978.5						
	2005.05-	2007.04	5AT	R	F	Estate Engine D5244T4	GCI62029	Inner Joint		26	26	31	513	93.5						
	2005.05-	2007.04	5AT	R	F	Estate Engine D5244T4	GC062009	Outer Joint	48T	36	27	56.5	48	66	M					
	2005.05-	2007.04	MT	R	F	Estate Engine D5244T4	GDS62028	Drive Shaft	48T	36	26	56.5	48	990						
	2005.05-	2007.04	MT	R	F	Estate Engine D5244T4	GCI62030	Inner Joint		26	25	40	526	92.5						
	2005.05-	2007.04	MT	R	F	Estate Engine D5244T4	GC062040	Outer Joint	48T	36	25	56.5	48	58	M					
	2005.05-	2007.04	6MT/6AT			Estate Engine D5244T4	GC062037	Outer Joint	48T	36	27	56.5	48	66	M					
2.4 D5 AWD (120 kW)	2003.03-	2007.08	MT/AT		F	Estate Engine D5244T/D5244T2/D5244T5	GC062009	Outer Joint	48T	36	27	56.5	48	66	M					
	2003.03-	2007.08	AT	L	F	Estate Engine D5244T/D5244T2/D5244T5	GDS62022	Drive Shaft	48T	36	26	56.5	48	527						



		YEAR	TRANSM	L/R	F/R		G-AP Ref.	PRODUCT	ABS	Technical Specifications										
										A	B	C	H	L	P					
<b>VOLVO</b> <b>V70 II (SW)</b>																				
2.4 D5 AWD (120 kW)	2003.03-	2007.08	AT	L	F	Estate Engine D5244T/D5244T2/D5244T5	GCI99109	Inner Joint		26	26	31	50	105						
	2003.03-	2007.08	AT	L	F	Estate Engine D5244T/D5244T2/D5244T5	GC062019	Outer Joint		36	27	56.5	48	66	M					
	2003.03-	2007.08	MT	L	F	Estate Engine D5244T/D5244T2/D5244T5	GDS62029	Drive Shaft	48T	36	26	56.5	48	540						
	2003.03-	2007.08	MT	L	F	Estate Engine D5244T/D5244T2/D5244T5	GCI62028	Inner Joint		26	25	40	67.5	94						
	2003.03-	2007.08	MT	L	F	Estate Engine D5244T/D5244T2/D5244T5	GC062038	Outer Joint		36	25	56.5	48	58	M					
	2003.03-	2007.08	MT	R	F	Estate Engine D5244T/D5244T2/D5244T5	GDS62031	Drive Shaft	48T	36	26	56.5	48	992						
	2003.03-	2007.08	6MT/6AT			Estate Engine D5244T/D5244T2/D5244T5	GC062037	Outer Joint	48T	36	27	56.5	48	66	M					
2.4 D5 AWD (136 kW)	2005.05-	2007.04	MT	L	F	Estate Engine D5244T4	GDS62029	Drive Shaft	48T	36	26	56.5	48	540						
	2005.05-	2007.04	MT	L	F	Estate Engine D5244T4	GCI62028	Inner Joint		26	25	40	67.5	94						
	2005.05-	2007.04	MT	L	F	Estate Engine D5244T4	GC062038	Outer Joint		36	25	56.5	48	58	M					
	2005.05-	2007.04	6MT/6AT			Estate Engine D5244T4	GC062037	Outer Joint	48T	36	27	56.5	48	66	M					
2.4 T (147 kW)	2000.03-	2007.08	MT/AT		F	Estate Engine B5244T3	GC062009	Outer Joint	48T	36	27	56.5	48	66	M					
	2000.03-	2007.08	AT	L	F	Estate Engine B5244T3	GDS62022	Drive Shaft	48T	36	26	56.5	48	527						
	2000.03-	2007.08	AT	L	F	Estate Engine B5244T3	GCI99109	Inner Joint		26	26	31	50	105						
	2000.03-	2007.08	AT	L	F	Estate Engine B5244T3	GC062019	Outer Joint		36	27	56.5	48	66	M					
	2000.03-	2007.08	MT	L	F	Estate Engine B5244T3	GDS62029	Drive Shaft	48T	36	26	56.5	48	540						
	2000.03-	2007.08	MT	L	F	Estate Engine B5244T3	GCI62028	Inner Joint		26	25	40	67.5	94						
	2000.03-	2007.08	MT	L	F	Estate Engine B5244T3	GC062038	Outer Joint		36	25	56.5	48	58	M					
	2000.03-	2007.08	MT	R	F	Estate Engine B5244T3	GDS62028	Drive Shaft	48T	36	26	56.5	48	990						
	2000.03-	2007.08	MT	R	F	Estate Engine B5244T3	GCI62030	Inner Joint		26	25	40	526	92.5						
	2000.03-	2007.08	MT	R	F	Estate Engine B5244T3	GC062040	Outer Joint	48T	36	25	56.5	48	58	M					
2.4 T AWD (147 kW)	2001.09-	2007.08	MT/AT		F	Estate Engine B5244T3	GC062009	Outer Joint	48T	36	27	56.5	48	66	M					
	2001.09-	2007.08	AT	L	F	Estate Engine B5244T3	GDS62022	Drive Shaft	48T	36	26	56.5	48	527						
	2001.09-	2007.08	AT	L	F	Estate Engine B5244T3	GCI99109	Inner Joint		26	26	31	50	105						
	2001.09-	2007.08	AT	L	F	Estate Engine B5244T3	GC062019	Outer Joint		36	27	56.5	48	66	M					
	2001.09-	2007.08	MT	L	F	Estate Engine B5244T3	GDS62029	Drive Shaft	48T	36	26	56.5	48	540						
	2001.09-	2007.08	MT	L	F	Estate Engine B5244T3	GCI62028	Inner Joint		26	25	40	67.5	94						
2.4 T5 (191 kW)	2005.05-	2007.04	MT/AT		F	Estate Engine B5244T5	GC062009	Outer Joint	48T	36	27	56.5	48	66	M					
	2005.05-	2007.04	AT	L	F	Estate Engine B5244T5	GDS62022	Drive Shaft	48T	36	26	56.5	48	527						
	2005.05-	2007.04	AT	L	F	Estate Engine B5244T5	GCI99109	Inner Joint		26	26	31	50	105						
	2005.05-	2007.04	AT	L	F	Estate Engine B5244T5	GC062019	Outer Joint		36	27	56.5	48	66	M					
	2005.05-	2007.04	MT	L	F	Estate Engine B5244T5	GDS62029	Drive Shaft	48T	36	26	56.5	48	540						
	2005.05-	2007.04	MT	L	F	Estate Engine B5244T5	GCI62028	Inner Joint		26	25	40	67.5	94						
	2005.05-	2007.04	MT	L	F	Estate Engine B5244T5	GC062038	Outer Joint		36	25	56.5	48	58	M					
	2005.05-	2007.04	MT	R	F	Estate Engine B5244T5	GDS62028	Drive Shaft	48T	36	26	56.5	48	990						
	2005.05-	2007.04	MT	R	F	Estate Engine B5244T5	GCI62030	Inner Joint		26	25	40	526	92.5						
	2005.05-	2007.04	MT	R	F	Estate Engine B5244T5	GC062040	Outer Joint	48T	36	25	56.5	48	58	M					
2.5 R Sport (221 kW)	2006.04-	2007.04	MT	L	F	Estate Engine B5254T4	GDS62029	Drive Shaft	48T	36	26	56.5	48	540						
	2006.04-	2007.04	MT	L	F	Estate Engine B5254T4	GCI62028	Inner Joint		26	25	40	67.5	94						
	2006.04-	2007.04	MT	L	F	Estate Engine B5254T4	GC062038	Outer Joint		36	25	56.5	48	58	M					
	2006.04-	2007.04	MT	R	F	Estate Engine B5254T4	GDS62028	Drive Shaft	48T	36	26	56.5	48	990						
	2006.04-	2007.04	MT	R	F	Estate Engine B5254T4	GCI62030	Inner Joint		26	25	40	526	92.5						
	2006.04-	2007.04	MT	R	F	Estate Engine B5254T4	GC062040	Outer Joint	48T	36	25	56.5	48	58	M					
2.5 T (154 kW)	2002.09-	2007.10	MT/AT		F	Estate Engine B5254T2	GC062009	Outer Joint	48T	36	27	56.5	48	66	M					
	2002.09-	2007.10	AT	L	F	Estate Engine B5254T2	GDS62022	Drive Shaft	48T	36	26	56.5	48	527						
	2002.09-	2007.10	AT	L	F	Estate Engine B5254T2	GCI99109	Inner Joint		26	26	31	50	105						
	2002.09-	2007.10	AT	L	F	Estate Engine B5254T2	GC062019	Outer Joint		36	27	56.5	48	66	M					
	2002.09-	2007.10	MT	L	F	Estate Engine B5254T2	GDS62029	Drive Shaft	48T	36	26	56.5	48	540						
	2002.09-	2007.10	MT	L	F	Estate Engine B5254T2	GCI62028	Inner Joint		26	25	40	67.5	94						
	2002.09-	2007.10	MT	L	F	Estate Engine B5254T2	GC062038	Outer Joint		36	25	56.5	48	58	M					
	2002.09-	2007.10	AT	R	F	Estate Engine B5254T2	GDS62028	Drive Shaft	48T	36	26	56.5	48	990						
	2002.09-	2007.10	AT	R	F	Estate Engine B5254T2	GCI62029	Inner Joint		26	26	31	513	93.5						
	2002.09-	2007.10	AT	R	F	Estate Engine B5254T2	GCI62030	Inner Joint		26	25	40	526	92.5						
	2002.09-	2007.10	AT	R	F	Estate Engine B5254T2	GC062009	Outer Joint	48T	36	27	56.5	48	66	M					
	2002.09-	2007.10	AT	R	F	Estate Engine B5254T2	GC062040	Outer Joint	48T	36	25	56.5	48	58	M					
	2002.09-	2007.10	MT	R	F	Estate Engine B5254T2	GDS62031	Drive Shaft	48T	36	26	56.5	48	992						
	2002.09-	2007.10	MT	R	F	Estate Engine B5254T2	GCI62028	Inner Joint		26	25	40	67.5	94						
2.5 T AWD (154 kW)	2002.09-	2007.08	MT/AT		F	Estate Engine B5254T2	GC062009	Outer Joint	48T	36	27	56.5	48	66	M					
	2002.09-	2007.08	AT	L	F	Estate Engine B5254T2	GDS62029	Drive Shaft	48T	36	26	56.5	48	540						
	2002.09-	2007.08	AT	L	F	Estate Engine B5254T2	GCI62028	Inner Joint		26	25	40	67.5	94						
	2002.09-	2007.08	AT	L	F	Estate Engine B5254T2	GCI99109	Inner Joint		26	26	31	50	105						



		YEAR	TRANSM	L/R	F/R		G-AP Ref.	PRODUCT	ABS	Technical Specifications									
										A	B	C	H	L	P				
<b>VOLVO</b>																			
<b>V70 II (SW)</b>																			
2.5 T AWD (154 kW)	2002.09-	2007.08	AT	L	F	Estate Engine B5254T2	GC062019	Outer Joint		36	27	56.5	48	66	M				
	2002.09-	2007.08	AT	L	F	Estate Engine B5254T2	GC062038	Outer Joint		36	25	56.5	48	58	M				
2.5 TDi (103 kW)	2000.03-	2007.08	MT/AT		F	Estate Engine D5252T	GC062009	Outer Joint	48T	36	27	56.5	48	66	M				
	2000.03-	2007.08	MT	L	F	Estate Engine D5252T	GDS62029	Drive Shaft	48T	36	26	56.5	48	540					
	2000.03-	2007.08	MT	L	F	Estate Engine D5252T	GCI62028	Inner Joint		26	25	40	67.5	94					
	2000.03-	2007.08	MT	L	F	Estate Engine D5252T	GC062038	Outer Joint		36	25	56.5	48	58	M				
	2000.03-	2007.08	AT	R	F	Estate Engine D5252T	GDS62017	Drive Shaft	48T	36	26	56.5	48	978.5					
	2000.03-	2007.08	AT	R	F	Estate Engine D5252T	GCI62029	Inner Joint		26	26	31	513	93.5					
	2000.03-	2007.08	AT	R	F	Estate Engine D5252T	GC062009	Outer Joint	48T	36	27	56.5	48	66	M				
	2000.03-	2007.08	MT	R	F	Estate Engine D5252T	GDS62028	Drive Shaft	48T	36	26	56.5	48	990					
	2000.03-	2007.08	MT	R	F	Estate Engine D5252T	GCI62030	Inner Joint		26	25	40	526	92.5					
	2000.03-	2007.08	MT	R	F	Estate Engine D5252T	GC062040	Outer Joint	48T	36	25	56.5	48	58	M				
	2000.03-	2007.08		R	F	Estate Engine D5252T	GDS62031	Drive Shaft	48T	36	26	56.5	48	992					
R 2.5 T AWD (221 kW)	2003.03-	2007.08	MT/AT		F	Estate Engine B5254T4	GC062009	Outer Joint	48T	36	27	56.5	48	66	M				
	2003.03-	2007.08	AT	L	F	Estate Engine B5254T4	GDS62022	Drive Shaft	48T	36	26	56.5	48	527					
	2003.03-	2007.08	AT	L	F	Estate Engine B5254T4	GCI99109	Inner Joint		26	26	31	50	105					
	2003.03-	2007.08	AT	L	F	Estate Engine B5254T4	GC062019	Outer Joint		36	27	56.5	48	66	M				
	2003.03-	2007.08	MT	L	F	Estate Engine B5254T4	GDS62029	Drive Shaft	48T	36	26	56.5	48	540					
	2003.03-	2007.08	MT	L	F	Estate Engine B5254T4	GCI62028	Inner Joint		26	25	40	67.5	94					
	2003.03-	2007.08	MT	L	F	Estate Engine B5254T4	GC062038	Outer Joint		36	25	56.5	48	58	M				
	2003.03-	2007.08	MT	R	F	Estate Engine B5254T4	GDS62028	Drive Shaft	48T	36	26	56.5	48	990					
	2003.03-	2007.08	MT	R	F	Estate Engine B5254T4	GCI62030	Inner Joint		26	25	40	526	92.5					
	2003.03-	2007.08	MT	R	F	Estate Engine B5254T4	GC062040	Outer Joint	48T	36	25	56.5	48	58	M				
<b>V70 III (BW)</b>																			
2.0 (100 kW)	2010.03-		MT	R	F	Estate Engine D5204T7	GDS99212	Drive Shaft		40	26	57.4	51	945					
	2010.03-		MT	R	F	Estate Engine D5204T7	GCI18129	Inner Joint		26	28	40	389	96.5					
	2010.03-		MT	R	F	Estate Engine D5204T7	GC099271	Outer Joint		40	28	57.4	51	63	M				
2.0 D (100 kW)	2007.10-		MT	R	F	Estate Engine D4204T	GDS99212	Drive Shaft		40	26	57.4	51	945					
	2007.10-		MT	R	F	Estate Engine D4204T	GCI18129	Inner Joint		26	28	40	389	96.5					
	2007.10-		MT	R	F	Estate Engine D4204T	GC099271	Outer Joint		40	28	57.4	51	63	M				
2.0 D3/D4 (120 kW)	2010.03-		AT	L	F	Estate Engine D5204T2/D5204T3	GDS59443	Drive Shaft		40	31	57.4	52	528					
	2010.03-		AT	R	F	Estate Engine D5204T2/D5204T3	GDS59444	Drive Shaft		40	28	57.4	52	994					
2.4 D (120 kW)	2007.08-					Estate Engine D5244T5	GC059285	Outer Joint		40	27	57.4	52	63.5	M				
2.4 D (129 kW)	2009.10-					Estate Engine D5244T14	GC059285	Outer Joint		40	27	57.4	52	63.5	M				
2.4 D5 (136 kW)	2007.08-		AT			Estate Engine D5244T4	GC059285	Outer Joint		40	27	57.4	52	63.5	M				
2.4 D5 (151 kW)	2009.12-					Estate Engine D5244T10	GC059285	Outer Joint		40	27	57.4	52	63.5	M				
2.4 D5 (158 kW)	2011.06-		AT			Estate Engine D5244T11/D5244T15	GC059285	Outer Joint		40	27	57.4	52	63.5	M				
2.4 D5 AWD (136 kW)	2007.10-		AT			Estate Engine D5244T4	GC059285	Outer Joint		40	27	57.4	52	63.5	M				
2.4 D5 AWD (151 kW)	2009.12-					Estate Engine D5244T10	GC059285	Outer Joint		40	27	57.4	52	63.5	M				
2.4 D5 AWD (158 kW)	2011.06-		AT			Estate Engine D5244T11/D5244T15	GC059285	Outer Joint		40	27	57.4	52	63.5	M				
2.5 T (147 kW)	2007.08-		AT	R	F	Estate Engine B5254T6	GDS59444	Drive Shaft		40	28	57.4	52	994					
	2007.08-		AT			Estate Engine B5254T6	GC059344	Outer Joint		40	26	57.4	52	63.5	M				
2.5 T (170 kW)	2010.01-		AT	R	F	Estate Engine B5254T10	GDS59444	Drive Shaft		40	28	57.4	52	994					
	2010.01-					Estate Engine B5254T10	GC059344	Outer Joint		40	26	57.4	52	63.5	M				
2.5 T FlexFuel (147 kW)	2008.05-		AT	R	F	Estate Engine B5254T8	GDS59444	Drive Shaft		40	28	57.4	52	994					
2.5 T FlexFuel (170 kW)	2009.10-		AT	R	F	Estate Engine B5254T11	GDS59444	Drive Shaft		40	28	57.4	52	994					
3.0 T6 AWD (210 kW)	2007.08-					Estate Engine B6304T2	GC059285	Outer Joint		40	27	57.4	52	63.5	M				
3.0 T6 AWD (224 kW)	2011.04-					Estate Engine B6304T4	GC059285	Outer Joint		40	27	57.4	52	63.5	M				
3.2 (175 kW)	2007.11-					Estate Engine B6324S	GC059285	Outer Joint		40	27	57.4	52	63.5	M				
3.2 (179 kW)	2011.05-					Estate Engine B6324S5	GC059285	Outer Joint		40	27	57.4	52	63.5	M				
3.2 AWD (175 kW)	2007.08-					Estate Engine B6324S	GC059285	Outer Joint		40	27	57.4	52	63.5	M				
3.2 AWD (179 kW)	2011.05-					Estate Engine B6324S5	GC059285	Outer Joint		40	27	57.4	52	63.5	M				
D4 AWD (120 kW)	2013.01-					Estate Engine D 5244 T17	GC059285	Outer Joint		40	27	57.4	52	63.5	M				
D4 AWD (133 kW)	2013.10-					Estate Engine D 5244 T12	GC059285	Outer Joint		40	27	57.4	52	63.5	M				
<b>XC60</b>																			
2.0 D3/D4 (120 kW)	2010.03-					Estate Engine D5204T2/D5204T3	GC059285	Outer Joint		40	27	57.4	52	63.5	M				
2.4 D AWD (129 kW)	2009.06-	2010.12				Estate Engine D 5244 T14	GC059285	Outer Joint		40	27	57.4	52	63.5	M				
2.4 D/D3/D4 AWD (120 kW)	2008.05-		MT			Estate Engine D5244T5/D5244T16/D5244T17	GC059285	Outer Joint		40	27	57.4	52	63.5	M				
2.4 D5 (158 kW)	2011.06-		MT			Estate Engine D5244T11	GC059285	Outer Joint		40	27	57.4	52	63.5	M				
2.4 D5 AWD (136 kW)	2008.05-		MT			Estate Engine D5244T4	GC059285	Outer Joint		40	27	57.4	52	63.5	M				
2.4 D5 AWD (151 kW)	2009.07-		MT			Estate Engine D5244T10	GC059285	Outer Joint		40	27	57.4	52	63.5	M				

		YEAR	TRANSM	L/R	F/R		G-AP Ref.	PRODUCT	ABS	Technical Specifications								
										A	B	C	H	L	P			
<b>VOLVO</b>																		
<b>XC60</b>																		
2.4 D5 AWD (158 kW)	2011.06-		MT			Estate Engine D5244T11/D5244T15	GC059285	Outer Joint		40	27	57.4	52	63.5	M			
<b>XC70 CROSS COUNTRY</b>																		
2.4 D5 AWD (136 kW)	2005.05-	2008.04	6MT/6AT			Estate Engine D5244T4	GC062037	Outer Joint	48T	36	27	56.5	48	66	M			
2.4 D5 XC AWD (120 kW)	2002.09-	2007.08		L	F	Estate Engine D5244T	GDS62039	Drive Shaft	48T	36	26	56.5	48	558.5				
	2002.09-	2007.08	6MT/6AT			Estate Engine D5244T	GC062037	Outer Joint	48T	36	27	56.5	48	66	M			
2.4 T XC AWD (147 kW)	2000.03-	2002.09	AT	L	F	Estate Engine B5244T3	GDS62022	Drive Shaft	48T	36	26	56.5	48	527				
	2000.03-	2002.09	AT	L	F	Estate Engine B5244T3	GCI99109	Inner Joint		26	26	31	50	105				
	2000.03-	2002.09	AT	L	F	Estate Engine B5244T3	GC062019	Outer Joint		36	27	56.5	48	66	M			
2.5 T XC AWD (154 kW)	2002.09-	2007.10		L	F	Estate Engine B5254T2	GDS62039	Drive Shaft	48T	36	26	56.5	48	558.5				
<b>XC70 II</b>																		
2.0 D3 AWD (120 kW)	2011.08-			L/R	R	Estate Engine D5204T2	GDS18364	Drive Shaft		36	26	56.5	49.5	750				
2.4 D/D4 AWD (120 kW)	2007.08-			L/R	R	Estate Engine D5244T5/D5244T16/D5244T17	GDS18364	Drive Shaft		36	26	56.5	49.5	750				
2.4 D5 AWD (136 kW)	2007.08-			L/R	R	Estate Engine D5244T4	GDS18364	Drive Shaft		36	26	56.5	49.5	750				
2.4 D5 AWD (151 kW)	2009.12-			L/R	R	Estate Engine D5244T10	GDS18364	Drive Shaft		36	26	56.5	49.5	750				
2.4 D5 AWD (158 kW)	2011.06-			L/R	R	Estate Engine D5244T11/D5244T15	GDS18364	Drive Shaft		36	26	56.5	49.5	750				
3.0 T6 AWD (210 kW)	2008.01-			L/R	R	Estate Engine B6304T2	GDS18364	Drive Shaft		36	26	56.5	49.5	750				
3.0 T6 AWD (224 kW)	2010.01-			L/R	R	Estate Engine B6304T4	GDS18364	Drive Shaft		36	26	56.5	49.5	750				
3.2 AWD (175 kW)	2007.08-			L/R	R	Estate Engine B6324S	GDS18364	Drive Shaft		36	26	56.5	49.5	750				
3.2 AWD (179 kW)	2007.08-			L/R	R	Estate Engine B6324S5	GDS18364	Drive Shaft		36	26	56.5	49.5	750				
D4 AWD (133 kW)	2013.10-			L/R	R	Estate Engine D 5244 T12	GDS18364	Drive Shaft		36	26	56.5	49.5	750				
<b>XC90</b>																		
2.4 D3/D5 (120 kW)	2009.04-		AT	L	F	Estate Engine D5244T5	GDS62046	Drive Shaft	48T	36	26	72	55	584				
	2009.04-		MT/6MT			Estate Engine D5244T5	GC062035	Outer Joint	48T	40	27	72	52	63.5	M			
	2009.04-					Estate Engine D5244T5	GC062031	Outer Joint	48T	36	27	72	55	65	M			
2.4 D5 (120 kW)	2002-					Transmission Cardanic	GCI35009	Inner Joint			20		21					
	2002.10-		AT	L	F	Estate Engine D5244T/D5244T5	GDS62046	Drive Shaft	48T	36	26	72	55	584				
	2002.10-				R	Estate Engine D5244T/D5244T5	GDS44068	Drive Shaft		36	26	56.5	50	797				
	2002.10-		MT/6MT			Estate Engine D5244T/D5244T5	GC062035	Outer Joint	48T	40	27	72	52	63.5	M			
	2002.10-					Estate Engine D5244T/D5244T5	GC062031	Outer Joint	48T	36	27	72	55	65	M			
2.4 D5 (136 kW)	2002-					Transmission Cardanic	GCI35009	Inner Joint			20		21					
	2005.05-	2007.11	AT	L	F	Estate Engine D5244T4	GDS62046	Drive Shaft	48T	36	26	72	55	584				
	2005.05-	2007.11			R	Estate Engine D5244T4	GDS44068	Drive Shaft		36	26	56.5	50	797				
	2005.05-	2007.11	MT/6MT			Estate Engine D5244T4	GC062035	Outer Joint	48T	40	27	72	52	63.5	M			
	2005.05-	2007.11				Estate Engine D5244T4	GC062031	Outer Joint	48T	36	27	72	55	65	M			
2.4 D5 (147 kW)	2011.01-		AT	L	F	Estate Engine D5244T18	GDS62046	Drive Shaft	48T	36	26	72	55	584				
	2011.01-				R	Estate Engine D5244T18	GDS44068	Drive Shaft		36	26	56.5	50	797				
	2011.01-					Estate Engine D5244T18	GC062031	Outer Joint	48T	36	27	72	55	65	M			
2.5 T (154 kW)	2002.10-				R	Estate Engine B5254T2	GDS44068	Drive Shaft		36	26	56.5	50	797				
	2002.10-					Estate Engine B5254T2	GC062031	Outer Joint	48T	36	27	72	55	65	M			
3.0 T6 (200 kW)	2002.10-				R	Estate Engine B6294T	GDS44068	Drive Shaft		36	26	56.5	50	797				
	2002.10-					Estate Engine B6294T	GC062031	Outer Joint	48T	36	27	72	55	65	M			
3.2 (175 kW)	2006.04-	2007.11			R	Estate Engine B6324S	GDS44068	Drive Shaft		36	26	56.5	50	797				
	2006.04-	2007.11				Estate Engine B6324S	GC062031	Outer Joint	48T	36	27	72	55	65	M			
	2006.04-	2007.11	AT	L	F	Estate Engine B6324S	GDS62046	Drive Shaft	48T	36	26	72	55	584				
3.2 24V AWD (175 kW)	2002.09-					Transmission Cardanic	GCI35009	Inner Joint			20		21					
3.2 AWD (179 kW)	2010.04-		AT	L	F	Estate Engine B6324S5	GDS62046	Drive Shaft	48T	36	26	72	55	584				
	2010.04-				F	Estate Engine B6324S5	GC062031	Outer Joint	48T	36	27	72	55	65	M			
	2010.04-				R	Estate Engine B6324S5	GDS44068	Drive Shaft		36	26	56.5	50	797				
4.4 V8 (232 kW)	2006.04-	2007.11	AT	L	F	Estate Engine B8444S	GDS62046	Drive Shaft	48T	36	26	72	55	584				
	2006.04-	2007.11			R	Estate Engine B8444S	GDS44068	Drive Shaft		36	26	56.5	50	797				
	2006.04-	2007.11				Estate Engine B8444S	GC062031	Outer Joint	48T	36	27	72	55	65	M			
4.4 V8 AWD (232 kW)	2002.09-					Transmission Cardanic	GCI35009	Inner Joint			20		21					
<b>ZAZ</b>																		
<b>TAVRIA (1102)</b>																		
1.1 (37 kW)	1989.01-		MT		F	Hatchback Engine MEMZ-245	GC064001	Outer Joint		22	22	42	92	66	I			
	1989.01-		MT		F	Hatchback Engine MEMZ-245	GCI54002	Inner Joint		22	22	40	60.2	94.5				
1.3 (44 kW)	1989.01-		MT		F	Hatchback Engine MEMZ-310	GC064001	Outer Joint		22	22	42	92	66	I			
	1989.01-		MT		F	Hatchback Engine MEMZ-310	GCI54002	Inner Joint		22	22	40	60.2	94.5				



COMPETITOR	G-AP Ref.	COMPETITOR	G-AP Ref.	COMPETITOR	G-AP Ref.	COMPETITOR	G-AP Ref.	COMPETITOR	G-AP Ref.
<b>GKN</b>		300984	GC023003	301289	GDS83048	301831	GDS45034	301954	GC083016
		300988	GC023004	301290	GDS83015	301832	GDS45033	301955	GC083018
305159	GDS85073	300989	GC023042	301307	GDS83050	301833	GDS45025	301956	GC083020
300636	GDS61031	300991	GC023005	301313	GDS83051	301834	GDS45004	301957	GC083017
300645	GDS85002	300992	GC081001	301320	GDS83060	301835	GDS45014	301960	GC083017
300659	GDS18128	300994	GC023006	301321	GDS83061	301836	GDS45021	301961	GC083019
300660	GDS18129	300996	GC023011	301323	GDS61119	301837	GDS45198	301962	GC083019
300669	GDS61005	300997	GC023018	301346	GDS18118	301838	GDS45167	301963	GC061003
300672	GDS48003	300998	GC023021	301347	GDS18289	301841	GDS45070	301964	GC061004
300681	GDS85001	301000	GC041060	301358	GDS18044	301842	GDS45160	301965	GC032001
300689	GDS35006	301007	GC056011	301359	GDS18039	301847	GDS45070	301966	GC017010
300690	GDS35001	301009	GC056012	301360	GDS18040	301848	GDS45008	301967	GC014012
300693	GDS85004	301012	GC056013	301374	GDS41094	301849	GDS50005	301968	GC014005
300694	GDS85007	301014	GC022001	301375	GDS41004	301850	GDS11004	301969	GC056014
300695	GDS85003	301016	GC018027	301376	GDS41001	301855	GDS50145	301970	GC057035
300745	GDS35004	301017	GC034002	301377	GDS41005	301858	GDS50030	301971	GC018019
300749	GDS35005	301018	GC061001	301378	GDS41130	301859	GDS50006	301972	GC018015
300758	GDS48001	301020	GC061013	301394	GDS41024	301861	GDS50012	301973	GC018006
300841	GC083018	301021	GC061013	301397	GDS62001	301862	GDS50013	301974	GC017006
300842	GC023017	301022	GC061002	301398	GDS62002	301865	GDS50023	301975	GC017039
300844	GC023071	301023	GC053008	301423	GDS51001	301866	GDS50025	301976	GC017001
300846	GC083034	301026	GC083009	301424	GDS51010	301867	GDS50044	301977	GC017001
300847	GC023016	301027	GC083008	301425	GDS51023	301868	GDS50201	301978	GC017039
300848	GC056004	301028	GC062001	301429	GC081020	301869	GDS50032	301979	GC017012
300849	GC061018	301030	GC028002	301430	GDS23040	301870	GDS50024	301980	GC017001
300850	GC083051	301032	GC051002	301467	GDS28001	301872	GDS50052	301981	GC022002
300853	GC083012	301041	GC017002	301468	GDS28002	301873	GDS50003	301982	GC039011
300855	GC083016	301047	GC083004	301469	GDS54002	301876	GDS50033	301983	GC039019
300856	GC083019	301048	GC083031	301470	GC0854001	301877	GDS50138	301984	GC039002
300857	GC083017	301052	GC083006	301505	GDS44002	301878	GDS50001	301985	GC039009
300861	GC061003	301056	GC052002	301506	GDS60002	301879	GDS50002	301986	GC023022
300862	GC061004	301061	GC099212	301507	GDS10278	301880	GDS50036	301987	GC041009
300866	GC017010	301062	GC052010	301508	GDS10024	301881	GDS50037	301988	GC041010
300868	GC056014	301063	GC099205	301509	GDS45023	301883	GDS50007	301989	GC041001
300869	GC018030	301064	GC044057	301510	GDS45022	301885	GDS44006	301990	GC014006
300872	GC018004	301065	GC044056	301532	GDS53003	301886	GDS50022	301991	GC056005
300874	GC022002	301069	GC034001	301533	GDS53005	301887	GDS50020	301992	GC059020
300877	GC039009	301070	GC053007	301534	GDS53004	301888	GDS50205	301993	GC034004
300878	GC059020	301075	GC083014	301535	GDS61008	301889	GDS50050	301994	GC034007
300879	GC018019	301083	GC030001	301537	GDS53003	301890	GDS50014	301995	GC034003
300881	GC018006	301084	GC030002	301538	GDS53005	301891	GDS50015	301996	GC034081
300883	GC017006	301092	GC010010	301542	GDS61054	301893	GDS50016	301997	GC017002
300884	GC017039	301095	GC059050	301547	GDS61008	301895	GDS50041	301998	GC017003
300886	GC017001	301103	GCI82001	301548	GDS53004	301899	GDS50150	302001	GC082004
300891	GC041009	301116	GCI83004	301551	GDS61172	301900	GDS50095	302002	GC082004
300893	GC041001	301117	GCI53001	301552	GDS61055	301903	GDS11001	302004	GC082015
300894	GC014006	301123	GCI44004	301553	GDS61067	301905	GDS10005	302006	GC082004
300895	GC056005	301124	GCI44001	301554	GDS61055	301906	GDS10003	302007	GC017004
300896	GC034007	301126	GCI62015	301574	GDS51004	301918	GDS10130	302008	GC017004
300898	GC034003	301129	GCI48004	301619	GDS61011	301920	GDS10039	302009	GC082004
300900	GC018021	301134	GCI83002	301620	GDS61028	301921	GDS10007	302010	GC017013
300902	GC041078	301136	GCI48004	301623	GDS61092	301922	GDS45068	302011	GC017003
300905	GC083036	301137	GCI61003	301706	GDS44014	301923	GDS10068	302012	GC039001
300906	GC017002	301141	GCI83006	301708	GDS44059	301924	GDS10034	302013	GC023013
300913	GC082004	301142	GCI18001	301709	GDS44011	301925	GDS10009	302014	GC023014
300915	GC017018	301144	GCI44002	301715	GDS53001	301926	GDS10008	302015	GC041006
300918	GC017004	301149	GCI99052	301716	GDS61006	301928	GDS10164	302016	GC041007
300919	GC082004	301169	GCI48002	301718	GDS53002	301929	GDS10004	302017	GC041008
300929	GC056003	301174	GCI48001	301722	GDS61009	301930	GDS10040	302018	GC041061
300936	GC088004	301177	GCI61001	301785	GDS45111	301932	GDS10038	302019	GC041078
300938	GC018018	301181	GCI28001	301786	GDS45111	301933	GDS10167	302020	GC041087
300945	GC041172	301209	GDS83012	301788	GDS45005	301936	GDS10090	302022	GC056003
300946	GC084001	301210	GDS99108	301789	GDS45066	301939	GC083032	302023	GC018031
300947	GC017005	301218	GDS83002	301791	GDS10117	301940	GC083034	302024	GC083036
300948	GC084001	301219	GDS83005	301793	GDS10117	301941	GC023016	302025	GC082009
300950	GC064001	301220	GDS61122	301795	GDS45013	301942	GC023016	302026	GC014003
300951	GC039040	301221	GDS99111	301796	GDS45036	301943	GC023017	302027	GC088004
300952	GC028001	301222	GDS83001	301797	GDS45030	301944	GC023026	302029	GC018018
300958	GC023010	301223	GDS83007	301798	GDS45029	301945	GC023071	302030	GC018017
300963	GC051010	301241	GDS61001	301799	GDS45003	301946	GC056004	302031	GC083022
300971	GC083007	301242	GDS61002	301801	GDS45015	301947	GC053007	302034	GC041172
300976	GC044041	301247	GDS83059	301802	GDS45001	301948	GC061018	302035	GC084001
300977	GC044055	301258	GDS83003	301803	GDS10010	301950	GC083012	302036	GC017005
300978	GC044051	301260	GDS83044	301804	GDS10044	301951	GC083051	302038	GC084001
300979	GC010001	301287	GDS61019	301829	GDS45134	301952	GC083016	302039	GC064001
300981	GC089004	301288	GDS83008	301830	GDS10177	301953	GC083016	302040	GC028001



COMPETITOR	G-AP Ref.	COMPETITOR	G-AP Ref.	COMPETITOR	G-AP Ref.	COMPETITOR	G-AP Ref.	COMPETITOR	G-AP Ref.
<b>GKN</b>		302148	GC062001	302363	GC061005	302799	GC059161	302951	GDS52002
		302149	GC083004	302366	GC014020	302800	GC059004	302961	GC083033
302041	GC054001	302150	GC083006	302374	GCI61002	302801	GC012019	302962	GC083033
302044	GC051013	302151	GC083032	302379	GDS61052	302803	GC012019	302963	GC083036
302046	GC051009	302152	GC083031	302380	GDS61034	302814	GC031001	302967	GC059009
302047	GC023010	302153	GC083029	302385	GDS44001	302816	GC044006	302969	GC027001
302049	GC023007	302155	GC083005	302386	GDS60002	302817	GDS88024	302971	GDS17038
302050	GC023008	302160	GC052004	302397	GDS18005	302818	GDS89039	302972	GDS17001
302052	GC051010	302162	GC052003	302398	GDS18016	302819	GDS88024	302977	GC018029
302054	GC018019	302164	GC052004	302399	GDS18006	302820	GDS89039	302977	GC034082
302057	GC062006	302165	GC052002	302400	GDS18002	302821	GDS88024	302978	GC018029
302058	GC062007	302166	GC099212	302403	GDS18001	302822	GDS89039	302978	GC034082
302059	GC083038	302167	GC052010	302404	GDS18003	302823	GDS89002	302980	GC057001
302060	GC083007	302168	GC099205	302405	GDS18002	302824	GDS89028	302982	GC018030
302061	GC083023	302169	GC044056	302406	GDS18004	302825	GDS89002	302983	GC089003
302065	GC044041	302170	GC044057	302420	GDS10022	302826	GDS89028	302984	GC012006
302066	GC044041	302171	GC023044	302427	GDS45017	302830	GDS18009	302985	GC012006
302067	GC044046	302172	GC023081	302428	GDS45024	302831	GDS18008	302988	GC089002
302068	GC044055	302174	GC034001	302429	GDS45153	302832	GDS18009	302989	GC089002
302069	GC044051	302175	GC053007	302435	GDS50031	302834	GDS18009	302990	GC089002
302070	GC010001	302177	GC053007	302436	GDS10113	302835	GDS18008	302995	GC010011
302073	GC089004	302181	GC083013	302437	GDS10114	302836	GDS61085	302997	GC010011
302074	GC039054	302182	GC083014	302440	GDS10025	302837	GDS61065	302998	GC010050
302075	GC089002	302183	GC083014	302441	GDS10023	302838	GDS18010	303001	GC054001
302076	GC039040	302184	GC083026	302446	GC061005	302839	GDS57040	303004	GC057003
302077	GC023003	302186	GC035018	302447	GC061006	302840	GDS57039	303042	GDS10105
302078	GC023003	302190	GC082011	302450	GC014020	302843	GDS35002	303043	GDS10069
302080	GC081002	302192	GC062002	302451	GC012034	302854	GC035001	303044	GDS10037
302081	GC023004	302193	GC083003	302452	GC017021	302856	GC018024	303045	GDS10104
302082	GC023042	302199	GC010010	302453	GC017022	302857	GC018011	303046	GDS10102
302083	GC023005	302200	GC052011	302454	GC044020	302859	GC059004	303047	GDS10103
302084	GC023005	302201	GC052007	302455	GC018021	302860	GC059161	303048	GDS10035
302085	GC081001	302203	GC083106	302456	GC082019	302861	GC044007	303049	GDS10036
302086	GC081001	302207	GCI18002	302457	GC029001	302863	GC044006	303050	GDS10067
302087	GC023021	302211	GCI82001	302458	GC023011	302865	GDS35010	303051	GDS10066
302088	GC023021	302215	GCI53001	302459	GC052001	302869	GC018012	303052	GDS10033
302089	GC023006	302225	GCI85001	302461	GC035033	302870	GC018004	303053	GDS10032
302090	GC023041	302227	GCI44004	302463	GCI83001	302871	GC018006	303054	GDS10052
302091	GC023006	302228	GCI44001	302464	GCI61002	302872	GC018012	303055	GDS10120
302093	GC023004	302229	GCI53001	302586	GC057011	302875	GCI34032	303056	GDS10082
302094	GC023021	302230	GCI83004	302592	GC034019	302877	GDS10167	303057	GDS10012
302095	GC023042	302231	GCI83004	302628	GC057007	302878	GDS10225	303058	GDS10072
302096	GC023011	302232	GCI83004	302629	GC057011	302879	GDS10193	303059	GDS10155
302097	GC041059	302238	GCI18001	302631	GC039014	302881	GDS10195	303060	GDS10016
302098	GC041060	302240	GCI48004	302634	GC034019	302884	GDS10189	303061	GDS10014
302099	GC041170	302241	GCI48004	302637	GC039027	302888	GDS50008	303064	GDS50009
302100	GC041073	302243	GCI62015	302638	GC041163	302889	GDS50105	303066	GDS50029
302102	GC056011	302246	GCI83002	302644	GCI99099	302896	GDS50171	303068	GDS50131
302104	GC056012	302247	GCI83003	302702	GCI99099	302898	GDS50215	303069	GDS50199
302106	GC056001	302248	GCI83002	302721	GCI99099	302899	GDS50047	303070	GDS50271
302107	GC056013	302249	GCI83014	302752	GC021002	302901	GDS50319	303071	GDS50099
302108	GC059001	302251	GCI48004	302753	GC026001	302903	GDS50046	303072	GDS50100
302109	GC022001	302252	GCI18070	302758	GC021001	302904	GDS50093	303073	GDS50074
302110	GC059001	302253	GCI44002	302762	GC034025	302905	GDS50035	303074	GDS50295
302111	GC018027	302254	GCI44005	302763	GC018035	302906	GDS50034	303075	GDS50296
302112	GC034002	302255	GCI61003	302764	GC053005	302907	GDS50134	303076	GDS50055
302113	GC061001	302257	GCI83011	302766	GC041083	302908	GDS50026	303078	GDS50028
302115	GC061013	302258	GCI83009	302768	GC059009	302911	GDS50461	303079	GDS50247
302117	GC061002	302260	GCI83003	302777	GC057034	302912	GDS10164	303080	GDS50130
302118	GC053008	302261	GCI83011	302778	GC021002	302914	GDS99007	303081	GDS50252
302121	GC061013	302262	GCI83009	302779	GC026001	302916	GDS10159	303084	GC018024
302122	GC061002	302266	GCI48004	302781	GC056006	302917	GDS10118	303085	GC018011
302123	GC053008	302271	GCI35006	302782	GC056030	302918	GDS10026	303091	GC041084
302124	GC061013	302273	GCI99052	302783	GC018033	302919	GDS10015	303095	GC035001
302128	GC083008	302277	GCI48004	302784	GC014013	302922	GDS45151	303096	GC010013
302129	GC083009	302282	GCI82004	302785	GC059054	302923	GDS45002	303098	GC010013
302130	GC028002	302287	GCI83001	302786	GC034025	302924	GDS45135	303099	GC010012
302132	GC051002	302297	GCI48002	302787	GC018032	302925	GDS45136	303111	GC017023
302133	GC051005	302299	GCI48001	302788	GC018035	302926	GDS45007	303112	GC082005
302134	GC051006	302303	GCI48002	302789	GC041078	302928	GDS10020	303113	GC082003
302136	GC051017	302305	GCI61001	302790	GC041083	302929	GDS10174	303114	GC082006
302137	GC051001	302307	GCI99075	302791	GC059056	302939	GDS10189	303115	GC082008
302138	GC051001	302315	GCI28001	302792	GC018028	302940	GDS10202	303116	GC017032
302141	GC017002	302317	GCI54002	302793	GC041063	302941	GC083033	303117	GC082003
302142	GC062004	302318	GCI54003	302794	GC040001	302946	GDS48002	303118	GC082006
302143	GC062005	302319	GC040001	302796	GC053005	302950	GDS52001	303120	GC027005

COMPETITOR	G-AP Ref.	COMPETITOR	G-AP Ref.	COMPETITOR	G-AP Ref.	COMPETITOR	G-AP Ref.	COMPETITOR	G-AP Ref.
<b>GKN</b>		303271	GC017042	303416	GC062008	303527	GC039021	303649	GDS17114
		303272	GC082017	303419	GC010086	303529	GC039022	303650	GDS17041
303122	GC041045	303273	GC082013	303423	GC062012	303530	GDS82001	303652	GDS17187
303126	GC041011	303274	GC017009	303426	GC062011	303531	GDS82002	303656	GDS17018
303128	GC057014	303275	GC082012	303427	GC062003	303532	GDS82003	303657	GDS17022
303141	GC099056	303277	GC059058	303430	GC010005	303533	GDS82004	303658	GDS17037
303152	GDS35003	303278	GC059058	303431	GC045004	303535	GC010006	303659	GDS17039
303153	GDS61045	303281	GC027007	303432	GC045001	303536	GC010007	303680	GDS10057
303154	GDS83046	303283	GC059017	303433	GC050008	303537	GC010021	303681	GDS10264
303155	GDS61045	303285	GC041095	303434	GC010003	303538	GC099089	303682	GDS45120
303156	GDS83046	303288	GC041021	303435	GC010004	303540	GCI35001	303687	GDS17020
303159	GDS61312	303291	GC059032	303436	GC018016	303544	GDS18140	303688	GDS17021
303161	GDS83006	303295	GC027010	303437	GC044026	303545	GDS18007	303700	GDS17015
303162	GDS83004	303304	GC041058	303438	GC044025	303546	GDS61007	303701	GDS17016
303165	GDS61004	303305	GC041040	303445	GC059024	303547	GDS61010	303738	GC057019
303167	GDS61003	303306	GC041058	303447	GC041028	303549	GDS50197	303739	GC057015
303174	GC012001	303307	GC041040	303450	GC061005	303550	GDS50043	303740	GC057037
303178	GC057001	303308	GC041013	303451	GC061006	303551	GC083035	303742	GDS50160
303179	GC057048	303310	GC041013	303455	GDS50038	303553	GDS44036	303743	GC018002
303181	GC034005	303311	GC041012	303456	GDS50320	303554	GDS44037	303745	GC039084
303183	GC034005	303313	GDS99113	303457	GDS50316	303555	GC054002	303786	GDS34044
303184	GC034006	303314	GDS83019	303458	GDS50247	303556	GC083027	303830	GC014010
303186	GC017020	303315	GDS83020	303459	GDS50211	303557	GC083024	303831	GC014046
303188	GC017017	303317	GC039015	303460	GDS50221	303560	GC062010	303832	GC014033
303189	GC017014	303318	GC059101	303461	GDS50019	303561	GC050026	303833	GC014073
303193	GC082017	303320	GC023047	303462	GDS50200	303562	GC050056	303834	GC014074
303194	GC082013	303321	GC023028	303463	GDS10030	303563	GC050105	303835	GC014027
303195	GC017009	303322	GC023028	303464	GDS10031	303565	GC010075	303836	GC014002
303196	GC082012	303323	GC059091	303465	GDS10146	303570	GDS45126	303837	GC023023
303199	GDS10043	303324	GC059091	303466	GDS10144	303571	GDS45104	303838	GC023083
303200	GDS45094	303325	GC018034	303467	GDS10001	303572	GDS45105	303839	GC023083
303202	GDS45027	303326	GC018034	303468	GDS10002	303574	GDS45119	303840	GC023024
303203	GDS45035	303330	GC099181	303469	GDS10147	303575	GDS45113	303842	GC023059
303204	GDS45031	303332	GC018013	303470	GDS45103	303576	GDS10192	303843	GC023032
303205	GDS45032	303333	GC018013	303471	GDS10181	303577	GDS10143	303848	GC034056
303206	GDS45012	303336	GC041003	303472	GDS10206	303578	GDS10142	303849	GC034080
303207	GDS45011	303337	GC041003	303473	GC045011	303579	GDS10121	303850	GC034100
303208	GDS45009	303339	GC012021	303474	GC010002	303580	GDS10140	303851	GC018029
303209	GDS45010	303342	GC044030	303475	GC010003	303581	GDS10141	303852	GC039054
303214	GDS45138	303343	GDS10161	303476	GC051011	303582	GDS10139	303857	GC041241
303215	GDS45137	303344	GDS10156	303480	GC051003	303583	GDS10207	303858	GC041031
303216	GDS45101	303345	GDS99006	303481	GC051004	303584	GDS10208	303860	GC041021
303217	GDS45016	303346	GDS99010	303482	GC099151	303587	GC059019	303861	GC041314
303218	GDS44005	303347	GDS10157	303486	GC051007	303590	GC039008	303862	GC041016
303219	GDS44004	303348	GDS10152	303487	GC023002	303592	GDS83023	303864	GC059065
303220	GDS50010	303349	GDS10048	303488	GDS45152	303604	GC041026	303865	GC059120
303221	GDS50011	303350	GDS10049	303489	GDS45020	303605	GC061012	303866	GC059006
303228	GDS50150	303351	GDS10138	303490	GDS45026	303607	GC017030	303867	GC059015
303229	GDS50151	303355	GDS35007	303491	GDS45106	303608	GC017009	303868	GC059155
303231	GDS50357	303356	GDS35008	303492	GDS99003	303609	GC082014	303869	GC024011
303233	GDS50004	303357	GDS35009	303493	GDS10162	303610	GC018007	303870	GC056039
303234	GDS50017	303358	GC044030	303494	GDS45108	303612	GDS50253	303871	GC056053
303236	GDS99150	303363	GC023063	303495	GDS44003	303613	GDS50358	303872	GC057017
303237	GDS10040	303364	GC099225	303496	GDS44013	303614	GDS50323	303873	GC057086
303238	GDS10017	303365	GC034008	303497	GDS50246	303615	GDS50039	303874	GC024004
303239	GDS10043	303366	GC034026	303498	GDS44022	303616	GDS50314	303876	GC035023
303240	GDS10203	303367	GC034010	303499	GDS50058	303617	GDS50324	303878	GC035005
303241	GDS10018	303369	GC034008	303500	GDS44017	303619	GDS50389	303880	GC035022
303242	GDS10019	303370	GC034026	303501	GDS50214	303620	GDS50325	303882	GC035004
303243	GDS10026	303371	GC034010	303502	GDS44016	303621	GDS50326	303884	GC057105
303244	GDS10027	303372	GC099042	303503	GDS44012	303622	GDS50327	303886	GC024173
303245	GDS10204	303380	GC041030	303504	GDS50249	303623	GDS50311	303888	GC044014
303246	GDS10205	303382	GC035002	303505	GDS50166	303624	GDS50043	303890	GC044013
303247	GDS10021	303384	GC018003	303506	GDS99151	303625	GDS50207	303892	GC088002
303248	GDS10165	303385	GC018003	303507	GDS50057	303626	GDS50228	303894	GC059022
303249	GDS10167	303390	GC039036	303508	GDS50059	303628	GDS50281	303896	GC059026
303250	GDS10128	303391	GC039036	303509	GC018026	303629	GDS50208	303898	GC088034
303251	GDS10023	303393	GC039016	303511	GC018025	303630	GDS50219	303900	GC088021
303252	GDS10163	303394	GC039016	303513	GDS10013	303631	GDS50226	303902	GC024002
303253	GDS10131	303400	GC045006	303514	GDS44021	303632	GDS50328	303904	GC024046
303265	GC017020	303401	GC045006	303515	GDS50060	303633	GDS50329	303906	GC012027
303266	GC017019	303403	GC010002	303521	GDS11002	303634	GDS50330	303908	GC012023
303267	GC017017	303405	GC010024	303522	GDS11003	303636	GDS50227	303910	GC012027
303268	GC017014	303407	GC010043	303523	GC039007	303637	GDS50268	303912	GC014030
303269	GC017011	303409	GC083021	303525	GC039098	303641	GDS50331	303914	GC082018
303270	GC082002	303412	GC051020	303526	GC062009	303648	GDS17025	303916	GC017031



COMPETITOR	G-AP Ref.	COMPETITOR	G-AP Ref.	COMPETITOR	G-AP Ref.	COMPETITOR	G-AP Ref.	COMPETITOR	G-AP Ref.
<b>GKN</b>		304338	GDS50440	304478	GDS85023	304593	GDS45193	304724	GDS50372
		304339	GDS99071	304479	GDS85023	304594	GDS45202	304725	GDS50516
303920	GC017028	304340	GDS99201	304480	GDS85022	304595	GDS10267	304726	GDS50354
303921	GC017026	304341	GDS99071	304481	GDS85036	304596	GC044020	304728	GC099282
303922	GDS83022	304342	GDS50441	304483	GDS85038	304598	GC017045	304729	GC041046
303923	GDS99120	304343	GDS50313	304484	GDS85039	304600	GC017060	304730	GDS10364
303924	GDS61083	304344	GDS50471	304491	GDS61084	304601	GC017055	304733	GDS50353
303925	GDS61082	304351	GDS61123	304495	GDS85029	304603	GCI17028	304734	GC023036
303927	GDS61121	304352	GDS61186	304496	GDS85018	304605	GCI17020	304735	GC083085
303928	GC010026	304353	GDS61312	304498	GDS85050	304606	GCI17042	304740	GDS85051
303930	GC045033	304356	GDS53010	304499	GDS61105	304608	GCI10038	304743	GDS62060
303931	GC045045	304364	GDS50359	304500	GDS83246	304609	GCI17022	304744	GDS62063
303933	GC099008	304365	GDS50102	304501	GDS61084	304610	GCI17021	304745	GDS99070
303934	GC044034	304366	GDS17032	304502	GDS61140	304611	GC017053	304746	GDS83294
303936	GC010025	304367	GDS17033	304504	GDS61210	304613	GC017052	304747	GDS54013
303975	GC014007	304370	GDS82005	304506	GDS61084	304615	GDS83036	304748	GDS83295
303976	GC014004	304374	GDS17190	304507	GDS45084	304616	GDS61252	304749	GDS61097
303981	GC023047	304375	GDS17191	304508	GDS45084	304617	GDS83052	304749	GDS83320
303984	GC027003	304378	GDS35037	304509	GDS45085	304618	GDS61183	304750	GDS61042
303985	GC034072	304379	GDS35038	304510	GDS45085	304620	GDS85047	304751	GDS54011
303986	GC056007	304380	GC017007	304511	GDS11012	304621	GDS85048	304752	GDS83313
303987	GC056010	304383	GC017051	304512	GDS11012	304622	GDS85017	304753	GDS61096
303988	GC018036	304384	GC044003	304513	GDS11014	304623	GC083007	304755	GDS53007
303992	GC059041	304386	GC044028	304514	GDS11014	304624	GC054004	304757	GDS83318
303993	GC061009	304388	GC044004	304515	GDS35022	304640	GC061045	304758	GDS83294
303995	GC061011	304390	GC044005	304518	GDS51068	304643	GDS99197	304759	GDS82009
303999	GC161030	304391	GC044002	304522	GDS17192	304644	GDS10312	304760	GDS61093
304004	GDS50527	304397	GC044027	304523	GDS17193	304645	GDS10313	304761	GDS83319
304005	GDS50506	304398	GDS44095	304526	GDS17054	304646	GDS10381	304762	GDS83294
304006	GDS50527	304399	GDS44075	304528	GDS61257	304647	GDS10382	304763	GDS61224
304009	GDS10070	304399	GDS44096	304529	GDS61258	304648	GDS10348	304764	GDS83265
304212	GDS99285	304400	GDS44045	304533	GDS18351	304650	GC059167	304767	GDS83266
304213	GDS38003	304401	GDS44075	304534	GDS18333	304653	GC017043	304769	GDS61094
304214	GDS85053	304404	GDS44027	304535	GDS18309	304655	GDS17082	304771	GDS61113
304215	GDS85054	304405	GDS44026	304536	GDS18326	304656	GDS17066	304773	GDS83346
304218	GDS38001	304410	GDS44038	304537	GDS18216	304657	GDS17172	304774	GDS61211
304219	GDS38002	304411	GDS44039	304538	GDS18217	304658	GDS17146	304777	GDS50442
304232	GDS18042	304414	GDS60013	304539	GDS10241	304659	GDS17147	304778	GDS50442
304233	GDS18046	304415	GDS44033	304540	GDS10242	304660	GDS17066	304779	GDS18274
304234	GDS18101	304418	GDS60013	304541	GDS10276	304663	GDS85062	304780	GDS60022
304235	GDS18102	304419	GDS60035	304542	GDS10259	304664	GDS85074	304781	GDS18271
304236	GDS18101	304420	GDS44044	304543	GC045067	304667	GDS99215	304782	GDS50497
304258	GDS50390	304424	GDS44029	304544	GDS35086	304668	GDS85078	304783	GDS18301
304259	GDS50391	304425	GDS44031	304545	GDS99213	304669	GDS99215	304786	GDS59495
304260	GDS50392	304426	GDS44028	304547	GDS83300	304670	GDS85078	304788	GDS85098
304261	GDS50393	304427	GDS44030	304549	GDS35087	304673	GDS85062	304791	GDS45157
304272	GDS18015	304428	GDS21063	304556	GCI99148	304674	GDS85074	304792	GDS45158
304273	GDS18019	304431	GDS21056	304557	GC061050	304682	GDS85042	304796	GDS99037
304274	GDS23122	304434	GDS21071	304558	GCI83027	304683	GC023030	304797	GDS41464
304275	GDS23078	304435	GDS21062	304559	GDS135051	304685	GDS10268	304798	GDS99217
304278	GDS23038	304436	GC053002	304562	GDS50446	304687	GDS50400	304799	GC010018
304279	GDS23039	304441	GDS61075	304564	GDS99186	304688	GDS50447	304800	GDS50245
304284	GDS83374	304442	GDS61074	304565	GDS50399	304689	GDS50401	304801	GDS99070
304286	GDS61115	304443	GDS83063	304568	GDS17194	304690	GDS50438	304802	GDS50400
304287	GDS61157	304444	GDS61063	304569	GDS50445	304691	GC034135	304803	GC041052
304288	GDS83362	304445	GDS61098	304570	GDS10125	304693	GC059037	304805	GDS50261
304291	GDS83057	304446	GDS61099	304571	GDS10124	304695	GC024041	304806	GDS35084
304292	GDS83058	304456	GDS51021	304572	GDS10146	304697	GC017051	304807	GDS85091
304297	GDS83363	304458	GC044011	304573	GDS10144	304699	GC023095	304809	GC041057
304300	GDS50394	304459	GC044001	304574	GDS10419	304701	GC023001	304811	GC082025
304301	GDS50194	304461	GDS50397	304576	GDS10420	304703	GC059137	304814	GC061007
304302	GDS50395	304463	GDS50437	304577	GDS10259	304704	GC038002	304816	GC010015
304303	GDS50193	304464	GDS50462	304579	GDS10266	304706	GC038003	304818	GC010015
304304	GC039024	304465	GDS50339	304580	GDS10265	304710	GDS50354	304820	GC041048
304306	GC039102	304466	GDS50398	304581	GDS10310	304711	GDS50517	304821	GC041037
304310	GC023033	304467	GDS50356	304582	GDS99190	304712	GDS50369	304823	GC059226
304312	GC099273	304468	GDS50462	304583	GDS99191	304713	GDS50562	304826	GDS61223
304313	GCI182011	304469	GDS85032	304584	GDS99272	304714	GDS50443	304827	GC059028
304322	GC059021	304470	GDS85040	304585	GDS99271	304715	GDS50554	304829	GC035026
304325	GC053001	304471	GDS85033	304586	GDS10311	304716	GDS50402	304831	GC099037
304327	GC083037	304472	GDS85034	304587	GDS99271	304717	GDS50518	304832	GCI35014
304329	GC083002	304473	GDS85038	304588	GDS45203	304718	GDS50403	304837	GCI61020
304331	GC083058	304474	GDS85039	304589	GDS45204	304719	GDS50348	304839	GCI61041
304333	GC083019	304475	GDS85038	304590	GDS45200	304721	GDS50519	304841	GCI61021
304335	GC083067	304476	GDS85039	304591	GDS45201	304722	GC041086	304843	GCI61029
304337	GDS50284	304477	GDS85022	304592	GDS45194	304723	GDS50256	304844	GDS83066



COMPETITOR	G-AP Ref.	COMPETITOR	G-AP Ref.	COMPETITOR	G-AP Ref.	COMPETITOR	G-AP Ref.	COMPETITOR	G-AP Ref.
<b>GKN</b>		305007	GC024152	305218	GDS44092	305711	GDS18259	15-1039	GC051009
		305012	GDS41453	305219	GDS44032	305712	GDS18260	15-1040	GC056012
304845	GDS50366	305021	GCI83008	305222	GDS44093	305713	GDS18435	15-1041	GC018017
304847	GDS61007	305023	GC018230	305223	GDS44094	305716	GDS18242	15-1042	GC034001
304849	GDS50207	305026	GDS50423	305224	GDS44002	305728	GDS85052	15-1043	GC041095
304850	GDS61236	305029	GDS50541	305227	GDS85107	305729	GDS85043	15-1044	GC023006
304851	GDS50460	305030	GDS50525	305233	GDS21053	305763	GC041142	15-1045	GC023021
304852	GDS50444	305031	GDS50526	305234	GDS21092	305766	GDS50383	15-1046	GC056013
304853	GDS50404	305034	GDS35037	305241	GC041047	305792	GDS35055	15-1047	GC024003
304855	GDS50520	305035	GDS18263	305252	GC059213	305805	GC035001	15-1048	GC089002
304856	GDS99188	305036	GDS18264	305254	GDS18197	305808	GC057105	15-1049	GC083038
304857	GDS50391	305037	GDS18041	305255	GDS50280	305814	GDS17053	15-1050	GC083032
304859	GDS61204	305038	GDS99042	305258	GDS50373	305815	GDS17050	15-1051	GC044056
304860	GDS50405	305039	GDS10255	305304	GC023034	305834	GC050170	15-1052	GC044057
304862	GDS50279	305040	GDS10254	305309	GC059168	305928	GDS23198	15-1053	GC023016
304868	GDS57222	305042	GDS10362	305312	GDS50416	<b>METELLI</b>		15-1053A	GC023017
304869	GDS57221	305043	GDS10251	305317	GDS50429			15-1054	GC023011
304870	GDS57223	305045	GDS10383	305319	GDS50379	15-0007	GC044041	15-1055	GC017005
304871	GDS57197	305046	GDS85039	305329	GDS41328	15-0024	GC018027	15-1056	GC044051
304873	GDS21032	305047	GDS85079	305330	GDS41327	15-0025	GC083004	15-1057	GC044055
304874	GDS21032	305048	GDS85040	305338	GDS10248	15-0028	GC041060	15-1058	GC034001
304875	GDS44080	305051	GDS44078	305339	GDS10250	15-0050	GC083032	15-1059	GC018031
304889	GDS41262	305052	GDS44079	305344	GDS18218	15-0096	GC083007	15-1060	GC041073
304890	GC041240	305053	GDS17071	305345	GDS18219	15-0112	GC083012	15-1062	GC052004
304893	GC099254	305054	GDS17070	305346	GC018067	15-0119	GC083013	15-1063	GC010009
304895	GDS50494	305055	GDS44040	305348	GDS99195	15-0146	GC034025	15-1064	GC089003
304899	GDS50405	305056	GDS44042	305349	GDS99196	15-0192	GC018004	15-1065	GC017005
304900	GC017024	305057	GDS17044	305360	GC045058	15-0195	GC083017	15-1066	GC083008
304902	GC035034	305058	GDS44079	305362	GDS50570	15-0198	GC018021	15-1067	GC017010
304904	GCI35020	305059	GDS44078	305364	GC082024	15-0200	GC018011	15-1068	GC088004
304906	GDS44020	305060	GDS44078	305366	GC082026	15-0201	GC018023	15-1069	GC034002
304907	GDS17040	305067	GDS83316	305395	GDS83373	15-0217	GC059007	15-1070	GC059001
304908	GC075007	305068	GDS83317	305400	GCI61057	15-0218	GC059064	15-1071	GC023005
304910	GDS50380	305069	GDS83310	305406	GDS10295	15-0229	GC061006	15-1072	GC023018
304911	GDS50496	305070	GDS83352	305414	GDS59493	15-0244	GC082012	15-1073	GC023044
304912	GC041025	305071	GDS83347	305418	GDS59494	15-0258	GC017042	15-1074	GC023044
304914	GC057100	305072	GDS83364	305419	GDS59552	15-0298	GC035001	15-1074A	GC023081
304923	GDS83273	305078	GDS83311	305423	GDS59553	15-0310	GC050043	15-1075	GC026001
304924	GDS83345	305091	GDS10422	305425	GDS59520	15-0351	GC059019	15-1076	GC021002
304926	GDS83321	305093	GDS10423	305432	GDS10314	15-0373	GC035002	15-1078	GC021001
304940	GDS10251	305094	GDS10424	305451	GC059085	15-0414	GC083024	15-1079	GC023004
304941	GDS10253	305098	GDS10425	305455	GC059034	15-0459	GC059117	15-1080	GC088004
304942	GDS10325	305104	GDS18358	305461	GC034110	15-0474	GC034010	15-1081	GC028001
304943	GDS10427	305105	GDS18359	305464	GC057041	15-0541	GC024041	15-1082	GC050007
304944	GDS10421	305109	GDS57078	305466	GDS18231	15-1001	GC084001	15-1083	GC082015
304945	GDS10380	305110	GDS57077	305467	GDS18232	15-1002	GC017005	15-1084	GC056004
304946	GDS10363	305112	GDS34163	305468	GDS18402	15-1003	GC017006	15-1085	GC041170
304947	GDS59316	305116	GDS18327	305469	GDS75056	15-1004	GC061001	15-1086	GC023042
304948	GDS59317	305119	GC083092	305474	GDS57165	15-1005	GC061013	15-1087	GC041105
304949	GDS59268	305126	GDS18328	305478	GDS50493	15-1007	GC044041	15-1088	GC041008
304950	GDS59447	305127	GDS18329	305483	GDS61087	15-1008	GC099205	15-1090	GC051002
304952	GC083077	305133	GC060005	305484	GDS18247	15-1009	GC053007	15-1091	GC083051
304954	GC083087	305135	GDS50544	305485	GDS18248	15-1010	GC023003	15-1092	GC018019
304956	GC083086	305136	GDS50542	305486	GDS18216	15-1011	GC023003	15-1093	GC082004
304958	GC083087	305139	GDS50538	305490	GC044090	15-1013	GC017001	15-1094	GC017003
304961	GDS50523	305140	GDS50539	305504	GDS83261	15-1014	GC018019	15-1095	GC017018
304962	GC083088	305150	GC017070	305520	GC099318	15-1015	GC010001	15-1096	GC083007
304964	GC017028	305152	GC017063	305532	GDS83025	15-1016	GC017004	15-1097	GC014012
304967	GDS50377	305154	GC099128	305535	GDS50162	15-1017	GC056011	15-1098	GC041061
304969	GDS50223	305156	GDS18194	305544	GDS50498	15-1018	GC056001	15-1099	GC081002
304970	GDS50495	305165	GDS41475	305544	GDS50415	15-1019	GC084001	15-1100	GC041060
304972	GDS50260	305168	GDS41365	305545	GDS50416	15-1020	GC010010	15-1101	GC023021
304973	GDS50263	305176	GC018203	305553	GDS35054	15-1021	GC053008	15-1102	GC050027
304983	GC099288	305184	GC044085	305560	GDS62031	15-1024	GC018027	15-1103	GC017002
304987	GDS10314	305186	GDS50514	305561	GDS62022	15-1025	GC083004	15-1104	GC039054
304988	GDS10320	305187	GDS50515	305575	GDS50540	15-1026	GC089004	15-1105	GC017001
304989	GDS10335	305193	GDS50353	305584	GDS18434	15-1027	GC041059	15-1106	GC017039
304995	GDS41451	305194	GDS50483	305585	GDS17170	15-1028	GC041060	15-1108	GC050001
304996	GDS41463	305195	GDS50411	305586	GDS17171	15-1029	GC044046	15-1109	GC017004
304997	GDS41463	305198	GC017053	305592	GDS50465	15-1030	GC022001	15-1110	GC082004
304998	GDS41409	305204	GDS44051	305601	GDS23199	15-1031	GC052004	15-1111	GC083034
305000	GDS41407	305205	GDS44052	305616	GDS61191	15-1032	GC017012	15-1112	GC083012
305001	GDS41452	305207	GDS21051	305617	GDS61190	15-1034	GC061002	15-1113	GC081001
305002	GDS41408	305210	GDS21073	305626	GDS51036	15-1035	GC083022	15-1114	GC057007
305003	GC024095	305214	GDS60027	305656	GDS50557	15-1037	GC018018	15-1115	GC012006
305005	GC027080	305215	GDS60026	305664	GDS62039	15-1038	GC051013	15-1116	GC044020

COMPETITOR	G-AP Ref.	COMPETITOR	G-AP Ref.	COMPETITOR	G-AP Ref.	COMPETITOR	G-AP Ref.	COMPETITOR	G-AP Ref.
<b>METELLI</b>		15-1194	GC041012	15-1280	GC012021	15-1369	GC062004	15-1450	GC059137
		15-1195	GC083017	15-1281	GC010019	15-1370	GC024006	15-1451	GC044002
15-1117	GC032001	15-1196	GC041040	15-1282	GC045005	15-1371	GC044008	15-1452	GC044004
15-1118	GC044007	15-1197	GC041058	15-1283	GC018012	15-1372	GC034006	15-1453	GC044026
15-1119	GC083013	15-1198	GC018021	15-1284	GC051001	15-1373	GC035002	15-1454	GC038001
15-1120	GC010013	15-1200	GC018011	15-1285	GC050011	15-1374	GC082018	15-1455	GC010028
15-1121	GC083014	15-1201	GC018023	15-1286	GC010017	15-1375	GC061012	15-1456	GC010025
15-1122	GC083009	15-1202	GC018010	15-1287	GC044030	15-1376	GC062005	15-1457	GC017043
15-1123	GC061003	15-1204	GC050008	15-1288	GC051004	15-1377	GC083020	15-1458	GC017027
15-1124	GC061004	15-1205	GC051010	15-1289	GC044049	15-1378	GC050004	15-1460	GC059026
15-1125	GC018006	15-1206	GC010005	15-1289A	GC044006	15-1380	GC057035	15-1462	GC083037
15-1127	GC083006	15-1207	GC031001	15-1290	GC044012	15-1381	GC083021	15-1463	GC083002
15-1128	GC083031	15-1208	GC010004	15-1291	GC018028	15-1382	GC045033	15-1464	GC083037
15-1129	GC041172	15-1209	GC017023	15-1292	GC045003	15-1383	GC051007	15-1465	GC053001
15-1130	GC039045	15-1210	GC082005	15-1293	GC041002	15-1384	GC034005	15-1466	GC061007
15-1131	GC023013	15-1211	GC082003	15-1294	GC014013	15-1385	GC039021	15-1467	GC083037
15-1131A	GC023014	15-1212	GC082006	15-1295	GC014005	15-1386	GC059101	15-1468	GC045052
15-1132	GC010011	15-1213	GC082019	15-1296	GC017014	15-1387	GC017030	15-1469	GC010052
15-1133	GC062001	15-1214	GC017032	15-1297	GC082002	15-1388	GC017009	15-1470	GC010051
15-1134	GC059056	15-1215	GC039040	15-1298	GC035001	15-1389	GC018026	15-1471	GC024061
15-1135	GC034004	15-1216	GC045001	15-1299	GC051018	15-1390	GC044083	15-1472	GC034008
15-1137	GC034019	15-1219	GC083005	15-1300	GC082013	15-1391	GC044060	15-1473	GC034026
15-1138	GC034007	15-1220	GC023007	15-1301	GC023024	15-1392	GC059025	15-1474	GC034010
15-1139	GC045004	15-1221	GC023010	15-1302	GC010022	15-1394	GC044001	15-1475	GC041052
15-1140	GC083016	15-1222	GC010018	15-1303	GC051003	15-1395	GC012027	15-1476	GC041141
15-1141	GC018034	15-1223	GC028002	15-1304	GC034023	15-1396	GC017026	15-1477	GC041057
15-1142	GC010043	15-1224	GC010015	15-1304A	GC034058	15-1397	GC083027	15-1478	GC061009
15-1144	GC052010	15-1225	GC017017	15-1306	GC017011	15-1398	GC027001	15-1479	GC061011
15-1145	GC027007	15-1226	GC017021	15-1307	GC044068	15-1399	GC023002	15-1480	GC038002
15-1146	GC034025	15-1227	GC017022	15-1308	GC083026	15-1400	GC044013	15-1481	GC017037
15-1147	GC039002	15-1228	GC064001	15-1309	GC017008	15-1401	GC088002	15-1483	GC059022
15-1148	GC039036	15-1229	GC061006	15-1310	GC050043	15-1402	GC012020	15-1484	GC059028
15-1149	GC057011	15-1230	GC061005	15-1311	GC012001	15-1403	GC054002	15-1485	GC059042
15-1150	GC083003	15-1231	GC017019	15-1312	GC041018	15-1404	GC039016	15-1486	GC099254
15-1151	GC056003	15-1232	GC017020	15-1315	GC041087	15-1405	GC027005	15-1487	GC052008
15-1152	GC082011	15-1233	GC018020	15-1316	GC050026	15-1406	GC024004	15-1488	GC018067
15-1153	GC082009	15-1234	GC012019	15-1317	GC050003	15-1407	GC010026	15-1489	GC018067
15-1154	GC017033	15-1235	GC088008	15-1319	GC056053	15-1408	GC051008	15-1490	GC018207
15-1155	GC017013	15-1236	GC010011	15-1321	GC041014	15-1409	GC017029	15-1492	GC039022
15-1156	GC018015	15-1239	GC083018	15-1323	GC041011	15-1410	GC017024	15-1493	GC017028
15-1157	GC034003	15-1240	GC017017	15-1324	GC041131	15-1411	GC017056	15-1494	GC017044
15-1158	GC054001	15-1241	GC083033	15-1325	GC059161	15-1412	GC044011	15-1495	GC018098
15-1159	GC014006	15-1242	GC023008	15-1326	GC059060	15-1413	GC083027	15-1496	GC010085
15-1160	GC014003	15-1244	GC082012	15-1328	GC034082	15-1414	GC083024	15-1497	GC010026
15-1161	GC039011	15-1245	GC082017	15-1329	GC039009	15-1415	GC053002	15-1498	GC010077
15-1162	GC089003	15-1247	GC056005	15-1330	GC089036	15-1416	GC017016	15-1499	GC045056
15-1163	GC041001	15-1248	GC041078	15-1331	GC039020	15-1418	GC082014	15-1501	GC099085
15-1164	GC041009	15-1249	GC041063	15-1332	GC039019	15-1419	GC017031	15-1502	GC050092
15-1165	GC041010	15-1250	GC023026	15-1333	GC014020	15-1420	GC017007	15-1503	GC050112
15-1166	GC052011	15-1251	GC023022	15-1334	GC059058	15-1422	GC050005	15-1504	GC044003
15-1167	GC099212	15-1252	GC057003	15-1335	GC034021	15-1423	GC023036	15-1505	GC044028
15-1168	GC052002	15-1253	GC059054	15-1336	GC050045	15-1424	GC023030	15-1506	GC017051
15-1169	GC052007	15-1254	GC018032	15-1337	GC023093	15-1425	GC023039	15-1506A	GC017051
15-1170	GC052003	15-1255	GC023023	15-1339	GC031001	15-1426	GC023095	15-1506B	GC017051
15-1171	GC018030	15-1256	GC034056	15-1340	GC012034	15-1427	GC023001	15-1507	GC017048
15-1172	GC041006	15-1258	GC017042	15-1341	GC099012	15-1428	GC083035	15-1508	GC041142
15-1173	GC041007	15-1259	GC045006	15-1344	GC086001	15-1429	GC018001	15-1509	GC041038
15-1174	GC083017	15-1260	GC023020	15-1346	GC059020	15-1430	GC018014	15-1510	GC099288
15-1175	GC010003	15-1261	GC018033	15-1347	GC059021	15-1431	GC051011	15-1511	GC018069
15-1176	GC010024	15-1263	GC010021	15-1348	GC041030	15-1432	GC018009	15-1513	GC059022
15-1177	GC010002	15-1264	GC010029	15-1349	GC041028	15-1434	GC035003	15-1514	GC099151
15-1179	GC010007	15-1265	GC041084	15-1351	GC059019	15-1435	GC083058	15-1515	GC045058
15-1180	GC010008	15-1266	GC057014	15-1353	GC050012	15-1436	GC083019	15-1518	GC027016
15-1181	GC083029	15-1267	GC083019	15-1354	GC018013	15-1437	GC044020	15-1519	GC099213
15-1182	GC010027	15-1268	GC018035	15-1355	GC021007	15-1438	GC089029	15-1520	GC038003
15-1183	GC082001	15-1269	GC052001	15-1356	GC089005	15-1439	GC044005	15-1522	GC050113
15-1184	GC040001	15-1270	GC051006	15-1357	GC018059	15-1440	GC017009	15-1523	GC050116
15-1185	GC083023	15-1271	GC059013	15-1358	GC017015	15-1441	GC083019	15-1525	GC034084
15-1186	GC029003	15-1272	GC062007	15-1359	GC014009	15-1442	GC041046	15-1527	GC088034
15-1187	GC041031	15-1273	GC062006	15-1360	GC057012	15-1443	GC041047	15-1528	GC099128
15-1188	GC083016	15-1274	GC056014	15-1361	GC057013	15-1444	GC018025	15-1529	GC099128
15-1189	GC083036	15-1275	GC041003	15-1364	GC018016	15-1445	GC041050	15-1530	GC088021
15-1190	GC053005	15-1276	GC041083	15-1365	GC057037	15-1446	GC010022	15-1531	GC054004
15-1191	GC039014	15-1277	GC083106	15-1366	GC051005	15-1447	GC059035	15-1533	GC061010
15-1192	GC018004	15-1278	GC034074	15-1367	GC035022	15-1448	GC029002	15-1535	GC034093
15-1193	GC041013	15-1279	GC012008	15-1368	GC062002	15-1449	GC017028	15-1536	GC059081



COMPETITOR	G-AP Ref.	COMPETITOR	G-AP Ref.	COMPETITOR	G-AP Ref.	COMPETITOR	G-AP Ref.	COMPETITOR	G-AP Ref.
<b>METELLI</b>		15-1643	GC034021	16-0008	GCI44004	17-0054	GDS50033	17-0160	GDS10033
		15-1644	GC061042	16-0019	GCI61001	17-0055	GDS50138	17-0161	GDS10032
15-1537	GC051020	15-1646	GC010026	16-0023	GCI53001	17-0056	GDS50150	17-0162	GDS18007
15-1538	GC062009	15-1647	GC041048	16-1001	GCI61003	17-0057	GDS50095	17-0163	GDS18140
15-1539	GC059037	15-1648	GC017070	16-1002	GCI18070	17-0058	GDS45023	17-0164	GDS45008
15-1540	GC057009	15-1649	GC045057	16-1002A	GCI48004	17-0059	GDS45022	17-0165	GDS45070
15-1541	GC024041	15-1650	GC050143	16-1003	GCI53001	17-0060	GDS10009	17-0166	GDS45024
15-1542	GC050069	15-1652	GC052012	16-1004	GCI83008	17-0061	GDS10008	17-0167	GDS45017
15-1543	GC024091	15-1653	GC083007	16-1005	GCI82006	17-0062	GDS45004	17-0169	GDS50063
15-1544	GC059226	15-1655	GC012011	16-1006	GCI44001	17-0063	GDS45025	17-0173	GDS35002
15-1545	GC024046	15-1656	GC088019	16-1007	GCI18002	17-0064	GDS45155	17-0174	GDS10114
15-1546	GC010015	15-1657	GC010118	16-1008	GCI44004	17-0065	GDS45156	17-0175	GDS10113
15-1547	GC099268	15-1658	GC061045	16-1010	GCI83003	17-0066	GDS45157	17-0176	GDS10190
15-1548	GC027070	15-1659	GC061050	16-1010A	GCI83009	17-0067	GDS45158	17-0177	GDS10191
15-1549	GC018105	15-1660	GC099351	16-1010B	GCI83011	17-0068	GDS45021	17-0179	GDS28001
15-1550	GC082025	15-1661	GC024090	16-1010C	GCI53002	17-0069	GDS45014	17-0180	GDS28002
15-1551	GC083078	15-1662	GC039102	16-1012	GCI83002	17-0074	GDS50001	17-0181	GDS83003
15-1552	GC083077	15-1663	GC027010	16-1014	GCI83001	17-0076	GDS44006	17-0185	GDS35003
15-1553	GC010096	15-1664	GC085009	16-1014A	GCI82004	17-0078	GDS10090	17-0186	GDS61119
15-1554	GC083067	15-1665	GC057039	16-1015	GCI82006	17-0079	GDS10167	17-0187	GDS61001
15-1555	GC044080	15-1666	GC022009	16-1016	GCI48002	17-0080	GDS10009	17-0196	GDS44003
15-1557	GC099282	15-1668	GC039024	16-1017	GCI82001	17-0081	GDS10008	17-0197	GDS83002
15-1558	GC010076	15-1669	GC018009	16-1019	GCI61001	17-0082	GDS10034	17-0198	GDS99111
15-1560	GC045057	15-1673	GC062035	16-1020	GCI82005	17-0083	GDS10013	17-0199	GDS83005
15-1561	GC010053	15-1674	GC099270	16-1022	GCI83008	17-0084	GDS10037	17-0200	GDS83001
15-1562	GC099155	15-1675	GC099366	16-1023	GCI53001	17-0085	GDS10104	17-0201	GDS61122
15-1563	GC018203	15-1677	GC018230	16-1024	GCI61002	17-0086	GDS10035	17-0202	GDS83007
15-1564	GC099129	15-1679	GC023034	16-1025	GCI82003	17-0087	GDS10036	17-0205	GDS83050
15-1565	GC018005	15-1681	GC023125	16-1026	GCI44003	17-0090	GDS18044	17-0206	GDS83051
15-1568	GC045067	15-1682	GC023094	16-1028	GCI28001	17-0092	GDS35004	17-0207	GDS61045
15-1569	GC045049	15-1684	GC023080	16-1029	GCI99025	17-0093	GDS35010	17-0208	GDS83046
15-1570	GC027072	15-1685	GC023118	16-1030	GCI35001	17-0098	GDS45111	17-0211	GDS83004
15-1572	GC099008	15-1686	GC023179	16-1031	GCI61029	17-0099	GDS45005	17-0212	GDS85014
15-1573	GC050114	15-1687	GC017063	16-1033	GCI99148	17-0100	GDS45033	17-0214	GCI85009
15-1574	GC050079	15-1688	GC083087	17-0001	GDS61005	17-0101	GDS45034	17-0214	GDS85002
15-1576	GC050041	15-1689	GC083088	17-0002	GDS53003	17-0103	GDS10159	17-0215	GDS35006
15-1579	GC050093	15-1692	GC041099	17-0003	GDS53005	17-0104	GDS10118	17-0216	GDS85021
15-1580	GC050109	15-1693	GC088047	17-0004	GDS10005	17-0106	GDS11004	17-0217	GDS10018
15-1585	GC010067	15-1697	GC083086	17-0005	GDS10003	17-0108	GDS50030	17-0218	GDS10019
15-1588	GC045038	15-1699	GC023033	17-0006	GDS10039	17-0109	GDS50024	17-0220	GDS17025
15-1590	GC099037	15-1702	GC030012	17-0007	GDS10007	17-0110	GDS50032	17-0226	GDS17038
15-1592	GC017053	15-1706	GC062010	17-0010	GDS10040	17-0111	GDS50003	17-0227	GDS17001
15-1593	GC017052	15-1708	GC061059	17-0011	GDS10004	17-0112	GDS11001	17-0245	GDS17018
15-1594	GC099018	15-1709	GC035016	17-0014	GDS10164	17-0115	GDS50009	17-0246	GDS17022
15-1595	GC082024	15-1710	GC099348	17-0016	GDS45111	17-0117	GDS50055	17-0247	GDS17037
15-1596	GC082023	15-1711	GC010155	17-0017	GDS45015	17-0119	GDS54001	17-0248	GDS17039
15-1597	GC082026	15-1713	GC044026	17-0018	GDS45001	17-0120	GDS54002	17-0249	GDS18040
15-1599	GC021030	15-1715	GC027078	17-0019	GDS10010	17-0121	GDS53004	17-0250	GDS18039
15-1600	GC041037	15-1717	GC017055	17-0020	GDS10044	17-0122	GDS61008	17-0255	GDS18016
15-1601	GC017065	15-1718	GC017060	17-0021	GDS45134	17-0123	GDS61001	17-0256	GDS18005
15-1602	GC057042	15-1720	GC045067	17-0022	GDS10177	17-0124	GDS61002	17-0257	GDS18002
15-1603	GC034015	15-1723	GC057100	17-0023	GDS10117	17-0127	GDS61007	17-0258	GDS18006
15-1604	GC035026	15-1724	GC044085	17-0025	GDS45013	17-0128	GDS61010	17-0259	GDS18001
15-1606	GC035028	15-1725	GC085010	17-0026	GDS45036	17-0130	GDS10038	17-0260	GDS18003
15-1607	GC024047	15-1726	GC017045	17-0027	GDS45030	17-0132	GDS10026	17-0261	GDS18002
15-1608	GC024038	15-1727	GC050157	17-0028	GDS45029	17-0133	GDS10015	17-0262	GDS18004
15-1610	GC034094	15-1728	GC050162	17-0029	GDS50050	17-0134	GDS10187	17-0267	GDS18008
15-1611	GC027068	15-1734	GC024033	17-0030	GDS50205	17-0135	GDS10188	17-0268	GDS35007
15-1612	GC017031	15-1736	GC024148	17-0032	GDS50022	17-0136	GDS10025	17-0272	GDS44048
15-1613	GC044027	15-1738	GC099271	17-0033	GDS50015	17-0137	GDS10023	17-0273	GDS44011
15-1614	GC057062	15-1740	GC017068	17-0034	GDS50022	17-0138	GDS10052	17-0274	GDS44059
15-1616	GC099298	15-1742	GC024036	17-0035	GDS50052	17-0139	GDS10120	17-0275	GDS44002
15-1617	GC039104	15-1757	GC024094	17-0036	GDS50025	17-0140	GDS10082	17-0276	GDS60002
15-1618	GC044065	15-1761	GC018270	17-0037	GDS50023	17-0141	GDS10012	17-0279	GDS44001
15-1628	GC039022	15-1764	GC010156	17-0038	GDS50024	17-0142	GDS10072	17-0280	GDS60002
15-1629	GC045065	15-1767	GC010124	17-0039	GDS50044	17-0143	GDS10155	17-0284	GDS45136
15-1630	GC085001	15-1777	GC018203	17-0040	GDS50005	17-0144	GDS10016	17-0285	GDS45159
15-1633	GC061042	15-1784	GC041214	17-0041	GDS50013	17-0145	GDS10014	17-0286	GDS45002
15-1634	GC041047	15-1785	GC041286	17-0042	GDS50012	17-0146	GDS10020	17-0287	GDS45135
15-1635	GC041256	15-1787	GC099318	17-0043	GDS50041	17-0147	GDS10174	17-0288	GDS45007
15-1636	GC010098	15-1788	GC018222	17-0046	GDS50016	17-0151	GDS10202	17-0292	GDS99003
15-1637	GC017070	15-1794	GC057061	17-0047	GDS50145	17-0154	GDS10189	17-0294	GDS50022
15-1639	GC039008	15-1812	GC021043	17-0048	GDS50036	17-0156	GDS10040	17-0297	GDS50093
15-1640	GC018007	15-1813	GC088066	17-0049	GDS50037	17-0157	GDS10017	17-0298	GDS50046
15-1641	GC083019	16-0001	GCI61003	17-0050	GDS50007	17-0158	GDS10067	17-0299	GDS50026
15-1642	GC062012	16-0003	GCI53001	17-0051	GDS50006	17-0159	GDS10066	17-0300	GDS50134



COMPETITOR	G-AP Ref.	COMPETITOR	G-AP Ref.	COMPETITOR	G-AP Ref.	COMPETITOR	G-AP Ref.	COMPETITOR	G-AP Ref.
<b>METELLI</b>		17-0428	GDS44004	17-0611	GDS83063	17-0782	GDS41003	17-1086	GDS54011
		17-0432	GDS50336	17-0612	GDS61063	17-0783	GDS41201	17-1136	GDS17061
17-0301	GDS50034	17-0435	GDS54001	17-0613	GDS61098	17-0786	GDS50401	17-1213	GDS10250
17-0302	GDS50053	17-0436	GDS54002	17-0614	GDS61099	17-0787	GDS50263	17-1217	GDS10248
17-0303	GDS50075	17-0443	GDS61123	17-0615	GDS53002	17-0792	GDS11012	21-0001	GDS59352
17-0306	GDS50047	17-0444	GDS61121	17-0617	GDS41094	17-0793	GDS11014	21-0002	GDS59354
17-0307	GDS50461	17-0445	GDS61045	17-0618	GDS41004	17-0799	GDS17045	<b>SPIDAN</b>	
17-0308	GDS50215	17-0446	GDS83046	17-0619	GDS41001	17-0803	GDS17060		
17-0310	GDS50175	17-0447	GDS83006	17-0620	GDS41005	17-0804	GDS17059	20020	GCI82001
17-0311	GDS50008	17-0448	GDS83004	17-0624	GDS60019	17-0809	GDS10268	20026	GC082015
17-0312	GDS50105	17-0466	GDS35037	17-0626	GDS45068	17-0816	GDS10103	20079	GC041040
17-0313	GDS50200	17-0467	GDS35038	17-0627	GDS45066	17-0834	GDS17101	20085	GC041040
17-0314	GDS50019	17-0472	GDS61075	17-0628	GDS50031	17-0835	GDS17112	20090	GCO41058
17-0315	GDS50029	17-0474	GDS61074	17-0629	GDS99190	17-0839	GDS18217	20094	GCO41058
17-0317	GDS50028	17-0486	GDS10048	17-0630	GDS99191	17-0840	GDS18263	20099	GC041012
17-0318	GDS50247	17-0487	GDS10049	17-0633	GDS41006	17-0841	GDS18264	20104	GC041013
17-0323	GDS50221	17-0488	GDS10157	17-0634	GDS41007	17-0842	GDS18041	20136	GC031001
17-0324	GDS50211	17-0489	GDS10152	17-0635	GDS17017	17-0843	GDS99042	20140	GDS88024
17-0329	GDS10141	17-0492	GDS10161	17-0636	GDS17019	17-0852	GDS44028	20141	GDS89039
17-0330	GDS10139	17-0493	GDS10156	17-0637	GDS45084	17-0853	GDS44030	20142	GDS88024
17-0331	GDS51001	17-0494	GDS99006	17-0638	GDS45085	17-0857	GDS59495	20143	GDS89039
17-0332	GDS51010	17-0495	GDS99010	17-0641	GDS10131	17-0860	GDS99071	20144	GDS88024
17-0337	GDS81020	17-0504	GDS82001	17-0642	GDS10023	17-0861	GDS50166	20145	GDS89039
17-0338	GDS23122	17-0507	GDS82002	17-0671	GDS17038	17-0862	GDS99151	20146	GDS89002
17-0339	GDS53001	17-0516	GDS10189	17-0673	GDS10057	17-0863	GDS50208	20147	GDS89028
17-0348	GDS44038	17-0519	GDS10225	17-0676	GDS35001	17-0864	GDS50226	20148	GDS89002
17-0349	GDS44039	17-0520	GDS10204	17-0689	GDS83012	17-0865	GDS50261	20149	GDS89028
17-0350	GDS44044	17-0521	GDS10027	17-0690	GDS99108	17-0866	GDS50260	20150	GDS18009
17-0352	GDS61172	17-0523	GDS10226	17-0691	GDS83019	17-0871	GDS50207	20151	GDS18008
17-0353	GDS61067	17-0524	GDS10227	17-0692	GDS83020	17-0876	GDS61223	20152	GDS18009
17-0354	GDS61054	17-0528	GDS12011	17-0693	GDS83057	17-0877	GDS83319	20154	GDS18009
17-0355	GDS61055	17-0529	GDS88059	17-0693	GDS83352	17-0881	GDS53007	20155	GDS18008
17-0358	GDS83006	17-0530	GDS12025	17-0694	GDS83058	17-0882	GDS53008	20156	GDS61085
17-0360	GDS18009	17-0531	GDS12044	17-0698	GDS85017	17-0884	GDS51101	20157	GDS61065
17-0362	GDS23040	17-0536	GDS17032	17-0699	GDS85006	17-0891	GDS44031	20158	GDS18010
17-0363	GDS23078	17-0537	GDS17033	17-0700	GDS10071	17-0896	GDS99071	20159	GDS57040
17-0372	GDS18042	17-0540	GDS18015	17-0701	GDS10070	17-0897	GDS50348	20160	GDS57039
17-0373	GDS18046	17-0542	GDS18019	17-0702	GDS45178	17-0903	GDS99070	20163	GDS35002
17-0374	GDS18101	17-0546	GDS83022	17-0703	GDS45179	17-0904	GDS50353	20176	GC035001
17-0375	GDS18102	17-0547	GDS83023	17-0706	GDS10147	17-0905	GDS50402	20178	GC059161
17-0376	GDS35016	17-0548	GDS41156	17-0707	GDS45103	17-0906	GDS50494	20179	GC059004
17-0377	GDS35011	17-0549	GDS41193	17-0708	GDS10001	17-0908	GDS50354	20180	GC059009
17-0378	GDS44013	17-0550	GDS41083	17-0709	GDS10002	17-0909	GDS50442	20181	GC044007
17-0379	GDS10043	17-0551	GDS41084	17-0718	GDS41280	17-0911	GDS82008	20183	GC044006
17-0380	GDS45094	17-0554	GDS60013	17-0719	GDS41024	17-0913	GDS44029	20184	GC039040
17-0381	GDS45027	17-0555	GDS44033	17-0720	GDS44077	17-0914	GDS85051	20186	GC018004
17-0382	GDS45035	17-0556	GDS45160	17-0723	GDS44036	17-0915	GDS85042	20187	GC018006
17-0383	GDS45031	17-0557	GDS45070	17-0724	GDS44037	17-0916	GDS99215	20188	GC018012
17-0385	GDS45032	17-0560	GDS45138	17-0726	GDS45153	17-0918	GDS50506	20193	GDS48002
17-0388	GDS10137	17-0561	GDS45137	17-0728	GDS45119	17-0919	GDS50527	20196	GDS52001
17-0389	GDS45009	17-0562	GDS45012	17-0729	GDS45113	17-0924	GDS85029	20197	GDS52001
17-0390	GDS45010	17-0563	GDS45011	17-0730	GDS45126	17-0925	GDS85018	20198	GDS52002
17-0393	GDS45101	17-0564	GDS45024	17-0731	GDS45104	17-0940	GDS83052	20208	GC082014
17-0394	GDS45016	17-0565	GDS45017	17-0732	GDS45105	17-0943	GDS83066	20228	GC035002
17-0395	GDS50150	17-0569	GDS50271	17-0733	GDS45152	17-0944	GDS99285	20232	GC041030
17-0396	GDS50151	17-0570	GDS50099	17-0734	GDS45020	17-0945	GDS38003	20257	GC083038
17-0397	GDS50004	17-0571	GDS50100	17-0735	GDS45026	17-0951	GDS10276	20258	GCI83004
17-0398	GDS50017	17-0572	GDS50074	17-0736	GDS10162	17-0952	GDS10259	20260	GC083007
17-0401	GDS50303	17-0573	GDS50295	17-0737	GDS45108	17-0956	GDS10264	20271	GC083004
17-0402	GDS50051	17-0574	GDS50296	17-0739	GDS50324	17-0957	GDS45120	20273	GCI83001
17-0403	GDS50045	17-0587	GDS50307	17-0740	GDS50389	17-0970	GDS18141	20276	GC083006
17-0404	GDS50082	17-0588	GDS50308	17-0752	GDS61028	17-0989	GDS35038	20285	GC083022
17-0405	GDS50010	17-0589	GDS50309	17-0755	GDS61003	17-1014	GDS17071	20286	GCI53001
17-0406	GDS50011	17-0591	GDS50160	17-0757	GDS61004	17-1018	GDS17044	20289	GCI83003
17-0407	GDS44005	17-0592	GDS50325	17-0759	GDS83294	17-1019	GDS44040	20294	GC083031
17-0408	GDS44004	17-0593	GDS50313	17-0760	GDS61042	17-1020	GDS99402	20295	GC083029
17-0409	GDS50010	17-0594	GDS50314	17-0761	GDS83295	17-1030	GDS50059	20300	GC045011
17-0411	GDS44005	17-0595	GDS50039	17-0762	GDS83313	17-1031	GDS50446	20302	GC023003
17-0413	GDS50197	17-0597	GDS50055	17-0763	GDS61097	17-1035	GDS50194	20303	GC023003
17-0414	GDS50043	17-0598	GDS50316	17-0764	GDS61096	17-1036	GDS50193	20304	GC081002
17-0415	GDS10030	17-0599	GDS50009	17-0766	GDS44075	17-1038	GDS50514	20305	GC023004
17-0416	GDS10031	17-0600	GDS50038	17-0769	GDS44027	17-1039	GDS50515	20306	GC023042
17-0418	GDS61006	17-0601	GDS50311	17-0770	GDS44026	17-1040	GDS50369	20307	GC023005
17-0425	GDS50010	17-0603	GDS83008	17-0775	GDS44076	17-1041	GDS50372	20308	GC023005
17-0426	GDS50011	17-0604	GDS61019	17-0780	GDS11006	17-1054	GDS59011	20309	GC081001
17-0427	GDS44005	17-0607	GDS61186	17-0781	GDS11007	17-1067	GDS50366	20310	GC081001

COMPETITOR	G-AP Ref.	COMPETITOR	G-AP Ref.	COMPETITOR	G-AP Ref.	COMPETITOR	G-AP Ref.	COMPETITOR	G-AP Ref.
<b>SPIDAN</b>		20817	GC028001	20996	GC017032	21115	GDS10040	21255	GC084001
		20819	GCI28001	20997	GC082003	21116	GDS10017	21257	GC010010
20319	GC023006	20826	GC062007	20998	GC082006	21119	GDS10043	21258	GC017006
20320	GC023006	20827	GC062004	21002	GC027005	21120	GDS10203	21284	GDS44021
20322	GC018003	20828	GC062005	21004	GC041045	21122	GDS10018	21286	GDS50060
20338	GC083033	20833	GDS62001	21006	GC041011	21123	GDS10019	21288	GC010002
20339	GC083033	20834	GDS62002	21007	GC057014	21124	GDS10026	21289	GC010003
20340	GC083036	20851	GDS51001	21010	GC099056	21125	GDS10027	21290	GC017002
20341	GDS17038	20852	GDS51010	21011	GDS35003	21126	GDS10204	21297	GC059024
20342	GDS17001	20853	GDS51023	21012	GDS61045	21127	GDS10205	21299	GC062009
20351	GC012006	20889	GC051005	21013	GDS83046	21128	GDS10021	21307	GC017002
20353	GC089002	20890	GC023010	21014	GDS61045	21129	GDS10165	21308	GC041170
20354	GC089002	20892	GC023007	21015	GDS83046	21130	GDS10167	21311	GCI48004
20357	GC050026	20893	GC023008	21018	GDS61312	21131	GDS10128	21312	GCI83002
20394	GCI48002	20894	GC051006	21020	GDS83006	21132	GDS10023	21315	GC041073
20399	GC053007	20895	GC051009	21021	GDS83004	21133	GDS10163	21327	GCI48004
20431	GC062010	20896	GC051013	21023	GDS61004	21134	GDS10131	21329	GC017001
20438	GCI83006	20899	GC051010	21025	GDS61003	21144	GC017020	21336	GC029001
20439	GCI18001	20900	GC041008	21027	GC012001	21145	GC017019	21337	GDS10161
20526	GC017001	20904	GC041060	21030	GC057001	21146	GC017017	21338	GDS10156
20527	GC017012	20914	GC051002	21031	GC057048	21147	GC017014	21339	GDS99006
20533	GC030001	20918	GC051001	21033	GC034005	21148	GC017011	21340	GDS99010
20536	GC023041	20919	GC051001	21034	GC034006	21149	GC082002	21341	GDS10157
20541	GDS85001	20920	GC051017	21036	GDS10043	21150	GC017042	21342	GDS10152
20542	GCI99052	20924	GC039036	21037	GDS45094	21151	GC082017	21343	GDS10048
20559	GC041026	20926	GC039016	21039	GDS45027	21152	GC082013	21344	GDS10049
20579	GDS83023	20928	GC062003	21040	GDS45035	21153	GC017009	21345	GDS10138
20583	GC062008	20930	GC062002	21041	GDS45031	21154	GC082012	21363	GC018007
20585	GC062012	20931	GC062001	21042	GDS45032	21155	GC059058	21368	GC034004
20587	GC062011	20934	GCI62015	21043	GDS45012	21157	GC027007	21370	GC018027
20592	GDS61119	20940	GDS10105	21044	GDS45011	21158	GC059017	21371	GC034001
20595	GC061003	20941	GDS10069	21045	GDS45009	21160	GC041095	21381	GC089004
20596	GC061004	20942	GDS10037	21046	GDS45010	21162	GC041021	21382	GC039054
20597	GCI61001	20943	GDS10104	21047	GDS45138	21164	GC059032	21385	GC023042
20600	GDS61034	20944	GDS10102	21048	GDS45137	21166	GC027010	21387	GC023004
20601	GDS61052	20945	GDS10103	21049	GDS45101	21172	GDS99113	21388	GC023021
20604	GC051020	20946	GDS10035	21050	GDS45016	21173	GDS83019	21406	GDS60002
20606	GDS10005	20947	GDS10036	21051	GDS44005	21174	GDS83020	21407	GDS44002
20607	GDS10003	20948	GDS10067	21052	GDS44004	21175	GC018034	21408	GDS44014
20621	GC039084	20949	GDS10066	21053	GDS50010	21176	GC039015	21427	GC044056
20627	GDS10024	20950	GDS10033	21054	GDS50011	21177	GC059101	21428	GC044051
20628	GDS10278	20951	GDS10032	21055	GDS50246	21178	GC023047	21429	GC044020
20631	GDS10189	20952	GDS10052	21056	GDS44022	21179	GC023028	21432	GC044046
20632	GDS10202	20953	GDS10120	21057	GDS50058	21182	GC099181	21433	GDS44011
20633	GC010011	20954	GDS10082	21058	GDS44017	21184	GC018013	21434	GDS44059
20634	GC010050	20955	GDS10012	21059	GDS50214	21186	GC059091	21438	GC099089
20636	GC018030	20956	GDS10072	21060	GDS44016	21188	GC041003	21449	GC018002
20637	GC089003	20957	GDS10155	21061	GDS50150	21189	GC012021	21450	GC044041
20639	GC054001	20958	GDS10016	21062	GDS50151	21192	GDS35007	21451	GCI44004
20649	GDS10009	20959	GDS10014	21064	GDS50357	21193	GDS35008	21452	GC044041
20650	GDS10008	20960	GDS50009	21066	GDS50004	21194	GDS35009	21455	GC099205
20651	GDS10164	20962	GDS50029	21067	GDS50017	21195	GC044030	21457	GCI44002
20653	GDS10040	20964	GDS50131	21069	GDS99150	21197	GC034008	21467	GCI44001
20654	GDS10004	20965	GDS50199	21074	GC045006	21198	GC034026	21470	GDS60002
20655	GDS10038	20966	GDS50271	21075	GC010002	21199	GC034010	21471	GDS44001
20657	GDS10113	20967	GDS50099	21076	GC010024	21200	GC099042	21476	GCI44002
20658	GDS10114	20968	GDS50100	21077	GC010043	21213	GC017005	21482	GC012019
20662	GDS10167	20969	GDS50074	21078	GC010086	21224	GC017039	21484	GC022002
20663	GDS10090	20970	GDS50295	21080	GC088004	21227	GC017018	21490	GCI48002
20665	GC010001	20971	GDS50296	21081	GC032001	21230	GC017010	21496	GC044055
20669	GDS10025	20972	GDS50055	21082	GC057035	21231	GC017039	21497	GC044057
20670	GDS10023	20974	GDS50028	21084	GCI99099	21232	GC017004	21498	GCI44005
20672	GDS10167	20975	GDS50247	21085	GCI99099	21233	GC082004	21511	GDS18016
20673	GDS10225	20976	GDS50130	21087	GC057007	21234	GC017001	21512	GDS18005
20674	GDS10193	20977	GDS50252	21088	GC057011	21235	GC017001	21513	GDS18001
20676	GDS10195	20978	GC018024	21089	GC057034	21236	GC017039	21514	GDS18003
20679	GDS10189	20979	GC018011	21090	GC057003	21237	GC017012	21518	GDS18006
20688	GDS10070	20983	GC041084	21091	GC083021	21238	GC082004	21520	GDS18004
20689	GC024004	20985	GC035001	21093	GC010005	21239	GC017004	21521	GDS18002
20698	GC028002	20986	GC010013	21094	GC045004	21240	GC017013	21522	GC083035
20712	GC044026	20987	GC010012	21095	GC045001	21241	GCI18070	21523	GDS18002
20713	GC044025	20991	GC017023	21096	GC050008	21242	GC017003	21528	GC023063
20807	GC030002	20992	GC082005	21097	GC010003	21247	GC017021	21529	GC099225
20812	GC062006	20993	GC082003	21098	GC010004	21248	GC017022	21531	GC041028
20815	GDS28001	20994	GC082006	21099	GC018016	21250	GC084001	21533	GC051011
20816	GDS28002	20995	GC082008	21105	GC084001	21252	GC017005	21537	GC051003



COMPETITOR	G-AP Ref.	COMPETITOR	G-AP Ref.	COMPETITOR	G-AP Ref.	COMPETITOR	G-AP Ref.	COMPETITOR	G-AP Ref.
<b>SPIDAN</b>		21664	GDS45198	21965	GDS10143	22184	GC056030	22458	GC083032
		21665	GDS45134	21966	GDS10142	22185	GC056006	22461	GC053008
21538	GC051004	21666	GDS10177	21967	GDS10121	22197	GC012027	22462	GDS53004
21539	GC099151	21669	GDS45160	21968	GDS10140	22199	GC014030	22463	GDS61008
21543	GC051007	21670	GDS45070	21969	GDS10141	22203	GC082018	22466	GDS53003
21544	GC023002	21671	GDS45008	21970	GDS10139	22208	GC017031	22467	GDS53005
21545	GDS11002	21672	GDS45070	21971	GDS10207	22212	GC017009	22469	GC061002
21546	GDS11003	21673	GDS10022	21972	GDS10208	22213	GC017030	22477	GDS61005
21549	GDS44012	21683	GDS45024	21975	GC024002	22251	GC017028	22487	GCI83002
21550	GDS50249	21684	GDS45017	21977	GC024046	22252	GC017026	22494	GC053007
21551	GDS50166	21686	GDS45153	21989	GCI85001	22253	GDS83022	22495	GDS53001
21552	GDS99151	21690	GDS45136	21998	GDS85002	22254	GDS99120	22497	GCI83011
21553	GDS50057	21691	GDS45151	22000	GDS85007	22255	GDS61083	22498	GCI83009
21554	GDS50059	21692	GDS45002	22006	GDS50005	22256	GDS61082	22502	GDS83059
21561	GCI18001	21693	GDS45135	22007	GDS11004	22258	GC035023	22522	GCI83002
21564	GDS50038	21694	GDS45136	22018	GDS50016	22260	GC035005	22538	GDS83003
21565	GDS50320	21695	GDS45007	22026	GDS50030	22262	GC035022	22541	GC083016
21566	GDS50316	21697	GDS10020	22028	GDS50006	22264	GC035004	22542	GC083023
21567	GDS50247	21698	GDS10174	22031	GDS50013	22267	GDS61121	22543	GC083008
21568	GDS50211	21706	GDS18140	22033	GDS50012	22268	GC010026	22544	GC083009
21569	GDS50221	21707	GDS18007	22042	GDS50025	22270	GC045033	22545	GCI83003
21570	GDS50019	21708	GDS61007	22043	GDS50023	22271	GC045045	22546	GC083032
21571	GDS50200	21709	GDS61010	22044	GDS50201	22273	GC099008	22547	GC083034
21572	GC018026	21711	GDS50197	22045	GDS50044	22274	GC044034	22550	GC083012
21574	GC018025	21718	GC039007	22046	GDS50024	22276	GC010025	22551	GC083051
21576	GDS82001	21720	GC039098	22047	GDS50032	22305	GC059001	22552	GC083016
21577	GDS82002	21721	GDS50043	22050	GDS50052	22306	GC022001	22560	GC083013
21578	GDS82003	21727	GCI35001	22055	GDS50003	22307	GC059001	22566	GC083014
21579	GDS82004	21729	GDS45126	22063	GDS50138	22310	GC059050	22568	GC083106
21580	GC010006	21730	GDS45104	22064	GDS50033	22311	GC059020	22572	GC083005
21581	GC010007	21731	GDS45105	22065	GDS11001	22312	GC059054	22581	GC083014
21582	GC010021	21733	GDS45119	22067	GDS50041	22313	GC059056	22589	GDS83050
21583	GDS44036	21734	GDS45113	22068	GDS50002	22314	GDS50253	22590	GDS83051
21584	GDS44037	21747	GC039022	22069	GDS50001	22315	GDS50358	22591	GC083017
21585	GC054002	21751	GC018018	22070	GDS50037	22316	GDS50323	22600	GC061018
21586	GC083027	21752	GCI18002	22071	GDS50036	22317	GDS50039	22618	GDS83061
21587	GC083024	21753	GC018019	22074	GDS50007	22318	GDS50314	22619	GDS83060
21590	GC050056	21759	GC039021	22077	GDS44006	22319	GDS50324	22622	GDS61009
21591	GC050105	21760	GC018019	22082	GDS50022	22321	GDS50389	22625	GDS61172
21593	GC010075	21761	GCI99075	22083	GDS50014	22322	GDS50325	22626	GDS61055
21598	GDS50527	21765	GC059019	22084	GDS50020	22323	GDS50326	22627	GC083036
21599	GDS50506	21781	GDS18128	22085	GDS50050	22324	GDS50327	22628	GDS61067
21600	GDS50527	21790	GC039008	22086	GDS50205	22325	GDS50311	22630	GDS61055
21605	GDS10130	21799	GDS18129	22088	GDS50015	22326	GDS50043	22632	GCI83014
21611	GDS45111	21800	GC044013	22089	GDS50150	22327	GDS50207	22639	GC083017
21613	GDS45005	21802	GC024173	22090	GDS50095	22328	GDS50228	22669	GC053008
21615	GDS10039	21808	GDS48003	22109	GC052004	22331	GDS50208	22670	GC061013
21616	GDS10007	21812	GC061012	22111	GDS10030	22333	GDS50226	22676	GDS83048
21617	GDS45068	21822	GC044014	22112	GDS10031	22334	GDS50328	22679	GDS83012
21618	GDS45066	21824	GC088002	22113	GDS10146	22335	GDS50329	22681	GC083018
21620	GDS10117	21843	GC059022	22114	GDS10144	22336	GDS50330	22682	GDS99111
21622	GDS10117	21845	GC059026	22115	GDS10001	22338	GDS50227	22683	GDS83002
21626	GDS45036	21847	GC088034	22116	GDS10002	22339	GDS50268	22684	GDS83001
21627	GDS45013	21850	GCI48001	22117	GDS10147	22343	GDS50331	22685	GDS83005
21628	GDS45029	21865	GC088021	22118	GC045103	22348	GC023011	22686	GDS61019
21629	GDS45030	21882	GCI48001	22119	GDS10181	22349	GC023017	22687	GDS83008
21631	GDS45003	21888	GCI48004	22120	GDS10206	22350	GC023026	22688	GDS83007
21635	GDS45001	21894	GDS48001	22125	GDS50215	22351	GC023071	22689	GDS61122
21636	GDS45015	21896	GCI48004	22126	GDS50047	22352	GC023014	22690	GC035018
21637	GDS45001	21897	GCI48002	22128	GDS50319	22353	GC023022	22695	GDS35001
21637	GDS10044	21906	GC052003	22131	GDS50031	22354	GC023016	22697	GDS35005
21638	GDS45015	21907	GC052004	22132	GDS50046	22355	GC023013	22701	GCI35006
21638	GDS10010	21909	GC052010	22133	GDS50093	22356	GC023044	22702	GDS35004
21641	GDS45022	21945	GC061005	22134	GDS50035	22360	GC023011	22704	GDS35006
21642	GDS45023	21946	GC061006	22135	GDS50034	22365	GC023016	22711	GC035033
21644	GDS10013	21947	GC012027	22136	GDS50134	22405	GCI83004	22716	GDS35010
21647	GDS10068	21955	GDS45152	22137	GDS50026	22407	GCI61003	22747	GC083020
21648	GDS10034	21956	GDS45020	22147	GDS50461	22419	GDS61031	22748	GC083026
21649	GC034007	21957	GDS45026	22151	GC056011	22428	GDS61006	22763	GC083019
21655	GDS45034	21958	GDS45106	22154	GC056012	22435	GDS61054	22773	GC083007
21656	GDS45033	21959	GDS99003	22162	GC056001	22437	GDS53002	22778	GC083004
21659	GDS45004	21960	GDS10162	22166	GC056013	22452	GC061002	22782	GC053008
21660	GDS45025	21961	GDS45108	22174	GC056014	22454	GC061001	22793	GCI83004
21661	GDS45021	21962	GDS44003	22175	GC056004	22455	GCI53001	22804	GC083019
21662	GDS45014	21963	GDS44013	22177	GC056005	22456	GC061013	22838	GDS17025
21663	GDS45167	21964	GDS10192	22179	GC056003	22457	GC061013	22839	GDS17114



COMPETITOR	G-AP Ref.	COMPETITOR	G-AP Ref.	COMPETITOR	G-AP Ref.	COMPETITOR	G-AP Ref.	COMPETITOR	G-AP Ref.
<b>SPIDAN</b>		23542	GDS53004	23940	GC014027	24116	GDS50437	24256	GDS10420
		23544	GDS61001	23941	GC014002	24117	GDS50462	24257	GDS10259
22840	GDS17041	23547	GDS61002	23942	GC023023	24118	GDS50339	24259	GDS10266
22842	GDS17187	23548	GC053007	23943	GC023083	24119	GDS50398	24260	GDS10265
22846	GDS17018	23564	GDS85004	23944	GC023083	24120	GDS50356	24261	GDS10310
22847	GDS17022	23568	GDS85003	23945	GC023024	24122	GDS85032	24262	GDS99190
22848	GDS17037	23589	GDS23039	23947	GC023059	24123	GDS85040	24263	GDS99191
22849	GDS17039	23607	GDS18039	23948	GC023032	24124	GDS85033	24268	GDS99272
22870	GDS10057	23608	GDS83374	23954	GC034080	24125	GDS85034	24269	GDS99271
22871	GDS10264	23610	GC018021	23955	GC034100	24126	GDS85038	24270	GDS10311
22872	GDS45120	23614	GDS61115	23956	GC018029	24127	GDS85039	24271	GDS99271
22877	GDS17020	23616	GDS83008	23957	GC039054	24128	GDS85038	24272	GDS45203
22878	GDS17021	23619	GDS18040	23962	GC041241	24129	GDS85039	24273	GDS45204
22890	GDS17015	23621	GDS18044	23963	GC041031	24130	GDS85022	24274	GDS45200
22891	GDS17016	23626	GCI61030	23965	GC041021	24131	GDS85023	24275	GDS45201
22900	GC061005	23628	GDS83057	23966	GC041314	24132	GDS85023	24276	GDS45194
22901	GC061006	23629	GDS83058	23967	GC041016	24133	GDS85022	24277	GDS45193
22902	GCI61002	23639	GC052001	23969	GC059065	24134	GDS85036	24278	GDS45202
22928	GDS50160	23656	GC099212	23970	GC059120	24136	GDS85038	24279	GDS10267
22930	GDS61028	23657	GC052002	23971	GC059006	24137	GDS85039	24280	GC044020
22931	GDS61011	23658	GC052011	23972	GC059015	24144	GDS61084	24282	GC017045
22934	GC057019	23659	GC052007	23973	GC059155	24148	GDS85029	24284	GC017060
22935	GC057015	23663	GDS50394	23974	GC024011	24149	GDS85018	24285	GC017055
22936	GC057037	23664	GDS50194	23975	GC056039	24151	GDS85050	24287	GCI17028
22956	GC014007	23665	GDS50395	23976	GC056053	24152	GDS61105	24289	GCI17020
22957	GC014004	23666	GDS50193	23977	GC057017	24153	GDS83246	24290	GCI17042
22962	GC023047	23667	GC039024	23978	GC057086	24155	GDS61140	24292	GCI10038
22965	GC027003	23669	GC039102	23979	GC061009	24157	GDS61210	24293	GCI17022
22966	GC034072	23673	GC023033	23981	GC061011	24160	GDS45084	24294	GCI17021
22967	GC056007	23675	GC053005	23984	GC017051	24161	GDS45084	24295	GC017053
22968	GC056010	23677	GCI82011	23985	GC044003	24162	GDS45085	24297	GC017052
22969	GC018036	23683	GC059021	23987	GC044028	24163	GDS45085	24299	GDS83036
22973	GC059041	23687	GC053001	23989	GC044004	24164	GDS11012	24301	GDS83052
22996	GC040001	23689	GC083037	23991	GC044005	24165	GDS11012	24302	GDS61183
23077	GC034003	23691	GC083002	23992	GC044002	24166	GDS11014	24304	GDS85047
23150	GDS54001	23693	GC083058	23997	GC044027	24167	GDS11014	24305	GDS85048
23151	GDS54002	23695	GC083019	23999	GDS44095	24168	GDS35022	24306	GDS85017
23152	GC054001	23697	GC083067	24000	GDS44075	24171	GDS51068	24307	GC083007
23154	GCI54002	23699	GDS50284	24000	GDS44096	24175	GDS17192	24308	GC054004
23155	GCI54003	23726	GDS18118	24007	GC018031	24176	GDS17193	24324	GDS50390
23159	GC064001	23728	GDS18289	24008	GC034081	24181	GDS61257	24325	GDS50391
23162	GC040001	23734	GC018017	24040	GC034019	24182	GDS61258	24326	GC061045
23200	GC021002	23735	GC018015	24044	GC018028	24186	GDS18351	24329	GDS99197
23201	GC026001	23736	GC018006	24045	GC034025	24187	GDS18333	24330	GDS10312
23277	GDS99285	23738	GC018004	24046	GC018032	24188	GDS18309	24331	GDS10313
23279	GDS85053	23739	GDS50440	24047	GC018035	24189	GDS18326	24332	GDS10381
23280	GDS85054	23740	GDS99071	24048	GC018033	24190	GDS18216	24333	GDS10382
23284	GDS38001	23741	GDS99201	24049	GC027001	24191	GDS18217	24334	GDS10348
23285	GDS38002	23742	GDS99071	24051	GC018029	24192	GDS10241	24341	GC017043
23298	GDS18042	23743	GDS50441	24052	GDS44045	24193	GDS10242	24343	GDS17082
23299	GDS18046	23744	GDS50313	24053	GDS44075	24194	GDS10276	24344	GDS17066
23300	GDS18101	23769	GDS61123	24056	GDS44027	24195	GDS10259	24346	GDS17146
23301	GDS18102	23770	GDS61186	24057	GDS44026	24196	GC045067	24347	GDS17147
23326	GDS50392	23771	GDS61312	24062	GDS44038	24200	GDS83300	24348	GDS17066
23327	GDS50393	23774	GDS53010	24063	GDS44039	24210	GC089002	24351	GDS85062
23338	GDS50008	23782	GDS50359	24066	GDS60013	24212	GC039011	24352	GDS85074
23339	GDS50105	23783	GDS50102	24068	GDS44033	24213	GC039001	24355	GDS99215
23346	GDS10164	23784	GDS17032	24072	GDS60035	24214	GC039019	24356	GDS85078
23348	GDS99007	23785	GDS17033	24073	GDS44044	24215	GC039002	24361	GDS85062
23350	GDS10159	23788	GDS82005	24077	GDS44029	24216	GC039009	24362	GDS85074
23351	GDS10118	23792	GDS17190	24078	GDS44031	24225	GC039014	24370	GDS85042
23352	GDS10026	23793	GDS17191	24079	GDS44028	24226	GC039027	24371	GC023030
23353	GDS10015	23796	GDS35037	24080	GDS44030	24236	GCI99148	24373	GDS10268
23356	GDS18015	23798	GC017007	24081	GDS21063	24237	GC061050	24375	GDS50400
23357	GDS18019	23830	GC082004	24084	GDS21056	24238	GCI83027	24376	GDS50447
23358	GDS23122	23831	GC082011	24087	GDS21071	24239	GCI35051	24377	GDS50401
23359	GDS23078	23838	GC082004	24088	GDS21062	24242	GDS50446	24378	GDS50438
23362	GDS23038	23839	GC082009	24089	GC053002	24244	GDS99186	24379	GC034135
23366	GDS50171	23844	GC082019	24094	GDS61075	24245	GDS50399	24381	GC059037
23506	GC034002	23845	GCI83001	24096	GDS83063	24248	GDS17194	24383	GC024041
23516	GDS61092	23891	GDS34044	24097	GDS61063	24249	GDS50445	24385	GC017051
23519	GC017002	23935	GC014010	24099	GDS61099	24250	GDS10125	24387	GC023095
23521	GCI82004	23936	GC014046	24109	GDS51021	24251	GDS10124	24389	GC023001
23522	GCI48004	23937	GC014033	24111	GC044011	24252	GDS10146	24391	GC059137
23537	GC061013	23938	GC014073	24112	GC044001	24253	GDS10144	24392	GC038002
23541	GDS61008	23939	GC014074	24114	GDS50397	24254	GDS10419	24394	GC038003

COMPETITOR	G-AP Ref.	COMPETITOR	G-AP Ref.	COMPETITOR	G-AP Ref.	COMPETITOR	G-AP Ref.	COMPETITOR	G-AP Ref.
<b>SPIDAN</b>		24524	GDS41464	24681	GC083077	24851	GDS57077	25195	GDS59494
		24525	GDS99217	24683	GC083087	24853	GDS34163	25196	GDS59552
24398	GDS50354	24526	GC010018	24685	GC083086	24857	GDS18327	25200	GDS59553
24399	GDS50517	24527	GDS50245	24687	GC083087	24860	GC083092	25202	GDS59520
24400	GDS50369	24528	GDS99070	24690	GDS50523	24867	GDS18328	25209	GDS10314
24409	GC041061	24529	GDS50400	24691	GC083088	24868	GDS18329	25228	GC059085
24410	GDS41004	24530	GC041052	24693	GC017028	24874	GC060005	25232	GC059034
24411	GDS41094	24532	GDS50261	24696	GDS50377	24876	GDS50544	25238	GC034110
24414	GDS41005	24533	GDS35084	24697	GDS50223	24877	GDS50542	25241	GC057041
24415	GDS41001	24534	GDS85091	24698	GDS50495	24880	GDS50538	25243	GDS18231
24416	GDS41130	24536	GC041057	24700	GDS50260	24881	GDS50539	25244	GDS18232
24426	GDS41024	24538	GC082025	24701	GDS50263	24891	GC017070	25245	GDS18402
24428	GC041009	24541	GC061007	24711	GC099288	24893	GC017063	25246	GDS75056
24429	GC041010	24543	GC010015	24715	GDS10314	24895	GC099128	25251	GDS57165
24430	GC041006	24545	GC010015	24716	GDS10320	24897	GDS18194	25255	GDS50493
24431	GC041007	24547	GC041048	24717	GDS10335	24910	GC083018	25260	GDS61087
24432	GC041001	24548	GC041037	24721	GDS99228	24911	GC061018	25261	GDS18247
24433	GC041172	24550	GC059226	24722	GDS99229	24912	GC083019	25262	GDS18248
24434	GC041078	24553	GDS61223	24724	GDS41463	24913	GC044041	25263	GDS18216
24435	GC041087	24554	GC059028	24725	GDS41463	24914	GC010001	25297	GC099318
24437	GC041163	24556	GC035026	24726	GDS41409	24915	GCI161003	25308	GDS54013
24438	GC041083	24558	GC099037	24728	GDS41407	24917	GC083021	25309	GDS83025
24439	GC041078	24559	GCI35014	24729	GDS41452	24919	GDS41365	25312	GDS50162
24440	GC041063	24564	GCI161020	24730	GDS41408	24927	GC018203	25321	GDS50498
24442	GDS50443	24566	GCI161041	24731	GC024095	24935	GC044085	25330	GDS35054
24443	GDS50554	24568	GCI161021	24733	GC027080	24937	GDS50514	25337	GDS62031
24444	GDS50402	24570	GCI161029	24735	GC024152	24938	GDS50515	25338	GDS62022
24445	GDS50518	24571	GDS83066	24740	GDS41453	24944	GDS50353	25352	GDS50540
24446	GDS50403	24572	GDS50366	24749	GCI83008	24945	GDS50483	25361	GDS18434
24447	GDS50348	24574	GDS61007	24751	GC018230	24946	GDS50411	25369	GDS50465
24449	GDS50519	24576	GDS50207	24754	GDS50423	24949	GC017053	25378	GDS23199
24450	GC041086	24577	GDS61236	24757	GDS50541	24955	GDS44051	25393	GDS61191
24451	GDS50256	24578	GDS50460	24758	GDS50525	24956	GDS44052	25394	GDS61190
24452	GDS50372	24579	GDS50444	24759	GDS50526	24958	GDS21051	25403	GDS51036
24453	GDS50516	24580	GDS50404	24762	GDS35037	24961	GDS21073	25433	GDS50557
24455	GC099282	24582	GDS50520	24763	GDS18263	24965	GDS60027	25488	GDS18259
24456	GC041046	24583	GDS99188	24764	GDS18264	24966	GDS60026	25489	GDS18260
24457	GDS10364	24584	GDS50391	24765	GDS18041	24969	GDS44092	25490	GDS18435
24460	GDS50353	24586	GDS61204	24766	GDS99042	24970	GDS44032	25493	GDS18242
24461	GC023036	24587	GDS50405	24767	GDS10255	24973	GDS44093	25534	GDS85052
24462	GC083085	24589	GDS50279	24768	GDS10254	24974	GDS44094	25535	GDS85043
24467	GDS85051	24595	GDS57222	24770	GDS10362	24975	GDS44002	25569	GC041142
24470	GDS62060	24596	GDS57221	24771	GDS10251	24978	GDS85107	25573	GDS50383
24471	GDS62063	24597	GDS57223	24773	GDS10383	24984	GDS21053	25599	GDS35055
24472	GDS99070	24598	GDS57197	24774	GDS85039	24985	GDS21092	25611	GC035001
24473	GDS83294	24600	GDS21032	24775	GDS85079	24992	GC041047	25614	GC057105
24474	GDS54013	24603	GDS21032	24776	GDS85040	25009	GC059213	25640	GC050170
24475	GDS83295	24604	GDS44080	24779	GDS44078	25011	GDS18197	25734	GDS23198
24476	GDS61097	24618	GDS41262	24780	GDS44079	25012	GDS50280	28081	GDS35040
24477	GDS61042	24619	GC041240	24781	GDS17071	25015	GDS50373	28082	GDS16021
24478	GDS54011	24622	GC099254	24782	GDS17070	25076	GC034015		
24479	GDS83313	24624	GDS50494	24783	GDS44040	25079	GC023039		
24482	GDS53007	24629	GC017024	24784	GDS44042	25080	GC023034	00003272X3	GDS10020
24484	GDS83318	24631	GC035034	24785	GDS17044	25084	GC059137	000032730A	GDS10186
24485	GDS83294	24633	GCI35020	24786	GDS44079	25085	GC059136	0003300036	GC035001
24486	GDS82009	24635	GDS44020	24787	GDS44078	25086	GC059168	0003301585	GC035001
24487	GDS61093	24636	GDS17040	24788	GDS44078	25094	GDS50429	0003301885	GC035002
24488	GDS83319	24637	GC075007	24795	GDS83316	25096	GDS50379	0046307241	GC017042
24489	GDS83294	24639	GDS50380	24796	GDS83317	25106	GDS41328	0046307398	GC017042
24490	GDS61224	24640	GDS50496	24797	GDS83310	25107	GDS41327	0060515370	GC017042
24491	GDS83265	24641	GC041025	24798	GDS83352	25115	GDS10248	0060815227	GC017042
24494	GDS83266	24643	GC057100	24804	GC014003	25116	GDS10250	0060815370	GC017042
24496	GDS61094	24652	GDS83273	24805	GC014006	25121	GDS18218	02N409344E	GDS61193
24498	GDS61113	24653	GDS83345	24806	GC014012	25122	GDS18219	02N409345	GDS61192
24501	GDS61211	24655	GDS83321	24807	GC014005	25123	GC018067	02Z409345B	GDS61190
24504	GDS50442	24669	GDS10251	24810	GC014020	25125	GDS99195	0374002	GC044030
24505	GDS50442	24670	GDS10253	24811	GC012034	25126	GDS99196	0374003	GC044049
24506	GDS18274	24671	GDS10325	24813	GC014013	25135	GC018207	0374013	GCI44004
24507	GDS60022	24672	GDS10427	24819	GDS83311	25137	GC045058	0374015	GC044057
24508	GDS18271	24673	GDS10421	24832	GDS10422	25139	GDS50570	0374027	GCI44004
24509	GDS50497	24674	GDS10380	24834	GDS10423	25141	GC082024	0374049	GC099205
24510	GDS18301	24675	GDS10363	24835	GDS10424	25143	GC082026	0374053	GC044013
24513	GDS59495	24676	GDS59316	24839	GDS10425	25172	GDS83373	0374061	GC099205
24515	GDS85098	24677	GDS59317	24845	GDS18358	25177	GCI161057	0374066	GC044041
24518	GDS45157	24678	GDS59268	24846	GDS18359	25183	GDS10295	0374077	GC044046
24519	GDS45158	24679	GDS59447	24850	GDS57078	25191	GDS59493	0374092	GC044046
								<b>OE</b>	



COMPETITOR	G-AP Ref.	COMPETITOR	G-AP Ref.	COMPETITOR	G-AP Ref.	COMPETITOR	G-AP Ref.	COMPETITOR	G-AP Ref.
<b>OE</b>		OK2N225400	GC027004	1097318	GDS18009	13149834	GDS17070	1355333080	GCI17021
		OK2N225600	GC027004	1097319	GDS18010	13150502	GDS44040	1355334080	GCI17022
0374099	GCI44001	OK2N225600	GC027032	1097321	GDS18009	13150503	GDS44042	1355334080	GCO17060
0374100	GCI44001	OK2N42540X	GC027004	1097322	GDS18009	13159533	GDS44092	1357488080	GCO17060
0374118	GCI44002	OK2N42560X	GDS27011	111102215012	GC099012	13159534	GDS44093	1357488080	GCI17022
0374126	GC044057	OK2N42560X	GC027004	11112215012	GC099012	13166587	GDS21032	1359342	GDS18217
0374130	GCI44005	OK2N42560X	GC027032	1111900	GC018025	13166588	GDS21092	1359345	GDS18216
0374147	GC044055	OK2NC22510A	GC027032	1117155	GC018016	13166589	GDS21053	1359656	GCO18230
0374175	GC044051	OK2NE2550XA	GDS27030	111862215012	GC028010	13166590	GDS21032	1359663	GC099288
0374176	GC044056	OK30A22510	GC027070	1122810	GDS18046	13166591	GDS44080	1360389	GC099129
0374195	GCI44002	OK30A22610	GC027070	1125045	GDS83023	1318854	GDS18333	1361301	GCO18013
0374218	GC044020	OK30A25400	GC027070	1125046	GDS61087	13189073	GDS44051	1361877	GDS18351
0374261	GDS44038	OK30A25600	GDS27024	1129668	GC018013	13214836	GDS21051	1361879	GDS18333
0374263	GC044007	OK30B22510	GC027070	1132482	GDS18008	13219092	GDS60027	1364028	GDS34163
0374318	GDS44037	OK30B22610	GC027070	1132487	GDS18008	1322209	GC099155	1364029	GDS18327
0374323	GDS44044	OK30B25400	GC027070	1132493	GDS18009	1322221	GC099155	1369960080	GDS17050
0374346	GC044012	OK30B25600	GC027070	1132495	GDS18010	13228204	GDS60026	1369961080	GDS17053
0374351	GC044011	OK5582560XA	GDS27037	1132497	GDS18009	1324166	GDS18359	1383755	GDS18263
0374368	GC044013	OK55C25500A	GDS27078	1132498	GDS18009	1324168	GDS18358	1417751	GDS18263
0374370	GDS44075	OK55C25600A	GDS27079	1134142	GC018013	13243461	GDS44033	1417775	GC018230
0374377	GC044020	OK56P25500A	GDS27018	113501201D	GDS61031	13248652	GDS44078	1418951	GC018014
0374403	GC044002	OK56P25600A	GDS27020	113501331	GCI83004	13248675	GDS44079	1420536	GDS18046
0374446	GCI44009	OK9A222550	GC027010	113598101	GCI83004	13250859	GDS17044	1420577	GC099129
0374466	GDS44027	OK9A422510	GC027010	1141768	GDS18102	13250860	GDS44064	1420578	GC099129
0374468	GDS44026	OK9A425500	GC027010	1142787	GC018001	13250861	GDS44065	1431161	GDS18358
0374471	GC017007	OK9A425600	GC027010	1142788	GC018014	1326260	GC018007	1431162	GDS18359
0374544	GDS44031	OK9A62550X	GC027010	1142790	GDS18217	1326339	GDS18333	1431359	GC018230
03CGV1053	GC023010	OK9B322510	GC027010	1142794	GDS18216	1326340	GDS18351	1431359	GDS18219
04641855AE	GDS88024	OK9B322610	GC027010	1148219	GC018009	13265648	GDS21050	1434479	GC099270
04641883AD	GDS88024	1003548	GC018012	115420170	GC054001	13271511	GDS88107	1434481	GC099270
05012749AA	GDS16009	1003550	GC018004	115420171	GCI54003	13271512	GDS88108	1437453	GDS18329
05012749AB	GDS16009	1007695	GC018026	115420174	GC054001	13271519	GDS99246	1437541	GDS18218
05085220AB	GDS15053	1008381	GDS18004	115420214	GC054001	13271549	GDS99247	1437705	GDS99212
05085224AB	GDS15054	1008402	GDS18002	115420214	GDS54001	1328094	GDS27062	1437736	GC099271
05105649AC	GDS15051	1008428	GDS18001	115420217	GC054001	1328359	GC018005	1446223	GC099271
05105660AC	GDS15052	1014109	GDS18039	115420217	GDS54002	1328362	GDS99042	1446227	GC099271
05274807AD	GC089032	1014111	GDS18040	115421210	GDS54001	1328363	GDS18264	1446232	GC099129
06483685	GC018006	1016692	GDS18009	1223723	GC018230	1328365	GDS18263	1446235	GC099129
06X039481190	GC084001	1020789	GDS18128	1223723	GDS18219	1328500	GDS18101	1446283	GCI18128
06X039534340	GC017005	1020964	GDS18008	1223725	GDS18329	1329584	GC018067	1447467	GDS18028
07629168	GC017001	1020967	GDS18009	1223785	GC099288	1329586	GC018067	1447468	GDS18027
07660834	GC017001	1023209	GDS18005	1223785	GDS18218	13296057	GC021038	1449540	GDS61087
0A5409343	GDS61191	1023209	GDS18006	1223788	GDS18328	13296183	GC088047	1450574	GDS18358
0A5409343B	GDS61191	1023211	GDS18003	1223791	GDS18194	13296185	GC021038	1451465	GDS18263
0A5409355C	GDS61191	1023211	GDS18004	1233500410	GDS35004	13306856	GCI188054	1451974	GCI18044
OK01122510	GC027002	1023212	GDS18002	1233602	GDS83023	13318006	GC021043	1454211	GDS34163
OK01122610	GC027002	1023213	GDS18001	1243502910	GDS35001	13318012	GCI188039	1454214	GDS18327
OK01225500A	GDS27067	1023213	GDS18002	1243503010	GDS35005	13318013	GCI188040	1456973	GDS18329
OK20022610	GC027010	1023247	GC018011	1243508810	GDS35001	13318014	GCI188041	1456975	GDS18328
OK20222510	GC027001	1023250	GC018023	1243508810	GCI35003	13334708	GDS99246	1456976	GDS18194
OK20222610	GC027001	1023250	GC018024	12793840	GC021030	13334715	GDS99247	1459738	GC099271
OK20225400	GC027001	1033616	GC018017	12804149	GC052012	1333973	GDS18326	1460786	GC099271
OK20225600	GC027001	105015	GC027007	12804150	GC052012	1333976	GDS18309	1463105080	GDS10037
OK20322510	GC027006	1059528	GDS18141	1293504010	GDS35005	13348258	GDS60027	1463106080	GDS10069
OK20322520	GC027006	1059534	GDS18007	1302515	GC099288	1339667	GDS27063	1463107080	GDS10035
OK20322610	GC027006	1063496	GC018003	1305325	GDS18329	1345637	GC018203	1463108080	GDS10036
OK21125600	GC027001	1063498	GC018013	1305327	GDS18328	1345638	GC018203	1468572	GDS18217
OK2162540X	GC027006	1073500410	GDS35004	1305328	GDS18194	1345639	GC018203	1468573	GDS18326
OK2162560X	GC027006	1073502710	GDS35004	1305938	GDS18219	1345864	GDS18042	1468577	GDS18309
OK2172540X	GC034006	1073502810	GDS35004	1305939	GDS18218	1348325	GDS18046	1474431	GC099129
OK2172560X	GC034006	1073503310	GDS35004	1306055	GC099129	1349785080	GC017045	1474438	GC099129
OK25425400	GC027006	1073504310	GDS35004	1306777	GC099129	1349785080	GDS17050	1474624	GC018230
OK25425600	GC027006	1074308	GC018016	1308638	GDS18333	1349786080	GCI10038	1474624	GDS18219
OK2A122610	GC027001	1078670	GC018012	13101629	GDS44032	1349786080	GC017055	1474807	GDS18358
OK2A125400	GC027006	1078675	GC018004	1310250	GDS18337	1349787080	GCI17021	1474892	GDS18329
OK2A125600	GC027006	1078677	GC018006	13109194	GDS21032	1349788080	GC017045	1474893	GDS18328
OK2A225600	GC027006	1078680	GC018015	13116174	GDS44094	1349788080	GCI17028	1475130	GDS34163
OK2C022510	GC027010	1078682	GC018017	13124675	GDS44029	1349788080	GDS17053	1475131	GDS18194
OK2C122510	GC027010	1079583	GC018011	13124676	GDS44031	1349789080	GC017055	1475135	GDS18359
OK2C222510	GC027010	1079584	GC018023	13124679	GDS21071	1349789080	GCI17042	1475136	GDS18327
OK2C32550X	GDS27070	1079584	GC018024	13124680	GDS21062	1349790080	GC017060	1476892	GC018203
OK2KB25400	GC027010	1079587	GC018021	13136379	GDS44028	1349790080	GCI17022	1478551080	GDS10033
OK2KB25600	GC027010	1079589	GC018018	13136382	GDS21063	1353398	GDS18218	1478552080	GDS10032
OK2N122520	GCI34008	1084716	GC018026	13149829	GDS44078	1353399	GDS18328	1478995	GDS18333
OK2N122610	GC027032	1097313	GDS18008	13149830	GDS44079	1354068	GDS18194	1478997	GDS18351
OK2N222610	GC027032	1097317	GDS18008	13149833	GDS17071	1355333080	GC017060	1481449080	GDS10057



COMPETITOR	G-AP Ref.	COMPETITOR	G-AP Ref.	COMPETITOR	G-AP Ref.	COMPETITOR	G-AP Ref.	COMPETITOR	G-AP Ref.
<b>OE</b>		1595093	GC099318	1690336	GC018026	191407271CX	GDS53003	1H0407272AC	GDS61067
		1595105	GC099318	1693601272	GC035026	191407271H	GDS53001	1H0407272AD	GDS61055
1481451080	GC010015	1602942	GDS18046	1693601572	GC099037	191407271HX	GDS53001	1H0407272AF	GDS61009
1481451080	GDS45120	1602947	GC018013	1693601768	GC099037	191407271K	GDS53001	1H0407272AG	GDS61067
1481452080	GC010015	1602965	GDS18101	1693602972	GCI35014	191407271N	GDS53004	1H0407272AM	GDS61028
1481452080	GDS10264	1603121	GC099318	1693602972	GC099037	191407271NV	GDS53004	1H0407272AX	GDS61009
1483807	GC099271	1603122	GC099318	1693603272	GDS35062	191407271NX	GDS53004	1H0407272M	GDS61009
1483808	GC099271	1603233	GC017007	1693603972	GC035026	191407271P	GDS53003	1H0407272MV	GDS61009
1485686080	GDS10422	1603234	GC017051	1693604072	GC035026	191407271Q	GDS53003	1H0407272MX	GDS61009
1485695080	GC018098	1603236	GCI44007	1693604372	GCI35014	191407271R	GDS53003	1H0407272N	GDS61002
1487936088	GDS10032	1603251	GC044005	1693604372	GC099037	191407271RV	GDS53003	1H04072724V	GDS61067
1487937088	GDS10033	1603261	GC044004	1693604472	GC099037	191407271T	GDS53001	1H04072724X	GDS61067
1491236080	GDS10069	1603269	GCI44008	1693605272	GC035026	191407272	GDS61008	1H0407311	GC083036
1491239080	GDS10035	1603270	GC044027	1693606072	GC035026	191407272A	GDS53005	1H0407311C	GC053008
1491240080	GDS10036	1603272	GCI44005	1693606272	GC035026	191407272AA	GDS61008	1H0407311D	GC053007
1491244080	GDS10066	1603273	GC044003	1693606572	GC035026	191407272AC	GDS53005	1H0407331	GCI53001
1491244080	GDS10032	1603274	GC044028	1693606872	GC035026	191407272AE	GDS53005	1H0407331B	GCI83006
1493004	GC099129	1603275	GC017051	1693607172	GC035026	191407272AG	GDS53002	1H0407331D	GCI83006
1493007	GC018230	1603291	GC021030	1693607372	GC035026	191407272AS	GDS61006	1H0407331E	GCI61004
1493012	GC099129	1603398	GC044004	1693608072	GC035026	191407272BB	GDS61006	1H0407331H	GCI83008
1493015	GC099288	1603403	GC017034	1693608372	GC099037	191407272BD	GDS53002	1H0407449X	GDS61172
1493218	GC099271	1603403	GC099018	1693701272	GDS35055	191407272C	GDS53005	1H0407450AX	GDS61067
1493963	GCI82006	1603405	GC017053	1693701572	GDS35054	191407272CV	GDS53002	1H0407450BX	GDS61009
1495063	GC099129	1603407	GCI44014	1693702772	GDS35054	191407272CX	GDS53002	1H0407452X	GDS61028
1495537080	GC010013	1603408	GCI44012	1693702872	GDS35055	191407272F	GDS53002	1H0498099	GC053007
1495541080	GC010013	1603409	GCI44009	1693704672	GDS35055	191407272X	GDS61008	1H0498099A	GC083036
1495542080	GDS10103	1603410	GCI44017	1693704772	GDS35055	191407274BX	GDS53005	1H0498099E	GC083036
1495545080	GC010011	1603411	GC017052	1693704872	GDS35055	191407274CX	GDS53002	1H0498099V	GC053007
1495545080	GDS10067	1607735380	GC017068	1693705572	GDS35054	191407274DX	GDS53002	1H0498099X	GC053007
1495546080	GDS10066	1608505480	GDS17053	1693705672	GDS35055	191407274FX	GDS61006	1H0498340X	GC053007
1496137080	GDS10066	1608505480	GC017045	1693706372	GDS35054	191407274X	GDS61008	1J0407271AA	GDS61123
1496138080	GC010011	1608505580	GDS17050	1693706472	GDS35055	191407311	GC053008	1J0407271AC	GDS61045
1496809	GDS18326	1608901980	GC017068	1693760242	GDS35055	191407311B	GC053007	1J0407271AF	GDS83006
1497187088	GC010098	1629459	GDS18128	1697493	GDS18309	191407311C	GDS53007	1J0407271AH	GDS61045
1497188088	GC010098	164001704701	GC017004	1702527	GC099129	191407311F	GC053007	1J0407271AL	GDS61045
1497191088	GDS10238	1643300801	GDS85060	1703321	GC099318	191407311H	GC053008	1J0407271AM	GDS61045
1497191088	GC010124	1643301901	GDS85061	171407272AC	GDS61006	191407311J	GC053007	1J0407271AP	GDS83006
1497192088	GDS10239	1643302301	GDS85060	171407272AG	GDS61054	191407311L	GC053007	1J0407271AQ	GDS83006
1497192088	GC010124	1643302401	GDS85061	171407272AS	GDS61006	191407331	GCI83006	1J0407271BG	GDS61312
1501261	GC018067	1643302701	GDS85060	171407274DX	GDS61006	191407331A	GC183006	1J0407271C	GDS83006
1501261	GDS18264	1643302801	GDS85061	171407274FX	GDS61006	191407449X	GDS53003	1J0407271CG	GDS61123
1501262	GDS18264	1659059	GC018015	171407311	GC061001	191407450X	GDS53005	1J0407271CJ	GDS61312
1501263	GDS18263	1667774	GDS99211	171407311D	GC083038	191497311J	GC053007	1J0407271EF	GDS61123
1501263	GC018207	1667774	GC099271	171407311E	GC083022	191497449X	GDS53003	1J0407271EP	GDS61123
1502109	GC099318	1667811	GC099271	171407311F	GC053008	191498099	GC053008	1J0407271ES	GDS61123
1502118	GC099318	1667941	GC099271	171407311G	GC061013	191498099A	GC053007	1J0407271F	GDS61045
150498099	GC083033	1667957	GC099271	171407311H	GC061013	191498099AV	GC053007	1J0407271FD	GDS61123
150498099A	GC083033	1676314	GC099288	171407311I	GC083007	191498099AX	GC053007	1J0407271FN	GDS83006
1506722	GDS18216	1682285	GDS18218	171407311P	GC083032	191498099B	GC053007	1J0407271GC	GDS61123
1506723	GDS18217	1683585	GDS50465	171407331C	GCI53001	191498099BV	GC053007	1J0407271GD	GDS61312
1512911	GDS18292	1683601872	GC035003	171407331E	GCI53001	191498099BX	GC053007	1J0407271H	GDS83006
1512912	GDS18293	1683601972	GDS35038	171407331F	GCI83008	191498099F	GC053008	1J0407271HJ	GDS83374
1513990	GDS18309	1683601972	GC035022	171407331G	GCI53001	191498099FX	GC053008	1J0407271HK	GDS83374
1513996	GDS18333	1683602372	GC035023	171498099	GC061001	191498099FV	GC053008	1J0407271JD	GDS83006
1520669	GDS18351	1683603172	GC035022	171498099A	GC053008	191498103	GCI83011	1J0407271JL	GDS61312
1528656	GDS34163	1683603172	GDS35037	171498099B	GC061013	191498103A	GCI83011	1J0407271LM	GDS61123
1528657	GDS18327	1683603272	GC035023	171498099BX	GC061013	191498103C	GCI83011	1J0407271LN	GDS61123
153120188003	GCI18001	1683603372	GDS35038	171498099C	GC053008	191498104	GCI83009	1J0407271Q	GDS61045
1534270	GC099318	1683603372	GC035022	171498099CX	GC061013	191498104A	GCI83009	1J0407272	GDS83004
1534271	GC099318	1683603472	GC035023	171498103	GCI83004	191498104C	GCI83011	1J0407272AB	GDS83046
1537377	GC018001	1683604572	GC035023	171498103B	GCI53001	191498340X	GC053008	1J0407272AG	GDS83004
1539136	GC018009	1683702172	GC035003	171498103C	GCI83008	191598099	GC083007	1J0407272AH	GDS83004
1539142	GC018222	1683702172	GDS35037	171498103CX	GCI83004	199051483	GCI44004	1J0407272AP	GDS83046
1541812	GDS17171	1683702272	GDS35038	171498103D	GCI53001	1C153B436AE	GDS18209	1J0407272AT	GDS83004
1541818	GDS17170	1685795	GDS18329	171498103DV	GCI53001	1C153B436CD	GDS18242	1J0407272BJ	GDS61121
1546263	GC017043	1685799	GDS18328	171498103DX	GCI53001	1C153B436CF	GDS18242	1J0407272BL	GDS83046
1546264	GC017026	1685799	GC018203	171498350X	GCI53001	1C153B437AE	GDS18213	1J0407272BM	GDS83046
1548224	GC018203	1686113	GDS18358	1726275	GDS18219	1H0407271	GDS61172	1J0407272C	GDS83004
1552939	GCI18045	1686114	GDS18359	17H8600	GC051009	1H0407271A	GDS61001	1J0407272DA	GDS83046
1567824	GDS18358	1686115	GDS34163	1802807	GC018222	1H0407271GX	GC083019	1J0407272F	GDS83046
1567848	GDS18359	1686116	GDS18327	183498099A	GC083003	1H0407271H	GDS61172	1J0407272FD	GDS61186
1594943	GDS50465	1689895	GC018012	1837849	GC018222	1H0407271N	GDS61011	1J0407272FL	GDS61186
1594945	GC099318	1690325	GC018018	191407271	GDS53004	1H0407271V	GDS61172	1J0407272FQ	GDS61186
1594946	GDS50466	1690328	GC018023	191407271A	GDS53003	1H0407271X	GDS61172	1J0407272GD	GDS61121
1594946	GC099318	1690331	GC018015	191407271B	GDS53003	1H0407272	GDS61055	1J0407272JK	GDS83004
1595088	GC099318	1690332	GC018017	191407271C	GDS53003	1H0407272A	GDS61009	1J0407272KT	GDS61121



COMPETITOR	G-AP Ref.	COMPETITOR	G-AP Ref.	COMPETITOR	G-AP Ref.	COMPETITOR	G-AP Ref.	COMPETITOR	G-AP Ref.
<b>OE</b>		1K0407271KP	GDS61198	1K0407761MX	GDS61198	21232215012	GC028004	28021AA033	GC056004
1J0407272M	GDS83046	1K0407271KS	GDS54013	1K0407761PX	GDS61281	21232215056	GCI28007	28021AA051	GC056003
1J0407311	GC083033	1K0407271LA	GDS61201	1K0407761QX	GDS54013	21232215057	GCI28006	28021AA052	GC056003
1J0407311C	GC083036	1K0407271LG	GDS54013	1K0407762X	GDS61211	212501331	GCI61003	28021AA053	GC056003
1J0407311D	GC083036	1K0407271LK	GDS54013	1K0407763GX	GDS61198	21702215012	GC028010	28021AA130	GC056004
1J0407311R	GC083035	1K0407271NM	GCI54004	1K0407764LX	GDS83313	23221GA232	GC056013	28021AA131	GC056004
1J0407341D	GCI61006	1K0407271NT	GDS54013	1K0407764PX	GDS54011	23221GA233	GC056013	28021AA132	GC056004
1J0407341F	GCI61006	1K0407272BG	GDS61096	1K0407764RX	GDS61280	23221GA242	GC056001	28021AA150	GC056003
1J0407363E	GCI61057	1K0407272CC	GDS61042	1K0407764X	GDS61199	23221GA243	GC056001	28021AA151	GC056003
1J0407451AV	GDS83006	1K0407272CR	GDS83266	1K0498099	GC083037	23221GA372	GC056002	28021AA152	GC056003
1J0407451AX	GDS83006	1K0407272DM	GDS53008	1K0498099A	GC083037	23221GA373	GC056002	28021AA160	GC056005
1J0407451BX	GDS61045	1K0407272DN	GDS61042	1K0498099AX	GC083037	23221GA592	GC056002	28021AA161	GC056005
1J0407451HX	GDS61123	1K0407272DQ	GDS54011	1K0498099B	GC083002	23221GA593	GC056002	28021AA162	GC056005
1J0407451J	GDS61312	1K0407272EC	GDS61042	1K0498099C	GC083037	235280201	GC018007	28021AA481	GC056005
1J0407451JX	GDS61312	1K0407272EG	GDS54011	1K0498099D	GC053001	235290201	GC018002	28021AA491	GC056005
1J0407451NV	GDS61312	1K0407272EN	GDS83313	1K0498099DX	GC053001	2374981032	GCI61013	28021AA501	GC056003
1J0407451NX	GDS61312	1K0407272ER	GDS54011	1K0498099E	GC083037	240608ENE0265	GC018004	28021AA511	GC056004
1J0407451P	GDS61123	1K0407272FR	GDS61042	1K0498099X	GC083037	24451255	GDS44020	28021AA541	GC056005
1J0407451PV	GDS61123	1K0407272FS	GDS61094	1K0498103	GCI83011	24451256	GDS17040	28021AA551	GC056004
1J0407451PX	GDS61123	1K0407272GK	GDS61042	1K0498103A	GCI83016	24462241	GDS44030	28021AA560	GC056004
1J0407451QX	GDS83006	1K0407272GM	GDS61042	1K0498103B	GCI83008	24462244	GDS44052	28021AC090	GC056005
1J0407451RX	GDS83374	1K0407272HB	GDS61211	1K0498103BX	GCI83008	24462250	GDS21056	28021AC130	GC056004
1J0407451SX	GDS83374	1K0407272HK	GDS61096	1K0498103C	GCI61011	24462251	GDS21073	28021AC130	GCI56006
1J0407451TV	GDS61312	1K0407272HN	GDS61113	1K0498103E	GCI54004	24969815	GDS10174	28021AC150	GC056004
1J0407451TX	GDS61312	1K0407272HR	GDS54011	1K0498103EX	GCI61057	24969905	GDS10020	28021AC200	GC056009
1J0407451V	GDS61045	1K0407272JT	GDS61096	1K0498103JX	GCI61011	251407271J	GDS61092	28021AC210	GCI56005
1J0407451X	GDS61045	1K0407272KB	GDS83346	1K0498103X	GCI83003	251501203B	GDS61005	28021AC210	GC056040
1J0407452AV	GDS83046	1K0407272KC	GDS61211	1K0501203F	GDS61284	251501203BX	GDS61005	28021AC280	GC056040
1J0407452BV	GDS83046	1K0407272KG	GDS54011	1K0501203FX	GDS61284	251501203D	GDS61005	28021AC281	GC056040
1J0407452BX	GDS83046	1K0407272KJ	GDS61126	1K0501204F	GDS61293	251501203DX	GDS61005	28021FA110	GC056039
1J0407452EX	GDS83046	1K0407272NJ	GDS61126	1K0501204FX	GDS61293	251501203G	GDS61005	28021FC031AT	GC056004
1J0407452LX	GDS61186	1K0407272NK	GDS54011	1K30A2540X	GC027078	251501204A	GDS61005	28091AA010	GC056004
1J0407452Q	GDS61121	1K0407272PH	GDS61199	1K30A2560X	GC027078	251501204AX	GDS61005	28091AA011	GC056004
1J0407452QV	GDS61121	1K0407272PL	GDS61303	1K30B2560X	GC027070	251501204B	GDS61005	28091AA012	GC056004
1J0407452QX	GDS61121	1K0407272QE	GDS54011	1KM498099	GC083002	251501204BX	GDS61005	28091AA014	GC056004
1J0407452V	GDS83004	1K0407272QF	GDS54011	1KO498103	GCI83011	251501331	GCI61003	28091AA020	GC056004
1J0407452X	GDS83004	1K0407272QN	GDS61283	1N0025500	GC034024	251598101	GCI61003	28091AA021	GC056004
1J0407453DV	GDS83006	1K0407272RB	GDS83313	1S0407761B	GDS50567	251598101A	GCI83001	28091AA024	GC056004
1J0407453DX	GDS83006	1K0407272RG	GDS54011	1S0407761BX	GDS50567	251598101X	GCI61003	28091AA024AT	GC056004
1J0407453GX	GDS83374	1K0407272SP	GDS61280	1S0407762D	GDS50543	26000690	GC086011	28091AA042	GC056004
1J0498099	GC083033	1K0407272TQ	GDS54011	1S0407762DX	GDS50543	26008329	GC086011	28091AA043	GC056004
1J0498099A	GC083033	1K0407311F	GC053001	1S0498099	GC050170	26008330	GC086002	28091AA094	GC056005
1J0498099AX	GC083033	1K0407311G	GC083037	1S4W3B437AA	GDS18101	26010773	GCI99025	28091AC090	GC056005
1J0498099B	GC083036	1K0407311H	GC083037	1S4W3B437AB	GDS18101	26010774	GC012001	28091AC091	GC056040
1J0498099BX	GC083036	1K0407311J	GC083002	1S653B418AA	GCI18022	26013813	GC012019	28091AC120	GC056009
1J0498099E	GC083035	1K0407311L	GC083037	1S713B436AC	GDS18028	26013831	GC012019	28091AC130	GC056040
1J0498099EX	GC083035	1K0407451BX	GDS83319	1S713B437AD	GDS18027	26020959	GC086002	28093AC030	GC056040
1J0498099F	GC083035	1K0407451CX	GDS83294	1S7W3B413AA	GC018007	26029827	GDS60002	28093AC040	GCI56005
1J0498103	GCI183008	1K0407451DX	GDS83295	1S7W3B413DA	GC018002	26029828	GDS44001	28093AC040	GC056009
1J0498103A	GCI83011	1K0407451FX	GDS83294	2013500813	GCI35006	26030481	GC086002	28094AC060	GC056026
1J0498103E	GCI83001	1K0407451JX	GDS61097	2013501810	GDS35006	26032411	GC044020	2815A189	GC039178
1J0498103K	GCI61006	1K0407451KX	GDS83294	2023505610	GDS35007	26032412	GDS44001	2815A190	GC039178
1J0498103X	GCI83008	1K0407451LX	GDS83373	2081207	GC039040	26032414	GDS60002	28321AE012	GC056026
1K0407271AP	GDS53007	1K0407451MX	GDS61268	2103508210	GDS35008	26060699	GC044013	28321AG000	GC056042
1K0407271AT	GDS83294	1K0407451PX	GDS83319	2103508410	GDS35009	26060700	GC044012	28321AG010	GC056042
1K0407271BD	GDS83318	1K0407451QX	GDS61093	21082215010	GC028001	26067600	GC044013	28321AG011	GC056042
1K0407271BF	GDS54013	1K0407451RX	GDS54013	21082215010	GDS28002	26073810	GC012019	28321AG012	GC056042
1K0407271BJ	GDS83295	1K0407451TX	GDS83318	21082215011	GC028001	26076882	GDS44075	28321AG020	GC056042
1K0407271BK	GDS61268	1K0407451X	GDS83295	21082215011	GDS28001	26076882	GDS44096	28321AG021	GC056042
1K0407271BN	GDS83295	1K0407452DX	GDS53007	21082215012	GC028001	26076883	GDS44095	28321AG022	GC056042
1K0407271BQ	GDS54013	1K0407452GX	GDS61042	21082215056	GCI28001	26089775	GC044020	28321FE001	GC056057
1K0407271CP	GDS83294	1K0407452MX	GDS61042	21100221501200	GC028010	26094867	GDS44027	28321FE020	GC056057
1K0407271CQ	GDS61093	1K0407452NX	GDS61113	21102215010	GDS28004	26095017	GDS44026	28321FE040	GC056067
1K0407271DH	GDS83319	1K0407452QX	GDS61211	21102215011	GDS28003	26119529	GDS17044	28321FE041	GC056067
1K0407271DJ	GDS61097	1K0407452TX	GDS61094	21102215012	GC028001	26119530	GDS44079	28321FE061	GC056067
1K0407271DQ	GDS83373	1K0407453BX	GDS83266	211501331B	GCI61003	2650112001	GDS88016	28321FE081	GC056067
1K0407271DR	GDS83373	1K0407453DX	GDS83265	211598101	GCI61003	2650112003	GDS59392	28321FE082	GC056067
1K0407271DS	GDS61224	1K0407454BX	GDS61042	21212215010	GDS28006	27H7567	GC051013	28321FE090	GC056067
1K0407271EE	GDS83295	1K0407454DX	GDS83313	21212215011	GDS28005	28021AA003	GC056005	28321FE091	GC056067
1K0407271ES	GDS83265	1K0407454HX	GDS54011	212122150111L	GDS28005	28021AA011	GC056005	28321FE092	GC056067
1K0407271HH	GDS61201	1K0407454NX	GDS61126	212122150111R	GDS28006	28021AA012	GC056005	28321FE110	GC056057
1K0407271HM	GDS83265	1K0407454TX	GDS83346	21212215012	GC028002	28021AA013	GC056005	28321FE130	GC056067
1K0407271JA	GDS61198	1K0407454X	GDS54011	21212215054	GCI28004	28021AA021	GC056004	28321FE131	GC056067
1K0407271JJ	GDS61281	1K0407761AX	GDS61224	21212215055	GCI28003	28021AA022	GC056004	28321FE150	GC056067
1K0407271KA	GDS54013	1K0407761EX	GDS61201	21212215056	GCI28004	28021AA031	GC056004	28321FE151	GC056067
		1K0407761HX	GDS83265	21212215057	GCI28003	28021AA032	GC056004	28321FE170	GC056067



COMPETITOR	G-AP Ref.	COMPETITOR	G-AP Ref.	COMPETITOR	G-AP Ref.	COMPETITOR	G-AP Ref.	COMPETITOR	G-AP Ref.
<b>OE</b>		30681130	GDS18194	31607561342	GDS85018	327220	GDS10039	32727F	GDS10021
		30711770	GDS18194	31607565313	GDS85029	327221	GDS45013	32727G	GDS10043
28321FE171	GC056067	30711772	GDS18328	31607565313	GC085001	327222	GDS45030	32727J	GDS10020
28321FE181	GC056067	30735121	GDS62031	31607565314	GDS85018	32722H	GDS45157	32727K	GDS10102
28321FE191	GC056058	30735129	GDS62022	31607565314	GCI85014	32722L	GDS10012	32727K	GDS10035
28321FE192	GC056058	30783002	GDS18329	31607574850	GDS38002	32722N	GDS10117	32727N	GDS10034
28321KC001	GC056007	30783082	GDS62022	31607574852	GC038003	32722P	GDS45026	32727T	GDS10142
28321KC041	GC056007	30783097	GDS62031	31607574852	GDS38001	32722Q	GDS99006	32727V	GDS10207
28321KC051	GC056007	30783167	GDS18328	31607586433	GC085001	32722S	GDS10131	32727W	GDS10128
28321SA030	GC056041	30783168	GDS18329	31607589763	GDS85024	32722V	GDS10141	327283	GC010004
28321SA031	GC056041	30783171	GDS18194	31607589767	GC085009	32722X	GDS45105	327283	GDS45155
28321SA033	GC056041	30783173	GDS62060	31607589768	GC085009	32722Z	GDS10040	327284	GDS45155
28321SA033	GDS56016	30783174	GDS62063	31607609211	GDS85024	327235	GC010008	327285	GDS10034
28321SA040	GC056041	30787774	GDS62060	31608605469	GDS85024	327235	GDS10191	327287	GDS10191
28321SA050	GC056041	30787775	GDS18328	321407311L	GC083007	327238	GDS10113	32728E	GC045011
28321SA051	GC056041	30787778	GDS18194	321407311M	GC083007	327239	GDS10113	32728E	GDS45031
299341X2	GC050009	30787783	GDS18329	321407331D	GCI83006	32723C	GC045033	32728F	GDS10021
2H0407271BX	GDS61173	30787784	GDS62063	321498099	GC083038	32723C	GDS45027	32728J	GDS10009
2H0407271D	GDS61173	30871328	GC039021	321498099A	GC083007	32723J	GDS10009	32728N	GDS45152
2H0407271DX	GDS61173	31217540115	GDS85062	321498099B	GC083007	32723K	GDS45015	32728Q	GDS10048
2H0498099	GC061062	31217540116	GDS85074	321498099C	GC083032	32723L	GDS45027	32728R	GDS10128
2H0498099A	GC061062	31256930	GDS18329	321498099CX	GC083032	32723N	GDS10113	32728S	GDS10131
2K0407272E	GDS61101	31256931	GDS18328	321498099E	GC083007	32723Q	GDS99006	32728T	GDS10141
2K0407272F	GDS61042	31601493977	GC038003	321498099EX	GC083007	327240	GDS10191	32728W	GC010028
2K3407271B	GDS61131	31601493977	GDS99285	321498099F	GC083007	327244	GDS45033	32728W	GDS45126
2K3407271BX	GDS61131	31601503306	GC038003	321498103	GCI83004	327245	GDS45033	327290	GDS10113
2M343B437AA	GDS34132	31601503306	GDS38002	321498103A	GCI83008	327248	GDS10034	327291	GDS45030
2M353B437AA	GDS27063	31601503307	GC038003	321498103B	GCI83003	32724C	GDS45027	327293	GDS45134
2M353B437CB	GDS27063	31601503307	GDS38001	321498103C	GCI83009	32724J	GDS10164	327298	GC010027
2S613B436AB	GDS18217	31603450563	GDS99215	321498103CV	GCI83009	32724K	GDS10039	32729C	GC010015
2S613B436AC	GDS18217	31603450564	GDS85078	321498103CX	GCI83009	32724K	GDS45068	32729C	GDS10264
2S613B436AD	GDS18217	31603450565	GC085010	321498103V	GCI83004	32724L	GDS10264	32729E	GC045011
2S613B436AE	GDS18217	31603450565	GDS99215	321498103X	GCI83004	32724Q	GDS10157	32729E	GDS45031
2S613B436AG	GDS18217	31603450566	GC085010	321498350V	GCI83004	32724R	GDS45004	32729G	GDS10204
2S613B437AB	GDS18216	31603450566	GDS85078	321498350X	GCI83004	32724T	GC045038	32729J	GDS10164
2S613B437AC	GDS18216	31604853485	GC085009	326582	GC041084	32724T	GDS10192	32729K	GDS10033
2S613B437AD	GDS18216	31604853486	GC085009	326763	GC021010	327250	GDS10009	32729L	GDS10165
2S613B437AE	GDS18216	31607502731	GDS85047	327000	GDS10003	327251	GDS10164	32729N	GDS45152
2S6W3A327AB	GC018001	31607502731	GDS85048	327200	GC010048	327254	GDS10009	32729P	GDS10161
2S6W3B437AA	GDS18216	31607505004	GDS85018	327200	GDS10039	327255	GDS10038	32729Q	GDS10048
2S6W3B437FC	GC018009	31607505005	GC085001	327201	GDS45134	327256	GDS10164	32729R	GDS10128
2T143A327AA	GC018067	31607505005	GDS85029	327202	GC010002	32725C	GDS45032	32729T	GDS10141
2T143A328AAK	GC018067	31607505006	GC085001	327202	GDS45134	32725K	GDS45068	32729W	GDS45126
2T143B436AC	GDS99042	31607505006	GDS85018	327202EH	GC010002	32725L	GDS10026	3272A1	GC010027
2T143B436AD	GDS99042	31607505199	GDS85047	327204	GDS45030	32725N	GDS10071	3272A1	GDS10022
2T143B436AE	GDS99042	31607505200	GDS85048	327206	GC045006	32725N	GC010008	3272A4	GDS10025
2T143B436AF	GDS99042	31607514475	GDS99285	327209	GC010002	32725P	GDS10162	3272A6	GDS10025
2T143B436AG	GC018067	31607514477	GDS38001	327209	GDS45160	32725P	GC045052	3272A8	GDS10117
2T143B436AG	GDS99042	31607514478	GDS38002	32720F	GDS45024	32725Q	GDS10157	3272A9	GDS10090
2T143B436AH	GDS99042	31607514479	GDS38001	32720G	GDS45024	32725T	GDS10192	3272AA	GDS45138
2T143B436CA	GDS18264	31607514480	GDS38002	32720H	GDS10165	32725X	GC010025	3272AC	GDS45138
2T143B436CC	GDS18264	31607518237	GC038003	32720J	GDS10163	32725X	GDS45119	3272AE	GC099008
2T143B436CF	GDS18264	31607518237	GC038002	327210	GC010002	327260	GC010029	3272AE	GDS45012
2T143B437CA	GDS18263	31607518237	GDS99285	327210	GDS45023	327260	GDS10191	3272AF	GDS45012
2T143B437CB	GDS18263	31607518238	GC038003	327211	GC010002	327261	GDS45024	3272AH	GC045049
2T143B437CC	GDS18263	31607518238	GC038002	327211	GDS45023	327265	GDS10007	3272AP	GDS45009
2T143B437CD	GDS18263	31607518238	GDS38003	327212	GC010002	32726C	GDS45032	3272AP	GDS45064
2T143B437CE	GDS18263	31607518247	GC038002	327212	GDS45023	32726E	GC045011	3272AS	GDS10422
2T143B437FA	GDS18041	31607518248	GC038002	327215	GDS45015	32726E	GDS10043	3272AT	GDS10422
2T143B437FB	GDS18041	31607518261	GC038003	327216	GDS45015	32726F	GDS10021	3272AX	GDS10020
2T143B437FC	GDS18041	31607524045	GDS99215	327218	GDS10040	32726K	GDS10105	3272C0	GDS10117
2T143B437FD	GDS18041	31607524046	GDS85078	327219	GDS45015	32726K	GDS10037	3272C3	GDS10090
2T143E327BA	GC018207	31607529201	GC085010	32721F	GDS10018	32726P	GDS10162	3272C7	GC010024
301012675R	GDS18247	31607529201	GDS99215	32721K	GDS10164	32726Q	GDS10138	3272CC	GDS10423
3015012031	GCI61003	31607529202	GDS85078	32721L	GDS10082	32726T	GDS10142	3272CE	GDS10423
3020513A25	GC041170	31607529202	GC085010	32721N	GDS10128	32726V	GDS10207	3272CH	GDS10037
3054073111	GC083007	31607531721	GDS85053	32721P	GDS45026	32726W	GDS10128	3272CK	GDS10035
305407311B	GC083007	31607531722	GDS85054	32721Q	GDS10161	32726W	GC010076	3272CN	GDS10033
305407311C	GC083007	31607533215	GDS85053	32721S	GDS10131	32726X	GDS45119	3272CQ	GDS10043
30610835	GC062011	31607533216	GDS85054	32721T	GDS10138	32726Y	GDS10026	3272CQ	GC045065
30611702	GC062008	31607545125	GDS85052	32721V	GDS10121	327275	GDS45004	3272CR	GDS10043
30611947	GC062012	31607545126	GC085006	32721W	GDS10121	327276	GDS10039	3272CS	GC045067
30681126	GDS18218	31607545126	GDS85043	32721X	GC010028	327277	GDS45021	3272E0	GC045004
30681127	GDS18219	31607553945	GDS85052	32721X	GDS45105	32727C	GDS45157	3272E1	GDS45024
30681128	GDS18328	31607553946	GDS85043	327220	GC010048	32727E	GC045011	3272E2	GC045004
30681129	GDS18329	31607561341	GDS85029	327220	GDS10007	32727E	GDS10043	3272E2	GDS45160



COMPETITOR	G-AP Ref.	COMPETITOR	G-AP Ref.	COMPETITOR	G-AP Ref.	COMPETITOR	G-AP Ref.	COMPETITOR	G-AP Ref.
OE		3272J4	GDS10037	3272PZ	GDS10253	3272W0	GDS45157	32732Q	GDS10205
		3272J5	GDS10102	3272PZ	GC099366	3272W5	GDS10009	32732Y	GDS10017
3272E3	GC045001	3272J5	GDS10035	3272Q	GDS99006	3272W8	GDS10164	32732Z	GDS10017
3272E4	GC010005	3272J6	GDS10035	3272Q5	GDS10189	3272WG	GDS10314	327330	GDS45030
3272E5	GC010003	3272J7	GDS10033	3272Q5	GDS10184	3272WH	GDS10314	32733K	GDS10205
3272E7	GDS45160	3272J8	GDS10033	3272Q6	GDS10189	3272WV	GC099366	32733L	GDS45035
3272EH	GDS10121	3272J9	GDS10113	3272Q7	GDS10189	3272WX	GC010155	32733M	GDS45035
3272EH	GC010096	3272JA	GDS10276	3272QA	GDS10253	3272X4	GDS10020	32733N	GDS45158
3272EJ	GDS10141	3272JC	GDS10276	3272QC	GC099366	3272X6	GDS10164	32733Q	GC010015
3272EK	GDS10207	3272JY	GC099128	3272QC	GDS10362	3272X8	GDS10164	32733Q	GDS45120
3272EN	GC010026	3272JZ	GDS59495	3272QE	GDS10362	3272X9	GDS99007	32733X	GC045011
3272EN	GDS10030	3272JZ	GC045058	3272QF	GC010155	3272XJ	GC045067	32733X	GDS45094
3272EP	GDS10030	3272K2	GDS10039	3272QF	GDS10427	3272Y0	GDS45009	32733Y	GC045011
3272EQ	GDS10146	3272K4	GDS45157	3272QG	GDS10427	3272Y0	GDS45064	32733Y	GDS45094
3272EQ	GC045057	3272K7	GDS10016	3272QH	GDS10380	3272Y1	GDS45009	32733Z	GDS10019
3272ER	GDS10146	3272K8	GDS10016	3272QJ	GDS10380	3272Y1	GDS45064	327348	GDS45013
3272ES	GC010026	3272KL	GC010067	3272QW	GDS10381	3272Y2	GDS10165	327349	GDS45013
3272ES	GDS10001	3272KL	GDS99195	3272QX	GDS10381	3272Y3	GC010022	32734E	GDS45147
3272ET	GDS10001	3272KW	GDS99272	3272QY	GDS10312	3272Y3	GDS10128	32734F	GDS45147
3272EV	GDS10181	3272KW	GC045057	3272QZ	GDS10312	3272Y4	GDS10128	32734H	GDS10019
3272EW	GDS10181	3272KX	GDS99272	3272R0	GDS10189	3272Y5	GDS10128	32734J	GDS10019
3272EX	GDS10147	3272KY	GC010025	3272R3	GDS10010	3272Y6	GDS10026	32734S	GDS10203
3272EY	GDS10147	3272KY	GDS45203	3272R5	GDS10039	3272Y7	GDS10026	32734T	GDS10205
3272F5	GC010043	3272KZ	GDS45203	3272R7	GDS10040	3272Y8	GDS10026	32734V	GDS45158
3272F5	GDS45160	3272L0	GDS10016	3272R8	GDS10040	3272YE	GDS45101	32734Y	GDS45137
3272F5SA	GDS45080	3272L1	GDS10082	3272RA	GDS10121	3272YW	GDS10362	32734Z	GDS45137
3272F6	GDS45008	3272L2	GDS45017	3272RC	GDS10121	3272Z0	GDS45101	327351	GDS45036
3272F6	GC045001	3272L3	GDS45017	3272RH	GDS10146	3272Z2	GDS10187	327352	GDS45036
3272F8	GDS45008	3272L4	GDS45157	3272RJ	GDS10424	3272Z7	GC010022	327354	GDS45030
3272F9	GDS10034	3272L9	GDS10052	3272RK	GDS10424	3272Z7	GDS10131	327355	GC010009
3272FG	GC010067	3272LA	GC010025	3272RL	GC010015	3272Z8	GDS10131	327355	GDS45066
3272FG	GDS99195	3272LA	GDS45200	3272RT	GDS10146	3272ZE	GDS10255	327356	GDS10008
3272FH	GDS99195	3272LC	GDS45200	3272RX	GDS10314	327301	GDS45178	327357	GDS45029
3272FL	GDS99195	3272LE	GC010067	3272RY	GDS10314	327304	GDS10118	327358	GDS45029
3272FP	GC010022	3272LE	GDS10248	3272RZ	GDS10335	327305	GDS10174	32735C	GDS10008
3272FP	GDS10131	3272LF	GDS10248	3272S2	GDS45151	327306	GDS10014	32735E	GDS45001
3272FQ	GDS10131	3272LG	GDS10250	3272S2	GDS45159	327307	GDS10004	32735F	GDS10186
3272FR	GDS10241	3272LH	GDS10250	3272S3	GDS45007	327309	GDS10032	32735H	GDS10174
3272FR	GC045057	3272LJ	GDS45194	3272S5	GC045005	32730E	GDS10174	32735J	GDS10003
3272FS	GDS10241	3272LK	GDS45194	3272S5	GDS45151	32730F	GDS10174	32735P	GDS10044
3272FT	GDS10268	3272LL	GDS45202	3272S5	GDS45159	32730M	GDS10137	32735Q	GDS10007
3272FT	GC010085	3272LN	GDS45202	3272S6	GC045003	32730N	GDS45010	32735R	GDS10007
3272FV	GDS10268	3272LP	GC010067	3272S6	GDS45135	32730N	GDS45065	32735S	GDS10069
3272FW	GDS10030	3272LP	GDS99195	3272S6	GDS45007	32730P	GDS45010	32735S	GDS10104
3272FW	GC010053	3272LQ	GDS99195	3272S7	GDS45106	32730P	GDS10137	32735T	GDS10036
3272FX	GDS10030	3272LT	GC099366	3272S7	GC010127	32730P	GDS45065	32735V	GDS10032
3272G1	GDS10020	3272LV	GDS45126	3272S8	GDS45106	32730Q	GDS10167	32735W	GDS10032
3272G9	GDS10189	3272LW	GDS45105	3272S8	GC010127	32730R	GDS10023	32735X	GDS10120
3272GE	GDS10266	3272LW	GC099366	3272SA	GDS10335	32730S	GDS10023	32735X	GDS10012
3272GE	GC010052	3272LX	GDS10255	3272SE	GC010098	32730T	GDS10023	32735Y	GDS10014
3272GF	GDS10266	3272LX	GC099366	3272SL	GDS17151	32730V	GDS10027	32735Z	GDS10057
3272GG	GC010052	3272M0	GDS10052	3272SL	GC017068	32730W	GDS10015	32735Z	GDS45120
3272GG	GDS10310	3272N0	GC010008	3272SN	GDS17151	32730X	GDS10015	327360	GC010010
3272GH	GDS10310	3272N0	GDS10071	3272SS	GC017060	32730Y	GDS45016	327360	GDS10034
3272GL	GC010051	3272N1	GC010029	3272SS	GDS45175	32730Y	GC045049	327360	GDS10068
3272GY	GC010015	3272NF	GDS10033	3272T2	GDS45004	32730Z	GDS45016	327362	GC010010
3272H3	GDS45160	3272NK	GC010124	3272T3	GDS45021	327310	GDS10032	327362	GDS10068
3272H7	GDS45021	3272NP	GC010098	3272T4	GDS45033	327311	GDS45005	327364	GC010009
3272H8	GDS45004	3272NQ	GC010098	3272T5	GDS45178	327312	GDS45005	327364	GDS10007
3272HL	GDS10381	3272NR	GDS10364	3272T8	GDS10159	327313	GDS10032	327364	GDS45066
3272HP	GDS10125	3272NS	GDS10364	3272T9	GDS10020	327315	GDS10014	327365	GC010009
3272HP	GC045056	3272NT	GDS10121	3272TC	GC010156	327317	GC010001	327365	GDS10007
3272HQ	GDS10125	3272NW	GDS10312	3272TH	GC010155	327317	GDS10117	327366	GC010009
3272HR	GDS10146	3272NY	GDS10381	3272TH	GDS10427	327318	GC010001	327366	GDS10039
3272HR	GC010077	3272P5	GDS10082	3272TK	GDS10380	327318	GDS10117	327366	GDS45068
3272HW	GDS10419	3272PA	GC017055	3272TN	GC099366	32731C	GDS10019	327367	GC010009
3272HX	GDS10419	3272PC	GC017055	3272TZ	GDS10250	32731H	GDS45017	327367	GDS10039
3272HY	GC045057	3272PF	GC017060	3272V0	GDS10016	32731J	GDS45017	327367	GDS45068
3272HY	GDS10420	3272PG	GC017045	3272V0	GDS10072	32731K	GDS10167	327368	GDS10003
3272HZ	GDS10420	3272PL	GDS10420	3272V1	GDS10040	327320	GC010001	327369	GC010009
3272J0	GDS10037	3272PQ	GC017060	3272V2	GDS10164	327321	GC010001	327369	GDS10007
3272J1	GDS10035	3272PR	GDS10364	3272V3	GDS10033	327323	GC010001	32736A	GDS10015
3272J2	GDS10067	3272PS	GDS10364	3272V4	GDS10033	327324	GC010001	32736A	GDS10027
3272J3	GDS10105	3272PT	GDS51047	3272V5	GDS10033	327325	GDS45158	32736G	GDS10205
3272J3	GDS10037	3272PV	GDS10311	3272V7	GDS10016	327327	GDS45029	32736H	GDS10019
3272J4	GDS10105	3272PW	GDS10311	3272VA	GDS10250	327329	GDS45003	32736J	GDS10167

COMPETITOR	G-AP Ref.	COMPETITOR	G-AP Ref.	COMPETITOR	G-AP Ref.	COMPETITOR	G-AP Ref.	COMPETITOR	G-AP Ref.
OE		3273C8	GDS10003	3273K3	GDS10023	3273QQ	GC010155	327461	GDS10130
		3273C8	GDS10008	3273K4	GDS10024	3273QQ	GDS10421	327477	GC010010
32736K	GDS10023	3273CC	GDS10425	3273K5	GDS10167	3273QR	GDS10421	327477	GDS10034
32736N	GDS10114	3273CE	GDS10425	3273K6	GDS45017	3273QS	GDS10363	327478	GC010010
32736P	GDS10070	3273CH	GDS10104	3273K7	GDS10167	3273QT	GDS10363	327478	GDS10068
32736P	GC010008	3273CJ	GDS10104	3273KJ	GDS99271	3273QV	GDS45113	327479	GC010001
32736R	GDS10068	3273CK	GDS10036	3273KJ	GC045057	3273QX	GDS10396	327480	GC010001
32736T	GDS45020	3273CN	GDS10032	3273KK	GDS99271	3273R0	GDS10036	327482	GC010001
32736V	GDS45020	3273CQ	GC045011	3273KL	GC010025	3273R1	GDS10036	327482	GDS10117
32736Y	GDS45108	3273CQ	GDS45094	3273KL	GDS45204	3273R2	GDS10032	327483	GC010001
32736Y	GC045052	3273CQ	GC045065	3273KN	GDS45204	3273R3	GDS10032	327483	GDS10117
32736Z	GDS45108	3273CS	GC045067	3273KP	GC010025	3273R6	GDS10007	327485	GC010001
327371	GC010002	3273CW	GDS10242	3273KP	GDS45201	3273R8	GDS45158	327486	GC010001
327371	GDS10177	3273CX	GDS10242	3273KQ	GDS45201	3273R9	GDS45158	327492	GDS45111
327373	GDS45029	3273CY	GC010085	3273KR	GC010067	3273RF	GDS10382	3274C4	GDS10130
327375	GC045006	3273E1	GC010021	3273KW	GDS45193	3273RG	GDS10382	3300036	GC035001
327378	GC010043	3273E2	GDS10008	3273KX	GDS45193	3273RH	GDS10313	3301585	GC035001
327378	GDS45070	3273E6	GC010003	3273KY	GDS10267	3273RJ	GDS10313	33201229141	GDS85021
327379	GC010002	3273E6	GDS45017	3273KZ	GDS10267	3273RN	GDS99197	33201229374	GDS85021
327379	GDS45022	3273E9	GDS45017	3273L1	GC045001	3273RP	GDS99197	33203415955	GDS85062
32737E	GDS10014	3273EA	GDS10031	3273L1	GDS45017	3273RQ	GDS10348	33207500914	GDS85050
32737F	GDS10156	3273EA	GC010053	3273L2	GC045004	3273RR	GDS10348	33207500915	GDS85050
32737G	GDS10156	3273EG	GDS10265	3273L2	GDS45153	3273S1	GDS10014	33207524043	GDS85062
32737H	GDS99010	3273EG	GC010052	3273L4	GC045004	3273S2	GDS10155	33207524044	GDS85074
32737J	GDS99010	3273EH	GDS10140	3273L4	GDS45070	3273S2	GDS10014	33207537607	GDS85062
32737K	GDS10152	3273EJ	GDS10139	3273L5	GC010005	3273S4	GDS10155	33207537608	GDS85074
32737L	GDS10152	3273EK	GDS10208	3273L7	GDS45070	3273SG	GDS10144	33207561795	GDS85039
32737Q	GDS10049	3273EN	GDS10031	3273L9	GDS10007	3273SK	GDS10320	33207561796	GDS85038
32737R	GDS10049	3273EP	GDS10031	3273LP	GDS45104	3273SL	GDS10320	33207580945	GDS85038
32737W	GDS10023	3273EQ	GDS10144	3273LP	GC099366	3273SV	GC010098	33207580946	GDS85039
327381	GC010002	3273EQ	GC045057	3273LQ	GC099366	3273SZ	GC010707	33207628251	GDS85107
327381	GDS45022	3273ER	GDS10144	3273LR	GDS10254	3273T3	GDS10120	33211225940	GDS85003
327384	GDS45001	3273ES	GC010026	3273LR	GC099366	3273T4	GDS10120	33211225941	GDS85003
327385	GDS45001	3273ES	GDS10002	3273LT	GDS10295	3273T6	GC010008	33211225942	GDS85004
327387	GDS10004	3273ET	GDS10002	3273N2	GC010043	3273T6	GDS10070	33211225943	GDS85004
327387	GDS10044	3273EV	GDS10206	3273N2	GDS45022	3273TC	GDS17052	33211226047	GDS85001
327388	GDS45001	3273EW	GDS10206	3273N2A	GDS45079	3273TC	GC017068	33211226330	GDS85003
327389	GC010009	3273EX	GDS45103	3273N4	GC010010	3273TR	GC010156	33211226336	GDS85003
327389	GDS10007	3273EY	GDS45103	3273N7	GDS10174	3273TT	GC010155	33211226720	GDS85001
32738G	GC045038	3273FA	GDS10265	3273NC	GDS10032	3273TT	GDS10421	33211226860	GDS85004
32738G	GDS10143	3273FG	GDS99196	3273NK	GC010124	3273TW	GDS10363	33211226861	GDS85003
32738H	GDS10143	3273FH	GDS99196	3273NP	GC010098	3273V7	GDS10012	33211226900	GDS85003
32738J	GDS10139	3273G1	GDS45025	3273NQ	GC010098	3273VH	GDS10254	33211226901	GDS85004
32738K	GDS10139	3273G2	GDS10007	3273NT	GDS99197	3273VN	GDS10251	33211226904	GDS85007
32738L	GDS10140	3273G3	GDS45014	3273NW	GDS10313	3273VP	GDS10251	33211226905	GDS85007
32738N	GDS10140	3273G9	GC010004	3273NX	GDS10313	3273W0	GDS10012	33211227032	GDS85002
32738P	GDS10139	3273G9	GDS45156	3273NY	GDS10140	3273W7	GC010021	33211227172	GDS85014
32738T	GDS10208	3273GC	GC010051	3273P3	GDS10195	3273W8	GDS10202	33211227404	GDS85007
32738V	GDS10208	3273GQ	GC010015	3273P7	GDS45070	3273W8	GDS10185	33211227585	GDS85007
327390	GDS45036	3273GZ	GC010096	3273P7	GDS45198	3273W9	GDS10202	33211227591	GDS85007
327391	GDS45029	3273GZ	GDS99197	3273PG	GDS10382	3273X	GDS10015	33211227597	GDS85002
32739Z	GDS10023	3273H0	GDS45156	3273PJ	GC017055	3273X3	GDS10202	33211227599	GDS85001
32739Z	GC010076	3273H1	GDS10068	3273PK	GC017055	3273X8	GDS10044	33211227606	GDS85002
3273A6	GC010008	3273H4	GDS10114	3273PN	GC017060	3273XP	GC099366	33211227912	GDS85006
3273A6	GDS10190	3273H5	GDS10190	3273PP	GC017045	3273XR	GC010155	33211229235	GDS85006
3273A9	GDS10114	3273H8	GDS10114	3273PP	GDS17050	3273Y0	GDS10007	33211229392	GDS85002
3273AA	GDS10023	3273H9	GDS45029	3273PT	GDS10259	3273Y2	GDS10004	33211229420	GDS85021
3273AC	GC010028	3273HC	GDS10382	3273PX	GC017060	3273Y3	GDS10004	33211229432	GDS85021
3273AC	GDS45104	3273HF	GDS10124	3273PY	GDS51050	3273Y4	GDS10118	33211229587	GDS85002
3273AE	GDS45104	3273HF	GC045056	3273PZ	GDS99271	3273Y7	GDS45002	33211229588	GDS85017
3273AH	GC010025	3273HG	GDS10124	3273Q1	GDS45014	3273Y9	GDS45136	33211229591	GDS85051
3273AH	GDS45113	3273HH	GDS10144	3273Q2	GDS45025	3273Y9	GDS45002	33211229592	GDS85042
3273AJ	GDS45113	3273HH	GC010077	3273Q3	GDS45156	3273YC	GC045067	33211229707	GDS85051
3273AL	GC099008	3273HR	GDS10259	3273Q5	GDS10104	3273Z0	GDS99003	33211229708	GDS85042
3273AL	GDS45011	3273HS	GDS10259	3273Q6	GDS10036	3273Z1	GDS99003	33213428179	GDS85062
3273AN	GDS45011	3273HT	GDS10259	3273Q7	GDS10066	3273Z5	GDS45014	33217529913	GDS85062
3273AQ	GDS45010	3273J1	GDS10177	3273Q8	GDS10104	3273Z6	GDS45034	33217529914	GDS85074
3273AQ	GDS45065	3273J5	GDS45029	3273Q9	GDS10104	3273Z7	GDS45179	33217540115	GDS85062
3273C0	GDS10114	3273J6	GC010027	3273QA	GDS99271	3273Z8	GC010019	33217540116	GDS85074
3273C1	GDS10190	3273J9	GC010027	3273QH	GDS10251	3273Z8	GDS45179	33217547069	GDS85040
3273C3	GDS45034	3273JR	GC099128	3273QJ	GDS10251	3273Z9	GDS45178	33217547070	GDS85032
3273C4	GDS45034	3273JS	GC045058	3273QK	GDS10325	3273ZP	GDS10383	33217547071	GDS85034
3273C5	GDS45017	3273JY	GDS99196	3273QK	GC099366	3273ZZ	GDS10032	33217547072	GDS85033
3273C6	GDS10190	3273JZ	GDS99196	3273QL	GDS10325	327453	GDS10130	33217547073	GDS85022
3273C7	GC010010	3273K1	GC010007	3273QN	GDS10383	327455	GDS10130	33217547074	GDS85023
3273C7	GDS10068	3273K2	GDS10023	3273QP	GDS10383	327459	GDS10130	33217547075	GDS85022



COMPETITOR	G-AP Ref.	COMPETITOR	G-AP Ref.	COMPETITOR	G-AP Ref.	COMPETITOR	G-AP Ref.	COMPETITOR	G-AP Ref.
<b>OE</b>		36000518	GDS62022	374221	GDS60002	374672	GC044028	3910001M15	GC041170
		36000519	GC062009	374222	GDS44001	374691	GC188054	3910002E02	GC041061
33217547076	GDS85023	36000522	GDS62039	374229	GDS60002	374738	GDS60002	3910005E02	GC041063
33217547821	GDS85091	36000532	GDS62031	374235	GDS44011	374748	GDS44059	3910006R00	GC041035
33217553559	GDS85039	36000548	GDS62060	374236	GDS44059	374788	GDS44078	391000926R	GDS50488
33217553560	GDS85038	36000549	GDS18328	374241	GC044006	374789	GDS44079	391000E410	GC041054
33217553561	GDS85040	36000550	GDS62060	374249	GDS44039	374790	GDS17071	391000E415	GC041054
33217553563	GDS85039	36000552	GDS18194	374259	GDS44049	374791	GDS17070	391000E510	GC041306
33217553564	GDS85038	36000557	GDS18329	374260	GDS44050	374792	GDS44040	391000E515	GC041306
33217561783	GDS85039	36000558	GDS62063	374261	GDS44038	374793	GDS44042	391000F000	GDS41464
33217561790	GDS85079	36000560	GDS62063	374262	GC044006	374800	GDS44075	391000M000	GC041001
33217561792	GDS85036	36000692	GC099271	374263	GC044007	374800	GDS44096	391000M005	GC041001
335712	GC041083	36001075	GC099271	374275	GDS44059	374801	GDS44095	391000M301	GC041078
337407311C	GC061028	36001076	GC099271	374278	GDS44059	374818	GDS17044	391000M316	GC041155
337407311F	GC099134	36001194	GC059285	374282	GDS44038	374825	GDS44078	391000M600	GC041033
337407331A	GCI18018	36001356	GDS18328	374312	GDS60002	374829	GDS60027	391000M605	GC041033
337498103	GCI18018	36001360	GDS18329	374317	GDS44036	374830	GDS21050	391000M801	GC041118
34303966	GC062004	36001360	GCI18044	374318	GDS44037	374831	GDS21054	391000M806	GC041118
34331017	GC062007	36001448	GC099288	374321	GDS60013	374835	GDS60026	391000M816	GC041155
3433105	GC062005	36001450	GC099288	374322	GDS44033	374843	GC017051	391000M900	GC041078
34331058	GC062005	36001451	GC099271	374323	GDS44044	374922	GDS60027	391000M905	GC041078
34349050	GC062006	36001452	GC099271	374328	GDS60035	377407311	GC083007	391000M910	GC041078
357407271A	GDS61001	36001531	GC099271	374329	GC044014	377498099F	GC061034	391000M910	GC041003
357407271B	GDS61002	36002144	GC099288	374346	GC044012	377498099G	GC061023	391000M970	GC041078
357407271EX	GDS61001	36002896	GC099288	374351	GC044011	377498099L	GC083007	3910010E02	GC041063
357407271G	GDS61001	36002897	GC099288	374366	GDS44001	377498099N	GC061030	391001162R	GC050157
357407271GX	GDS61001	360113KTX	GC050012	374368	GC044013	377498103E	GCI53002	3910011A00	GC041060
357407271H	GDS61001	36051061	GDS62063	374370	GDS44075	3815A008	GC039177	3910011A10	GC041060
357407271HX	GDS61001	3652045	GC018013	374372	GDS44075	3815A011	GC039177	3910011A20	GC041060
357407271P	GDS61001	3652045	GDS18102	374372	GDS44096	3815A065	GC039117	3910011M00	GC041060
357407271PX	GDS61001	3652047	GC018013	374373	GDS44095	3815A068	GC039117	3910011M05	GC041060
357407272	GDS61002	3652047	GDS18101	374377	GC044020	3815A107	GC039113	3910012A00	GC041060
357407272B	GDS61002	3667428	GC018013	374378	GCI44003	3815A108	GC039113	3910012A10	GC041060
357407272F	GDS61002	3667428	GDS18042	374387	GC044065	3815A133	GC039022	3910012A20	GC041060
357407272FX	GDS61002	3667429	GC018013	374402	GCI99026	3815A164	GC039236	3910013A00	GC041060
357407272L	GDS61002	3667429	GDS18046	374403	GC044002	3815A165	GC039236	3910013A01	GC041060
357407272M	GDS61002	371003840R	GDS50569	374410	GC044065	3815A167	GC015011	3910013A10	GC041060
357407272MV	GDS61002	374002	GC044030	374423	GC044060	3815A168	GC015011	3910013A20	GC041060
357407272MX	GDS61002	374003	GC044049	374442	GDS44027	3815A169	GC015011	3910015A05	GC041060
357407311	GC053007	374013	GCI44004	374443	GDS44026	3815A170	GC015011	3910016E00	GC041063
357407449AX	GDS61001	374014	GC044055	374446	GCI44009	3815A183	GCI39037	3910016E02	GC041063
357407450V	GDS61002	374015	GC044057	374461	GC044006	3815A184	GCI39036	3910016R05	GC041060
357407450X	GDS61002	374027	GCI44004	374466	GDS44027	3815A189	GC039113	391001702R	GDS50429
357498099	GC053007	374048	GCI44002	374468	GDS44026	3815A190	GC039113	39100173N10	GC041011
357498099A	GC053007	374049	GC099205	374470	GDS21032	3815A203	GC039178	391001C100	GC041018
357498099D	GC053007	374053	GC044013	374471	GC017007	3815A204	GC039178	391001C110	GC041024
357498099DV	GC061018	374061	GC099205	374472	GC017007	3815A205	GC039211	391001KA0B	GC041279
357498099DX	GC061018	374066	GC044041	374473	GC017007	3815A207	GC039211	391001KB0A	GC041309
357498099E	GC083036	374067	GCI44002	374473	GDS44020	3815A208	GC039211	391001KD0A	GC041251
357498099EV	GC083036	374068	GC044083	374474	GC017007	3815A307	GDS39163	391001U600	GDS41463
357498099EX	GC083036	374077	GC044046	374513	GDS44002	3815A308	GDS39164	391001V10A	GC041188
357498099X	GC053007	374078	GC044046	374523	GDS44032	3815A309	GDS39104	3910020N00	GC041085
357498103	GCI83011	374091	GCI44003	374524	GDS44094	3815A309	GDS39163	3910024B00	GC041031
357498103A	GCI83011	374092	GC044046	374525	GDS44093	3815A310	GDS39105	3910024B10	GC041031
357498103B	GCI83011	374099	GCI44001	374526	GDS44092	3815A310	GDS39164	3910026E00	GC041063
357498103V	GCI83011	374100	GCI44001	374537	GDS21032	3815A390	GC039178	391002F000	GC041029
357498103X	GCI83011	374103	GDS44039	374543	GDS44029	3815A461	GC039178	391002F010	GC041030
357498104	GCI83009	374118	GCI44002	374544	GDS44031	3815A462	GC039178	391002F210	GDS41002
357498104V	GCI83009	374126	GC044057	374545	GDS44028	3815A464	GC039178	391002F605	GC041028
357498104X	GCI83009	374130	GCI44005	374547	GDS21063	3815A469	GC039178	391002F615	GC041028
357498340AX	GC061018	374145	GDS44014	374548	GDS44030	3815A470	GC039178	391002J201	GC041189
36000183	GDS62060	374147	GC044055	374549	GDS44052	3817A141	GCI51034	391002J205	GC041018
36000184	GDS62063	374148	GCI44002	374552	GDS21056	3910000Q3M	GDS18248	391002J206	GC041189
36000241	GDS62063	374175	GC044051	374561	GDS21071	3910000Q4G	GDS18248	391002J210	GC041184
36000363	GC059285	374176	GC044056	374562	GDS21062	3910000Q4H	GDS18248	391002J211	GC041055
36000439	GDS62060	374178	GDS44002	374569	GDS21073	391000153R	GC099085	391002J215	GC041184
36000440	GDS18328	374183	GDS44011	374593	GDS44080	3910001A00	GC041170	391002J216	GC041055
36000441	GDS62060	374184	GDS44059	374600	GDS44051	3910001B01	GC041172	391002S600	GC041100
36000443	GDS18194	374188	GDS60002	374612	GDS60035	3910001B02	GC041172	391002S660	GC041100
36000448	GDS18329	374195	GCI44002	374625	GDS21092	3910001B05	GC041172	391002U010	GC041154
36000449	GDS62063	374210	GDS60002	374626	GDS21053	3910001B11	GC041172	391002U210	GC041154
36000450	GDS62063	374211	GC044007	374632	GDS17044	3910001B15	GC041172	391002U310	GC041154
36000451	GDS62063	374211	GDS44002	374633	GDS44079	3910001B60	GC041172	391002Y016	GC041022
36000505	GC062035	374213	GC044007	374641	GDS21051	3910001E02	GC041061	391002Y016	GC041314
36000514	GC062035	374218	GC044020	374646	GC088047	3910001J00	GC041026	391002Y076	GC041187
36000518	GC062009	374221	GC044020	374671	GC044003	3910001J10	GC041026	391002Y115	GC041022



COMPETITOR	G-AP Ref.	COMPETITOR	G-AP Ref.	COMPETITOR	G-AP Ref.	COMPETITOR	G-AP Ref.	COMPETITOR	G-AP Ref.
<b>OE</b>		3910055A00	GC041008	3910087E10	GC041035	39100WD205	GC041118	391012Y115	GC041022
		3910055E01	GC041035	391008H315	GC041037	39100WD210	GC041155	391012Y175	GC041037
391002Y115	GC041314	391005791R	GDS50541	391008H315	GC041185	39100WD215	GC041155	391012Y175	GC041185
391002Y175	GC041037	3910058G00	GC041016	391008H515	GC041185	39100WF110	GC041184	391012Y176	GC041037
391002Y175	GC041185	3910058G60	GC041016	391008H615	GC041037	3910100Q3G	GDS18247	391012Y176	GC041185
391002Y210	GC041187	391005C510	GC041024	391008H615	GC041185	3910100Q4E	GDS18247	391012Y215	GC041187
391003113R	GDS41475	391005J010	GC041184	391008H710	GC041037	3910100Q4F	GDS18247	3910131U00	GC041021
3910031G00	GC041051	391005J016	GC041189	391008J065	GDS41297	391010115R	GDS50487	3910131U00	GC041036
3910031U00	GC041021	3910060A00	GC099204	391009742R	GDS41475	3910101B00	GC041172	3910131U10	GC041314
3910031U00	GC041036	3910060A10	GC099204	391009F601	GC041028	3910101B05	GC041172	3910132U05	GC041036
3910031U10	GC041021	3910060Y00	GC041078	391009F611	GC041028	3910101B15	GC041172	3910132U15	GC041022
3910031U10	GC041314	3910060Y05	GC041078	391009H610	GC041037	3910101E02	GC041061	3910132U15	GC041314
3910032U05	GC041021	3910060Y10	GC041003	391009J20A	GDS41452	3910101J00	GC041026	3910132U16	GC041314
3910032U05	GC041036	3910060Y15	GC041003	391009Y015	GC041251	3910101J10	GC041026	391013J210	GC041024
3910032U15	GC041022	3910061E00	GC041018	391009Y115	GC041250	3910101M15	GC041281	391013U505	GC041304
3910032U15	GC041314	3910061Y06	GC041078	39100AE415	GC041184	3910102E02	GC041061	391014021R	GC050162
3910032U16	GC041022	3910061Y16	GC041003	39100AU115	GC041282	3910103A00	GC041281	3910140Y00	GC041033
3910032U16	GC041314	391006276R	GC050162	39100AU415	GC041184	3910105E02	GC041063	3910140Y05	GC041118
391003J110	GC041054	3910062E00	GC041018	39100AU416	GC041184	391010737R	GDS99070	3910140Y06	GC041033
391003J171	GC041184	3910062Y00	GC041003	39100AW010	GC041184	391010E417	GC041043	3910141B00	GC041040
391003J210	GC041024	3910062Y05	GC041078	39100AX000	GC041188	391010E478	GC041184	3910141B00	GC041114
391003U007	GC041304	3910062Y10	GC041003	39100AX005	GC041188	391010E510	GC041306	3910141B05	GC041040
391003U507	GC041304	3910062Y15	GC041003	39100BC500	GDS41463	391010E515	GC041306	3910141B05	GC041114
3910040Y00	GC041033	3910063E00	GC041023	39100BC55A	GDS41463	391010M000	GC041001	3910141B10	GC041154
3910040Y05	GC041118	3910063Y00	GC041078	39100BC600	GDS41408	391010M005	GC041001	3910141F100	GC041040
3910040Y06	GC041033	3910063Y01	GC041078	39100BH00A	GDS41408	391010M301	GC041078	3910141F400	GC041040
3910040Y15	GC041155	3910063Y10	GC041003	39100BM580	GDS41327	391010M801	GC041118	391014440R	GDS50261
391004165R	GDS50263	3910063Y11	GC041003	39100BN710	GC041052	391010M806	GC041118	3910144B00	GC041013
3910041B00	GC041040	3910064E00	GC041023	39100C6000	GC041241	391010M900	GC041078	3910144B02	GC041013
3910041B00	GC041114	3910064E00	GC041042	39100C7400	GC041241	391010M905	GC041078	3910144B10	GC041013
3910041B05	GC041040	3910064E05	GC041018	39100CA000	GC041245	3910110A01	GC041060	3910144B12	GC041013
3910041B05	GC041114	3910064E10	GC041024	39100CA100	GC041232	3910110E02	GC041063	3910145B00	GC041040
3910041B10	GC041154	3910064Y00	GC041087	39100CA100	GC041245	3910111A00	GC041060	3910145B10	GC041154
3910041F100	GC041040	3910064Y05	GC041087	39100CC20B	GC041232	3910111A10	GC041060	3910147A00	GC041041
3910041F400	GC041040	3910065A00	GC099204	39100CN200	GC041250	3910111A20	GC041060	391014F100	GC041040
391004298R	GDS45085	3910065A10	GC099204	39100CX015	GC041184	3910111M00	GC041060	391014F100	GDS41083
3910044B00	GC041013	3910065J00	GC041018	39100CX016	GC041184	3910111M05	GC041060	391014F400	GC041012
3910044B02	GC041013	3910065J10	GC041024	39100CX115	GC041184	3910112A00	GC041060	391014F401	GDS41156
3910044B10	GC041013	3910066J011	GC041189	39100CX215	GC041184	3910112A10	GC041060	391014M470	GC041159
3910044B12	GC041013	3910066J016	GC041189	39100D4000	GC041023	3910112A20	GC041060	391014M570	GC041034
3910045B00	GC041040	3910066J071	GC041184	39100D4600	GC041018	391011327R	GDS50498	391014M575	GC041034
3910045B00	GC041114	3910066J076	GC041184	39100D5600	GC041063	3910113A00	GC041060	391014M761	GC041078
3910045B10	GC041154	3910066J915	GC041184	39100D5610	GC041063	3910113A01	GC041060	391014M761	GC041003
391004751R	GC050162	3910070A00	GC099204	39100EB300	GDS41262	3910113A10	GC041060	391014M771	GC041034
3910047A00	GC041041	3910070A10	GC041023	39100EB70A	GC041231	3910113A20	GC041060	391014N175	GC041184
391004F100	GC041040	3910070A20	GC041023	39100ED005	GC041303	391011406R	GC050162	391014N177	GC041184
391004F100	GDS41084	3910070N00	GC041018	39100ED00A	GC041303	3910116E00	GC041063	391014N275	GC041184
391004F400	GC041012	3910070N05	GC041018	39100ED105	GC041302	3910116E02	GC041063	391014U010	GC041044
391004M400	GC041239	3910070N10	GC041024	39100ED305	GC041302	3910116R05	GC041060	391014U075	GC041142
391004M465	GC041239	3910071J00	GC041005	39100ED805	GC041302	391011HC3B	GDS41437	391014V01C	GC041304
391004M470	GC041159	3910071J10	GC041007	39100EE32B	GC041308	391011KA0B	GC041279	391014V51A	GC041304
391004M475	GC041159	3910071J10	GDS41024	39100EE70A	GC041302	391011KB0A	GC041309	391014V70A	GC041304
391004M500	GC041033	3910071N00	GC041023	39100EE70B	GC041302	391011KD0A	GC041251	391015061R	GDS50498
391004M510	GC041034	3910071N04	GC041018	39100EE76A	GC041308	391011U600	GDS41451	391015061R	GDS50415
391004M570	GC041034	3910071N05	GC041018	39100EW605	GC041308	391011V10C	GC041188	3910150A00	GC041039
391004M761	GC041078	3910071N15	GC041024	39100G8100	GC041023	3910124B00	GC041031	3910150A05	GC041073
391004M761	GC041003	3910072J10	GC041010	39100JA010	GC041214	3910124B10	GC041031	3910150A10	GC041039
391004N175	GC041184	3910072J20	GC041009	39100JC20B	GC041252	3910126E00	GC041063	3910150R00	GC041018
391004N275	GC041184	3910072J20	GDS41130	39100JD02B	GC041286	391012991R	GDS50498	3910150R10	GC041018
391004V51A	GC041304	3910073J00	GC041009	39100JD24B	GC041214	391012F001	GDS41003	3910150Y00	GC041001
391004V70A	GC041304	3910073J00	GDS41004	39100JD52B	GC041214	391012F011	GC041030	3910150Y01	GC041001
3910050A00	GC041073	3910073J20	GC041010	39100JD72B	GDS41299	391012F011	GDS41003	3910150Y10	GC041002
3910050A05	GC041073	3910073J20	GDS41005	39100JD74A	GDS41475	391012F210	GDS41025	3910150Y11	GC041002
3910050A10	GC041039	3910073N00	GC041011	39100JG32C	GC041311	391012J201	GC041189	3910151Y00	GC041001
3910050A11	GC041039	3910073N10	GC041062	39100JG34B	GC041311	391012J205	GC041018	3910151Y10	GC041002
3910050R10	GC041018	3910074N00	GC041018	39100JG34C	GC041311	391012J206	GC041189	3910152A00	GC041039
3910050Y00	GC041001	3910077A00	GC041039	39100JN10A	GC041222	391012J210	GC041024	3910152Y00	GC041001
3910050Y10	GC041002	3910078G00	GC041086	39100JY04A	GC041249	391012J211	GC041189	3910152Y10	GC041002
3910051M00	GC099204	3910078G00	GC041178	39100JY04A	GDS41475	391012J215	GC041184	3910153Y00	GC041001
3910051Y00	GC041001	391007F002	GDS41464	39100M7270	GC041059	391012J216	GC041189	3910153Y10	GC041002
3910051Y10	GC041002	3910080E00	GC041023	39100OM316	GC041118	391012U310	GC041154	391015451R	GC099085
3910052A00	GC041039	3910080E05	GC041018	39100OM806	GC041118	391012Y016	GC041022	3910155A00	GC041008
3910052Y00	GC041001	391008165R	GDS50569	39100VB001	GC041053	391012Y016	GC041314	3910155E01	GC041035
3910052Y10	GC041002	391008165R	GDS50416	39100VB001	GDS41179	391012Y070	GC041037	3910158E10	GC041062
3910053Y00	GC041001	3910085E00	GC041063	39100WA015	GC041184	391012Y070	GC041185	391015J010	GC041184
3910053Y10	GC041002	3910085E10	GC041063	39100WD200	GC041118	391012Y076	GC041187	391015J016	GC041189

COMPETITOR	G-AP Ref.	COMPETITOR	G-AP Ref.	COMPETITOR	G-AP Ref.	COMPETITOR	G-AP Ref.	COMPETITOR	G-AP Ref.
<b>OE</b>		3910180E05	GC041018	391208H315	GCI41124	39211AY125	GC041046	3M513B436DAH	GDS18219
		391018299R	GDS45084	39125EL000	GC041217	39211AY625	GC041047	3M513B436KC	GDS18329
391015M310	GC041137	3910185E00	GC041063	3920164Y10	GC041014	39211BC50J	GC041047	3M513B436KE	GDS18329
391015M310	GC041256	3910185E10	GC041063	3920202E25	GC041042	39211BM427	GC041057	3M513B436KF	GDS18329
3910160A00	GC0099204	391018662R	GDS50490	3920213A91	GC041170	39211BM526	GC041048	3M513B436KG	GDS18329
3910160A10	GC0099204	391018H315	GC041037	3920401B28	GC041172	39211BM527	GC041141	3M513B436KH	GDS18329
3910160Y00	GC041078	391018H315	GC041185	392042F025	GC041029	39211BM528	GC041243	3M513B436KJ	GDS18329
3910160Y05	GC041078	391018H710	GC041037	3920511A25	GC041060	39211BM580	GC041243	3M513B437ASD	GDS18327
3910160Y10	GC041003	391018H710	GDS41127	39210A03G0	GC041095	39211BM725	GC041112	3M513B437ASE	GDS18327
3910160Y15	GC041003	391018H810	GC041037	39210Y02G0	GC041084	39211BM726	GC041052	3M513B437DAC	GDS18218
3910161E00	GC041018	391018H810	GC041185	392110E015	GC041043	39211BM727	GC009252	3M513B437DAD	GDS18218
3910161Y07	GC041078	391018J065	GDS41296	392111AA0A	GC041232	39211BU025	GC041142	3M513B437DAE	GDS18218
3910161Y17	GC041003	391019671R	GC050157	392111C100	GC041024	39211CA100	GC041232	3M513B437DAF	GDS18218
3910162E00	GC041018	391019F600	GC041028	3921124B00	GC041031	39211EB30A	GC041240	3M513B437DAG	GDS18218
3910162Y00	GC041003	391019F610	GC041028	392112F025	GC041030	39211EB31A	GC041257	3M513B437K3C	GDS18328
3910162Y05	GC041078	391019U005	GDS41409	392112F025	GC041186	39211ED100	GC041167	3M513B437KE	GDS18328
3910162Y06	GC041033	391019U20A	GDS41453	392112F026	GC041029	39211EL00B	GC041234	3M513B437KF	GDS18328
3910162Y10	GC041003	391019Y015	GC041251	392112F225	GC041028	39211EN100	GC041285	3M513B437KG	GDS18328
3910162Y15	GC041003	391019Y110	GC041250	392112J200	GC041044	3930110A01	GC041060	3M513B437KH	GDS18328
3910162Y16	GC041003	39101AE415	GC041184	392112Y010	GC041152	3930111A00	GC041060	3M513B437KJ	GDS18328
3910163E00	GC041023	39101AU075	GC041282	392112Y070	GC041037	3930112A00	GC041060	3M513B437NE	GDS18194
3910163Y00	GC041078	39101AU415	GC041184	392112Y070	GC041185	3930113A00	GC041060	3M513B437NF	GDS18194
3910163Y01	GC041078	39101AU416	GC041184	392112Y210	GC041187	3930113A01	GC041060	3M513B437NG	GDS18194
3910163Y05	GC041033	39101AW110	GC041184	3921131G00	GC041086	395003K320	GC024170	3M513B437NH	GDS18194
3910163Y11	GC041003	39101AX000	GC041188	3921131U00	GC041022	395003K370	GC024170	3M514C062FA	GC018203
3910163Y15	GC041003	39101AX005	GC041188	3921131U00	GC041314	3959551	GDS18101	3M514C062LA	GC018203
3910164E00	GC041042	39101BC500	GDS41451	3921131U10	GC041022	39710F4269	GCI41038	4000642	GC009212
3910164E05	GC041023	39101BC55A	GDS41451	3921131U10	GC041314	39710F4605	GCI41032	4000659	GC052010
3910164E15	GC041054	39101BC600	GDS41407	3921132R00	GC041018	3971101B26	GC041172	4002911	GC052003
3910164J00	GC041023	39101BH00A	GDS41407	392114F125	GC041040	3971102A05	GCI41001	40144980001	GC010009
3910164Y00	GC041087	39101BM510	GC041048	392114F126	GC041058	3971170A10	GC041017	4087120	GC084001
3910164Y05	GC041087	39101BM580	GDS41328	392114F425	GC041012	39711EE40A	GCI59036	4103255	GC052011
3910165A00	GC0099204	39101BN710	GC041052	392114F426	GC041013	39711-JD24C	GCI41108	4103263	GC052007
3910165A10	GC0099204	39101C6000	GC041241	3921150A00	GC041105	39711JG34C	GCI41108	4104909	GDS18242
3910165J00	GC041018	39101C7400	GC041241	3921150Y00	GC041001	3971202A25	GCI41001	4106378	GDS18027
3910165J05	GC041018	39101CA000	GC041245	3921150Y10	GC041002	39720ET028	GCI41117	4110154G50	GC024050
3910165J10	GC041023	39101CA100	GC041232	3921155A00	GC041008	39771-JD02B	GCI41157	4130008001	GC009158
3910165J15	GC041024	39101CN200	GC041250	3921158E10	GC041011	3B0407271N	GDS83008	4130008001	GCI44023
391016J010	GC041184	39101CX116	GC041184	3921158E15	GC041011	3B0407271NX	GDS83008	4130008001	GDS66004
391016J011	GC041189	39101D4000	GC041042	3921158G00	GC041016	3B0407272M	GDS61019	4130008012	GDS66003
391016J016	GC041189	39101D4600	GC041018	3921158G60	GC041100	3B0407341B	GCI61057	414204	GCI48002
391016J071	GC041184	39101D5600	GC041063	392115C510	GC041024	3B0498099	GC061012	4166490	GDS18242
391016J076	GC041184	39101D5610	GC041063	392115J000	GC041306	3B0498099A	GC083018	4166906	GC018069
391016J915	GC041184	39101ED005	GC041303	392115M300	GC041099	3B0498099AV	GC061012	4166909	GDS18101
3910170A10	GC041023	39101ED00A	GC041303	392115M325	GC041137	3B0498099B	GC083021	4187268	GDS18101
3910170A20	GC041023	39101ED105	GC041302	392115M425	GC041236	3B0498099BX	GC083021	4230009100	GCI85048
3910170J00	GC041006	39101ED305	GC041302	392115M426	GC041256	3B0498099C	GC083021	4230009101	GCI85048
3910170J10	GC041007	39101ED805	GC041302	392115M427	GC041057	3B0498099CX	GC083021	42310SXA01	GDS23198
3910170J10	GDS41280	39101EE32B	GC041308	392115V010	GC041015	3B0498099D	GC061012	42311SXA01	GDS23199
3910170N00	GC041018	39101EE70A	GC041302	392115V471	GC041142	3B0498099DX	GC061012	42311SXA010M1	GDS23199
3910170N00	GDS41094	39101EE70B	GC041302	3921160Y00	GC041078	3B0498099E	GC083019	42320-S0E-300	GCI23069
3910170N05	GC041018	39101EE76A	GC041308	3921160Y10	GC041003	3B0498099EX	GC083019	4233017020	GC059001
3910170N10	GC041024	39101EW605	GC041308	3921161E06	GC041042	3B0498099H	GC083021	42330S9A305	GCI23046
3910170N15	GC041024	39101JC20B	GC041252	3921164Y00	GC041087	3B0498103	GCI83002	42330SXA01	GC023160
3910171J00	GC041005	39101JD02B	GC041286	3921165J00	GC041018	3B0498103B	GCI50019	4237019115	GC059021
3910171J10	GC041005	39101JD24B	GC041214	3921165J10	GC041023	3B0498103X	GCI83002	4237029245	GC075002
3910171N00	GC041023	39101JD52B	GC041214	3921171E15	GC041011	3C0407311A	GC061045	4237039135	GC059390
3910171N01	GC041023	39101JD52B	GDS41329	3921171J25	GC041006	3C0498099	GC061045	4242016040	GDS59049
3910171N10	GC041024	39101-JG04C	GCI41108	3921171J26	GC041007	3C113B436AB	GDS18435	4242016042	GDS59049
3910172J00	GC041005	39101JG32C	GC041311	3921171J27	GC041006	3C113B436AC	GDS18435	4242236	GC052001
3910172J10	GC0099203	39101JG34C	GC041311	3921172J25	GC041010	3C113B436BB	GDS18260	4242328	GCI44005
3910172J15	GC041017	39101JY04A	GC041249	3921173J25	GC041009	3C113B436BC	GDS18260	4246Y5	GDS10186
3910172N00	GC041018	39101JY04A	GDS41365	3921173J26	GC041009	3C113B437AB	GDS18434	4246Y9	GDS10186
3910173J00	GC041009	39101M720	GC041059	3921173J27	GC041010	3C113B437AC	GDS18434	4247399	GC084001
3910173J05	GDS41094	39101OE478	GC041184	3921178G00	GC041086	3C113B437BC	GDS18259	42601388	GCI18070
3910173J20	GC041010	39101OM316	GC041118	392117F000	GC041025	3M353B436AA	GDS27062	42601892	GCI18070
3910173J20	GDS41001	39101OM806	GC041118	3921185E00	GC041011	3M513A327BB	GC018230	4303044021	GCI59078
3910173N00	GC041011	39101VB001	GC041053	3921185E05	GC041151	3M513A327BB	GDS18219	4304005060	GCI99038
3910173N01	GC041011	39101VB001	GDS41221	3921185E10	GC041151	3M513A327MA	GC018203	4304006040	GCI59033
3910173N10	GC041062	39101WD200	GC041118	392118V000	GC041078	3M513B436DAC	GC018230	430400W030	GCI59082
3910174N00	GC041018	39101WD205	GC041118	392118V010	GC041137	3M513B436DAC	GDS18219	4304012120	GCI59100
3910175N00	GC041018	39101WF110	GC041184	3921199999	GC041011	3M513B436DAD	GDS18219	4304028010	GCI59073
3910175N10	GC041024	39101WF115	GC041184	392119F626	GC041142	3M513B436DAE	GC018230	4304028011	GCI59073
3910177A00	GC041039	39101WF715	GC041184	39211AU325	GC041142	3M513B436DAE	GDS18219	4304032040	GCI59005
3910180E00	GC041018	39101WF716	GC041184	39211AV625	GC041038	3M513B436DAF	GC018230	43040702030	GCI19001
3910180E03	GC041023	39112M7225	GC041059	39211AW325	GC041050	3M513B436DAF	GDS18219	4306SH3J00	GC023021



COMPETITOR	G-AP Ref.	COMPETITOR	G-AP Ref.	COMPETITOR	G-AP Ref.	COMPETITOR	G-AP Ref.	COMPETITOR	G-AP Ref.
<b>OE</b>		4341006151	GC059095	4341012210	GC059001	4341020331	GC059021	4341042200	GC059321
		4341006161	GC059004	4341012260	GC059020	4341020341	GC059020	4341047010	GC059153
4308412	GC084001	4341006180	GC059048	4341012270	GC059020	4341020342	GC059001	4341047020	GC059136
4308413	GC084001	4341006370	GDS59062	4341012350	GC059020	4341020342	GC059020	4341048010	GC059320
4308418	GC084001	4341006390	GDS59075	4341012351	GC059001	4341020430	GC059020	4341048030	GC059320
4313087	GC084001	434100D020	GC099282	4341012351	GC059020	4341020431	GC059020	4341048040	GC059320
431407275	GC083004	434100D080	GC099282	4341012351	GDS59195	4341020432	GC059021	4341048061	GC059175
431407311A	GC083004	434100D110	GC059207	4341012352	GC059001	4341020440	GC059005	4341048071	GC059175
431407311C	GC083003	434100D120	GDS59076	4341012352	GC059020	4341020441	GC059005	4341052010	GC059029
431407331	GCI83001	434100D120	GC059196	4341012353	GC059001	4341020444	GC059021	4341052040	GC059026
431407331E	GCI83008	434100D150	GC099282	4341012353	GC059020	4341020450	GC059020	4341052050	GC059026
431407331G	GCI83001	434100D170	GC059232	4341012360	GC059019	4341020451	GC059006	4341052070	GC059137
431407331H	GCI83002	434100D190	GC059384	4341012400	GC059018	4341020451	GC059020	4341052070	GDS59011
431498099A	GC083004	434100D280	GC059274	4341012420	GC059020	4341020470	GC059020	4341052110	GDS99180
431498099AX	GC083004	434100D292	GDS59345	4341012430	GC059020	4341020515	GC059006	4341052110	GC059152
431498099B	GC083003	434100D380	GDS59208	4341012490	GC059136	4341020530	GC059001	4341052110	GC059255
431498099D	GC083006	434100E011	GC059305	4341012500	GC059036	4341020540	GC059019	4341052120	GC059190
431498099DX	GC083006	434100E020	GC059304	4341012510	GC059047	4341020560	GC059261	4341052130	GC059190
431498099E	GC083004	434100F010	GDS59531	4341012530	GC059036	4341020580	GC059019	4341052180	GC059308
431498099F	GC083006	434100F040	GDS59494	4341012531	GC059262	4341020582	GC059120	4341052190	GC059385
431498103C	GCI83001	434100F041	GDS59494	4341012600	GC059153	4341020600	GC059261	4341052191	GC059385
431498103CX	GCI83001	434100H010	GC099128	4341012660	GC059131	4341020640	GC099124	4341052210	GC059274
431498104CX	GCI83001	434100H010A	GC099128	4341012670	GDS59191	4341020670	GC059011	4341052220	GC059274
4315132	GCI48004	434100H020B	GC045058	4341012670	GC059153	4341020680	GC059012	43410522210	GC059274
432087727	GC014012	4341010010	GC059054	4341012790	GC059387	4341020730	GC059003	4341052270	GC059274
4328468	GC084001	4341010020	GC059054	4341012810	GC059387	4341020780	GC059153	4341052280	GC059308
4330605	GDS18216	4341010021	GC059054	4341012H00	GC059001	4341020781	GC059262	4341052330	GC059274
4340087728	GC014012	4341010030	GC059054	4341016040	GDS59050	4341020800	GC059261	4341058020	GC059321
434030D061	GC159092	4341010040	GC059054	4341016042	GDS59050	4341021011	GC059261	4341059050	GC059026
434030H010	GC099128	4341010050	GC059054	4341016050	GC022001	4341021041	GC059261	4341074060	GC059384
4340310010	GCI59002	4341010060	GC059054	4341016060	GC022001	4341021060	GC059262	4341087000	GC014012
4340312040	GC059005	4341010070	GC059013	4341016070	GC059023	4341026040	GC059015	4341087103	GC014006
4340360040	GCI59049	4341010071	GC059013	4341016071	GC059023	4341028010	GC059089	4341087104	GC014006
4340502230	GC059213	4341010090	GC059054	4341016080	GC022001	4341028030	GDS59064	4341087113	GC014006
4340560015	GC059050	4341010090	GCI59002	4341016090	GC022001	4341028030	GC059175	4341087114	GC014006
4340560016	GC059050	4341010091	GCI59002	4341016111	GC059023	4341028040	GC059175	4341087115	GC014006
4340560020	GC059050	4341010101	GC059040	4341016131	GC059023	4341028051	GC059154	4341087119	GC014006
4340560030	GC059064	4341010110	GC059040	4341016132	GC059020	4341030021	GC059306	4341087120	GC014006
4340560040	GC059007	4341010121	GC059040	4341016141	GC059177	4341032010	GC059001	4341087123	GC014006
4340560050	GC059064	4341010130	GC059054	4341016150	GC059023	4341032011	GC059001	4341087126	GC014006
4340560060	GC059101	4341010131	GC059054	4341016151	GC059023	4341032020	GC059001	4341087211	GDS14006
4340560070	GC059101	4341010150	GC022001	4341016160	GC059023	4341032021	GC059001	4341087222	GC014036
4340560070	GC059041	4341010160	GC059006	4341016161	GC059023	4341032022	GC059001	4341087223	GC014020
4340560080	GC059041	4341010200	GC059005	4341016191	GC059020	4341032030	GC059001	4341087224	GC014036
4340560100	GC059027	4341010210	GC059022	4341016210	GC059023	4341032031	GC059001	4341087225	GC014020
4340560110	GC059027	4341010250	GC059227	4341016270	GC059017	4341032040	GC059001	4341087226	GC014020
4340560120	GC059046	4341012020	GC022001	4341016281	GC059017	4341032041	GC059001	4341087227	GC014036
4340598001	GC059212	4341012021	GC022001	4341020010	GC059001	4341032060	GC059001	4341087234	GC014009
4341001030	GC059063	4341012030	GC059001	4341020020	GC059001	4341032061	GC059001	4341087235	GC014018
4341002010	GC059001	4341012030	GC059036	4341020031	GC059001	4341032070	GC059003	4341087242	GC014020
4341002011	GC059001	4341012040	GC059001	4341020040	GC059001	4341032090	GC059203	4341087242	GC012034
4341002020	GC022001	4341012050	GC022001	4341020060	GC059056	4341032111	GC059010	4341087246	GC014018
4341002031	GC059337	4341012060	GC022001	4341020061	GC059056	4341032130	GC059011	4341087247	GC014018
4341002180	GC059036	4341012070	GC059001	4341020062	GC059056	4341032131	GC059011	4341087248	GC014018
4341002220	GC059047	4341012080	GC022001	4341020070	GC059056	4341032141	GC059001	4341087249	GC014018
4341002240	GC059037	4341012090	GC059001	4341020071	GC059056	4341032150	GC059012	4341087250	GC014018
4341002270	GC059226	4341012091	GC059001	4341020072	GC059056	4341032170	GC059018	4341087251	GC014008
4341002570	GDS59317	4341012100	GC059001	4341020073	GC059056	4341032180	GC059011	4341087252	GC014018
4341002570	GC059213	4341012101	GC059001	4341020100	GC059001	4341032181	GC059011	4341087253	GC014018
4341002580	GDS59447	4341012120	GC022001	4341020101	GC059021	4341032211	GC059089	4341087256	GC014018
4341002580	GC059213	4341012122	GC022001	4341020142	GC059005	4341032271	GC059203	4341087257	GC014018
4341003010	GC059058	4341012122	GC059020	4341020151	GC059020	4341032301	GC059036	4341087258	GC014018
4341005060	GC059020	4341012123	GC022001	4341020152	GC059020	4341032302	GC059262	4341087265	GC014018
4341005060	GC059021	4341012130	GC022001	4341020180	GC059001	4341033010	GC059011	4341087266	GC014018
4341005140	GC059120	4341012131	GC059020	4341020181	GC059001	4341033012	GDS59060	4341087267	GC014018
4341005241	GC059269	4341012140	GC059001	4341020220	GC059001	4341033020	GC059012	4341087268	GC014018
4341005330	GC059037	4341012141	GC059001	4341020231	GC059019	4341033022	GC059012	4341087269	GC014018
4341005370	GDS99106	4341012150	GC059001	4341020240	GC031001	4341033030	GC059065	4341087275	GC014018
4341005380	GC099302	4341012151	GC059001	4341020241	GC031001	4341033040	GC059161	4341087276	GC014018
4341005412	GC059175	4341012161	GC059070	4341020251	GC059012	4341033140	GC059161	4341087281	GDS14024
4341005420	GC099302	4341012170	GC059001	4341020281	GC059003	4341042021	GC059001	4341087401	GC014011
4341005450	GDS59552	4341012171	GC059001	4341020291	GC059019	4341042060	GC059175	4341087401	GC014027
4341005451	GDS59552	4341012180	GC059001	4341020292	GC099124	4341042120	GC059081	4341087402	GC014002
4341005720	GDS99106	4341012181	GC059019	4341020301	GC059003	4341042140	GC059081	4341087405	GDS14022
4341006050	GC059087	4341012191	GC059021	4341020310	GC059002	4341042160	GC059321	4341087405	GC014011
4341006060	GC059004	4341012200	GC059019	4341020311	GC059002	4341042180	GC059383	4341087604	GC014004



COMPETITOR	G-AP Ref.	COMPETITOR	G-AP Ref.	COMPETITOR	G-AP Ref.	COMPETITOR	G-AP Ref.	COMPETITOR	G-AP Ref.
<b>OE</b>		4342005240	GDS59272	4342012750	GC059387	4342032231	GC059036	4342087611	GC014004
		4342005260	GC059269	4342012751	GC059387	4342032232	GC059262	4342087612	GC014010
4341087605	GC014004	4342005320	GDS59107	4342016040	GDS59049	4342033010	GC059011	4342087701	GC014007
4341087606	GC014017	4342005331	GC099302	4342016042	GDS59049	4342033012	GDS59059	4342087703	GC014003
4341087608	GC014017	4342005360	GC099302	4342016050	GC022001	4342033020	GC059012	4342087706	GC014003
4341087611	GC014004	4342005400	GDS59553	4342016060	GC022001	4342033030	GC059060	4342087710	GC014012
4341087612	GC014010	4342005401	GDS59553	4342016070	GC059023	4342033040	GC059161	4342087711	GC014012
4341087701	GC014007	4342005430	GDS59520	4342016071	GC059023	4342033120	GC059060	4342087717	GC014005
4341087702	GC014007	4342005431	GDS59520	4342016080	GC022001	4342033130	GC059161	4342087718	GC014005
4341087703	GC014003	4342006050	GC059087	4342016090	GC022001	4342033172	GC059161	4342087721	GC014013
4341087706	GC014003	4342006060	GC059004	4342016101	GC059023	4342041Y10	GC059001	4342087722	GC014013
4341087710	GC014012	4342006151	GCI59033	4342016121	GC059023	4342042020	GC059019	4342087725	GC014013
4341087711	GC014012	4342006161	GC059004	4342016122	GC059023	4342042021	GC059001	4342087726	GC014012
4341087717	GC014005	4342006180	GC059161	4342016130	GC059177	4342042050	GC059167	4342087727	GC014012
4341087718	GC014005	4342006360	GDS59063	4342016140	GC059023	4342042091	GC059153	4342087728	GC014016
4341087722	GC014005	4342006390	GDS59074	4342016141	GC059023	4342042120	GC059175	4342087729	GC014016
4341087725	GC014005	434200D020	GC099282	4342016151	GC059023	4342042160	GC059383	4342087730	GC014013
4341087726	GC014012	434200D080	GC099282	4342016201	GC059017	4342047020	GC059136	4342087731	GC014012
4341087727	GC014012	434200D100	GDS59077	4342020010	GC059001	4342047030	GDS59377	4342087735	GC014012
4341087730	GC014005	434200D150	GC099282	4342020020	GC059001	4342048010	GC059320	4342087739	GC014096
4341087731	GC014012	434200D170	GC059232	4342020040	GC059056	4342048030	GC059320	4342087745	GC041323
4341087732	GC014012	434200D190	GC059384	4342020041	GC059056	4342048042	GC059173	4342087746	GC014001
4341087735	GC014012	434200D322	GDS59343	4342020042	GC059056	4342048050	GC059320	4342087765	GC014096
4341087746	GC014001	434200D370	GDS59206	4342020050	GC059056	4342048061	GC059175	4342087766	GC014096
4341087772	GC014072	434200E011	GC059305	4342020051	GC059056	4342048090	GC059294	4342087773	GC014072
4341087782	GC014072	434200F011	GDS59505	4342020052	GC059056	4342048091	GC059175	4342087775	GC014072
4341087786	GC014072	434200F070	GDS59493	4342020053	GC059056	4342051Y10	GC059001	4342087776	GC014073
4341087788	GC014073	434200F071	GDS59493	4342020060	GC059001	4342052010	GC059029	4342087778	GC014073
4341087789	GC014072	434200H020	GDS59495	4342020070	GC059001	4342052010	GDS59057	4342087Z05	GDS14003
4341087790	GC014072	434200H020	GC045058	4342020111	GC059020	4342052070	GC059137	4342097204	GC014061
4341087791	GC014072	4342010020	GC059054	4342020112	GC059020	4342052110	GDS99181	4342097205	GC014052
4341087Z05	GDS14004	4342010021	GC059054	4342020113	GDS88016	4342052110	GC059152	4342097214	GC014052
4341097205	GC014061	4342010030	GC059054	4342020120	GC059001	4342052110	GC059255	4342097218	GC014061
4341097206	GC014052	4342010060	GC059054	4342020121	GC059021	4342052120	GC059190	4342097221	GC014061
4341097211	GC014061	4342010070	GC059013	4342020170	GC059001	4342052130	GC059190	4342097242	GDS14005
4341097217	GC014061	4342010071	GC059013	4342020190	GC031001	4342052180	GC059308	4342097402	GC014077
4341097221	GC014052	4342010090	GC059054	4342020191	GC031001	4342052190	GC059385	4342097402000	GC014062
4341097242	GDS14006	4342010101	GC059040	4342020193	GC031001	4342052191	GC059385	4342097403	GC014038
4341097243	GC014061	4342010110	GC059040	4342020201	GC059012	4342052210	GC059274	4342097501	GC014052
4341097244	GC014061	4342010121	GC059040	4342020231	GC059003	4342052220	GC059274	4342097502	GC014052
4341097255	GC014061	4342010130	GC059054	4342020241	GC059002	4342052261	GC059274	4342097503	GC014052
4341097403	GC014077	4342010150	GC022001	4342020281	GC059020	4342052271	GC059274	43420B1010	GC059268
4341097403000	GC014062	4342010190	GC059202	4342020290	GC059018	4342052280	GC059308	43420B1020	GC059266
4341097404	GC014038	4342012020	GC022001	4342020291	GC059001	4342058010	GC059321	43420B4010	GC099290
4341097405	GC014038	4342012021	GC022001	4342020301	GC059001	4342059050	GC059026	43420BZ010	GC059268
4341097502	GC014052	4342012030	GC022001	4342020340	GC059001	4342074050	GC059384	43420BZ020	GC059266
4341097503	GC014052	4342012040	GC059001	4342020380	GC059001	4342087000	GC014012	43420BZ041	GC099299
4341097505	GC014052	4342012041	GC059001	4342020380	GC059019	4342087103	GC014006	43420OE011	GC059305
43410B1010	GC059268	4342012060	GC022001	4342020420	GC059019	4342087104	GC014006	43420OE021	GC059304
43410B1020	GC059266	4342012070	GC059001	4342020430	GC059011	4342087113	GC014006	43420OW190	GC059304
43410B1030	GC059268	4342012071	GC059001	4342020431	GC031001	4342087114	GC014006	434300K020	GC059199
43410B2060	GC014078	4342012080	GC022001	4342020440	GC059012	4342087123	GC014006	434300K020	GDS59168
43410B2061	GC014078	4342012082	GC022001	4342020490	GC059019	4342087211	GDS14005	434300K022	GC059242
43410B4010	GC099290	4342012083	GC022001	4342020500	GC059003	4342087222	GC014036	434300K022	GDS59168
43410BZ010	GC059268	4342012090	GC022001	4342020560	GC059261	4342087223	GC014020	434300K030	GC059242
43410BZ020	GC059266	4342012091	GC059020	4342020581	GC059262	4342087224	GC014036	434300K200	GDS59004
43410BZ041	GC099299	4342012100	GC059001	4342020590	GC059261	4342087225	GC014020	4343026013	GC059016
43410OE011	GC059305	4342012101	GC059001	4342028030	GDS59051	4342087226	GC014020	4343026021	GC059016
43410OE020	GC059304	4342012110	GC059001	4342028030	GC059175	4342087227	GC014036	4343026021	GDS59031
43410OW160	GC059304	4342012111	GC059001	4342028040	GC059175	4342087234	GC014009	4343026031	GC059015
4342001030	GC059063	4342012140	GC059001	4342028090	GC059321	4342087239	GC014018	4343026032	GC059016
4342002080	GC059021	4342012141	GC059001	4342030021	GC059306	4342087240	GC014018	4343026040	GC059016
4342002200	GC059036	4342012161	GC059021	4342032010	GC059001	4342087241	GC014018	4343026041	GC059016
4342002270	GC059037	4342012191	GC059018	4342032011	GC059001	4342087243	GC014018	4343028011	GC059045
4342002270	GDS59270	4342012250	GC059020	4342032030	GC059001	4342087246	GC014018	4343028031	GC059201
4342002300	GC059226	4342012260	GC059020	4342032031	GC059001	4342087250	GC014018	4343028040	GC059073
4342002610	GDS59316	4342012330	GC059120	4342032040	GC059001	4342087254	GC014018	4343028050	GC059166
4342002610	GC059213	4342012341	GDS59196	4342032041	GC059001	4342087255	GC014018	4343028051	GC059201
4342002611	GDS59316	4342012360	GC059019	4342032050	GC059003	4342087401	GC014027	4343035010	GC059015
4342002620	GDS59268	4342012420	GC059136	4342032070	GC059203	4342087402	GC014002	4343035011	GC059016
4342002620	GC059213	4342012450	GC059036	4342032091	GC059010	4342087405	GC014011	4343035011	GDS59031
4342002D80	GDS59493	4342012580	GC059036	4342032110	GC059011	4342087406	GDS14029	4343035012	GC059016
4342005020	GC059020	4342012580	GDS59069	4342032111	GC059011	4342087406	GC014011	4343035021	GC059016
4342005080	GC059020	4342012590	GDS59192	4342032121	GC059019	4342087523	GC014008	4343035022	GC059016
4342005100	GC059120	4342012730	GC059387	4342032122	GC059019	4342087604	GC014004	4343035030	GC059034
4342005130	GC059024	4342012731	GC059387	4342032211	GC059203	4342087605	GC014004	4343060020	GC059085

COMPETITOR	G-AP Ref.	COMPETITOR	G-AP Ref.	COMPETITOR	G-AP Ref.	COMPETITOR	G-AP Ref.	COMPETITOR	G-AP Ref.
<b>OE</b>		4346049406	GC059244	4347059105	GC059190	44010SR1003	GC023023	44011S07000	GC023016
		4346059025	GC059026	4347059115	GC059035	44010SR3020	GC023023	44011S09950	GC023086
4343060040	GC059085	4346059045	GC059137	4347059455	GC059137	44010SR3030	GC023023	44011S0A951	GC023024
4343060060	GC059107	4346059055	GC059029	4347080013	GC059294	44010SR3040	GC023023	44011S10A00	GC081006
4343060061	GC059107	4346059076	GC059137	4347080018	GC059153	44010SR3901	GC023023	44011S10A50	GC023029
4343060071	GC059336	4346059115	GC059190	4347080020	GC059131	44010SR3902	GC023023	44011S2G950	GC023073
4343060080	GCI59049	4346059125	GC059035	4347080148	GC059020	44010SR3903	GC023023	44011S30950	GC023029
4346009160	GC059004	4346059365	GC059137	4347080318	GC059244	44010SR3952	GC023023	44011S30J50	GC023029
4346009270	GC059028	4346069055	GC059107	4347087180	GC014006	44010SR3J01	GC023016	44011S30N20	GC023029
4346009290	GC059022	4346069105	GC059107	4347087181	GC014006	44010SR3J02	GC023016	44011S47000	GC023035
4346009331	GC059024	4346069145	GC059085	4347087294	GC014008	44010SR3J03	GC023016	44011S47010	GC023035
4346009420	GC059092	4346080033	GC059199	4347087298	GC014008	44010SR3J04	GC023016	44011S47951	GC023029
4346009420	GDS59217	4346080035	GC059199	4347087780	GC014003	44010SR3J05	GC023016	44011SH3G12	GC023011
4346009490	GC059022	4346080094	GC059020	4347087781	GC014005	44010SR3J51	GC023016	44011SK3E00	GC023007
4346009510	GC059024	4346080125	GC059131	4347087789	GC014034	44010SR3J52	GC023016	44011SK3E10	GC023008
4346009530	GC099282	4346080145	GC059020	4347087F81	GC014005	44010SR3J53	GC023016	44011SL5000	GC023028
4346009600	GC059037	4346087180	GC014006	4347087F82	GC014005	44010SR3J54	GC023016	44011SL5N01	GC023013
4346009601	GC059037	4346087181	GC014006	4347087F88	GC014013	44010SR3J55	GC023016	44011SL5N80	GC023014
4346009611	GC059044	4346087295	GC014008	4347087F89	GC014013	44010SR7000	GC023016	44011SM4000	GC023014
4346009621	GC059226	4346087682	GC014008	4347087N82	GC014096	44010SR7010	GC023016	44011SM4010	GC023014
4346009A21	GC059226	43460876822000	GC014008	434708Z034	GC059345	44010SR7020	GC023016	44011SM4951	GC023014
4346009A22	GC059226	4346087789	GC014034	434708Z039	GC059365	44010SR7030	GC023016	44011SO4010	GC023047
4346009C80	GC099128	4346087F81	GC014005	4349287701	GC014007	44010SR7040	GC023016	44011SO4010	GCI23021
4346009D00	GC045058	4346087F86	GC014013	4349287702	GC014007	44010SS0000	GC023013	44011SOA950	GC023033
4346009M50	GC059332	4346087F98	GC041323	4349387703	GC014007	44010SS0000	GC023014	44011SOAN50	GC023033
4346009M60	GDS59354	4346087F99	GC041323	4349487702	GC014007	44010SS0010	GC023013	44011SP0951	GC081005
4346009M70	GC059232	4346087N82	GC014096	437407305	GC083006	44010SS0020	GC023013	44011SR3020	GC023023
4346009P50	GC059226	4346O19166	GC059023	4384702	GC089005	44010SS0020	GC023014	44011SR3030	GC023023
4346009P70	GC059226	4347009330	GC059183	4384734	GC089005	44010SS0030	GC023013	44011SR3040	GC023023
4346009R20	GC059213	4347009420	GC059269	4390952	GC017005	44010SS0930	GC023014	44011SR3901	GC023023
4346009R30	GC059213	4347009440	GC059028	4393155	GC017006	44010SS0960	GC023013	44011SR3902	GC023023
4346009T10	GC059131	4347009480	GC059022	4393157	GC017006	44010SS0980	GC023014	44011SR3903	GC023023
4346009V10	GC059199	4347009480	GC059028	4399325	GC052001	44010SS0981	GC023014	44011SR3952	GC023023
4346009V20	GC059199	4347009480	GC059269	44010S04010	GC023038	44010SS0982	GC023014	44011SR3J01	GC023016
4346019085	GC059054	4347009500	GC059022	44010S04951	GC023073	44010SS0983	GC023014	44011SR3J02	GC023016
4346019086	GC059054	4347009541	GC059024	44010S04961	GC023073	44010SS0J80	GC023014	44011SR3J03	GC023016
4346019095	GC022001	4347009560	GC059028	44010S04J00	GC023086	44010SS0J81	GC023014	44011SR3J04	GC023016
4346019096	GC022001	4347009740	GC059022	44010S04J01	GC023023	44010SS0J82	GC023014	44011SR3J50	GC023016
4346019165	GC059023	4347009760	GC059024	44010S04J51	GC023086	44010SS0J83	GC023014	44011SR3J51	GC023016
4346019167	GC059023	4347009780	GC099282	44010S07000	GC023016	44010SS0J84	GC023014	44011SR3J52	GC023016
4346019276	GC059020	4347009A14	GC059037	44010S08950	GC023083	44010ST3E59	GC023179	44011SR3J53	GC023016
4346019286	GC059001	4347009A15	GC059226	44010S09950	GC023086	44010ST3F00	GC023179	44011SR3J54	GC023016
4346019306	GC059001	4347009A38	GC059226	44010S0AJ50	GC023029	44010ST3G01	GC023179	44011SR3J55	GC023017
4346019365	GC059021	4347009A39	GC059226	44010S10A00	GC081006	44010ST5003	GC023099	44011SR7000	GC023016
4346019415	GC059013	4347009C90	GC099128	44010S10A10	GC081006	44010ST6003	GC023099	44011SR7010	GC023016
4346019496	GC059040	4347009L30	GDS59352	44010S10A60	GC023029	44010ST7900	GC023023	44011SR7020	GC023016
4346019516	GC059023	4347009L40	GC059232	44010S17J30	GC081006	44010ST7J30	GC081006	44011SR7030	GC023016
4346019536	GC059023	4347009S50	GC059213	44010S2G950	GC023073	44010ST7J50	GC023017	44011SR7040	GC023016
4346019556	GC059023	4347009S60	GC059213	44010S30950	GC023029	44010ST7N00	GC023016	44011SR7954	GC023016
4346019626	GC059023	4347009W20	GC059131	44010S30N20	GC023029	44010ST7N10	GC023017	44011SS0000	GC023013
4346019795	GC059136	4347019137	GC059023	44010S30N50	GC023029	44010ST7N50	GC023016	44011SS0000	GC023014
4346029056	GC059045	4347019216	GC059020	44010S47000	GC023035	44010ST7N60	GC023017	44011SS0010	GC023013
4346029057	GC059045	4347019236	GC059001	44010S47950	GC023029	44010SV1000	GC023014	44011SS0020	GC023013
4346029067	GC059016	4347019316	GC059021	44010S50010	GC099162	44010SV1010	GC023014	44011SS0020	GC023014
4346029098	GC059005	4347019496	GC059023	44010S50951	GC023126	44010SV1950	GC023014	44011SS0030	GC023013
4346029099	GC059020	4347019516	GC059023	44010SH3981	GC023011	44010SV1A00	GC023014	44011SS0930	GC023014
434602918	GC059021	4347019536	GC059023	44010SH3A03	GC023011	44010SV1A50	GC023014	44011SS0940	GC023013
4346029425	GC059182	4347019827	GC059017	44010SH3G12	GC023011	44010SV1A51	GC023014	44011SS0980	GC023014
4346035070	GC059015	4347029107	GC022001	44010SH9000	GC023020	44010SV4000	GC023013	44011SS0981	GC023014
4346039025	GC059015	4347029108	GC059020	44010SL4950	GC023014	44010SV4010	GC023013	44011SS0982	GC023014
4346039026	GC059015	4347029445	GC099124	44010SL5010	GC023028	44010SV4950	GC023014	44011SS0J82	GC023014
4346039027	GC059015	4347029446	GC099124	44010SL5N01	GC023013	44010SV4951	GC023014	44011SS0J84	GC023014
4346039046	GC059015	4347029635	GC059043	44010SL5N02	GC023014	44010SV4952	GC023014	44011SSON00	GC023013
4346039065	GC059034	4347029636	GC059043	44010SL5N80	GC023014	44010SV4N60	GC023014	44011SSON01	GC023013
4346039175	GC059015	4347039086	GC059001	44010SL5N82	GC023014	44010SV4N61	GC023014	44011SSON02	GC023013
4346039275	GC059015	4347039185	GC059060	44010SM1952	GC023014	44010SVA000	GC023013	44011SSON10	GC023013
4346049065	GC059167	4347039465	GC059431	44010SM4950	GC023014	44010SW5000	GC023035	44011SSON60	GC023014
4346049106	GC059081	4347039575	GC059431	44010SM4952	GC023014	44010SW5950	GC023029	44011SSON91	GC023014
4346049106	GC059167	4347049196	GC059081	44010SM4953	GC023014	44010SX0000	GC023035	44011ST3E70	GC051021
4346049125	GC059167	4347049226	GC059042	44010SM4A00	GC023013	44010SX0950	GC023029	44011ST3G50	GC051021
4346049126	GC059167	4347049665	GC059245	44010SO4010	GC023047	44011S04010	GC023038	44011ST3G70	GC051021
4346049146	GC059042	4347059015	GC059025	44010SO4010	GCI23020	44011S04020	GC023038	44011ST6003	GC023099
4346049165	GC059167	4347059025	GC059026	44010SOA950	GC023033	44011S04951	GC023024	44011ST7900	GC023023
4346049166	GC059167	4347059045	GC059137	44010SOAJ50	GC023029	44011S04J01	GC023023	44011ST7J30	GC081006
4346049167	GC059167	4347059065	GC059035	44010SOAN50	GC023033	44011S04J51	GC023086	44011ST7N00	GC023016
4346049405	GC059340	4347059076	GC059137	44010SP0951	GC081005	44011S05N00	GC023038	44011ST7N50	GC023016



COMPETITOR	G-AP Ref.	COMPETITOR	G-AP Ref.	COMPETITOR	G-AP Ref.	COMPETITOR	G-AP Ref.	COMPETITOR	G-AP Ref.
<b>OE</b>		44014SMGE00	GC023125	4410160GN0	GC057037	4410182020	GC088004	4410272J10	GC057039
		44014SMGE01	GC023125	4410162B10	GC057007	4410182021	GC088004	4410272K00	GDS57166
44011SV1A10	GC023014	44014SP0000	GC081005	4410162B11	GC057007	4410182313	GC088004	4410272K40	GDS57168
44011SV1A60	GC023014	44014ST3E01	GC099210	4410162B12	GC057007	4410182611	GC088004	4410275F02	GC057024
44011SV1N00	GC023014	44014ST3E51	GC051021	4410162B22	GC057007	4410183000	GC057019	4410275F20	GC057024
44011SV1N01	GC023014	44014ST7C01	GC023033	4410162D00	GC057006	4410183300	GC057019	4410275F20	GC056010
44011SV1N50	GC023014	44014ST7C51	GC023033	4410162D01	GC057006	4410183301	GC057019	4410275F31	GC057024
44011SV1N51	GC023014	44014SV4000	GC023013	4410162J01	GC057042	4410183E11	GC044001	4410275F32	GC056010
44011SV4J00	GC023014	44014SV4010	GC023014	4410162J20	GC057095	4410184012	GC032001	4410276G00	GC057157
44011SV4J50	GC023014	44014SV4950	GC023013	4410162J90	GC057042	4410184150	GC032001	4410276G01	GC057157
44011SV4N00	GC023013	44014SV4951	GC023014	4410163B10	GC057007	4410184330	GC032001	4410276G10	GC057157
44011SV4N01	GC023014	44014SWA000	GC023153	4410163B10	GCI57009	4410184331	GC032001	4410276G11	GC057157
44011SV4N50	GC023014	44014SWA010	GC023124	4410163B20	GC057007	4410184332	GC032001	4410276G40	GC057125
44011SW5000	GC023035	44014SWET01	GC023124	4410163J00	GC057042	4410185E50	GC044080	4410276G60	GDS57068
44011SW5950	GC023029	44014SX0C10	GC023118	4410163J10	GC057042	4410186041	GC088004	4410276G60	GC057125
44011SX1000	GC023035	44014SX0C11	GC023118	4410163J21	GDS99080	4410186G00	GC057062	4410276G61	GC057125
44011SX1950	GC023032	44014SX0C50	GC023118	4410163J80	GC057042	4410186G01	GC057062	4410276G70	GC057039
44011SX1951	GC023032	44014SX0C60	GC023118	4410164B10	GC057011	4410186G30	GC057105	4410276G70	GC057024
44011SX1952	GC023086	44014SX0C61	GC023029	4410164B11	GC057011	4410186G60	GC057079	4410276GK0	GC057022
44014S04952	GC023024	44014SX0C62	GC023118	4410164B12	GC057018	4410186GA0	GC057081	4410277E00	GC057017
44014S04N52	GC023024	44014SX8M02	GC023051	4410164B20	GC057011	44101A83300	GC057020	4410277E01	GC057017
44014S04N53	GC023156	44014SXSAA00	GC023124	4410165G00	GC024050	44101M72F12	GDS57077	4410277E02	GC057017
44014S0AJ51	GC081006	44014SZ3A51	GC023032	4410165J00	GC099322	44101M72F13	GDS57077	4410278011	GC088004
44014S0AJ52	GC023032	44014TA0A00	GC023103	4410167D00	GC057009	44101M79F10	GC057076	4410278012	GC088004
44014S0K000	GC023031	44014TA0A50	GC023124	4410170B12	GC057006	44101M79F50	GC057027	4410278E00	GC057009
44014S10A00	GC023080	44014TF0J00	GC023094	4410170B50	GC057006	44101M79F60	GC057027	4410278K00	GC099322
44014S10A50	GC081006	44014TL1E00	GC023135	4410171C10	GC057003	44101M79F70	GC057027	4410279C00	GC057039
44014S10A50	GC023080	44014TL1E01	GC023135	4410171C12	GC057011	44101M79F75	GC057061	4410279C00	GC057024
44014S10A51	GC023080	44014TL1E52	GC023145	4410171C30	GC057003	44101M79FA0	GC057061	4410279FA0	GC057061
44014S10A52	GC023080	4401720	GC044026	4410171C41	GC057003	44101T51K90000	GC057100	4410280000	GC057034
44014S1AE00	GC023036	4401727	GC044026	4410172K00	GDS57167	4410251K00	GDS57222	4410280001	GC057034
44014S1AE01	GC023036	4401727	GDS50166	4410172K20	GDS57169	4410251K90	GC057100	4410280E00	GC057048
44014S1BE01	GC023036	4406234	GDS18247	4410175F01	GC057024	44102-51K90	GDS57223	4410280E00	GDS57040
44014S2G951	GC023024	4406235	GDS18248	4410175F02	GC056010	4410254G50	GC057041	4410280E01	GC057048
44014S30C61	GC023080	4406518	GDS18247	4410175F20	GC057024	4410254G5000109	GC057041	4410280E01	GDS57040
44014S30C62	GC023139	4406519	GDS18248	4410175F20	GC056010	4410254J00	GC054007	4410280E0100	GDS57040
44014S3X950	GC023029	4409208	GDS44013	4410175F31	GC057024	4410255G00	GC057041	4410280E01000	GDS57040
44014S3X951	GC023118	4409210	GDS44003	4410175F32	GC056010	4410260A00	GC057006	4410280E21	GC057012
44014S3X960	GC023118	4410151K00	GC044085	4410175F51	GC057024	4410260B12	GC057007	4410280G00	GC057039
44014S3X961	GC023118	4410151K00	GDS57221	4410175F52	GC057024	4410260B20	GC057007	4410280J10	GC057149
44014S5A951	GC023039	4410151K90	GDS57197	4410175H10	GC057039	4410260B30	GC057007	4410280J50	GC057141
44014S5AJ51	GC023033	4410154G50	GC057041	4410176G00	GC057157	4410260G00	GC057037	4410281A00	GC059117
44014S5AJ52	GC023033	4410154J00	GC054007	4410176G01	GC057157	4410260G00	GCI88017	4410281A80	GC059117
44014-S5D-A50	GC023087	4410154J01	GC054007	4410176G10	GC057157	4410260G01	GC057160	4410282013	GC057006
44014-S5D-A51	GC023087	4410155G00	GC057041	4410176G11	GC057157	4410260G10	GC057160	4410282020	GC088004
44014S6DE01	GC023095	4410160A00	GC057010	4410176G40	GC057125	4410260G20	GC057159	4410282021	GC088004
44014S6DG50	GC023039	4410160A01	GC057010	4410176G60	GC057125	4410260G23	GC057015	4410282313	GC088004
44014S6FE01	GC023001	4410160A10	GC057010	4410176G61	GC057125	4410260G30	GC057015	4410282611	GC088004
44014S6M950	GC023033	4410160A20	GC057035	4410176G70	GC057039	4410260G42	GC057018	4410283000	GC057019
44014S7A950	GC023118	4410160B12	GC057007	4410176G70	GC057024	4410260G50	GC057002	4410283300	GC057019
44014S7A952	GC023139	4410160B20	GC057007	4410177E00	GC057017	4410260G52	GC057002	4410283301	GC057019
44014S7AJ50	GC023033	4410160B30	GC057007	4410177E01	GC057017	4410260G60	GC057016	4410283E10	GC044001
44014S7C950	GC041028	4410160DD0	GC088004	4410178010	GC088004	4410260G62	GC057015	4410284012	GC032001
44014S91010	GC099159	4410160G00	GC057037	4410178012	GC088004	4410260G70	GC057159	4410284150	GC032001
44014S9A010	GC099159	4410160G00	GCI57002	4410178E00	GC057009	4410260GB0	GC057037	4410284330	GC032001
44014S9A020	GC023034	4410160G01	GC057037	4410178F20	GC057024	4410260GH0	GC057037	4410284331	GC032001
44014SABN21	GC023030	4410160G20	GCI57005	4410178G30	GC057024	4410260GN0	GC057037	4410284A00	GC099354
44014SABN22	GC023030	4410160G20	GC057014	4410178K00	GC099322	4410262B11	GC057007	4410285E50	GC044080
44014SCAE01	GC023034	4410160G22	GCI57005	4410179FA0	GC057061	4410262B12	GC057007	4410286041	GC088004
44014SD4950	GC023081	4410160G22	GC057014	4410180000	GC057034	4410262B22	GC057007	4410286G30	GC057105
44014SD5A51	GC023105	4410160G23	GC057015	4410180001	GC057034	4410262J20	GC057095	4410286G30000	GC057105
44014SDCA00	GC023056	4410160G31	GC057159	4410180E00	GC057048	4410262J30	GC057095	4410286G50	GC057079
44014SDCA50	GC023034	4410160G33	GC057015	4410180E00	GDS57039	4410262J90	GC057042	4410286G60	GC057062
44014SDCA51	GC023034	4410160G42	GC057018	4410180E01	GC057048	4410263B10	GC057007	4410286GD0	GC057081
44014SDETOOL	GC023056	4410160G43	GC057018	4410180E01000	GDS57039	4410263B20	GC057007	44102M72F12	GC057001
44014SDZT00	GC023033	4410160G44	GC057018	4410180E21	GC057012	4410263B21	GC057007	44102M72F12	GC057048
44014SE0000	GC023012	4410160G50	GC057002	4410180G00	GC057039	4410263J00	GC057042	44102M72F12	GDS57078
44014SE0910	GC023026	4410160G51	GC057159	4410180G11	GC057039	4410263J30	GC057042	44102M72F13	GDS57078
44014SE0930	GC023021	4410160G52	GC057002	4410180G11	GC057024	4410263J50	GC057042	44102M72F21	GC057001
44014SE0J51	GC023012	4410160G60	GC057016	4410180G20	GC057039	4410263J80	GC057042	44102M72F41	GC057001
44014SELTOO	GC023106	4410160G62	GC057015	4410180J11	GC057092	4410264B10	GC057011	44102M76M00	GDS57211
44014SENP00	GC023094	4410160G70	GC057159	4410180J50	GC057141	4410264B11	GC057011	44102M79F50	GC057027
44014SF1970	GC023014	4410160G72	GC057015	4410180JE0	GC057141	4410264B12	GC057018	44102M79F60	GC057027
44014SF1971	GC023017	4410160G90	GC057160	4410181A00	GC059117	4410264B20	GC057011	44102M79F70	GDS32008
44014SM4000	GC023014	4410160GB0	GC057037	4410181A80	GC059117	4410265J00	GC099322	44102M79F75	GDS57128
44014SM4020	GC023013	4410160GH0	GC057037	4410182013	GC057006	4410272F00	GC057008	44102T51K90000	GC057100



COMPETITOR	G-AP Ref.	COMPETITOR	G-AP Ref.	COMPETITOR	G-AP Ref.	COMPETITOR	G-AP Ref.	COMPETITOR	G-AP Ref.
<b>OE</b>		44305S5A950	GC023039	44305SE0J20	GC023021	44305SK7J81	GC023017	44306S10J50	GC099248
4410478800000	GC012006	44305S5AJ50	GC023033	44305SE0J21	GC023021	44305SK7J82	GC023017	44306S1AE21	GC023118
4410578B00000	GC012006	44305S5AJ60	GC023033	44305SE0J22	GC023021	44305SK7J83	GC023017	44306S2G950	GC023073
441072651586	GC054001	44305S5AJ61	GC023033	44305SE0J23	GC023021	44305SK7J84	GC023017	44306S2G960	GC023073
441072651706	GC054001	44305S5AN50	GC023039	44305SE7E01	GC023021	44305SM1000	GC023013	44306S2H950	GC023033
4411463B60	GC057003	44305S5C950	GC023033	44305SEFFE00	GDS23027	44305SM1010	GC023013	44306S2K950	GC023182
4411578010	GC088004	44305S5CN50	GC023033	44305SELT00	GDS23071	44305SM1950	GC023014	44306S2KN50	GC023182
4411582020	GC057006	44305S5CN51	GC023033	44305SELT00	GC023106	44305SM1951	GC023014	44306S2L950	GC023182
4411582611	GC088004	44305S5DA01A	GDS23066	44305SE0923	GC023071	44305SM1980	GC023014	44306S2T950	GC023073
4411584312	GC057053	44305S5DA51	GDS23097	44305SF0910	GC023017	44305SM1981	GC023014	44306S3N950	GC023029
4411584332	GC057053	44305S5DA950	GC023039	44305SF1305	GC023016	44305SM1A80	GC023014	44306S3N951	GC023029
4411584332	GC057053	44305S74E00	GC023002	44305SF1405	GC023017	44305SM1A81	GC023014	44306S3R951	GC023029
4411584342	GC057053	44305S74E01	GC023002	44305SF1910	GC023016	44305SM4000	GC023013	44306S47N50	GC023118
4411660B20	GC057007	44305S74E51	GC023002	44305SF1911	GC023016	44305SM4010	GC023013	44306S5A950	GC023039
4411660B30	GC057007	44305S7A950	GC023118	44305SF1912	GC023016	44305SM4020	GC023013	44306S5AJ51	GC023033
4411662B10	GC057007	44305S7B950	GC023033	44305SF1913	GC023016	44305SM4030	GC023013	44306S5AJ61	GC023033
4411663B20	GC057006	44305S9A000	GDS23074	44305SF1914	GC023016	44305SM4040	GC023013	44306S5AJ62	GC023033
4411663E10	GC057007	44305S9AN00	GC023034	44305SF1915	GC023013	44305SM4050	GC023013	44306S5AN50	GC023039
4411664B10	GC057011	44305SA0003	GC023003	44305SF1970	GC023017	44305SM4950	GC023014	44306S5DA01A	GDS23068
4411684332	GC057053	44305SA2010	GC023041	44305SF1971	GC023017	44305SM4951	GC023014	44306S5DA51	GDS23089
4411684342	GC057053	44305SA2030	GC023041	44305SF1972	GC023017	44305SM4952	GC023014	44306S7A950	GC023118
4411698	GDS50562	44305SA5000	GC023004	44305SF1973	GC023017	44305SM4953	GC023014	44306S7B950	GC023033
4411699	GDS50557	44305SA5010	GC023004	44305SF1974	GC023014	44305SM4954	GC023014	44306S9AN00	GC023034
4411762B10	GC057007	44305SA5020	GC023005	44305SF1975	GC023014	44305SM4955	GC023014	44306SA0013	GC023003
4411763B20	GC057007	44305SA5620	GC023005	44305SF1G10	GC023016	44305SM4980	GC023013	44306SA2010	GC023041
4411765J00	GC057067	44305SA5622	GC023071	44305SF1G11	GC023016	44305SM4981	GC023013	44306SA2030	GC023041
4411772F00	GCI188017	44305SA5640	GC023005	44305SF1G12	GC023016	44305SM4982	GC023013	44306SA5000	GC023004
44127M79F01	GCI57034	44305SA5641	GC023005	44305SF1G13	GC023016	44305SM4982	GC023014	44306SA5010	GC023004
4413160A00	GC057010	44305SA5971	GC023071	44305SF1G14	GC023016	44305SM4983	GC023013	44306SA5020	GC023005
4413160A01	GC057035	44305SA7000	GC023018	44305SF4010	GC023042	44305SM4984	GC023013	44306SA5620	GC023005
4413260A00	GC057035	44305SAA000	GC023104	44305SF4020	GC023042	44305SM4J80	GC023014	44306SA5640	GC023005
4413397	GC018105	44305SAP950	GC023182	44305SF4900	GC023042	44305SM4J81	GC023014	44306SA5641	GC023005
441407305B	GC083017	44305SB0621	GC023005	44305SF4901	GC023042	44305SM4J82	GC023014	44306SA5950	GC023005
44144516	GDS44013	44305SB0622	GC023005	44305SF4J21	GC023006	44305SM4J83	GC023014	44306SA5951	GC023005
4414517	GDS44003	44305SB0623	GC023005	44305SF4J22	GC023006	44305SM4J84	GC023014	44306SA5970	GC081001
4414517	GC044034	44305SB0624	GC023005	44305SF4J23	GC023006	44305SN4003	GC023099	44306SA5971	GC081001
4417909	GDS18301	44305SB2000	GC023042	44305SF4J24	GC023006	44305SNA000	GC023155	44306SA7000	GC023018
4417910	GDS18271	44305SB2010	GC023042	44305SF4J40	GC023006	44305SNA000	GDS23023	44306SAA000	GC023104
4417912	GDS60022	44305SB2750	GC023006	44305SF4J41	GC023006	44305SNAN00	GC023155	44306SA0013	GC023003
4420054	GDS18248	44305SB2751	GC023006	44305SF4J42	GC023006	44305SNLT00	GDS23023	44306SAP950	GC023182
4420055	GDS18247	44305SB2960	GC023006	44305SFA000	GC023104	44305SNW000	GC023153	44306SB0010	GC081001
4422057	GDS18248	44305SB2961	GC023006	44305SH3000	GC023042	44305SNW010	GC023153	44306SB0040	GC081001
4422058	GDS18247	44305SCAG00	GC099159	44305SH3010	GC023042	44305SOA960	GC023033	44306SB0621	GC023005
4430546	GDS50557	44305SCAG00	GDS23074	44305SH3960	GC023011	44305SOAJ60	GC023029	44306SB0622	GC023005
4430547	GC018105	44305SD4020	GC023044	44305SH3960	GDS23030	44305SOAJ61	GC023029	44306SB0624	GC023005
4430560040	GC059007	44305SD5003	GC023098	44305SH3961	GC023011	44305SOAN60	GC023033	44306SB0670	GC023005
44305629671	GC081002	44305SD5013	GC023098	44305SH3961	GDS23030	44305SP0951	GC081005	44306SB0671	GC023005
44305634003	GC023003	44305SD5023	GC023099	44305SH3970	GC023011	44305SP0952	GC081005	44306SB2000	GC023042
44305634013	GC023003	44305SD5901	GC023099	44305SH3971	GC023011	44305SP0953	GC081005	44306SB2010	GC023042
44305634023	GC023003	44305SD9013	GC023020	44305SH3980	GC023011	44305SWA900	GC023153	44306SB2750	GC023006
44305634033	GC023003	44305SDETOOL	GC023056	44305SH3981	GC023011	44305SX0C51	GC023118	44306SB2751	GC023006
44305671003	GC023003	44305SE0000	GC023011	44305SH3A00	GC023011	44305SY000	GC023173	44306SB2960	GC023006
44305671023	GC023003	44305SE0010	GC023011	44305SH3A01	GDS23030	44305SYZ000	GC023155	44306SB2961	GC023006
44305688000	GC023004	44305SE0020	GC023011	44305SH3A01	GC023011	44305TA0J00	GC023168	44306SCAG00	GC099159
44305688020	GC023004	44305SE0912	GC023021	44305SH3A01	GDS23030	44305TA1A00	GC023153	44306SCAG00	GDS23011
44305689010	GC023041	44305SE0913	GC023021	44305SH3A21	GC023042	44305TA2J00	GC023168	44306SD4E71	GC023081
44305689030	GC023041	44305SE0920	GC023021	44305SH3G00	GC023011	44305TF0J00	GC023094	44306SD5003	GC023098
44305689601	GC023003	44305SE0921	GC023021	44305SH3G00	GDS23030	44305TF6N01	GC023165	44306SD5013	GC023098
44305692003	GC023003	44305SE0922	GC023021	44305SH3G01	GC023011	44305TL1E00	GC023168	44306SD5023	GC023099
44305692671	GC081002	44305SE0923	GC023021	44305SH3G01	GDS23030	44305TL3000	GC023168	44306SD5901	GC023099
44305S04J60	GC023033	44305SE0924	GC023021	44305SH3G10	GC023011	44306634013	GC023003	44306SD5J01	GC023099
44305S0AJ60	GC023118	44305SE0925	GC023021	44305SH3G11	GC023011	44306657000	GC023003	44306SDETOOL	GC023056
44305S0AJ61	GC023118	44305SE0G01	GC023011	44305SH3G21	GC023071	44306657023	GC023003	44306SE0000	GC023011
44305S10C61	GC023029	44305SE0G02	GC023011	44305SH7J83	GC023017	44306659000	GC023003	44306SE0010	GC023011
44305S10J50	GC099248	44305SE0G10	GC023021	44305SH9000	GC023020	44306659010	GC023003	44306SE0020	GC023011
44305S1AE21	GC023118	44305SE0G11	GC023021	44305SH9003	GC023020	44306671003	GC023003	44306SE0910	GC023021
44305S2G950	GC023073	44305SE0G12	GC023021	44305SK7J21	GC023016	44306671033	GC023003	44306SE0911	GC023021
44305S2G960	GC023073	44305SE0G13	GC023021	44305SK7J22	GC023016	44306688000	GC023004	44306SE0912	GC023021
44305S2H951	GC023033	44305SE0G20	GC023021	44305SK7J23	GC023016	44306689010	GC023041	44306SE0913	GC023021
44305S2K950	GC023182	44305SE0G21	GC023021	44305SK7J24	GC023016	44306689020	GC023004	44306SE0920	GC023021
44305S2L950	GC023182	44305SE0G22	GC023021	44305SK7J70	GC023017	44306689601	GC023003	44306SE0921	GC023021
44305S2T950	GC023073	44305SE0G23	GC023021	44305SK7J71	GC023017	44306692003	GC023003	44306SE0922	GC023021
44305S3N950	GC023029	44305SE0G24	GC023021	44305SK7J72	GC023017	44306692671	GC081002	44306SE0923	GC023021
44305S3N951	GC023029	44305SE0G25	GC023021	44305SK7J73	GC023017	44306S0AJ60	GC023118	44306SE0924	GC023021
44305S3R951	GC023118	44305SE0J00	GC023011	44305SK7J74	GC023017	44306S0AJ61	GC023118	44306SE0980	GC023011
44305S47N50	GC023118	44305SE0J01	GC023011	44305SK7J75	GC023017	44306S10C51	GC023029	44306SE0981	GC023011



COMPETITOR	G-AP Ref.	COMPETITOR	G-AP Ref.	COMPETITOR	G-AP Ref.	COMPETITOR	G-AP Ref.	COMPETITOR	G-AP Ref.
<b>OE</b>		44306SH3G10	GC023011	44310SK7J02	GC081006	46307103	GC182005	46308072	GDS82004
		44306SH3G11	GC023011	44310SIOA10	GC081006	46307105	GC029001	46308205	GC082018
44306SE0982	GC023011	44306SK7J21	GC023016	44310SL5N00	GC081006	46307107	GC017022	46308206	GC017031
44306SE0G01	GC023011	44306SK7J22	GC023016	44310SM4310	GC081006	46307108	GC017022	46308230	GC017051
44306SE0G02	GC023011	44306SK7J23	GC023016	44310SM4901	GC023013	46307109	GDS17001	46308235	GC082024
44306SE0G10	GC023021	44306SK7J73	GC023017	44310SM4980	GC023013	46307110	GDS17038	46308266	GC082023
44306SE0G11	GC023021	44306SK7J74	GC023017	44310SO4300	GC023047	46307121	GC017020	46308276	GC082026
44306SE0G12	GC023021	44306SK7J75	GC023017	44310SO4300	GCI23020	46307122	GC017019	46308315	GC017022
44306SE0G13	GC023021	44306SK7J81	GC023017	44310SO4900	GC023047	46307134	GC082008	46308316	GCI17021
44306SE0G20	GC023021	44306SK7J82	GC023017	44310SO4900	GCI23021	46307147	GDS17039	46308322	GC017053
44306SE0G21	GC023021	44306SK7J83	GC023017	44310SR3A12	GC023017	46307169	GC082006	46308324	GDS17146
44306SE0G22	GC023021	44306SM1000	GC023013	44310SS0910	GC023046	46307171	GC082003	46308329	GDS17066
44306SE0G23	GC023021	44306SM1010	GC023013	44310ST7900	GC081006	46307182	GC017032	46308330	GDS17172
44306SE0G24	GC023021	44306SM1950	GC023014	44310TL1305	GCI23023	46307223	GCI82004	46308335	GCI17028
44306SE0J20	GC023021	44306SM1951	GC023014	44333S04N01	GC023030	46307234	GC017011	46308336	GCI17020
44306SE0J21	GC023021	44306SM1952	GC023014	443407305	GC083006	46307241	GC017042	46308337	GC017052
44306SE0J22	GC023021	44306SM1980	GC023014	443407305B	GC083014	46307246	GC082012	46308345	GDS17082
44306SE0J23	GC023021	44306SM1981	GC023014	443407305C	GC083005	46307299	GC082013	46308347	GDS41007
44306SE0J24	GC023021	44306SM1A80	GC023014	443407311	GC083013	46307308	GC082002	46308366	GDS17147
44306SE0J25	GC023021	44306SM1A81	GC023014	443407331D	GCI83001	46307309	GC082017	46308367	GDS17066
44306SEAN50	GC023034	44306SM4000	GC023013	443407331G	GCI83001	46307322	GC017015	46308369	GC017055
44306SEAN50	GDS81047	44306SM4010	GC023013	44340SN7003	GC051017	46307345	GDS82001	46308370	GC017060
44306SEFE00	GDS23026	44306SM4020	GC023013	44340SN7315	GC051001	46307346	GDS82002	46308371	GC017045
44306SELTOO	GDS23070	44306SM4030	GC023013	443498099B	GC083014	46307366	GC017037	46308391	GCI10038
44306SELTOOL	GC023106	44306SM4040	GC023013	443498099BX	GC083014	46307367	GC017024	46308399	GCI17042
44306SF1305	GC023016	44306SM4050	GC023013	443498099C	GC083014	46307368	GDS17190	46308404	GDS17193
44306SF1307	GC023016	44306SM4060	GC023013	443498099CX	GC083014	46307369	GDS17191	46308405	GDS17192
44306SF1315	GC023016	44306SM4950	GC023014	443498099D	GC083013	46307394	GC017008	46308409	GDS17054
44306SF1405	GC023017	44306SM4951	GC023014	443498099E	GC083005	46307398	GC017042	46308463	GC017063
44306SF1406	GC023016	44306SM4952	GC023014	443498099EX	GC083005	46307406	GC017016	46308483	GC017055
44306SF1910	GC023016	44306SM4953	GC023014	443498099F	GC083106	46307408	GDS17038	46308484	GC017045
44306SF1911	GC023016	44306SM4954	GC023014	443498103	GCI83002	46307420	GC017017	46308485	GC017060
44306SF1912	GC023016	44306SM4955	GC023014	443498103A	GCI83001	46307457	GCI82004	46308487	GCI10038
44306SF1913	GC023016	44306SM4956	GC023014	4441033030	GC059060	46307466	GDS17032	46308488	GC017021
44306SF1914	GC023016	44306SM4980	GC023013	44430SN7315	GC051001	46307467	GDS17033	46308488	GCI17022
44306SF1916	GC023013	44306SM4981	GC023013	44511SE0406	GC023026	46307515	GCI82003	46308488	GCI17028
44306SF1970	GC023017	44306SM4982	GC023013	4465504	GC084001	46307516	GC017029	46308497	GCI17042
44306SF1971	GC023017	44306SM4982	GC023014	447498099	GC083106	46307542	GCI99008	46308498	GCI10038
44306SF1972	GC023017	44306SM4983	GC023013	4475837	GC084001	46307543	GCI17015	46308499	GCI17028
44306SF1973	GC023017	44306SM4984	GC023013	4490557	GC018067	46307557	GC017014	46308500	GCI17020
44306SF1974	GC023017	44306SM4J80	GC023014	4490558	GDS18041	46307565	GDS17032	46308501	GCI17022
44306SF1975	GC023014	44306SM4J81	GC023014	4501957	GC018067	46307572	GC082018	46308502	GCI17021
44306SF1976	GC023014	44306SM4J82	GC023014	4501957	GDS18263	46307617	GC017056	46308518	GC017028
44306SF1G10	GC023016	44306SM4J83	GC023014	4507298	GDS18260	46307659	GC017031	46308519	GC017053
44306SF1G11	GC023016	44306SM4J84	GC023014	4507299	GDS18434	46307674	GDS17017	46308521	GDS17147
44306SF1G12	GC023016	44306SN4003	GC023099	4507300	GDS18259	46307678	GDS17019	46308522	GDS17066
44306SF1G13	GC023016	44306SNA000	GC023155	4511435	GDS89002	46307685	GC082014	46308523	GDS17054
44306SF1G14	GC023016	44306SNA000	GDS23022	4511436	GDS89028	46307687	GDS82005	46308524	GC017028
44306SF1G15	GC023016	44306SNA900	GC023155	4511438	GDS89028	46307695	GDS16001	46308538	GC017070
44306SF1J71	GC023014	44306SNAN00	GC023155	4511443	GDS89002	46307698	GDS82005	46308551	GC017063
44306SF4010	GC023042	44306SNLT10	GDS23022	4511445	GDS89002	46307710	GC017028	46308552	GC017070
44306SF4020	GC023042	44306SNW000	GC023153	4511448	GDS89028	46307742	GC017009	46308677	GC099348
44306SF4J21	GC023006	44306SOA960	GC023033	4512586	GC018207	46307792	GDS17033	46308703	GC010094
44306SF4J22	GC023006	44306SOAJ60	GC023029	4512587	GC018067	46307815	GDS16002	46308706	GC017063
44306SF4J23	GC023006	44306SOAJ61	GC023029	4512587K	GC018067	46307877	GC017028	46308707	GC017053
44306SFA000	GC023104	44306SOAN60	GC023033	4512588	GC018207	46307884	GCI17027	46308710	GC082024
44306SFB000	GC023104	44306SP0952	GC081005	4515857	GC018067	46307886	GC017026	46308735	GC017026
44306SH3000	GC023042	44306SP0953	GC081005	4543301101	GC017048	46307887	GC017009	46308759	GC017063
44306SH3010	GC023042	44306SX0C51	GC023118	4602016	GC018005	46307889	GC017014	46308773	GC099298
44306SH3960	GC023011	44306SYY000	GC023173	4602017	GDS18434	46307901	GC082017	46308798	GC082024
44306SH3960	GDS81013	44306SYZ000	GC023155	4602023	GDS18259	46307906	GC017031	4641005310	GC059024
44306SH3961	GC023011	44306TA0J00	GC023168	4603300935	GC035018	46307913	GC082018	4641528	GDS89002
44306SH3961	GDS81013	44306TA1A00	GC023153	4610572	GC052007	46307914	GC017030	4641672	GDS89002
44306SH3970	GC023011	44306TA2J00	GC023168	4610580	GC052001	46307924	GC017009	4641883AA	GC089029
44306SH3971	GC023011	44306TF0J00	GC023094	4615962	GDS18435	46307934	GC099298	4641883AC	GC089029
44306SH3980	GC023011	44306TL1E00	GC023168	4615963	GDS18260	46307988	GDS41007	4641975	GDS88024
44306SH3981	GC023011	44306TL3000	GC023168	463007241	GC017042	46307998	GDS41006	4641981	GDS88024
44306SH3A00	GC023011	44310S0A900	GC023038	46302199SX	GDS17014	46307999	GDS41007	4641981K	GDS88024
44306SH3A00	GDS81013	44310S10310	GCI23017	46302200SX	GDS17013	46308000	GC017043	46429632	GC017032
44306SH3A01	GC023011	44310S10901	GCI23023	46307032	GC082003	46308020	GC017027	4646009331	GC059024
44306SH3A01	GDS81013	44310S10A00	GC081006	46307034	GC082006	46308024	GDS82002	46477176	GDS17187
44306SH3A21	GC023042	44310S10A10	GC081006	46307047	GC017017	46308025	GDS82003	465001C060	GC024041
44306SH3G00	GC023011	44310S50300	GC099162	46307080	GC017039	46308026	GDS82004	4660487	GDS88024
44306SH3G00	GDS81013	44310S5A300	GCI23018	46307082	GC017023	46308067	GC017028	4700644	GC044001
44306SH3G01	GC023011	44310S9A305	GCI23013	46307083	GC082005	46308070	GC082025	4701110	GC044001
44306SH3G01	GDS81013	44310SH3J00	GC081006	46307094	GC017021	46308071	GDS82003	4705753	GC044001

COMPETITOR	G-AP Ref.	COMPETITOR	G-AP Ref.	COMPETITOR	G-AP Ref.	COMPETITOR	G-AP Ref.	COMPETITOR	G-AP Ref.
<b>OE</b>		495001E610	GC024047	4950038950	GDS24003	495012F110	GDS27168	4950824A00	GC024003
		495001E650	GC024047	495003A202	GC027009	495012H002	GC024077	4950824A01	GC024003
4705754	GC044001	495001F500	GDS24046	495003A205	GC027009	495012L010	GDS24283	4950825A00	GC024033
4707438	GC044080	495001G011	GDS27105	495003A206	GC027009	495012L210	GDS24296	4950825B00	GC024033
4710013	GDS57221	495001G051	GDS27155	495003A207	GC027009	495012L410	GDS24305	4950828A00	GC089004
4710017	GDS57222	495001G110	GDS27156	495003A217	GC024029	495012P000	GDS24117	4950828B00	GC024001
4710021	GDS57197	495001G150	GDS27186	495003A240	GC024130	495012P000	GCI24058	4950828E00	GC089003
4711022	GDS57223	495001H010	GDS27185	495003A310	GC024066	495012P200	GDS24232	4950828H00	GC024006
4713189	GDS16003	495001H110	GC024095	495003A311	GC024066	495012P250	GCI24054	4950828H01	GC024006
4720380	GDS16004	495001H210	GC027080	495003A312	GC024066	495012V100	GDS24289	4950828J00	GC024006
4720381	GDS16003	495001H310	GC024152	495003A312	GDS24158	495013A200	GC027009	4950828J01	GC024006
4804589	GCI88035	495001J250	GC024152	495003C451	GDS27002	495013A201	GC027009	4950828K00	GC024006
4804590	GCI88034	495001J400	GDS24153	495003E000	GDS27065	495013A202	GC027009	4950828K01	GC024006
4804592	GC022009	495001K200	GDS39189	495003E110	GDS27064	495013A210	GC024029	4950829A00	GC024006
4804594	GCI12009	495003K300	GDS39190	495003K200	GDS24031	495013A390	GC024066	4950829C00	GC039067
4808125	GDS88024	495003K400	GC024095	495003K250	GDS24032	495013A392	GC024066	4950838B00	GC024027
4808135	GDS88024	495003K410	GC027080	495003K250	GC024058	495013S251	GDS24261	4950838E00	GC039104
4808568L	GDS89039	495003K460	GC024152	495003K300	GDS24127	495013S260	GDS24228	4950838E00	GC024014
4808578	GDS89039	495003L500	GC024152	495003K410	GDS24128	495013S261	GDS24228	4950838E00	GC027008
4808578L	GDS89039	495003L551	GDS27142	495003K460	GDS24128	495013S261	GDS24228	4951038200	GC027008
4808580K	GDS89039	495003S201	GC024132	495003L500	GDS24143	495013S271	GDS24261	4951038500	GC027009
4808873	GDS88024	495003S210	GCI39052	495003L551	GDS24142	495013S280	GDS24228	495361R001	GCI39052
4808883	GC089029	495003S211	GDS24246	495003S201	GDS24262	495013V270	GDS24261	4959107010	GC027072
4808883	GDS88024	495003S211	GDS24260	495003S210	GDS24229	495013X100	GDS24321	4959107090	GC027077
4808883J	GDS88024	495003S211	GDS24290	495003S211	GDS24229	495013X110	GDS24265	4959107091	GC027072
4808965	GDS88024	495003V200	GDS24294	495003V200	GDS24262	495013X200	GDS24249	4959107091	GDS34169
4808971	GDS88024	495003X100	GDS24299	495003X100	GDS24264	495013Z450	GDS24347	4959107110	GC027072
4808971K	GDS88024	495003X110	GDS24293	495003X110	GDS24272	495014D001	GDS27151	4959107191	GC027072
4950002010	GC024011	495003X200	GDS27117	495003X200	GDS24248	495014D201	GDS27114	4959107210	GC034094
4950002450	GDS27017	495003Z200	GDS24038	495003Z200	GDS24262	495014D700	GDS27152	4959107291	GC034094
4950002460	GDS24033	495004D201	GC024075	495004D201	GDS27115	4950522A00	GCI24009	495911F210	GC027067
4950002550	GDS27017	4950107000	GDS24129	4950107000	GC027077	4950525B00	GCI24010	495911G510	GC027068
4950002560	GDS24033	4950107010	GC039105	4950107010	GC027072	4950528B01	GC089004	495911G591	GC027068
4950002550	GDS24033	4950117000	GDS39211	4950117000	GC024036	495052EA00	GCI24030	495911H011	GC024095
4950007000	GCI24019	4950117050	GC024065	4950117050	GC024036	495052PA20	GCI24066	495911H012	GC024095
4950007010	GC027072	4950117150	GDS39214	4950117150	GC024061	4950538C00	GCI24008	495911H111	GC027080
4950007010	GDS27132	4950117510	GC024075	4950117510	GC024038	4950538E00	GCI24001	495911H112	GC027080
4950007050	GC027077	495011D200	GC024075	495011D200	GDS27111	4950702A00	GC024004	495911H211	GC024152
4950007060	GC027072	495011F200	GDS39213	495011F200	GDS24172	4950702A10	GC024004	495911H212	GC024152
4950007060	GDS99216	495011H010	GDS39212	495011H010	GC024095	4950702A20	GC024011	495911H311	GC024152
4950007110	GDS27207	495011H110	GDS39122	495011H110	GC027080	4950702A30	GC024011	495911H312	GC024152
4950007160	GDS27206	495011H210	GC024091	495011H210	GC024152	4950705A00	GC024004	495912F000	GC099294
495000X000	GDS24156	495011H310	GC024091	495011H310	GC024152	4950705A00	GC099025	495912F010	GC099294
495000X004	GC034146	495011L010	GC024091	495011L010	GC024095	4950721000	GC089004	495912F090	GC099294
495000X010	GDS24157	495011L110	GC024091	495011L110	GC027080	4950722A00	GC024002	495912F091	GC099294
495000X014	GC034146	495011L210	GC024091	495011L210	GC024152	4950722B00	GC024002	495912F310	GC027073
495000X100	GDS39191	495011L310	GC024072	495011L310	GC024152	4950722C00	GC024002	495913E201	GC027014
495000X110	GDS39192	495011M010	GDS39247	495011M010	GDS27143	4950722E00	GC024002	495921F200	GCI27018
495000X300	GDS24240	495011M010	GC024001	495011M010	GC024132	4950724A00	GC024003	495921H010	GCI24039
495000X310	GDS24241	495011R000	GC024001	495011R000	GDS24247	4950724A01	GC024003	495922F000	GC027073
4950017000	GC024036	495011R010	GDS24363	495011R010	GDS24259	4950724B00	GC089004	496002E000	GDS24287
4950017050	GC024036	495011R200	GC039147	495011R200	GDS24291	4950725A00	GC024033	496002E000	GC024178
4950017100	GC024061	495011R300	GC039147	495011R300	GDS24293	4950725A20	GC024065	4994093	GDS18263
4950017150	GC024061	495011R300	GDS24054	495011R300	GDS24294	4950725B00	GC024033	4A0407271BG	GDS83050
4950017510	GC024038	495011R500	GC024090	495011R500	GDS24247	4950728A00	GC089004	4A0407271BS	GDS83060
495001C050	GC024041	495011R510	GC024090	495011R510	GDS24259	4950728E00	GC039054	4A0407271DG	GDS83060
495001C060	GC024041	495011Y000	GDS24111	495011Y000	GDS27116	4950728G00	GC024009	4A0407272BD	GDS83050
495001C250	GC024046	4950125955	GCI24030	4950125955	GDS39123	4950728G01	GC024009	4A0407272BH	GDS83051
495001C260	GC024046	4950126410	GC024094	4950126410	GC024091	4950728J00	GC024008	4A0407272BS	GDS83061
495001C302	GC024025	4950126510	GC024148	4950126510	GC024091	4950728J01	GC024008	4A0407272DE	GDS83051
495001C302	GCI24010	4950126560	GC099294	4950126560	GDS24218	4950729A00	GC024006	4A0407272DF	GDS83050
495001C351	GC024098	4950126561	GC099294	4950126561	GDS24218	4950729A10	GC024004	4A0407272DG	GDS83061
495001C352	GC024098	4950126600	GDS27169	4950126600	GC024091	4950729C10	GDS24113	4A0407305A	GC083016
495001C352	GC024046	4950126660	GC027073	4950126660	GDS24217	495072EE00	GC024090	4A0407305E	GC083014
495001C352	GDS24194	4950126661	GC024077	4950126661	GC024091	4950733A00	GC039054	4A0407305F	GC083016
495001C361	GC024098	495012D002	GC024077	495012D002	GC024001	4950733A10	GC039054	4A0407305G	GC083017
495001C362	GC024098	495012D012	GDS24282	495012D012	GDS24364	4950733A20	GC039054	4A0407311B	GC083017
495001C450	GC024047	495012D101	GDS24297	495012D101	GC039147	4950733B10	GC039054	4A0407311C	GC083015
495001C460	GC024047	495012D102	GDS24233	495012D102	GC039147	4950738E00	GC039104	4A0407341B	GCI50019
495001C510	GDS24141	495012D312	GDS24288	495012D312	GDS24053	4950805A00	GC024004	4A0407451X	GDS83060
495001C550	GC024047	495012E400	GDS24124	495012E400	GC024090	4950805A00	GC099025	4A0407452EX	GDS83051
495001D200	GDS27102	495012E400	GDS24123	495012E400	GDS24216	4950821000	GC089004	4A0407452FX	GDS83050
495001E000	GDS24188	495012E500	GCI24001	495012E500	GDS24172	4950821A00	GC089004	4A0407452X	GDS83061
495001E010	GDS24188	495012E800	GC024029	495012E800	GC024148	4950822A00	GC024002	4A0498099	GC083017
495001E011	GC024046	495012E900	GDS24126	495012E900	GDS24172	4950822B00	GC024002	4A0498099B	GC083016
495001E310	GC024046	495012F000	GDS24125	495012F000	GC099294	4950822C00	GC024002	4A0498099C	GC083016
495001E600	GDS24045	495012F010	GDS24004	495012F010	GC099294	4950822E00	GC024002	4A0498099D	GC083017



COMPETITOR	G-AP Ref.	COMPETITOR	G-AP Ref.	COMPETITOR	G-AP Ref.	COMPETITOR	G-AP Ref.	COMPETITOR	G-AP Ref.
<b>OE</b>		5026652	GDS18039	55182803	GCI17027	60651295	GDS82002	6E0407311	GC099268
		5026653	GDS18040	55197729	GCI17011	606665	GC030001	6E0498099	GC099268
4A0498099J	GC083016	5029036	GDS18006	55197730	GCI17012	6069108	GCI99075	6G913B436EB	GDS99212
4B0407271AP	GDS83019	5029037	GDS18004	55207525	GCI17025	6069109	GCI99075	6G913B437BE	GDS99211
4B0407271AS	GDS83066	5029038	GDS18005	55209968	GCI17026	6069110	GC018019	6G9N4B402AA	GDS57165
4B0407271BB	GDS83066	5029039	GDS18003	55214684	GCI18100	6071774	GC018018	6G9N4B402AB	GDS57165
4B0407271F	GDS83019	5029040	GDS18002	55221323	GCI17031	6073690	GCI18002	6M213B437AA	GDS61087
4B0407272AP	GDS83020	5029041	GDS18002	55700558	GDS17066	6073691	GCI18002	6N0407271	GDS61007
4B0407272C	GDS99113	5029043	GDS18016	55700559	GCI17028	6079195	GC018019	6N0407271B	GDS61007
4B0407272F	GDS83020	5029044	GDS18001	55700560	GDS17045	60802000	GC017009	6N0407271V	GDS61007
4B0407272M	GDS99113	50500529	GC082024	55700561	GDS17082	60802018	GDS82003	6N0407271X	GDS61007
4B0407418E	GDS83020	5057682	GDS52002	55700562	GC017052	60802019	GDS82004	6N0407272	GDS61010
4B0407451EX	GDS83019	5057708	GDS52001	55700562	GDS17045	60802035	GDS82005	6N0407272X	GDS61010
4B0407451PX	GDS83066	5083616	GDS18041	55702107	GDS17146	60806930	GC148004	6N0407311	GC053005
4B0407451RX	GDS83066	510416	GC012001	55702108	GDS17172	60809609	GC082009	6N0407331	GCI53001
4B0407452CX	GDS99113	510418	GC012008	5860052290	GC023038	60810018	GC017004	6N0407449V	GDS61007
4B0407452GX	GDS83020	510433	GC012001	5890430	GC017004	60811033	GC082004	6N0407450X	GDS61010
4B0498103	GCI83001	510734	GC012019	5929237	GC017002	60812691	GCI82005	6N0407451X	GDS61007
4B3407271G	GDS83066	510736	GC012001	5929240	GC017002	60812753	GC082003	6N0498099	GC053005
4B3407271J	GDS83066	510736A	GC012001	5944689	GC084001	60812755	GC017032	6N0498099X	GC053005
4B3407451AX	GDS83066	510851	GC012027	5944690	GC084001	60812760	GC082006	6N0498103	GCI53001
4D0407272S	GDS83019	512292	GC012023	5959385	GC084001	60812880	GC082019	6N0498103X	GCI53001
4D0407305B	GC083019	513315	GC012019	5990430	GC017002	60813079	GC017023	6N0498340X	GC053005
4D0407305B	GC083092	513316	GC012001	5998669	GC084001	60813096	GC082005	6N0498350X	GCI53001
4D0498099	GC083019	51610H1000	GC024173	5998706	GC084001	60815021	GC082012	6Q0407271AK	GDS83063
4D0498099A	GC083019	51614H1000	GC024173	5M0498099	GC061059	60815163	GC082013	6Q0407271AL	GDS83063
4D0498099AX	GC083019	51620H1000	GC024173	5M513B436SA	GDS34163	60815227	GC017042	6Q0407271AS	GDS83063
4D0498099X	GC083019	51624H1000	GC024173	5M513B436SB	GDS34163	60815250	GC082002	6Q0407271AT	GDS83063
4D0598099	GC083019	51704100	GC029002	5M513B436SC	GDS34163	60815368	GC017011	6Q0407271BC	GDS83063
4E0407272P	GDS83025	51705516	GC017007	5M513B436SD	GDS34163	60815370	GC017042	6Q0407271BE	GDS61098
4E0407452AX	GDS83025	51706611	GC017007	5M513B436SE	GDS34163	6099110	GC018019	6Q0407271BS	GDS61098
4E0498103	GCI61044	51733777	GC099018	5M513B437SA	GDS18327	614627	GC075007	6Q0407271CE	GDS61204
4F0407271G	GDS83290	51757652	GDS17102	5M513B437SB	GDS18327	614628	GC075007	6Q0407271CL	GDS61204
4F0407271H	GDS83271	51757653	GDS17113	5M513B437SC	GDS18327	614694	GC075007	6Q0407271DA	GC083024
4F0407271J	GDS83306	51783824	GC017028	5M513B437SD	GDS18327	6168422	GC018017	6Q0407271DB	GDS61098
4F0407271K	GC099351	51783854	GDS17151	5M513B437SE	GDS18327	6168423	GC018015	6Q0407271DE	GDS61098
4F0407272K	GC099351	51787180	GC017028	5N0498103A	GCI61048	6195781	GC018006	6Q0407271DP	GDS61302
4F0498099A	GC083077	51787861	GDS17171	5N0498103AV	GCI61048	628126	GC099162	6Q0407271DS	GDS61302
4F0498099B	GC099351	51787863	GDS17170	5N513B437SE	GDS18327	6313300236	GDS35010	6Q0407271J	GDS61204
4H0498103A	GCI83022	51795511	GC017063	5Q0407271G	GDS61304	6313300335	GDS35010	6Q0407272AR	GDS61252
4H0498103AX	GCI83022	51795511	GDS17194	5Q0407272BN	GDS61280	6313300501	GDS35010	6Q0407272BA	GDS61252
4M513B436JD	GDS18358	51807676	GDS17088	5Q0407272F	GDS61303	6313300701	GDS35010	6Q0407272BC	GDS61063
4M513B436JE	GDS18358	51808105	GDS17146	5Q0407272H	GDS61283	6313301301	GDS35010	6Q0407272BD	GDS61063
4M513B436JF	GDS18358	51808106	GDS17082	5Q0407761DX	GDS61304	6313370010	GDS35010	6Q0407272BE	GDS61063
4M513B437JA	GDS18359	51808107	GC017028	5Q0407761FX	GDS61268	6383340534	GDS35002	6Q0407272BH	GDS61063
4M513B437JC	GDS18359	51808108	GDS17172	5Q0407762EX	GDS61283	6383340634	GDS35002	6Q0407272BK	GDS61099
4M513B437JD	GDS18359	51808313	GDS17193	5Q0407762JX	GDS61303	6383341634	GDS35002	6Q0407272BL	GDS61252
4M513B437JE	GDS18359	51808314	GDS17192	5Q0407762X	GDS61199	6383341734	GCI48002	6Q0407272CL	GDS61183
4N113B436CA	GDS18326	51810404	GDS17034	5X0498099A	GC083007	6383341734	GDS35002	6Q0407272DH	GDS61099
4N113B436CB	GDS18326	51816768	GDS17057	5X3407271	GDS61079	6383342334	GCI35001	6Q0407272DJ	GDS61252
4N113B436CC	GDS18326	51822813	GDS17106	5X3407272	GDS61080	6383342334	GC035002	6Q0407272DM	GDS61223
4N113B437CA	GDS18309	51854039	GC017053	5Z0498099A	GC083007	6383342334	GDS35003	6Q0407272DR	GDS61063
4N113B437CB	GDS18309	51854040	GC017053	6000591283	GDS11002	6393300301	GDS35084	6Q0407272EA	GDS61301
4N113B437CD	GDS18309	51872271	GC010011	6001542122	GDS11001	6393300701	GDS35084	6Q0407272J	GDS61183
4S613B436AD	GDS18333	51872271	GDS10033	6001544964	GDS50098	6393500710	GC035028	6Q0407311D	GC053002
4S613B436AE	GDS18333	51955476	GDS17171	6001547028	GDS45084	6393500710	GDS35022	6Q0407311Q	GC083024
4S613B436AF	GDS18333	51955481	GDS17170	6001547029	GDS45085	6393501510	GDS35022	6Q0407451DX	GDS83063
4S613B436AG	GDS18333	5232897	GC052008	6001548102	GDS45084	6483685	GC018006	6Q0407451EV	GDS83063
4S613B437AD	GDS18351	535498104	GCI83009	6001548103	GDS45085	6485412	GC018017	6Q0407451EX	GDS83063
4S613B437AE	GDS18351	538450081	GDS18231	6001548658	GDS11012	6485414	GC018015	6Q0407451FX	GDS61098
4S613B437AF	GDS18351	538450082	GDS18232	6001548659	GDS11012	6485415	GC018021	6Q0407451JX	GDS61204
4S613B437AG	GDS18351	538450085	GDS18402	6001548660	GDS11014	6596773	GDS18039	6Q0407451QX	GDS61302
5003846	GC062001	538450086	GDS75056	6001548661	GDS11014	6596778	GDS18040	6Q0407451X	GDS83063
5003847	GC062001	538450101	GDS18231	6001548720	GDS50354	6596779	GDS18040	6Q0407452EX	GDS61063
5003911	GC062002	538450102	GDS18232	6001550690	GDS50570	6747789	GDS18128	6Q0407452FX	GDS61063
5003912	GC062002	538450103	GDS18402	6001550691	GDS50570	6757622	GC018011	6Q0407452GX	GDS61063
5018713	GDS18128	538450104	GDS75056	6001550794	GDS50443	6757666	GDS18004	6Q0407452HX	GDS61099
5018714	GDS18129	5390489	GC099254	6001551095	GDS50570	6757668	GDS18003	6Q0407452KX	GDS61183
5024568	GDS18039	5458020	GDS41464	6001551096	GDS50570	6757672	GDS18002	6Q0407452MX	GDS61252
5024569	GDS18039	547407311	GC099154	60504718	GC082015	6757676	GDS18001	6Q0407452QX	GDS61252
5024574	GDS18040	547407311A	GC018100	60506536	GC082015	6843198	GC062001	6Q0407452RX	GDS61301
5024575	GDS18040	547498103	GCI83004	60515370	GC017042	6962758	GDS18128	6Q0498099	GC083027
5024576	GDS18044	547679	GC082015	60541802	GC082009	6C113B436BC	GDS99244	6Q0498099A	GC054002
502623	GC099046	547682	GC082015	60584662	GCI82011	6C113B436BE	GDS99244	6Q0498099B	GC083024
5026504	GDS18289	548135	GC082015	60589273	GC082001	6C113B437BC	GDS99179	6Q0498099C	GC054002
5026505	GDS18118	551407311	GC018103	60605055	GC082004	6C113B437BE	GDS99179	6Q0498099CX	GC054002



COMPETITOR	G-AP Ref.	COMPETITOR	G-AP Ref.	COMPETITOR	G-AP Ref.	COMPETITOR	G-AP Ref.	COMPETITOR	G-AP Ref.
<b>OE</b>		701498099BX	GC061005	7294553	GDS18001	7700109333	GDS50150	7701348160	GDS50016
		701498099C	GC061006	72GG4635BA	GCI18001	7700109334	GDS50102	7701348256	GDS50016
6Q0498099D	GC083027	701498099CX	GC061006	73503002	GDS17040	7700110218	GDS50197	7701348968	GDS50145
6Q0498099DX	GC083027	701498099V	GC061003	73503003	GDS44020	7700110482	GDS50017	7701349025	GC050007
6Q0498099E	GC083024	701498099X	GC061003	737319	GC017006	7700110483	GDS50357	7701349026	GC050007
6Q0498099EX	GC083024	701498103	GCI161001	7560070	GC017005	7700110484	GC050004	7701349026	GDS50030
6Q0498099F	GC053002	701498103A	GCI161002	7573193	GC017006	7700110484	GDS50004	7701349028	GC050007
6Q0498099FX	GC053002	701498103AX	GCI161002	7577041	GC017005	7700110484	GDS50150	7701349034	GC050007
6Q0498103A	GCI83008	701498103X	GCI161001	7599433	GC017005	7700111077	GDS50038	7701349172	GDS50012
6QD498099	GC083024	701498340AX	GC061004	7608632	GC017006	7700111079	GDS50358	7701349359	GDS50013
6QE407271G	GDS83063	701498340BX	GC061005	7627971	GC082004	7700111190	GDS50357	7701349660	GDS50012
6QE407311C	GC054004	701498340CX	GC061006	7629168	GC017001	7700111259	GDS50401	7701349689	GC050007
6QE498099	GC061010	701498340X	GC061003	7629457	GC017001	7700111259	GDS50004	7701349689	GDS50052
6QE498099B	GC054004	701498350X	GCI161001	7631082	GC017039	7700111313	GDS50323	7701349691	GDS50037
6R0407761	GDS83330	7024787	GC018023	7633434	GC017012	7700111364	GDS50045	7701349692	GDS50041
6R0407761A	GDS61184	7024787	GC018024	7637734	GDS17015	7700111365	GDS50082	7701349726	GDS50023
6R0407761AX	GDS61184	7024788	GC018023	7643642	GC084001	7700111504	GDS50526	7701349727	GDS50025
6R0407761K	GDS61274	7024788	GC018024	7646401	GC017004	7700111506	GDS50004	7701349734	GDS50052
6R0407761S	GDS61260	7024789	GDS18006	7646402	GC082004	7700111508	GDS50162	7701349740	GDS50032
6R0407761SX	GDS61260	7024790	GDS18005	7647244	GC017010	7700111748	GDS50039	7701349741	GDS50024
6R0407761X	GDS83330	7024791	GDS18002	7647245	GC017010	7700111809	GDS50316	7701349742	GDS50201
6R0407762A	GDS61185	7024792	GDS18016	76472452A	GC017010	7700111810	GDS50038	7701349769	GC050027
6R0407762AX	GDS61185	7076344	GC084001	7652957	GC017004	7700111811	GDS50316	7701349769	GDS50006
6R0407762K	GDS61301	7077257	GC017046	7652958	GC082004	7700111812	GDS50068	7701349771	GDS50044
6R0407762S	GDS61261	7078573	GC017019	7656786	GC017005	7700111813	GDS50316	7701349785	GDS50033
6R0407762SX	GDS61261	7079221	GC017017	7656944	GC017012	7700111814	GDS50038	7701349786	GDS50138
6R0407763K	GDS61302	7081591	GC082017	7656945	GC017004	7700111818	GDS50320	7701349803	GDS50024
6R0498099	GC083027	711106122	GDS50013	7656949	GC082004	7700111820	GDS50316	7701349804	GDS50044
6R0498099X	GC083027	711106129	GDS50016	7659161	GC017039	7700111914	GDS50325	7701349839	GC050007
6U0407271A	GDS54001	711106130	GDS50145	7659167	GC017001	7700111914	GC050114	7701349839	GDS50007
6U0407271F	GDS54001	711106218	GDS50024	7659169	GC017001	7700111916	GDS50160	7701349847	GDS50023
6U0407271FX	GDS54001	711106219	GDS50044	7660834	GC017001	7700111916	GC050114	7701349848	GDS50025
6U0407272A	GDS54002	711106221	GDS50015	7668798	GDS17187	7700111918	GC050069	7701349873	GDS50037
6U0407272AF	GDS54002	711106222	GDS50014	7682656	GDS17016	7700111918	GDS50039	7701349874	GC050008
6U0407272F	GDS54002	711106260	GDS50033	7688157	GC082004	7700111920	GDS50314	7701349874	GDS50002
6U0407272FX	GDS54002	711497150	GDS50353	7692993	GC082004	7700112114	GDS50320	7701349879	GDS50036
6U0407311	GC054001	71720784	GC017024	7694584	GDS17010	7700112116	GDS50311	7701349880	GC050008
6U0498099	GC054001	71720785	GC017024	7698632	GC017006	7700112116	GC050114	7701349880	GDS50001
6U0498099A	GC054001	71740557	GC017007	7698900	GC017004	7700112131	GDS50253	7701349913	GDS50050
6U0498103A	GCI54003	71745011	GC017065	7700010	GC017004	7700112132	GDS50323	7701349914	GDS50014
6X0407271H	GDS61075	71771179	GC017063	770010065	GDS50271	7700112147	GDS50359	7701349915	GDS50020
6X0407271K	GDS61075	71771311	GCI17042	7700101680	GDS50271	7700112149	GDS50102	7701349915	GDS50015
6X0407272E	GDS61074	71771441	GCI10038	7700102136	GDS50438	7700112315	GDS50197	7701349916	GDS50022
6X0407331	GCI53002	71771442	GCI17028	7700102978	GC044008	7700112506	GDS50227	7701349921	GDS50007
6X0407451AX	GDS61075	71783876	GC082025	7700102978	GDS44005	7700112507	GDS50268	7701349938	GC050008
6X0407451X	GDS61075	71787055	GDS17033	7700102979	GDS50010	7700112511	GDS50268	7701349938	GDS50050
6X0407452V	GDS61074	71790991	GC017055	7700102980	GC044008	7700112688	GDS50324	7701349939	GDS50205
6X0407452X	GDS61074	71791000	GC017055	7700102980	GDS44004	7700112689	GDS50389	7701349940	GDS50052
6X0498099	GC061007	7201674	GDS18008	7700102981	GDS50011	7700113086	GDS50320	7701349945	GDS50024
6X0498099X	GC061007	7201677	GDS18009	7700102998	GC044008	7700113258	GDS50162	7701349946	GDS50044
6X0498103	GCI53002	7201678	GDS18010	7700102998	GDS44005	7700114056	GDS50272	7701349955	GC050026
700611	GCI82001	723220041	GC056006	7700102999	GC044008	7700114057	GDS50225	7701349955	GDS50008
701407271AB	GDS61034	723221055	GC056011	7700102999	GDS44004	7700114453	GDS50357	7701349958	GC050105
701407271AC	GDS61052	723221392	GC056012	7700103731	GDS50004	7700115005	GDS50324	7701349959	GDS50105
701407271B	GDS61119	723221971	GC056006	7700103863	GDS50331	7700115010	GDS50357	7701349972	GDS50002
701407271BV	GDS61119	723221981	GC056060	7700104460	GDS50130	7700115011	GDS50004	7701349980	GDS50102
701407271BX	GDS61119	723251001	GC056014	7700104727	GDS50150	7700115196	GDS50325	7701349990	GC050105
701407271CX	GDS83061	723251011	GC056014	7700105447	GDS50272	7700115197	GDS50160	7701349992	GC050003
701407271M	GDS61003	723291003	GC056012	7700105450	GDS50225	7700115818	GDS50253	7701349992	GDS50461
701407271P	GDS61004	723291013	GC056011	7700105484	GDS50038	7700272531	GDS50024	7701349994	GDS50026
701407321B	GC061003	723291130	GC056014	7700105485	GDS50316	7700850487	GDS44006	7701349994	GDS50093
701407321C	GC061004	723291140	GC056014	7700105486	GDS50038	7700872598	GDS50211	7701349994	GC050005
701407321D	GC061005	723291300	GC056014	7700105487	GDS50316	7700873311	GDS50055	7701349997	GDS50035
701407321E	GC061006	723291301	GC056014	7700106007	GDS50004	7700873322	GDS50316	7701349998	GDS50046
701407321G	GC061006	723291310	GC056014	7700106009	GDS50357	7700873326	GDS50145	7701349998	GDS50134
701407331A	GCI161001	723291311	GC056014	7700106013	GDS50357	7700875246	GDS50038	7701351124	GC050007
701407331B	GCI161002	723291530	GC056006	7700106017	GDS50356	7700875247	GDS50316	7701351124	GDS50052
701407449FX	GDS61003	723291540	GC056006	7700106018	GDS50336	7701056621	GDS50004	7701351127	GDS50041
701407449X	GDS61119	723291570	GC056016	7700106263	GDS50253	7701210040	GC050143	7701351130	GC050003
701407451A	GDS61004	72728L	GDS10021	7700106291	GDS50221	7701210040	GDS50379	7701351160	GDS50023
701407451X	GDS61003	72737X	GDS10023	7700107509	GDS50320	7701348085	GDS11004	7701351162	GDS50025
701498099	GC061003	7294547	GC018010	7700107765	GDS50197	7701348086	GDS11004	7701351172	GC050027
701498099A	GC061004	7294548	GC018011	7700108248	GDS50150	7701348089	GC050027	7701351172	GDS50006
701498099AV	GC061004	7294549	GDS18004	7700108465	GDS50295	7701348098	GDS50005	7701351192	GDS50044
701498099AX	GC061004	7294550	GDS18003	7700109021	GDS50024	7701348109	GC050027	7701351193	GDS50032
701498099B	GC061005	7294551	GDS18002	7700109022	GDS50201	7701348152	GDS50016	7701351194	GDS50024

COMPETITOR	G-AP Ref.	COMPETITOR	G-AP Ref.	COMPETITOR	G-AP Ref.	COMPETITOR	G-AP Ref.	COMPETITOR	G-AP Ref.
<b>OE</b>		7701352488	GDS50271	7701471284	GDS50357	7711135307	GDS50446	7C113B436AA	GDS99244
		7701352489	GDS50099	7701471377	GDS50043	7711135316	GDS50495	7C113B436AB	GDS99179
7701351195	GDS50201	7701352493	GC050105	7701472850	GDS50272	7711135321	GDS50228	7D0498099	GC061006
7701351264	GC050007	7701352495	GDS50319	7701472852	GDS50272	7711135354	GDS50281	7D0498103	GCI61030
7701351264	GDS50007	7701352495	GC050105	7701473010	GDS50058	7711135401	GDS50392	7D0498331	GCI61030
7701351266	GDS50033	7701352552	GDS50447	7701473013	GDS44017	7711135403	GDS50390	7E0407272AH	GDS83261
7701351267	GDS50138	7701352560	GDS50199	7701473014	GDS44016	7711135411	GDS50391	7H0407271AA	GDS61084
7701351290	GDS50024	7701352561	GDS50199	7701498698	GDS50005	7711135414	GDS50400	7H0407271AF	GDS61084
7701351292	GDS50044	7701352562	GDS50131	7701498699	GDS11004	7711135416	GDS99071	7H0407271AK	GDS61105
7701351363	GDS50044	7701352563	GDS50130	7701498775	GC050027	7711135417	GDS99071	7H0407271AL	GDS61084
7701351428	GDS50030	7701352595	GDS50009	7701498797	GDS50016	7711135420	GDS99201	7H0407271E	GDS61105
7701351478	GDS50037	7701352596	GDS50055	7701498799	GDS50016	7711135425	GDS50441	7H0407271Q	GDS61084
7701351479	GC050008	7701352618	GDS50100	7701498918	GC050007	7711135440	GDS50562	7H0407271T	GDS61105
7701351479	GDS50002	7701352619	GDS50074	7701498918	GDS50030	7711135441	GDS50557	7H0407272AC	GDS61140
7701351480	GC050008	7701352622	GC050056	7701498919	GC050007	7711135530	GDS50246	7H0407272AF	GDS61210
7701351480	GDS50002	7701352622	GDS50296	7701498921	GC050007	7711135531	GDS50214	7H0407272AH	GDS61084
7701351483	GDS50036	7701352628	GDS50221	7701498923	GDS50145	7711135532	GDS44022	7H0407272AJ	GDS83246
7701351484	GC050008	7701352629	GDS50200	7701498924	GDS50145	7711135536	GDS50207	7H0407272AK	GDS61084
7701351484	GDS50001	7701352630	GDS50211	7701498955	GC050027	7711135775	GDS50440	7H0407272AL	GDS61140
7701351486	GDS50001	7701352631	GDS50019	7701498955	GDS50006	7711135777	GDS50494	7H0407272AP	GDS61210
7701351571	GC050008	7701352729	GDS50039	7701498957	GDS50012	7711135875	GDS50438	7H0407272AR	GDS61084
7701351571	GDS50002	7701352730	GDS50029	7701498958	GDS50013	7711135906	GDS50261	7H0407272AS	GDS61210
7701351572	GC050008	7701352744	GDS50130	7701499223	GDS50003	7711135956	GDS18197	7H0407272BB	GDS61140
7701351572	GDS50001	7701352750	GC050043	7702096438	GC099076	7711368091	GDS50393	7H0407272BC	GDS83246
7701351607	GDS44006	7701352771	GDS50150	77036889	GC017006	7711368284	GDS99070	7H0407272BD	GDS61140
7701351608	GDS44006	7701352774	GDS50017	7711106122	GDS50013	7711368470	GDS50517	7H0407272BE	GDS61210
7701351695	GDS50022	7701352775	GDS50151	7711106127	GDS11004	7711368568	GDS50514	7H0407272BG	GDS61084
7701351697	GDS50014	7701352776	GDS50017	7711106130	GDS50145	7711368569	GDS50514	7H0407272BJ	GDS61210
7701351699	GDS50020	7701352777	GDS50151	7711106216	GDS50025	7711368650	GDS50526	7H0407272BK	GDS83246
7701351701	GDS50015	7701352791	GDS50331	7711106217	GDS50023	7711368656	GDS50401	7H0407272BL	GDS61140
7701351801	GDS50015	7701352808	GDS50359	7711106221	GDS50015	7711368677	GDS50280	7H0407272BN	GDS61084
7701351806	GDS50050	7701352809	GDS50359	7711106227	GDS50001	7711368831	GDS18271	7H0407272BQ	GDS61210
7701351807	GDS50205	7701352849	GDS99150	7711106228	GDS50002	7711368832	GDS18301	7H0407272CJ	GDS83246
7701351841	GDS50031	7701352869	GDS50197	7711130027	GDS50093	7711368859	GDS50314	7H0407272CK	GDS61084
7701351948	GC050045	7701352870	GDS50046	7711130028	GDS50134	7711368884	GDS50442	7H0407272S	GDS83246
7701351959	GDS50105	7701352881	GDS50045	7711130045	GDS50034	7711368905	GDS50411	7H0407321	GC061011
7701351989	GDS50095	7701352882	GDS50357	7711130057	GDS50043	7711497234	GDS50554	7H0407321A	GC061009
7701351990	GDS50150	7701352907	GC050056	7711134327	GDS99150	7711497282	GDS50525	7H0407321B	GC061009
7701351995	GC050026	7701352907	GDS50295	7711134419	GDS50447	7711497286	GDS50400	7H0407321C	GC061011
7701351995	GDS50008	7701352983	GDS50447	7711134738	GDS50336	7711497417	GDS50354	7H0407321D	GC061011
7701352001	GC050026	7701354993	GDS50034	7711134775	GDS50471	7711497474	GDS45084	7H0407331	GCI61029
7701352001	GDS50105	7701394697	GC050007	7711134776	GDS50330	7711497475	GDS45085	7H0407331B	GCI61041
7701352020	GC050007	7701463194	GDS50012	7711134777	GDS50207	7711497477	GDS45084	7H0407331E	GCI61029
7701352020	GDS50052	7701463343	GDS50003	7711134777	GC050113	7711497478	GDS45085	7H0407332	GCI61021
7701352021	GDS50031	7701465455	GDS50201	7711134778	GC050113	7711497479	GDS11012	7H0407332J	GCI61021
7701352024	GDS50052	7701465773	GDS44006	7711134779	GDS50208	7711497480	GDS11014	7H0407332P	GCI61020
7701352025	GC050007	7701468452	GDS44006	7711134780	GDS50226	7711497525	GDS50326	7H0407451AX	GDS61084
7701352025	GDS50007	7701468548	GDS50102	7711134783	GDS50281	7711497634	GDS50280	7H0407451CV	GDS61084
7701352128	GC050105	7701468549	GDS50359	7711134785	GDS50328	7720510	GC017010	7H0407451JX	GDS61105
7701352129	GDS50461	7701468642	GDS50461	7711134786	GDS50329	7735107	GDS17011	7H0407451TX	GDS61084
7701352133	GC050005	7701468836	GDS50326	7711134941	GDS50311	7740977	GDS17018	7H0407451X	GDS61105
7701352133	GDS50026	7701468839	GDS50326	7711134957	GDS50194	7750299	GC017012	7H0407452AV	GDS61140
7701352134	GDS50093	7701468840	GDS50327	7711134959	GDS50193	7750300	GC082004	7H0407452AX	GDS61140
7701352141	GDS50046	7701468842	GDS50039	7711135005	GDS50401	7750301	GC017004	7H0407452BV	GDS61084
7701352142	GDS50215	7701468843	GDS50327	7711135196	GDS50227	7758266	GC017017	7H0407452BX	GDS61084
7701352144	GDS50134	7701468887	GDS50034	7711135206	GDS50325	7765363	GDS17025	7H0407452DX	GDS61210
7701352190	GDS50171	7701469363	GC050011	7711135207	GDS50160	7770910	GC029003	7H0407452FV	GDS61084
7701352223	GDS50020	7701469374	GDS50009	7711135208	GDS50039	7771582	GC017001	7H0407452FX	GDS61084
7701352224	GDS50022	7701469375	GDS50327	7711135213	GDS50253	7794472	GDS17022	7H0407452HX	GDS61210
7701352288	GDS44006	7701469542	GC050056	7711135215	GDS50323	779TT3K177EB	GCI18002	7H0407452JV	GDS61140
7701352318	GDS50102	7701469542	GDS50271	7711135216	GDS50325	7835070	GC088005	7H0407452JX	GDS61140
7701352385	GDS50035	7701469543	GDS50099	7711135217	GDS50160	7837075	GC088008	7H0407452KX	GDS61084
7701352386	GDS50034	7701469962	GC050056	7711135219	GDS50324	7837456	GC044046	7H0407452NV	GDS83246
7701352413	GDS50326	7701469962	GDS50100	7711135220	GDS50389	7837457	GC044046	7H0407452NX	GDS83246
7701352414	GC050028	7701469965	GDS50074	7711135223	GDS50253	7839614	GCI44003	7H0407452PX	GDS61140
7701352415	GDS50043	7701469966	GDS50296	7711135233	GDS50009	7839615	GC044046	7H0407452QX	GDS61210
7701352415	GDS50029	7701470173	GDS50200	7711135236	GDS50284	7842037	GC088008	7H0407452RX	GDS61210
7701352416	GDS50326	7701470175	GDS50019	7711135237	GDS50313	7843919	GC088008	7H0407452SX	GDS83246
7701352417	GDS50029	7701470183	GDS50359	7711135243	GDS50150	7845024	GC088008	7H0407452TX	GDS83246
7701352421	GDS50247	7701470298	GDS50359	7711135246	GDS50004	7845070	GC088005	7H0407452V	GDS83246
7701352427	GDS50047	7701470304	GDS50044	7711135265	GDS50223	7849841	GC021001	7H0407452X	GDS83246
7701352428	GDS50215	7701470700	GDS50043	7711135267	GDS50221	7910028946	GDS10130	7H0407454X	GDS61084
7701352471	GC050043	7701470721	GDS50017	7711135277	GDS44004	795283	GC082015	7H0498099	GC061009
7701352471	GDS50009	7701470884	GDS99150	7711135278	GDS50010	79TT3K187AA	GC018018	7H0498099A	GC061011
7701352472	GDS50326	7701471084	GDS50357	7711135279	GDS44005	79TT3K187BA	GC018019	7H0498099B	GC061011
7701352488	GC050056	7701471155	GDS50336	7711135280	GDS50011	79TT3K187M	GC018018	7H0498103	GCI61041



COMPETITOR	G-AP Ref.	COMPETITOR	G-AP Ref.	COMPETITOR	G-AP Ref.	COMPETITOR	G-AP Ref.	COMPETITOR	G-AP Ref.
<b>OE</b>		7M0407272CX	GDS61065	811498099F	GC083007	8200169273	GDS44022	8200274159	GDS50401
		7M0407272E	GDS18008	811498103A	GCI83003	8200169277	GC044026	8200274161	GDS50245
7H0498103C	GCI61029	7M0407272F	GDS18008	81AG3K187AA	GC018019	8200169277	GDS44016	8200276640	GDS50445
7H0498103CX	GCI61029	7M0407272G	GDS61065	81AG3K187M	GC018019	8200169279	GDS50214	8200278602	GDS18197
7H0498104A	GCI61021	7M0407272H	GDS18008	81TT3K177AA	GCI99075	8200169281	GC044026	8200278603	GDS50554
7H0498104AK	GCI61020	7M0407272K	GDS18008	81TT3K177AB	GCI99075	8200169281	GDS44004	8200283723	GDS50253
7H0498104F	GCI61020	7M0407321A	GC018026	8200014107	GDS50446	8200169285	GC044026	8200283724	GDS50253
7H0498104G	GDS83246	7M0407321B	GC018025	8200014109	GDS50328	8200169285	GDS50060	8200283725	GDS50253
7H0498104GX	GCI61021	7M0407449AX	GDS18009	8200014111	GDS50208	8200169286	GDS44021	8200283726	GDS50253
7H0498104K	GCI61021	7M0407450AX	GDS18008	8200014111	GC050079	8200169288	GC044026	8200285908	GDS50447
7H0501201C	GCI61020	7M0407451A	GDS83023	8200014114	GDS50330	8200169288	GDS99151	8200285909	GDS50441
7H0501201CX	GDS61257	7M0407451AV	GDS83023	8200014352	GDS50207	8200169289	GDS50249	8200285909	GC050109
7H0501201DX	GDS61257	7M0407451AX	GDS18009	8200014353	GDS50281	8200169291	GDS44013	820029984	GDS50057
7H0501202C	GDS61257	7M0407452X	GDS18008	8200024622	GDS50043	8200169307	GDS50272	8200299844	GDS50057
7H0501202CX	GDS61257	7M0498099	GC018026	8200026912	GDS44016	8200171562	GDS50391	8200300713	GDS99071
7L0407271C	GDS61258	7M0498099A	GC018025	8200029444	GDS50043	8200173584	GDS50325	8200310122	GDS50494
7L0407271CX	GDS61258	7M0498099V	GC018025	8200030623	GDS50329	8200178618	GC044026	8200318010	GDS45085
7L0407271E	GDS99213	7M0498099X	GC018026	8200031134	GDS50197	8200178618	GDS44005	8200323959	GDS50044
7L0407271EX	GDS99213	7M0498340X	GC018026	8200031137	GDS50197	8200178624	GC044026	8200323960	GDS50024
7L0407321D	GDS99213	7M307271Q	GDS83022	8200031149	GDS50221	8200178624	GDS50166	8200323961	GDS50012
7L0407331A	GC061050	7M3407271	GDS83022	8200032887	GDS50268	8200178625	GDS44012	8200327707	GDS50442
7L0498099	GCI99148	7M3407271A	GDS83023	8200032891	GDS50227	8200179212	GDS44003	8200327707	GC050116
7L0498099A	GC061050	7M3407271E	GDS83022	8200035673	GDS50226	8200184199	GDS50520	8200330413	GDS50402
7L0498099AX	GC061050	7M3407271F	GDS83022	8200035673	GC050079	8200197978	GDS50447	8200331639	GDS50506
7L0498099C	GC061050	7M3407271G	GDS83023	8200045471	GDS50506	8200197979	GDS50441	8200334338	GC018105
7L0498099CX	GC061050	7M3407271H	GDS61087	8200052420	GDS50058	8200198015	GDS50400	8200334338	GDS44003
7L0498103	GC061050	7M3407271I	GDS61085	8200052421	GDS50246	8200198016	GC099213	8200341698	GDS50369
7L0498103A	GCI99148	7M3407271M	GDS83023	8200052423	GDS44017	8200198016	GDS99201	8200341698	GC050112
7L0498103AX	GCI99148	7M3407271N	GDS83023	8200052426	GDS44004	8200216519	GDS50442	8200351249	GDS50495
7L0501201A	GDS61236	7M3407271P	GDS83023	8200052428	GDS44005	8200216519	GC050093	8200352042	GDS99217
7L0501201B	GDS61236	7M3407271PX	GDS83023	8200063808	GDS50268	8200216523	GC050093	8200356803	GC099085
7L0501201BX	GDS61236	7M3407271Q	GDS83022	8200064731	GC050069	8200216625	GDS50399	8200356803	GDS99070
7L0501201C	GDS61236	7M3407271QX	GDS83022	8200064731	GDS50314	8200216626	GDS99186	8200358163	GC099085
7L0501201CX	GDS35086	7M3407271RX	GDS61085	8200065334	GDS50194	8200225099	GDS50281	8200358164	GC099085
7L0501331	GCI83027	7M3407271S	GDS61087	8200069146	GDS44013	8200226056	GDS50390	8200358168	GDS50354
7L0501331A	GCI135051	7M3407271SX	GDS61087	8200069147	GC018105	8200226057	GDS50392	8200363697	GDS50518
7L0598103	GCI83027	7M3407271T	GDS61087	8200069147	GDS44003	8200228393	GDS50390	8200375537	GDS50403
7L0598103A	GCI135051	7M3407271TX	GDS61087	8200072831	GDS50523	8200231663	GDS50526	8200375538	GDS50495
7L6407271	GDS83300	7M3407272B	GDS99120	8200079912	GDS50228	8200231680	GDS50150	8200376094	GDS50494
7L6407271BV	GDS83300	7M3407272C	GDS99120	8200079912	GC050113	8200231949	GDS50138	8200376095	GDS50442
7L6407271BX	GDS83300	7M3407272D	GDS61065	8200079913	GDS50207	8200231949	GDS50359	8200378880	GDS50372
7L6407271C	GDS83300	7M3407272E	GDS99120	8200079913	GC050113	8200231953	GDS50102	8200378880	GC050112
7L6407271CX	GDS83300	7M3407272EX	GDS99120	8200079915	GC050041	8200232886	GDS50446	8200379235	GDS99188
7L6407271DX	GDS83300	7M3407332	GCI61033	8200079915	GDS50256	8200233728	GDS50281	8200379236	GDS50516
7L6407271G	GC061042	7M3407451A	GDS83023	8200079916	GDS50330	8200236089	GDS50438	8200383707	GDS50444
7L6407271GX	GDS83300	7M3407451AV	GDS83023	8200087857	GDS50313	8200236092	GDS50401	8200387424	GDS50391
7L6407321E	GDS83300	7M3407451AX	GDS83023	8200087860	GDS50517	8200236103	GDS50525	8200387439	GDS50391
7L6498099A	GC083085	7M3407451BV	GDS83023	8200088665	GDS50253	8200236107	GDS50401	8200387548	GDS50330
7L6498099B	GC083085	7M3407451BX	GDS83023	8200090175	GDS50358	8200236109	GDS50261	8200388506	GDS99070
7L6498099C	GC061042	7M3407451CX	GDS61085	8200105214	GDS50357	8200236110	GC050069	8200388900	GDS11007
7L6498099CX	GC083085	7M3407451DX	GDS61087	8200107090	GDS99150	8200236110	GDS50261	8200388903	GDS11006
7L6501201A	GC083085	7M3407451V	GDS83022	8200110754	GDS50160	8200236112	GDS50519	8200407659	GDS50514
7L6501201C	GC083085	7M3407451X	GDS83022	8200110754	GC050114	8200236114	GDS50245	8200407660	GDS50514
7L6501201E	GDS35087	7M3407452AX	GDS18008	8200114426	GDS50193	8200236116	GDS50260	8200408418	GC099085
7L6501817A	GDS35087	7M3407452V	GDS99120	8200116063	GDS50162	8200240425	GDS50401	8200409664	GDS18274
7L6501817C	GDS35087	7M3407452X	GDS99120	8200117068	GDS50442	8200240430	GDS50263	8200410080	GDS50004
7L6501817E	GDS35087	7M3407761A	GDS83022	8200117069	GDS50494	8200243985	GDS50207	8200414937	GDS50366
7L8501201	GDS35087	7M3407761AX	GDS83022	8200128122	GDS50162	8200246665	GDS99071	8200416682	GDS50445
7M0407271A	GDS85098	7M3407761X	GDS83023	8200133289	GDS50393	8200255027	GDS50279	8200432514	GC099085
7M0407271AV	GDS18009	7M3498103	GCI61044	8200142879	GDS50162	8200259911	GDS50391	8200432514	GDS50405
7M0407271AX	GDS18009	7M3498103H	GCI61044	8200144764	GDS50527	8200261838	GDS50443	8200432515	GDS50516
7M0407271C	GDS18010	80078574	GC017020	8200144765	GDS50527	8200261838	GC099085	8200432516	GDS50403
7M0407271D	GDS61085	803407275A	GC083004	8200144781	GDS50506	8200261840	GDS50353	8200432517	GC050093
7M0407271F	GDS18009	803498099A	GC083004	8200164147	GDS50057	8200261840	GC050092	8200436365	GDS50447
7M0407271G	GDS18009	8063258	GDS18328	8200164149	GDS50059	8200261841	GDS50354	8200436365	GC050109
7M0407271H	GDS18009	8111303	GC062001	8200167522	GDS99071	8200261841	GC050092	8200436366	GC099213
7M0407271I	GDS18009	8111304	GC062001	8200167535	GDS99070	8200262685	GDS50526	8200436366	GDS50400
7M0407271L	GDS18009	8111306	GDS62001	8200167536	GDS99071	8200264664	GC099085	8200436848	GC050041
7M0407271M	GDS18010	8111307	GC062002	8200167554	GDS50440	8200264664	GDS99070	8200436849	GDS50393
7M0407271MX	GDS18010	8111308	GC062002	8200168513	GDS50038	8200264665	GDS99071	8200436849	GC050041
7M0407271N	GDS61085	811407305A	GC083029	8200169163	GDS50562	8200264667	GC099085	8200439891	GDS50393
7M0407271Q	GDS18009	811407311	GC083032	8200169164	GDS50557	8200264668	GDS99071	8200440187	GDS50353
7M0407271R	GDS18009	811407331	GCI83002	8200169176	GDS50228	8200267041	GDS50440	8200441337	GC050143
7M0407272A	GDS18008	811498099	GC083032	8200169176	GC050113	8200269195	GDS50527	8200441337	GDS50379
7M0407272AV	GDS18008	811498099A	GC083029	8200169177	GC050041	8200270510	GDS50354	8200441340	GC050143
7M0407272C	GDS61065	811498099E	GC083007	8200169272	GDS44017	8200272322	GDS45084	8200444438	GDS45084



COMPETITOR	G-AP Ref.	COMPETITOR	G-AP Ref.	COMPETITOR	G-AP Ref.	COMPETITOR	G-AP Ref.	COMPETITOR	G-AP Ref.
<b>OE</b>		8200624049	GDS50162	8601100	GC062001	8942633	GC050001	8D0407271BF	GDS83036
		8200626032	GDS50260	8601101	GC062001	8943126721	GC026004	8D0407271BJ	GDS61122
8200452268	GC060005	8200626038	GDS99071	8601102	GC062002	8943126730	GC026004	8D0407271BP	GDS83048
8200452269	GDS60022	8200626040	GDS50442	8601103	GC062002	8943643300	GC026001	8D0407271BQ	GDS61083
8200452272	GDS50497	8200626043	GDS99070	8601571	GC062010	8943643320	GC026001	8D0407271CL	GDS61122
8200452273	GC060005	8200626991	GDS50462	8601853	GDS62022	8944052272	GC021002	8D0407271DF	GDS61157
8200452273	GDS18301	8200647679	GC050041	8601856	GDS62031	8944052282	GC021002	8D0407271DJ	GDS61122
8200455157	GDS50354	8200659626	GDS50496	8601967	GC062012	8944264013	GC026002	8D0407271DK	GDS83012
8200460992	GDS50354	8200661507	GDS50539	8601968	GC062012	8944264023	GC026002	8D0407271DL	GDS83002
8200467490	GDS50514	8200661557	GDS99070	8602574	GC062009	8944676640	GC026001	8D0407271DM	GDS83012
8200467679	GDS50392	8200664841	GDS18274	8602574	GDS62022	8944676670	GC026001	8D0407271DN	GDS83036
8200467679	GC050041	8200666595	GDS50540	8602577	GC062009	8944676690	GC021002	8D0407271DP	GDS61122
8200470129	GDS50207	8200676172	GDS50377	8602578	GDS62031	8944676700	GC021002	8D0407271DQ	GDS61157
8200470129	GC050113	8200684084	GC050112	8603119	GDS62060	8944676710	GC021002	8D0407271DT	GDS83008
8200470131	GC050041	8200690053	GDS99070	8603120	GDS62063	8944676720	GC021002	8D0407271EC	GDS83008
8200470131	GDS50256	8200725499	GDS50383	8603251	GDS18194	8944676730	GC026006	8D0407271ED	GDS83015
8200470133	GDS50390	8200725503	GC050157	8603259	GDS18329	8944676740	GC026005	8D0407271EF	GDS83008
8200472158	GDS50348	8200725504	GC050157	8603362	GDS18218	8944676741	GC026005	8D0407271EH	GDS83008
8200477655	GDS50059	8200725510	GC050157	8603363	GDS18219	8944676750	GC026006	8D0407271EK	GDS61083
8200477656	GDS50057	8200725511	GC050157	8603486	GDS18328	8944676760	GC026005	8D0407271EL	GDS83008
8200482436	GDS50538	8200725513	GDS50429	8603487	GDS18194	8944676761	GC026005	8D0407271RX	GDS61157
8200484373	GDS45085	8200749390	GDS50373	8603789	GDS62022	8944732250	GC026001	8D0407272AC	GDS99108
8200484376	GDS45085	8200776535	GC060005	8603793	GDS62031	8952905	GC052002	8D0407272AJ	GDS61019
8200485576	GDS44005	8200776535	GDS50497	8603794	GC062009	895407271D	GC0583003	8D0407272AL	GDS83048
8200485578	GDS50166	8200776537	GC060005	8603819	GDS62060	895407272F	GDS83044	8D0407272AN	GDS83007
8200485589	GC018105	8200776538	GDS60022	8603820	GDS62063	895407305	GC083009	8D0407272AP	GDS99111
8200485589	GDS44003	8200788672	GC050162	8614498099	GC083022	895407305A	GC083016	8D0407272AQ	GDS83001
8200485590	GDS50557	8200788674	GC050162	861498099	GC083022	895407305B	GC083012	8D0407272BA	GDS99111
8200493304	GDS11012	8200790517	GDS50400	861498103A	GDS18219	895407311	GC083008	8D0407272BB	GDS61019
8200499306	GDS11014	8200790519	GDS50447	861498103AX	GCI53001	895498099A	GC083012	8D0407272BC	GDS83048
8200499585	GDS50353	8200844453	GDS50526	8689210	GDS62022	895498099B	GC083009	8D0407272BE	GDS99108
8200499586	GDS50354	8200863524	GDS50570	8689214	GDS62031	895498099C	GC083016	8D0407272BJ	GDS83007
8200499895	GDS99151	8200863653	GDS50570	871407311	GC061002	895498099D	GC083016	8D0407272BQ	GDS61082
8200500684	GDS50493	8200890089	GDS50384	871498099	GC061002	895498099H	GC083012	8D0407272CL	GDS83007
8200503358	GDS11012	8200930507	GDS50416	871498099A	GC061002	8963571	GC052003	8D0407272DJ	GDS83007
8200503359	GDS11014	8200930507	GDS50569	871498099AX	GC061002	8970636220	GC026003	8D0407272DK	GDS99108
8200511116	GDS99070	8200934677	GDS50377	871498099X	GC061002	8971172150	GC026007	8D0407272DL	GDS99111
8200511122	GC099085	8201187931	GDS50497	893407271L	GDS83059	8971172440	GC026007	8D0407272DM	GDS99108
8200511122	GDS50405	8201187935	GDS50570	893407305	GC083034	8971368880	GC026004	8D0407272DP	GDS83007
8200511220	GC099085	8201235775	GDS50493	893407305C	GC083023	8971390930	GC026004	8D0407272DT	GDS61019
8200511225	GDS50353	8201235787	GDS50496	893407305G	GC083017	8971839460	GC026007	8D0407272ED	GDS83048
8200511225	GC050092	8201236025	GDS50162	893407305N	GC083012	8971839480	GC026007	8D0407272EF	GDS61019
8200531861	GDS50253	8201236028	GDS50540	893407311	GC083032	8972001010	GC026007	8D0407272EK	GDS61082
8200531886	GDS50253	8201272648	GDS50541	893407311D	GC083051	8972001020	GC026007	8D0407305G	GC083018
8200531889	GDS50519	822821139	GCI48004	893498099	GC083032	8972156971	GC026004	8D0407305H	GC083020
8200531894	GDS50281	82301373	GC017002	893498099A	GC083034	8973499521	GC026004	8D0407305J	GC083019
8200531908	GDS99186	82333811	GC017002	893498099B	GC083051	8973876640	GC026004	8D0407305M	GC083021
8200531910	GDS99186	823407313	GC083038	893498099D	GC083023	8983571	GC052003	8D0407305Q	GC061012
8200531917	GDS50405	82362521	GC017002	893498099E	GC083008	8990574	GC050001	8D0407417H	GDS83012
8200534635	GDS50401	82362523	GC017002	893498099F	GC083051	8990574	GC052004	8D0407417J	GDS83036
8200535798	GDS50514	82362524	GC017002	893498099G	GC083009	8994676740	GC026005	8D0407418H	GDS99108
8200535799	GDS50514	8236523	GC017002	893498099GX	GC083009	89FG3K183AA	GC018017	8D0407451AV	GDS83005
8200535800	GDS50515	82413699	GC017003	893498099H	GC083051	89FG3K187BA	GC018015	8D0407451AX	GDS83005
8200543868	GDS50280	82428432	GC017002	893498099L	GC083017	89FG3K187CA	GC018015	8D0407451BV	GDS61122
8200559377	GDS50353	82439756	GC017002	893498099LX	GC083017	8A0407271AE	GDS83003	8D0407451BX	GDS61122
8200571876	GDS50401	82440166	GC017002	893498099M	GC083012	8A0407271H	GDS83003	8D0407451CV	GDS83008
8200571878	GDS50245	82443532	GC017003	893498099MX	GC083012	8A0407271J	GDS83003	8D0407451CX	GDS83008
8200571880	GDS50263	82443746	GC017006	893498099P	GC083026	8A0407272AT	GDS83044	8D0407451DV	GDS83012
8200575489	GDS50494	82448780	GC017006	893498099PX	GC083026	8A0407305F	GC083017	8D0407451DX	GDS83012
8200575489	GC050116	82449123	GC017018	893498099X	GC083032	8A0407305G	GC083026	8D0407451FX	GDS61122
8200575490	GDS50442	82466864	GC017013	893498103	GCI83003	8A0498099	GC083012	8D0407451GX	GDS83036
8200575490	GC050116	82466865	GC017033	893498103B	GCI83014	8A0498099X	GC083012	8D0407451LX	GDS83008
8200590972	GDS50391	82480859	GC017018	893498103BX	GCI83014	8C113B436AD	GDS18292	8D0407451N	GDS61083
8200598563	GC050143	82486230	GC082004	893498103X	GCI83003	8C113B437AD	GDS18293	8D0407451NX	GDS61083
8200613818	GDS50525	82486231	GC017004	8941086343	GC026001	8C114B436AD	GDS18292	8D0407451PV	GDS61157
8200613822	GDS50401	82489521	GC029001	8941086353	GC026001	8D0407271AC	GDS83012	8D0407451PX	GDS61157
8200613823	GDS50519	82489521	GC082011	8941246280	GC022002	8D0407271AJ	GDS83008	8D0407451RX	GDS61157
8200613827	GDS99071	8251517	GC062010	8941246290	GC022002	8D0407271AL	GDS83015	8D0407451TX	GDS61083
8200613828	GDS50440	8251531	GC062012	8941539492	GC026005	8D0407271AM	GDS83036	8D0407451V	GDS83002
8200618111	GDS50354	8252049	GDS62031	8941539494	GC026005	8D0407271AN	GDS61122	8D0407451X	GDS83002
8200618168	GDS50380	855407311	GC083031	8941539501	GC026006	8D0407271AP	GDS83002	8D0407452AV	GDS83001
8200618501	GDS50353	855498099	GC083031	8941539514	GC026005	8D0407271AQ	GDS83005	8D0407452AX	GDS83001
8200621196	GDS50519	855498099A	GC083031	8941539521	GC026006	8D0407271BA	GDS83002	8D0407452BV	GDS83007
8200622834	GDS50261	855498099B	GC083031	8941581302	GC021002	8D0407271BB	GDS83008	8D0407452BX	GDS83007
8200622835	GDS50260	85G4234CA	GDS18128	8941581312	GC021002	8D0407271BC	GDS83015	8D0407452CV	GDS61019
8200623807	GDS99070	8601097	GDS62002	8942476490	GC026003	8D0407271BE	GDS83012	8D0407452CX	GDS61019



COMPETITOR	G-AP Ref.	COMPETITOR	G-AP Ref.	COMPETITOR	G-AP Ref.	COMPETITOR	G-AP Ref.	COMPETITOR	G-AP Ref.
<b>OE</b>		8K0407271S	GDS83321	90511447	GDS44038	93180019	GC044004	93BG3B437BD	GDS18001
8D0407452DV	GDS99108	8K0407305C	GC083086	90512387	GDS44077	93180229	GC044080	94426401	GC026002
8D0407452DX	GDS99108	8K0407305D	GC083087	90538427	GC044030	93182543	GC044028	94426402	GC026002
8D0407452FV	GDS83007	8K0407305E	GC083088	90538428	GC044011	93182571	GC044027	94633378	GC062009
8D0407452FX	GDS83007	8K0407305F	GC083087	90538595	GC044049	93182575	GC044003	94633379	GC062010
8D0407452LX	GDS61019	8K0407451AV	GDS83273	90538602	GDS60013	93182576	GC017051	94633397	GC062010
8D0407452M	GDS61082	8K0407451AX	GDS83273	90538603	GDS44033	93182577	GC044027	9480544	GDS62022
8D0407452MX	GDS61082	8K0407451DX	GDS83273	90538604	GDS44044	93186026	GC052012	94AG3A427EA	GDS18039
8D0407452V	GDS99111	8K0407451EX	GDS83321	90539783	GDS60035	93187066	GDS60035	94AG3A428DA	GDS18040
8D0407452X	GDS99111	8K0407451FX	GDS83345	90540520	GDS44002	93187468	GC044004	9503080	GC044006
8D0407453EV	GDS83008	8K0407451LX	GDS83291	90540523	GDS60002	93190106	GDS44075	95133190100	GCI48004
8D0407453EX	GDS83008	8K0407451V	GDS83345	90540536	GDS44059	93190106	GDS44096	95533202401	GDS61236
8D0407454CV	GDS61019	8K0407451X	GDS83345	90540865	GDS44011	93190108	GDS44095	95533202411	GDS35086
8D0407454CX	GDS61019	8K0498099	GC083087	90540911	GDS44059	93190187	GC017053	95533290200	GCI83027
8D0498099	GC083018	8K0498099A	GC083088	90576706	GDS44036	93190189	GCI44014	95534990100	GC061050
8D0498099A	GC083020	8K0498099AX	GC083088	90576707	GDS44037	93190190	GCI44012	95534990102	GC061050
8D0498099B	GC083018	8K0498099B	GC083086	90AU3K183AA	GC018044	93190193	GC017052	95534990200	GCI99148
8D0498099BX	GC083018	8K0498099BX	GC083086	90FX3219CA	GDS18289	93190460	GC021038	95534990201	GCI99148
8D0498099C	GC083020	8K0498099C	GC083087	90FX3220CA	GDS18118	93192081	GDS44001	95555116	GDS10034
8D0498099D	GC083019	8K0498099D	GC083087	9102880	GC052004	93192082	GDS60002	95555117	GDS10068
8D0498099E	GC083019	8K0498099E	GC083087	9109186	GDS50010	93194650	GC044085	9555511780	GDS10068
8D0498103	GCI83002	8K0498103D	GCI83022	9113320244	GDS48001	93194650	GDS57221	95569340	GDS10069
8D0498103A	GCI83002	8N0407272G	GCI83022	91133203001	GCI48002	93194655	GDS57222	95582409	GDS10130
8D0498103AX	GCI83002	8N0407272P	GDS53010	9117407	GCI48002	93194659	GC057100	95582416	GDS45005
8E0407271AA	GDS83052	8N0407272A	GDS53010	91166707	GDS44013	93194660	GDS57197	95591073	GDS10039
8E0407271AH	GDS61115	8N0498099	GDS53010	91166708	GDS44003	93194660	GDS57223	95591074	GDS10007
8E0407271AR	GDS83310	8N0498099A	GC061021	91168794	GDS44013	9321150Y00	GC041001	95592320	GDS45005
8E0407271AT	GDS83352	8N0498099AX	GC061021	91168795	GDS44003	93225238	GC099205	9559529280	GDS10034
8E0407271BA	GDS83347	8R0407271	GC061021	9117407	GDS60013	93225242	GC044069	9559529480	GDS10068
8E0407271BE	GDS83052	8R0407271A	GDS83316	9117408	GDS44033	93225287	GC099205	95598210	GC010009
8E0407271BF	GDS83052	8R0407271B	GDS83317	9117409	GDS44044	93225296	GCI99127	95601867	GDS10003
8E0407271BG	GDS83364	8R0407271B	GDS83316	9117414	GDS60035	93230068	GC021025	95601868	GDS10005
8E0407271BJ	GDS83363	8R0407271C	GDS83316	9117611	GC044014	93230069	GC199023	95601887	GDS10003
8E0407271S	GDS83057	8V413A327AA	GDS83317	9117957	GDS44014	93230069	GCI199027	95602238	GDS10117
8E0407271T	GDS83052	8V413A327AB	GC099318	9122567	GC062001	93262105	GC021026	95602241	GDS10024
8E0407272AH	GDS83362	8V413A327AX	GC099318	9122569	GDS62001	932902609	GCI99026	95603330	GDS10130
8E0407272AR	GDS83311	8V413A328AA	GC099318	91225698	GDS62001	93292610	GC044032	95604719	GC010001
8E0407272AT	GDS83058	8V413A328AB	GC099318	9122570	GDS62002	93299251	GDS44002	95606796	GDS10117
8E0407272S	GDS83058	8V413A328AX	GC099318	91225706	GDS62002	93486853	GC012027	95606797	GDS10024
8E0407305A	GC083030	8V413B436BD	GC099318	9122833	GC062001	93741015	GC012021	95606802	GC010010
8E0407305A	GC083058	8V413B437AC	GDS50465	9122919	GC062002	93743414	GCI88035	95606803	GC010010
8E0407305B	GC083067	8V513B436AAC	GDS50466	9122920	GC062002	93743417	GC022009	95606803	GDS10034
8E0407451EX	GDS61115	8V513B437AAA	GDS18201	9163592	GDS62002	93743419	GCI12009	95606804	GC010010
8E0407451GX	GDS83057	90095159	GDS18216	9163593	GDS62001	93743421	GC021047	95606804	GDS10068
8E0407451HX	GDS83052	90125875	GCI44004	9163594	GC062002	93745994	GC021043	95615878	GC010002
8E0407451JX	GDS83352	9013300001	GC099205	9163595	GC062001	93850890	GDS50562	95619479	GDS10278
8E0407451KX	GDS83347	9013300001	GC035034	9186550	GDS21032	93850891	GDS50557	95619480	GDS10024
8E0407451LX	GDS83363	90142329	GCI35020	9186552	GC017007	93852699	GDS44003	95619481	GDS10039
8E0407451NX	GDS83052	90147008	GCI44001	9186553	GC017007	93856307	GDS18301	95619482	GDS10007
8E0407451PX	GDS83052	90157131	GC099205	91AX3219DA	GDS18039	93856308	GDS18271	95624994	GDS10005
8E0407451QX	GDS83310	90199039	GC044041	91AX3220DA	GDS18040	93856309	GDS50497	95624995	GDS10003
8E0407451RX	GDS83364	90235271	GCI44001	91AX3220EA	GDS18044	93856470	GDS44003	95643689	GC010005
8E0407452EX	GDS83362	90278734	GC044057	9201725	GC044002	93856471	GDS50557	95643952	GDS10190
8E0407452GX	GDS83058	90297728	GCI44002	9204528	GC044001	93861972	GDS50497	95643956	GDS10114
8E0407452JX	GDS83058	90304156	GCI48002	9206563	GDS57087	93BG3B413AAB	GC018024	95644258	GDS10113
8E0407452PX	GDS83311	90304775	GCI44005	92225296	GCI99127	93BG3B413AB	GC018024	95644260	GDS10071
8E0498099	GC083030	9031660004	GC044055	92333203200	GCI18001	93BG3B413ABB	GC018011	95644403	GDS10010
8E0498099A	GC083058	90334947	GC059015	92333203302	GDS48003	93BG3B413AE	GC018024	95644404	GDS10044
8E0498099A	GC083019	90334948	GC044051	92601388	GCI48004	93BG3B413BE	GC018011	95646292	GC010010
8E0498099A	GC083092	90345303	GC044056	92601892	GCI48004	93BG3B413CE	GC018010	95648544	GDS10278
8E0498099C	GC083067	90348324	GC044007	92601903	GC017001	93BG3B413DE	GC018024	95648547	GDS10005
8E0498099D	GC083058	90350824	GDS44014	92AG3K183BA	GC018006	93BG3B413DD	GC018011	95648548	GDS10003
8E0498099DX	GC083058	90350865	GDS44011	92AG3K183DA	GC018004	93BG3B413DE	GC018011	95653009	GC010008
8E0498099E	GC083078	90350907	GDS44002	92AG3K183M	GC018021	93BG3B436AAD	GDS18006	95653010	GC010007
8E0498099E	GC083092	90350908	GDS44059	92AG3K187BA	GC018006	93BG3B436AAE	GDS18006	95654730	GDS10039
8E0498099G	GC083019	90444327	GDS44011	92AG3K187M	GC018021	93BG3B436ABD	GDS18004	95654731	GDS10007
8E0498099G	GC083092	90444328	GDS44002	93033203400	GCI48001	93BG3B436ABE	GDS18004	95656495	GC010003
8E0498099X	GC083030	90496368	GDS60002	93170265	GC044001	93BG3B436AD	GDS18005	95656595	GC010003
8E0498099X	GC083058	90496976	GC044006	93170266	GC044001	93BG3B436AE	GDS18005	95666908	GDS10164
8E0498103A	GCI61002	90498406	GDS44039	93170397	GCI44009	93BG3B436AD	GDS18003	95666940	GDS10164
8K0407271AJ	GDS83291	90498412	GC044007	93172152	GC044006	93BG3B436BE	GDS18003	9566694077	GDS10038
8K0407271C	GDS83345	9049842	GC044006	9317340	GCI44002	93BG3B437AAE	GDS18002	9566694087	GDS10038
8K0407271D	GDS83273	90498637	GDS44038	93173409	GC017007	93BG3B437ABD	GDS18002	9566722180	GC010013
8K0407271P	GDS83345	90511247	GDS44011	93173410	GC017051	93BG3B437ABE	GDS18002	9566722380	GC010011
8K0407271Q	GDS83273	90511248	GDS44059	93173430	GCI44002	93BG3B437AD	GDS18016	95669013	GDS10040
		90511255	GDS44011	93176743	GC044005	93BG3B437AE	GDS18016	95669014	GDS10004



COMPETITOR	G-AP Ref.	COMPETITOR	G-AP Ref.	COMPETITOR	G-AP Ref.	COMPETITOR	G-AP Ref.	COMPETITOR	G-AP Ref.
<b>OE</b>		96225969	GC012005	9642600080	GDS99196	A1643302301	GDS85060	BS0525400	GC034062
		96225970	GC012005	9642600180	GDS99195	A1643302401	GDS85061	BS0525600	GC034018
9567582280	GC010011	96238258	GDS88072	9642876780	GDS10121	A1643302701	GDS85060	C20225500A	GC018009
9567582298	GC010011	96238259	GDS88071	9645248980	GC017044	A1643302801	GDS85061	C20225500C	GC018009
95VW3B436BA	GDS18008	96243571	GC012027	9645249280	GC018098	A1683602372	GC035023	C20225600A	GC018009
95VW3B436DA	GDS61065	96243571	GC088002	9646326680	GDS10259	A1683603172	GC035022	C20225600C	GC018009
95VW3B436FA	GDS18008	96243573	GC012009	9646326780	GDS10420	A1683603172	GDS35037	C60225500A	GC018009
95VW3B437BA	GDS18009	96243574	GC012027	9646327880	GDS10259	A1683603272	GC035023	C60225600	GC018009
95VW3B437CB	GDS18010	96243574	GC088002	9646327980	GDS10420	A1683603372	GDS35038	C9120B071000	GC118045
95VW3B437DA	GDS61085	96243575	GC012027	96474834	GC012020	A1683603372	GC035022	C9211AU31A	GC041142
95VW3B437FA	GDS18009	96243576	GC012004	96474835	GC012020	A1683603472	GC035023	C9211EB30A	GC041240
95VW3B437HA	GDS18009	96245285	GC012023	96481004	GC014030	A1683604572	GC035023	C9211EB31A	GC041257
95VW3BA413AB	GC018025	96245288	GCI12006	96481061	GC012020	A1683700872	GC035005	C9211EL00B	GC041217
95VW3K187BA	GC018026	96251135	GC012004	96481062	GC012020	A1683701572	GC035005	C9211EL10A	GC041271
95VW3K187BB	GC018025	96251136	GC012004	96485019	GDS88012	A1683702172	GC035004	C9211JA00A	GC041214
96009409	GDS10278	96251183	GC012018	96485020	GDS88013	A1683702172	GDS35037	C9211JD02B	GC041286
96009410	GDS10024	96256953	GC012027	96486854	GC012027	A1683702272	GC035004	C9211JD22B	GC041214
9601096	GDS62001	96256954	GC012027	96489832	GC012023	A1693601272	GC035026	C92AAJD22B	GC041214
96021730	GDS10010	96256965	GC012027	96489842	GC012027	A1693601572	GC099037	C97113HC0B	GC159036
96021731	GDS10044	96256966	GC012027	96489845	GCI99025	A1693602972	GCI35014	C9B11JD02B	GC041286
96031845	GDS10023	96257801	GC012027	9650624180	GDS10259	A1693602972	GC099037	CGV1053	GC051009
96033355	GDS10005	96257802	GC012001	9652371980	GDS10419	A1693603372	GC035022	CTA125500	GC034181
96033369	GDS10003	96257803	GC088002	9652372280	GDS10419	A1693603972	GC035026	E152120186009	GC099212
96042941	GDS10005	96257804	GC012020	96549101	GDS12045	A1693604372	GCI35014	E3FZ3B413B	GC018042
96042942	GDS10003	96257821	GDS12011	96549102	GDS12046	A1693604372	GC099037	F00122540	GC018027
96048666	GDS10164	96257822	GDS88059	9656329380	GDS10255	A1693604472	GC099037	F00125400	GC018027
96049018	GDS10167	96257823	GDS12025	9656329480	GDS10254	A1693605272	GC035026	F00125400A	GC018027
96072988	GDS10040	96257824	GDS12044	96564144	GC012021	A1693606072	GC035026	F00125400B	GC018027
96072989	GDS10004	96257853	GC012027	9657555580	GDS10295	A1693606272	GC035026	F00125600A	GC018027
9607411180	GDS10034	96257854	GC012027	9660896080	GDS10362	A2013508010	GDS35006	F00125600B	GC018027
9607411480	GDS10034	9626083988	GDS10016	96624724	GCI88035	A2023505610	GDS35007	F00325400A	GC018027
96091415	GDS10025	9626084088	GC010015	96639350	GC068008	A4543301101	GC017048	F00325400B	GC018027
96091416	GDS10023	9626084088	GDS10014	96666908	GDS10164	A6383340534	GC035007	F00325600A	GC018027
96095217	GDS10164	96273570	GC012021	96682500880	GDS10335	A6383340634	GDS35002	F00325600B	GC018027
96141635	GC010004	96273571	GC012021	9684135180	GDS10383	A6383341734	GDS35002	F00425500A	GC018032
96141637	GC010024	96273572	GCI12001	9684135380	GDS10253	A6383342334	GC035002	F00525400	GC018027
9614188080	GDS10113	96273759	GC012011	9684135480	GDS10325	A6383342334	GDS35003	F00525400A	GC018027
9614188180	GDS10114	96273760	GC088019	96870387	GDS88012	A6393500710	GDS35022	F00525400B	GC018027
96145818	GDS10071	96298465	GC088002	96870388	GDS88013	A6393501510	GDS35022	F00525400C	GC018027
96145819	GDS10190	96298466	GC088002	96963323	GDS44071	A9013300001	GC035034	F00525600A	GC018027
96160589	GC012008	96298467	GC012027	96963324	GDS44072	A9013300001	GCI35020	F00525600B	GC018027
96160590	GC012008	96298468	GC012027	96AG3K183AB	GC018012	AEU2522	GC099113	F00525600C	GC018027
96160618A	GC012004	9630766880	GDS45094	96AG3K183BB	GC018004	B00122510A	GC018036	F00622610A	GC034003
96164213	GC010004	9630767080	GDS10043	96BG3B413AAB	GC018023	B00225400	GC018030	F00625400	GC034003
96167303	GDS10025	9630767280	GDS45035	96BG3B413AB	GC018024	B00225400A	GC018036	F00625400A	GC034003
96167304	GDS10023	9630767880	GDS45032	96BG3B413ABB	GC018011	B00225400B	GC018030	F00625400B	GC034003
96171856	GDS10090	9630768080	GDS45010	96FG3B418CA	GCI18072	B00225500	GC018030	F00625400C	GC034003
96171857	GDS10167	9630768280	GDS45009	97FU4K258AA	GC099015	B00225500B	GC018030	F00625400D	GC034018
96171858	GDS10117	9630768280	GDS45064	97FU4K258CA	GC018004	B0022560	GC018030	F00625500	GC034003
96171871	GDS10225	96328841	GDS12027	9801388580	GDS10340	B00225600	GC018030	F00625500E	GC034018
96171873	GDS10193	96328841	GC014030	9801611180	GC045057	B00225600A	GC018030	F00625600	GC034003
96171874	GDS10025	96328842	GDS12026	98633202450	GDS48002	B00225600B	GC018030	F00625600A	GC034003
96171875	GDS10023	96328842	GC014030	98AG3K183BA	GC018016	B00225600D	GC018030	F00625600B	GC034003
9617303280	GDS10034	96348782	GC088034	98AX3C242DA	GC018016	B00325400	GC018030	F00625600C	GC034003
9617303380	GDS10069	96348783	GC088034	9936769	GCI48004	B00325400C	GC018030	F00625600F	GC034018
9617303480	GDS10013	96348790	GC088021	9H2423B	GC044090	B00325400D	GC018030	F00725600A	GC018027
96173635	GDS10278	96348790	GDS12058	9M513B436BB	GDS18262	B00325600	GC018030	F01325400	GC034019
96173636	GDS10023	96348791	GC088021	9M513B437BA	GDS18261	B00325600C	GC018030	F01325600	GC034019
96173637	GDS10025	96349953	GC012023	9S513B436AA	GDS17171	B00325600D	GC018030	F0152550X	GC034009
9617408188	GC010015	96349956	GCI12003	9S513B437AA	GDS17170	B00422510	GC034018	F0152560X	GC034009
9617408188	GDS10072	9636786780	GDS45119	9T163B436AA	GDS18264	B00422610	GC034018	F01625500	GC034009
9617408288	GC010015	9636786880	GDS45113	9T163B437AA	GDS18263	B00425400	GC034018	F01625600	GC034009
9617408288	GDS10014	9637117780	GDS45105	9T163B437AAD	GDS18263	B00425400A	GC034003	F01625600A	GC034009
96177248	GDS10117	9637117880	GDS45104	9V4N3A327AA	GC099318	B00425510	GC034018	F01725600D	GC034009
96183138	GC012005	9638016580	GDS10030	9V4N3A328AA	GC099318	B00425600	GC034018	F0182560XA	GC034009
96183139	GC012005	96391014	GC012027	A0003300036	GC035001	B00425600A	GC034003	F02322510	GC034019
96184031	GDS10034	96391550	GC088021	A0003301585	GC035001	B00525400	GC018033	F02322520A	GC034019
96184033	GDS10068	96391551	GC088021	A0003301885	GC035002	B00525400D	GC018033	F02325400	GC034019
9619947580	GC010059	96391554	GC088034	A098J30755	GC030002	B00525600	GC018033	F02325400A	GC034051
9619947588	GC010059	96391555	GC088034	A100J20362	GC030001	B00525600D	GC018033	F02325400C	GC034051
9619947588	GDS10052	96391556	GCI99107	A1243508810	GDS35001	BAU2018	GC051013	F02325600	GC034019
9619947680	GC010059	9639508780	GDS45103	A1633300101	GDS35027	BAU4444	GC051013	F02422510	GC018034
9619947688	GC010059	96396135	GCI12001	A1633300401	GDS35027	BAU5439	GC051002	F02422510A	GC034022
9619947688	GDS10120	9641777180	GDS10147	A1633300401	GC035016	BAU5440	GC051002	F02422510B	GC018034
9621456388	GC010059	9642426680	GDS99195	A1633300501	GC035016	BAU5466	GC051010	F02422510C	GC018034
9621456488	GC010018	9642426780	GDS99196	A1643300801	GCI85041	BD5M3W427A	GC018020	F02422610	GC018034



COMPETITOR	G-AP Ref.	COMPETITOR	G-AP Ref.	COMPETITOR	G-AP Ref.	COMPETITOR	G-AP Ref.	COMPETITOR	G-AP Ref.
<b>OE</b>		FA8025600B	GC034181	G02125600C	GC034002	G56425600	GC018028	GD362560XB	GC034135
		FA8125500A	GC134022	G02225500	GC034001	G56425600A	GC034012	GD3822510A	GC034084
F02422610A	GC018034	FA8125600B	GC034181	G02225500A	GC034001	G5642560X	GC034022	GD3822610	GC034135
F02425400	GC018034	FA8225500A	GC034181	G02225500B	GC034001	G56822510A	GC018035	GD382550X	GC099273
F02425400A	GC018034	FD502560XA	GC034020	G02225600	GC034001	G56822510B	GC018035	GD382550XA	GC034084
F02425400D	GC018034	FD5522510	GC034020	G02225600A	GC034001	G56822520	GC134033	GD4022510	GC099273
F02425400E	GC018034	FD5522610	GC034020	G02225600C	GC034001	G56822620	GC134032	GD4022510A	GC099273
F02425600	GC018034	FD552550XA	GC034124	G02325500	GC034004	G56825500	GC018035	GD402550XA	GC099273
F02425600D	GC034055	FD552560AC	GC034124	G02325600	GC034004	G56825500A	GC018035	GD402550XA	GDS99064
F0245600H	GC034007	FD552560XA	GC034124	G02425500	GC027007	G56825500B	GC018035	GD402560XA	GC099273
F02525400	GC034023	FD8025500B	GC034181	G024256	GC027027	G56825600	GC018035	GD402560XA	GDS34039
F02525600	GC034023	FD8025600A	GC034181	G02425600	GC027007	G56825600A	GC018035	GD602560X	GC034135
F02825400	GC034006	FF0125500	GC034009	G03325500	GC018031	G56825600B	GC018035	GD602560XA	GC034135
F0352550X	GC034009	FF022550X	GC034009	G03325500B	GC018031	G57022510A	GC018028	GD602560XB	GC034135
F03625500	GC034009	FF042550X	GC034123	G03325600	GC018031	G57025500	GC034082	GD622550X	GC099273
F03625600A	GC034009	FF042550XA	GC034123	G03325600D	GC018031	G57025500A	GC034082	GD622550XA	GC099273
F03725500	GC188013	FF072560X	GC034123	G03425500	GC034011	G57025600A	GC018029	GD622550XB	GC099273
F03725500A	GC034025	FG0125500D	GC034015	G03425600	GC034011	G57225500	GC018035	GD622550XC	GC099273
F03725500A	GC188013	FG0225500C	GC034015	G0342560X	GC034011	G5722550X	GC034145	GD622560XD	GC034180
F03725500B	GC034081	FG0225500C	GDS34101	G03725500	GC034014	G57225600	GC018035	GD762550XC	GC034173
F03725600	GC134007	FG0225500D	GC034131	G03725500B	GC034014	G5722560X	GC034145	GD762560XC	GC034173
F03725600A	GC134007	FG0225500E	GC034131	G03725600	GC034014	G57622510A	GC018035	GF092550X	GC034110
F03725600C	GC034009	FG0225600C	GC034015	G04325500	GC018031	G57625500	GC018035	GF092560X	GC034110
F03725600C	GC134007	FG0225600D	GC034131	G04325500B	GC018031	G57625600	GC018035	GF092560XB	GC034110
F03825600	GC034009	FG0225600E	GC034131	G04325600	GC018031	GA0625500	GC034009	GF092560XC	GC034110
F03922510B	GC034058	FG0525600B	GC034174	G04325600D	GC018031	GA072550X	GC034009	GF112560X	GC034110
F0392550X	GC034009	FG0525600C	GC034174	G04425500	GC034011	GA202550XB	GC034117	GG062550XC	GC034090
F03925510B	GC034058	FG0625600A	GC034174	G04425500A	GC034011	GA202560XB	GC034117	GG062550XD	GC034090
F0392560XA	GC034009	FP0125500C	GC034181	G0442550X	GC034068	GA222550X	GC034117	GG062560XD	GC034090
F0472560X	GC034009	FR012550X	GC034015	G04425600C	GC034011	GA222560X	GC034117	GG062560XE	GC034090
F0652560X	GC018034	FR012560X	GC034015	G0442560X	GC034011	GA2325500A	GC034004	GG062560XF	GC034090
F06625500	GC034009	FR022550X	GC034015	G04725500	GC034014	GA2325600C	GC034004	GG062560XG	GC034090
F06625500B	GC034009	FS1825400	GC034018	G04725500A	GC034014	GA322550X	GC034118	GG082560XC	GC034090
F06625500C	GC034009	FS1825400C	GC034018	G04725600	GC034014	GA322550XA	GC034118	GG0922520C	GC134013
F0662550X	GC034006	FS1825600	GC034018	G04725600B	GC034014	GA322550XB	GC034118	GG0922620C	GC199113
F06922610B	GC034007	FS1825600C	GC034018	G05325500	GC018028	GA322560X	GC034118	GG092550XD	GC034121
F06922610C	GC018034	FS2122610A	GC018036	G05325500B	GC018028	GA322560XA	GC034118	GG092550XE	GC034121
F06925400	GC034022	FS2125400A	GC034018	G05325600	GC018028	GA322560XB	GC034118	GG182560X	GC034090
F06925600	GC034022	FS2125400C	GC034018	G05325600C	GC018028	GA4425500	GC034011	GG2525500C	GC034015
F06925600B	GC034058	FS2125600A	GC034018	G05425500A	GC018029	GCV1075	GC051006	GG2525600C	GC034015
F06925600C	GC034022	FS2125600C	GC034018	G05425600C	GC018029	GCV1076	GC051005	GG2725500E	GC034048
F0692560XC	GC018034	FZ2425400A	GC034007	G05425600D	GC018029	GCV1088	GC051003	GG2822620A	GC134049
F0722560X	GC034009	G00125500	GC034002	G06325500	GC018028	GCV1105	GC051009	GG2825600C	GC034048
F07922610	GC034006	G00125500A	GC034002	G06325500A	GC018028	GCV1112	GC051001	GG2925500A	GC034093
F07922610A	GC034006	G00125500B	GC034002	G06325600	GC018028	GCV1117	GC051001	GG292550XA	GC034093
F87A3K183B	GC18037	G00125500D	GC034002	G06325600A	GC018028	GCV1118	GC051018	GG3425600E	GC034177
FA0922510A	GC018034	G00125600	GC034002	G06425500	GC018029	GCV1119	GC051004	GG3425600G	GC034177
FA0922510B	GC034007	G00125600A	GC034002	G06425500A	GC018029	GCV1123	GC023002	GG3625500C	GC034177
FA0922510C	GC034007	G00125600B	GC034002	G06425600	GC018029	GCV1146	GC051007	GG362550X	GC034090
FA143650XC	GC034009	G00125600E	GC034002	G06425600A	GC018029	GCV1181	GC051011	GG362560X	GC034090
FA3425400	GC018036	G00225500	GC034001	G07225500	GC034019	GCV1194	GC099151	GG4525600B	GC034174
FA502540XA	GC034020	G00225500A	GC034001	G07225600	GC034019	GD0125500	GC034051	GG4625500A	GC034178
FA502540XB	GC034020	G00225500B	GC034001	G07225600B	GC034016	GD022550XA	GC034051	GG4625600A	GC034178
FA502560XB	GC034020	G00225600	GC034001	G07425500	GC034016	GD022560X	GC034016	GG4625600C	GC034178
FA5122520	GC134022	G00225600A	GC034001	G07425600	GC034016	GD022560XA	GC034016	GG6225500A	GC034177
FA512550X	GC034123	G00225600B	GC034001	G0752550X	GC034016	GD022560XC	GC034016	GG6225600B	GC034177
FA512550XA	GC034123	G00525500	GC034002	G07525600	GC034016	GD1522510	GC099042	GG6625500	GC034177
FA512550XB	GC034123	G00525600	GC034002	G0752560X	GC034016	GD1722510	GC034010	GO1325500A	GC034004
FA512550XC	GC034123	G00625500	GC034001	G07622510	GC039123	GD1725500	GC034010	GO1325600C	GC034004
FA512560X	GC034123	G00625600	GC034001	G07622610	GC039123	GD172550XB	GC034072	GP062560XB	GC034110
FA522550X	GC034020	G01125500	GC034002	G07625500	GC039123	GD172560X	GC034072	GP062560XD	GC034110
FA522560XB	GC034123	G01125600	GC034002	G07625600	GC039123	GD172560XA	GC034072	GP102560XB	GC034110
FA522560XC	GC034123	G01222510	GC034001	G07822610	GC039123	GD172560XB	GC034072	GP182550X	GC034110
FA5822510	GC034026	G01225500A	GC034001	G56022510A	GC018035	GD1922510	GC018035	GP182550XA	GC034110
FA5822510B	GC034026	G01225500B	GC034001	G56025500	GC018035	GD192550XA	GC034021	GP182550XC	GC034110
FA582550X	GC034020	G01225600	GC034001	G56025500A	GC018035	GD192560X	GC034013	GP182560XF	GC034110
FA5922510	GC034008	G01225600C	GC034001	G56025500B	GC034021	GD192560XA	GC034021	GP202560X	GC034110
FA5922510A	GC034008	G01325500	GC034004	G56025600	GC018035	GD212550X	GC034120	GP202560XB	GC034110
FA6022620	GC134027	G01325500A	GC034004	G56025600A	GC018035	GD212560X	GC034120	GP342550XC	GC034173
FA602540X	GC034020	G01325600	GC034004	G56025600B	GC034021	GD2322510A	GC034008	GP342560XE	GC034173
FA602560X	GC034020	G01325600C	GC034004	G56025600C	GC034021	GD3622610	GC034084	GP352550XB	GC034173
FA6122510A	GC034008	G02122510A	GC034002	G56422510A	GC018028	GD3622610	GC034135	GP352560XB	GC034173
FA6122510B	GC034008	G02125500	GC034002	G56422610A	GC018028	GD362560X	GC034135	GR0125500	GC034012
FA6122610A	GC034060	G02125500A	GC034002	G5642510A	GC018028	GD362560XA	GC034084	GR012550X	GC034012
FA6122610B	GC034060	G02125600	GC034002	G56425500	GC018028	GD362560XB	GC034135	GR0125600	GC034012
FA782550XA	GC034026	G02125600A	GC034002	G56425500A	GC018029	GD362560XB	GC034084	GR012560X	GC034012



COMPETITOR	G-AP Ref.	COMPETITOR	G-AP Ref.	COMPETITOR	G-AP Ref.	COMPETITOR	G-AP Ref.	COMPETITOR	G-AP Ref.
<b>OE</b>		MB176874	GCI39002	MB526533	GC089002	MB837265	GC039009	MN156277	GC039005
		MB176876	GC039054	MB526544	GC039014	MB837266	GC039214	MN156463	GC039143
GR052550XE	GC034013	MB178865	GC089004	MB526547	GC089004	MB837267	GC039214	MN156464	GC039143
GR052560XE	GC034013	MB196876	GCI39005	MB526548	GC089004	MB837399	GC039023	MN156487	GC039143
GR252550XB	GC034015	MB297148	GC089004	MB526551	GC039014	MB837400	GC039023	MN156490	GC039143
GR252560XB	GC034015	MB297185	GC024003	MB526553	GC039014	MB837426	GC039016	MN156833	GCI99019
GR272550XB	GC034048	MB297186	GC024003	MB526558	GC039011	MB837433	GC039009	MN180244	GC039176
GR272560XB	GC034048	MB297189	GC024003	MB526581	GC089004	MB837434	GC039009	MN580862	GC039176
GR282550X	GC034048	MB297341	GC089004	MB526582	GC089004	MB837517	GC039009	MR110029	GC039021
GR282560X	GC034048	MB297343	GC089004	MB526583	GC024003	MB837600	GC039009	MR110030	GC039021
GU0125500	GC034012	MB297344	GC089004	MB526583	GC089001	MB837641	GC039009	MR110031	GC039022
GU012550XA	GC034012	MB297345	GC089004	MB526613	GC039011	MB837642	GC039009	MR110032	GC039022
GU012550XC	GC034012	MB297346	GC089004	MB526614	GC039011	MB837697	GC039002	MR110091	GC039009
GU0125600	GC034012	MB297347	GC089004	MB526666	GC089002	MB837698	GC039214	MR110120	GC039016
GU012560XA	GC034012	MB297348	GC089004	MB526772	GC039015	MB837707	GC039009	MR110193	GC039007
GU012560XD	GC034012	MB297353	GC089004	MB526774	GC039015	MB837708	GC039009	MR110199	GC039016
GVC1053	GC023010	MB297372	GC089002	MB526829	GC089002	MB886230	GC039009	MR110207	GC039016
GVC1069	GC023007	MB297373	GC089002	MB526829	GC039054	MB886260	GC039012	MR110208	GC039016
IED000081	GDS51036	MB297375	GC039054	MB526831	GC089003	MB886436	GC039009	MR110402	GC039009
IED500040	GDS51036	MB297376	GC039054	MB526853	GC089004	MB886539	GC039011	MR110406	GC039009
JZW407450QX	GDS61210	MB297377	GC039054	MB526854	GC089004	MB886540	GC039011	MR110763	GC039009
JZW498340BX	GC053007	MB297385	GC039054	MB526859	GC039011	MB886761	GC039027	MR110883	GC039015
JZW498340CX	GC053005	MB297438	GC089003	MB526860	GC089004	MB896213	GC039079	MR110886	GC039015
JZW498340FX	GC018026	MB297492	GC089002	MB526865	GC089004	MB896214	GC039079	MR111060	GC039009
JZW498340X	GC053008	MB297538	GCI24003	MB526866	GC089004	MB896215	GC039020	MR111061	GC039009
JZW498350AX	GCI83004	MB297661	GC089004	MB526867	GC039011	MB896315	GC039064	MR111365	GC039021
JZW498350X	GCI53001	MB297662	GC089004	MB526868	GC039011	MB896316	GC039064	MR111366	GC039021
K30A22510	GC027070	MB297678	GC089003	MB526869	GC039011	MB896525	GC039019	MR111367	GC039022
K9A422510	GC027010	MB297696	GC089003	MB526873	GC089004	MB896526	GC039019	MR111368	GC039022
KK16825400	GDS27108	MB297699	GC089003	MB526892	GCI39005	MB896742	GC039040	MR111854	GC039019
KK16825600	GDS27109	MB297815	GC039054	MB526897	GC089004	MB896744	GC039040	MR111856	GC039020
KK33122510	GC018030	MB297818	GC039054	MB526898	GC089004	MB896778	GC039016	MR165842	GC039009
KK33122610	GC018030	MB297871	GC039036	MB526908	GC039036	MB896787	GC039016	MR165844	GC039064
KK33125400	GDS27042	MB297872	GC039036	MB526909	GC039036	MB896788	GC039016	MR176551	GC039021
KK33125400A	GC027005	MB297874	GC089004	MB526911	GC039014	MB896789	GC039016	MR176553	GC039022
KK33125600	GC027005	MB297927	GCI39002	MB526914	GC039009	MB896789	GC039017	MR176639	GC039016
KK33125600A	GDS27040	MB297991	GC039002	MB526972	GC039002	MB896790	GC039016	MR176640	GC039016
KK33325400	GC018030	MB297992	GC039002	MB526973	GC039002	MB919125	GC039214	MR176647	GC039214
KK33325600	GC018030	MB297999	GC089004	MB526999	GC089004	MB936148	GC039023	MR176648	GC039214
KK38822510	GC027016	MB399348	GCI39028	MB620034	GC039009	MB936359	GC039009	MR176993	GC039009
KK38822610	GC027016	MB525577	GC089004	MB620055	GCI39002	MB936361	GC039064	MR196757	GC039150
KK38825400	GC027016	MB525577	GC039011	MB620166	GC039002	MB936362	GC039064	MR196758	GC039150
KK38825400A	GDS27024	MB526011	GC039214	MB620170	GC024003	MB936363	GC039016	MR196868	GC039016
KK38825600	GC027016	MB526012	GC039214	MB620178	GC039045	MB936365	GC039016	MR196869	GC039016
KK38825600	GCI34008	MB526063	GC089004	MB620247	GC039014	MB936771	GC039214	MR196872	GC039016
KS514K258AA	GC018099	MB526064	GC089004	MB620251	GC039027	MB936772	GC039214	MR196876	GCI39005
LMN180244	GC039112	MB526066	GC089004	MB620253	GC039027	MB936778	GC039009	MR222050	GC039120
LMR580861	GC039112	MB526067	GC089004	MB620325	GC039001	MB936779	GC039009	MR222051	GC039120
LR001160	GDS57165	MB526112	GC024003	MB620326	GC039001	MB937996	GC039019	MR222052	GC039149
LR003159	GC059285	MB526117	GC089004	MB620363	GC039010	MD0422510	GC099046	MR222052	GCI39029
LR005870	GC059285	MB526118	GC089004	MB620481	GC039015	MD0925500A	GDS34019	MR222053	GC039149
LR014491	GDS57165	MB526142	GC039027	MB620625	GC039027	MD1025500	GC034017	MR222960	GC039121
LR024525	GDS57165	MB526145	GC039027	MB620653	GC039018	MD1025600	GC034017	MR222961	GC039121
LR025959	GDS57165	MB526270	GC039027	MB620701	GC039025	MD1325500A	GC034017	MR222962	GC039119
LR041309	GDS57165	MB526271	GC039027	MB620702	GC039025	MD1325600	GC034017	MR222963	GC039119
M02525500A	GC034017	MB526272	GC039027	MB620752	GC039015	MD1525500A	GC034017	MR222964	GC039121
M02525500B	GC034017	MB526350	GC089002	MB620754	GC039012	MD1525600	GC034017	MR222965	GC039121
M02525600A	GC034017	MB526353	GC089002	MB620755	GC039015	MD1922510	GC027017	MR222966	GC039119
M02525600B	GC034017	MB526377	GC089002	MB620756	GC039015	MD1922510A	GC027017	MR222967	GC039119
M07022510	GC034056	MB526406	GC039026	MB620758	GC039015	MD192550X	GC027017	MR232727	GC039017
M07022510A	GC034056	MB526437	GC039009	MB620770	GC089004	MD2022510	GC034067	MR263884	GC039021
M07025500C	GC034056	MB526438	GC039009	MB620807	GC039015	MD2022510A	GC034067	MR263886	GC039022
M07025500D	GC034056	MB526443	GC089004	MB620808	GC039015	MD202550XB	GC034067	MR263947	GC039149
M07025600A	GC034056	MB526444	GC089004	MB620833	GC039027	MD202560XB	GC027017	MR263948	GC039149
M07025600B	GC034056	MB526453	GC089004	MB620834	GC039027	MD202560XD	GC034067	MR263949	GC039149
MB160653	GC039001	MB526453	GC089002	MB620899	GC039016	MD206060XD	GC034067	MR263950	GC039149
MB160654	GC039001	MB526454	GC089004	MB620900	GC039016	MD2525500A	GC034017	MR276445	GCI39023
MB176160	GC089004	MB526454	GC089002	MB620957	GC039009	MD2525600A	GC034017	MR276859	GC039027
MB176161	GC089004	MB526455	GC039054	MB837166	GCI39005	MI208006	GC039054	MR276860	GC039027
MB176463	GC089004	MB526456	GC039054	MB837184	GC039016	MN147042	GC039143	MR276870	GC039018
MB176464	GC089004	MB526464	GC089002	MB837195	GC039009	MN147089	GCI39057	MR276870	GDS39006
MB176864	GC089004	MB526464	GC039054	MB837195	GC039016	MN156219	GC039112	MR276871	GC039018
MB176865	GC089004	MB526473	GC089003	MB837261	GC039009	MN156271	GC039005	MR276871	GDS39007
MB176866	GC089004	MB526490	GC089004	MB837262	GC039009	MN156273	GDS39118	MR276874	GDS39006
MB176867	GC089004	MB526490	GC024003	MB837263	GC039009	MN156274	GDS39119	MR331245	GCI39023
MB176872	GC039054	MB526531	GC089004	MB837264	GC039009	MN156275	GC039005	MR336527	GC039136



COMPETITOR	G-AP Ref.	COMPETITOR	G-AP Ref.	COMPETITOR	G-AP Ref.	COMPETITOR	G-AP Ref.	COMPETITOR	G-AP Ref.
<b>OE</b>		MR980745	GC039221	TFB000060	GC051008				
		MR980746	GC039177	TFB000070	GC023002				
MR336528	GC039136	MR980747	GC017048	TFB000090	GC051003				
MR367165	GC039136	MR980748	GC017048	TFB000110	GC051004				
MR367166	GC039136	OK20225400	GC027001	TFB000140	GC051007				
MR377293	GC039098	OK30B25400	GC027070	TOB500330	GDS51036				
MR377294	GC039098	OK30B25600	GC027070	XS463B418DA	GCI18022				
MR377295	GC039007	P0595T	GDS10044	XS4C3B413AA	GC018003				
MR377575	GC039021	P0596T	GDS10010	XS4C3B413BA	GC018013				
MR377576	GC039021	P4808883	GDS88024	XS4C3B418EB	GCI18044				
MR377713	GC039102	P96273570	GC012028	XS4C3C092BA	GCI18045				
MR377715	GC039102	Q0003233V006000000	GDS99191	XS4W3B436BB	GDS18102				
MR399351	GCI39028	Q0003233V007000000	GDS99191	XS4W3B436DB	GDS18046				
MR453383	GC039124	Q0003233V009000000	GDS99191	XS4W3B437BC	GDS18101				
MR453384	GC039124	Q0003233V010000000	GDS99191	XS4W3B437DB	GDS18042				
MR498477	GC039112	Q0003233V011000000	GDS99191	XS614K258BA	GC018014				
MR498478	GC039112	Q0003234V006000000	GDS99190	YM213B436AD	GDS99120				
MR498969	GC039143	Q0003234V007000000	GDS99190	YM213B437A	GDS83023				
MR498974	GC039143	Q0003234V009000000	GDS99190	YM213B437AB	GDS83023				
MR515191	GC039136	Q0003234V010000000	GDS99190	YM213B437AC	GDS83023				
MR515192	GC039136	Q0003234V011000000	GDS99190	YM213B473BC	GDS83022				
MR528565	GC039141	R92AX3219DA	GDS18039	ZBA407311	GC083038				
MR528566	GC039141	R92AX3220DA	GDS18040	ZBA407331	GCI18019				
MR528569	GC039114	R93BG3B436AAE	GDS18006	ZBC407331	GCI83008				
MR528570	GC039114	R93BG3B436ABD	GDS18004	ZBC407331A	GCI18019				
MR528640	GC039006	R93BG3B436ABE	GDS18004						
MR528643	GC039028	R93BG3B436AE	GDS18005						
MR553009	GC039142	R93BG3B436BD	GDS18003						
MR553010	GC039142	R93BG3B436BE	GDS18003						
MR567001	GC039059	R93BG3B437AAE	GDS18002						
MR567002	GC039059	R93BG3B437ABD	GDS18002						
MR567003	GC039141	R93BG3B437ABE	GDS18002						
MR567004	GC039141	R93BG3B437AE	GDS18016						
MR580213	GC039143	R93BG3B437BD	GDS18001						
MR580251	GC039112	R93BG3B437BE	GDS18001						
MR580252	GC039112	R94FX3220BA	GDS18007						
MR580374	GC039112	R97FX3220DA	GDS18141						
MR580375	GC039059	R98AX3C242CA	GC018018						
MR580376	GC039059	R98BX3C242AA	GC018011						
MR580449	GC039134	R98BX3C242BA	GC018023						
MR580450	GC039134	R98FX3C242BA	GC018004						
MR580452	GC039161	R98FX3C242EA	GC018015						
MR580470	GC039143	R98FX3C242FA	GC018017						
MR580553	GC039008	R98VW3C242AA	GC018026						
MR580554	GC039008	RE98BX3C242B1A	GC018023						
MR580561	GC039004	REN770209643	GC099076						
MR580562	GC039004	RM1C1J3B436CF	GDS18242						
MR580733	GC039124	RM1S4W3B437AB	GDS18101						
MR580734	GC039124	RM2T143B437CB	GDS18263						
MR580849	GC039143	RM3C113B436BC	GDS18260						
MR580850	GC039143	RM3C113B437BC	GDS18259						
MR580851	GC039143	RM3M513B436DAD	GC018230						
MR580862	GC039176	RR176553G	GC039022						
MR580863	GC039176	RR276871G	GC039018						
MR580864	GC039176	RR580553G	GC039008						
MR580896	GC039176	RTC5843	GC030002						
MR580911	GC039023	RTC6811	GC030003						
MR581309	GC039143	RTC6862	GC051016						
MR582021	GC017048	SE022141915	GC017005						
MR582022	GC017048	SE025141514B	GC084001						
MR886257	GC039012	SE138141915A	GC017005						
MR886260	GC039012	STC3046	GC030003						
MR910297	GC039024	STC3051	GC030004						
MR910890	GC039102	STC3204	GC030006						
MR912134	GC039084	TDB000360	GDS51009						
MR912135	GC039084	TDB104020	GDS51002						
MR912136	GC039084	TDB104030	GDS51003						
MR936359	GC039009	TDB104890	GDS51068						
MR936361	GC039064	TDJ000010	GC030004						
MR935369	GC039176	TDJ10016	GC051005						
MR935383	GC039114	TDJ100470	GC051020						
MR935384	GC039114	TDJ100580	GC051011						
MR980002	GCI39057	TDJ100590	GC099151						
MR980743	GC039221	TDJ500040	GC030012						
MR980744	GC039221	TDJ500050	GC018229						
MR980745	GC039177	TDR100790	GC099211						

G-AP Ref.	MAKE	ADAPTABLE TO OE	GKN	SPIDAN	METELLI	PAGE
GDS81003	HONDA					245
GDS81004	HONDA					245
GDS81006	HONDA					245
GDS81010	HONDA					252,253
GDS81013	HONDA	44306SH3960/44306SH3961/44306SH3A00/ 44306SH3A01/44306SH3G00/44306SH3G01				250,251
GDS81015	HONDA					244
GDS81016	ACURA					1
GDS81017	HONDA					257
GDS81018	HONDA					257
GDS81020	HONDA/ROVER		301429		17-0337	255,538,539,541
GDS81025	HONDA					248
GDS81026	HONDA					245
GDS81027	HONDA					244
GDS81028	HONDA					245
GDS81035	HONDA					248
GDS81036	HONDA					257
GDS81047	HONDA	44306SEAN50				247
GDS81052	ACURA					1
GDS81056	HONDA					253
GDS81066	MINI					337,338
GDS81067	MINI					337
GDS82001	ALFA ROMEO	46307345	303530	21576	17-0504	3
GDS82002	ALFA ROMEO	46307346/60651295	303531	21577	17-0507	3
GDS82003	ALFA ROMEO/LANCIA	46308025/46308071/60802018	303532	21578		3,292
GDS82004	ALFA ROMEO/LANCIA	46308026/46308072/60802019	303533	21579		3,292
GDS82005	FIAT	46307687/46307698	304370	23788		153,154
GDS82008	ALFA ROMEO	46308024			17-0911	1,2,3,11
GDS82009	ALFA ROMEO		304759	24486		1,2
GDS83001	SKODA/VOLKSWAGEN	8D0407272AQ/8D0407452AV/8D0407452AX	301222	22684	17-0200	583,702,708
GDS83002	VOLKSWAGEN	8D0407271AP/8D0407271BA/8D0407271DL/ 8D0407451V/8D0407451X	301218	22683	17-0197	702,708
GDS83003	AUDI	895407271D/8A0407271AE/8A0407271H/ 8A0407271J	301258	22538	17-0181	18,19,20,21,22,71
GDS83004	AUDI/SEAT/SKODA/VOLKSWAGEN	1J0407272/1J0407272AG/1J0407272AH/ 1J0407272AT/1J0407272C/1J0407272JK/ 1J0407452V/1J0407452X	303162	21021	17-0211/17-0448	24,560,564,565,572,, 573,663,664,665,666, 677,678,680,681,700
GDS83005	SKODA/VOLKSWAGEN	8D0407271AQ/8D0407451AV/8D0407451AX	301219	22685	17-0199	583,702,708
GDS83006	AUDI/SEAT/SKODA/VOLKSWAGEN	1J0407271AP/1J0407271AQ/1J0407271FN/ 1J0407271H/1J0407271JD/1J0407451AX/ 1J0407451QX/1J0407271AF/1J0407271C/ 1J0407451AV/1J0407453DV/1J0407453DX	303161	21020	17-0358/17-0447	24,560,564,565,572, 573,663,665,666, 677,680,700
GDS83007	SKODA/VOLKSWAGEN	8D0407272AN/8D0407272BJ/8D0407272CL/ 8D0407272DJ/8D0407272DP/8D0407452BV/ 8D0407452BX/8D0407452FX/8D0407452FV	301223	22688	17-0202	582,702,708
GDS83008	SKODA/VOLKSWAGEN	3B0407271N/8D0407271AJ/8D0407271BB/ 8D0407271DT/8D0407451CV/8D0407451CX/ 8D0407453EV/8D0407271EH/8D0407451LX/ 8D0407453EX/8D0407271EL/8D0407271EF/ 8D0407271EC/3B0407271NX	301288	23616/22687	17-0603	583,702,703,708,709
GDS83009	AUDI					33
GDS83010	AUDI					33
GDS83012	VOLKSWAGEN	8D0407271AC/8D0407271BE/8D0407271DK/ 8D0407271DM/8D0407417H/8D0407451DV/ 8D0407451DX	301209	22679	17-0689	702,708
GDS83015	AUDI	8D0407271AL/8D0407271BC/8D0407271ED	301290			33,44
GDS83019	AUDI	4B0407271AP/4B0407271F/4D0407272S/ 4B0407451EX	303314	21173	17-0691	59,60,61,64,65,66
GDS83020	AUDI	4B0407272AP/4B0407272F/4B0407418E/ 4B0407452GX	303315	21174	17-0692	59,60,61,64,65,66
GDS83022	FORD/SEAT/VOLKSWAGEN	7M307271Q/7M3407271A/7M3407271E/ 7M3407271Q/7M3407271QX/7M3407451V/ 7M3407451X/YM213B473BC/7M3407761A/ 7M3407761AX	303922	22253	17-0546	214,215,546,547,548, 719,720,721
GDS83023	FORD/SEAT/VOLKSWAGEN	1125045/1233602/7M0407451A/7M3407271/ 7M3407271F/7M3407271M/7M3407271N/ 7M3407271P/7M3407271PX/7M3407451A/ 7M3407451AV/7M3407451AX/7M3407451BV/ 7M3407451BX/7M3407761X/YM213B437AB/ YM213B437AC/YM213B437A/7M0407451AV	303592	20579	17-0547	214,215,546,547,548, 719,720,721
GDS83024	FORD/SEAT/VOLKSWAGEN					213,546,719

G-AP Ref.	MAKE	ADAPTABLE TO OE	GKN	SPIDAN	METELLI	PAGE
GDS83025	AUDI	4E0407272P/4E0407452AX	305532	25309		58
GDS83026	AUDI					58
GDS83027	FORD/SEAT/VOLKSWAGEN					213,546,719
GDS83028	AUDI					13
GDS83036	AUDI/VOLKSWAGEN	8D0407271AM/8D0407417J/8D0407271BF/ 8D0407271DN/8D0407451GX	304615	24299		44,702,708
GDS83044	AUDI	895407272F/8A0407272AT	301260			19,20,21,71
GDS83046	AUDI/SEAT/SKODA/VOLKSWAGEN	1J0407272AP/1J0407272BL/1J0407272BM/ 1J0407272DA/1J0407272F/1J0407452BX/ 1J0407452EX/1J0407272AB/1J0407272M/ 1J0407452AV/1J0407452BV	303154/303156	21013/21015	17-0208/17-0446	23,559,560,564,571, 572,573,574,663,664, 665,676,677,679,680
GDS83048	AUDI	8D0407271BP/8D0407272AL/ 8D0407272BC/8D0407272ED	301289	22676		33,44
GDS83050	AUDI	4A0407272BD/4A0407271BG/ 4A0407272DF/4A0407452FX	301307	22589	17-0205	15,17,58,63,64
GDS83051	AUDI	4A0407272BH/4A0407272DE/4A0407452EX	301313	22590	17-0206	15,17,58,63,64
GDS83052	AUDI	8E0407271AA/8E0407271BE/8E0407271BF/ 8E0407271T/8E0407451HX/8E0407451NX/ 8E0407451PX	304617	24301	17-0940	33,34,35,36,37,38,39, 40,44,45,46,47,49
GDS83054	AUDI					33
GDS83057	AUDI	8E0407271S/8E0407451GX	304291	23628	17-0693	33,34,35,36,39,40, 44,45,46,47
GDS83058	AUDI	8E0407272S/8E0407452GX/ 8E0407452JX/8E0407272AT	304292	23629	17-0694	33,34,35,36,39,40, 45,46,47
GDS83059	AUDI	893407271L	301247	22502		18,19,20,21,71
GDS83060	AUDI	4A0407271BS/4A0407271DG/4A0407451X	301320	22619		15,17,58,63,64
GDS83061	AUDI	4A0407272BS/4A0407272DG/	301321	22618		15,17,58,63,64
GDS83063	SEAT/SKODA/VOLKSWAGEN	6Q0407271AK/6Q0407271AL/6Q0407271AS/ 6Q0407271AT/6Q0407271BC/6Q0407451DX/ 6Q0407451EV/6Q0407451EX/6Q0407451X/ 6QE407271G	304443	24096	17-0611	553,554,556,557,566, 567,568,569,570,579, 580,673,715,716
GDS83064	FORD/SEAT/VOLKSWAGEN					213,546,719
GDS83065	FORD/SEAT/VOLKSWAGEN					214,215,547,720
GDS83066	AUDI	4B0407271AS/4B0407271BB/4B3407271G/ 4B3407451AX/4B0407451PX/4B3407271J/ 4B0407451RX	304844	24571	17-0943	58,59,60,61,64,65, 66,67
GDS83236	AUDI/SEAT/SKODA/VOLKSWAGEN					25,26,27,28,29,30, 31,549,550,551,552, 561,562,565,566,574, 575,576,577,578,581, 582,584,668,669,670, 671,672,682,683,684, 685,686,687,688,689, 690,691,692,693,696, 701,702,703,704,705, 706,707,709,710,711, 717,718,725,726,727
GDS83241	AUDI/SEAT/SKODA/VOLKSWAGEN					25,26,27,28,29,30, 74,75,76,549,550,551, 552,561,562,565,566, 574,575,577,578,581, 582,668,669,670,671, 672,683,684,685,686, 688,689,690,691,693, 695,696,697,701,703, 704,705,706,707,709, 710,711,718,725,726, 727
GDS83246	VOLKSWAGEN	7H0407272AJ/7H0407272BC/7H0407272BK/ 7H0407272CH/7H0407272S/7H0407452NV/ 7H0407452NX/7H0407452SX/7H0407452TX/ 7H0407452V/7H0407452X/7H0498104F	304500	24153		697,698,729,734, 735,736,737
GDS83255	AUDI/SEAT					36,37,38,39,40,47,48 ,49,50,555
GDS83261	VOLKSWAGEN	7E0407272AH	305504			698,729,730,735,737



G-AP Ref.	MAKE	ADAPTABLE TO OE	GKN	SPIDAN	METELLI	PAGE
GDS83265	AUDI/SEAT/SKODA/ VOLKSWAGEN	1K0407271ES/1K0407271HM/ 1K0407453BX/1K0407761HX	304764	24491		25,26,29,30,550, 551,561,565,575,578, 581,582,584,683,684, 686,691,704,710, 711,718,725,726
GDS83266	AUDI/SEAT/SKODA/ VOLKSWAGEN	1K0407452TX/1K0407272CR	304767	24494		25,26,27,29,30,31, 552,576,577,578,581, 582,584,669,670,671, 685,686,687,688,690, 691,693,701,705, 706,707,711
GDS83267	VOLKSWAGEN					698,699,729,730, 734,735,736,737,738
GDS83269	VOLKSWAGEN					722
GDS83270	VOLKSWAGEN					722
GDS83271	AUDI	4F0407271H				61,62,67,68
GDS83273	AUDI	8K0407271D/8K0407271Q/8K0407451AV/ 8K0407451AX/8K0407451DX	304923	24652		41,42,43,44,50,51, 52,53,54,55,56,57
GDS83278	VOLKSWAGEN					738
GDS83288	FORD					213,214,228,229, 232,233
GDS83289	FORD					213,214,228,229, 232,233
GDS83290	AUDI	4F0407271G				61,62,63,67,68
GDS83291	AUDI	8K0407271AJ/8K0407451LX				41,42,43,44,50,51,52, 53,54,55,56,57,58
GDS83292	AUDI					61,67
GDS83293	VOLKSWAGEN					698,729,730,735, 736,737
GDS83294	AUDI/SEAT/SKODA/VOLKSWAGEN	1K0407271AT/1K0407451CX/1K0407271CP/ 1K0407451FX/1K0407271DR/1K0407451KX	304746/304758/ 304762	24489/24473/ 24485	17-0759	24,25,27,28,29,548, 549,550,551,561,565, 574,575,576,577,581, 582,583,682,683,685, 688,689,690,691,693, 695,704,710,725,727
GDS83295	AUDI/SEAT/SKODA/VOLKSWAGEN	1K0407271BJ/1K0407271EE/1K0407271BN/ 1K0407451DX/1K0407451TX	304748	24475	17-0761	25,26,27,28,29,30,31, 549,550,551,552,561, 562,565,566,575,576, 577,578,581,582,584, 669,670,671,672,683, 684,685,686,687,688, 689,690,691,693,696, 701,703,704,705,706, 707,709,710,711,718, 725,726
GDS83300	VOLKSWAGEN	7L6407271/7L6407271BV/7L6407271BX/ 7L6407271C/7L6407271GX/7L6407271D/ 7L6407271DX/7L6407271G	304547	24200		722
GDS83302	VOLKSWAGEN					682,684,688,695, 724,726
GDS83303	AUDI					73,74,75
GDS83304	AUDI					23,74,75
GDS83306	AUDI	4F0407271J				61,62,63,67,68
GDS83310	AUDI	8E0407271AR/8E0407451QX	305069	24797		34,35,36,37,38,39, 45,46,47,48,49
GDS83311	AUDI	8E0407272AR/8E0407452PX	305078	24819		36,37,38,39,47,48,49
GDS83313	AUDI/SEAT/SKODA/VOLKSWAGEN	1K0407272EN/1K0407272RB/ 1K0407454DX/1K0407764LX	304752	24479	17-0762	25,26,27,28,29,549, 550,551,552,561,562, 565,566,575,577,578, 581,671,672,683,684, 686,689,690,691,696, 701,703,704,705,706, 707,709,710,711,718, 725,726
GDS83316	AUDI	8R0407271B/8R0407271/8R0407271BX	305067	24795		72

G-AP Ref.	MAKE	ADAPTABLE TO OE	GKN	SPIDAN	METELLI	PAGE
GDS83317	AUDI	8R0407271A/8R0407271C	305068	24796		63,68,69,72,73
GDS83318	AUDI/SKODA/VOLKSWAGEN	1K0407451RX/1K0407271BD	304757	24484		24,28,574,576,682,685
GDS83319	AUDI/SKODA/VOLKSWAGEN	1K0407271DH/1K0407451BX/1K0407451MX	304761	24488	17-0877	24,28,574,576,682,685,695,697
GDS83320	AUDI/SEAT/SKODA/VOLKSWAGEN		304749			24,27,28,548,550,560,561,565,574,576,682,685,688,690,692,695
GDS83321	AUDI	8K0407271S/8K0407451EX	304926	24655		42,43,51,52,54,55,56,57
GDS83322	AUDI					74,75
GDS83329	AUDI					61,62,63,67,68
GDS83330	SEAT/SKODA/VOLKSWAGEN	6R0407761/6R0407761X				558,559,566,579,714
GDS83337	AUDI					41,42,43,51,52,54,55,56,57,58
GDS83345	AUDI	8K0407271C/8K0407271P/8K0407451FX/8K0407451V/8K0407451X	304924	24653		41,42,43,44,50,51,52,54,55,56,57
GDS83346	AUDI/SKODA/VOLKSWAGEN	1K0407272KB/1K0407454TX	304773			24,28,574,576,583,682,685,688,695
GDS83347	AUDI	8E0407271BA/8E0407451KX	305071			36,38,39,40,47,49,50
GDS83349	AUDI/SEAT/VOLKSWAGEN					27,28,31,550,562,679,696
GDS83350	AUDI					73,74,75
GDS83352	AUDI/SEAT	8E0407271AT/8E0407451JX	305070	24798	17-0693	33,34,35,36,37,38,39,40,41,45,46,47,48,49,50,554,555
GDS83355	AUDI/SEAT/SKODA/VOLKSWAGEN					25,26,28,29,30,549,550,551,552,561,562,565,566,575,577,578,581,669,670,671,672,683,684,685,686,688,689,691,693,696,703,704,705,706,709,710,711,718,725,726,727
GDS83362	AUDI/VOLKSWAGEN	8E0407272AH/8E0407452EX	304288			33,34,35,39,44,45,46,59,703,709
GDS83363	AUDI	8E0407271BJ/8E0407451LX	304297			35,38,40,46,49
GDS83364	AUDI	8E0407271BG/8E0407451RX	305072			35,36,46,48
GDS83373	SEAT/SKODA/VOLKSWAGEN	1K0407271DQ/1K0407451LX	305395	25172		562,563,578,668,669,693,703,709,725
GDS83374	AUDI/VOLKSWAGEN	1J0407271HJ/1J0407451RX/1J0407451SX/1J0407271HK/1J0407453GX	304284	23608		23,24,663,664,665,666,677,678,679,680,681
GDS85001	BMW	33211226047/33211226720	300681	20541		83,85
GDS85002	BMW	33211227032/33211227597/33211227606/33211229392/33211229587	300645	21998	17-0214	78,82
GDS85003	BMW	33211225940/33211225941/33211226330/33211226336/33211226861/33211226900	300695	23568		77,78,81,82
GDS85004	BMW	33211225942/33211225943/33211226860/33211226901	300693	23564		77,78,81,82
GDS85005	BMW					81
GDS85006	BMW	33211227912/33211229235			17-0699	91
GDS85007	BMW	33211226904/33211226905/33211227404/33211227585/33211227591	300694	22000		78,79,82
GDS85010	BMW					88,89
GDS85011	BMW					88,89
GDS85014	BMW	33211227172			17-0212	78,82
GDS85017	BMW	33211229588	304622	24306	17-0698	79,81,82
GDS85018	BMW	31607505004/31607505006/31607561342/31607565314	304496	24149	17-0925	88,89
GDS85019	BMW					81
GDS85021	BMW	33201229141/33201229374/33211229420/33211229432			17-0216	84,85
GDS85022	BMW	33217547073/33217547075	304477/304480	24130/24133		76,77,79,80
GDS85023	BMW	33217547074/33217547076	304478/304479	24131/24132		76,77,79,80
GDS85024	MINI	31608605469/31607609211/31607589763				337,338,339
GDS85025	MINI					337,338
GDS85026	MINI					337,338
GDS85029	BMW	31607505005/31607561341/31607565313	304495	24148	17-0924	88,89
GDS85032	BMW	33217547070	304469	24122		76,77,79,80
GDS85033	BMW	33217547072	304471	24124		76

G-AP Ref.	MAKE	ADAPTABLE TO OE	GKN	SPIDAN	METELLI	PAGE
GDS85034	BMW	33217547071	304472	24125		76
GDS85036	BMW	33217561792	304481	24134		76
GDS85038	BMW	33207561796/33207580945/ 33217553560/33217553564	304473/304475/ 304483	24126/24128/ 24136		76,77,80,81,83
GDS85039	BMW	33207561795/33207580946/33217553559/ 33217553563/33217561783	304474/304476/ 304484/305046	24774/24127/ 24129/24137		76,77,80,81,83
GDS85040	BMW	33217547069/33217553561	304470/305048	24776/24123		76,77,79,80
GDS85041	MINI					338,339
GDS85042	BMW	33211229592/33211229708	304682	24370	17-0915	79,81,82,91
GDS85043	BMW	31607545126/31607553946	305729	25535		89,90,91
GDS85044	BMW					87,88
GDS85045	MINI					338,339
GDS85047	BMW	31607502731/31607505199	304620	24304		79,82
GDS85048	BMW	31607502731/31607505200	304621	24305		79,82
GDS85049	BMW					88,89
GDS85050	BMW	33207500914/33207500915	304498	24151		88,89
GDS85051	BMW	33211229591/33211229707	304740	24467	17-0914	79,81,82,91
GDS85052	BMW	31607545125/31607553945	305728	25534		89,90,91
GDS85053	MINI	31607531721/31607533215	304214	23279		337,338
GDS85054	MINI	31607531722/31607533216	304215	23280		338
GDS85058	MITSUBISHI					343
GDS85060	MERCEDES BENZ	1643302301/A1643302301/A1643302701/ 1643302701/1643300801				331
GDS85061	MERCEDES BENZ	1643302801/A1643302401/1643302401/ A1643302801/1643301901				331
GDS85062	BMW	31217540115/33207537607/33217540115/ 33207524043/33203415955/ 33213428179/33217529913	304673/304663	24351/24361		87,88
GDS85063	MINI					338,339,340
GDS85064	BMW					84,85
GDS85066	BMW					77,81,83
GDS85067	BMW					77,81,83
GDS85068	MERCEDES BENZ					332
GDS85069	BMW					87,88
GDS85070	BMW					89,90
GDS85071	MINI					338,339,340
GDS85073	BMW		305159			84,85,86
GDS85074	BMW	33207524044/33217529914/31217540116/ 33207537608/33217540116	304664/304674	24352/24362		86,87,88
GDS85078	BMW	31607524046/31607529202/ 31603450564/31603450566	304668/304670	24356		87,88
GDS85079	BMW	33217561790	305047	24775		76,77,80,81,82,83
GDS85081	BMW					89
GDS85082	BMW					84,85,86
GDS85085	BMW					76,77,80,81,82,83
GDS85091	BMW	33217547821	304807	24534		84,85,86
GDS85093	BMW					87,88
GDS85098	AUDI	7L8501201	304788	24515		73
GDS85107	BMW	33207628251	305227	24978		77,81,83
GDS88010	OPEL					431
GDS88011	OPEL					431
GDS88012	CHEVROLET/DAEWOO	96485019/96870387				94,142
GDS88013	DAEWOO	96485020/96870388				142
GDS88016	CHEVROLET/TOYOTA	4342020113/2650112001				95,96,613,615
GDS88017	CHEVROLET/HOLDEN/TOYOTA					95,96,244,611,613,615
GDS88019	DAEWOO					143
GDS88024	CHRYSLER	4641975/4641981/4660487/4808125/ 4808135/4808873/4808883/4808965 04641855AE/04641883AD/4641981K 4808971K/P4808883/4808971/4808883J	302817/302819/ 302821	20140/20142/ 20144		100
GDS88059	DAEWOO	96257822			17-0529	143
GDS88061	SUZUKI					594
GDS88071	CHEVROLET	96238259				94
GDS88072	CHEVROLET	96238258				94
GDS88080	CHEVROLET					96
GDS88081	CHEVROLET					96
GDS88082	CITROEN/PEUGEOT					110,112,445,447,448
GDS88093	CHEVROLET/OPEL					93,385
GDS88094	CHEVROLET/OPEL					93,385
GDS88095	CHEVROLET					94
GDS88107	CHEVROLET	13271511				93,94
GDS88108	CHEVROLET	13271512				94
GDS88115	JEEP					279,280
GDS88137	CHRYSLER					97,98
GDS88150	JEEP					279,280



G-AP Ref.	MAKE	ADAPTABLE TO OE	GKN	SPIDAN	METELLI	PAGE
GDS89002	CHRYSLER	4511435/4511443/4511445/4641528/4641672	302823/302825	20146/20148		99
GDS89004	CHRYSLER/DODGE/PLYMOUTH					99,150,482
GDS89005	CHRYSLER TRUCK/DODGE TRUCK/					100,151,482
GDS89013	CHRYSLER/DODGE/EAGLE					97,150,151
GDS89028	CHRYSLER	4511436/4511438/4511448	302824/302826	20147/20149		99
GDS89039	CHRYSLER	4808578/4808568L/4808578L/4808580K	302818/302820/302822	20141/20143/20145		100
GDS89048	CHRYSLER					98
GDS89049	CHRYSLER					98
GDS89067	CHRYSLER					100
GDS89073	CHRYSLER					98,99
GDS89074	CHRYSLER					98
GDS89082	CHRYSLER					100
GDS10001	CITROEN	3272ES/3272ET	303467	22115	17-0708	107,116
GDS10002	CITROEN	3273ES/3273ET	303468	22116	17-0709	107
GDS10003	CITROEN	327000/327368/95601867/95601887/ 95624995/95648548/96033369/ 96042942/32735J/3273C8	301906	20607	17-0005	100,101
GDS10004	CITROEN	327307/327387/95669014/ 96072989/3273Y2/3273Y3	301929	20654	17-0011	138
GDS10005	CITROEN	95601868/95624994/95648547/ 96033355/96042941	301905	20606	17-0004	100,101
GDS10007	CITROEN	327220/327265/327364/327365/ 327369/327389/95591074/95619482/ 95654731/32735Q/32735R/3273G2/ 3273L9/3273R6/3273Y0	301921	21616	17-0007	106
GDS10008	CITROEN	3273E2/327356/3273C8/32735C	301926	20650	17-0061/17-0081	130
GDS10009	CITROEN	327250/327254/32728J/3272W5/32723J	301925	20649	17-0060/17-0080	130
GDS10010	CITROEN/PEUGEOT	95644403/96021730/3272R3/P0596T	301803	21638	17-0019	105,106,435
GDS10012	CITROEN/FIAT/PEUGEOT	32722L/32735X/3273V7/3273W0	303057	20955	17-0141	131,185,186,187,192,
GDS10013	CITROEN/FIAT/PEUGEOT	9617303480	303513	21644	17-0083	106,172,173,174,
GDS10014	CITROEN/FIAT/PEUGEOT	327306/327315/9617408288/9626084088/ 32735Y/32737E/3273S1/3273S2	303061	20959	17-0145	131,132,185,187,192, 193,465
GDS10015	CITROEN/PEUGEOT	32730W/32730X/32736A/3273X	302919	23353	17-0133	102,480,481
GDS10016	CITROEN/FIAT/PEUGEOT	9626083988/3272K7/3272K8/ 3272L0/3272V0/3272V7	303060	20958	17-0144	131,132,185,187,192, 193,465
GDS10017	CITROEN	32732Y/32732Z	303238	21116	17-0157	136
GDS10018	CITROEN	32721F	303241	21122	17-0217	135,136
GDS10019	CITROEN	32731C/32733Z/32734H/32734J/32736H	303242	21123	17-0218	135,136
GDS10020	CITROEN	24969905/00003272X3/32727J/ 3272G1/3272T9/3272X4/3272AX	302928	21697	17-0146	130,131
GDS10021	CITROEN	32726F/32727F/32728F/72728L	303247	21128		136
GDS10022	CITROEN/PEUGEOT	3272A1	302420	21673		138,433,435,436
GDS10023	CITROEN/PEUGEOT	96031845/96091416/96167304/96171875/ 96173636/32730R/32730S/32730T/32736K/ 32737W/32739Z/3273AA/3273K2/ 3273K3/72737X	302441/303251	20670/21132	17-0137/17-0642	135,136,137,138,480
GDS10024	CITROEN	95602241/95606797/95619480/ 96009410/3273K4	301508	20627		103,104,105
GDS10025	PEUGEOT	96091415/96167303/96171874/ 96173637/3272A4/3272A6	302440	20669	17-0136	480
GDS10026	CITROEN	32725L/32726Y/3272Y6/3272Y7/3272Y8	302918/303243	21124/23352	17-0132	136
GDS10027	CITROEN	32730V/32736A	303244	21125	17-0521	136,137
GDS10030	CITROEN	3272EN/3272EP/3272FW/9638016580/3272FX	303463	22111	17-0415	106,107,108
GDS10031	CITROEN	3273EA/3273EN/3273EP	303464	22112	17-0416	106,107,108
GDS10032	CITROEN/FIAT/PEUGEOT	327309/327310/327313/1478552080/ 1487936088/32735V/32735W/3273CN/ 3273R2/3273R3/3273ZZ/3273NC/ 1491244080	303053	20951	17-0161	122,123,124,125,126, 127,128,129,160,161, 162,163,164,165,166, 167,168,169,170,468, 469,470,471,472,473, 474,475,476
GDS10033	CITROEN/FIAT/PEUGEOT	1478551080/1487937088/32729K/ 3272CN/3272J7/3272J8/3272V3/ 3272V4/3272V5/3272NF/51872271	303052	20950	17-0160	120,122,123,124,125, 126,127,128,129,160, 161,162,163,164,165, 166,167,168,169,173, 467,468,469,470,471, 472,473,474,475,476
GDS10034	CITROEN/FIAT/PEUGEOT	327248/327285/327360/327477/95555116/ 95606803/96184031/9559529280/9607411180/ 9607411480/9617303280/32727N/3272F9	301924	21648	17-0082	106,107,172,173,174, 190,477,478,479

G-AP Ref.	MAKE	ADAPTABLE TO OE	GKN	SPIDAN	METELLI	PAGE
GDS10035	CITROEN/FIAT/PEUGEOT	1463107080/1491239080/32727K/ 3272CK/3272J1/3272J5/3272J6	303048	20946	17-0086	122,123,124,125,126, 127,128,129,160,161, 162,163,164,165,166, 167,168,169,170,468 ,469,470,471,472,473 ,474,475
GDS10036	CITROEN/FIAT/PEUGEOT	1463107080/1491239080/32727K/ 3272CK/3272J1/3272J5/3272J7	303049	20947	17-0087	122,123,124,125,126, 127,128,129,160,161, 162,163,164,165,166, 167,168,169,170,468 ,469,470,471,472,473, 474,476
GDS10037	CITROEN/FIAT/PEUGEOT	1463105080/32726K/3272CH/ 3272J0/3272J3/3272J4	303044	20942	17-0084	122,123,124,125,126, 127,128,129,160,161, 162,163,164,165,166, 167,168,169,170,468, 469,470,471,472, 473,474,475
GDS10038	CITROEN	327255/9566694077/9566694087	301932	20655	17-0130	130
GDS10039	CITROEN	327200/327220/327276/327366/ 327367/95591073/95619481/95654730/ 32724K/3272K2/3272R5	301920	21615	17-0006	106
GDS10040	CITROEN	327218/95669013/96072988/32722Z/ 3272R7/3272R8/3272V1	301930/303237	20653/21115	17-0010/17-0156	135,136
GDS10043	CITROEN/PEUGEOT	9630767080/32726E/32727E/ 32727G/3272CQ/3272CR	303199/303239	21036/21119	17-0379	135,136,436,437
GDS10044	CITROEN/PEUGEOT	327387/95644404/96021731/ 32735P/3273X8/P0595T	301804	21637	17-0020	105,106,435
GDS10045	CITROEN					130
GDS10046	CITROEN					131
GDS10048	CITROEN	32728Q/32729Q	303349	21343	17-0486	130,131
GDS10049	CITROEN	32737Q/32737R	303350	21344	17-0487	130,131
GDS10050	PEUGEOT					480
GDS10051	CITROEN					138
GDS10052	CITROEN/FIAT/PEUGEOT	9619947588/3272L9/3272M0	303054	20952	17-0138	131,185,186,187, 192,193,465
GDS10053	CITROEN					135,136,137
GDS10057	CITROEN/FIAT/LANCIA	1481449080/32735Z	303680	22870	17-0673	119,185,187,193,296
GDS10063	PEUGEOT					436
GDS10065	PEUGEOT					454
GDS10066	CITROEN/FIAT/PEUGEOT	1495546080/1496137080/ 3273Q7/1491244080	303051	20949	17-0159	122,123,124,125,126, 127,128,129,160,161, 162,163,164,165,166, 167,168,169,170,468, 469,470,471,472,473, 474,475,476
GDS10067	CITROEN/FIAT/PEUGEOT	1495545080/3272J2	303050	20948	17-0158	122,123,124,125,126, 127,128,129,160,161, 162,163,164,165,166, 167,168,169,467,468, 469,470,471,472,473, 474,475,476
GDS10068	CITROEN/FIAT/PEUGEOT	327360/327362/327478/95555117/95606804/ 96184033/9555511780/9559529480/ 32736R/3273C7/3273H1	301923	21647		106,107,172,173,174, 190,477,478,479
GDS10069	CITROEN/FIAT/PEUGEOT	95569340/1463106080/1491236080/ 9617303380/32735S	303043	20941		122,123,124,125,126, 127,128,129,160,161, 162,163,164,165,166, 167,168,169,170,468, 469,470,471,472,473, 474,475
GDS10070	CITROEN/PEUGEOT	32736P/3273T6	304009	20688	17-0701	134,464,465
GDS10071	CITROEN/PEUGEOT	95644260/96145818/32725N/3272N0			17-0700	134,464,465
GDS10072	CITROEN/FIAT/PEUGEOT	9617408188/3272V0	303058	20956	17-0142	131,132,185,187,192, 193,465,466
GDS10078	CITROEN/ CITROEN UTILIT AIRES/PEUGEOT					101,139,480
GDS10080	CITROEN UTILIT AIRES/PEUGEOT					139,480

G-AP Ref.	MAKE	ADAPTABLE TO OE	GKN	SPIDAN	METELLI	PAGE
GDS10082	CITROEN/FIAT/PEUGEOT	32721L/3272L1/3272P5	303056	20954	17-0140	119,131,185,186,187, 192,193,465
GDS10083	CITROEN/PEUGEOT					133,134,464
GDS10084	CITROEN/PEUGEOT					133,134,464
GDS10087	CITROEN					106
GDS10090	CITROEN	96171856/3272A9/3272C3	301936	20663	17-0078	104
GDS10093	CITROEN/PEUGEOT					100,433
GDS10094	CITROEN/PEUGEOT					100,433
GDS10102	CITROEN/FIAT/PEUGEOT	32727K/3272J5	303046	20944		122,123,124,125,126, 127,128,129,160,161, 162,163,164,165,166, 167,168,169,170,468, 469,470,471,472,473, 474,475
GDS10103	CITROEN/FIAT/PEUGEOT	1495542080	303047	20945	17-0816	122,123,124,125,126, 127,128,129,160,161, 162,163,164,165,166, 167,168,169,170,468, 469,470,471,472,473, 474,475
GDS10104	CITROEN/FIAT/PEUGEOT	32735S/3273CH/3273CJ/3273Q5/ 3273Q8/3273Q9	303045	20943	17-0085	122,123,124,125,126, 127,128,129,160,161, 162,163,164,165,166, 167,168,169,170,468, 469,470,471,472,473, 474,475
GDS10105	CITROEN/FIAT/PEUGEOT	32726K/3272J3/3272J4	303042	20940		122,123,124,125,126, 127,128,129,160,161, 162,163,164,165,166, 167,168,169,467,468, 469,470,471,472,473, 474,475
GDS10113	CITROEN/PEUGEOT	327238/327239/327290/95644258/ 9614188080/32723N/3272J9	302436	20657	17-0175	133,134,135,463,464
GDS10114	CITROEN/PEUGEOT	95643956/9614188180/32736N/3273A9/ 3273C0/3273H4/3273H8	302437	20658	17-0174	133,134,135,464
GDS10117	CITROEN/PEUGEOT	327317/327318/327482/327483/95602238/ 95606796/96171858/96177248/32722N/ 3272A8/3272C0	301791/301793	21620/21622	17-0023	103,104,105,138,442
GDS10118	CITROEN	327304/3273Y4	302917	23351	17-0104	131
GDS10119	CITROEN/PEUGEOT					131,433
GDS10120	CITROEN/FIAT/PEUGEOT	9619947688/32735X/3273T3/3273T4	303055	20953	17-0139	119,131,185,186,187, 192,193,465
GDS10121	CITROEN	32721V/32721W/3272EH/3272NT/ 3272RA/3272RC/9642876780	303579	21967		114
GDS10124	PEUGEOT	3273HF/3273HG	304571	24251		433
GDS10125	PEUGEOT	3272HP/3272HQ	304570	24250		433
GDS10126	PEUGEOT					443,444
GDS10128	CITROEN	32721N/32726W/32727W/32728R/ 32729R/3272Y3/3272Y4/3272Y5	303250	21131		135,136,137
GDS10130	CITROEN/PEUGEOT	327453/327455/327459/327461/95582409/ 95603330/7910028946/3274C4	301918	21605		105,106,121,132,433
GDS10131	CITROEN	32721S/32722S/32728S/3272FP/ 3272FQ/3272Z7/3272Z8	303253	21134	17-0641	135,136,137,138
GDS10136	PEUGEOT					436
GDS10137	PEUGEOT	32730M/32730P			17-0388	436
GDS10138	CITROEN	32721T/32726Q	303351	21345		130,131
GDS10139	CITROEN	32738J/32738K/32738P/3273EJ	303582	21970	17-0330	114
GDS10140	CITROEN	32738L/32738N/3273EH/3273NY	303580	21968		114
GDS10141	CITROEN	32722V/32728T/32729T/3272EJ	303581	21969	17-0329	114
GDS10142	CITROEN/PEUGEOT	32726T/32727T	303578	21966		113,114,115,439
GDS10143	CITROEN/PEUGEOT	32738G/32738H	303577	21965		113,114,115,439
GDS10144	CITROEN/PEUGEOT	3273EQ/3273ER/3273HH/3273SG	303466/304573	24253/22114		106,107,108,109,433
GDS10146	CITROEN/PEUGEOT	3272EQ/3272ER/3272HR/3272RT/3272RH	303465/304572	24252/22113		106,107,433
GDS10147	CITROEN	9641777180/3272EX/3272EY	303469	22117	17-0706	106,107,108,109
GDS10150	CITROEN					138
GDS10152	CITROEN	32737K/32737L	303348	21342	17-0489	130,131
GDS10153	PEUGEOT					459
GDS10155	CITROEN/FIAT/PEUGEOT	3273S2/3273S4	303059	20957	17-0143	131,132,185,187, 192,193,465,466
GDS10156	CITROEN	32737F/32737G	303344	21338	17-0493	130



G-AP Ref.	MAKE	ADAPTABLE TO OE	GKN	SPIDAN	METELLI	PAGE
GDS10157	CITROEN	32724Q/32725Q	303347	21341	17-0488	130,131
GDS10159	CITROEN	3272T8	302916	23350	17-0103	131
GDS10161	CITROEN	32721Q/32729P	303343	21337	17-0492	130
GDS10162	PEUGEOT	32725P/32726P	303493	21960	17-0736	457,458,459,460
GDS10163	CITROEN	32720J	303252	21133		135,136,137
GDS10164	CITROEN	327251/327256/95666908/95666940/ 96048666/96095217/96666908/32721K/ 32729J/3272V2/3272W8/32724J/ 3272X6/3272X8	301928/302912	23346/20651	17-0014	130
GDS10165	CITROEN	32720H/32729L/3272Y2	303248	21129		135,136,137
GDS10167	CITROEN/PEUGEOT	96049018/96171857/32730Q/ 32731K/32736J/3273K5/3273K7	301933/302877/ 303249	20662/20672/ 21130	17-0079	135,136,137,480
GDS10173	CITROEN/PEUGEOT					109,110,111,112, 445,446,447,448
GDS10174	CITROEN	327305/24969815/32730E/32730F/ 32735H/3273N7	302929	21698	17-0147	130,131
GDS10177	PEUGEOT	327371/3273J1	301830	21666	17-0022	433,435,436
GDS10181	CITROEN	3272EV/3272EW	303471	22119		106,107,108
GDS10184	CITROEN	3272Q5				132
GDS10185	CITROEN	3273W8				132
GDS10186	CITROEN	000032730A/32735F/4246Y5/4246Y9				130
GDS10187	CITROEN	3272Z2			17-0134	102
GDS10188	CITROEN				17-0135	102
GDS10189	CITROEN	3272G9/3272Q5/3272Q6/3272Q7/3272R0	302884/302939	20631/20679	17-0154/17-0516	132
GDS10190	CITROEN/PEUGEOT	95643952/96145819/3273A6/3273C1/ 3273C6/3273H5			17-0176	134,464,465
GDS10191	CITROEN/PEUGEOT	327235/327240/327260/327287			17-0177	134,464,465
GDS10192	CITROEN	32724T/32725T	303576	21964		113,114,115
GDS10193	CITROEN	96171873	302879	20674		135,136,137
GDS10195	CITROEN	3273P3	302881	20676		132
GDS10202	CITROEN	3273W8/3273W9/3273X3	302940	20632	17-0151	132,133
GDS10203	CITROEN	32734S	303240	21120		135,136,137
GDS10204	CITROEN	32729G	303245	21126	17-0520	135,136,137
GDS10205	CITROEN	32732Q/32733K/32734T/32736G	303246	21127		136
GDS10206	CITROEN	3273EV/3273EW	303472	22120		106,107,108
GDS10207	CITROEN	32726V/32727V/3272EK	303583	21971		114
GDS10208	CITROEN	32738T/32738V/3273EK	303584	21972		114
GDS10210	PEUGEOT					441,442,450,451, 453,463
GDS10221	PEUGEOT					465
GDS10225	CITROEN	96171871	302878	20673	17-0519	135,136,137,138
GDS10226	CITROEN				17-0523	102,103
GDS10227	CITROEN				17-0524	102,103
GDS10229	CITROEN/PEUGEOT					101,102,109,110,111, 112,113,445,446,447, 448,479,480,481
GDS10231	CITROEN/PEUGEOT/TOYOTA					105,433,605
GDS10232	CITROEN/PEUGEOT/TOYOTA					105,433,605
GDS10234	CITROEN/FIAT					118,185,186
GDS10237	CITROEN/FIAT/LANCIA/PEUGEOT					132,185,187,193, 296,465,476
GDS10238	CITROEN/FIAT/PEUGEOT	1497191088				120,185,477
GDS10239	CITROEN/FIAT/PEUGEOT	1497192088				118,121,185,461, 462,476,477
GDS10241	CITROEN	3272FR/3272FS	304539	24192		106,108,109
GDS10242	CITROEN	3273CW/3273CX	304540	24193		106,108,109
GDS10244	CITROEN/FIAT/PEUGEOT					118,186,476,477
GDS10248	PEUGEOT	3272LE/3272LF	305338	25115	17-1217	439,440
GDS10249	CITROEN/PEUGEOT					108,439,440
GDS10250	CITROEN/PEUGEOT	3272VA/3272TZ/3272LG/3272LH	305339	25116	17-1213	108,112,439,440,441, 442,448,449,451,452, 463
GDS10251	CITROEN/PEUGEOT	3273QH/3273QJ/3273VN/3273VP	304940/305043	24669/24771		112,119,120,441,448, 449,451,452,463
GDS10253	CITROEN/PEUGEOT	3272PZ/3272QA/9684135380	304941	24670		108,112,119,120,433, 439,440,441,442,449, 450,451,452,462,463
GDS10254	CITROEN/PEUGEOT	3273LR/3273VH/9656329480	305040	24768		101,102,109,110,111, 112,113,479,480,481
GDS10255	CITROEN/PEUGEOT	3272LX/3272ZE/9656329380	305039	24767		101,102,109,110,111, 112,113,479,480,481
GDS10259	CITROEN	9650624180/3273HS/3273HT/3273HR/ 3273PT/9646326680/9646327880	304542/304577	24257/24195	17-0952	106,107,109

G-AP Ref.	MAKE	ADAPTABLE TO OE	GKN	SPIDAN	METELLI	PAGE
GDS10264	CITROEN/FIAT/LANCIA	1481452080/32724L/32729C	303681	22871	17-0956	119,185,187,193,295
GDS10265	CITROEN/PEUGEOT	3273EG/3273FA	304580	24260		116,461,462
GDS10266	PEUGEOT	3272GE/3272GF	304579	24259		461,462
GDS10267	PEUGEOT	3273KY/3273KZ	304595	24279		439,440
GDS10268	CITROEN/PEUGEOT	3272FT/3272FV	304685	24373	17-0809	110,112,445,446,447,448
GDS10270	PEUGEOT					477
GDS10276	CITROEN	3272JA/3272JC	304541	24194	17-0951	106,107,109
GDS10278	CITROEN	95619479/95648544/96009409/96173635	301507	20628		103,104,105
GDS10279	PEUGEOT					461,462
GDS10283	CITROEN/PEUGEOT					116,461,462
GDS10285	CITROEN/PEUGEOT					116,461,462
GDS10286	CITROEN/PEUGEOT					109,111,113,445,446,447,448
GDS10287	PEUGEOT					436,437
GDS10288	CITROEN					106,107,108
GDS10291	CITROEN/PEUGEOT					109,111,113,445,446,447,448
GDS10292	PEUGEOT					439,440
GDS10293	CITROEN					110,112,113
GDS10294	PEUGEOT					439,440
GDS10295	CITROEN	3273LT/9657555580	305406	25183		110,112,113
GDS10306	PEUGEOT					440
GDS10309	CITROEN					108,119
GDS10310	CITROEN/PEUGEOT	3272GG/3272GH	304581	24261		116,461,462
GDS10311	CITROEN/PEUGEOT	3272PV/3272PW	304586	24270		108,119,438,439,440
GDS10312	CITROEN	3272NW/3272QY/3272QZ	304644	24330		115
GDS10313	CITROEN	3273NW/3273NX/3273RH/3273RJ	304645	24331		115,117
GDS10314	CITROEN	3272RX/3272RY/3272WG/3272WH	304987/305432	25209/24715		116,117
GDS10320	CITROEN	3273SK/3273SL	304988	24716		116,117
GDS10325	CITROEN/PEUGEOT	3273QK/3273QL/9684135480	304942	24671		112,120,441,442,449,450,451,452,463
GDS10335	CITROEN	3272RZ/3272SA/9682500880	304989	24717		116,117
GDS10340	CITROEN	9801388580				119
GDS10343	PEUGEOT					433,463
GDS10344	CITROEN					114,115
GDS10345	PEUGEOT					436,437,438
GDS10348	CITROEN	3273RQ/3273RR	304648	24334		115
GDS10361	PEUGEOT					441,442,450,451,453,463
GDS10362	CITROEN/PEUGEOT	3272QE/9660896080/3272YW/3272QC	305042	24770		112,448,449,450,451,452
GDS10363	PEUGEOT	3273QS/3273QT/3273TW	304946	24675		441,442,450,451,453,463
GDS10364	CITROEN/PEUGEOT	3272NR/3272NS/3272PR/3272PS	304730	24457		106,108,433
GDS10380	PEUGEOT	3272QH/3272QJ/3272TK	304945	24674		441,442,450,451,453,463
GDS10381	CITROEN	3272HL/3272NY/3272QW/3272QX	304646	24332		115
GDS10382	CITROEN	3273HC/3273PG/3273RF/3273RG	304647	24333		115
GDS10383	CITROEN/PEUGEOT	3273QN/3273QP/9684135180/3273ZP	305045	24773		112,448,449,450,451,452
GDS10384	CITROEN					116,117
GDS10385	PEUGEOT					462
GDS10396	CITROEN/PEUGEOT	3273QX				116,465
GDS10419	CITROEN/PEUGEOT	3272HW/3272HX/9652371980/9652372280	304574	24254		107,433
GDS10420	CITROEN/PEUGEOT	3272HY/3272HZ/3272PL/9646326780/9646327980	304576	24256		107,109,433
GDS10421	CITROEN/PEUGEOT	3273TT/3273QQ/3273QR	304944	24673		112,120,441,442,463
GDS10422	CITROEN/FIAT/LANCIA/PEUGEOT	3272AS/3272AT/1485686080	305091	24832		117,192,293,466
GDS10423	CITROEN/PEUGEOT	3272CC/3272CE	305093	24834		117,466
GDS10424	CITROEN/PEUGEOT	3272RJ/3272RK	305094	24835		117,118,466
GDS10425	CITROEN/PEUGEOT	3273CE/3273CC	305098	24839		117,118,466
GDS10427	CITROEN/PEUGEOT	3272TH/3272QG/3272QF	304943	24672		112,120,441,442,450,451,452,453,463
GDS11001	DACIA	6001542122	301903	22065	17-0112	139
GDS11002	DACIA	6000591283	303521	21545		141
GDS11003	DACIA		303522	21546		141
GDS11004	DACIA	7701348085/7701348086/7701498699/7711106127	301850	22007	17-0106	139
GDS11006	DACIA	8200388903			17-0780	141
GDS11007	DACIA	8200388900			17-0781	141

G-AP Ref.	MAKE	ADAPTABLE TO OE	GKN	SPIDAN	METELLI	PAGE
GDS11012	DACIA	6001548658/6001548659/7711497479/ 8200499304/8200503358	304511/304512	24164/24165	17-0792	140
GDS11014	DACIA	6001548660/6001548661/7711497480/ 8200499306/8200503359	304513/304514	24166/24167	17-0793	140
GDS12003	DAEWOO					144
GDS12004	DAEWOO					144
GDS12006	DAEWOO					142
GDS12007	DAEWOO					141
GDS12008	DAEWOO					141
GDS12009	DAEWOO					144
GDS12010	DAEWOO					144
GDS12011	DAEWOO	96257821			17-0528	143
GDS12013	DAEWOO					143
GDS12015	CHEVROLET					96
GDS12016	DAEWOO					142
GDS12017	DAEWOO					141,142
GDS12018	DAEWOO					141,142
GDS12023	DAEWOO					141
GDS12024	DAEWOO					141
GDS12025	CHEVROLET	96257823			17-0530	95
GDS12026	CHEVROLET	96328842				94
GDS12027	CHEVROLET	96328841				94
GDS12044	DAEWOO	96257824			17-0531	143
GDS12045	CHEVROLET	96549101				96
GDS12046	CHEVROLET	96549102				96
GDS12058	CHEVROLET/DAEWOO	96348790				94,95,142
GDS14003	DAIHATSU	4342087Z05				147
GDS14004	DAIHATSU	4341087Z05				147
GDS14005	DAIHATSU	4342087211/4342097242				146,147
GDS14006	DAIHATSU	4341087211/4341097242				146
GDS14007	DAIHATSU					145
GDS14009	DAIHATSU					144,145
GDS14012	DAIHATSU					144
GDS14013	DAIHATSU					144,145
GDS14014	DAIHATSU					144,145
GDS14015	DAIHATSU					144
GDS14016	DAIHATSU					144
GDS14017	DAIHATSU					145
GDS14018	DAIHATSU					145
GDS14019	DAIHATSU					144
GDS14020	DAIHATSU					144
GDS14021	DAIHATSU					149
GDS14022	DAIHATSU	4341087405				149
GDS14024	DAIHATSU	4341087281				147
GDS14029	DAIHATSU	4342087406				149
GDS14031	DAIHATSU					145,149
GDS14032	DAIHATSU					145,149
GDS14035	DAIHATSU/PERODUA					145,433
GDS14036	DAIHATSU/PERODUA					145,433
GDS15004	CHRYSLER					99
GDS15051	DODGE	05105649AC				150
GDS15052	DODGE	05105660AC				150
GDS15053	DODGE	05085220AB				150
GDS15054	DODGE	05085224AB				150
GDS16001	FIAT	46307695				179,187
GDS16002	FIAT	46307815				179,187
GDS16003	JEEP	4713189/4720381				280
GDS16004	JEEP	4720380				280
GDS16009	JEEP	05012749AB/05012749AA				279
GDS16012	JEEP					280
GDS16013	JEEP					280
GDS16021	JEEP			28082		279
GDS17001	FIAT	46307109	302972	20342	17-0227	153,154
GDS17002	FIAT					152,179
GDS17003	FIAT					152,179
GDS17005	FIAT					179,180
GDS17007	FIAT					179
GDS17010	FIAT/LANCIA	7694584				153,154,177,178, 294,295
GDS17011	FIAT/LANCIA	7735107				153,154,177,178, 294,295
GDS17013	FIAT	46302200SX				152,157,179
GDS17014	FIAT	46302199SX				152,157,179
GDS17015	FIAT	7637734	303700	22890		193
GDS17016	FIAT	7682656	303701	22891		193



G-AP Ref.	MAKE	ADAPTABLE TO OE	GKN	SPIDAN	METELLI	PAGE
GDS17017	FIAT	46307674			17-0635	157,158,159
GDS17018	FIAT	7740977	303656	22846	17-0245	181
GDS17019	FIAT	46307678			17-0636	157,158,159
GDS17020	FIAT		303687	22877		193
GDS17021	FIAT		303688	22878		193
GDS17022	FIAT	7794472	303657	22847	17-0246	181
GDS17023	FIAT LCV					195
GDS17025	FIAT	7765363	303648	22838	17-0220	153,154
GDS17029	FIAT					152,179
GDS17030	FIAT					152,179
GDS17031	FIAT					157,177,187,189,193
GDS17032	FIAT	46307466/46307565	304366	23784	17-0536	181,182,184
GDS17033	FIAT	46307467/46307792/71787055	304367	23785	17-0537	181,184
GDS17034	FIAT	51810404				152
GDS17037	FIAT		303658	22848	17-0247	181
GDS17038	FIAT	46307110/46307408	302971	20341	17-0226/17-0671	153,154
GDS17039	FIAT	46307147	303659	22849	17-0248	181
GDS17040	FIAT/OPEL/VAUXHALL	73503002/24451256	304907	24636		156,418,425,426,427,428,654,657,658,659
GDS17041	FIAT		303650	22840		153,154
GDS17044	OPEL/VAUXHALL	13250859/26119529/374632/374818	305057	24785	17-1018	407,408,647,649
GDS17045	ALFA ROMEO/FIAT	55700562/55700560			17-0799	12,182
GDS17046	FIAT					181,184
GDS17050	CITROEN/FIAT/PEUGEOT	1349785080/3273PP /1369960080/1608505580	305815			120,121,122,129,170,171,175,467,476
GDS17052	CITROEN/PEUGEOT	3273TC				121,466
GDS17053	CITROEN/FIAT/PEUGEOT	1349788080/1369961080/1608505480	305814			120,175,476
GDS17054	FIAT/LANCIA	46308409/46308523	304526			175,176,292,295
GDS17055	FIAT					175
GDS17056	FIAT					152,179
GDS17057	FIAT	51816768				177
GDS17058	FIAT					177
GDS17059	FIAT				17-0804	176
GDS17060	FIAT				17-0803	176
GDS17061	FIAT				17-1136	175
GDS17062	FIAT					175
GDS17063	FIAT					177
GDS17064	FIAT					177
GDS17066	FIAT/LANCIA	55700558/46308329/46308522/46308367	304656/304660	24348/24344		176,182,184,292,295
GDS17067	FIAT					157
GDS17068	FIAT					157
GDS17069	FIAT					157
GDS17070	OPEL/VAUXHALL	13149834/374791	305054	24782		407,408,648,649
GDS17071	OPEL/VAUXHALL	13149833/374790	305053	24781	17-1014	407,408,648,649
GDS17076	FIAT					157
GDS17077	FIAT					188,189
GDS17078	FIAT					157
GDS17079	FIAT					157
GDS17080	FIAT					188,189
GDS17081	FIAT					157
GDS17082	FIAT/LANCIA	46308345/51808106/55700561	304655	24343		182,295
GDS17088	FIAT	51807676				177
GDS17089	FIAT					177
GDS17099	FIAT					188,189
GDS17101	FIAT				17-0834	151
GDS17102	FIAT	51757652				157
GDS17106	FIAT	51822813				159
GDS17107	ALFA ROMEO					1,2,11
GDS17108	FIAT					188,189
GDS17109	FIAT					176,182,184
GDS17110	ALFA ROMEO					3
GDS17111	ALFA ROMEO/FIAT					12,182,183,184
GDS17112	FIAT				17-0835	151
GDS17113	FIAT	51757653				157
GDS17114	FIAT		303649	22839		153,154
GDS17115	ALFA ROMEO					5
GDS17116	ALFA ROMEO					5
GDS17117	ALFA ROMEO					3
GDS17118	FIAT					188
GDS17119	FIAT/FORD					152,219
GDS17120	FIAT/FORD					152,219
GDS17121	FIAT					155
GDS17122	ALFA ROMEO					4,5,10
GDS17123	ALFA ROMEO					5,6,10
GDS17124	ALFA ROMEO					4,5,10

G-AP Ref.	MAKE	ADAPTABLE TO OE	GKN	SPIDAN	METELLI	PAGE
GDS17136	FIAT					155
GDS17137	FIAT					180,181
GDS17141	FIAT					180,181
GDS17142	FIAT					176,182,183
GDS17143	FIAT					176,182,183
GDS17144	ALFA ROMEO					12
GDS17145	ALFA ROMEO					5,6,10
GDS17146	FIAT/LANCIA	55702107/46308324/51808105	304658	24346		175,182,183,184,295
GDS17147	FIAT/LANCIA	46308366/46308521	304659	24347		175,176,184,292,295
GDS17148	ALFA ROMEO					12
GDS17149	FIAT					180,181
GDS17151	CITROEN/PEUGEOT	3272SN/3272SL/51783854				121,466
GDS17152	FIAT					158
GDS17153	FIAT					158
GDS17157	FIAT					175,184
GDS17158	FIAT					181
GDS17159	ALFA ROMEO					2,3,11
GDS17170	FIAT/FORD	51787863/51955481/1541818/9S513B437AA	305585			151,219
GDS17171	FIAT/FORD	51787861/51955476/9S513B436AA/1541812	305586			151,219
GDS17172	FIAT/LANCIA	55702108/46308330/51808108	304657			182,183,295
GDS17178	FIAT					155
GDS17179	FIAT					155
GDS17180	FIAT					154
GDS17187	FIAT	46477176/7668798	303652	22842		187
GDS17190	FIAT	46307368	304374	23792		187
GDS17191	FIAT	46307369	304375	23793		187
GDS17192	FIAT	46308405/51808314	304522	24175		181
GDS17193	FIAT	46308404/51808313	304523	24176		181
GDS17194	FIAT/LANCIA	51795511	304568	24248		154,155,188,189,291
GDS18001	FORD	1008428/1023213/5029044/6757676/7294553/ 93BG3B437BD/R93BG3B437BD/ R93BG3B437BE	302403	21513	17-0259	221,223,224,225,226
GDS18002	FORD	1008402/1023212/1023213/5029040/5029041/ 6757672/7024791/7294551/93BG3B437AAE/ 93BG3B437ABD/93BG3B437ABE/ R93BG3B437AAE/R93BG3B437ABD/ R93BG3B437ABE	302400/302405	21521/21523	17-0257/17-0261	220,221,222,223, 224,225,226
GDS18003	FORD	1023211/5029039/6757668/7294550/ 93BG3B436BD/93BG3B436BE R93BG3B436BE/R93BG3B436BD	302404	21514	17-0260	221,222,223,224, 225,226
GDS18004	FORD	1008381/1023211/5029037/6757666/7294549/ 93BG3B436ABD/93BG3B436ABE/ R93BG3B436ABD/R93BG3B436ABE	302406	21520	17-0262	221,222,223,224, 225,226
GDS18005	FORD	1023209/5029038/7024790/93BG3B436AD/ 93BG3B436AE/R93BG3B436AE	302397	21512	17-0256	220,221,222,223,224, 225,226
GDS18006	FORD	1023209/5029036/7024789/93BG3B436AAD/ 93BG3B436AAE/R93BG3B436AAE	302399	21518	17-0258	220,221,222,223, 224,225,226
GDS18007	FORD	1059534/R94FX3220BA	303545	21707	17-0162	219
GDS18008	FORD/SEAT/VOLKSWAGEN	1020964/1097313/1097317/1132482/ 1132487/7201674/7M0407272A/7M0407272AV/ 7M0407272E/7M0407272F/7M0407272H/ 7M0407272K/7M0407450AX/7M0407452X/ 95VW3B436BA/95VW3B436FA/7M3407452AX	302831/302835	20151/20155	17-0267	214,215,546,547, 719,720
GDS18009	FORD/SEAT/VOLKSWAGEN	1016692/1020967/1097318/1097321 1132493/1132497/1132498/7201677 7M0407271AV/7M0407271AX/7M0407271F/ 7M0407271J/7M0407271L/7M0407271Q/ 7M0407271R/7M0407449AX/7M0407451AX/ 95VW3B437BA/95VW3B437FA /7M0407271A/95VW3B437HA/1097322	302830/302832/ 302834	20150/20152/ 20154	17-0360	214,215,546,547, 719,720
GDS18010	FORD/VOLKSWAGEN	1097319/1132495/7201678/7M0407271C/ 7M0407271M/7M0407271MX/95VW3B437CB	302838	20158		215,721
GDS18011	FORD					202
GDS18012	FORD					197
GDS18015	FORD		304272	23356	17-0540	198,200
GDS18016	FORD	5029043/7024792/93BG3B437AD/ 93BG3B437AE/R93BG3B437AE	302398	21511	17-0255	220,221,222,223, 224,225,226
GDS18018	FORD					203,204,205
GDS18019	FORD		304273	23357	17-0542	198
GDS18027	FORD	1S713B437AD/1447468/4106378				204,226,227

G-AP Ref.	MAKE	ADAPTABLE TO OE	GKN	SPIDAN	METELLI	PAGE
GDS18028	FORD	1S713B436AC/1447467				204,226,227
GDS18032	FORD/FORD LCV					202,231,240
GDS18035	FORD					236,237,239
GDS18036	FORD					236,237,239
GDS18039	FORD	1014109/5024568/5024569/5026652/ 6596773/91AX3219DA/94AG3A427EA/ R92AX3219DA	301359	23607	17-0250	198,199,200,231
GDS18040	FORD	1014111/5024574/5024575/5026653/ 6596778/6596779/91AX3220DA/ 94AG3A428DA/R92AX3220DA	301360	23619	17-0249	198,199,200,231
GDS18041	FORD	4490558/5083616/2T143B437FA/ 2T143B437FB/2T143B437FC/2T143B437FD	305037	24765	17-0842	238
GDS18042	FORD	3667428/XS4W3B437DB/1345864	304232	23298	17-0372	204,205
GDS18043	FORD					226
GDS18044	FORD	5024576/91AX3220EA	301358	23621	17-0090	199,200,231
GDS18046	FORD	1122810/1348325/1420536/1602942/ 3667429/XS4W3B436DB	304233	23299	17-0373	204,205
GDS18056	FORD/MAZDA					220,303
GDS18057	FORD/MAZDA					220,303
GDS18058	FORD					235
GDS18077	DAIHATSU					149
GDS18078	DAIHATSU					149
GDS18081	FORD/MERCURY					198,234,336
GDS18083	FORD/MAZDA					220,321
GDS18087	FORD/KIA/MAZDA/MERCURY					195,198,285,320,336
GDS18093	FORD					201,231
GDS18101	FORD	3652047/3959551/XS4W3B437BC/1328500/ 1602965/1S4W3B437AB/1S4W3B437AA/ 4166909/4187268/RM1S4W3B437AB	304234/304236	23300	17-0374	204,205
GDS18102	FORD	1141768/3652045/XS4W3B436BB	304235	23301	17-0375	204,205
GDS18103	FORD					200
GDS18118	FORD	5026505/90FX3220CA	301346	23726		197,202
GDS18128	FORD	1020789/1629459/5018713/6747789/6962758/ 85GG4234CA	300659	21781		216,217,218,234
GDS18129	FORD	5018714	300660	21799		216,217,218,234
GDS18137	FORD					201,204
GDS18138	FORD					201,204
GDS18140	FORD		303544	21706	17-0163	219
GDS18141	FORD	R97FX3220DA/1059528			17-0970	202
GDS18142	FORD					236,237,239
GDS18143	FORD					226
GDS18148	FORD/MERCURY					198,234,336
GDS18153	FORD/MERCURY					198,234,336
GDS18175	FORD					197,202,231
GDS18176	MAZDA					313
GDS18178	FORD					220
GDS18186	FORD					220
GDS18189	FORD/VOLVO					195,196,205,206,207, 208,209,210,740,743, 749
GDS18190	FORD					196,206,207,208, 209,210
GDS18191	FORD					206
GDS18192	VOLVO					740,741,742,743,750
GDS18193	FORD					205
GDS18194	FORD/VOLVO	1223791/1305328/1354068/1456976/1475131/ 3M513B437NE/3M513B437NF/3M513B437NG/ 3M513B437NH/30681130/30711770/30783171/ 30787778/36000443/36000552/8603251/ 8603487	305156	24897		196,206,209,210,740, 742,743,750
GDS18195	FORD					204,205
GDS18197	RENAULT	7711135956/8200278602	305254	25011		522,523
GDS18198	FORD					209,210
GDS18199	SAAB					541,542
GDS18201	FORD/MAZDA	8V513B436AAC				202,203,204,212, 213,302
GDS18202	FORD/MAZDA					202,203,204,212, 213,302
GDS18206	FORD/VOLVO					195,196,205,206,207, 208,209,210,740,743, 749



G-AP Ref.	MAKE	ADAPTABLE TO OE	GKN	SPIDAN	METELLI	PAGE
GDS18209	FORD	1C153B436AE				236,237,238,239,240
GDS18213	FORD	1C153B437AE				236,237,238,240
GDS18216	FORD	1142794/1359345/1506722/2S613B437AB/ 2S613B437AC/2S613B437AD/2S613B437AE/ 8V513B437AAA/2S6W3B437AA/4330605	304537/305486	25263/24190		202,212
GDS18217	FORD	1142790/1359342/1468572/1506723/ 2S613B436AB/2S613B436AC/2S613B436AD/ 2S613B436AE/2S613B436AG	304538	24191	17-0839	203,212
GDS18218	FORD	1223785/1305939/1353398/1437541/ 3M513B437DAC/3M513B437DAD/ 3M513B437DAE/3M513B437DAF/ 3M513B437DAG/30681126/8603362/1682285	305344	25121		195,196,205,206,207, 208,209,210
GDS18219	FORD/VOLVO	3M513A327BB/1223723/1305938/1431359/ 1474624/1726275/3M513B436DAC/ 3M513B436DAD/3M513B436DAE/ 3M513B436DAF/3M513B436DAH/ 30681127/8603363	305345	25122		195,196,205,206,207, 208,209,210,743
GDS18230	JAGUAR					275
GDS18231	LDV	538450101/538450081	305466	25243		300,301
GDS18232	LDV	538450102/538450082	305467	25244		300,301
GDS18240	JAGUAR					275,278
GDS18242	FORD	4166490/1C153B436CF/4104909/ 1C153B436CD/RM1C1J3B436CF	305716	25493		236,237,239
GDS18247	RENAULT	301012675R/3910100Q3G/4406234 3910100Q4F/4406518/4420055/4422058 /3910100Q4E	305484	25261		516
GDS18248	NISSAN/OPEL/RENAULT	3910000Q4G/3910000Q3M/3910000Q4H/ 4406235/4406519/4420054/4422057	305485	25262		367,368,418,516,517
GDS18251	FORD					209
GDS18252	FORD					226,227
GDS18259	FORD	3C113B437BC/4507300/4602023/ RM3C113B437BC	305711	25488		238,239
GDS18260	FORD	3C113B436BB/3C113B436BC/4507298/ 4615963/RM3C113B436BC	305712	25489		238,239
GDS18261	FORD	9M513B437BA				206
GDS18262	FORD	9M513B436BB				206
GDS18263	FORD	1417751/1501263/2T143B437CD/ 2T143B437CE/9T163B437AA/2T143B437CA/ 1328365/1383755/1451465/2T143B437CB/ 2T143B437CC/4501957/4994093/ 9T163B437AAD/RM2T143B437CB	305035	24763	17-0840	238
GDS18264	FORD	1501261/1501262/2T143B436CA/ 2T143B436CF/9T163B436AA/1328363 2T143B436CC	305036	24764	17-0841	238
GDS18271	OPEL/RENAULT	4417910/93856308/7711368831	304781	24508		429,430,535,536
GDS18274	RENAULT	8200409664/8200664841	304779	24506		501,531
GDS18280	FORD/VOLVO					206,209,210,743
GDS18289	FORD	5026504/90FX3219CA	301347	23728		197,202
GDS18290	FORD					209
GDS18291	CITROEN/FIAT/PEUGEOT					118,192,466
GDS18292	FORD	8C114B436AD/1512911/8C113B436AD				235,236,238,239,240
GDS18293	FORD	1512912/8C113B437AD				235,236,238,239,240
GDS18294	FORD					196,210,211,212,218
GDS18295	FORD					196,210,211,212,218
GDS18296	FORD					211,212
GDS18301	OPEL/RENAULT/VAUXHALL	4417909/93856307/7711368832/8200452273	304783	24510		429,430,535,536, 659,660
GDS18309	FORD	1333976/1468577/1513990/1697493/ 4N113B437CA/4N113B437CB/4N113B437CD	304535	24188		203,213
GDS18322	FORD					195,196,211,212,219
GDS18323	FORD					195,196,211,212,219
GDS18324	MAZDA					302
GDS18325	MAZDA					308
GDS18326	FORD	1333973/1468573/1496809/4N113B436CA/ 4N113B436CB/4N113B436CC	304536	24189		203,213

G-AP Ref.	MAKE	ADAPTABLE TO OE	GKN	SPIDAN	METELLI	PAGE
GDS18327	FORD	1364029/1454214/1475136/1528657/1686116/ 3M513B437ASD/3M513B437ASE/ 5M513B437SA/5M513B437SB/5M513B437SC /5M513B437SD/5M513B437SE/5N513B437SE	305116	24857		196,206,209,210
GDS18328	FORD/VOLVO	1223788/1305327/1353399/1456975/1474893/ 1685799/3M513B437KE/3M513B437KF/ 3M513B437KG/3M513B437KH/3M513B437KJ/ 3M513B437KC/30681128/30711772/30783167/ 30787775/31256931/36000440/ 36000549/36001356/8063258/8603486	305126	24867		196,206,208,209, 210,740,743,749
GDS18329	FORD/VOLVO	1223725/1305325/1437453/1456973/ 1474892/1685795/3M513B436KE 3M513B436KG/3M513B436KH 3M513B436KC/30681129/30783002 30787783/31256930/36000448/36000557/ 36001360/8603259/3M513B436KF/ /3M513B436KJ//30783168	305127	24868		196,206,208,209, 210,740,743,749
GDS18333	FORD	1308638/1318854/1326339/1361879/1478995/ 1513996/4S613B436AD/4S613B436AE/ 4S613B436AF/4S613B436AG	304534	24187		203,213
GDS18335	FORD					235,238
GDS18336	FORD					207,210
GDS18337	FORD/VOLVO	1310250				195,205,206,207, 208,209,210,740, 743,749
GDS18340	FORD					213,228,229,230,232
GDS18341	FORD					213,228,229,230,232
GDS18342	JAGUAR					275
GDS18343	FORD					196,211,212,219
GDS18350	FORD					214,229,230,233
GDS18351	FORD	1326340/1361877/1478997/1520669/ 4S613B437AD/4S613B437AE/4S613B437AF/ 4S613B437AG	304533	24186		203,213
GDS18358	FORD	1324168/1431161/1450574/1567824/ 1686113/4M513B436JD/4M513B436JE/ 4M513B436JF/1474807	305104	24845		195,196,206,208,210
GDS18359	FORD	1324166/1431162/1475135/1567848/ 1686114/4M513B437JA/4M513B437JC/ 4M513B437JD/4M513B437JE	305105	24846		195,196,206,208,210
GDS18361	NISSAN					362
GDS18362	NISSAN					362
GDS18363	FORD					214,229,230,233
GDS18364	VOLVO					754
GDS18365	NISSAN					362
GDS18366	RENAULT					523
GDS18367	VOLVO					740,742,743,750
GDS18381	FORD					211,212
GDS18382	FORD					211,212
GDS18402	LDV	538450085/538450103	305468	25245		300,301
GDS18405	FORD					195
GDS18406	FORD					195,203,204
GDS18407	FORD					204
GDS18408	LAND ROVER					299
GDS18409	LAND ROVER					299
GDS18413	FORD					235,238
GDS18414	NISSAN					362
GDS18434	FORD	3C113B437AB/4507299/4602017/	305584	25361		238,239
GDS18435	FORD	3C113B436AB/3C113B436AC/4615962	305713	25490		238,239
GDS21019	CHEVROLET					96
GDS21020	CHEVROLET					96
GDS21021	CHEVROLET					96
GDS21032	OPEL/SAAB/VAUXHALL	13109194/13166590/374537/13166587/ 374470/9186550	304874/304873	24603/24600		419,420,426,427,428, 541,654,655,657,658, 659
GDS21035	OPEL/VAUXHALL					396,397,637,638
GDS21036	OPEL/VAUXHALL					394,400,629,639
GDS21040	GM					242,243
GDS21050	OPEL/VAUXHALL	374830/13265648				409,649,650
GDS21051	OPEL/VAUXHALL	13214836/374641	305207	24958		394,395,396,397,398, 432,636,637,638,640, 661,662

G-AP Ref.	MAKE	ADAPTABLE TO OE	GKN	SPIDAN	METELLI	PAGE
GDS21053	OPEL/VAUXHALL	13166589/374626	305233	24984		419,426,428,654,657,659
GDS21054	OPEL/VAUXHALL	374831				409,649,650
GDS21055	OPEL/VAUXHALL					394,395,396,397,635,636,637,638,640,661
GDS21056	OPEL/VAUXHALL	24462250/374552	304431	24084		395,396,397,398,432,637,638,661,662
GDS21061	OPEL/VAUXHALL					419,427,428,654,658
GDS21062	OPEL/VAUXHALL	13124680/374562	304435	24088		394,395,396,397,398,432,635,637,638,640,661,662
GDS21063	OPEL/VAUXHALL	13136382/374547	304428	24081		394,395,396,397,432,635,636,637,638,640,661,662
GDS21070	FORD					229,230,233
GDS21071	OPEL/VAUXHALL	13124679/374561	304434	24087		394,395,397,398,432,635,637,638,640,661
GDS21072	OPEL/VAUXHALL					399,400,638,639
GDS21073	OPEL/VAUXHALL	374569/24462251	305210	24961		395,396,397,398,637,638,640
GDS21074	OPEL/VAUXHALL					394,399,400,629,639
GDS21075	OPEL					394,400
GDS21076	OPEL/VAUXHALL					394,399,400,629,638,639
GDS21092	OPEL/VAUXHALL	13166588/374625	305234	24985		419,426,428,654,657,659
GDS22001	TOYOTA					611
GDS22003	TOYOTA					611
GDS22004	TOYOTA					611
GDS22005	TOYOTA					606
GDS22006	TOYOTA					606
GDS22019	HONDA					247
GDS23002	ISUZU					275
GDS23003	ISUZU					275
GDS23004	HOLDEN					244
GDS23005	HONDA					258
GDS23008	HONDA					245
GDS23011	HONDA	44306SCAG00				255
GDS23013	HONDA					258
GDS23014	HONDA					248
GDS23015	HONDA					248
GDS23020	HONDA					252,253
GDS23022	HONDA	44306SNLT10/44306SNA000				248
GDS23023	HONDA	44305SNLT00/44305SNA000				249
GDS23024	HONDA					249
GDS23025	HONDA					249
GDS23026	HONDA	44306SEFE00				247
GDS23027	HONDA	44305SEFE00				247
GDS23030	HONDA	44305SH3960/44305SH3961/44305SH3A00/				250,251
GDS23031	HONDA					245
GDS23032	HONDA					245
GDS23038	ROVER		304278	23362		540
GDS23039	ROVER		304279	23589		540
GDS23040	HONDA/ROVER		301430		17-0362	255,538,539,541
GDS23042	HONDA					255
GDS23045	HONDA					249
GDS23049	ACURA/HONDA					1,259
GDS23050	ACURA/HONDA					1,259
GDS23051	HONDA					248
GDS23061	HONDA					245
GDS23066	HONDA	44305S5DA01A				248
GDS23068	HONDA	44306S5DA01A				248
GDS23069	HONDA					248
GDS23070	HONDA	44306SELT00				248
GDS23071	HONDA	44305SELT00				248
GDS23072	HONDA					260
GDS23073	HONDA					260
GDS23074	HONDA	44305S9A000/44305SCAG00				255
GDS23078	HONDA/ROVER		304275	23359	17-0363	255,538,539
GDS23080	ACURA/HONDA					1,259
GDS23084	HONDA					245
GDS23087	HONDA					248



G-AP Ref.	MAKE	ADAPTABLE TO OE	GKN	SPIDAN	METELLI	PAGE
GDS23089	HONDA	44306S5DA51				254
GDS23091	HONDA					258
GDS23097	HONDA	44305S5DA51				254
GDS23116	HONDA					259
GDS23119	HONDA					248,249
GDS23120	HONDA					248,249
GDS23122	HONDA/ROVER		304274	23358	17-0338	255,538,539
GDS23124	HONDA					255
GDS23127	ACURA/HONDA					1,248
GDS23128	ACURA/HONDA					1,248
GDS23129	ISUZU					275
GDS23135	HONDA					251
GDS23142	HONDA					259
GDS23146	HONDA					259
GDS23149	HONDA					252
GDS23155	HONDA					253
GDS23164	HONDA					254
GDS23165	HONDA					254
GDS23188	HONDA					255
GDS23189	HONDA					256
GDS23190	HONDA					255
GDS23191	HONDA					254
GDS23192	HONDA					254
GDS23198	HONDA	42310SXSA01	305928	25734		256
GDS23199	HONDA	42311SXSA01/42311SXSA010M1	305601	25378		256
GDS23216	HONDA					256
GDS23250	HONDA					247
GDS23259	HONDA					254
GDS23266	HONDA					254
GDS23270	HONDA					247
GDS23287	HONDA					254
GDS24001	PROTON					484
GDS24002	HYUNDAI					262,263,264
GDS24003	HYUNDAI	4950038950				272
GDS24004	HYUNDAI	4950038900				272
GDS24009	HYUNDAI					261,266
GDS24010	HYUNDAI					266
GDS24011	HYUNDAI					273
GDS24012	HYUNDAI					273
GDS24014	HYUNDAI					273
GDS24015	HYUNDAI					273
GDS24016	HYUNDAI					272
GDS24017	HYUNDAI					272
GDS24018	HYUNDAI					261
GDS24019	HYUNDAI					261
GDS24020	HYUNDAI					265
GDS24022	HYUNDAI					262,263
GDS24023	HYUNDAI					262,263
GDS24028	HYUNDAI					261
GDS24029	HYUNDAI					261
GDS24031	HYUNDAI	495003K200				273
GDS24032	HYUNDAI	495003K250				273
GDS24033	HYUNDAI	4950002560/4950002460				264
GDS24034	HYUNDAI					264
GDS24035	HONDA					260
GDS24036	HONDA					260
GDS24038	HYUNDAI	4950025200				263
GDS24043	HYUNDAI					261
GDS24044	HYUNDAI					261
GDS24045	HYUNDAI	495001E600				261
GDS24046	HYUNDAI	495001E650				261
GDS24053	HYUNDAI	495012D312				270
GDS24054	HYUNDAI	495002D312				270
GDS24058	HYUNDAI/KIA					274,282
GDS24059	HYUNDAI					265,270
GDS24060	HYUNDAI					265,270
GDS24061	HYUNDAI					265
GDS24062	HYUNDAI					265
GDS24076	HYUNDAI					265
GDS24077	HYUNDAI					265
GDS24094	HYUNDAI/KIA					273,282,283
GDS24104	HYUNDAI					264
GDS24107	HYUNDAI					269
GDS24108	HYUNDAI					273
GDS24110	HYUNDAI					274

G-AP Ref.	MAKE	ADAPTABLE TO OE	GKN	SPIDAN	METELLI	PAGE
GDS24111	HYUNDAI	495002E500				274
GDS24112	HYUNDAI					274
GDS24113	HYUNDAI	4950729C10				265
GDS24116	HYUNDAI					271
GDS24117	HYUNDAI/KIA	495012P000				271,272,286
GDS24123	HYUNDAI	4950038362				272
GDS24124	HYUNDAI	4950038312				272
GDS24125	HYUNDAI	4950038791				272
GDS24126	HYUNDAI	4950038741				272
GDS24127	HYUNDAI	495003K410				264,267,273
GDS24128	HYUNDAI	495003K460				264,267,273
GDS24129	HYUNDAI	4950025210				261,262,263
GDS24140	HYUNDAI					266
GDS24141	HYUNDAI	495001C510				266
GDS24142	HYUNDAI	495003L551				264
GDS24143	HYUNDAI	495003L500				264
GDS24144	HYUNDAI					273
GDS24145	HYUNDAI					273
GDS24147	HYUNDAI					261,262,263
GDS24148	HYUNDAI					261,262,263
GDS24153	HYUNDAI	495001J250				267
GDS24156	HYUNDAI	495000X000				267
GDS24157	HYUNDAI	495000X010				267
GDS24158	HYUNDAI/KIA	495003A312				274,282
GDS24162	HYUNDAI					265,269
GDS24163	HYUNDAI					265,269
GDS24172	HYUNDAI/KIA	495012E900/495012E500/495011F200				274,275,287,288
GDS24173	HYUNDAI/KIA					274,275,287,288
GDS24188	HYUNDAI	495001E000/495001E010				262
GDS24194	HYUNDAI	495001C352				266
GDS24195	HYUNDAI/KIA					271,272,286
GDS24200	HYUNDAI					266
GDS24216	HYUNDAI	495012E400				274
GDS24217	HYUNDAI	4950126560				271,272
GDS24218	HYUNDAI	4950126510/4950126511				271,272
GDS24221	HYUNDAI/KIA					274,275,287,288
GDS24228	HYUNDAI	495013S260/495013S280/495013S261				273
GDS24229	HYUNDAI	495003S210/495003S211				273
GDS24232	HYUNDAI	495012P200				271
GDS24233	HYUNDAI	495002P200				271
GDS24240	HYUNDAI	495000X300				267
GDS24241	HYUNDAI	495000X310				267
GDS24246	HYUNDAI	495001R000				261
GDS24247	HYUNDAI	495011R000/495011R500				261
GDS24248	HYUNDAI	495003X200				265,267
GDS24249	HYUNDAI	495013X200				265,267
GDS24259	HYUNDAI	495011R010/495011R510				261
GDS24260	HYUNDAI	495001R010				261
GDS24261	HYUNDAI	495013S271/495013S251/495013V270				264,268,273
GDS24262	HYUNDAI	495003S201/495003Z200/495003V200				264,268,273
GDS24264	HYUNDAI	495003X100				267
GDS24265	HYUNDAI	495013X110				265,267
GDS24272	HYUNDAI	495003X110				267
GDS24282	HYUNDAI	495002L010				268
GDS24283	HYUNDAI	495012L010				268
GDS24287	HYUNDAI	496002E000				274,275
GDS24288	HYUNDAI	495002V100				275
GDS24289	HYUNDAI	495012V100				275
GDS24290	HYUNDAI	495001R200				261
GDS24291	HYUNDAI	495011R200				261
GDS24293	HYUNDAI	495011R300/495001R300				261
GDS24294	HYUNDAI	495001R300/495011R300				261
GDS24296	HYUNDAI	495012L210				268
GDS24297	HYUNDAI	495002L210				268
GDS24299	HYUNDAI					268
GDS24300	HYUNDAI/KIA					274,275,287,288
GDS24304	HYUNDAI					267
GDS24305	HYUNDAI	495012L410				268
GDS24317	HYUNDAI/KIA					268,288
GDS24318	HYUNDAI/KIA					268,288
GDS24321	HYUNDAI	495013X100				267
GDS24347	HYUNDAI	495013Z450				268
GDS24352	HYUNDAI/KIA					274,275,287,288
GDS24362	HYUNDAI/KIA					268,288
GDS24363	HYUNDAI	495002D012				265,269

G-AP Ref.	MAKE	ADAPTABLE TO OE	GKN	SPIDAN	METELLI	PAGE
GDS24364	HYUNDAI	495012D012				265,269
GDS24398	HYUNDAI					275
GDS24399	KIA					281,282,284
GDS24400	HYUNDAI/KIA					268,288
GDS24401	KIA					285
GDS26004	HOLDEN					244
GDS27001	HYUNDAI					273
GDS27002	KIA	495003C451				283
GDS27005	KIA					285
GDS27006	KIA					285
GDS27011	KIA	0K2N42560X				287
GDS27017	HYUNDAI	4950002550/4950002450				264
GDS27018	KIA	0K56P25500A				281
GDS27020	KIA	0K56P25600A				281
GDS27024	FORD/KIA	0K30A25600/KK38825400A				201,284
GDS27025	KIA					284
GDS27026	FORD/KIA					201,284
GDS27027	KIA					284
GDS27030	KIA	0K2NE2550XA				287
GDS27031	KIA					286
GDS27034	KIA					280
GDS27035	KIA					280
GDS27037	KIA	0K5582560XA				281
GDS27040	KIA	KK33125600A				284
GDS27042	KIA	KK33125400				284
GDS27049	FORD/KIA					220,286
GDS27050	KIA					286
GDS27053	KIA					286,287
GDS27055	KIA					286
GDS27059	KIA					287
GDS27062	FORD/MAZDA	3M353B436AA/1328094				232,314
GDS27063	FORD/MAZDA	2M353B437AA/1339667/2M353B437CB				232,314
GDS27064	KIA	495003E110				286
GDS27065	KIA	495003E000				286
GDS27066	KIA					286,287
GDS27067	KIA	0K01225500A				287
GDS27070	KIA	0K2C32550X				286,287
GDS27071	KIA					280,286,287
GDS27078	KIA	0K55C25500A				281
GDS27079	KIA	0K55C25600A				281
GDS27084	KIA					287
GDS27096	KIA					281,285
GDS27097	KIA					281,285
GDS27099	KIA					281,285
GDS27102	KIA	495001D200				280
GDS27105	KIA	495001F500				287
GDS27108	KIA	KK16825400				284
GDS27109	KIA	KK16825600				284
GDS27111	KIA	495011D200				280
GDS27114	KIA	495014D201				281
GDS27115	KIA	495004D201				281
GDS27116	KIA	495011Y000				283
GDS27117	KIA	495001Y000				283
GDS27132	KIA	4950007010				283
GDS27142	KIA	495001M010				282
GDS27143	KIA	495011M010				282
GDS27151	KIA	495014D001				281
GDS27152	KIA	495014D700				281,285
GDS27155	KIA	495001G011				284
GDS27156	KIA	495001G051				284
GDS27168	KIA	495012F110				282
GDS27169	KIA	495002F110				282
GDS27185	KIA	495001G150				284
GDS27186	KIA	495001G110				284
GDS27206	KIA	4950007160				283
GDS27207	KIA	4950007110				283
GDS28001	LADA	21082215011	301467	20815	17-0179	288,289,290
GDS28002	LADA	21082215010	301468	20816	17-0180	288,289,290
GDS28003	LADA	21102215011				290
GDS28004	LADA	21102215010				290
GDS28005	LADA	21212215011/212122150111L				289
GDS28006	LADA	21212215010/212122150111R				289
GDS28007	LADA					289
GDS28008	LADA					289
GDS28011	LADA					289



G-AP Ref.	MAKE	ADAPTABLE TO OE	GKN	SPIDAN	METELLI	PAGE
GDS28012	LADA					289
GDS30002	LAND ROVER					296,297,300
GDS30003	LAND ROVER					297,298
GDS30004	LAND ROVER					297,298
GDS30005	LAND ROVER					297,298
GDS32006	SUZUKI					594
GDS32008	SUZUKI	44102M79F70				594
GDS34011	FORD					220
GDS34012	FORD/MAZDA					232,314
GDS34019	FORD/MAZDA	MD0925500A				197,231,314,315
GDS34039	MAZDA	GD402560XA				307,308,309
GDS34044	MAZDA		303786	23891		303,305
GDS34046	MAZDA					319,320
GDS34055	MAZDA					319
GDS34067	MAZDA					320
GDS34068	MAZDA					319
GDS34076	FORD/MAZDA					197,220,303
GDS34077	FORD/MAZDA					197,220,303
GDS34078	MAZDA					303
GDS34079	MAZDA					303
GDS34080	FORD					220
GDS34087	FORD/MAZDA					220,321
GDS34088	MAZDA					306,307,308,309
GDS34091	MAZDA					306
GDS34096	FORD/MAZDA					220,321
GDS34101	MAZDA	FG0225500C				302
GDS34120	MAZDA					307,308,309
GDS34132	FORD/MAZDA	2M343B437AA				231,314
GDS34133	FORD/MAZDA					231,314
GDS34137	MAZDA					306,307,308
GDS34153	MAZDA					307,308,309
GDS34163	FORD	1364028/1454211/1475130/1528656/1686115/ 5M513B436SA/5M513B436SB 5M513B436SD/5M513B436SE/5M513B436SC	305112	24853		196,206,209,210
GDS34165	MAZDA					307,308,309
GDS34166	KIA					281,285
GDS34167	KIA					283
GDS34168	KIA					283
GDS34169	KIA	4959107091				283
GDS34171	KIA					284
GDS34195	MAZDA					303
GDS34196	FORD/MAZDA					220,321
GDS34210	KIA					285
GDS34211	MAZDA					319
GDS34212	MAZDA					319
GDS34222	RENAULT					500
GDS34223	RENAULT					500
GDS34224	VOLVO					748
GDS34225	MAZDA					306
GDS34226	MAZDA					306
GDS35001	MERCEDES BENZ	1243502910/1243508810/A1243508810	300690	22695	17-0676	329,330,332
GDS35002	MERCEDES BENZ	6383340534/6383340634/6383341634/ 6383341734/A6383340634/A6383341734	302843	20163	17-0173	333,334
GDS35003	MERCEDES BENZ	6383342334/A6383342334	303152	21011	17-0185	333,334
GDS35004	MERCEDES BENZ	1073500410/1073502710/1073502810/ 1073503310/1073504310/1233500410	300745	22702	17-0092	329,330,332
GDS35005	MERCEDES BENZ	1243503010/1293504010	300749	22697		329,330,332
GDS35006	MERCEDES BENZ	2013501810/A2013508010	300689	22704	17-0215	321
GDS35007	MERCEDES BENZ	2023505610/A2023505610	303355	21192	17-0268	326,332
GDS35008	MERCEDES BENZ	2103508210	303356	21193		329
GDS35009	MERCEDES BENZ	2103508410	303357	21194		329
GDS35010	MERCEDES BENZ	6313300236/6313300335/6313300501/ 6313300701/6313301301/6313370010	302865	22716	17-0093	321
GDS35011	MERCEDES BENZ				17-0377	333,334
GDS35014	MERCEDES BENZ					331
GDS35016	MERCEDES BENZ				17-0376	333,334
GDS35022	MERCEDES BENZ	6393500710/6393501510/ A6393500710/A6393501510	304515	24168		333,334,335
GDS35025	MERCEDES BENZ					322,323,324,325,326
GDS35027	MERCEDES BENZ	A1633300401/A1633300101				330,331
GDS35029	JAGUAR					275,278
GDS35030	JAGUAR					275,278
GDS35031	MERCEDES BENZ					329

G-AP Ref.	MAKE	ADAPTABLE TO OE	GKN	SPIDAN	METELLI	PAGE
GDS35032	MERCEDES BENZ					322,323
GDS35037	MERCEDES BENZ	1683603172/1683702172/ A1683603172/A1683702172	304378/305034	24762/23796	17-0466	322
GDS35038	MERCEDES BENZ	1683601972/1683603372/	304379		17-0467/17-0989	322
GDS35039	MERCEDES BENZ					322,323,324,325
GDS35040	JEEP			28081		279
GDS35045	MERCEDES BENZ					322,323,324,325
GDS35047	MERCEDES BENZ					322
GDS35049	MERCEDES BENZ					325,326
GDS35052	SMART					585,586
GDS35053	SMART					585,586
GDS35054	MERCEDES BENZ	1693701572/1693702772/ 1693705572/1693706372	305553	25330		322,323,324,325,326
GDS35055	MERCEDES BENZ	1693701272/1693702872/1693704672/ 1693704772/1693704872/1693705672/ 1693706472/1693760242	305792	25599		322,323,324,325,326
GDS35057	MERCEDES BENZ					324,325
GDS35062	MERCEDES BENZ	1693603272				324,325,326
GDS35063	MERCEDES BENZ					332
GDS35075	MERCEDES BENZ					322,323
GDS35081	MERCEDES BENZ					323,324
GDS35082	MERCEDES BENZ					324,325,326
GDS35084	MERCEDES BENZ	6393300301/6393300701	304806	24533		333,335
GDS35086	PORSCHE/VOLKSWAGEN	95533202411/7L0501201A/7L0501201C	304544			483,484,723
GDS35087	VOLKSWAGEN	7L6501817C/7L6501817E/7L6501201A/ 7L6501201C/7L6501201E/7L6501817A	304549			722
GDS38001	MINI	31601503307/31607514477/ 31607514479/31607574852	304218	23284		337,338
GDS38002	MINI	31601503306/31607514478/ 31607514480/31607574850	304219	23285		337,338
GDS38003	MINI	31607518238	304213		17-0945	337
GDS38005	MINI					337
GDS39001	FORD/MAZDA					232,314
GDS39006	MITSUBISHI	MR276870/MR276874				342,347
GDS39007	MITSUBISHI	MR276871				347
GDS39023	MITSUBISHI					350
GDS39024	MITSUBISHI					350
GDS39034	MITSUBISHI					347
GDS39096	VOLVO					742,748,749
GDS39097	VOLVO					742,748,749
GDS39104	MITSUBISHI	3815A309				348
GDS39105	MITSUBISHI	3815A310				348
GDS39118	MITSUBISHI	MN156273				345
GDS39119	MITSUBISHI	MN156274				345
GDS39122	HYUNDAI	4950025955				262
GDS39123	HYUNDAI	4950125955				262
GDS39139	MITSUBISHI					354
GDS39147	MITSUBISHI					347,348
GDS39148	MITSUBISHI					347,348
GDS39163	MITSUBISHI	3815A307/3815A309				347,348
GDS39164	MITSUBISHI	3815A308/3815A310				347,348
GDS39182	CHEVROLET					94
GDS39183	CHEVROLET					94
GDS39189	HYUNDAI	495001J400				267
GDS39190	HYUNDAI	495001J450				267
GDS39191	HYUNDAI	495000X100				267
GDS39192	HYUNDAI	495000X110				267
GDS39202	MITSUBISHI					353
GDS39210	KIA					286
GDS39211	HYUNDAI	4950025300				261,275
GDS39212	HYUNDAI	4950025510				261,275
GDS39213	HYUNDAI	4950025500				261,275
GDS39214	HYUNDAI	4950025310				261,275
GDS39216	MITSUBISHI					348
GDS39217	MITSUBISHI					348
GDS39224	MITSUBISHI					354
GDS39228	MITSUBISHI					348
GDS39236	MITSUBISHI					353
GDS39237	HYUNDAI/KIA					268,288
GDS39247	HYUNDAI/KIA	495002B360				271,272,286
GDS39249	HYUNDAI					270
GDS39261	MITSUBISHI					353
GDS39262	HYUNDAI					270

G-AP Ref.	MAKE	ADAPTABLE TO OE	GKN	SPIDAN	METELLI	PAGE
GDS39263	KIA					282,284
GDS41001	NISSAN	3910173J20	301376	24415	17-0619	370
GDS41002	NISSAN	391002F210				374
GDS41003	NISSAN	391012F011/391012F001			17-0782	374
GDS41004	NISSAN	3910073J00	301375	24410	17-0618	370
GDS41005	NISSAN	3910073J20	301377	24414	17-0620	370
GDS41006	FIAT	46307998			17-0633	157,158,159
GDS41007	FIAT	46307999/46308347/46307988			17-0634	158,159
GDS41020	NISSAN					372,374
GDS41021	NISSAN					372,374
GDS41023	NISSAN					365
GDS41024	NISSAN	3910071J10	301394	24426	17-0719	370,371,374
GDS41025	NISSAN	391012F210				374
GDS41055	NISSAN					381,382
GDS41081	NISSAN					372,375
GDS41083	NISSAN	391014F100			17-0550	365
GDS41084	NISSAN	391004F100			17-0551	365
GDS41094	NISSAN	3910173J05/3910170N00	301374	24411	17-0617	370
GDS41127	NISSAN	391018H710				383,384
GDS41130	NISSAN	3910072J20	301378	24416		370,371
GDS41153	NISSAN					370
GDS41154	NISSAN					365
GDS41156	NISSAN	391014F401			17-0548	365
GDS41179	NISSAN	39100VB001				368
GDS41193	NISSAN				17-0549	365
GDS41194	NISSAN					357
GDS41195	NISSAN					357
GDS41197	NISSAN					383
GDS41198	NISSAN					383
GDS41199	NISSAN					383
GDS41200	NISSAN					364,365,366,367
GDS41201	NISSAN				17-0783	374
GDS41204	NISSAN					364,365,366,367
GDS41205	NISSAN					371,372,374
GDS41206	NISSAN					372,375
GDS41213	NISSAN					371,374
GDS41214	NISSAN					372,373
GDS41215	NISSAN					372,373
GDS41221	NISSAN	39101VB001				368
GDS41244	NISSAN					372
GDS41245	NISSAN					365,366,367
GDS41260	NISSAN					364,365,366
GDS41261	NISSAN					364,365,366,367
GDS41262	NISSAN	39100EB300	304889	24618		366,368
GDS41269	NISSAN					356
GDS41270	NISSAN					356
GDS41271	NISSAN					372
GDS41280	NISSAN	3910170J10			17-0718	370,371,374
GDS41286	NISSAN					377
GDS41296	NISSAN	391018J065				357
GDS41297	NISSAN	391008J065				357
GDS41299	NISSAN	39100JD72B				377
GDS41301	NISSAN					376
GDS41327	NISSAN	39100BM580	305330	25107		356
GDS41328	NISSAN	39101BM580	305329	25106		356
GDS41329	NISSAN	39101JD52B				376
GDS41337	NISSAN					366
GDS41365	NISSAN/RENAULT	39101JY04A	305168	24919		377,506
GDS41366	NISSAN					361
GDS41385	NISSAN					356
GDS41386	NISSAN					356
GDS41392	NISSAN					372,373
GDS41407	NISSAN	39101BC600/39101BH00A	305000	24728		365,366,367
GDS41408	NISSAN	39100BC600/39100BH00A	305002	24730		365,366,367
GDS41409	NISSAN	391019U005	304998	24726		367
GDS41428	NISSAN					362
GDS41437	NISSAN	391011HC3B				366,367
GDS41441	NISSAN/RENAULT					377,506
GDS41451	NISSAN	391011U600/39101BC500/39101BC55A	304995			364,366,367
GDS41452	NISSAN	391009U20A	305001	24729		367
GDS41453	NISSAN	391019U20A	305012	24740		367
GDS41463	NISSAN	39100BC500/39100BC55A/391001U600	304996/304997	24724/24725		364,366
GDS41464	NISSAN	391000F000/391007F002/5458020	304797	24524		381,382
GDS41466	NISSAN					367



G-AP Ref.	MAKE	ADAPTABLE TO OE	GKN	SPIDAN	METELLI	PAGE
GDS41475	NISSAN/RENAULT	391003113R/391009742R/ 39100JD74A/39100JY04A	305165			377,506
GDS44001	VAUXHALL	374222/374366/26029828/26032412/93192081	302385	21471	17-0279	646
GDS44002	OPEL/VAUXHALL	374178/374211/90350865/90444327/ 374513/93299251/90540520	301505/305224	24975/21407	17-0275	387,388,389,390,420, 422,631,639,642,643
GDS44003	OPEL/RENAULT/VAUXHALL	4409210/4414517/91166708/91168795/ 93852699/93856470/8200069147/8200179212/ 8200334338/8200485589	303495	21962	17-0196	429,430,535,536,660
GDS44004	RENAULT/VAUXHALL	7700102980/7700102999/7711135277/ 8200052426/8200169281	303219	21052	17-0408/17-0428	514,515,516,652
GDS44005	OPEL/RENAULT/VAUXHALL	7700102978/7700102998/7711135279/ 8200052428/8200178618/8200485576	303218	21051	17-0407/17- 0411/	417,514,515,516 ,652,653
GDS44006	OPEL/RENAULT/VAUXHALL	7700850487/7701351607/7701351608/ 7701352288/7701465773/7701468452	301885	22077	17-0076	386,534,535,628
GDS44007	OPEL					404
GDS44008	OPEL					404
GDS44009	GM					242
GDS44011	OPEL/VAUXHALL	374183/374235/90350824/90350908/ 90511247/90511255/90540865	301709	21433	17-0273	387,388,389,401,420, 421,422,423,632,633, 640,642,643,644
GDS44012	OPEL/RENAULT/VAUXHALL	8200178625	303503	21549		417,418,515,652,653
GDS44013	OPEL/RENAULT/VAUXHALL	4409208/4414516/91166707/91168794/ 8200069146/8200169291	303496	21963	17-0378	429,430,535,536,660
GDS44014	OPEL/VAUXHALL	374145/9117957/90348324	301706	21408		401,420,421,422,423,6 40
GDS44016	VAUXHALL	7701473014/8200026912/8200169277	303502	21060		652,653
GDS44017	OPEL/RENAULT/VAUXHALL	7701473013/8200052423/8200169272	303500	21058		417,515,652,653
GDS44018	CHEVROLET					93
GDS44019	CHEVROLET					93
GDS44020	FIAT/OPEL/VAUXHALL	73503003/24451255/374473	304906	24635		156,418,425,426,427, 428,654,657,658,659
GDS44021	OPEL/RENAULT/VAUXHALL	8200169286	303514	21284		417,515,652,653
GDS44022	OPEL/RENAULT/VAUXHALL	7711135532/8200169273	303498	21056		417,515,652,653
GDS44024	OPEL/VAUXHALL					394,395,396,397,398, 636,637,640
GDS44025	OPEL/VAUXHALL					390,391,392,431,634, 635,660,661
GDS44026	OPEL/VAUXHALL	374468/26095017/374443/0374468	304405	24057	17-0770	401,402,403,404,405, 406,407,420,645,646
GDS44027	OPEL/VAUXHALL	374466/26094867/374442/0374466	304404	24056	17-0769	401,402,403,404,405 ,406,420,645,646
GDS44028	OPEL/VAUXHALL	374545/13136379	304426	24079	17-0852	394,395,396,397,432, 635,636,637,661
GDS44029	OPEL/VAUXHALL	13124675/374543	304424	24077	17-0913	394,395,397,398, 636,637
GDS44030	OPEL/VAUXHALL	374548/24462241	304427	24080	17-0853	394,395,396,397,432, 635,636,637,661
GDS44031	OPEL/VAUXHALL	13124676/374544/0374544	304425	24078	17-0891	394,395,397,398, 636,638
GDS44032	OPEL/VAUXHALL	13101629/374523	305219	24970		402,403,406,416, 645,647,651
GDS44033	OPEL/VAUXHALL	374322/9117408/13243461/90538603	304415	24068	17-0555	390,391,392,393,633
GDS44034	CHEVROLET/GM					95,242
GDS44035	CHEVROLET/GM					95,242
GDS44036	OPEL/VAUXHALL	374317/90576706	303553	21583	17-0723	404,646
GDS44037	OPEL/VAUXHALL	374318/90576707/0374318	303554	21584	17-0724	404,646
GDS44038	OPEL/VAUXHALL	374261/374282/90498637/ 90511447/0374261	304410	24062	17-0348	423,424,425,655
GDS44039	OPEL/VAUXHALL	374103/374249/90496976	304411	24063	17-0349	423,424,425,655
GDS44040	OPEL/VAUXHALL	13150502/374792	305055	24783	17-1019	407,408,648,649
GDS44041	GM					242,243

G-AP Ref.	MAKE	ADAPTABLE TO OE	GKN	SPIDAN	METELLI	PAGE
GDS44042	OPEL/VAUXHALL	374793/13150503	305056	24784	17-1020	407,408,648,649
GDS44043	OPEL/VAUXHALL					385,627
GDS44044	OPEL/VAUXHALL	374323/9117409/90538604/0374323	304420	24073	17-0350	390,391,392,393,431,634,635,661
GDS44045	OPEL/VAUXHALL		304400	24052		401,402,403,404,405,406,420,645,646,648
GDS44048	OPEL/VAUXHALL				17-0272	388,632
GDS44049	OPEL	374259				404
GDS44050	OPEL	374260				404
GDS44051	OPEL/VAUXHALL	374600/13189073	305204	24955		394,395,396,398,432,636,637,640,662
GDS44052	OPEL/VAUXHALL	374549/24462244	305205	24956		394,395,397,398,635,636,637,638,640
GDS44059	OPEL/VAUXHALL	374184/374236/374275/374278/374748/ 90350907/90511248/90540536/90540911	301708	21434	17-0274	387,388,389,401,420,421,422,423,632,633,640,642,643,644
GDS44064	OPEL/VAUXHALL	13250860				394,399,400,629,638,639
GDS44065	OPEL/VAUXHALL	13250861				399,400,638,639
GDS44068	VOLVO					754
GDS44069	CHEVROLET					92,93
GDS44070	CHEVROLET					92,93
GDS44071	CHEVROLET/DAEWOO	96963323				94,142
GDS44072	CHEVROLET/DAEWOO	96963324				94,142
GDS44075	OPEL/VAUXHALL	374370/0374370/26076882/374372/ 374800/93190106	304401/304399	24000/24053	17-0766	401,402,403,405,406,420,644,645,646,647,648,649,655
GDS44076	OPEL/VAUXHALL				17-0775	423,424,425,655
GDS44077	OPEL/VAUXHALL	90512387			17-0720	423,424,425,655
GDS44078	OPEL/VAUXHALL	13248652/374825/13149829/374788	305051/305059/ 305060	24787/24788/ 24779		385,407,408,627,647,648,649
GDS44079	OPEL/VAUXHALL	13149830/26119530/374633/ 374789/13248675	305052/305058	24786/24780		385,407,408,627,647,648,649
GDS44080	OPEL/SAAB/VAUXHALL	13166591/374593	304875	24604		419,426,428,541,654,657,658,659
GDS44082	OPEL/VAUXHALL					390,391,392,431,634,635,660,661
GDS44088	OPEL/VAUXHALL					416,652
GDS44092	OPEL/VAUXHALL	13159533/374526	305218	24969		402,403,406,645
GDS44093	OPEL/VAUXHALL	13159534/374525	305222	24973		416,651
GDS44094	OPEL	13116174/374524	305223	24974		416
GDS44095	OPEL/VAUXHALL	26076883/374373/374801/93190108	304398	23999		405,406,646,648
GDS44096	OPEL/VAUXHALL	26076882/374372/374800/93190106	304399	24000		405,646,648
GDS45001	PEUGEOT	327384/327385/327388/32735E	301802	21637/21635	17-0018	435
GDS45002	PEUGEOT	3273Y7/3273Y9	302923	21692	17-0286	456,457,458,459,460
GDS45003	PEUGEOT	327329	301799	21631		453
GDS45004	PEUGEOT	327275/32724R/3272H8/3272T2	301834	21659	17-0062	444
GDS45005	PEUGEOT	327311/327312/95582416/95592320	301788	21613	17-0099	479
GDS45007	PEUGEOT	3272S3/3272S6	302926	21695	17-0288	457,458,459,460
GDS45008	PEUGEOT	3272F6/3272F8	301848	21671	17-0164	443,444
GDS45009	PEUGEOT	9630768280/3272AP/3272Y0/3272Y1	303208	21045	17-0389	437
GDS45010	PEUGEOT	9630768080/32730N/32730P/3273AQ	303209	21046	17-0390	437
GDS45011	PEUGEOT	3273AL/3273AN	303207	21044	17-0563	438
GDS45012	PEUGEOT	3272AE/3272AF	303206	21043	17-0562	438
GDS45013	PEUGEOT	327221/327348/327349	301795	21627	17-0025	453
GDS45014	PEUGEOT	3273G3/3273Q1/3273Z5	301835	21662	17-0069	442,443,444
GDS45015	PEUGEOT	327215/327216/327219/32723K	301801	21638/21636	17-0017	435
GDS45016	PEUGEOT	32730Y/32730Z	303217	21050	17-0394	437,438
GDS45017	PEUGEOT	3273E6/3273E9/3272L2/3272L3/32731H/ 32731J/3273C5/3273K6/3273L1	302427	21684	17-0167/17-0565	443,444
GDS45018	PEUGEOT					445
GDS45020	PEUGEOT	32736T/32736V	303489	21956	17-0734	456,457,458,459,460
GDS45021	PEUGEOT	327277/3272H7/3272T3	301836	21661	17-0068	442,443,444
GDS45022	PEUGEOT	327379/327381/3273N2	301510	21641	17-0059	454,455,456
GDS45023	PEUGEOT	327210/327211/327212	301509	21642	17-0058	454,455,456
GDS45024	PEUGEOT	3272E1/327261/32720F/32720G	302428	21683	17-0166/17-0564	443,444
GDS45025	PEUGEOT	3273G1/3273Q2	301833	21660	17-0063	444
GDS45026	PEUGEOT	32721P/32722P	303490	21957	17-0735	457,458,459,460
GDS45027	PEUGEOT	32723C/32723L/32724C	303202	21039	17-0381	437

G-AP Ref.	MAKE	ADAPTABLE TO OE	GKN	SPIDAN	METELLI	PAGE
GDS45029	PEUGEOT	327327/327357/327358/327373/327391/ 3273H9/3273J5	301798	21628	17-0028	453
GDS45030	PEUGEOT	327204/327222/327291/327330/327354	301797	21629	17-0027	453
GDS45031	PEUGEOT	32728E/32729E	303204	21041	17-0383	436,437,438
GDS45032	PEUGEOT	9630767880/32725C/32726C	303205	21042	17-0385	437
GDS45033	PEUGEOT	327244/327245/3272T4	301832	21656	17-0100	453
GDS45034	PEUGEOT	3273C3/3273C4/3273Z6	301831	21655	17-0101	453
GDS45035	PEUGEOT	9630767280/32733L/32733M	303203	21040	17-0382	437
GDS45036	PEUGEOT	327351/327352/327390	301796	21626	17-0026	453
GDS45041	PEUGEOT					445
GDS45043	CITROEN					136
GDS45044	PEUGEOT					459
GDS45048	PEUGEOT					445
GDS45063	PEUGEOT					454
GDS45064	PEUGEOT	9630768280/3272AP/3272Y0/3272Y1				436
GDS45065	PEUGEOT	32730N/32730P/3273AQ				436
GDS45066	CITROEN/PEUGEOT	327355/327364	301789	21618	17-0627	132,433,435
GDS45068	CITROEN/PEUGEOT	327366/327367/32724K/32725K	301922	21617	17-0626	132,433,435
GDS45069	PEUGEOT					454
GDS45070	PEUGEOT	327378/3273L4/3273L7/3273P7	301841/301847	21670/21672	17-0165/17-0557	443,444
GDS45071	PEUGEOT					433
GDS45072	PEUGEOT					433
GDS45073	PEUGEOT					442
GDS45074	PEUGEOT					442
GDS45075	PEUGEOT					442
GDS45079	PEUGEOT	3273N25A				454
GDS45080	PEUGEOT	3272F5SA				454
GDS45084	DACIA	6001547028/6001548102/7711497474/ 7711497477/8200272322/8200444438/ 391018299R	304507/304508	24160/24161	17-0637	140,141
GDS45085	DACIA	6001547029/6001548103/7711497475/ 7711497478/8200318010/8200484373/ 8200484376/391004298R	304509/304510	24162/24163	17-0638	140,141
GDS45092	PEUGEOT					442
GDS45093	PEUGEOT					463
GDS45094	PEUGEOT	9630766880/32733X/32733Y/3273CQ	303200	21037	17-0380	436,437
GDS45101	PEUGEOT	3272YE/3272Z0	303216	21049	17-0393	438
GDS45103	CITROEN	9639508780/3273EX/3273EY	303470	22118	17-0707	106,107,108,109
GDS45104	CITROEN/PEUGEOT	9637117880/3273AC/3273AE/3273LP	303571	21730	17-0731	101,109,110,111,112, 113,445,446,447,448, 479,480
GDS45105	CITROEN/PEUGEOT	9637117780/32721X/32722X/3272LW	303572	21731	17-0732	101,109,110,111,112, 113,445,446,447,448, 479
GDS45106	PEUGEOT	3272S7/3272S8	303491	21958		458,459,460
GDS45108	PEUGEOT	32736Y/32736Z	303494	21961	17-0737	457,458,459,460,461
GDS45111	PEUGEOT	327492	301786/301785	21611	17-0098/17-0016	433,435
GDS45113	CITROEN/PEUGEOT	9636786880/3273AH/3273AJ/3273QV	303575	21734	17-0729	109,111,445,446,447, 448
GDS45115	PEUGEOT					436
GDS45116	PEUGEOT					461
GDS45117	PEUGEOT					445
GDS45119	CITROEN/PEUGEOT	32725X/32726X/9636786780	303574	21733	17-0728	109,111,445,446,447, 448
GDS45120	CITROEN/FIAT/LANCIA	1481451080/32733Q/32735Z	303682	22872	17-0957	119,185,187,193,296
GDS45126	CITROEN/PEUGEOT	32728W/32729W/3272LV	303570	21729	17-0730	109,111,445,446,447, 448
GDS45133	CITROEN/FIAT/PEUGEOT					116,117,118,185,186, 461,462,476,477
GDS45134	PEUGEOT	327201/327202/327293	301829	21665	17-0021	433,434,435,436
GDS45135	PEUGEOT	3272S6	302924	21693	17-0287	457,458,459,460
GDS45136	PEUGEOT	3273Y9	302925	21690/21694	17-0284	461
GDS45137	PEUGEOT	32734Y/32734Z	303215	21048	17-0561	438,444
GDS45138	PEUGEOT	3272AA/3272AC	303214	21047	17-0560	438,444
GDS45140	CITROEN					113,114,115
GDS45147	PEUGEOT	32734E/32734F				436,437
GDS45151	PEUGEOT	3272S2/3272S5	302922	21691		456,457,459



G-AP Ref.	MAKE	ADAPTABLE TO OE	GKN	SPIDAN	METELLI	PAGE
GDS45152	PEUGEOT	32728N/32729N	303488	21955	17-0733	456,457,459
GDS45153	PEUGEOT	3273L2	302429	21686	17-0726	456
GDS45155	PEUGEOT	327283/327284			17-0064	444
GDS45156	PEUGEOT	3273G9/3273H0/3273Q3			17-0065	444
GDS45157	PEUGEOT	32722H/32727C/3272K4/3272L4/3272W0	304791	24518	17-0066	443,455,456
GDS45158	PEUGEOT	327325/32733N/32734V/3273R8/3273R9	304792	24519	17-0067	443,444
GDS45159	PEUGEOT	3272S2/3272S5			17-0285	456,457,459
GDS45160	PEUGEOT	3272E2/327209/3272E7/3272F5/3272H3	301842	21669	17-0556	454,455
GDS45165	PEUGEOT					465
GDS45166	PEUGEOT					465
GDS45167	PEUGEOT		301838	21663		443,444
GDS45174	CITROEN/FIAT/PEUGEOT					122,129,171,172,467
GDS45175	CITROEN/FIAT/PEUGEOT	3272SS				122,129,171,467
GDS45176	CITROEN/FIAT/PEUGEOT					121,122,129,170,171,173,466,467
GDS45178	CITROEN	327301/3272T5/3273Z9			17-0702	133
GDS45179	CITROEN	3273Z7/3273Z8			17-0703	133
GDS45188	PEUGEOT					479
GDS45189	PEUGEOT					479
GDS45193	PEUGEOT	3273KW/3273KX	304593	24277		439
GDS45194	PEUGEOT	3272LJ/3272LK	304592	24276		439
GDS45198	PEUGEOT	3273P7	301837	21664		443,444
GDS45200	PEUGEOT	3272LA/3272LC	304590	24274		438,439,440
GDS45201	PEUGEOT	3273KP/3273KQ	304591	24275		438,439,440
GDS45202	PEUGEOT	3272LL/3272LN	304594	24278		433,439
GDS45203	PEUGEOT	3272KZ/3272KY	304588	24272		439
GDS45204	PEUGEOT	3273KN/3273KL	304589	24273		439
GDS48001	PORSCHE	91133202414	300758	21894		483
GDS48002	PORSCHE	98633202450	302946	20193		483
GDS48003	PORSCHE	92333203302	300672	21808		483
GDS49005	PROTON					484
GDS49006	PROTON					484
GDS50001	RENAULT	7701349880/7701351484/7701351486/ 7701351572/7711106227	301878	22069	17-0074	484,485,487,488
GDS50002	RENAULT	7701349874/7701349972/7701351479/ 7701351480/7701351571/7711106228	301879	22068		484,485,487,488
GDS50003	RENAULT	7701463343/7701499223	301873	22055	17-0111	514
GDS50004	RENAULT	7700103731/7700106007/7700110484/ 7700111259/7700111506/7700115011/ 7701056621/7711135246/8200410080	303233	21066	17-0397	494,495,496
GDS50005	RENAULT	7701348098/7701498698	301849	22006	17-0040	491,529
GDS50006	RENAULT	7701349769/7701351172/7701498955	301859	22028	17-0051	533,534
GDS50007	RENAULT	7701349839/7701349921/7701351264/ 7701352025	301883	22074	17-0050	488,489,490
GDS50008	RENAULT	7701349955/7701351995	302888	23338	17-0311	529
GDS50009	RENAULT	7701352471/7701352595/7701469374/ 7711135233	303064	20960	17-0115/17-0599	517,518,519,520,529
GDS50010	OPEL/RENAULT/VAUXHALL	9109186/7700102979/7711135278	303220	21053	17-0405/17-0409 17-0425	417,514,515,516, 652,653
GDS50011	RENAULT/VAUXHALL	7700102981/7711135280	303221	21054	17-0406/17-0426	514,515,516,652
GDS50012	RENAULT	7701349172/7701349660/7701463194/ 7701498957/8200323961	301861	22033	17-0042	484,491
GDS50013	RENAULT	711106122/7701349359/7701498958/ 7711106122	301862	22031	17-0041	484,491
GDS50014	RENAULT	711106222/7701349914/7701351697	301890	22083		492
GDS50015	RENAULT	711106221/7701349915/7701351701/ 7701351801/7711106221	301891	22088	17-0033	492
GDS50016	RENAULT	711106129/7701348152/7701348160/ 7701348256/7701498797/7701498799	301893	22018	17-0046	484
GDS50017	RENAULT	7700110482/7701352774/7701352776/ 7701470721	303234	21067	17-0398	494,495,496
GDS50018	RENAULT					506
GDS50019	RENAULT	7701352631/7701470175	303461	21570	17-0314	499
GDS50020	RENAULT	7701349915/7701351699/7701352223	301887	22084		492,493
GDS50022	RENAULT	7701349916/7701351695/7701352224	301886	22082	17-0032/17- 0034/	492,493

G-AP Ref.	MAKE	ADAPTABLE TO OE	GKN	SPIDAN	METELLI	PAGE
GDS50023	RENAULT	7701349726/7701349847/7701351160/ 7711106217	301865	22043	17-0037	532,533
GDS50024	RENAULT	711106218/7700109021/7701349741/ 7701349803/7701349945/7701351194/ 7701351290/8200323960/7700272531	301870	22046	17-0038/17-0109	500,532,533
GDS50025	RENAULT	7701349727/7701349848/7701351162/ 7711106216	301866	22042	17-0036	532,533
GDS50026	RENAULT	7701349994/7701352133	302908	22137	17-0299	507,508,509
GDS50028	RENAULT	7701352414	303078	20974	17-0317	517,518,519,530
GDS50029	RENAULT	7701352415/7701352417/7701352730	303066	20962	17-0315	517,518,519,530
GDS50030	RENAULT	7701349026/7701351428/7701498918	301858	22026	17-0108	488,490,498
GDS50031	RENAULT	7701351841/7701352021	302435	22131	17-0628	490,498
GDS50032	RENAULT	7701349740/7701351193	301869	22047	17-0110	532,533
GDS50033	RENAULT	711106260/7701349785/7701351266	301876	22064	17-0054	488,489
GDS50034	RENAULT	7701352386/7701354993/7701468887/ 7711130045	302906	22135	17-0301	507,508,509
GDS50035	RENAULT	7701349997/7701352385	302905	22134		507,508,509
GDS50036	RENAULT	7701349879/7701351483	301880	22071	17-0048	484,485,486,487,488
GDS50037	RENAULT	7701349691/7701349873/7701351478	301881	22070	17-0049	484,485,487,488
GDS50038	RENAULT	7700105484/7700105486/7700111077/ 7700111810/7700111812/7700111814/ 7700875246/8200168513	303455	21564	17-0600	517,518,519,520,529
GDS50039	RENAULT	7700111748/7700111918/7701352729/ 7701468842/7711135208	303615	22317	17-0595	519,520,530
GDS50041	RENAULT	7701349692/7701351127	301895	22067	17-0043	484,491
GDS50043	RENAULT	7701352750/7701470700/7701471377/ 7711130057/8200024622/8200029444	303550/303624	21721/22326	17-0414	507,508,509
GDS50044	RENAULT	711106219/7701349771/7701349804/ 7701349946/7701351192/7701351292/ 7701351363/8200323959/7701470304	301867	22045	17-0039	500,532,533
GDS50045	RENAULT	7700111364/7701352881			17-0403	493
GDS50046	RENAULT	7701349998/7701352141/7701352870	302903	22132	17-0298	507,508,509
GDS50047	RENAULT	7701352427	302899	22126	17-0306	508,509
GDS50050	RENAULT	7701349913/7701349938/7701351806	301889	22085	17-0029	492
GDS50051	RENAULT				17-0402	493
GDS50052	RENAULT	7701349689/7701349734/7701349940/ 7701351124/7701352020/7701352024	301872	22050	17-0035	490,498
GDS50053	RENAULT				17-0302	507,508,509
GDS50055	RENAULT	7700873311/7701352596	303076	20972	17-0117/17-0597	517,518,519,520,529
GDS50057	RENAULT	820029984/8200164147/ 8200299844/8200477656	303507	21553		514,515,516
GDS50058	OPEL/RENAULT/VAUXHALL	7701473010/8200052420	303499	21057		417,514,515,652,653
GDS50059	RENAULT	8200164149/8200477655	303508	21554	17-1030	514,515,516
GDS50060	OPEL/RENAULT/VAUXHALL	8200169285	303515	21286		417,515,652,653
GDS50063	RENAULT				17-0169	495,496
GDS50066	NISSAN/OPEL/RENAULT/ VAUXHALL					361,417,418,514,515, 516,652,653
GDS50074	RENAULT	7701352619/7701469965	303073	20969	17-0572	529
GDS50075	RENAULT				17-0303	507,508
GDS50082	RENAULT	7700111365			17-0404	493
GDS50089	RENAULT					521,530
GDS50091	RENAULT					521,530
GDS50092	RENAULT					494,505,506
GDS50093	RENAULT	7701349994/7701352134/7711130027	302904	22133	17-0297	507,508,509
GDS50095	RENAULT	7701351989	301900	22090	17-0057	536
GDS50098	DACIA	6001544964				141
GDS50099	RENAULT	7701352489/7701469543	303071	20967	17-0570	529
GDS50100	RENAULT	7701352618/7701469962	303072	20968	17-0571	529
GDS50102	RENAULT	7700109334/7700112149/7701349980/ 7701352318/7701468548/8200231953	304365	23783		536
GDS50103	RENAULT					493,494
GDS50105	RENAULT	7701349959/7701351959/7701352001	302889	23339	17-0312	529
GDS50112	RENAULT					501,502
GDS50114	RENAULT					501,502
GDS50116	RENAULT					491,492
GDS50117	RENAULT					492
GDS50130	RENAULT	7700104460/7701352563/7701352744	303080	20976		508,509,527
GDS50131	RENAULT	7701352562	303068	20964		506,527

G-AP Ref.	MAKE	ADAPTABLE TO OE	GKN	SPIDAN	METELLI	PAGE
GDS50133	RENAULT					506
GDS50134	RENAULT	7701349998/7701352144/7711130028	302907	22136	17-0300	507,508,509
GDS50138	RENAULT	7701349786/7701351267/8200231949	301877	22063	17-0055	488,489,490
GDS50145	RENAULT	711106130/7700873326/7701348968/ 7701498923/7701498924/7711106130	301855		17-0047	484,500
GDS50146	NISSAN/RENAULT					362,494,495,496,497, 502,503,504,505
GDS50149	RENAULT					517
GDS50150	RENAULT	7700104727/7700108248/7700109333/ 7700110484/7701351990/7701352771/ 7711135243/8200231680	301899/303228	21061/22089	17-0056/17-0395	494,495,496,502,503, 504,505,536
GDS50151	RENAULT	7701352775/7701352777	303229	21062	17-0396	494,495,496
GDS50160	RENAULT	7700111916/7700115197/7711135207/ 7711135217/8200110754	303742	22928	17-0591	517,519,521,530
GDS50162	RENAULT	8200128122/7700111508/8200116063/ 8200142879/8200624049/8201236025/ 7700113258	305535	25312		493,494,502
GDS50164	RENAULT					506
GDS50165	RENAULT					484
GDS50166	OPEL/RENAULT/VAUXHALL	8200178624/8200485578/4401727	303505	21551	17-0861	417,418,515,652,653
GDS50169	ROVER					538,539
GDS50171	RENAULT	7701352190	302896	23366		529
GDS50172	SUBARU					593
GDS50173	RENAULT					517,518,519,520,521, 529,530
GDS50175	RENAULT				17-0310	529
GDS50177	NISSAN/RENAULT					362,494,495,496,497, 502,503,504,505
GDS50183	RENAULT					535
GDS50189	RENAULT					507,508,509
GDS50193	RENAULT	7711134959/8200114426	304303	23666	17-1036	496,503,505
GDS50194	RENAULT	7711134957/8200065334	304301	23664	17-1035	496,503,505
GDS50197	RENAULT	7700107765/7700110218/7700112315/ 7701352869/8200031134/8200031137	303549	21711	17-0413	507,508,509
GDS50199	RENAULT	7701352560/7701352561	303069	20965		527
GDS50200	RENAULT	7701352629/7701470173	303462	21571	17-0313	499
GDS50201	RENAULT	7700109022/7701349742/ 7701351195/7701465455	301868	22044		500,532,533
GDS50205	RENAULT	7701349939/7701351807	301888	22086	17-0030	492
GDS50207	RENAULT	7711134777/8200079913/8200470129/ 8200014352/8200243985/7711135536	303625/304849	24576/22327	17-0871	510,511,512
GDS50208	RENAULT	7711134779/8200014111	303629	22331	17-0863	510,511,512
GDS50209	RENAULT					506
GDS50211	RENAULT	7700872598/7701352630	303459	21568	17-0324	499
GDS50214	VAUXHALL	7711135531/8200169279	303501	21059		652,653
GDS50215	RENAULT	7701352142/7701352428	302898	22125	17-0308	508,509
GDS50216	RENAULT					506
GDS50219	RENAULT		303630			510,511,512
GDS50221	RENAULT	7700106291/7701352628/7711135267/ 8200031149	303460	21569	17-0323	499
GDS50223	RENAULT	7711135265	304969	24697		499
GDS50225	RENAULT	7700105450/7700114057				499
GDS50226	RENAULT	7711134780/8200035673	303631	22333	17-0864	510,511,512
GDS50227	RENAULT	7700112506/7711135196/8200032891	303636	22338		508,509
GDS50228	RENAULT	7711135321/8200079912/8200169176	303626	22328		510,511,512
GDS50233	RENAULT					506
GDS50241	RENAULT					493,494
GDS50245	RENAULT	8200236114/8200274161/8200571878	304800	24527		502,504
GDS50246	OPEL/RENAULT/VAUXHALL	7711135530/8200052421	303497	21055		417,514,515,652,653
GDS50247	RENAULT	7701352421	303079/303458	21567/20975	17-0318	517,518,519,520
GDS50249	OPEL/RENAULT/VAUXHALL	8200169289	303504	21550		417,418,515,652,653
GDS50250	NISSAN/RENAULT					362,494,495,496,497, 498,502,503,504,505
GDS50252	RENAULT		303081	20977		527
GDS50253	RENAULT	7700106263/7700112131/7700115818/ 7711135213/7711135223/8200088665/ 8200283723/8200283724/8200283725/ 8200283726/8200531861/8200531886	303612	22314		517,518,519,520, 521,530
GDS50254	RENAULT					530
GDS50255	RENAULT					522,523,525,526



G-AP Ref.	MAKE	ADAPTABLE TO OE	GKN	SPIDAN	METELLI	PAGE
GDS50256	RENAULT	8200079915/8200470131	304723	24451		511,513
GDS50257	RENAULT					511,512
GDS50260	RENAULT	8200236116/8200622835/8200626032	304972	24700	17-0866	496,503,505
GDS50261	RENAULT	7711135906/8200236109/8200236110/ 8200622834/391014440R	304805	24532	17-0865	496,503,504
GDS50263	RENAULT	8200240430/8200571880/391004165R	304973	24701	17-0787	494
GDS50268	RENAULT	7700112507/7700112511/8200032887/ 8200063808	303637	22339		508,509
GDS50269	RENAULT					506
GDS50271	RENAULT	7700100065/7700101680/ 7701352488/7701469542	303070	20966	17-0569	529
GDS50272	RENAULT	7700105447/7700114056/7701472850/ 7701472852/8200169307				499
GDS50279	RENAULT	8200255027	304862	24589		496
GDS50280	RENAULT	7711368677/7711497634/8200543868	305255	25012		495,496,533
GDS50281	RENAULT	8200014353/8200233728/8200531894/ 8200225099/7711134783/7711135354	303628			510,511,512
GDS50284	RENAULT	7711135236	304337	23699		521
GDS50293	RENAULT					491,492,501
GDS50295	RENAULT	7700108465/7701352907	303074	20970	17-0573	529
GDS50296	RENAULT	7701352622/7701469966	303075	20971	17-0574	529
GDS50303	RENAULT				17-0401	493
GDS50307	RENAULT				17-0587	536
GDS50308	RENAULT				17-0588	536
GDS50309	RENAULT				17-0589	507,508,509
GDS50311	RENAULT	7700112116/7711134941	303623	22325	17-0601	518,519,521,530
GDS50313	RENAULT	8200087857/7711135237	304343	23744	17-0593	517,519,521,530
GDS50314	RENAULT	7700111920/8200064731/7711368859	303616	22318	17-0594	517,519,520,530
GDS50316	RENAULT	7700105485/7700105487/7700111809/ 7700111811/7700111813/7700111820/ 7700873322/7700875247	303457	21566	17-0598	517,518,519,520, 521,529
GDS50319	RENAULT	7701352495	302901	22128		508,509
GDS50320	RENAULT	7700107509/7700111818/7700112114/ 7700113086	303456	21565		517,518,519,520,530
GDS50323	RENAULT	7700111313/7700112132/7711135215	303614	22316		521
GDS50324	RENAULT	7700112688/7700115005/7711135219	303617	22319	17-0739	530
GDS50325	RENAULT	7700111914/7700115196/7711135206/ 7711135216/8200173584	303620	22322	17-0592	519,520,530
GDS50326	RENAULT	7701352413/7701352416/7701352472/ 7701468836/7701468839/7711497525	303621	22323		520,521
GDS50327	RENAULT	7701468840/7701468843/7701469375	303622	22324		521
GDS50328	RENAULT	7711134785/8200014109	303632	22334		510,511
GDS50329	RENAULT	7711134786/8200030623	303633	22335		510,511
GDS50330	RENAULT	7711134776/8200014114/8200079916/ 8200387548	303634	22336		511,513
GDS50331	RENAULT	7700103863/7701352791	303641	22343		508,510
GDS50336	RENAULT	7700106018/7701471155/7711134738			17-0432	495,496
GDS50339	RENAULT		304465	24118		502,503,504,505
GDS50348	RENAULT	8200472158	304719	24447	17-0897	522,524,525,526,531
GDS50350	RENAULT					501,522,524,525, 526,531
GDS50351	RENAULT					522,523,524,525,526
GDS50353	DACIA/RENAULT	8200261840/8200440187/8200499585/ 8200511225/8200618501/711497150/ 8200559377	304733/305193	24944/24460	17-0904	140,141,493,497,498, 513,528
GDS50354	DACIA/RENAULT	6001548720/7711497417/8200261841/ 8200270510/8200358168/8200455157/ 8200460992/8200499586/8200618111	304710/304726	24398	17-0908	140,141,493,497,498, 513,528
GDS50356	RENAULT	7700106017	304467	24120		502,504
GDS50357	RENAULT	7700106009/7700106013/7700110483/ 7700111190/7700114453/7700115010/ 7701352882/7701471084/7701471284/ 8200105214	303231	21064		502,503,504,505

G-AP Ref.	MAKE	ADAPTABLE TO OE	GKN	SPIDAN	METELLI	PAGE
GDS50358	RENAULT	7700111079/8200090175	303613	22315		520,521
GDS50359	RENAULT	7700112147/7701352808/7701352809/ 7701468549/7701470183/7701470298/ 8200231949	304364	23782		536
GDS50363	RENAULT					493,494,502
GDS50364	RENAULT					495,496,497,503, 504,505
GDS50365	RENAULT					496,498
GDS50366	RENAULT	8200414937	304845	24572	17-1067	514,515,516
GDS50367	RENAULT					499
GDS50369	RENAULT	8200341698	304712	24400	17-1040	493,497,528
GDS50372	RENAULT	8200378880	304724	24452	17-1041	493,497,528
GDS50373	RENAULT	8200749390	305258	25015		495,496,533
GDS50377	RENAULT	8200676172/8200934677	304967	24696		506,513
GDS50378	RENAULT					506,513
GDS50379	RENAULT	7701210040/8200441337	305319	25096		493,497,498,528
GDS50380	RENAULT	8200618168	304910	24639		506,511,513
GDS50383	RENAULT	8200725499	305766	25573		500,526,527
GDS50384	RENAULT	8200890089				528
GDS50386	RENAULT					501,531
GDS50389	RENAULT	7700112689/7711135220	303619	22321	17-0740	530
GDS50390	RENAULT	7711135403/8200226056/ 8200228393/8200470133	304258	24324		499
GDS50391	RENAULT	7711135411/8200171562/8200387439/ 8200590972/8200259911/8200387424	304259/304857	24584/24325		499
GDS50392	RENAULT	7711135401/8200226057/8200467679	304260	23326		499
GDS50393	RENAULT	7711368091/8200133289/ 8200436849/8200439891	304261	23327		499
GDS50394	RENAULT		304300	23663		496,503,504
GDS50395	RENAULT		304302	23665		494,495,496,502, 503,504,505,533
GDS50397	RENAULT		304461	24114		495,496,533
GDS50398	RENAULT		304466	24119		502,504
GDS50399	RENAULT	8200216625	304565	24245		501,531
GDS50400	RENAULT	7711135414/8200198015/8200436366/ 8200790517/7711497286	304687/304802	24375/24529		501,522,523,524, 525,526,531
GDS50401	RENAULT	7700111259/7711135005/7711368656/ 8200236092/8200236107/8200240425/ 8200274159/8200534635/8200571876/ 8200613822	304689	24377	17-0786	494,502,504,536
GDS50402	RENAULT	8200330413	304716	24444	17-0905	522,524,525,526,531
GDS50403	RENAULT	8200375537/8200432516	304718	24446		501,531
GDS50404	RENAULT		304853	24580		519,520
GDS50405	RENAULT	8200511122/8200531917/8200432514	304860/304899	24587		521,522,524,525,526
GDS50410	RENAULT					498
GDS50411	NISSAN/RENAULT	7711368905	305195	24946		362,495,496,502,503, 504,505
GDS50415	DACIA	391015061R	305544			139
GDS50416	DACIA	8200930507/391008165R	305312/305545			139
GDS50421	VOLVO					742,743,748,749
GDS50423	RENAULT		305026	24754		503,504,505
GDS50425	RENAULT					501,526,527,532
GDS50426	RENAULT					500,501,526,527,532
GDS50429	RENAULT	391001702R/8200725513	305317	25094		501,532
GDS50437	RENAULT		304463	24116		495,496,497,533
GDS50438	RENAULT	7711135875/8200236089/7700102136	304690	24378		536
GDS50440	RENAULT	7711135775/8200167554/8200267041/ 8200613828	304338	23739		522,524,525,526
GDS50441	RENAULT	7711135425/8200197979/8200285909	304342	23743		523,525
GDS50442	RENAULT	7711368884/8200117068/8200216519/ 8200327707/8200376095/8200575490/ 8200626040	304777/304778	24504/24505	17-0909	501,524,525,526,531
GDS50443	RENAULT	6001550794/8200261838	304714	24442		493,498,528
GDS50444	RENAULT	8200383707	304852	24579		501,523,525,531
GDS50445	RENAULT	8200276640/8200416682	304569	24249		511,512
GDS50446	RENAULT	7711135307/8200014107/8200232886	304562	24242	17-1031	510,511

G-AP Ref.	MAKE	ADAPTABLE TO OE	GKN	SPIDAN	METELLI	PAGE
GDS50447	RENAULT	7701352552/7701352983/7711134419/ 8200197978/8200285908/8200436365/ 8200790519	304688	24376		523,525
GDS50453	RENAULT					501,523,525,531
GDS50454	RENAULT					499
GDS50460	RENAULT		304851	24578		511
GDS50461	RENAULT	7701349992/7701352129/7701468642	302911	22147	17-0307	508,509
GDS50462	RENAULT	8200626991	304464/304468	24117		496
GDS50465	FORD	8V413B436BD/1683585/1594943	305592	25369		219,220
GDS50466	FORD	8V413B437AC/1594946				219,220
GDS50467	RENAULT					498
GDS50468	RENAULT					498
GDS50469	RENAULT					511,513
GDS50470	SUZUKI					600
GDS50471	RENAULT	7711134775	304344			511,513
GDS50483	RENAULT		305194	24945		493,497,498,528
GDS50486	RENAULT					494,495,496,498, 503,505
GDS50487	RENAULT	391010115R				498
GDS50488	RENAULT	391000926R				498
GDS50489	RENAULT					498
GDS50490	RENAULT	391018662R				498
GDS50493	RENAULT	8200500684/8201235775	305478	25255		499
GDS50494	RENAULT	7711135777/8200117069/8200310122/ 8200376094/8200575489	304895	24624	17-0906	501,524,525,526,531
GDS50495	RENAULT	7711135316/8200351249/8200375538	304970	24698		501,531
GDS50496	RENAULT	8200659626/8201235787	304911	24640		506,511,513
GDS50497	OPEL/RENAULT	93856309/93861972/8200452272/ 8200776535/8201187931	304782	24509		429,430,535,536
GDS50498	DACIA	391011327R/391012991R/391015061R	305544	25321		139
GDS50502	RENAULT					494
GDS50504	RENAULT					496
GDS50505	RENAULT					496
GDS50506	RENAULT	8200144781/8200331639/8200045471	304005	21599	17-0918	503,505
GDS50509	RENAULT					510,511,512
GDS50510	RENAULT					501,517,526,527,532
GDS50514	RENAULT	7711368568/7711368569/8200407659/ 8200407660/8200467490/8200535798/ 8200535799	305186	24937	17-1038	502,503,504,505
GDS50515	RENAULT	8200535800	305187	24938	17-1039	502,503,504,505
GDS50516	RENAULT	8200379236/8200432515	304725	24453		522,524,526
GDS50517	RENAULT	7711368470/8200087860	304711	24399		530
GDS50518	RENAULT	8200363697	304717	24445		511,512,513
GDS50519	RENAULT	8200236112/8200531889/ 8200613823/8200621196	304721	24449		503,505,533
GDS50520	RENAULT	8200184199	304855	24582		523,525
GDS50523	RENAULT	8200072831	304961	24690		502
GDS50525	RENAULT	7711497282/8200236103/8200613818	305030	24758		503
GDS50526	RENAULT	7700111504/7711368650/8200231663/ 8200262685/8200844453	305031	24759		504
GDS50527	RENAULT	8200144764/8200144765/8200269195	304006/304004	21600/21598	17-0919	503,505
GDS50538	RENAULT	8200482436	305139	24880		537
GDS50539	RENAULT	8200661507	305140	24881		537
GDS50540	RENAULT	8200666595/8201236028	305575	25352		499
GDS50541	RENAULT	391005791R/8201272648	305029	24757		503,504,505
GDS50542	RENAULT		305136	24877		536,537
GDS50543	SEAT/SKODA/VOLKSWAGEN	1S0407762D/1S0407762DX				564,566,738
GDS50544	RENAULT		305135	24876		536
GDS50554	RENAULT	7711497234/8200278603	304715	24443		522,523
GDS50557	OPEL/RENAULT/VAUXHALL	4411699/4430546/93850891/93856471/ 7711135441/8200169164/8200485590	305656	25433		429,430,535,536, 659,660
GDS50562	OPEL/RENAULT/VAUXHALL	4411698/93850890/7711135440/8200169163	304713			429,430,535,536, 659,660
GDS50563	RENAULT					498
GDS50564	RENAULT					491
GDS50567	SEAT/SKODA/VOLKSWAGEN	1S0407761B/1S0407761BX				564,566,738
GDS50569	DACIA	8200930507/391008165R/371003840R				139
GDS50570	DACIA/RENAULT	6001551095/8200863653/8200863524/ 6001551096/6001550690/6001550691/ 8201187935	305362	25139		140,141,513
GDS51001	HONDA/ROVER		301423	20851	17-0331	254,537,538,539,541
GDS51002	LAND ROVER	TDB104020				297



G-AP Ref.	MAKE	ADAPTABLE TO OE	GKN	SPIDAN	METELLI	PAGE
GDS51003	LAND ROVER	TDB104030				297
GDS51004	ROVER		301574			538,539
GDS51006	ROVER					539
GDS51008	LAND ROVER					297,298,299
GDS51009	LAND ROVER	TDB000360				297
GDS51010	HONDA/ROVER		301424	20852	17-0332	254,537,538,539,541
GDS51011	ROVER					538,539
GDS51013	LAND ROVER					297,298
GDS51017	ROVER					541
GDS51018	MG/ROVER					336,538,541
GDS51019	MG/ROVER					336,538,541
GDS51020	ROVER					538,539,541
GDS51021	PLYMOUTH/ROVER		304456	24109		482,538
GDS51023	HONDA/ROVER		301425	20853		254,537,538,539,541
GDS51024	LAND ROVER					298
GDS51025	LAND ROVER					297,298
GDS51030	LAND ROVER					297,298
GDS51035	MG					336,337
GDS51036	LAND ROVER	TOB500330/IED000081/IED500040	305626	25403		299
GDS51037	LAND ROVER					297,298
GDS51038	LAND ROVER					297,298
GDS51041	JEEP					279
GDS51046	MITSUBISHI					352
GDS51047	CITROEN/PEUGEOT	3272PT				105,454
GDS51050	CITROEN/PEUGEOT	3273PY				105,454
GDS51068	ROVER	TDB104890	304518	24171		540
GDS52001	SAAB	5057708	302950	20196/20197		541,542
GDS52002	SAAB	5057682	302951	20198		541,542
GDS52006	SAAB					544
GDS53001	VOLKSWAGEN	191407271H/191407271HX/ 191407271K/191407271T	301715	22495	17-0339	668
GDS53002	VOLKSWAGEN	191407272AG/191407272BD/ 191407272CV/191407272CX/191407272F/ 191407274CX/191407274DX	301718	22437	17-0615	668
GDS53003	SEAT/VOLKSWAGEN	191407271A/191407271B/191407271C/ 191407271CX/191407271P/191407271Q/ 191407271R/191407271RV/191407449X/ 191497449X	301532/301537	22466	17-0002	559,668
GDS53004	SEAT/VOLKSWAGEN	191407271/191407271N/	301534/301548	22462/23542	17-0121	553,554,556,559,668
GDS53005	SEAT/VOLKSWAGEN	191407272A/191407272AE/191407272C/ 191407274BX/191407450X/191407272AC	301533/301538	22467	17-0003	559,668
GDS53006	SEAT					564
GDS53007	AUDI/SEAT/SKODA/ VOLKSWAGEN	1K0407271AP/1K0407451X	304755	24482	17-0881	31,548,550,560,565, 574,576,682,684,688, 690,692
GDS53008	VOLKSWAGEN	1K0407272DM			17-0882	682,684,688
GDS53010	SEAT/VOLKSWAGEN	8N0407272G/8N0407272P/8N0407452AX	304356	23774		560,677
GDS54001	SKODA	115420214/115421210/6U0407271A/ 6U0407271F/6U0407271FX	301470	23150	17-0119/17-0435	571
GDS54002	SKODA	115420217/6U0407272A/6U0407272AF/ 6U0407272F/6U0407272FX	301469	23151	17-0120/17-0436	571
GDS54003	SKODA					571
GDS54011	AUDI/SEAT/SKODA/ VOLKSWAGEN	1K0407272ER/1K0407272KG/1K0407272NK/ 1K0407272QE/1K0407272QF/1K0407272RG/ 1K0407272HR/1K0407272DQ/1K0407272EG/ 1K0407454X/1K0407272TQ/1K0407764PX/ 1K0407454HX	304751	24478	17-1086	25,26,27,28,29,30, 549,550,551,552,561, 562,565,566,575,577, 578,581,582,669,670, 671,672,683,684,685, 686,688,689,691,693, 695,696,701,703,704, 705,706,707,709,710, 711,718,725,726,727
GDS54013	AUDI/SEAT/SKODA/ VOLKSWAGEN	1K0407271BF/1K0407271KA/1K0407271KS/ 1K0407271LG/1K0407271LK/1K0407271BQ/ 1K0407451QX/1K0407271NT/1K0407761QX	304747	25308/24474		25,26,27,28,29,30,73, 75,549,550,551,552, 561,562,565,566,574, 575,577,578,581,582, 668,670,671,672,683, 684,685,686,688,689, 691,693,695,696,701, 703,704,705,706,707, 709,710,711,718,725, 726,727
GDS54014	SUZUKI					596

G-AP Ref.	MAKE	ADAPTABLE TO OE	GKN	SPIDAN	METELLI	PAGE
GDS56001	SUBARU					592
GDS56002	SUBARU					591
GDS56006	SUBARU					586,590,593
GDS56007	SUBARU					590
GDS56010	SUBARU					586
GDS56013	SUBARU					589,590,591,592,593
GDS56014	SUBARU					586
GDS56015	SUBARU					586
GDS56016	SUBARU	28321SA033				586,588,589
GDS56017	SUBARU					586,593
GDS56020	SUBARU					586,592
GDS56021	SUBARU					586,593
GDS56068	SUBARU					586
GDS57001	MARUTI					302
GDS57002	MARUTI					302
GDS57007	HOLDEN/SUZUKI					244,599
GDS57008	HOLDEN/SUZUKI					244,599
GDS57009	HOLDEN/SUZUKI					244,598
GDS57010	HOLDEN/SUZUKI					244,598
GDS57039	SUZUKI	4410180E00/4410180E01000	302840	20160		599
GDS57040	SUZUKI	4410280E00/4410280E01/ 4410280E0100/4410280E01000	302839	20159		599
GDS57066	SUZUKI					600
GDS57068	SUZUKI	4410276G60				600
GDS57074	MARUTI					302
GDS57075	MARUTI					302
GDS57077	SUZUKI	44101M72F12/44101M72F13	305110	24851		594
GDS57078	SUZUKI	44102M72F12/44102M72F13	305109	24850		594
GDS57086	SUZUKI					599
GDS57087	OPEL/VAUXHALL	9206563				385,627
GDS57119	SUZUKI					594
GDS57120	SUZUKI					594
GDS57121	SUZUKI					596
GDS57124	SUZUKI					593
GDS57128	SUZUKI	44102M79F75				593
GDS57145	HYUNDAI					267
GDS57165	LAND ROVER	6G9N4B402AA/6G9N4B402AB/LR001160/ LR014491/LR024525/LR025959/LR041309	305474	25251		297,298
GDS57166	SUZUKI	4410272K00				599
GDS57167	SUZUKI	4410172K00				599
GDS57168	SUZUKI	4410272K40				599
GDS57169	SUZUKI	4410172K20				599,600
GDS57175	OPEL/SUZUKI/VAUXHALL					385,598,627
GDS57176	CHEVROLET/DAEWOO					95,143
GDS57177	CHEVROLET/DAEWOO					95,143
GDS57179	CHEVROLET					96
GDS57197	OPEL/SUZUKI/VAUXHALL	4710021/93194660/4410151K90	304871	24598		385,598,628
GDS57210	OPEL/SUZUKI/VAUXHALL					385,598,600,628
GDS57211	SUZUKI	44102M76M00				593
GDS57221	OPEL/SUZUKI/VAUXHALL	4710013/93194650/4410151K00	304869	24596		385,598,627
GDS57222	OPEL/SUZUKI/VAUXHALL	4710017/93194655/4410251K00	304868	24595		385,598,627
GDS57223	VAUXHALL	4711022/93194660/44102-51K90	304870	24597		628
GDS59001	FORD					220
GDS59004	TOYOTA	434300K200				619
GDS59011	TOYOTA	4341052070			17-1054	626,627
GDS59012	TOYOTA					622
GDS59013	TOYOTA					622
GDS59020	TOYOTA					621
GDS59021	TOYOTA					617
GDS59022	TOYOTA					617
GDS59031	TOYOTA	4343026021/4343035011				619
GDS59032	HOLDEN/TOYOTA					244,606
GDS59035	HOLDEN/TOYOTA					244,611
GDS59036	TOYOTA					618
GDS59044	TOYOTA					611,622
GDS59046	TOYOTA					611,622
GDS59049	TOYOTA	4242016040/4242016042/ 4342016040/4342016042				625
GDS59050	TOYOTA	4341016040/4341016042				625
GDS59051	TOYOTA	4342028030				616
GDS59052	TOYOTA					624
GDS59053	TOYOTA					624
GDS59054	TOYOTA					619
GDS59057	TOYOTA	4342052010				626
GDS59059	TOYOTA	4342033012				606

G-AP Ref.	MAKE	ADAPTABLE TO OE	GKN	SPIDAN	METELLI	PAGE
GDS59060	TOYOTA	4341033012				606
GDS59062	TOYOTA	4341006370				606
GDS59063	TOYOTA	4342006360				606
GDS59064	TOYOTA	4341028030				616
GDS59069	TOYOTA	4342012580				611
GDS59070	TOYOTA					611
GDS59071	TOYOTA					611
GDS59074	TOYOTA	4342006390				606
GDS59075	TOYOTA	4341006390				606
GDS59076	TOYOTA	434100D120				625
GDS59077	TOYOTA	434200D100				625
GDS59078	TOYOTA					602,604,605,611
GDS59079	TOYOTA					611
GDS59080	TOYOTA					611
GDS59114	TOYOTA					615
GDS59137	TOYOTA					606
GDS59161	TOYOTA					616
GDS59162	TOYOTA					616
GDS59168	TOYOTA	434300K020/434300K022				618,619
GDS59172	TOYOTA					603,604,605
GDS59191	TOYOTA	4341012670				611
GDS59192	TOYOTA	4342012590				611
GDS59195	TOYOTA	4341012351				611
GDS59196	TOYOTA	4342012341				611
GDS59205	TOYOTA					612
GDS59206	TOYOTA	434200D370				626
GDS59207	TOYOTA					603
GDS59208	TOYOTA	434100D380				626
GDS59209	TOYOTA					626
GDS59217	TOYOTA	4346009420				619
GDS59219	TOYOTA					619
GDS59268	TOYOTA	4342002620	304949	24678		602,611
GDS59270	TOYOTA	4342002270				611,612
GDS59271	TOYOTA					611,612
GDS59272	TOYOTA	4342005240				603
GDS59273	TOYOTA					603
GDS59316	TOYOTA	4342002610/4342002611	304947	24676		602,611
GDS59317	TOYOTA	4341002570	304948	24677		602,611
GDS59343	TOYOTA	434200D322				626
GDS59344	LAND ROVER					297,298
GDS59345	TOYOTA	434100D292				626
GDS59346	LAND ROVER					298
GDS59352	TOYOTA	4347009L30			21-0001	626
GDS59354	TOYOTA	4346009M60			21-0002	626
GDS59377	TOYOTA	4342047030				622
GDS59379	TOYOTA					622
GDS59380	TOYOTA					622
GDS59392	TOYOTA	2650112003				611
GDS59443	VOLVO					746,748,753
GDS59444	VOLVO					746,748,750,753
GDS59445	TOYOTA					615
GDS59446	TOYOTA					615
GDS59447	TOYOTA	4341002580	304950	24679		602,611
GDS59480	LAND ROVER					296,297,300
GDS59493	TOYOTA	4342002D80/434200F070/434200F071	305414	25191		625
GDS59494	TOYOTA	434100F040/434100F041	305418	25195		602,625
GDS59495	CITROEN/PEUGEOT/TOYOTA	3272JZ/434200H020	304786	24513	17-0857	105,433,605
GDS59505	TOYOTA	434200F011				615
GDS59518	TOYOTA					623
GDS59519	TOYOTA					603
GDS59520	TOYOTA	4342005430/4342005431	305425	25202		604
GDS59531	TOYOTA	434100F010				615
GDS59535	LAND ROVER					296,297,299
GDS59552	TOYOTA	4341005450/4341005451	305419	25196		603,604
GDS59553	TOYOTA	4342005400/4342005401	305423	25200		603,604
GDS59589	TOYOTA					604
GDS60002	VAUXHALL	374188/374210/374221/374312/ 26029827/26032414/93192082/374738/ 90540523/374229/90444328	301506/302386	21406/21470	17-0276/17-0280	647
GDS60004	VAUXHALL					645
GDS60006	VAUXHALL					645
GDS60007	VAUXHALL/VAUXHALL LCV					645,646,655,662
GDS60009	VAUXHALL					645
GDS60010	VAUXHALL/VAUXHALL LCV					628,642,662



G-AP Ref.	MAKE	ADAPTABLE TO OE	GKN	SPIDAN	METELLI	PAGE
GDS60012	VAUXHALL					656
GDS60013	OPEL/VAUXHALL	374321/9117407/90538602	304414/304418	24066	17-0554	390,391,392,393,633
GDS60014	VAUXHALL					628
GDS60015	VAUXHALL					656
GDS60016	OPEL/VAUXHALL					427,428,656,658
GDS60019	OPEL				17-0624	389,390
GDS60020	OPEL/VAUXHALL					394,395,396,398,635,636,637,640
GDS60021	OPEL/VAUXHALL					402,403,406,416,645,647,651
GDS60022	OPEL/RENAULT	8200452269/4417912/8200776538	304780	24507		429,430,535,536
GDS60023	OPEL/VAUXHALL					385,407,408,627,647,648,649
GDS60024	OPEL/VAUXHALL					408,648
GDS60025	OPEL/VAUXHALL					408,648
GDS60026	OPEL/VAUXHALL	13228204/374835	305215	24966		409,410,649,650
GDS60027	OPEL/VAUXHALL	13219092/374829/13348258/374922	305214	24965		408,409,410,432,649,650,651,662
GDS60035	CHEVROLET/OPEL/VAUXHALL/VOLKSWAGEN	374328/374612/90539783/9117414/93187066	304419	24072		92,390,391,392,393,431,634,635,639,661,703
GDS61001	VOLKSWAGEN	357407271A/357407271EX/357407271G/ 357407271GX/357407271H/357407271HX/ 357407271P/357407271PX/ 357407449AX/1H0407271A	301241	23544	17-0123/17-0187	675,676,700,701,702,707,708,739
GDS61002	VOLKSWAGEN	357407272/1H0407272N/357407271B/ 357407272B/357407272F/357407272FX/ 357407272L/357407272M/357407272MV/ 357407272MX/357407450V/357407450X	301242	23547	17-0124	675,676,700,701,702,707,708,739
GDS61003	VOLKSWAGEN	701407271M/701407451X/701407449FX	303167	21025	17-0755	728,732,733,734
GDS61004	VOLKSWAGEN	701407271P/701407451A	303165	21023	17-0757	728,732,733,734
GDS61005	VOLKSWAGEN	251501203B/251501203BX/251501203D/ 251501203DX/251501203G/251501204A/ 251501204AX/251501204B/251501204BX	300669	22477	17-0001	727,731,732
GDS61006	VOLKSWAGEN	171407272AC/171407272AS/171407274DX/ 171407274FX/191407272AS/191407272BB/ 191407274FX	301716	22428	17-0418	674,718
GDS61007	VOLKSWAGEN	6N0407271/6N0407271V/6N0407271X/ 6N0407449V/6N0407271B/6N0407451X	303546/304847	24574/21708	17-0127	713,714
GDS61008	VOLKSWAGEN	191407272/191407272AA/191407272X/ 191407274X	301535/301547	22463/23541	17-0122	674,695
GDS61009	VOLKSWAGEN	1H0407272A/1H0407272AF/1H0407272AX/ 1H0407272M/1H0407272MV/1H0407272MX/ 1H0407450BX	301722	22622		675,676,739
GDS61010	VOLKSWAGEN	6N0407272/6N0407272X/6N0407450X	303547	21709	17-0128	713,714
GDS61011	VOLKSWAGEN	1H0407271N	301619	22931		675,676,739
GDS61012	VOLKSWAGEN					684,738
GDS61019	SKODA/VOLKSWAGEN	3B0407272M/8D0407272AJ/8D0407272BB/ 8D0407272DT/8D0407272EF/8D0407452CV/ 8D0407452CX/8D0407454CV/8D0407454CX/ 8D0407452LX	301287	22686	17-0604	583,702,703,708,709
GDS61021	AUDI/SEAT/SKODA/ VOLKSWAGEN					23,24,560,565,572,573,663,664,665,666,677,678,679,680,681,699,700
GDS61022	VOLKSWAGEN					713
GDS61023	VOLKSWAGEN					713
GDS61024	VOLKSWAGEN					713
GDS61025	VOLKSWAGEN					713
GDS61028	VOLKSWAGEN	1H0407272AM/1H0407452X	301620	22930	17-0752	675,676,739
GDS61030	VOLKSWAGEN LCV					739
GDS61031	VOLKSWAGEN	113501201D	300636	22419		663,697
GDS61034	VOLKSWAGEN	701407271AB	302380	20600		728,733,734
GDS61040	VOLKSWAGEN					673

G-AP Ref.	MAKE	ADAPTABLE TO OE	GKN	SPIDAN	METELLI	PAGE
GDS61042	AUDI/SEAT/SKODA/ VOLKSWAGEN	1K0407272CC/1K0407272DN/1K0407272FR/ 1K0407272GK/1K0407272GM/1K0407454BX/ 2K0407272F/1K0407272EC/1K0407452DX/ 1K0407452GX	304750	24477	17-0760	24,25,27,28,29,548, 549,550,551,561,575, 577,581,582,583,669, 670,682,683,684,685, 688,689,690,691,692, 693,695,696,697,703, 709,725,727
GDS61045	AUDI/SEAT/SKODA/ VOLKSWAGEN	1J0407271AC/1J0407271AH/1J0407271AL/ 1J0407271AM/1J0407271F/1J0407271Q/ 1J0407451BX/1J0407451V/1J0407451X	303153/303155	21012/21014	17-0207/17-0445	23,559,560,564,571, 572,573,574,663,664, 665,676,677,679,680
GDS61052	VOLKSWAGEN	701407271AC	302379	20601		728,733,734
GDS61054	VOLKSWAGEN	171407272AG	301542	22435	17-0354	674,718
GDS61055	VOLKSWAGEN	1H0407272/1H0407272AD	301552/301554	22626/22630	17-0355	675,676,739
GDS61060	VOLKSWAGEN					694
GDS61062	VOLKSWAGEN					674,738
GDS61063	SEAT/SKODA/VOLKSWAGEN	6Q0407272BC/6Q0407272BD/6Q0407272BE/ 6Q0407272BH/6Q0407272DR/6Q0407452EX/ 6Q0407452FX/6Q0407452GX	304444	24097	17-0612	553,554,556,557,566 ,567,568,569,570,571, 579,580,673,715,716
GDS61065	FORD/SEAT/VOLKSWAGEN	7M0407272C/7M0407272CX/7M0407272G/ 7M3407272D/95VW3B436DA	302837	20157		215,546,547,719,720
GDS61067	VOLKSWAGEN	1H0407272AC/1H0407272AG/1H0407274V/ 1H0407274X/1H0407450AX	301553	22628	17-0353	675,676,738,739
GDS61074	SEAT/VOLKSWAGEN	6X0407272E/6X0407452V/6X0407452X	304442		17-0474	553,697
GDS61075	SEAT/VOLKSWAGEN	6X0407271H/6X0407271K/6X0407451AX/ 6X0407451X	304441	24094	17-0472	553,697
GDS61076	AUDI					59,60,61,64,65,66
GDS61079	VOLKSWAGEN	5X3407271				673,700
GDS61080	VOLKSWAGEN	5X3407272				673,700
GDS61082	SKODA/VOLKSWAGEN	8D0407272BQ/8D0407272EK/8D0407452M/ 8D0407452MX	303925	22256		582,583,702,708
GDS61083	SKODA/VOLKSWAGEN	8D0407271BQ/8D0407271EK/8D0407451N/ 8D0407451NX/8D0407451TX	303924	22255		582,702,708
GDS61084	VOLKSWAGEN	7H0407271AF/7H0407271AL/7H0407451TX/ 7H0407451CV/7H0407271Q/7H0407271AA/ 7H0407451AX/7H0407452BV/7H0407452FV/ 7H0407272AH/7H0407272AK/7H0407272AR/ 7H0407272BG/7H0407272BN/7H0407272CJ/ 7H0407452BX/7H0407452FX/7H0407452KX/ 7H0407454X	304501/304506/ 304491	24144		699,730,736,737,738
GDS61085	FORD/SEAT/VOLKSWAGEN	7M0407271D/7M0407271N/7M3407271H/ 7M3407271RX/7M3407451CX/95VW3B437DA	302836	20156		215,546,548,719,720
GDS61087	FORD/SEAT/VOLKSWAGEN	6M213B437AA/1449540/7M3407271TX/ 7M3407271T/1125046/7M3407271G/ 7M3407271S/7M3407271SX/7M3407451DX	305483	25260		214,547,719,720
GDS61089	AUDI/SEAT/SKODA/ VOLKSWAGEN					24,25,27,28,29,548, 549,550,551,560,561, 562,563,564,565,574, 575,576,577,578,579, 581,582,583,672,682, 683,684,685,688,689, 690,691,692,693,694 ,695,696,703,704,709, 710,725,727
GDS61092	VOLKSWAGEN	251407271J	301623	23516		727,731,732
GDS61093	AUDI/SEAT/SKODA/ VOLKSWAGEN	1K0407271CQ/1K0407451PX	304760	24487		24,25,28,29,549,551, 561,565,575,577,668, 669,672,682,683,685, 688,690,695,696,703, 704,709,710,725
GDS61094	AUDI/SEAT/SKODA/ VOLKSWAGEN	1K0407272FS/1K0407452QX	304769	24496		24,25,28,29,549,551, 561,565,575,577,668, 669,672,682,683,685, 688,690,695,696,703 ,704,709,710,725
GDS61096	AUDI/VOLKSWAGEN	1K0407272HK/1K0407272BG/1K0407272JT	304753		17-0764	24,28,682,685
GDS61097	AUDI/VOLKSWAGEN	1K0407271DJ/1K0407451JX	304749	24476	17-0763	24,28,682,685

G-AP Ref.	MAKE	ADAPTABLE TO OE	GKN	SPIDAN	METELLI	PAGE
GDS61098	SEAT/SKODA/VOLKSWAGEN	6Q0407271BE/6Q0407271BS/6Q0407271DB/ 6Q0407271DE/6Q0407451FX	304445		17-0613	553,554,556,557,566, 567,568,569,570,580, 715,716
GDS61099	SEAT/SKODA/VOLKSWAGEN	6Q0407272BK/6Q0407272DH/6Q0407452HX	304446	24099	17-0614	553,554,557,566,567, 568,569,570,580,715 ,716
GDS61101	VOLKSWAGEN	2K0407272E			17-0884	668,669,670
GDS61104	FORD/SEAT/VOLKSWAGEN					215,547,719,720
GDS61105	VOLKSWAGEN	7H0407271AK/7H0407271E/7H0407271T/ 7H0407451JX/7H0407451X	304499	24152		697,698,729,734,735, 736,737
GDS61106	FORD					214,229,230,233
GDS61113	SEAT/SKODA/ VOLKSWAGEN	1K0407272HN/1K0407452MX	304771	24498		549,551,561,565,575, 577,668,669,670,683, 685,703,709,725
GDS61115	AUDI	8E0407271AH/8E0407451EX	304286	23614		33,34,44,45,46
GDS61117	VOLKSWAGEN					673,700
GDS61118	VOLKSWAGEN					673,700
GDS61119	VOLKSWAGEN	701407271B/701407271BV/701407271BX/ 701407449X	301323	20592	17-0186	728,732,733,734
GDS61121	SEAT/SKODA/VOLKSWAGEN	1J0407272BJ/1J0407272GD/1J0407272KT/ 1J0407452Q/1J0407452QV/1J0407452QX	303927	22267	17-0444	560,564,565,572,573, 663,665,666,677,680
GDS61122	SKODA/VOLKSWAGEN	8D0407271AN/8D0407271BJ/8D0407271CL /8D0407271DJ/8D0407271DP/8D0407451BV/ 8D0407451BX/8D0407451FX	301220	22689	17-0201	582,702,708
GDS61123	AUDI/SEAT/SKODA/ VOLKSWAGEN	1J0407271AA/1J0407271CG/1J0407271EP/ 1J0407271ES/1J0407271FD/1J0407271GC/ 1J0407271LM/1J0407271LN/1J0407451HX/ 1J0407451P/1J0407451PV/1J0407451PX/ 1J0407271EF	304351	23769	17-0443	23,24,74,75,76,560 ,564,565,572,573,663, 664,665,666,677,678, 680,681
GDS61126	AUDI/SEAT/SKODA/ VOLKSWAGEN	1K0407272NJ/1K0407454NX/1K0407272KJ				26,27,28,29,30,31,549, 550,551,552,561,562, 565,566,575,576,577, 578,581,582,584,671 ,672,683,684,686,689, 690,691,693,696,701, 702,704,705,706,707, 709,710,711,717,718, 725,726,727
GDS61131	AUDI/SEAT/SKODA/ VOLKSWAGEN	2K3407271B/2K3407271BX				25,27,29,548,551,561, 574,576,581,582,668, 669,670,671,690,701, 705,706,707,709
GDS61135	SEAT/SKODA/VOLKSWAGEN					553,554,557,558,566, 567,568,569,570,580, 715,716
GDS61136	SEAT/SKODA/VOLKSWAGEN					553,554,557,558,566, 567,568,569,570,580, 715,716
GDS61140	VOLKSWAGEN	7H0407272AC/7H0407272AL/7H0407272BB/ 7H0407272BD/7H0407272BL/7H0407452AV/ 7H0407452AX/7H0407452JV/7H0407452JX/ 7H0407452PX	304502	24155		699,730,736,738
GDS61146	AUDI/VOLKSWAGEN					72,721,722
GDS61147	AUDI/VOLKSWAGEN					72,721,722
GDS61150	SKODA					566,570,580
GDS61156	AUDI/SEAT/SKODA/ VOLKSWAGEN					23,24,74,75,559,564, 565,571,572,573,574 ,575,663,664,665,666, 676,677,678,679,680, 681,699,700
GDS61157	AUDI/VOLKSWAGEN	8D0407451PV/8D0407271DF/8D0407451RX/ 8D0407271DQ/8D0407271RX/8D0407451PX	304287			44,702,708
GDS61172	VOLKSWAGEN	1H0407271/1H0407271H/1H0407271V/ 1H0407271X/1H0407449X	301551	22625	17-0352	675,738,739
GDS61173	VOLKSWAGEN	2H0407271BX/2H0407271D/2H0407271DX				663
GDS61183	SEAT/SKODA/VOLKSWAGEN	6Q0407272CL/6Q0407272J/6Q0407452KX	304618	24302		554,557,568,716
GDS61184	AUDI/SEAT/VOLKSWAGEN	6R0407761A/6R0407761AX				22,558,714
GDS61185	AUDI/SEAT/VOLKSWAGEN	6R0407762A/6R0407762AX				22,558,714
GDS61186	AUDI/SEAT/SKODA/VOLKSWAGEN	1J0407452LX/1J0407272FQ/1J0407272FL/ 1J0407272FD	304352	23770	17-0607	23,24,74,75,76,560, 573,663,664,665,666, 677,678,680,681



G-AP Ref.	MAKE	ADAPTABLE TO OE	GKN	SPIDAN	METELLI	PAGE
GDS61188	SEAT/VOLKSWAGEN					546,721
GDS61190	VOLKSWAGEN	02Z409345B	305617	25394		697,698,699,729,730, 731,734,735,736,737 ,738
GDS61191	VOLKSWAGEN	0A5409343/0A5409355C/0A5409343B	305616	25393		697,698,699,729,730, 731,734,735,736,737, 738
GDS61192	FORD/SEAT/VOLKSWAGEN	02N409345				213,214,215,546,547, 548,719,720,721
GDS61193	FORD/SEAT/VOLKSWAGEN	02N409344E				213,214,215,546,547, 548,719,720,721
GDS61198	SEAT/SKODA/VOLKSWAGEN	1K0407271KP/1K0407763GX/1K0407271JA/ 1K0407761MX				548,550,558,560,562 574,576,583,672,681, 682,689,690,692,695, 696,697,701,703,707 <del>708,717,726</del>
GDS61199	SEAT/VOLKSWAGEN	5Q0407762X/1K0407272PH/1K0407764X				562,563,689,693,694
GDS61200	AUDI/SEAT/SKODA/VOLKSWAGEN					31,32,33,562,563, 564,574,576,578,579, 580,581,584,694,701, 703,704,707,709,710, 726
GDS61201	AUDI/SKODA/VOLKSWAGEN	1K0407271LA/1K0407271HH/1K0407761EX				24,27,28,583,670,671, 681,682,684,688,689, 690,692,693,694,695, 701,703,706,707,709, 717,724,726
GDS61202	SEAT/VOLKSWAGEN					559,663,665,676,679
GDS61203	SEAT/VOLKSWAGEN					559,663,665,676, 677,679
GDS61204	SEAT/SKODA	6Q0407271CL/6Q0407271J/ 6Q0407451JX/6Q0407271CE	304859	24586		554,557,568
GDS61205	SEAT/VOLKSWAGEN					552,697,713
GDS61206	VOLKSWAGEN					716
GDS61210	VOLKSWAGEN	7H0407272BE/7H0407272AP/7H0407452HX/ 7H0407272AF/7H0407272AS/7H0407272BJ/ 7H0407272BQ/7H0407452DX/7H0407452QX/ 7H0407452RX/JZW407450QX	304504	24157		699,730,736,737,738
GDS61211	AUDI/SKODA/VOLKSWAGEN	1K0407272HB/1K0407272KC/1K0407452NX/ 1K0407762X	304774	24501		24,28,576,682,685, 695,697
GDS61223	SEAT/SKODA/VOLKSWAGEN	6Q0407272DM/6Q0407452QX	304826	24553	17-0876	553,556,566,567,568, 569,570,580,673,716
GDS61224	VOLKSWAGEN	1K0407271DS/1K0407761AX	304763	24490		682,695,724
GDS61236	PORSCHE/VOLKSWAGEN	95533202401/7L0501201BX/7L0501201B	304850	24577		483,484,722,723
GDS61244	VOLKSWAGEN					663,665,666,677, 680,681
GDS61252	SEAT/SKODA/VOLKSWAGEN	6Q0407272AR/6Q0407272BL/6Q0407272DJ/ 6Q0407272BA/6Q0407452MX	304616			553,556,567,568, 569,715
GDS61257	VOLKSWAGEN	7H0501201D/7H0501201DX/7H0501201C/ 7H0501201CX	304528	24181		699,730,731,736,738
GDS61258	VOLKSWAGEN	7H0501202C/7H0501202CX	304529	24182		699,736
GDS61260	AUDI/SEAT/VOLKSWAGEN	6R0407761S/6R0407761SX				22,558,559,714
GDS61261	AUDI/SEAT/VOLKSWAGEN	6R0407762S/6R0407762SX				22,558,559,714
GDS61263	AUDI/SEAT/VOLKSWAGEN					22,557,558,559,714
GDS61267	SEAT/SKODA/VOLKSWAGEN					558,559,566,579,714
GDS61268	SEAT/VOLKSWAGEN	1K0407271BK/5Q0407761FX/1K0407451LX				563,669,670
GDS61274	AUDI/SEAT/VOLKSWAGEN	6R0407761K				22,557,558,559,714
GDS61280	SEAT/SKODA/VOLKSWAGEN	5Q0407272BN/1K0407272SP/1K0407764RX				561,574,576,578,579, 683,684,690,693,694
GDS61281	SKODA/VOLKSWAGEN	1K0407271JJ/1K0407761PX				574,670,682,689,690, 692,701,703,706,707, 709
GDS61283	SEAT/SKODA/VOLKSWAGEN	1K0407272QN/5Q0407272H/ 5Q0407762EX				562,563,578,693,694
GDS61284	AUDI/VOLKSWAGEN	1K0501203F/1K0501203FX				26,27,30,31,685,687, 705,711

G-AP Ref.	MAKE	ADAPTABLE TO OE	GKN	SPIDAN	METELLI	PAGE
GDS61293	AUDI/VOLKSWAGEN	1K0501204F/1K0501204FX				26,27,30,31,685,687,705,711
GDS61301	SKODA/VOLKSWAGEN	6R0407762K/6Q0407272EA/6Q0407452RX				566,567,569,570,580,716
GDS61302	SKODA/VOLKSWAGEN	6Q0407271DS/6R0407763K/6Q0407271DP/6Q0407451QX				566,567,569,570,580,716
GDS61303	SEAT/SKODA/VOLKSWAGEN	5Q0407272F/1K0407272PL/5Q0407762JX				562,563,578,684,693,694
GDS61304	AUDI/CITROEN/SEAT/SKODA/VOLKSWAGEN	5Q0407271G/5Q0407761DX				31,32,33,109,562,563,564,578,579,693,694
GDS61312	FORD/SEAT/VOLKSWAGEN	1J0407271GD/1J0407271JL/1J0407451NX/1J0407451TX/1J0407451NV/1J0407451TV/1J0407271BG/1J0407271CJ/1J0407451JX/1J0407451J	304353/303159	23771/21018		227,559,564,663,665,676
GDS62001	VOLVO	8111306/9122569/9163593/9601096/91225698	301397	20833		741
GDS62002	VOLVO	8601097/9122570/9163592/91225706	301398	20834		741
GDS62004	VOLVO					749
GDS62017	VOLVO					744,745,746,747,751,753
GDS62021	VOLVO					742,749
GDS62022	VOLVO	9480544/8689210/8603789/8602574/8601853/30783082/36000518/30735129	305561	25338		743,744,745,746,750,751,752,753,754
GDS62023	VOLVO					743
GDS62028	VOLVO					741,742,744,745,746,747,748,750,751,752,753
GDS62029	VOLVO					744,745,746,747,748,750,751,752,753
GDS62031	VOLVO	8602578/30735121/30783097/36000532/8252049/8601856/8603793/8689214	305560	25337		745,751,752,753
GDS62035	VOLVO					742,743,749
GDS62039	VOLVO	36000522	305664			754
GDS62046	VOLVO					754
GDS62053	VOLVO					743,749
GDS62056	MITSUBISHI/SAAB					354,544
GDS62060	VOLVO	30783173/30787774/36000183/36000439/36000441/36000548/36000550/8603119/8603819	304743	24470		740,741,742,743,750
GDS62063	VOLVO	30783174/30787784/36000184/36000241/36000449/36000450/36000451/36000558/36000560/36051061/8603120/8603820	304744	24471		740,741,742,743,750
GDS62064	VOLVO					743,749
GDS62072	VOLVO					742,743,749
GDS66001	SSANGYONG					586
GDS66002	SSANGYONG					586
GDS66003	SSANGYONG	4130008012				586
GDS66004	SSANGYONG	4130008001				586
GDS75056	LDV	538450086/538450104	305469	25246		300,301
GDS99003	PEUGEOT	3273Z0/3273Z1	303492	21959	17-0292	458,459,460
GDS99006	CITROEN	32722Q/32723Q/3272Q	303345	21339	17-0494	130
GDS99007	CITROEN	3272X9	302914	23348		130
GDS99010	CITROEN	32737H/32737J	303346	21340	17-0495	130
GDS99012	PEUGEOT					433
GDS99013	PEUGEOT					433
GDS99014	CITROEN					130,131
GDS99017	PEUGEOT					436,437,438
GDS99019	CITROEN/PEUGEOT					101,102,109,110,111,112,113,445,446,447,448,479,480,481
GDS99025	CITROEN/PEUGEOT					102,135,136,137,480,481
GDS99026	CITROEN					130,131
GDS99027	CITROEN					130,131
GDS99028	PEUGEOT					438
GDS99037	PEUGEOT		304796			445
GDS99038	PEUGEOT					442

G-AP Ref.	MAKE	ADAPTABLE TO OE	GKN	SPIDAN	METELLI	PAGE
GDS99042	FORD	1328362/2T143B436AC/2T143B436AD/ 2T143B436AE/2T143B436AF/2T143B436AG/ 2T143B436AH	305038	24766	17-0843	238
GDS99043	FORD/FORD LCV					202,240
GDS99044	FORD					219,234
GDS99047	FORD					197,231
GDS99048	FIAT					178
GDS99053	HYUNDAI					274
GDS99064	MAZDA	GD402550XA				307,308,309
GDS99069	OPEL/PORSCHE/VAUXHALL					403,405,406,416,483, 646,648,651
GDS99070	RENAULT	7711368284/8200356803/8200388506/ 8200511116/8200167535/8200264664/ 8200623807/8200690053/391010737R/ 8200626043/8200661557	304745/304801	24472/24528	17-0903	503,504,505,522,524 ,525,526
GDS99071	RENAULT	7711135416/7711135417/8200167522/ 8200264665/8200264668/8200300713 /8200613827/8200626038/8200167536 /8200246665	304339/304341	23740/23742	17-0896/17-0860	522,524,525,526
GDS99072	NISSAN/RENAULT					362,502,504
GDS99073	NISSAN/RENAULT					362,494,495,496,497, 498,502,504,505
GDS99076	RENAULT					518,520,530
GDS99080	SUZUKI	4410163J21				599
GDS99096	SUZUKI					599
GDS99097	SUZUKI					599
GDS99106	TOYOTA	4341005370/4341005720				603
GDS99107	TOYOTA	4342005320				603
GDS99108	VOLKSWAGEN	8D0407272AC/8D0407272BE/8D0407272DK/ 8D0407272DM/8D0407418H/8D0407452DV/ 8D0407452DX	301210		17-0690	702,708
GDS99111	VOLKSWAGEN	8D0407272AP/8D0407272DL/8D0407452V/ 8D0407452X/8D0407272BA	301221	22682	17-0198	702,708
GDS99113	AUDI	4B0407272C/4B0407272M/4B0407452CX	303313	21172		59,60,61,64,65,66
GDS99116	SEAT					559
GDS99120	FORD/SEAT/VOLKSWAGEN	7M3407272B/7M3407272C/7M3407272E/ 7M3407272EX/7M3407452V/7M3407452X/ YM213B436AD	303923	22254		215,548,721
GDS99132	RENAULT					484
GDS99136	PEUGEOT					443
GDS99138	VAUXHALL					644
GDS99139	VAUXHALL					644
GDS99146	HONDA					255
GDS99150	RENAULT	7701352849/7701470884/7711134327/ 8200107090	303236	21069		495,496,533
GDS99151	OPEL/RENAULT/VAUXHALL	8200169288/8200499895	303506	21552	17-0862	417,418,515,652,653
GDS99155	HOLDEN					244
GDS99157	OPEL/VAUXHALL					403,405,406,416,646, 648,651
GDS99158	CITROEN					130,131
GDS99159	PEUGEOT					456,457,458,459,460
GDS99165	PEUGEOT					457,458,459,460
GDS99167	JEEP					278,279,280
GDS99168	JEEP					278,279,280
GDS99169	RENAULT					494,495,496,498, 503,505
GDS99170	CITROEN/PEUGEOT					109,111,445,446,447
GDS99172	CITROEN					114,115
GDS99175	FORD					204,205
GDS99176	JAGUAR					275,278
GDS99177	JAGUAR					275,278
GDS99179	FORD	6C113B437BC/6C113B437BE/7C113B436AB				235,236,238,239
GDS99180	TOYOTA	4341052110				626
GDS99181	TOYOTA	4342052110				626
GDS99184	SUZUKI					596,597
GDS99186	RENAULT	8200216626/8200531908/8200531910	304564	24244		501,531
GDS99188	RENAULT	8200379235	304856	24583		522,524,526
GDS99189	CITROEN					113,114,115



G-AP Ref.	MAKE	ADAPTABLE TO OE	GKN	SPIDAN	METELLI	PAGE
GDS99190	SMART	Q0003234V006000000/Q0003234V007000000/ Q0003234V009000000/Q0003234V010000000/ Q0003234V011000000	304582	24262	17-0629	584,585,586
GDS99191	SMART	Q0003233V006000000/Q0003233V007000000/ Q0003233V009000000/Q0003233V010000000/ Q0003233V011000000	304583	24263	17-0630	584,585,586
GDS99195	CITROEN/PEUGEOT	3272FG/3272FH/3272FL/3272KL/ 3272LP/9642426680/3272LQ/9642600180	305348	25125		102,103,135,136,137, 138,480,481
GDS99196	CITROEN/PEUGEOT	3273FG/3273FH/3273JY/3273JZ/9642426780/ 9642600080	305349	25126		102,103,135,136,137, 138,480,481
GDS99197	CITROEN	3273GZ/3273NT/3273RN/3273RP	304643	24329		115
GDS99200	SAAB					544
GDS99201	RENAULT	8200198016/7711135420	304340	23741		501,522,523,524, 525,526,531
GDS99205	OPEL/VAUXHALL					401,402,403,404,405 ,406,407,644,645,646 ,647,648,649,651,655
GDS99211	FORD	6G913B437BE/1667774				213,214,227,228,229
GDS99212	FORD/VOLVO	1437705/6G913B436EB				213,214,228,229,230
GDS99213	AUDI/PORSCHE/VOLKSWAGEN	7L0407271EX/7L0407271E/ 7L0407271C/7L0407271CX	304545			73,483,484,722,723
GDS99214	CITROEN/FIAT/PEUGEOT					116,117,118,120,186, 461,462,476,477
GDS99215	BMW	31607529201/31607524045/ 31603450563/31603450565	304667/304669	24355	17-0916	87,88
GDS99216	KIA	4950007060				283
GDS99217	RENAULT	8200352042	304798	24525		496
GDS99228	RENAULT			24721		503,504,505
GDS99229	RENAULT			24722		503,504,505
GDS99232	MINI					347
GDS99242	RENAULT					494,495,496,498 ,503,505
GDS99244	FORD	6C113B436BC/6C113B436BE/7C113B436AA				239
GDS99246	CHEVROLET	13271519/13334708				93,94
GDS99247	CHEVROLET	13271549/13334715				93,94
GDS99266	RENAULT					511,512
GDS99271	CITROEN/PEUGEOT	3273KJ/3273KK/3273PZ/3273QA	304585/304587	24271/24269		108,119,438,439,440
GDS99272	PEUGEOT	3272KW/3272KX	304584	24268		438,439
GDS99278	KIA					285
GDS99285	MINI	31601493977/31607514475/31607518237	304212	23277	17-0944	337
GDS99286	NISSAN/OPEL/RENAULT/VAUXHALL					361,417,418,514,515, 516,652,653
GDS99288	MINI					337
GDS99296	MERCEDES BENZ					323,324,325,326
GCI81001	HONDA					255
GCI81002	ACURA/HONDA					1,244,245,259
GCI81003	HONDA					245
GCI81006	HONDA					257
GCI81008	HONDA/ROVER					258,540
GCI82001	ALFA ROMEO	700611	301103/302211	20020	16-1017	1,7,8,9,10,11
GCI82003	ALFA ROMEO	46307515			16-1025	12
GCI82004	ALFA ROMEO	46307223/46307457	302282	23521	16-1014A	7
GCI82005	ALFA ROMEO/FIAT/LANCIA	46307103/60812691			16-1020	1,2,3,7,11,12,153,176, 177,178,181,184,188, 189,292
GCI82006	FIAT/FORD/LANCIA/MOSKVIC	1493963			16-1005/16-1015	190,191,192,193,216, 217,218,234,293,294, 355
GCI82007	ALFA ROMEO/LANCIA					1,2,3,4,7,291,292
GCI82009	ALFA ROMEO					4,5,6,11,13
GCI82010	ALFA ROMEO					4,5,6,10,11,13
GCI82011	FIAT	60584662	304313	23677		177,178,188
GCI82014	ALFA ROMEO					4,6
GCI83001	ALFA ROMEO/AUDI/SKODA/ VOLKSWAGEN	251598101A/431407331G/431498103C/ 431498103CX/443407331D/443407331G/ 443498103A/4B0498103/431407331/ 431498104CX/1J0498103E	302287/302463	20273/23845	16-1014	13,58,64,583,702,708
GCI83002	AUDI/VOLKSWAGEN	443498103/811407331/3B0498103 8D0498103/8D0498103A/8D0498103AX/ 3B0498103X/431407331H/	301134/302246/ 302248	21312/22487/ 22522	16-1012	59,60,65,66,702,708

G-AP Ref.	MAKE	ADAPTABLE TO OE	GKN	SPIDAN	METELLI	PAGE
GCI83003	SKODA	893498103/1K0498103X/321498103B/ 811498103A/893498103X	302247/302260	20289/22545	16-1010	572,573,574
GCI83004	SEAT/SKODA/ VOLKSWAGEN	113501331/113598101/171498103/ 321498103/547498103/321498103V 321498350V/321498350X/171498103CX/ JZW498350AX/321498103X/	301116/302230/ 302231/302232	22793/20258/ 22405		553,554,556,559,571, 572,668,676,677,679
GCI83006	AUDI/VOLKSWAGEN	191407331/191407331A/1H0407331B/ 1H0407331D/321407331D	301141	20438		71,671,675,700,706,707
GCI83008	AUDI/SEAT/SKODA/VOLKSWAGEN	171407331F/171498103C/1J0498103/ 1K0498103B/321498103A/6Q0498103A/ ZBC407331/1H0407331H/1K0498103BX/ 431407331E/1J0498103X	305021	24749	16-1004/16-1022	23,548,550,559,560, 564,571,572,573,574, 576,663,664,674,676 ,677,679,682,684,688 ,690,692,699,700,713
GCI83009	SEAT/SKODA/VOLKSWAGEN	191498104/357498104/535498104 321498103C/321498103CV/321498103CX/ 357498104V/357498104X/191498104A	302258/302262	22498	16-1010A	553,560,572,573,665 ,677,680,700
GCI83011	AUDI/SEAT/SKODA/ VOLKSWAGEN/ VOLKSWAGEN LCV	191498103/357498103/191498103A 191498104C/1K0498103/357498103A/ 357498103B/357498103V/357498103X/ 1J0498103A/1K0498103/191498103C	302257/302261	22497	16-1010B	23,24,25,26,27,28,29, 30,31,73,74,75,76,548 ,549,550,551,552,553 ,554,556,557,558,559, 560,561,564,565,566, 570,572,573,574,575 ,576,577,578,580,581 ,663,664,665,666,668 ,669,670,671,672,677, 678,679,680,681,682 ,683,684,685,686,688, 690,691,695,696,699, 700,703,704,705,706, 709,710,711,713,714, 716,717,721,722,724, 725,739
GCI83013	AUDI/SKODA/VOLKSWAGEN					21,32,579,664,700
GCI83014	AUDI	893498103B/893498103BX	302249	22632		18,19,20,21,71
GCI83016	AUDI/SEAT/SKODA/ VOLKSWAGEN	1K0498103A				22,23,24,25,26,27,28, 29,30,31,32,72,74,549 ,550,551,552,557,558, 561,562,563,565,570 ,575,576,577,578,579 ,581,582,583,584,664 ,668,669,670,671,672, 679,683,684,685,686 ,687,688,689,690,691, 692,693,694,696,697 ,701,704,705,706,707 ,710,711,712,717,718, 719,721,722,724,725 ,726
GCI83022	AUDI	4H0498103AX/8K0498103DX/ 4H0498103A/8K0498103D				41,42,43,44,50,51,52 ,53,54,55,56,57,63,68 ,69,70,71,72,73
GCI83027	AUDI/VOLKSWAGEN	7L0598103/95533290200/7L0501331	304558	24238		73,722,723
GCI83029	AUDI					41,42,43,44,50,51,52, 54,55,56,57
GCI85001	BMW	33211227599	302225	21989		91
GCI85007	MERCEDES BENZ					329
GCI85009	BMW				17-0214	78,81,82,91
GCI85012	MINI					337,338,339
GCI85014	BMW	31607565314				88,89,90,91
GCI85030	BMW					89,90,91
GCI85033	BMW					84,85,86
GCI85041	MERCEDES BENZ	A1643300801				331
GCI85042	MERCEDES BENZ					331
GCI85043	MINI					337,338
GCI85044	MINI					337,338

G-AP Ref.	MAKE	ADAPTABLE TO OE	GKN	SPIDAN	METELLI	PAGE
GCI85048	SSANGYONG	4230009101/4230009100				586
GCI86001	BUICK					92
GCI86003	BUICK					92
GCI88002	DAEWOO					142
GCI88008	CHEVROLET/GMC/OLDSMOBILE					96,243,384
GCI88009	CHEVROLET / GEO/GMC					97,243
GCI88013	MAZDA	F03725500/F03725500A				318
GCI88014	FORD					220
GCI88015	CHEVROLET/HOLDEN/TOYOTA					95,96,244,611,613,615
GCI88016	TOYOTA					613
GCI88017	SUZUKI	4410260G00/4411772F00				595
GCI88018	SUZUKI					593,595,598,600
GCI88021	CHEVROLET					92,93
GCI88034	CHEVROLET/DAEWOO/OPEL	4804590				93,144,385
GCI88035	CHEVROLET/OPEL	93743414/96624724/4804589				93,386
GCI88039	CHEVROLET	13318012				94
GCI88040	CHEVROLET	13318013				94
GCI88041	CHEVROLET	13318014				94
GCI88054	CHEVROLET/OPEL	13306856/374691				94,399
GCI88057	CHRYSLER					98
GCI89003	CHRYSLER					98,99
GCI89005	CHRYSLER/CHRYSLER TRUCK / VAN					99,100
GCI89006	CHRYSLER					99
GCI89009	CHRYSLER/DODGE/EAGLE					97,150,151
GCI89011	CHRYSLER TRUCK/ DODGE TRUCK/ PLYMOUTH TRUCK					100,151,482
GCI89012	DODGE TRUCK					151
GCI89017	CHRYSLER					98
GCI89021	CHRYSLER/DODGE/PLYMOUTH					99,150,482
GCI89023	CHRYSLER					97,99
GCI89024	CHRYSLER					97,98
GCI89026	CHRYSLER/DODGE/PLYMOUTH					98,99,150,151,482
GCI10001	PEUGEOT					445
GCI10003	PEUGEOT					456
GCI10004	PEUGEOT					456
GCI10005	PEUGEOT					433
GCI10006	CITROEN					130
GCI10020	PEUGEOT					445
GCI10027	PEUGEOT					479
GCI10037	PEUGEOT					479
GCI10038	CITROEN/CITROEN LCV/ FIAT/FIAT LCV/ PEUGEOT/PEUGEOT LCV	46308391/46308487/46308498/ 1349786080/71771441	304608	24292		121,129,138,170,171, 194,466,467,482
GCI10041	CITROEN/FIAT/PEUGEOT					116,117,118,120,186 ,461,462,476,477
GCI10043	CITROEN					116,117
GCI10057	CITROEN/PEUGEOT					108,112,119,120,433, 439,440,441,442,449, 450,451,452,463
GCI10058	CITROEN/PEUGEOT					112,120,441,442,449, 450,451,452,463
GCI10081	PEUGEOT					479
GCI10090	CITROEN					115
GCI10091	PEUGEOT					441,442,450,451,453, 463
GCI10092	CITROEN/PEUGEOT					106,108,433
GCI10093	PEUGEOT					438
GCI12001	DAEWOO	96273572/96396135				143,144
GCI12002	DAEWOO					141,142
GCI12003	DAEWOO	96349956				142
GCI12004	CHEVROLET					95,96
GCI12005	DAEWOO					143
GCI12006	DAEWOO	96245288				143
GCI12009	CHEVROLET/DAEWOO/OPEL	93743419/4804594				92,93,94,144,385
GCI14001	DAIHATSU					144,148
GCI14004	DAIHATSU					147
GCI14005	DAIHATSU					146,147
GCI14007	DAIHATSU					144
GCI14008	DAIHATSU					149
GCI14009	DAIHATSU					144
GCI15003	PLYMOUTH					482
GCI15005	MITSUBISHI					348
GCI15006	DODGE/MITSUBISHI					151,341
GCI15010	DODGE					150
GCI16003	CHRYSLER					98



G-AP Ref.	MAKE	ADAPTABLE TO OE	GKN	SPIDAN	METELLI	PAGE
GCI16004	JEEP					280
GCI16005	JEEP					279,280
GCI17001	FIAT/FIAT LCV/LANCIA					152,180,195,294,295
GCI17004	FIAT					188,189
GCI17005	ALFA ROMEO/FIAT/LANCIA					1,2,4,11,153,154,155, 177,188,189,291,292 ,293,294
GCI17006	ALFA ROMEO/FIAT/LANCIA					1,2,3,4,11,153,154,157 ,177,188,292,293
GCI17007	ALFA ROMEO					6,7,11,13
GCI17008	ALFA ROMEO					6,7,11,13
GCI17011	FIAT/FIAT LCV/LANCIA	55197729				152,176,180,182,183 ,195,292,295
GCI17012	FIAT/FIAT LCV/LANCIA	55197730				176,182,183,184,195, 292,295
GCI17013	FIAT					188,189
GCI17014	FIAT					188,189
GCI17015	FIAT/FIAT LCV/LANCIA	46307543				152,157,158,159,176 ,179,183,193,194,195, 292,295
GCI17016	LANCIA					295
GCI17018	FIAT					157,158,177,179,187, 189,193
GCI17020	CITROEN/FIAT/PEUGEOT	46308336/46308500	304605	24289		120,121,129,170,171 ,175,466,467,476
GCI17021	CITROEN/CITROEN LCV/ FIAT/FIAT LCV/PEUGEOT/ PEUGEOT LCV	1349787080/1355333080/46308316/ 46308488/46308502	304610	24294		122,129,138,139,171, 172,194,467,482
GCI17022	CITROEN/FIAT/PEUGEOT	1349790080/1355334080/1357488080/ 46308315/46308488/46308501	304609	24293		122,129,171,467
GCI17025	ALFA ROMEO/FIAT/FIAT LCV	55207525				12,157,159,176,177, 183,194
GCI17026	ALFA ROMEO/FIAT/FIAT LCV	55209968				12,157,159,176,177, 182,183,194
GCI17027	FIAT/FIAT LCV/LANCIA	46307884/55182803				152,153,154,157,158, 159,176,177,178,179, 180,181,182,183, 184,188,194,195,292, 295
GCI17028	CITROEN/CITROEN LCV/ FIAT/FIAT LCV/PEUGEOT/ PEUGEOT LCV	55700559/1349788080/46308335/46308488/ 46308499/71771442	304603	24287		120,121,129,138,170 ,171,175,194,466,467 ,476,482
GCI17029	CITROEN/PEUGEOT					121,466
GCI17030	CITROEN/PEUGEOT					121,466
GCI17031	ALFA ROMEO/FIAT/ FIAT LCV/LANCIA	55221323				5,6,11,12,154,157, 159,175,176,177,183, 194,291
GCI17035	ALFA ROMEO/FIAT/LANCIA					4,5,10,153,154 ,156,157,291
GCI17036	FIAT					156,157
GCI17038	FIAT					177,178
GCI17042	CITROEN/CITROEN LCV/ FIAT/FIAT LCV/PEUGEOT/ PEUGEOT LCV	46308399/46308497/71771311/1349789080	304606	24290		121,122,129,138,170 ,171,194,466,467,482
GCI17043	FIAT					157
GCI17048	ALFA ROMEO/LANCIA					7,294
GCI17055	ALFA ROMEO					4,6
GCI17056	ALFA ROMEO/FIAT/FIAT LCV					12,176,183,194,195
GCI17058	FIAT/LANCIA					153,154,291
GCI17059	FIAT/FIAT LCV					175,184,194,195
GCI17062	FIAT/LANCIA					177,183,293
GCI17069	ALFA ROMEO/LANCIA					7,294
GCI17075	ALFA ROMEO					5,6
GCI17076	ALFA ROMEO/LANCIA					7,294
GCI17103	ALFA ROMEO/FIAT					12,182
GCI18001	FORD	153120188003/72GG4635BA/92333203200	301142/302238	20439/21561		197,216,217,218,234
GCI18002	FORD	6073690/77TT3K177EB/6073691	302207	21752	16-1007	198,199,201,230
GCI18004	MAZDA					303
GCI18005	MAZDA					309,319,320
GCI18006	MAZDA/MERCURY					303,318,319,320,336
GCI18007	FORD					201
GCI18008	FORD					201
GCI18009	FORD/MAZDA					220,303,320
GCI18010	FORD					235

G-AP Ref.	MAKE	ADAPTABLE TO OE	GKN	SPIDAN	METELLI	PAGE
GCI18012	MAZDA					315
GCI18015	KIA					286
GCI18018	VOLKSWAGEN	337498103/337407331A				717
GCI18019	VOLKSWAGEN	ZBA407331/ZBC407331A				700
GCI18021	FORD					235
GCI18022	FORD	1S653B418AA/XS463B418DA				219
GCI18037	FORD	F87A3K183B				201,231
GCI18039	FORD/KIA/MAZDA/MERCURY					195,198,285,320,336
GCI18041	FORD					200
GCI18044	FORD	XS4C3B418EB/1451974/36001360				204
GCI18045	FORD	C9120B071000/XS4C3C092BA/1552939				204
GCI18047	FORD					202
GCI18054	FORD					235
GCI18068	FORD/MERCURY					198,200,336
GCI18070	FIAT/LANCIA/SEAT	42601388/42601892	302252	21241	16-1002	155,156,175,184,190,191,192,290,291,293,294,564
GCI18072	FORD	96FG3B418CA				201,219
GCI18086	FORD					206
GCI18087	FORD					197,202,206,231
GCI18100	FIAT	55214684				157,158
GCI18120	FORD					236,237,238,239,240
GCI18124	FORD					205,206
GCI18126	FORD					204,205
GCI18128	FORD	1446283				213,214,215,216,221,227,228,229,230,232,233,234
GCI18129	FORD/VOLVO					213,214,215,216,228,229,230,232,233,234,753
GCI18167	DODGE					150
GCI18168	FORD/VOLVO					195,205,206,207,208,209,210,740,743,749
GCI18172	FORD					205
GCI18173	FORD					236,237,238,239,240
GCI18174	LDV					300,301
GCI18179	JAGUAR					275
GCI18180	FORD					238,239
GCI18181	FORD					238,239
GCI18182	FORD					204,205
GCI19001	TOYOTA	4304702030				611,617
GCI21007	GM					241,243
GCI21009	GM					241
GCI21011	FIAT/OPEL/SAAB/VAUXHALL					157,388,393,398,423,424,431,542,628,629,632,656,661
GCI21014	GM/OPEL/VAUXHALL					242,243,390,391,392,393,394,395,396,397,398,399,400,416,423,424,425,431,432,628,629,633,635,636,637,638,639,651,655,656,660,661
GCI21016	ALFA ROMEO/FIAT/LANCIA					4,6,7,11,13,157,294
GCI21017	ALFA ROMEO/FIAT/LANCIA					5,6,7,10,11,13,153,154,291
GCI21034	OPEL/VAUXHALL					402,403,406,416,645,647,651
GCI23001	ISUZU					275
GCI23002	HONDA					244,258
GCI23004	HONDA					246,248,250,256
GCI23005	HONDA					252,253
GCI23008	ACURA/HONDA					1,248
GCI23009	HONDA					255
GCI23010	HONDA					249
GCI23011	HONDA					253
GCI23012	HONDA					259
GCI23013	HONDA	44310S9A305				253,255
GCI23014	HONDA					253

G-AP Ref.	MAKE	ADAPTABLE TO OE	GKN	SPIDAN	METELLI	PAGE
GCI23017	HONDA	44310S10310				245,249,254,260
GCI23018	HONDA	44310S5A300				248
GCI23019	HONDA					260
GCI23020	HONDA	44010SO4010/44310SO4300				248
GCI23021	HONDA	44011SO4010/44310SO4900				248
GCI23023	HONDA	44310S10901/44310TL1305				249,254
GCI23046	HONDA	42330S9A305				245,255,256,258
GCI23069	HONDA	42320-S0E-300				247,248,260
GCI24001	HYUNDAI/KIA	4950538E00/4950038442				273,274,282
GCI24002	HYUNDAI					264
GCI24003	MITSUBISHI	MB297538				355
GCI24008	HYUNDAI/KIA	4950538C00				272,283
GCI24009	HYUNDAI	4950522A00				261,262,263,266
GCI24010	HYUNDAI	4950525B00/495001C302				261,275
GCI24013	HYUNDAI					262
GCI24014	HYUNDAI					262
GCI24016	HYUNDAI					270
GCI24019	KIA	4950007000				283
GCI24022	HYUNDAI					272
GCI24030	HYUNDAI/KIA	495002E550/495052EA00				274,275,287,288
GCI24031	HYUNDAI					262,266
GCI24032	HYUNDAI					265,269
GCI24039	KIA	495921H010				281,282,284
GCI24042	MITSUBISHI					344
GCI24044	HYUNDAI					274
GCI24048	HYUNDAI					267
GCI24049	HYUNDAI					265,269
GCI24054	HYUNDAI	495012P250				271
GCI24056	HYUNDAI					264,268,273
GCI24058	KIA	495012P000				286
GCI24061	HYUNDAI					265,268
GCI24065	HYUNDAI					265,267
GCI24066	HYUNDAI	495052PA20				271
GCI24094	HYUNDAI/KIA					271,272,286
GCI24097	HYUNDAI					268
GCI24098	HYUNDAI					268
GCI26001	HOLDEN/HONDA/ISUZU					244,258,275
GCI26002	HOLDEN/HONDA/ISUZU					244,258,275
GCI26003	HOLDEN/ISUZU					244,275
GCI26004	ISUZU					275
GCI26005	ISUZU					275
GCI27001	KIA					282,283
GCI27002	KIA					281
GCI27003	KIA					280,281
GCI27004	KIA					287
GCI27006	FORD					234
GCI27007	KIA					285
GCI27008	FORD/KIA					201,284
GCI27013	KIA					281
GCI27014	KIA					281
GCI27015	KIA					286,287
GCI27016	KIA					287
GCI27018	KIA	495921F200				280
GCI27019	HYUNDAI					268
GCI27020	KIA					281
GCI27023	KIA					281
GCI27033	KIA					281,285
GCI27034	KIA					281
GCI27036	KIA					281,285
GCI27037	HYUNDAI					267
GCI27038	KIA					284
GCI27043	HYUNDAI					261
GCI28001	LADA	21082215056	301181/302315	20819	16-1028	289,290
GCI28003	LADA	21212215055/21212215057				289
GCI28004	LADA	21212215054/21212215056				289
GCI28005	LADA					289
GCI28006	LADA	21232215057				289
GCI28007	LADA	21232215056				289
GCI30001	LAND ROVER					297
GCI31001	TOYOTA					606
GCI31004	TOYOTA					607
GCI34001	MAZDA					303
GCI34002	MAZDA					309,319,320
GCI34003	MAZDA					309
GCI34004	MAZDA					309



G-AP Ref.	MAKE	ADAPTABLE TO OE	GKN	SPIDAN	METELLI	PAGE
GCI34005	MAZDA					312
GCI34006	MAZDA					312
GCI34007	MAZDA	F03725600/F03725600A/F03725600C				318
GCI34008	FORD/KIA	0K2N122520/KK38825600				197,285
GCI34009	MAZDA					319,320
GCI34010	FORD					220
GCI34011	FORD/MAZDA					232,314
GCI34012	MAZDA					319,320
GCI34013	MAZDA	GG0922520C				309
GCI34017	MAZDA					317
GCI34018	FORD/MAZDA					232,314
GCI34019	FORD/MAZDA					232,314
GCI34022	MAZDA	FA5122520/FA8125500A				303
GCI34027	MAZDA	FA6022620				303
GCI34028	MAZDA					317
GCI34029	MAZDA					306
GCI34032	FORD	G56822620	302875			234
GCI34033	MAZDA	G56822520				309,320
GCI34036	MAZDA					309,320
GCI34037	KIA					287
GCI34049	MAZDA	GG2822620A				303,306,314
GCI34071	FORD/MAZDA					220,321
GCI34075	KIA					281,285
GCI34112	LDV					300,301
GCI35001	MERCEDES BENZ	6383342334	303540	21727	16-1030	333,334
GCI35003	MERCEDES BENZ	1243508810				321,329
GCI35004	MERCEDES BENZ					331
GCI35006	MERCEDES BENZ	2013500813	302271	22701		329
GCI35007	JAGUAR					275,278
GCI35009	VOLVO					748,754
GCI35010	MERCEDES BENZ					326,333
GCI35011	MERCEDES BENZ					322,323,324,325,326,327,328
GCI35012	MERCEDES BENZ					323,324,325,326,327,328
GCI35013	MERCEDES BENZ					322,326,333
GCI35014	MERCEDES BENZ	1693602972/1693604372/A1693602972/A1693604372	304832	24559		323,324,325,326,327,328
GCI35015	MERCEDES BENZ					324
GCI35020	MERCEDES BENZ	9013300001/A9013300001	304904	24633		332
GCI35024	MERCEDES BENZ					322,323,324,325,326,327,328
GCI35039	MERCEDES BENZ					330,331
GCI35040	MERCEDES BENZ					322,323,324,325,326,327,328
GCI35044	MERCEDES BENZ					329
GCI35051	AUDI/VOLKSWAGEN	7L0598103A/7L0501331A	304559	24239		73,722,723
GCI38001	MINI					337,338
GCI38002	MINI					337,338
GCI38004	MINI					337
GCI39001	MITSUBISHI/PROTON					345,484
GCI39002	MITSUBISHI	MB176874/MB297927/MB620055				345,350
GCI39003	MITSUBISHI					345
GCI39005	MITSUBISHI	MB196876/MB526892/MB837166/MR196876				350,354
GCI39009	MITSUBISHI					348
GCI39010	MITSUBISHI					345
GCI39013	MITSUBISHI					345
GCI39023	MITSUBISHI	MR276445/MR331245				350
GCI39025	MITSUBISHI					348,350
GCI39027	MITSUBISHI					345
GCI39028	MITSUBISHI	MB399348/MR399351				345
GCI39029	MITSUBISHI	MR222052				348
GCI39036	MITSUBISHI	3815A184				347,348
GCI39037	MITSUBISHI	3815A183				342,347
GCI39044	DODGE/MITSUBISHI					151,351,353
GCI39045	MITSUBISHI					352
GCI39052	HYUNDAI/KIA	495361R001/495001R000				263,268,272,284
GCI39057	MITSUBISHI	MR980002/MN147089				343,347,348,350
GCI39063	HYUNDAI/KIA					274,275,287,288
GCI39074	MITSUBISHI					348
GCI39075	HYUNDAI					271
GCI41001	NISSAN	3971102A05/3971202A25				377
GCI41002	NISSAN					363,368,375,378
GCI41003	NISSAN					371,374

G-AP Ref.	MAKE	ADAPTABLE TO OE	GKN	SPIDAN	METELLI	PAGE
GCI41007	NISSAN					383,384
GCI41008	INFINITI/NISSAN					275,357,364
GCI41013	INFINITI/NISSAN					275,370
GCI41014	INFINITI/NISSAN					275,368,369,384
GCI41015	NISSAN					382
GCI41016	NISSAN					382
GCI41028	NISSAN					377,382
GCI41032	NISSAN	39710F4605				382
GCI41034	NISSAN					382
GCI41037	NISSAN					377
GCI41038	NISSAN	39710F4269				383
GCI41045	NISSAN					365
GCI41076	NISSAN					377
GCI41090	NISSAN					356
GCI41102	NISSAN					364,366,367
GCI41108	NISSAN	39711-JD24C/39101-JG04C/39711JG34C				377,384
GCI41110	NISSAN					357
GCI41117	NISSAN	39720ET028				382
GCI41122	NISSAN					383
GCI41124	NISSAN	391208H315				383
GCI41131	NISSAN/RENAULT					377,506
GCI41132	NISSAN					372
GCI41142	NISSAN					367
GCI41143	NISSAN					367
GCI41144	NISSAN					372,373
GCI41157	NISSAN	39771-JD02B				376,377
GCI44001	OPEL/VAUXHALL	0374099/374099/0374100/374100/ 90142329/90199039	301124/302228	21467	16-1006	386,411,412,413,414 ,415,628,630,641
GCI44002	OPEL/SAAB/VAUXHALL	374048/374118/374148/374195/9317340/ 93173430/0374195/90278734/374067/ 0374118	301144/302253	21476/21457		386,387,388,389,401 ,410,411,412,413,414, 415,420,421,422,423, 545,628,630,631,632 ,633,640,641,642,643, 644
GCI44003	OPEL/VAUXHALL	374091/7839614/374378			16-1026	387,402,404,420,655
GCI44004	OPEL/VAUXHALL	0374013/374013/374027/0374027/90095159/ 199051483	301123/302227	21451	16-0008/16-1008	386,387,388,389,390, 404,410,411,412,413 ,414,415,420,422,628, 630,631,632,639,641, 642,643,646,653,654, 655
GCI44005	OPEL/SAAB/VAUXHALL	374130/4242328/90304156/1603272/0374130	302254	21498		401,421,422,423,545, 640,642,643,644
GCI44006	DAEWOO					144
GCI44007	OPEL	1603236				401,426,427
GCI44008	OPEL/VAUXHALL	1603269				394,395,396,397,398, 635,636,637,638,640
GCI44009	OPEL/VAUXHALL	374446/0374446/93170397/1603409				405,406,416,420,646 ,647,648,649,651,655
GCI44010	OPEL					404
GCI44011	OPEL/VAUXHALL					394,395,396,398,432 ,636,637,640,662
GCI44012	OPEL	1603408/93190190				407
GCI44013	OPEL/VAUXHALL					407,408,647,649
GCI44014	FIAT/FIAT LCV/OPEL/VAUXHALL	1603407/93190189				176,183,194,195,407 ,408,648,649
GCI44015	CHEVROLET/GM					95,242,243
GCI44017	OPEL/VAUXHALL	1603410				407,408,647,649
GCI44018	OPEL/VAUXHALL					390,391,392,431, 634,635,660,661
GCI44022	SSANGYONG					586
GCI44023	SSANGYONG	4130008001				586
GCI45011	CITROEN/PEUGEOT					135,136,436,437
GCI45012	PEUGEOT					436
GCI45016	PEUGEOT					454
GCI45017	CITROEN/PEUGEOT					135,136,137,138,454

G-AP Ref.	MAKE	ADAPTABLE TO OE	GKN	SPIDAN	METELLI	PAGE
GCI45018	CITROEN/PEUGEOT					116,135,136,137, 138,461,462
GCI45019	PEUGEOT					436
GCI45020	CITROEN/PEUGEOT					135,138,442,454, 456,457,459
GCI45021	PEUGEOT					442,454
GCI45031	PEUGEOT					477
GCI48001	PORSCHE	93033203400	301174/302299	21882/21850		483
GCI48002	ALFA ROMEO/ MERCEDES BENZ/ VOLKSWAGEN	414204/90297728/6383341734/91133203001/ 91133292301	301169/302297/ 302303	20394/21490/ 21897	16-1016	12,13,333,334,732,733
GCI48004	ALFA ROMEO/FIAT/ LANCIA/PORSCHE/SEAT	4315132/9936769/60806930/82282139/ 92601388/92601892/95133190100	301129/301136/ 302240/302241/ 302251/302266/ 302277	21311/21327/ 21888/21896/ 23522	16-1002A	2,7,155,156,175,184, 185,189,190,191,192, 193,290,291,293,294, 483,564
GCI50008	DACIA					141
GCI50013	RENAULT					490
GCI50015	RENAULT					491
GCI50019	FORD/SEAT/SKODA/VOLKSWAGEN	4A0407341B/3B0498103B				215,547,582,702,703, 708,719,720
GCI50025	RENAULT					529
GCI50040	RENAULT					500
GCI50045	RENAULT					516
GCI50046	NISSAN/OPEL/RENAULT					367,368,418,516,517
GCI50048	RENAULT					537
GCI50058	DACIA/RENAULT					141,493,494,495,496, 533,536
GCI50059	DACIA/RENAULT					139,484,488,491
GCI50061	FORD					219,220
GCI50079	RENAULT					503,505
GCI50083	FORD					219,220
GCI50084	RENAULT					500
GCI50085	RENAULT					496,502,503,504,505
GCI50086	RENAULT					496,502,503,504,505
GCI50087	RENAULT					511,512,513
GCI50096	RENAULT					500,526,527
GCI50097	OPEL/RENAULT/VAUXHALL					429,430,535,536, 659,660
GCI50098	PEUGEOT					436,437
GCI51005	LAND ROVER					298
GCI51006	ROVER					538,539
GCI51007	LAND ROVER					297,298,299
GCI51012	LAND ROVER					297,298
GCI51021	CITROEN					105
GCI51034	MITSUBISHI	3817A141				348,352
GCI53001	SEAT/VOLKSWAGEN	171407331C/171407331E/171407331L/ 171498103B/171498103D/171498103DV/ 171498103DX/171498350X/1H0407331/ 6N0407331/6N0498103/861498103A/ JZW498350X/861498103AX/6N0498350X/ 6N0498103X	301117/302215/ 302229	20286/22455	16-0003/16-0023 16-1003/16-1023	552,553,554,555, 556,559,668
GCI53002	AUDI/BMW/SEAT/SKODA/ VOLKSWAGEN	377498103E/6X0407331/6X0498103			16-1010C	22,23,24,25,26,27,28 ,29,30,31,74,75,80,548 ,550,551,552,557,558, ,559,560,566,567,569 ,570,572,573,574,575, ,576,577,578,580,581, ,582,583,584,663,664 ,665,666,668,669,670 ,673,674,677,678,679 ,680,681,682,683,684 ,685,686,687,688,690, ,691,692,693,699,700 ,703,704,705,706,709 ,710,711,714,717,721, ,722,725
GCI54002	SKODA/SAFARI		302317	23154		571,754
GCI54003	SKODA	115420171/6U0498103A	302318	23155		571



G-AP Ref.	MAKE	ADAPTABLE TO OE	GKN	SPIDAN	METELLI	PAGE
GCI54004	AUDI/SEAT/SKODA/VOLKSWAGEN	1K0498103E/1K0407271NM				26,27,28,30,549,550,551,552,561,566,574,575,576,577,578,581,668,670,672,683,684,685,686,688,689,690,691,695,704,705,706,710,711,718,725,726
GCI55001	SMART					585,586
GCI56001	SUBARU					592
GCI56002	SUBARU					593
GCI56003	SUBARU					586,590,591
GCI56004	SUBARU					586
GCI56005	SUBARU	28021AC210/28093AC040				590
GCI56006	SUBARU	28021AC130				591
GCI56009	SUBARU					590
GCI56012	SUBARU					586
GCI56013	SUBARU					586,588,589,593
GCI57002	SUZUKI	4410160G00				594,595
GCI57003	SUZUKI					594,598
GCI57005	SUZUKI	4410160G20/4410160G22				595,596
GCI57006	SUZUKI					595
GCI57009	HOLDEN/SUZUKI	4410163B10				244,598,599
GCI57024	SUZUKI					599
GCI57034	SUZUKI	44127M79F01				597
GCI59002	TOYOTA	4341010090/4341010091/4340310010				623,624
GCI59004	TOYOTA					616
GCI59005	TOYOTA	4304032040				603,604,605,611
GCI59006	TOYOTA					606
GCI59007	TOYOTA					606
GCI59009	TOYOTA					607,609,612
GCI59012	TOYOTA					611,622
GCI59014	TOYOTA					601,621,624
GCI59022	TOYOTA					616
GCI59023	TOYOTA					611,625
GCI59024	TOYOTA					606
GCI59025	TOYOTA					606
GCI59026	TOYOTA					606
GCI59027	TOYOTA					616
GCI59033	TOYOTA	4304006040/4342006151				606,623,625
GCI59036	NISSAN	39711EE40A/C97113HC0B				364,366,382
GCI59039	TOYOTA					619
GCI59049	TOYOTA	4343060080/4340360040				619
GCI59069	CITROEN/PEUGEOT/TOYOTA					105,433,605
GCI59070	TOYOTA					604,605
GCI59073	TOYOTA	4304028010/4304028011				601,605,606,615,622,623
GCI59078	TOYOTA	4303044021				601,605,615,622,623
GCI59082	LEXUS	430400W030				301
GCI59092	TOYOTA	434030D061				626
GCI59094	TOYOTA					622
GCI59100	TOYOTA	4304012120				602,611,619,625,626
GCI59140	CITROEN					105
GCI60001	OPEL/VAUXHALL					401,402,403,405,406,407,644,645,646,647,648,649,651,655
GCI60003	OPEL/VAUXHALL					402,403,406,416,645,647,651
GCI61001	VOLKSWAGEN	701498103/701407331A/701498103X/701498350X	301177/302305	20597	16-0019/16-1019	727,728,732,733,734
GCI61002	AUDI/SEAT/SKODA/VOLKSWAGEN	701407331B/701498103A/701498103AX/8E0498103A	302374/302464	22902	16-1024	23,24,74,75,76,560,573,663,664,665,666,677,678,680,681,727,728,729,732,733,734
GCI61003	VOLKSWAGEN	211598101/212501331/251501331/251598101/3015012031/211501331B/251598101X	301137/302255	24915/22407	16-0001/16-1001	727,731,732
GCI61004	VOLKSWAGEN	1H0407331E				674
GCI61005	SEAT/SKODA/VOLKSWAGEN					553,556,567,568,569,676,679,715,716

G-AP Ref.	MAKE	ADAPTABLE TO OE	GKN	SPIDAN	METELLI	PAGE
GCI61006	SEAT/SKODA/VOLKSWAGEN	1J0407341D/1J0407341F/1J0498103K				553,554,556,557,567, 568,569,572,573,663 ,664,665,666,676,677, 678,679,680,681,697, 715,716
GCI61007	AUDI					18,19,20,21,33,71
GCI61011	AUDI/SEAT/SKODA/VOLKSWAGEN	1K0498103C/1K0498103JX				24,25,28,29,549,551 ,561,565,574,575,576 ,577,583,668,669,672 ,682,683,684,685,688 ,690,695,696,703,704 ,709,710,725
GCI61013	VOLKSWAGEN	2374981032				697
GCI61017	VOLKSWAGEN					668,669,670
GCI61020	VOLKSWAGEN	7H0407332P/7H0498104F/7H0498104K/ 7H0498104AK	304837	24564		698,729,734,735 ,736,737
GCI61021	VOLKSWAGEN	7H0407332J/7H0498104G/7H0498104GX/ 7H0498104A/7H0407332	304841	24568		699,730,736,737,738
GCI61022	VOLKSWAGEN					673,674,705,738
GCI61028	FORD/SEAT/VOLKSWAGEN					214,215,546,547, 719,720,721
GCI61029	VOLKSWAGEN/VOLKSWAGEN LCV	7H0498103C/7H0407331E/7H0498103CX/ 7H0407331	304843	24570	16-1031	699,730,736,737,738 ,739,740
GCI61030	VOLKSWAGEN	7D0498103/7D0498331	303999	23626		728,729,733
GCI61032	FORD/SEAT/VOLKSWAGEN					214,547,719,720
GCI61033	AUDI/SEAT/SKODA/VOLKSWAGEN	7M3407332				35,36,37,40,44,46,48, 59,60,61,64,65,66, 546,547,582,583, 702,703,708,709, 719,720
GCI61039	SKODA/VOLKSWAGEN					566,570,580,716
GCI61041	VOLKSWAGEN	7H0407331B/7H0498103	304839	24566		698,729,734,735 ,736,737
GCI61044	AUDI/FORD/SEAT/VOLKSWAGEN	4E0498103/7M3498103H/7M3498103				33,34,35,36,37,38, 39,40,44,45,46,47,48 ,49,50,214,215,546 ,547,548,555, 719,720,721
GCI61048	VOLKSWAGEN	5N0498103A/5N0498103AV				722
GCI61057	AUDI/SEAT/SKODA/VOLKSWAGEN	1J0407363E/1K0498103EX/3B0407341B	305400	25177		25,26,28,29,30,549 ,550,551,552,561,562, 565,566,575,577,578, 581,582,669,670,672 ,683,684,685,686,688 ,689,691,693,695,696, 703,704,705,706,709, 710,711,718,725,726
GCI61062	AUDI/SEAT/SKODA/VOLKSWAGEN					23,24,74,75,553,554 ,557,558,559,560,564, 565,566,567,568,569 ,570,571,572,573,574, 575,580,663,664,665, 666,676,677,678,679 ,680,681,699,700,715, 716
GCI61064	PORSCHE/VOLKSWAGEN					483,484,722,723
GCI61066	PORSCHE/VOLKSWAGEN					483,484,722,723
GCI61070	AUDI					34,35,36,37,38,39,45 ,46,47,48,49
GCI61075	BMW					84,85,86
GCI61076	AUDI					36,38,39,40,47,49,50
GCI62015	VOLVO		301126/302243	20934		741
GCI62028	VOLVO					744,745,746,747,748 ,750,751,752,753
GCI62029	VOLVO					744,745,746,747,750, 751,752,753

G-AP Ref.	MAKE	ADAPTABLE TO OE	GKN	SPIDAN	METELLI	PAGE
GCI62030	VOLVO					741,742,744,745,746 ,747,748,750,751,752 ,753
GCI99001	CITROEN/PEUGEOT					112,448,449,450, 451,452
GCI99008	FIAT/FIAT LCV/LANCIA	46307542				152,157,158,159,175 ,176,179,180,182,183 ,193,194,195,292,295
GCI99019	MITSUBISHI	MN156833				351,352
GCI99023	GM	93230069				241,242,243
GCI99025	DAEWOO	26010773/96489845			16-1029	142
GCI99026	FIAT/GM/OPEL/VAUXHALL	932902609/374402				156,240,241,243,393 ,398,418,425,426,427 ,428,431,628,629,630 ,654,657,658,659,660
GCI99027	GM	93230069				241
GCI99028	DAEWOO					144
GCI99038	TOYOTA	4304005060				602,611,612,615
GCI99045	TOYOTA					619
GCI99050	FORD					235
GCI99052	BMW		301149/302273	20542		77,78,81,82,83,85
GCI99053	FORD/SEAT/VOLKSWAGEN					214,215,546,547,719, 720,721
GCI99057	VOLKSWAGEN					673
GCI99059	CHRYSLER/DODGE					99,150
GCI99062	CHRYSLER/DODGE					97,150
GCI99072	FORD					219
GCI99075	FORD	6069108/6069109/ 81TT3K177AA/81TT3K177AB	302307	21761		198,199,230,231
GCI99083	MITSUBISHI					342,348
GCI99089	BYD					92
GCI99099	SUZUKI		302644/302702/ 302721	21084/21085		599
GCI99100	CHEVROLET					96
GCI99107	CHEVROLET	96391556				94
GCI99108	GM					241
GCI99109	VOLVO					743,744,745,746,750, 751,752,753,754
GCI99113	MAZDA	GG0922620C				309
GCI99127	GM	92225296/93225296				243
GCI99130	FIAT/LANCIA					189,292
GCI99136	MERCEDES BENZ					322,323,326,327,328
GCI99138	OPEL/SAAB/VAUXHALL					419,426,427,428,429, 541,543,544,654,655 ,656,657,658,659
GCI99146	JAGUAR					275,278
GCI99147	JAGUAR					275,278
GCI99148	AUDI/VOLKSWAGEN	95534990200/95534990201/7L0407331A/ 7L0498103/7L0498103A/7L0498103AX	304556	24236	16-1033	73,663,722,723,724
GCI99150	RENAULT					522,523
GCI99158	CITROEN/FIAT/PEUGEOT					120,121,185,477
GCI99159	CITROEN/FIAT					121,185
GCI99160	RENAULT					522,523
GCI99169	RENAULT					537
GCI99177	MERCEDES BENZ					333,334,335
GCI99179	NISSAN					372,373
GCI99188	OPEL					390,431
GC081001	HONDA	44306SA5970/44306SA5971/44306SB0010/ 44306SB0040	300992/302085/ 302086	20309/20310	15-1113	246,259
GC081002	HONDA	44305629671/44305692671/44306692671	302080	20304	15-1099	245,259
GC081004	ACURA					1
GC081005	HONDA	44014SP0000/44305SP0953/44011SP0951/ 44306SP0952/44010SP0951/44306SP0953/ 44305SP0952/44305SP0951				257



G-AP Ref.	MAKE	ADAPTABLE TO OE	GKN	SPIDAN	METELLI	PAGE
GC081006	HONDA	44010S10A00/44010S10A10/44010S17J30/ 44010ST7J30/44011S10A00/44011ST7J30/ 44014S0AJ51/44014S10A50/44310S10A00/ 44310S10A10/44310SH3J00/44310SK7J02/ 44310S10A10/44310SL5N00/44310SM4310/ 44310ST7900				255
GC082001	ALFA ROMEO	60589273			15-1183	8,9
GC082002	ALFA ROMEO	46307308/60815250	303270	21149	15-1297	7
GC082003	FIAT	46307032/46307171/60812753	303113/303117	20993/20997	15-1211	177,178
GC082004	ALFA ROMEO	7627971/7652958/7656949/7688157/7692993/ 7750300/60605055/60811033/82486230/76464 02	300913/300919/ 302001/302002/ 302006/302009	21233/21238/ 23830/23838	15-1093/15-1110	12
GC082005	FIAT	46307083/60813096	303112	20992	15-1210	177,178
GC082006	FIAT	46307034/46307169/60812760	303114/303118	20994/20998	15-1212	177,178
GC082008	ALFA ROMEO/FIAT	46307134	303115	20995		3,4,11,155,177, 178,188
GC082009	ALFA ROMEO	60541802/60809609	302025	23839	15-1153	13
GC082011	LANCIA	82489521	302190	23831	15-1152	291,292
GC082012	ALFA ROMEO/FIAT/LANCIA	46307246/60815021	303196/303275	21154	15-0244/15-1244	3,4,178,292
GC082013	ALFA ROMEO	46307299/60815163	303194/303273	21152	15-1300	7,12
GC082014	ALFA ROMEO	46307685	303609	20208	15-1418	1,2
GC082015	ALFA ROMEO	547679/547682/548135/795283 /60504718/60506536	302004	20026	15-1083	8,9,10
GC082017	ALFA ROMEO	7081591/46307309/46307901	303193/303272	21151	15-1245	2
GC082018	FIAT	46307572/46307913/46308205	303914	22203	15-1374	157,158,159
GC082019	ALFA ROMEO/FIAT	60812880	302456	23844	15-1213	2,178
GC082023	ALFA ROMEO	46308266			15-1596	4,5,6,7,10,11,13
GC082024	ALFA ROMEO	46308235/50500529/46308798/46308710	305364	25141	15-1595	4,5,6,7,10,11,13
GC082025	ALFA ROMEO/LANCIA	46308070/60802035/71783876	304811	24538	15-1550	1,2,293
GC082026	ALFA ROMEO	46308276	305366	25143	15-1597	4,5,6
GC083002	AUDI/SEAT/SKODA/ VOLKSWAGEN/ VOLKSWAGEN LCV	1K0407311J/1K0498099B/1KM498099	304329	23691	15-1463	22,24,25,26,27,28,29, 30,31,72,73,74,75,548 ,549,550,551,552,561 ,562,563,565,566,574 ,575,576,577,578,579 ,581,583,584,668,669 ,670,671,672,682,683, 684,685,686,687,688, 689,690,691,692,695 ,696,697,703,704,705 ,706,709,710,711,712 ,718,719,721,722,724 ,725,726,727,739
GC083003	AUDI/VOLKSWAGEN	183498099A/431407311C/431498099B	302193		15-1150	18,73,694
GC083004	AUDI	431407275/431407311A/431498099A/ 431498099AX/431498099E/803407275A/ 803498099A	301047/302149	22778/20271	15-0025/15-1025	13,14,15,16,17 ,18,19,21
GC083005	AUDI	443407305C/443498099E/443498099EX	302155	22572	15-1219	13,14,15,16
GC083006	AUDI	437407305/443407305/431498099D/ 431498099F/431498099DX	301052/302150	20276	15-1127	13,14,15,16,17, 18,19,21
GC083007	VOLKSWAGEN	191598099/377407311/3054073111/ 171407311L/305407311B/305407311C/ 321407311L/321407311M/321498099A/ 321498099B/321498099E/321498099EX/ 321498099F/811498099F/5Z0498099A/ 5X0498099A/811498099E/377498099L	300971/302060/ 304623	22773/24307/ 20260	15-0096/15-1096 15-1653	673
GC083008	AUDI	895407311/893498099E	301027/302128	22543	15-1066	18,19,21
GC083009	AUDI	895407305/893498099G/893498099GX/ 895498099B	301026/302129	22544	15-1122	18,19,20,21,22
GC083012	AUDI	893407305N/893498099M/893498099MX/ 895407305B/895498099A/895498099H/ 8A0498099/8A0498099X	300853/301950	22550	15-0112/15-1112	71
GC083013	AUDI	443407311/443498099D	302181	22560	15-0119/15-1119	13,14,15,16,17
GC083014	AUDI	443407305B/443498099B/443498099BX/ 443498099C/443498099CX/4A0407305E	301075/302182/ 302183	22566/22581	15-1121	13,14,15,16,17,20, 21,58,63,64
GC083015	AUDI	4A0407311C				15

G-AP Ref.	MAKE	ADAPTABLE TO OE	GKN	SPIDAN	METELLI	PAGE
GC083016	AUDI	4A0407305A/4A0407305F/4A0498099B/ 4A0498099C/4A0498099J/895407305A/ 895498099C/895498099D	300855/301952 301953/301954	22541/22552	15-1140/15-1188	15,17,20,21,58,63, 64,72
GC083017	AUDI	441407305B/4A0407305G/4A0407311B/ 4A0498099/4A0498099D/893407305G/ 893498099L/893498099LX/8A0407305F	300857/301957 301960	22591/22639	15-0195/15-1174 15-1195	15,17,20,21,58,63,64, 71,72,76
GC083018	AUDI/SKODA/VOLKSWAGEN	3B0498099A/8D0407305G/8D0498099/ 8D0498099B/8D0498099BX	300841/301955	24910/22681	15-1239	58,59,64,583, 702,708
GC083019	AUDI/SKODA/VOLKSWAGEN	1H0407271GX/3B0498099E/4D0407305B/ 4D0498099/4D0498099A/4D0498099X/ 4D0598099/8D0407305J/8D0498099D/ 8D0498099E/8E0498099A/8E0498099G/ 3B0498099EX/4D0498099AX	300856/301961 301962/304333	24912/22763 22804/23695	15-1267/15-1436 15-1441/15-1641	59,60,61,64,65,66, 67,70,71,582,583, 702,703,708,709
GC083020	AUDI/VOLKSWAGEN	8D0407305H/8D0498099A/8D0498099C	301956	22747	15-1377	51,59,60,65,66, 703,709
GC083021	AUDI/SKODA/VOLKSWAGEN	3B0498099B/3B0498099BX/3B0498099C/ 8D0407305M/3B0498099H/3B0498099CX	303409	24917/21091	15-1381	59,64,582,583, 702,708
GC083022	VOLKSWAGEN	861498099/8614498099/171407311E	302031	20285	15-1035	671,714,715
GC083023	AUDI	893407305C/893498099D	302061	22542	15-1185	18,19
GC083024	AUDI/SEAT/SKODA/VOLKSWAGEN	6Q0407271DA/6Q0407311Q/6Q0498099E/ 6Q0498099EX/6Q0498099B/6QD498099	303557	21587	15-0414/15-1414	22,23,553,554,556 ,557,558,559,566,567 ,568,569,570,580,673, 715,716
GC083026	AUDI	893498099P/893498099PX/8A0407305G	302184	22748	15-1308	51
GC083027	AUDI/SEAT/SKODA/VOLKSWAGEN	6Q0498099/6Q0498099D/6Q0498099DX/ 6R0498099/6R0498099X	303556	21586	15-1397/15-1413	23,553,554,556,557 ,558,566,567,568,569 ,570,579,580,715 ,716,717
GC083029	AUDI	811407305A/811498099A	302153	20295	15-1181	21,71
GC083030	AUDI/SEAT	8E0407305A/8E0498099/8E0498099X				33,34,35,36,37,39,44, 45,46,47,48,49, 554,555
GC083031	AUDI/VOLKSWAGEN	855407311/855498099/ 855498099A/855498099B	301048/302152	20294	15-1128	21,71,700,706
GC083032	AUDI	811407311/811498099/893407311/ 893498099/171407311P/321498099C/ 893498099X/321498099CX	301939/302151	22458/22546	15-0050/15-1050	18,19,21
GC083033	AUDI/SEAT/SKODA/VOLKSWAGEN	150498099/150498099A/1J0498099/ 1J0498099A/1J0498099AX/1J0407311	302941/302961/3	20338/20339	15-1241	23,60,66,559,560 ,564,571,572,573,663 ,664,676,677,679
GC083034	AUDI	893407305/893498099A	300846/301940	22547	15-1111	18,19,21
GC083035	AUDI/SEAT/SKODA/VOLKSWAGEN	1J0407311R/1J0498099E/1J0498099EX	303551	21522	15-1428	23,24,74,75,76,559, 560,564,565,572,573, 663,664,665,666,677 ,678,679,680,681,700
GC083036	AUDI/SEAT/SKODA/VOLKSWAGEN	1H0407311/1H0498099A/1H0498099E/ 1J0407311C/1J0407311D/1J0498099B/ 1J0498099BX/357498099E/357498099EV/ 357498099EX	300905/302024/ 302963	20340/22627	15-1189	23,24,74,75,559,560, 564,565,571,572,573, 574,663,664,665,666, 674,675,676,677,678, 679,680,681,689, 699,700
GC083037	AUDI/SEAT/SKODA/ VOLKSWAGEN/ VOLKSWAGEN LCV	1K0407311G/1K0407311H/1K0407311L/ 1K0498099/1K0498099A/1K0498099C/ 1K0498099E/1K0498099X/1K0498099AX	304327	23689	15-1462/15- 1464/ 15-1467	24,25,26,27,28,29,30, 31,32,74,75,548,549 ,550,551,560,561,562 ,563,564,565,574,575, 576,577,579,580,581, 583,668,669,670,672, 682,683,684,685,686, 687,688,689,690,691 ,692,694,695,696,697 ,703,704,709,710,711 ,712,717,719,722,724 ,725,726,727,739
GC083038	AUDI/VOLKSWAGEN	321498099/823407313/ 171407311D/ZBA407311	302059	20257	15-1049	17,18,700,707
GC083045	AUDI/AUDI FAW/SKODA/ VOLKSWAGEN					43,44,58,59,64,76,583 ,700,702,708
GC083049	AUDI/AUDI FAW/VOLKSWAGEN					33,44,51,59,60,61,65 ,66,76,703,709
GC083050	SKODA/VOLKSWAGEN					582,583,702,708

G-AP Ref.	MAKE	ADAPTABLE TO OE	GKN	SPIDAN	METELLI	PAGE
GC083051	AUDI	893407311D/893498099B/ 893498099F/893498099H	300850/301951	22551	15-1091	18,19,20,21,22,71
GC083055	AUDI					58
GC083056	AUDI					15,17,76
GC083058	AUDI	8E0407305A/8E0498099/8E0498099D/ 8E0498099DX/8E0498099X	304331	23693	15-1435	33,34,35,36,37,38,39, 40,44,45,46,47,48,49, 59,64
GC083064	AUDI/SKODA					68,69,580
GC083067	AUDI/SEAT	8E0407305B/8E0498099C	304335	23697	15-1554	33,34,35,36,37,38,39 ,40,45,46,47,48,49 ,50,554,555
GC083069	AUDI/SEAT					33,34,35,36,37,38,39 ,40,41,45,46,47,48,49 ,50,554,555
GC083070	AUDI/VOLKSWAGEN	1J0498099F				23,673,674
GC083077	AUDI	4F0498099A	304952	24681	15-1552	61,62,67,68,69,70,71, 72
GC083078	AUDI/SEAT	8E0498099E			15-1551	33,34,35,36,37,38,39, 40,45,46,47,48,49,50 ,52,53,554,555,556 ,557
GC083085	AUDI/VOLKSWAGEN	7L6407321E/7L6498099A/ 7L6498099B/7L6498099C	304735	24462		73,723
GC083086	AUDI	8K0407305C/8K0498099B/8K0498099BX	304956	24685	15-1697	41,42,43,44,50,51,52 ,54,55,56,57,72
GC083087	AUDI	8K0407305F/8K0498099C/8K0498099D /8K0407305D/8K0498099/8K0498099X	304958/304954	24683/24687	15-1688	41,42,43,44,50,51,52 ,53,54,55,56,57,63,68, 69,72,73
GC083088	AUDI	8K0407305E/8K0498099A/8K0498099AX	304962	24691	15-1689	42,43,51,52,54,56 ,57,70
GC083092	AUDI/SEAT	8E0498099A/8E0498099E/8E0498099G/ 4D0407305B	305119	24860		33,34,35,36,37,38, 39,40,44,45,46,47, 48,49,555
GC083095	SEAT/VOLKSWAGEN					546,721
GC083099	AUDI/FIAT/VOLKSWAGEN					61,62,63,67,68,70 ,176,712
GC083100	AUDI/HAWTAI/SEAT/ SKODA/VOLKSWAGEN					24,27,28,31,32,33,244 ,549,551,561,562,563 ,564,574,576,578,579 ,581,582,583,584,668 ,669,681,682,683,684 ,688,689,690,692,693, 694,701,703,704,707, 709,710,717,726
GC083101	AUDI/SEAT/SKODA/VOLKSWAGEN					31,32,33,562,563,564 ,578,579,693,694
GC083102	AUDI					41,42,43,51,52,54,55, 56,57,58,70
GC083103	AUDI					41,42,43,44,50,51,52 ,53,54,55,56,57,58,63 ,68,69,70
GC083106	AUDI	443498099F/447498099	302203	22568	15-1277	14,16,17
GC083107	AUDI					42,43,44,51,54,55 ,57,72
GC083109	AUDI					41,42,50,51,54
GC083116	AUDI/SKODA/VOLKSWAGEN					24,28,574,576,583, 682,685,688,695
GC084001	FIAT	4087120/4247399/4308412/4308413/4308418/ 4313087/4328468/4465504/4475837/5944689/ 5944690/5959385/5998706/7076344/7643642/ 06X039481190/SE025141514B/5998669	300946/300948/ 302035/302038	21105/21250/ 21255	15-1001/15-1019	180,181
GC085001	BMW	31607505005/31607505006/ 31607586433/31607565313			15-1630	88,89
GC085002	BMW					79,82
GC085004	LAND ROVER					299
GC085006	BMW	31607545126				89,90,91
GC085007	MERCEDES BENZ					328,329,331
GC085008	MINI					337,338,339,340
GC085009	MINI	31607589767/31607589768/ 31604853486/31604853485			15-1664	338,339,340
GC085010	BMW	31603450566/31607529201/ 31607529202/31603450565			15-1725	86,87,88



G-AP Ref.	MAKE	ADAPTABLE TO OE	GKN	SPIDAN	METELLI	PAGE
GC085016	MINI					337,338
GC086001	BUICK/CHEVROLET/PONTIAC				15-1344	91,92,93,482
GC086002	BUICK/CHEVROLET/ OLDSMOBILE/PONTIAC	26008330/26020959/26030481				92,95,384,482
GC086003	GM					240
GC086011	BUICK/CHEVROLET/ OLDSMOBILE/PONTIAC	26000690/26008329				92,95,384,482
GC088002	DAEWOO	96257803/96298465/96298466/ 96243574/96243571	303892	21824	15-1401	142
GC088004	SUZUKI	4410178010/4410178012/4410182020/ 4410182021/4410182313/4410182611/ 4410186041/4410278011/4410278012/ 4410282020/4410282021/4410282313 /4410282611/4410286041/4411578010 /4411582611/4410160DDO	300936/302027	21080	15-1068/15-1080	598
GC088005	BUICK/CADILLAC/ CHEVROLET/GMC/ OLDSMOBILE	7835070/7845070				92,96,243,384
GC088006	CHEVROLET/GMC					92,94,243,244
GC088007	BUICK/CADILLAC/CHEVROLET					92,96
GC088008	CADILLAC	7837075/7842037/7843919/7845024			15-1235	92
GC088009	CHEVROLET/GMC					93,96,243,244
GC088011	BUICK/CHEVROLET/GEO/ GMC/OLDSMOBILE					92,96,240,243,384
GC088015	CHEVROLET/ISUZU					96,275
GC088016	CHEVROLET					92
GC088018	CHEVROLET / GEO/SUZUKI					97,599
GC088019	CHEVROLET/DAEWOO	96273760			15-1656	95,96,143
GC088021	CHEVROLET/DAEWOO	96348790/96348791/96391550/96391551	303900	21865	15-1530	92,93,94,95,142
GC088022	CHRYSLER/DODGE/EAGLE					97,98,150,151
GC088024	CHEVROLET/OLDSMOBILE/ PONTIAC					95,384,482
GC088025	CHEVROLET					92
GC088034	CHEVROLET/DAEWOO	96348782/96348783/96391554/96391555	303898	21847	15-1527	92,94,142
GC088037	CHEVROLET					92,94
GC088038	CHEVROLET					94
GC088047	OPEL/VAUXHALL	374646/13296183			15-1693	394,399,400,629, 638,639
GC088066	CHEVROLET				15-1813	94,96
GC089001	MITSUBISHI	MB526583				342,343,344,345, 350,351,354
GC089002	HYUNDAI/MITSUBISHI	MB297372/MB297373/MB297492/MB526350/ MB526353/MB526377/MB526453/MB526454/ MB526464/MB526533/MB526666/MB526829	302075/302988/ 302989/302990	20353/20354/ 24210	15-1048	270,345,354,355
GC089003	HYUNDAI/MITSUBISHI	4950828E00/MB297438/MB297678/ MB297696/MB297699/MB526473/MB526831	302983	20637	15-1064/15-1162	269,270,345,354,355
GC089004	HYUNDAI/MITSUBISHI	4950721000/4950821000/4950528B01/ 4950724B00/4950821A00/4950828A00/ MB176160/MB176161/MB176463/ MB176464/MB176864/MB176865/ MB176866/MB176867/MB178865/ MB297148/MB297341/MB297343/ MB297344/MB297345/MB297346/ MB297347/MB297348/MB297353/ MB297661/MB297662/MB297874/ MB297999/MB525577/MB526063/ MB526064/MB526066/MB526067/MB526117/ MB526118/MB526443/MB526444/MB526453/ MB526454/MB526490/MB526531/MB526547/ MB526548/MB526581/MB526582/MB526853/ MB526854/MB526860/MB526865/MB526866/ MB526873/MB526897/MB526898/MB526999/ MB620770/4950728A00	300981/302073	21381	15-1026	263,269,270,342,343, 344,345,348,349, 354,355
GC089005	CHRYSLER	4384702/4384734			15-1356	98,99
GC089006	CHRYSLER					97,98
GC089008	CHRYSLER/DODGE/PLYMOUTH					98,150,151,482
GC089009	CHRYSLER					99,100
GC089010	CHRYSLER/DODGE/PLYMOUTH					97,98,150,151,482
GC089011	DODGE					150,151
GC089012	CHRYSLER					97,98,99
GC089013	DODGE/DODGE TRUCK					150,151
GC089014	CHRYSLER					97
GC089016	CHRYSLER/DODGE/EAGLE					97,98,150,151
GC089017	CHRYSLER					97

G-AP Ref.	MAKE	ADAPTABLE TO OE	GKN	SPIDAN	METELLI	PAGE
GC089019	CHRYSLER					98
GC089022	CHRYSLER					98
GC089026	CHRYSLER					97
GC089028	CHRYSLER					99
GC089029	CHRYSLER	4808883/4641883AA/4641883AC			15-1438	100
GC089032	CHRYSLER	05274807AD				99
GC089033	DODGE/PLYMOUTH					150,482
GC089034	CHRYSLER					97
GC089035	CHRYSLER					98
GC089036	CHRYSLER				15-1330	98
GC089037	CHRYSLER					97,99
GC089038	CHRYSLER/DODGE/EAGLE					97,98,150,151
GC089039	CHRYSLER/DODGE					97,150
GC089040	CHRYSLER					98,99
GC089041	CHRYSLER					97
GC089043	CHRYSLER					97,99
GC089045	CHRYSLER					99
GC089049	JEEP					280
GC089051	CHRYSLER					97,98
GC089056	JEEP					279,280
GC010001	CITROEN/PEUGEOT	327317/327318/327320/327321/ 327323/327324/327479/327480/327482/ 327483/327485/327486/95604719	300979/302070	24914/20665	15-1015	103,104,105,454,455
GC010002	CITROEN/PEUGEOT	327202/327209/327210/327211/327212/ 327371/327379/327381/95615878/327202EH	303403/303474	21075/21288	15-1177	136,137,443,444
GC010003	CITROEN/PEUGEOT	95656495/95656595/3272E5/3273E6	303434/303475	21097/21289	15-1175	136,137,443
GC010004	CITROEN/PEUGEOT	327283/96141635/96164213/3273G9	303435	21098	15-1208	132,442,443,444
GC010005	CITROEN/PEUGEOT	3272E4/95643689/3273L5	303430	21093	15-1206	103,104,105,436,453 ,454,455
GC010006	CITROEN/PEUGEOT		303535	21580		133,134,463,464
GC010007	CITROEN/PEUGEOT	95653010/3273K1	303536	21581	15-1179	133,134,463,464
GC010008	CITROEN/PEUGEOT	327235/95653009/3272N0/3273A6/			15-1180	134,135,464,465
GC010009	CITROEN/PEUGEOT	327355/327364/327365/327366/327367/ 327369/327389/95598210/40144980001			15-1063	105,106,132,433 ,435,436
GC010010	CITROEN/FIAT/PEUGEOT	327360/327362/327477/327478/95606802/ 95606803/95606804/95646292 /3273C7/3273N4	301092/302199	21257	15-1020	106,107,172,173,174, 190,477,478,479
GC010011	CITROEN/FIAT/PEUGEOT	1495545080/9566722380/9567582280/ 1496138080/51872271/9567582298	302995/302997	20633	15-1132/15-1236	122,123,124,125,126 ,127,128,129,159,160, 161,162,163,164,165 ,166,167,168,169,170, 467,468,469,470,471 472,473,474,475,476
GC010012	CITROEN/FIAT/PEUGEOT		303099	20987		122,123,124,125,126, 127,128,129,159,160 ,161,162,163,164,165, 166,167,168,169,467 ,468,469,470,471,472, 473,474,475
GC010013	CITROEN/FIAT/PEUGEOT	1495537080/1495541080/9566722180	303096/303098	20986	15-1120	122,123,124,125,126, 127,128,129,159,160, 161,162,163,164,165 ,166,167,168,169,170 ,467,468,469,470,471, 472,473,474,475
GC010014	CITROEN/FIAT/PEUGEOT					131,132,185,187,192 ,465
GC010015	CITROEN/FIAT/LANCIA/PEUGEOT	1481451080/1481452080/9617408188/ 9617408288/9626084088/32729C/3272GY/ 3272RL/32733Q/3273GQ	304816/304818	24543/24545	15-1224/15-1546	119,120,131,132,185 187,192,193,295,296 ,465,476
GC010016	CITROEN/FIAT/PEUGEOT					131,185,186,192, 193,465
GC010017	CITROEN				15-1286	105,106
GC010018	CITROEN/FIAT/LANCIA/PEUGEOT	9621456488	304799	24526	15-1222	119,131,185,186,187 ,192,193,295,465,477
GC010019	CITROEN	3273Z8			15-1281	133
GC010020	CITROEN/PEUGEOT					102,103,135,136,137, 480,481
GC010021	CITROEN/PEUGEOT	3273E1/3273W7	303537	21582	15-1263	133,134,463,464
GC010022	CITROEN	3272FP/3272Y3/3272Z7			15-1302/15-1446	102,135,136,137,138
GC010024	CITROEN/PEUGEOT	96141637/3272C7	303405	21076	15-1176	132,133,443,444

G-AP Ref.	MAKE	ADAPTABLE TO OE	GKN	SPIDAN	METELLI	PAGE
GC010025	CITROEN/PEUGEOT	32725X/3272KY/3272LA/3273AH/ 3273KL/3273KP	303936	22276	15-1456	109,111,438,439,440 ,445,446,447,448
GC010026	CITROEN	3272EN/3272ES/3273ES	303928	22268	15-1407/15-1497 15-1646	107,108,109
GC010027	CITROEN	327298/3272A1/3273J6/3273J9			15-1182	133
GC010028	CITROEN/PEUGEOT	32721X/32728W/3273AC			15-1455	109,110,111,445,446, 447,448
GC010029	CITROEN/PEUGEOT	327260/3272N1			15-1264	134,464,465
GC010034	CITROEN					130
GC010036	PEUGEOT					456
GC010038	CITROEN/PEUGEOT					102,442,454,456,480
GC010042	CITROEN/PEUGEOT					102,103,132,133,454
GC010043	CITROEN	327378/3272F5/3273N2	303407	21077	15-1142	133
GC010047	PEUGEOT					464,465
GC010048	CITROEN	327200/327220				105,106,132
GC010049	CITROEN UTILIT AIRES/PEUGEOT					139,480
GC010050	CITROEN/FIAT/PEUGEOT		302998	20634		122,123,124,125,126 ,127,128,129,159,160, 161,162,163,164,165 ,166,167,168,169,467 ,468,469,470,471,472 ,473,474,475,476
GC010051	PEUGEOT	3272GL/3273GC			15-1470	461,462,465
GC010052	CITROEN/PEUGEOT	3272GE/3272GG/3273EG			15-1469	116,118,461,462,466
GC010053	CITROEN	3272FW/3273EA			15-1561	106
GC010054	CITROEN/PEUGEOT					134,464
GC010056	PEUGEOT					436,437
GC010059	CITROEN/FIAT/PEUGEOT	9619947580/9619947588/9619947680/ 9619947688/9621456388				131,186,192,193,465
GC010061	PEUGEOT					479
GC010065	CITROEN/PEUGEOT					132,138,433
GC010067	CITROEN/PEUGEOT	3272FG/3272KL/3272LE/3272LP/3273KR			15-1585	102,103,108,137,439, 440,441,448,449,450, 451,452,463,480,481
GC010069	CITROEN					106,107,108,109
GC010075	CITROEN		303565	21593		114
GC010076	CITROEN/PEUGEOT	32726W/32739Z			15-1558	135,136,137,480,481
GC010077	CITROEN/PEUGEOT	3272HR/3273HH			15-1498	106,108,109,433
GC010085	CITROEN/PEUGEOT	3272FT/3273CY			15-1496	110,112,445,446, 447,448
GC010086	PEUGEOT		303419	21078		456,457,458,459,460
GC010094	FIAT	46308703				159
GC010095	CITROEN/FIAT/PEUGEOT					120,121,185,477
GC010096	CITROEN	3272EH/3273GZ			15-1553	115
GC010097	CITROEN/PEUGEOT					108,109,111,119,445 ,446,447,448
GC010098	CITROEN/FIAT/PEUGEOT	1497187088/1497188088/3272NP/ 3272NQ/3272SE/3273NP/3273NQ/3273SV			15-1636	116,118,185,186, 476,477
GC010100	PEUGEOT					436
GC010104	CITROEN/FIAT/PEUGEOT					106,172,173,190,477
GC010109	PEUGEOT					477
GC010115	CITROEN					116,117
GC010118	CITROEN				15-1657	110,113
GC010124	CITROEN/FIAT/PEUGEOT	3273NK/3272NK/1497191088/1497192088			15-1767	118,185,476,477
GC010127	PEUGEOT	3272S7/3272S8				457,458,459,460
GC010148	CITROEN/PEUGEOT					108,112,119,120,433 ,439,440,441,442,449
GC010149	PEUGEOT					479
GC010155	CITROEN/DACIA/PEUGEOT	3273TT/3273XR/3272WX/3272TH/ 3272QF/3273QQ			15-1711	120,139,442,448,449 ,450,451,452,453,463 ,481
GC010156	CITROEN	3272TC/3273TR			15-1764	108
GC010158	PEUGEOT					441,442,450,451 ,453,463
GC010159	CITROEN/FIAT/PEUGEOT					116,117,118,120,186, 461,462,476,477
GC012001	DAEWOO	510416/510433/510736/513316/26010774/ 96257802/510736A	303174	21027	15-1311	143
GC012004	DAEWOO	96243576/96251135/96251136/96160618A				141,142,143
GC012005	CHEVROLET	96183138/96183139/96225969/96225970				95
GC012006	DAEWOO	4410478800000/4410578B00000	302984/302985	20351	15-1115	144



G-AP Ref.	MAKE	ADAPTABLE TO OE	GKN	SPIDAN	METELLI	PAGE
GC012008	DAEWOO	510418/96160589/96160590			15-1279	142
GC012009	DAEWOO	96243573				142,143
GC012011	CHEVROLET	96273759			15-1655	95,96
GC012013	DAEWOO					141,142
GC012014	CHEVROLET/DAEWOO					96,143
GC012015	DAEWOO					143
GC012018	DAEWOO	96251183				142,143
GC012019	DAEWOO	510734/513315/26013813/26013831/26073810	302801/302803	21482	15-1234	142,143
GC012020	DAEWOO	96257804/96474834/96474835/ 96481061/96481062			15-1402	142
GC012021	CHEVROLET/DAEWOO	93741015/96273570/96273571/96564144	303339	21189	15-1280	95,143
GC012022	CHEVROLET/DAEWOO					96,143
GC012023	DAEWOO	512292/96245285/96349953/96489832	303908			144
GC012024	DAEWOO					143
GC012027	DAEWOO	510851/93486853/96243575/96256953/ 96256954/96256965/96256966/96257801/ 96298467/96298468/96391014/96486854/ 96489842/96243574/96243571/ 96257853/96257854	303906/303910	21947/22197	15-1395	142,143,144
GC012028	DAEWOO	P96273570				143
GC012030	DAEWOO					141
GC012031	DAEWOO					143,144
GC012034	DAIHATSU	4341087242	302451	24811	15-1340	146,147
GC012042	CHEVROLET/DAEWOO					92,93,95,142
GC012046	CHEVROLET/DAEWOO					95,96,143
GC012049	HYUNDAI					264
GC014001	DAIHATSU	4341087746/4342087746				145,146,149
GC014002	DAIHATSU	4341087402/4342087402	303836	23941		149
GC014003	DAIHATSU	4341087703/4341087706/4342087703/ 4342087706/4347087780	302026	24804	15-1160	145
GC014004	DAIHATSU	4341087604/4341087605/4341087611/ 4342087604/4342087605/4342087611	303976	22957		146,149
GC014005	DAIHATSU	4341087717/4341087718/4341087722/ 4341087725/4341087730/4342087717/ 4342087718/4347087781/4346087F81/ 4347087F81/4347087F82	301968	24807	15-1295	145
GC014006	DAIHATSU	4341087103/4341087104/4341087113/ 4341087114/4341087115/4341087119/ 4341087120/4341087123/4341087126/ 4342087103/4342087104/4342087113/ 4342087114/4342087123/4346087180/ 4346087181/4347087180/4347087181	300894/301990	24805	15-1159	144
GC014007	DAIHATSU	4341087701/4341087702/4342087701/ 4349287701/4349287702/4349387703/ 4349487702	303975	22956		144
GC014008	DAIHATSU	4341087251/4346087682000/4346087295/ 4346087682/4347087294/4347087298/ 4342087523				146
GC014009	DAIHATSU	4341087234/4342087234			15-1359	147
GC014010	DAIHATSU	4341087612/4342087612	303830	23935		146
GC014011	DAIHATSU	4341087401/4342087405/4341087405/ 4342087406				149
GC014012	DAIHATSU	432087727/4340087728/4341087000/ 4341087710/4341087711/4341087726/ 4341087727/4341087731/4341087735/ 4342087000/4342087710/4342087711/ 4342087726/4342087727/4342087731/ 4342087735/4341087732	301967	24806	15-1097	145
GC014013	DAIHATSU	4342087722/4342087725/4342087730/ 4346087F86/4347087F88/4347087F89/ 4342087721	302784	24813	15-1294	145
GC014014	DAIHATSU					145
GC014016	DAIHATSU	4342087728/4342087729				145
GC014017	DAIHATSU	4341087606/4341087608				146,149
GC014019	DAIHATSU					145
GC014020	DAIHATSU	4341087223/4341087225/4341087226/ 4341087242/4342087223/4342087225/ 4342087226	302366/302450	24810	15-1333	147
GC014024	DAIHATSU					146,147
GC014027	DAIHATSU	4341087401/4342087401	303835	23940		149

G-AP Ref.	MAKE	ADAPTABLE TO OE	GKN	SPIDAN	METELLI	PAGE
GC014018	DAIHATSU	4341087253/4341087265/4342087254/ 4341087235/4341087246/4341087247/ 4341087248/4341087249/4341087250/ 4341087252/4341087256/4341087257/ 4341087258/4341087266/4341087267/ 4341087268/4341087269/4341087275/ 4341087276/4342087239/4342087240/ 4342087241/4342087243/4342087246/ 4342087250/4342087255				147,148
GC014029	DAIHATSU					148
GC014030	DAEWOO	96328841/96328842/96481004	303912	22199		142
GC014033	DAIHATSU		303832	23937		145,146
GC014034	DAIHATSU	4346087789/4347087789				149
GC014036	DAIHATSU	4341087222/4341087224/4341087227/ 4342087222/4342087224/4342087227				147
GC014037	DAIHATSU/TOYOTA					149,605
GC014038	DAIHATSU	4341097404/4341097405/4342097403				149,150
GC014039	DAIHATSU					147
GC014040	DAIHATSU					146,149
GC014041	DAIHATSU					147
GC014042	DAIHATSU					147
GC014043	DAIHATSU					149
GC014046	DAIHATSU		303831	23936		145,146
GC014051	DAIHATSU					147
GC014052	DAIHATSU	4341097206/4341097221/4341097502/ 4341097503/4341097505/4342097205/ 4342097214/4342097501/4342097502/ 4342097503				147,148
GC014053	DAIHATSU					147
GC014055	DAIHATSU					149
GC014061	DAIHATSU	4341097205/4341097217/4341097243/ 4341097244/4341097255/4342097204/ 4342097218/4342097221/4341097211				147,148
GC014062	DAIHATSU	4341097403000/4342097402000				146
GC014063	DAIHATSU					149
GC014072	DAIHATSU	4341087790/4341087791/4341087789/ 4341087772/4341087782/4342087773/ 4342087775/4341087786				149
GC014073	DAIHATSU	4341087788/4342087776/4342087778	303833	23938		145,146
GC014074	DAIHATSU		303834	23939		148
GC014077	DAIHATSU	4341097403/4342097402				149
GC014078	DAIHATSU	43410B2060/43410B2061				146
GC014096	DAIHATSU	4342087739/4342087765/4342087766/ 4346087N82/4347087N82				145
GC014098	DAIHATSU					146
GC015002	KIA/MAZDA					286,320
GC015003	MITSUBISHI					343,346,350
GC015005	DODGE					150
GC015009	DODGE					150
GC015010	JEEP					279,280
GC015011	MITSUBISHI	3815A167/3815A168/3815A169/3815A170				348
GC015012	CHRYSLER					97
GC016001	JEEP					280
GC016002	JEEP					279
GC016003	JEEP					279
GC016004	JEEP					280
GC016005	JEEP					279
GC016006	JEEP					279
GC016007	JEEP					279
GC017001	FIAT/LANCIA	7629168/07629168/7629457/7659167/ 7659169/07660834/7771582/92601903/ 7660834	300886/301976/ 301977/301980	20526/21234/ 21235/21329	15-1013/15-1105	153,154,177,178, 294,295

G-AP Ref.	MAKE	ADAPTABLE TO OE	GKN	SPIDAN	METELLI	PAGE
GC017002	FIAT/LANCIA	5929237/5929240/5990430/8236523/ 82301373/82333811/82362521/82362523/ 82362524/82428432/82439756/82440166	300906/301041/ 301997/302141	21290/21307/ 23519	15-1103	155,156,290,293,294
GC017003	FIAT/LANCIA	82413699/82443532	301998/302011	21242	15-1094	155,156,293,294
GC017004	FIAT	5890430/7646401/7652957/7656945/7698900/ 7700010/7750301/60810018/82486231/ 164001704701	300918/302007/ 302008	21232/21239	15-1016/15-1109	153
GC017005	FIAT/LANCIA/SEAT	4390952/7560070/7577041/7599433/7656786/ 06X039534340/SE022141915/SE138141915A	300947/302036	21213/21252	15-1002/15-1055 15-1065	151,175,184,185,189, 190,193,291,293,555
GC017006	FIAT/LANCIA/SEAT	737319/4393155/4393157/7573193/7608632/ 7698632/7703689/82443746/82448780	300883/301974	21258	15-1003	184,185,189,190,193, 291,293,564
GC017007	FIAT/OPEL/VAUXHALL	374471/0374471/374472/374473/374474/ 1603233/9186552/9186553/71740557/ 93173409/51705516/51706611	304380	23798	15-1420	156,157,418,419,425, 426,427,428,429,654 ,656,657,658,659
GC017008	FIAT/LANCIA	46307394			15-1309	153,155,295
GC017009	ALFA ROMEO/FIAT/LANCIA	46307742/46307887/46307924/60802000	303195/303274/ 303608	21153/22212	15-1388/15-1440	4,10,11,188,189,292
GC017010	FIAT	7647244/7647245/7720510/76472452A	300866/301966	21230	15-1067	187
GC017011	FIAT/LANCIA	46307234/60815368	303269	21148	15-1306	155,177,178,292
GC017012	FIAT	7633434/7656944/7750299	301979	20527/21237	15-1032	190,191,192
GC017013	FIAT/LANCIA	82466864	302010	21240	15-1155	155,156,293,294
GC017014	FIAT/LANCIA	46307557/46307889	303189/303268	21147	15-1296	176,177,181,184,
GC017015	FIAT	46307322			15-1358	177,178
GC017016	FIAT	46307406			15-1416	179,180
GC017017	FIAT	7079221/7758266/46307047/46307420	303188/303267	21146	15-1225/15-1240	175,179,187
GC017018	FIAT/LANCIA	82449123/82480859	300915	21227	15-1095	155,156,190,191,192 ,291,293,294
GC017019	FIAT	7078573/46307122	303266	21145	15-1231	175,179,180,187,188
GC017020	FIAT	46307121/80078574	303186/303265	21144	15-1232	175,179,180,187,188
GC017021	FIAT/LANCIA	46307094	302452	21247	15-1226	153,154,291
GC017022	FIAT/LANCIA	46307107/46307108	302453	21248	15-1227	153,154,291
GC017023	FIAT	46307082/60813079	303111	20991	15-1209	177,178
GC017024	FIAT	46307367/71720784/71720785	304900	24629	15-1410	187
GC017026	FIAT/FIAT LCV/FORD	46307886/1546264/46308735	303921	22252	15-1396	152,153,154,159,180 ,181,188,189,195,219
GC017027	FIAT/LANCIA	46308020			15-1458	176,292
GC017028	ALFA ROMEO/CITROEN LCV/ FIAT/FIAT LCV/LANCIA/ PEUGEOT LCV	46307710/46307877/46308067/46308518/ 51787180/51783824/46308524/51808107	303920/304964	22251/24693	15-1449/15-1493	12,139,175,176,177, 182,183,184,188,189 ,194,292,293,295,482
GC017029	FIAT	46307516			15-1409	179,187
GC017030	FIAT/LANCIA	46307914	303607	22213	15-1387	153,154,155,157,158, 159,188,189,291
GC017031	FIAT	46307659/46307906/46308206	303916	22208	15-1419/15-1612	158,159,190
GC017032	FIAT	46307182/46429632/60812755	303116	20996	15-1214	154,178
GC017033	FIAT/LANCIA	82466865			15-1154	155,156,293,294
GC017034	FIAT/OPEL	1603403				182,405
GC017037	FIAT	46307366			15-1481	179,190
GC017039	FIAT/LANCIA	7631082/7659161/46307080	300884/301975/ 301978	21224/21231/ 21236	15-1106	177,178,294,295
GC017042	ALFA ROMEO/FIAT/LANCIA	46307241/0046307241/0046307398/ 46307398/0060515370/60515370/0060815227/ 60815227/0060815370/60815370/463007241	303271	21150	15-0258/15-1258	1,2,3,4,11,12,13,153 ,155,177,178,181,182 ,184,292
GC017043	FIAT/FORD	46308000/1546263	304653	24341	15-1457	151,152,180,219
GC017044	CITROEN/FIAT/LANCIA/PEUGEOT	9645248980			15-1494	117,121,192,293,466
GC017045	CITROEN/FIAT/PEUGEOT	46308371/46308484/1349785080/1349788080/ 3272PG/3273PP/1608505480	304598	24282	15-1726	120,121,129,170,171 ,175,466,467,476
GC017046	FIAT	7077257				191
GC017047	LANCIA					294
GC017048	MINISUBISHI/SMART	4543301101/A4543301101/MR980747/ MR582021/MR582022/MR980748			15-1507	343,585
GC017051	FIAT/OPEL/SAAB/VAUXHALL	374843/1603234/1603275/46308230/ 93173410/93182576	304383/304697	23984/24385	15-1506/ 15-1506A/ 15-1506B	156,157,394,395,396, 397,408,409,410,419 ,426,427,428,429,432, 541,637,638,654,655, 656,657,658,659



G-AP Ref.	MAKE	ADAPTABLE TO OE	GKN	SPIDAN	METELLI	PAGE
GC017052	ALFA ROMEO/FIAT/OPEL/VAUXHALL	1603411/46308337/55700562/93190193	304613	24297	15-1593	12,182,183,407,408,647,648,649
GC017053	FIAT/LANCIA/OPEL/VAUXHALL	1603405/46308322/46308519/93190187/46308707/51854039/51854040	304611/305198	24949/24295	15-1592	176,182,183,295,407,408,647,648,649
GC017054	CITROEN LCV/FIAT LCV/PEUGEOT LCV					138,194,482
GC017055	CITROEN/CITROEN LCV/FIAT/FIAT LCV/PEUGEOT/PEUGEOT LCV	46308369/46308483/71790991/71791000/1349786080/1349789080/3272PA/3272PC/3273PJ/3273PK	304601	24285	15-1717	121,129,138,170,171,194,466,467,482
GC017056	FIAT	46307617			15-1411	179
GC017057	FIAT					188,189
GC017059	FIAT					177
GC017060	CITROEN/CITROEN LCV/FIAT/FIAT LCV/PEUGEOT/PEUGEOT LCV	46308370/46308485/3272PF/3272SS/3273PN/3273PX/1357488080/1355333080/1349790080/1355334080/3272PQ	304600	24284	15-1718	122,129,138,139,171,172,194,467,482
GC017061	CITROEN LCV/FIAT LCV/PEUGEOT LCV					138,139,194,482
GC017063	ALFA ROMEO/FIAT/LANCIA	46308706/46308551/71771179/46308463/46308759/51795511	305152	24893	15-1687	12,153,176,177,182,183,184,291
GC017064	ALFA ROMEO/FIAT/LANCIA					11,153,291
GC017065	ALFA ROMEO/FIAT	71745011			15-1601	12,176,182,183
GC017067	CITROEN/PEUGEOT					121,466
GC017068	CITROEN/PEUGEOT	3272SL/1607735380/1608901980/3273TC			15-1740	121,466
GC017070	ALFA ROMEO/CITROEN/CITROEN LCV/FIAT/FIAT LCV/PEUGEOT/PEUGEOT LCV	46308538/46308552/3273SZ	305150	24891	15-1637/15-1648	12,121,139,175,177,183,184,194,466,482
GC017093	FIAT					179,187,189
GC018001	FORD/MAZDA	1142787/1537377/2S6W3A327AB			15-1429	202,203,212,302
GC018002	FORD	235290201/1S7W3B413DA	303743	21449		226,227
GC018003	FORD	1063496/XS4C3B413AA	303384/303385	20322		202,212
GC018004	FORD/MAZDA	1003550/1078675/240608ENE0265/92AG3K183DA/96AG3K183BB/R98FX3C242BA/97FU4K258CA	300872/302870	20186/23738	15-0192/15-1192	197,202,231,302
GC018005	FORD	1328359/4602016			15-1565	236,237,238,239,240
GC018006	FORD	1078677/6195781/6483685/06483685/92AG3K183BA/92AG3K187BA	300881/301973/302871	20187/23736	15-1125	202,231
GC018007	FORD	1326260/235280201/1S7W3B413AA	303610	21363	15-1640	226,227
GC018009	FORD	1148219/2S6W3B437FC/1539136/C60225600/C20225600C/C20225500C/C20225500A/C20225600A/C60225500A			15-1432/15-1669	202,212
GC018010	FORD	7294547/93BG3B413BE			15-1202	221,222,223,224
GC018011	FORD	1023247/1079583/6757622/7294548/93BG3B413ABB/93BG3B413BB/93BG3B413DE/96BG3B413ABB/93BG3B413DD/R98BX3C242AA	302857/303085	20979	15-0200/15-1200	221,222,223,224,225
GC018012	FORD/MAZDA	1003548/1078670/96AG3K183AB/1689895	302869/302872	20188	15-1283	197,202,219,302
GC018013	FORD	1063498/1129668/1361301/3652045/3652047/3667428/3667429/XS4C3B413BA/1134142/1602947	303332/303333	21184	15-1354	204,205
GC018014	FORD	1142788/1418951/XS614K258BA			15-1430	203,213
GC018015	FORD	1078680/1659059/6168423/6485414/89FG3K187BA/89FG3K187CA/1690331/R98FX3C242EA/	301972	23735	15-1156	197,199,201,202,231
GC018016	FORD	1074308/1117155/98AG3K183BA/98AX3C242DA	303436	21099	15-1364	198
GC018017	FORD	1033616/1078682/6168422/6485412/89FG3K183AA/R98FX3C242FA/1690332	302030	23734	15-1041	198,199,200,201,231
GC018018	FORD	6071774/79TT3K187AA/79TT3K187M/R98AX3C242CA/1690325/1079589	300938/302029	21751	15-1037	198,199,201,230
GC018019	FORD	6069110/6079195/6099110/79TT3K187BA/81AG3K187AA/81AG3K187M	300879/301971/302054	21753/21760	15-1014/15-1092	198,199,201,230,231
GC018020	FORD	BD5M3W427A			15-1233	195,197,231,234
GC018021	FORD	1079587/6485415/92AG3K183M/92AG3K187M	300900/302455	23610	15-0198/15-1198	199,200,231
GC018023	FORD	1023250/1079584/7024787/7024788/96BG3B413AAB/1690328/RE98BX3C242B1A/R98BX3C242BA			15-0201/15-1201	222,223,224,225
GC018024	FORD	1023250/1079584/7024787/7024788/93BG3B413AAB/93BG3B413AB/93BG3B413AE/93BG3B413CE/96BG3B413AB	302856/303084	20978		220,221,222,223,224,225,226

G-AP Ref.	MAKE	ADAPTABLE TO OE	GKN	SPIDAN	METELLI	PAGE
GC018025	FORD/SEAT/VOLKSWAGEN	1111900/7M0407321B/7M0498099A/ 7M0498099AX/95VW3BA413AB/ 95VW3K187BB	303511	21574	15-1444	214,215,546,547,548, 719,720,721
GC018026	FORD/SEAT/VOLKSWAGEN	1007695/1084716/7M0407321A/7M0498099/ 7M0498099V/7M0498099X/7M0498340X/ 95VW3K187BA/R98VW3C242AA/1690336/ JZW498340FX	303509	21572	15-1389	214,215,546,547,548, 719,720
GC018027	MAZDA	F00122540/F00125400/F00125400A/ F00125400B/F00125600A/F00125600B/ F00325400A/F00325400B/F00325600A/ F00325600B/F00525400/F00525400A/ F00525400B/F00525400C/F00525600A/ F00525600B/F00525600C/F00725600A	301016/302111	21370	15-0024/15-1024	302,304,305
GC018028	MAZDA	G05325500/G05325500B/G05325600/ G05325600C/G06325500/G06325500A/ G06325600/G06325600A/G56422510A/ G56422610A/G5642510A/G56425500 G57022510A/G56425600/	302792	24044	15-1291	310,311,312,320
GC018029	MAZDA	G05425500A/G05425600C/G06425500/ G06425500A/G06425600/G06425600A/ G56425500A/G57025600A/G05425600D	302977/302978/ 303851	23956/24051		310,311,312,320,321
GC018030	KIA/MAZDA	B00225400/B00225400B/B00225500/ B00225500B/B0022560/B00225600/ B00225600B/B00325400/B00325400C/ B00325400D/B00325600/B00325600C/ B00325600D/KK33122510/KK33122610/ KK33325400/B00225600A/KK33325600/ B00225600D	300869/302982	20636	15-1171	284,302
GC018031	FORD USA/MAZDA	G03325500/G03325500B/G03325600/ G03325600D/G04325500/G04325500B/ G04325600/G04325600D	302023	24007	15-1059	240,310,311,312,319
GC018032	MAZDA	F00425500A	302787	24046	15-1254	305
GC018033	FORD/KIA/MAZDA	B00525400/B00525400D/B00525600/ B00525600D	302783	24048	15-1261	201,284,302
GC018034	MAZDA	F02422510/F02422510B/F02422510C/ F02422610/F02422610A/F02425400/ F02425400A/F02425400D/F02425400E/ F02425600/F0652560X/F06922610C/ F0692560XC/FA0922510A	303325/303326	21175	15-1141	303,304,305,319
GC018035	KIA	G56022510A/G56025500/G56025500A/ G56025600/G56025600A/G56822510A/ G56822510B/G56825500/G56825500A/ G56825500B/G56825600/G56825600A/ G56825600B/G57225500/G57225600/ G57622510A/G57625500/G57625600/ GD1922510	302763/302788	24047	15-1268	286
GC018036	MAZDA	B00122510A/B00225400A/FA3425400/ FS2122610A	303988	22969		317
GC018037	FORD/MAZDA					231,314
GC018039	FORD/SEAT/VOLKSWAGEN					214,215,546,547,548, 719,720,721
GC018040	FORD/SEAT/VOLKSWAGEN					213,214,546,719
GC018041	FORD/MERCURY					234,336
GC018042	FORD/MERCURY	E3FZ3B413B				198,234,235,336
GC018044	FORD/VOLKSWAGEN	90AU3K183AA				198,240,663
GC018045	FORD/MAZDA					231,309
GC018046	FORD/MERCURY					234,336
GC018047	FORD/MERCURY					234,336
GC018048	FORD/MERCURY					197,336
GC018050	FORD					195
GC018051	FORD					220
GC018052	FORD					220,221,222,223,224
GC018055	MAZDA					320
GC018056	FORD/MERCURY					197,336
GC018057	FORD					201
GC018059	MERCURY				15-1357	336
GC018060	FORD					235
GC018061	FORD					236,237,238,239,240
GC018063	FORD					216,235
GC018067	FORD	1329584/1329586/1501261/4490557/ 4501957/4512587/4515857/2T143B436AG/ 2T143A327AA/2T143A328AAK/4512587K	305346	25123	15-1488/15-1489	235,238
GC018069	FORD	4166906			15-1511	204,205,206

G-AP Ref.	MAKE	ADAPTABLE TO OE	GKN	SPIDAN	METELLI	PAGE
GC018073	MAZDA					312,320
GC018074	FORD/MAZDA					201,305
GC018075	MERCURY/NISSAN					336,377
GC018077	FORD					200,234
GC018078	FORD/MAZDA					231,309
GC018079	FORD/MERCURY					197,336
GC018081	FORD/MERCURY					197,336
GC018085	FORD/LINCOLN/MERCURY					234,301,336
GC018098	FIAT/LANCIA	1485695080/9645249280			15-1495	192,293
GC018099	FORD	KS514K258AA				201,219
GC018100	FORD/VOLKSWAGEN	547407311A				198,240,697,713
GC018103	FORD	551407311				195,197,231,234
GC018105	NISSAN/OPEL/RENAULT/ RENAULT LCV/VAUXHALL	4413397/4430547/8200069147/8200334338/ 8200485589			15-1549	370,429,430,535, 536,537,660
GC018200	LAND ROVER					297,298
GC018203	FORD	1345638/1345637/1345639/1476892/1548224/ 1685799/3M513A327MA/3M514C062FA/ 3M514C062LA	305176	24927	15-1563/15-1777	206,207,208,209,210
GC018204	FORD/MAZDA					220,321
GC018206	FORD/MAZDA					231,315
GC018207	FORD	4512586/4512588/1501263/2T143E327BA		25135	15-1490	235,238
GC018209	RENAULT					522,523
GC018220	FORD LCV					240
GC018222	FORD/LANDWIND	1802807/1837849/1539142			15-1788	195,203,204,211,212,
GC018223	MAZDA					302
GC018225	FORD					197
GC018229	LAND ROVER	TDJ500050				296,299,300
GC018230	FORD	1223723/1359656/1417775/1431359/1474624/ 1493007/3M513A327BB/3M513B436DAC/ 3M513B436DAE/3M513B436DAF/ RM3M513B436DAD	305023	24751	15-1677	195,196,205,206,207, 208,209,210
GC018237	FORD					235
GC018240	FORD					196,211,212,218,219
GC018244	FORD					196,210,211,212,219
GC018245	MAZDA					308
GC018250	AUDI/LAND ROVER					67,299
GC018264	FORD/VOLVO					195,205,206,207,208, 209,210,740,743,749
GC018270	FORD				15-1761	196,211,212,219,220
GC018271	JAGUAR					275
GC019003	SUZUKI					595,597,598
GC021001	CHEVROLET/GEO/TOYOTA	7849841	302758		15-1078	95,96,240,611,614
GC021002	GEO/ISUZU	8941581302/8941581312/8944052272/ 8944052282/8944676690/8944676700/ 8944676710/8944676720	302752/302778	23200	15-1076	240,275
GC021003	GM					241
GC021006	GM					241
GC021007	BUICK/OLDSMOBILE				15-1355	91,384
GC021010	GM	326763				241,243
GC021011	GM					241
GC021017	GM					241
GC021018	BUICK/CHEVROLET/PONTIAC					92,93,482
GC021019	CHEVROLET/GMC					92,94,244
GC021022	CHEVROLET / GEO/GMC					97,243,244
GC021025	GM	93230068				241,242,243
GC021026	GM	93262105				242,243
GC021030	OPEL/SAAB/VAUXHALL	1603291/12793840			15-1599	427,428,541,542, 658,659
GC021031	GM					243
GC021032	GM					242,243
GC021038	OPEL	13296185/13296057/93190460				408,409,410,418, 425,427,428
GC021043	CHEVROLET	93745994/13318006			15-1812	93,94
GC021047	CHEVROLET/DAEWOO/OPEL	93743421				93,144,385
GC022002	ISUZU	8941246280/8941246290	300874/301981	21484		275
GC022004	HOLDEN					244
GC022005	HOLDEN/OPEL/VAUXHALL					244,402,403,406,416 ,645,647,651
GC022009	CHEVROLET/OPEL	93743417/4804592			15-1666	93,385,386
GC023001	HONDA	44014S6FE01	304701	24389	15-1427	253,254
GC023002	ROVER	44305S74E00/44305S74E01/44305S74E51/ GCV1123/TFB000070	303487	21544	15-1399	539,540



G-AP Ref.	MAKE	ADAPTABLE TO OE	GKN	SPIDAN	METELLI	PAGE
GC022001	TOYOTA	4341010150/4341012020/4341012021/ 4341012050/4341012060/4341012080/ 4341012120/4341012122/4341012130/ 4341016050/4341016060/4341016080/ 4341016090/4342010150/4342012020/ 4342012021/4342012030/4342012060/ 4342012082/4342012090/4342016050/ 4342016060/4342016080/4342016090/ 4346019095/4346019096/4347029107/ 4341002020/4341012123/4342012080/ 4342012083	301014/302109	22306	15-1030	609,610,611,612,613, 614,615,616,621,623, 624,625
GC023003	HONDA	44305634003/44305634013/44305634023/ 44305634033/44305671003/44305671023/ 44305689601/44305692003/44306634013/ 44306657000/44306657023/44306659000/ 44306659010/44306671003/44306671033/ 44306689601/44306692003/44305SA0003/ 44306SA0013/44306SA0013/	300984/302077/ 302078	20302/20303	15-1010/15-1011	245,249,250,259,260
GC023004	HONDA	44305688000/44305688020/44306688000/ 44306689020/44305SA5000/44305SA5010/ 44306SA5000/44306SA5010	300988/302081/ 302093	20305/21387	15-1079	245
GC023005	HONDA	44305SA5020/44305SA5620/44305SA5640/ 44305SA5641/44305SB0621/44305SB0622/ 44305SB0623/44305SB0624/44306SA5020/ 44306SA5620/44306SA5640/44306SA5641/ 44306SA5950/44306SA5951/44306SB0621/ 44306SB0622/44306SB0624/44306SB0670/ 44306SB0671	300991/302083/ 302084	20307/20308	15-1071	245
GC023006	HONDA	44305SB2750/44305SB2751/44305SB2960/ 44305SB2961/44305SF4J21/44305SF4J22/ 44305SF4J23/44305SF4J24/44305SF4J40/ 44305SF4J41/44305SF4J42/44306SB2750/ 44306SB2751/44306SB2960/44306SB2961/ 44306SF4J21/44306SF4J22/44306SF4J23	300994/302089/ 302091	20319/20320	15-1044	249,250
GC023007	HONDA/ROVER	44011SK3E00/GVC1069	302049	20892	15-1220	255,538,539,541
GC023008	HONDA/ROVER	44011SK3E10	302050	20893	15-1242	255,538,539,541
GC023010	ROVER	03CGV1053/GVC1053	300958/302047	20890	15-1221	538
GC023011	HONDA	44010SH3981/44010SH3A03/44010SH3G12/ 44011SH3G12/44305SE0000/44305SE0010/ 44305SE0020/44305SE0G01/44305SE0G02/ 44305SE0J00/44305SE0J01/44305SH3960/ 44305SH3961/44305SH3970/44305SH3971/ 44305SH3980/44305SH3981/44305SH3A00/ 44305SH3A01/44305SH3G00/44305SH3G01/ 44305SH3G10/44305SH3G11/44306SE0000/ 44306SE0010/44306SE0020/44306SE0980/ 44306SE0981/44306SE0982/44306SE0G01/ 44306SE0G02/44306SH3960/44306SH3961/ 44306SH3970/44306SH3971/44306SH3980/ 44306SH3981/44306SH3A00/44306SH3A01/ 44306SH3G00/44306SH3G01/44306SH3G10/ 44306SH3G11	300996/302096/ 302458	22348/22360	15-1054	246,250,251
GC023012	HONDA	44014SE0000/44014SE0J51				246,250,251

G-AP Ref.	MAKE	ADAPTABLE TO OE	GKN	SPIDAN	METELLI	PAGE
GC023013	HONDA	44010SL5N01/44010SM4A00/44010SS0000/ 44010SS0010/44010SS0020/44010SS0030/ 44010SS0960/44010SV4000/44010SV4010/ 44010SVA000/44011SL5N01/44011SS0000/ 44011SS0010/44011SS0020/44011SS0030/ 44011SS0940/44011SS0N00/44011SS0N01/ 44011SS0N02/44011SS0N10/44011SV4N00/ 44014SM4020/44014SV4000/44014SV4950/ 44305SF1915/44305SM1000/44305SM1010/ 44305SM4000/44305SM4010/44305SM4020/ 44305SM4030/44305SM4040/44305SM4050/ 44305SM4980/44305SM4981/44305SM4982/ 44305SM4983/44305SM4984/44306SF1916/ 44306SM1000/44306SM1010/44306SM4000/ 44306SM4010/44306SM4020/44306SM4030/ 44306SM4040/44306SM4050/44306SM4060/ 44306SM4980/44306SM4981/44306SM4982/ 44306SM4983/44306SM4984/44310SM4901/ 44310SM4980	302013	22355	15-1131	246,247,259,260
GC023014	HONDA	44010SL4950/44010SL5N02/44010SL5N80/ 44010SL5N82/44010SS0000/44010SS0020/ 44010SS0930/44010SS0980/44010SS0981/ 44010SS0982/44010SS0983/44010SS0J80/ 44010SS0J81/44010SS0J82/44010SS0J83/ 44010SS0J84/44010SV1000/44010SV1010/ 44010SV1950/44010SV1A00/44010SV1A50/ 44010SV1A51/44010SV4950/44010SV4951/ 44010SV4952/44010SV4N60/44010SV4N61/ 44011SL5N80/44011SS0000/44011SS0020/ 44011SS0930/44011SS0980/44011SS0981/ 44011SS0982/44011SS0J82/44011SS0J84/ 44011SS0N60/44011SS0N91/44011SV1A10/ 44011SV1A60/44011SV1N00/44011SV1N01/ 44011SV1N50/44011SV1N51/44011SV4J00/ 44011SV4J50/44011SV4N01/44011SV4N50/ 44305SF1974/44305SF1975/44305SM1950/ 44305SM1951/44305SM1980/44305SM1981/ 44305SM1A80/44305SM1A81/44305SM4950/ 44305SM4951/44305SM4952/44305SM4953/ 44305SM4954/44305SM4955/44305SM4982/ 44305SM4J80/44305SM4J81/44305SM4J82/ 44305SM4J83/44305SM4J84/44306SF1975/ 44306SF1976/44306SF1J71/44306SM1950/ 44306SM1951/44306SM1952/44306SM1980/ 44306SM1981/44306SM1A80/44306SM1A81/ 44306SM4950/44306SM4951/44306SM4952/ 44306SM4953/44306SM4954/44306SM4955/ 44306SM4956/44306SM4982/44306SM4J80/ 44306SM4J81/44306SM4J82/44306SM4J83/ 44306SM4J84/44010SM1952/44010SM4950/ 44010SM4952/44010SM4953/44011SM4000/ 44011SM4010/44011SM4951/44014SF1970/ 44014SM4000/44014SV4010/44014SV4951	302014	22352	15-1131A	246,247,259,260
GC023015	HONDA				245,248,257,259, 260,261	
GC023017	HONDA	44010ST7J50/44014SF1971/44305SF0910/ 44305SF1405/44305SF1970/44305SF1971/ 44305SF1972/44305SF1973/44305SH7J83/ 44305SK7J70/44305SK7J71/44305SK7J72/ 44305SK7J73/44305SK7J74/44305SK7J75/ 44305SK7J81/44305SK7J82/44305SK7J83/ 44305SK7J84/44306SF1405/44306SF1970/ 44306SF1971/44306SF1972/44306SF1973/ 44306SF1974/44306SK7J73/44306SK7J74/ 44306SK7J75/44306SK7J81/44306SK7J82/ 44306SK7J83/44010ST7N10/44010ST7N60/ 44011SR3J55/44310SR3A12	300842/301943	22349	15-1053A	252,253

G-AP Ref.	MAKE	ADAPTABLE TO OE	GKN	SPIDAN	METELLI	PAGE
GC023016	HONDA	44010S07000/44010SR3J01/44010SR3J02/ 44010SR3J03/44010SR3J04/44010SR3J05/ 44010SR3J51/44010SR3J52/44010SR3J53/ 44010SR3J54/44010SR3J55/44010SR7000/ 44010SR7010/44010SR7020/44010SR7030/ 44010SR7040/44010ST7N00/44010ST7N50/ 44011S07000/44011SR3J01/44011SR3J02/ 44011SR3J03/44011SR3J04/44011SR3J50/ 44011SR3J51/44011SR3J52/44011SR3J53/ 44011SR3J54/44011SR7000/44011SR7010/ 44011SR7020/44011SR7030/44011SR7040/ 44011SR7954/44011ST7N00/44011ST7N50/ 44305SF1305/44305SF1910/44305SF1911/ 44305SF1912/44305SF1913/44305SF1914/ 44305SF1G10/44305SF1G11/44305SF1G12/ 44305SF1G13/44305SF1G14/44305SK7J21/ 44305SK7J22/44305SK7J23/44305SK7J24/ 44306SF1305/44306SF1307/44306SF1315/ 44306SF1406/44306SF1910/44306SF1911/ 44306SF1912/44306SF1913/44306SF1914/ 44306SF1G10/44306SF1G11/44306SF1G12/ 44306SF1G13/44306SF1G14/44306SF1G15/ 44306SK7J21/44306SK7J22/44306SK7J23	300847/301941/ 301942	22354/22365	15-1053	246,252,254,256,257, 259,260
GC023018	HONDA	44305SA7000/44306SA7000	300997		15-1072	248
GC023019	HONDA					249,250,256,257, 258,260
GC023020	HONDA/ROVER	44010SH9000/44305SD9013/44305SH9000/ 44305SH9003			15-1260	251,538,539,541
GC023021	HONDA	4306SH3J00/44014SE0930/44305SE0912/ 44305SE0913/44305SE0920/44305SE0921/ 44305SE0922/44305SE0923/44305SE0924/ 44305SE0925/44305SE0G10/44305SE0G11/ 44305SE0G12/44305SE0G13/44305SE0G20/ 44305SE0G21/44305SE0G22/44305SE0G23/ 44305SE0G24/44305SE0G25/44305SE0J20/ 44305SE0J21/44305SE0J22/44305SE0J23/ 44305SE7E01/44306SE0910/44306SE0911/ 44306SE0912/44306SE0913/44306SE0920/ 44306SE0921/44306SE0922/44306SE0923/ 44306SE0924/44306SE0G10/44306SE0G11/ 44306SE0G12/44306SE0G13/44306SE0G20/ 44306SE0G21/44306SE0G22/44306SE0G23/ 44306SE0G24/44306SE0J20/44306SE0J21/ 44306SE0J22/44306SE0J23/44306SE0J24/ 44306SE0J25	300998/302087/ 302088/302094	21388	15-1045/15-1101	246,249,250,251,256
GC023022	HONDA		301986	22353	15-1251	252,254
GC023023	HONDA	44010S04J01/44010SR1003/44010SR3020/ 44010SR3030/44010SR3040/44010SR3901/ 44010SR3902/44010SR3903/44010SR3952/ 44010ST7900/44011S04J01/44011SR3020/ 44011SR3030/44011SR3040/44011SR3901/ 44011SR3902/44011SR3903/44011SR3952/ 44011ST7900	303837	23942	15-1255	252,253,254
GC023024	HONDA	44011S04951/44011S0A951/44014S04N52/ 44014S2G951/44014S04952	303840	23945	15-1301	253



G-AP Ref.	MAKE	ADAPTABLE TO OE	GKN	SPIDAN	METELLI	PAGE	
GC023026	HONDA	44511SE0406/44014SE0910	301944	22350	15-1250	246	
GC023028	HONDA	44010SL5010/44011SL5000	303321/303322	21179		246,257,260	
GC023029	HONDA	44010S10A60/44010S30950/44010S30N20/ 44010S30N50/44010S47950/44010SOAJ50/ 44010SW5950/44010SX0950/44011S10A50/ 44011S30950/44011S30J50/44011S30N20/ 44011S47951/44011SW5950/44014S3X950/ 44014SX0C61/44305S10C61/44305S3N950/ 44305S3N951/44305SOAJ60/44305SOAJ61/ 44306S10C51/44306S3N950/44306S3N951/ 44306S3R951/44306SOAJ60/44306SOAJ61/ 44010SOAJ50					245,248,258,260
GC023030	HONDA	44014SABN21/44333S04N01/44014SABN22	304683	24371	15-1424	257	
GC023031	HONDA	44014S0KC00				247	
GC023032	HONDA	44011SX1950/44011SX1951/44014S0AJ52/ 44014SZ3A51	303843	23948		260	
GC023033	HONDA	44010SOA950/44010SOAN50/ 44011SOA950/44011SOAN50/44014S5AJ51/ 44014S5AJ52/44014S6M950/44014S7AJ50/ 44014SDZT00/44014ST7C01/44014ST7C51/ 44305S04J60/44305S2H951/44305S5AJ50/ 44305S5AJ60/44305S5AJ61/44305S5C950/ 44305S5CN50/44305S5CN51/44305S7B950/ 44305SOA960/44305SOAN60/44306S2H950/ 44306S5AJ51/44306S5AJ61/44306S5AJ62/ 44306S7B950/44306SOA960/44306SOAN60	304310	23673	15-1699	257	
GC023034	HONDA	44014SCAE01/44014SDCA50/44305S9AN00/ 44306S9AN00/44306SEAN50/44014S9A020/ 44014SDCA51	305304	25080	15-1679	247,255	
GC023035	HONDA	44010S47000/44010SW5000/44010SX0000/ 44011S47000/44011S47010/44011SW5000/ 44011SX1000				260	
GC023036	HONDA	44014S1AE00/44014S1AE01/44014S1BE01	304734	24461	15-1423	247	
GC023038	HONDA	44010S04010/44011S04010/44310S0A900/ 44011S05N00/44011S04020/5860052290				249,250,256,257,258	
GC023039	HONDA	44014S5A951/44014S6DG50/44305S5A950/ 44305S5AN50/44305S6A950/44306S5A950/ 44306S5AN50		25079	15-1425	253,254	
GC023041	HONDA	44306SA2030/44305689010/44305689030/ 44305SA2010/44305SA2030/44306689010/ 44306SA2010	302090	20536		248,249,259	
GC023042	HONDA	44305SB2000/44305SB2010/44305SF4010/ 44305SF4020/44305SF4900/44305SF4901/ 44305SH3000/44305SH3010/44305SH3A21/ 44306SB2000/44306SB2010/44306SF4010/ 44306SF4020/44306SH3000/44306SH3010/ 44306SH3A21	300989/302082/ 302095	20306/21385	15-1086	250	
GC023043	HONDA					244,257,259	
GC023044	HONDA	44305SD4020	302171	22356	15-1073/15-1074	257,258	
GC023046	HONDA	44310SS0910				259	
GC023047	HONDA	44010SO4010/44011SO4010/44310SO4300/ 44310SO4900	303320/303981	21178/22962		252,253	
GC023051	HONDA	44014SX8M02				248	
GC023053	HONDA					248	
GC023055	HONDA					258	
GC023056	HONDA	44014SDCA00/44014SDETOOL/ 44305SDETOOL/44306SDETOOL				245	
GC023059	HONDA		303842	23947		260	
GC023061	HONDA					248	
GC023063	HONDA		303363	21528		252,253	
GC023071	HONDA	44305SA5622/44305SA5971/44305SE0923/ 44305SH3G21	300844/301945	22351		246	
GC023073	HONDA	44010S04951/44010S04961/44305S2G950/ 44305S2G960/44305S2T950/44306S2G950/ 44306S2G960/44306S2T950/44010S2G950/ 44011S2G950				252,253	
GC023075	ACURA/HONDA					1,259	
GC023080	HONDA	44014S10A00/44014S10A50/44014S10A51/ 44014S10A52/44014S30C61			15-1684	255	
GC023081	HONDA	44014SD4950/44306SD4E71	302172		15-1074A	246,257	

G-AP Ref.	MAKE	ADAPTABLE TO OE	GKN	SPIDAN	METELLI	PAGE
GC023083	HONDA	44010S08950	303838/303839	23943/23944		252,254
GC023084	HONDA					257,258
GC023086	HONDA	44010S04J51/44011S04J51/44014S01952/ 44010S04J00/44010S09950/44011S09950				250,252,253,254,256
GC023087	HONDA	44014-S5D-A50/44014-S5D-A51				248
GC023093	HONDA				15-1337	252,256
GC023094	HONDA	44014SENP00/44014TF0J00/44305TF0J00/ 44306TF0J00			15-1682	257
GC023095	HONDA	44014S6DE01	304699	24387	15-1426	253,254
GC023096	HONDA					255
GC023097	HONDA					252
GC023098	HONDA	44305SD5003/44305SD5013/44306SD5003/ 44306SD5013				260
GC023099	HONDA	44010ST5003/44010ST6003/44011ST6003/ 44305SD5023/44305SD5901/44305SN4003/ 44306SD5023/44306SD5901/44306SD5J01/ 44306SN4003				258,260
GC023103	HONDA	44014TA0A00				245
GC023104	HONDA	44305SAA000/44306SAA000/44305SFA000/ 44306SFA000/44306SFB000				256
GC023105	HONDA	44014SD5A51				248
GC023106	HONDA	44014SELTOO/44305SELTOOL/ 44306SELTOOL				256
GC023107	HONDA					248
GC023108	HONDA					248,252
GC023109	HONDA					248,252
GC023110	HONDA					248
GC023118	HONDA	44014S3X951/44014S3X960/44014S3X961/ 44014S7A950/44014SX0C10/44014SX0C11/ 44014SX0C50/44014SX0C60/44014SX0C62/ 44305S0AJ60/44305S0AJ61/44305S1AE21/ 44305S3R951/44305S47N50/44305S7A950/ 44305SX0C51/44306S0AJ60/44306S0AJ61/ 44306S1AE21/44306S47N50/44306S7A950/ 44306SX0C51			15-1685	247,260
GC023124	HONDA	44014SWET01/44014SXA00/44014TA0A50/ 44014SWA010				255,256
GC023125	HONDA	44014SMGE00/44014SMGE01			15-1681	254
GC023126	HONDA	44010S50951				258
GC023135	HONDA	44014TL1E01/44014TL1E00				247
GC023139	HONDA	44014S30C62/44014S7A952				254
GC023145	HONDA	44014TL1E52				247,256
GC023146	HONDA					245,247
GC023147	HONDA					254
GC023153	HONDA	44014SWA000/44305SNW000/44305SWA900/ 44306SNW000/44305TA1A00/44305SNW010/ 44306TA1A00				245,249,255
GC023155	HONDA	44305SNA000/44305SNAN00/44305SYZ000/ 44306SNA000/44306SNA900/44306SNAN00/ 44306SYZ000				249
GC023156	HONDA	44014S04N53				258
GC023160	HONDA	42330SXA01				256
GC023165	HONDA	44305TF6N01				256
GC023168	HONDA	44305TL3000/44306TL3000/44305TA2J00/ 44306TA2J00/44305TA0J00/44306TA0J00/ 44305TL1E00/44306TL1E00				245
GC023173	HONDA	44305SYY000/44306SYY000				256
GC023179	HONDA	44010ST3F00/44010ST3G01/44010ST3E59			15-1686	252
GC023182	HONDA	44305S2K950/44305S2L950/44305SAP950/ 44306S2K950/44306S2KN50/44306S2L950/ 44306SAP950				258
GC023197	HONDA					255
GC024001	HYUNDAI	495012D002/495002D000/ 495002D002/4950828B00				269,270

G-AP Ref.	MAKE	ADAPTABLE TO OE	GKN	SPIDAN	METELLI	PAGE
GC024002	HONDA/HYUNDAI	4950722E00/4950822E00/4950722A00/ 4950722B00/4950722C00/4950822A00/ 4950822B00/4950822C00	303902	21975		248,250,259,260 ,262,263
GC024003	HYUNDAI/MITSUBISHI	4950724A00/4950724A01/4950824A00/ 4950824A01/MB297185/MB297186/MB297189/ MB526112/MB526490/MB526583/MB620170			15-1047	270,342,343,344, 345,349,354,355
GC024004	HYUNDAI	4950702A00/4950702A10/4950705A00/ 4950729A10/4950805A00	303874	20689	15-1406	264
GC024005	HYUNDAI					264
GC024006	HYUNDAI	4950729A00/4950828H00/4950828H01/ 4950828J00/4950828J01/4950828K00/ 4950828K01/4950829A00			15-1370	269
GC024008	HYUNDAI	4950728J00/4950728J01				269,270
GC024009	MITSUBISHI	4950728G00/4950728G01				350
GC024011	HYUNDAI	4950002010/4950702A20/4950702A30	303869	23974		264
GC024012	HYUNDAI					272
GC024013	HYUNDAI/KIA					272,273,274,282
GC024014	HYUNDAI	49508U5A01				264,272
GC024016	HYUNDAI					263
GC024018	HYUNDAI					264
GC024019	HYUNDAI					273
GC024022	HYUNDAI					271
GC024024	HYUNDAI					265,269
GC024025	HYUNDAI	495001C302				262,266,267
GC024026	HYUNDAI					261,262,266
GC024027	HYUNDAI	4950838B00				272
GC024029	HYUNDAI/KIA	495013A210/495003A217/4950038470				271,273,274,282,283
GC024031	HYUNDAI					265
GC024033	HYUNDAI	4950725A00/4950725B00/4950825A00/ 4950825B00			15-1734	261,262,263
GC024034	HYUNDAI					267
GC024036	HYUNDAI	4950017000/4950117000/ 4950017050/4950117050			15-1742	270
GC024037	KIA					282
GC024038	HYUNDAI	4950017510/4950117510			15-1608	270
GC024041	HYUNDAI	465001C060/495001C050/495001C060	304695	24383	15-0541/15-1541	266
GC024044	HYUNDAI					265
GC024046	HYUNDAI/KIA	495001C250/495001C260/495001E011/ 495001E310/495001C352	303904	21977	15-1545	266,267,284
GC024047	HYUNDAI	495001C450/495001C460/495001C550/ 495001E610/495001E650			15-1607	263,267
GC024048	HYUNDAI					274,275
GC024050	SUZUKI	4110154G50/4410165G00				595,597,598
GC024056	HYUNDAI					271
GC024058	HYUNDAI	495003K300				273
GC024060	HYUNDAI					265,269
GC024061	HYUNDAI	4950017100/4950017150/4950117150			15-1471	270
GC024062	HYUNDAI					273
GC024063	HYUNDAI					267
GC024065	HYUNDAI	4950025301/4950725A20				262,263
GC024066	HYUNDAI	495003A310/495003A311/495003A312/ 495013A390/495013A392				274
GC024071	HYUNDAI					272
GC024072	HYUNDAI/KIA	495002B360				271,272,286
GC024074	HYUNDAI					270
GC024075	HYUNDAI	4950025200/4950025311/4950025400				275
GC024077	HYUNDAI	495002H010/495002H011/495012H002				268
GC024087	HYUNDAI					267
GC024090	HYUNDAI	495002E250/495002E500/495012E400/ 495072EE00			15-1661	274
GC024091	HYUNDAI	4950026111/4950026161/4950026411/ 4950026461/4950026561/4950126410/ 4950126411/4950126560/4950126561			15-1543	271
GC024094	HYUNDAI/KIA	495002E600			15-1757	274,287
GC024095	HYUNDAI/KIA	495001H010/495001L010/495011H010/ 495011L010/495911H011/495911H012	305003	24731		268,281
GC024098	HYUNDAI	495001C351/495001C352/495001C361/ 495001C362				266,267
GC024099	HYUNDAI					264
GC024100	HYUNDAI					270
GC024111	KIA					287,288
GC024114	KIA					285
GC024125	HYUNDAI					273



G-AP Ref.	MAKE	ADAPTABLE TO OE	GKN	SPIDAN	METELLI	PAGE
GC024126	HYUNDAI					268
GC024129	HYUNDAI					267
GC024130	HYUNDAI	495003A240				274
GC024131	HYUNDAI					261
GC024132	HYUNDAI	495001M010/495011M010				265,268
GC024136	HYUNDAI					261
GC024137	HYUNDAI					268
GC024138	HYUNDAI					264,268,273
GC024139	KIA					282
GC024144	HYUNDAI					265,267
GC024148	HYUNDAI	495002E800/495012E800			15-1736	275
GC024151	HYUNDAI					266
GC024152	HYUNDAI/KIA	495001L210/495001L310/495011L210/ 495011L310/495001H210/495001H310/ 495011H210/495011H310/495911H211/ 495911H212/495911H311/495911H312	305007	24735		268,282
GC024153	HYUNDAI/KIA					275,287,288
GC024159	HYUNDAI					264
GC024161	HYUNDAI					275
GC024163	HYUNDAI					261
GC024170	HYUNDAI	395003K320/395003K370				273
GC024173	HYUNDAI	51610H1000/51614H1000/51620H1000/ 51624H1000	303886	21802		273
GC024178	HYUNDAI	496002E000				274,275
GC026001	ISUZU	8941086343/8941086353/8943643300/ 8943643320/8944676640/8944676670/ 8944732250	302753/302779	23201	15-1075	275
GC026002	ISUZU	94426401/94426402/ 8944264013/8944264023				275
GC026003	ISUZU	8942476490/8970636220				275
GC026004	ISUZU	8971368880/8971390930/8973876640/ 8972156971/8943126721/8973499521/ 8943126730				275
GC026005	ISUZU	8941539492/8941539494/8941539514/ 8944676740/8944676741/8944676760/ 8944676761/8994676740				275
GC026006	ISUZU	8941539501/8941539521/8944676730/ 8944676750				275
GC026007	ISUZU	8971172150/8971172440/8971839460/ 8971839480/8972001010/8972001020				275
GC026009	ISUZU					275
GC027001	KIA	0K20222510/0K20222610/0K20225400/ 0K2A122610/0K20225400/0K20225600/ 0K21125600	302969	24049	15-1398	282,283,286
GC027002	KIA	0K01122510/0K01122610				288
GC027003	KIA/MAZDA		303984	22965		284,302
GC027004	KIA	0K2N225400/0K2N225600/0K2N42540X/ 0K2N42560X				287
GC027005	KIA	KK33125400A/KK33125600	303120	21002	15-1405	284
GC027006	KIA	0K20322510/0K20322520/0K20322610/ 0K2162540X/0K2162560X/0K25425400/ 0K25425600/0K2A125400/0K2A125600/ 0K2A225600				286,287
GC027007	KIA	105015/G02425500/G02425600	303281	21157	15-1145	283
GC027008	KIA	4951038200				283
GC027009	HYUNDAI/KIA	4951038500/495003A202/495003A205/ 495003A206/495003A207/495013A200/ 495013A201/495013A202				274,283
GC027010	KIA	0K2C022510/0K2C122510/0K9A422510/ 0K9A425600/0K9A62550X/0K9B322510/ 0K9B322610/K9A422510/0K9A425500/ 0K2KB25600/0K20022610/0K2KB25400/ 0K9A222550/0K2C22510	303295	21166	15-1663	282
GC027011	KIA					287
GC027012	KIA					281
GC027013	KIA					280
GC027014	KIA	495913E201				286
GC027015	KIA					281
GC027016	KIA	KK38822510/KK38822610/KK38825400/ KK38825600			15-1518	285
GC027017	FORD/MAZDA	MD192550X/MD202560XB/MD1922510A/ MD1922510				232,314
GC027022	KIA/MAZDA					285,318

G-AP Ref.	MAKE	ADAPTABLE TO OE	GKN	SPIDAN	METELLI	PAGE
GC027023	MAZDA					320
GC027024	KIA					286
GC027027	KIA/MAZDA	G024256				283,303,305,310
GC027028	KIA					286
GC027029	KIA					280,282
GC027030	KIA					281,285
GC027031	KIA					280
GC027032	KIA	0K2NC22510A/0K2N122610/ 0K2N222610/0K2N225600/0K2N42560X				286
GC027033	KIA					285
GC027062	KIA					281,285
GC027067	KIA	495911F210				280,287,288
GC027068	KIA	495911G510/495911G591			15-1611	285
GC027070	KIA	0K30A22510/0K30A22610/0K30A25400/ 0K30B22510/0K30B22610/0K30B25400/ 0K30B25600/1K30B2560X/K30A22510/ 0K30B25600/0K30B25400			15-1548	285
GC027072	KIA	4950007010/4950007060/4950107010/ 4959107010/4959107091/4959107110/ 4959107191			15-1570	283
GC027073	KIA	495922F000/495912F310/495002F310				282
GC027074	KIA					283
GC027075	KIA					281
GC027076	HYUNDAI/KIA					262,263,282,285
GC027077	KIA	4950007050/4959107090/4950107000				283
GC027078	KIA	1K30A2540X/1K30A2560X			15-1715	285
GC027080	HYUNDAI/KIA	495001H110/495011H110/495911H111/ 495911H112/495001L110/495011L110	305005	24733		268,281,282
GC027088	KIA					282
GC027091	KIA					281,285
GC027097	KIA					284
GC027107	KIA					283
GC027108	KIA					285
GC028001	LADA	21082215010/21082215011/21082215012/ 21102215012	300952/302040	20817	15-1081	288,289,290
GC028002	LADA	21212215012	301030/302130	20698	15-1223	289
GC028004	LADA	21232215012				289
GC028010	LADA	111862215012/21100221501200/ 21702215012				289
GC029001	LANCIA	46307105/82489521	302457	21336		291,292
GC029002	LANCIA	51704100			15-1448	295
GC029003	LANCIA	7770910			15-1186	291
GC030001	LAND ROVER	606665/A100J20362	301083	20533		299
GC030002	LAND ROVER	A098J30755/RTC5843	301084	20807		296,299
GC030003	LAND ROVER	RTC6811/STC3046				296
GC030004	LAND ROVER	STC3051/TDJ000010				296
GC030005	LAND ROVER					296
GC030006	LAND ROVER	STC3204				299
GC030009	LAND ROVER					297,298
GC030011	LAND ROVER					296
GC030012	LAND ROVER	TDJ500040			15-1702	296,297,300
GC030015	LAND ROVER					296,297,299
GC030016	LAND ROVER					298
GC031001	LEXUS/TOYOTA	4341020240/4341020241/4342020190/ 4342020191/4342020193/4342020431	302814	20136	15-1207/15-1339	301,606,607, 610,622
GC031002	TOYOTA					606
GC032001	SUZUKI	4410184012/4410184150/4410184330/ 4410184331/4410284012/4410284150/ 4410284330/4410284331/4410184332	301965	21081	15-1117	594
GC034001	MAZDA	G00225500/G00225500A/G00225500B/ G00225600/G00225600A/G00225600B/ G00625500/G00625600/G01222510/ G01225500A/G01225500B/G01225600/ G01225600C/G02225500/G02225500A/ G02225500B/G02225600/G02225600A/ G02225600C	301069/302174	21371	15-1042/15-1058	309,310
GC034002	MAZDA	G00125500/G00125500A/G00125500B/ G00125500D/G00125600/G00125600A/ G00125600B/G00125600E/G00525500/ G00525600/G01125500/G01125600/ G02125500/G02125500A/G02125600/ G02125600A/G02125600C/G02122510A	301017/302112	23506	15-1069	309

G-AP Ref.	MAKE	ADAPTABLE TO OE	GKN	SPIDAN	METELLI	PAGE
GC034003	MAZDA	B00425400A/B00425600A/F00622610A/ F00625400/F00625400A/F00625400B/ F00625400C/F00625500/F00625600/ F00625600A/F00625600B/F00625600C	300898/301995	23077	15-1157	304
GC034004	MAZDA	G01325500/G01325500A/G01325600/ G02325500/G02325600/G01325600C/ GA2325500A/GA2325600C/G01325500A/ G01325600C	301993	21368	15-1135	310,311,312
GC034005	MAZDA		303181/303183	21033	15-1384	304,305,306
GC034006	KIA/MAZDA	F02825400/F0662550X/F07922610 0K2172560X/0K2172540X/F07922610A/	303184	21034	15-1372	282,283,304, 305,306
GC034007	MAZDA	F0245600H/F06922610B/FA0922510B/ FA0922510C/FZ2425400A	300896/301994	21649	15-1138	303,304,305,319
GC034008	MAZDA	FA5922510/FA5922510A/FA6122510A/ FA6122510B/GD2322510A	303365/303369	21197	15-1472	304,306,320
GC034009	MAZDA	F0152550X/F0152560X/F01625500 F01625600A/F01725600D/F0182560XA/ F0352550X/F03625500/F03625600A/ F03725600C/F03825600/F0392550X/ F0392560XA/F0472560X/F06625500/ F06625500B/F06625500C/F0722560X/ FA143650XC/FF0125500/FF022550X/ GA0625500/GA072550X/F01625600/				314,317,318
GC034010	MAZDA	GD1722510/GD1725500	303367/303371	21199	15-0474/15-1474	313
GC034011	MAZDA	G03425500/G03425600/G0342560X/ G04425500/G04425500A/G04425600C/ G0442560X/GA4425500				315,316,317
GC034012	MAZDA	G56425600A/G5642560X/GR0125500/ GR012550X/GR0125600/GR012560X/ GU0125500/GU012550XA/GU012550XC/ GU0125600/GU012560XA/GU012560XD				316,317,319,320
GC034013	MAZDA	GD192560X/GR052550XE/GR052560XE				313
GC034014	MAZDA	G03725500/G03725500B/G03725600/ G04725500/G04725500A/G04725600/ G04725600B				315,316,317,319,320
GC034015	MAZDA	FG0125500D/FG0225500C/FG0225600C/ FR012550X/FR012560X/FR022550X GR252560XB/GG2525500C/GG2525600C GR252550XB/		25076	15-1603	302,303
GC034016	MAZDA	G07225600B/G07425500/G07425600/ G0752550X/G07525600/G0752560X GD022560XA/GD022560XC/GD022560X/				315,316,317
GC034017	MAZDA	M02525500A/M02525500B/M02525600A/ M02525600B/MD1025500/MD1025600/ MD1325500A/MD1325600/MD1525500A/ MD1525600/MD2525500A/MD2525600A				314,315
GC034018	MAZDA	B00422510/B00422610/B00425400 B00425600/BS0525600/F00625400D/ F00625500E/F00625600F/FS1825400/ FS1825400C/FS1825600/FS1825600C/ FS2125400A/FS2125400C/FS2125600A/ FS2125600C/B00425510/				317,318,321
GC034019	MAZDA	F01325400/F01325600/F02322510/ F02325400/F02325600/G07225500/ F02322520A/G07225600	302592/302634	24040	15-1137	303,305,310,311,312
GC034020	MAZDA	FA502540XA/FA502540XB/FA502560XB/ FA522550X/FA582550X/FA602540X/ FD502560XA/FD5522510/FD5522610 FA602560X/				318
GC034021	MAZDA	GD192550XA/GD192560XA/G56025500B/ G56025600B/G56025600C			15-1335/15-1643	312
GC034022	KIA/MAZDA	F02422510A/F06925400/ F06925600/F06925600C				282,283,303,304,305 ,306,319
GC034023	MAZDA	F02525400/F02525600			15-1304	304,306
GC034024	MAZDA/NISSAN	1N0025500				318,355,360,368,369, 370,375,376,379,383
GC034025	MAZDA	F03725500A	302762/302786	24045	15-0146/15-1146	303,312,318,320
GC034026	MAZDA	FA5822510/FA5822510B/FA782550XA	303366/303370	21198	15-1473	304,306
GC034027	MAZDA					303
GC034028	MAZDA					303



G-AP Ref.	MAKE	ADAPTABLE TO OE	GKN	SPIDAN	METELLI	PAGE
GC034029	MAZDA					309
GC034036	FORD/MAZDA					231,309,320
GC034037	MAZDA					319
GC034038	MAZDA					309
GC034039	FORD/MAZDA					197,220,321
GC034044	MAZDA					316
GC034045	MAZDA					309
GC034046	MAZDA					306
GC034048	MAZDA	GG2725500E/GG2825600C/GR272550XB/ GR272560XB/GR282550X/GR282560X				303
GC034050	MAZDA					309,320
GC034051	MAZDA	F02325400A/F02325400C/GD0125500/ GD022550XA				303,304,305,306
GC034052	MAZDA					319
GC034054	MAZDA					309,320
GC034055	MAZDA	F02425600D				304,305,306,319
GC034056	FORD/MAZDA	M07022510/M07022510A/M07025500C/ M07025500D/M07025600A/M07025600B	303848		15-1256	232,314
GC034057	MAZDA					317
GC034058	MAZDA	F03922510B/F03925510B/F06925600B			15-1304A	304,306
GC034059	MAZDA					318
GC034060	MAZDA	FA6122610A				320
GC034061	MAZDA					309
GC034062	MAZDA	BS0525400				302
GC034063	FORD/MAZDA					231,309,320
GC034064	FORD/MAZDA					197,220,321
GC034065	MAZDA					306
GC034067	FORD/MAZDA	MD202550XB/MD202560XD/MD206060XD/ MD2022510A/MD2022510				232,314
GC034068	MAZDA	G0442550X				310,311,312
GC034069	MAZDA					314
GC034070	MAZDA					306,307,308,309
GC034071	FORD					231
GC034072	MAZDA	GD172550XB/GD172560X/GD172560XA/ GD172560XB	303985	22966		313
GC034073	MAZDA					312,320
GC034074	MAZDA				15-1278	310,311,312
GC034075	MAZDA					318
GC034077	MAZDA					319
GC034080	MAZDA		303849	23954		313
GC034081	MAZDA	F03725500B	301996	24008		303,304,305,306,312
GC034082	MAZDA	G57025500/G57025500A	302977/302978		15-1328	310,311,312,320
GC034084	MAZDA	GD3622610/GD362560XA/GD362560XB/ GD3822510A/GD382550XA			15-1525	306,307,308,309
GC034085	MAZDA					319
GC034086	MAZDA					309,310
GC034087	MAZDA					312
GC034090	FORD/MAZDA	GG062550XD/GG062560XE/GG082560XC/ GG182560X/GG362550X/GG062550XC/ GG062560XD/GG062560XF/GG062560XG/ GG362560X				220,321
GC034091	MAZDA					302,303,306
GC034093	MAZDA	GG2925500A/GG292550XA			15-1535	302
GC034094	KIA	4959107210/4959107291			15-1610	283
GC034100	MAZDA		303850	23955		321
GC034105	MAZDA					302
GC034107	FORD					197
GC034110	MAZDA	GF092550X/GF092560X/GF092560XB/ GF112560X/GP182550XA/GP202560X/ GP182550X/GP062560XB/GP062560XD/ GF092560XC/GP102560XB/GP182560XF/ GP182550XC/GP202560XB	305461	25238		306,307,308,309,314
GC034114	MAZDA					307,308,309
GC034117	MAZDA	GA202550XB/GA202560XB/GA222550X/ GA222560X				319
GC034118	MAZDA	GA322550X/GA322550XA/GA322550XB/ GA322560X/GA322560XA/GA322560XB				319
GC034120	MAZDA	GD212550X/GD212560X				316
GC034121	MAZDA	GG092550XD/GG092550XE				316
GC034123	MAZDA	FA512550X/FA512550XA/FA512550XB/ FA512550XC/FA512560X/FA522560XB/ FA522560XC/FF042550X/FF042550XA/ FF072560X				318,320
GC034124	MAZDA	FD552550XA/FD552560AC/FD552560XA				318,320

G-AP Ref.	MAKE	ADAPTABLE TO OE	GKN	SPIDAN	METELLI	PAGE
GC034127	KIA					284,285
GC034128	KIA					285
GC034131	MAZDA	FG0225500D/FG0225500E/FG0225600D/ FG0225600E				303
GC034135	MAZDA	GD3622610/GD362560X/GD362560XA/ GD362560XB/GD3822610/GD602560X/ GD602560XA/GD602560XB	304691	24379		306,307,308
GC034145	MAZDA	G5722550X/G5722560X				315,316,317,319,320
GC034146	HYUNDAI	495000X004/495000X014				267
GC034147	MAZDA					306,308
GC034156	KIA					284
GC034173	MAZDA	GP342560XE/GP352560XB/GP352550XB/ GP342550XC/GD762550XC/GD762560XC				313
GC034174	MAZDA	FG0625600A/FG0525600B/FG0525600C/ GG4525600B				318
GC034177	MAZDA	GG3625500C/GG3425600E/GG3425600G/ GG6225500A/GG6225600B/GG6625500				318
GC034178	MAZDA	GG4625500A/GG4625600A/GG4625600C				318
GC034180	MAZDA	GD622560XD				314
GC034181	MAZDA	FA8025500A/FD8025500B/FA8225500A/ FP0125500C/CTA125500/FA8125600B/ FD8025600A/FA8025600B				317
GC034200	MAZDA					303
GC035001	MERCEDES BENZ	0003300036/3300036/0003301585/3301585/ A0003301585/A0003300036	302854/303095/ 305805	20176/25611/ 20985	15-0298/15-1298	333,334
GC035002	MERCEDES BENZ	0003301885/6383342334/A6383342334/ A0003301885	303382	20228	15-0373/15-1373	333,334
GC035003	MERCEDES BENZ	1683601872/1683702172			15-1434	322
GC035004	MERCEDES BENZ	A1683702172/A1683702272	303882	22264		322
GC035005	MERCEDES BENZ	A1683700872/A1683701572	303878	22260		322
GC035006	MERCEDES BENZ					331
GC035007	MERCEDES BENZ	A6383340534				333,334
GC035008	MERCEDES BENZ					333,334
GC035010	MERCEDES BENZ					322
GC035016	MERCEDES BENZ	A1633300401/A1633300501			15-1709	328,329
GC035017	MERCURY/NISSAN					336,377
GC035018	MERCEDES BENZ	4603300935	302186	22690		330
GC035019	MERCEDES BENZ					327,328
GC035020	MERCEDES BENZ					326
GC035021	MERCEDES BENZ					324
GC035022	MERCEDES BENZ	1683603172/A1683603172/A1693603372/ A1683603372/1683601972/1683603372	303880	22262	15-1367	322
GC035023	MERCEDES BENZ	A1683602372/A1683603272/A1683603472/ A1683604572/1683604572/1683603472/ 1683602372/1683603272	303876	22258		322
GC035024	MERCEDES BENZ					333,334,335
GC035025	LDV					300,301
GC035026	MERCEDES BENZ	1693603972/1693604072/1693601272/ 1693605272/1693606072/1693606272/ A1693601272/A1693605272/A1693606272/ 1693607172/1693607372/1693608072/ A1693603972/A1693606072/1693606872/ 1693606572	304829	24556	15-1604	322,323,324,325,326, 327,328
GC035027	MERCEDES BENZ					322,323,324,326 ,327,328
GC035028	MERCEDES BENZ	6393500710			15-1606	333,334,335
GC035030	MERCEDES BENZ					323,324,325,326 ,327,328
GC035032	MERCEDES BENZ					324
GC035033	MERCEDES BENZ		302461	22711		330
GC035034	MERCEDES BENZ	9013300001/A9013300001	304902	24631		332
GC035036	MERCEDES BENZ					333,335
GC035040	MERCEDES BENZ					322,323,324,325
GC035052	MERCEDES BENZ					330,331
GC038001	MINI				15-1454	337
GC038002	MINI	31607518237/31607518238/31607518247/ 31607518248	304704	24392	15-1480	337,340
GC038003	MINI	31601493977/31601503306/31601503307/ 31607518237/31607518238/31607518261/ 31607574852	304706	24394	15-1520	337,338
GC039001	MITSUBISHI	MB160653/MB160654/MB620325/MB620326	302012	24213		352,353
GC039002	MITSUBISHI	MB297991/MB297992/MB526972/MB526973/ MB837697/MB620166	301984	24215	15-1147	344,346,347,353,354

G-AP Ref.	MAKE	ADAPTABLE TO OE	GKN	SPIDAN	METELLI	PAGE
GC039003	MITSUBISHI					352
GC039004	MITSUBISHI	MR580561/MR580562				343
GC039005	MITSUBISHI	MN156271/MN156275/MN156277				347
GC039006	MITSUBISHI	MR528640				353
GC039007	MITSUBISHI	MR110193/MR377295	303523	21718		341,342,350
GC039008	MITSUBISHI	MR580553/MR580554/RR580553G	303590	21790	15-1639	343,350
GC039009	MITSUBISHI	MB526437/MB526438/MB526914/MB620034/ MB837195/MB837262/MB837263/MB837264/ MB837265/MB837433/MB837434/MB837517/ MB837600/MB837642/MB837707/MB837708/ MB886436/MB936359/MR110091/MR110402/ MR110406/MR110763/MR111061/MR165842/ MR936359/MR176993/MB837641/MR111060/ MB936779/MB936778/MB886230/MB837261/ MB620957	300877/301985	24216	15-1329	346
GC039010	MITSUBISHI	MB620363				346
GC039011	MITSUBISHI	MB525577/MB526558/MB526613/MB526614/ MB526859/MB526867/MB526868/MB526869/ MB886539/MB886540	301982	24212	15-1161	343,346,350
GC039012	MITSUBISHI	MB620754/MB886260/MR886257/MR886260				344,353
GC039014	MITSUBISHI	MB526544/MB526551/MB526553/MB526911/ MB620247	302631	24225	15-1191	343,349
GC039015	MITSUBISHI	MB526772/MB526774/MB620481/MB620752/ MB620755/MB620756/MB620758/MB620807/ MB620808/MR110883/MR110886	303317	21176		352,353
GC039016	MITSUBISHI	MB620899/MB620900/MB837184/MB837195/ MB837426/MB896778/MB896787/MB896788/ MB896789/MB896790/MB936363/MB936365/ MR110120/MR110199/MR110207/MR110208/ MR176639/MR176640/MR196868/MR196869/ MR196872	303393/303394	20926	15-1404	347,354
GC039017	MITSUBISHI	MB896789/MR232727				341
GC039018	MITSUBISHI	MR276870/MR276871/RR276871G/MB620653				342,352
GC039019	MITSUBISHI	MB896525/MB896526/MB937996/MR111854	301983	24214	15-1332	350
GC039020	MITSUBISHI/PROTON	MR111856/MB896215			15-1331	347,351,484
GC039021	VOLVO	30871328/MR110029/MR110030/MR111365/ MR111366/MR176551/MR263884/MR377575/ MR377576	303527	21759	15-1385	742,743,748,749
GC039022	MITSUBISHI	MR110031/MR110032/MR111367/ MR111368/MR176553/MR263886/RR176553G/ 3815A133	303529	21747	15-1492/15-1628	341,342
GC039023	MITSUBISHI/PROTON	MB837399/MB837400/MB936148/MR580911				343,350,484
GC039024	MITSUBISHI	MR910297	304304	23667	15-1668	341,342,354
GC039025	MITSUBISHI	MB620701/MB620702				344,353
GC039026	MITSUBISHI	MB526406				344,345
GC039027	MITSUBISHI	MB526145/MB526270/MB526271/MB526272/ MB620251/MB620833/MB620834/MB886761/ MR276859/MR276860/MB526142/MB620253/ MB620625	302637	24226		352,353
GC039028	MITSUBISHI	MR528643				353
GC039029	CHEVROLET / GEO/GMC/HUMMER					97,244,261
GC039030	MITSUBISHI					342,343,345,348,350,
GC039032	MITSUBISHI					342
GC039033	HYUNDAI					265,269
GC039034	HYUNDAI/MITSUBISHI					269,270,273,344,345,
GC039035	MITSUBISHI					344,346,347
GC039036	MITSUBISHI	MB297871/MB297872/MB526908/MB526909	303390/303391	20924	15-1148	346,353,354
GC039037	DODGE					151
GC039039	MITSUBISHI					348
GC039040	PROTON	2081207/MB896742/MB896744	300951/302076	20184	15-1215	484
GC039041	CHRYSLER/DODGE/EAGLE/ MITSUBISHI/PLYMOUTH					99,150,151,344, 345,482
GC039042	MITSUBISHI					353
GC039044	CHEVROLET					96
GC039045	MITSUBISHI	MB620178			15-1130	353
GC039046	MITSUBISHI					344,345
GC039047	MITSUBISHI					351
GC039048	MITSUBISHI					348



G-AP Ref.	MAKE	ADAPTABLE TO OE	GKN	SPIDAN	METELLI	PAGE
GC039054	HYUNDAI/MITSUBISHI	4950728E00/4950733A00/4950733A10/ 4950733A20/4950733B10/MB176872 MB297376/MB297377/MB297385/MB297818/ MB526455/MB526456/MB526464/MB526829/ MI208006/MB297815/MB176876/MB297375/	302074/303852	21382/23957	15-1104	269,270,273,342,343, 344,345,348,349,354 ,355
GC039058	mitsubishi					345
GC039059	MITSUBISHI	MR567001/MR567002/MR580375/MR580376				348
GC039060	MITSUBISHI					354
GC039063	HYUNDAI					262
GC039064	MITSUBISHI	MB896315/MB896316/MB936361/ MB936362/MR936361/MR165844				344,345,351
GC039067	HYUNDAI	4950829C00				269,270
GC039070	MITSUBISHI					341
GC039077	MITSUBISHI					341
GC039078	CHRYSLER/DODGE/MITSUBISHI					99,150,344,345
GC039079	MITSUBISHI	MB896213/MB896214				344
GC039082	MITSUBISHI					348
GC039084	MITSUBISHI	MR912134/MR912135/MR912136	303745	20621		342,354
GC039085	MITSUBISHI/PROTON					343,345,484
GC039089	MITSUBISHI					346
GC039093	MITSUBISHI					353
GC039097	MITSUBISHI					344
GC039098	MITSUBISHI	MR377293/MR377294	303525	21720		341,342
GC039100	MITSUBISHI/VOLVO					354,742,743,748,749
GC039102	MITSUBISHI	MR377715/MR910890/MR377713	304306	23669	15-1662	354
GC039103	MITSUBISHI					342,343
GC039104	HYUNDAI	4950738E00/4950838E00			15-1617	273
GC039105	HYUNDAI	4950025300				261,275
GC039110	MITSUBISHI					350
GC039112	MITSUBISHI	LMN180244/LMR580861/MN156219/ MR498477/MR498478/MR580251/MR580252/ MR580374				351,352
GC039113	MITSUBISHI	3815A107/3815A108/3815A189/3815A190				348
GC039114	MITSUBISHI	MR528569/MR528570/MR953583/MR953584				349
GC039117	MITSUBISHI	3815A065/3815A068				351
GC039119	MITSUBISHI	MR222962/MR222963/MR222966/MR222967				343
GC039120	MITSUBISHI	MR222050/MR222051				343
GC039121	MITSUBISHI	MR222960/MR222961/MR222964/MR222965				343
GC039123	MAZDA	G07622510/G07622610/G07625500/ G07625600/G07822610				309
GC039124	MITSUBISHI	MR453383/MR453384/MR580733/MR580734				352
GC039128	HYUNDAI					262
GC039134	MITSUBISHI	MR580449/MR580450				347
GC039135	MITSUBISHI					347
GC039136	MITSUBISHI	MR336527/MR336528/MR367165/ MR367166/MR515191/MR515192				353
GC039137	CITROEN/PEUGEOT					105,454
GC039141	MITSUBISHI	MR528565/MR528566/MR567003/MR567004				349
GC039142	MITSUBISHI	MR553009/MR553010				349
GC039143	MITSUBISHI	MN147042/MN156463/MN156464/ MN156487/MN156490/MR498969/ MR498974/MR580213/MR580470/ MR580849/MR580850/MR580851/MR581309				342
GC039146	MITSUBISHI/SMART					343,585
GC039147	HYUNDAI	495002D100/495002D102/495012D101/ 495012D102				265
GC039149	MITSUBISHI	MR222052/MR222053/MR263947/ MR263948/MR263949/MR263950				351
GC039150	MITSUBISHI	MR196757/MR196758				350
GC039157	MITSUBISHI					353
GC039161	MITSUBISHI	MR580452				347
GC039166	MITSUBISHI					347,348
GC039168	MITSUBISHI					348
GC039170	MITSUBISHI					347
GC039176	MITSUBISHI	MN180244/MR953569/MR580864/ MR580896/MR580862/MR580863/MN580862				341,349
GC039177	MITSUBISHI	3815A008/3815A011/MR980745/MR980746				342
GC039178	MITSUBISHI	3815A203/3815A204/3815A461/ 3815A462/3815A464/3815A469/ 3815A470/3815A390/2815A189/2815A190				345
GC039181	HYUNDAI					267
GC039185	HYUNDAI					265,269
GC039186	MITSUBISHI					353
GC039190	HYUNDAI					265,269
GC039192	HYUNDAI					267

G-AP Ref.	MAKE	ADAPTABLE TO OE	GKN	SPIDAN	METELLI	PAGE
GC039200	MITSUBISHI					348
GC039203	MITSUBISHI					348
GC039211	MITSUBISHI	3815A207/3815A208/3815A205				349
GC039214	MITSUBISHI	MB526011/MB526012/MR176647/ MR176648/MB837698/MB919125/ MB837266/MB936771/MB837267/MB936772				344,345,350,351
GC039221	MITSUBISHI	MR980743/MR980744/MR980745				342
GC039232	HYUNDAI					266
GC039233	MITSUBISHI					351
GC039234	PROTON					484
GC039236	MITSUBISHI	3815A165/3815A164				342
GC040001	MOSKVICH		302319/302794	23162/22996	15-1184	355
GC041001	NISSAN	391000M000/391000M005/3910050Y00/ 3910051Y00/3910052Y00/3910053Y00/ 391010M000/391010M005/3910150Y00/ 3910150Y01/3910151Y00/3910152Y00/ 3910153Y00/3921150Y00/9321150Y00	300893/301989	24432	15-1163	356,381
GC041002	NISSAN	3910050Y10/3910051Y10/3910052Y10/ 3910053Y10/3910150Y10/3910150Y11/ 3910151Y10/3910152Y10/3910153Y10/ 3921150Y10			15-1293	356
GC041003	NISSAN	391000M910/391004M761/3910060Y10/ 3910060Y15/3910061Y16/3910062Y00/ 3910062Y10/3910062Y15/3910063Y10/ 3910063Y11/391014M761/3910160Y10/ 3910160Y15/3910161Y17/3910162Y00/ 3910162Y10/3910162Y15/3910162Y16/ 3910163Y11/3910163Y15/3921160Y10	303336/303337	21188	15-1275	356,381
GC041005	NISSAN	3910071J00/3910171J00/3910171J10/ 3910172J00				375
GC041006	NISSAN	3910170J00/3921171J25/3921171J27	302015	24430	15-1172	358,359,370,371
GC041007	NISSAN	3910071J10/3910170J10/3921171J26	302016	24431	15-1173	358,359,370,371
GC041008	NISSAN	3910055A00/3910155A00/3921155A00	302017	20900	15-1088	380
GC041009	NISSAN	3910072J20/3910073J00/3910173J00/ 3921173J25/3921173J26	300891/301987	24428	15-1164	370,371
GC041010	NISSAN	3910072J10/3910073J20/3910173J20/ 3921172J25/3921173J27	301988	24429	15-1165	370,371
GC041011	NISSAN	3921185E00/3910073N00/3910173N00/ 3910173N01/3921199999/39100173N10/ 3921171E15/3921158E10/3921158E15	303126	21006	15-1323	364,369,374
GC041012	NISSAN	391004F400/391014F400/392114F425	303311	20099	15-1194	365
GC041013	NISSAN	3910044B00/3910044B02/3910044B10/ 3910044B12/3910144B00/3910144B02/ 3910144B10/3910144B12/392114F426	303308/303310	20104	15-1193	365
GC041014	NISSAN	3920164Y10			15-1321	355,381
GC041015	NISSAN	392115V010				357
GC041016	NISSAN	3910058G00/3910058G60/3921158G00	303862	23967		368,369
GC041017	NISSAN	3910172J15/3971170A10				373,375
GC041018	NISSAN	3910061E00/3910062E00/3910161E00/ 3910162E00/3910180E00/3910064E05/ 3910080E05/3910180E05/391001C100/ 391002J205/3910050R10/3910065J00/ 3910070N00/3910070N05/3910071N04/ 3910071N05/3910074N00/39100D4600/ 391012J205/3910150R00/3910150R10/ 3910165J00/3910165J05/3910170N00/ 3910170N05/3910172N00/3910174N00/ 3910175N00/39101D4600/3921132R00/ 3921165J00			15-1312	358,359,374,378
GC041019	NISSAN					374
GC041020	NISSAN					365
GC041021	NISSAN	3910031U00/3910031U10/3910032U05/ 3910131U00	303288/303860	21162/23965		364
GC041022	NISSAN	391002Y016/391002Y115/3910032U15/ 3910032U16/391012Y016/391012Y115/ 3910132U15/3921131U00/3921131U10				364

G-AP Ref.	MAKE	ADAPTABLE TO OE	GKN	SPIDAN	METELLI	PAGE
GC041023	NISSAN	3910063E00/3910064E00/3910080E00/ 3910163E00/3910180E03/3910164E05/ 3910070A10/3910070A20/3910071N00/ 39100D4000/39100G8100/3910164J00/ 3910165J10/3910170A10/3910170A20/ 3910171N00/3910171N01/3921165J10				357,358,359,360,363, 369,373,375,376,377, 378,379,383
GC041024	NISSAN	3910064E10/391001C110/391003J210/ 391005C510/3910065J10/3910070N10/ 3910071N15/391012J210/391013J210/ 3910165J15/3910170N10/3910170N15/ 3910171N10/3910175N10/392111C100/ 392115C510				357,358,363,369,373, 375,377,378
GC041025	NISSAN	392117F000	304912	24641		381,382
GC041026	NISSAN	3910001J00/3910001J10/3910101J00/ 3910101J10	303604	20559		368,369
GC041028	NISSAN	391002F605/391002F615/392112F225/ 44014S7C950/391019F610/391019F600/ 391009F601/391009F611	303447	21531	15-1349	371,372,374
GC041029	NISSAN	391002F000/392042F025/392112F026				370
GC041030	NISSAN	391002F010/391012F011/392112F025	303380	20232	15-1348	371,372,373,374
GC041031	NISSAN	3910024B00/3910024B10/3910124B00/ 3910124B10/3921124B00	303858	23963	15-1187	365
GC041033	NISSAN	391000M600/391000M605/3910040Y00/ 3910040Y06/391004M500/3910140Y00/ 3910140Y06/3910162Y06/3910163Y05				355,360,368,369,370, 375,376,377,379,383
GC041034	NISSAN	391004M510/391004M570/391014M570/ 391014M575/391014M771				355,360,368,369,370, 375,376,377,379,383
GC041035	NISSAN	3910055E01/3910087E10/3910006R00/ 3910155E01				357,358,360,364,369
GC041036	NISSAN	3910031U00/3910032U05/3910131U00/ 3910132U05				360
GC041037	NISSAN	391002Y175/391008H315/391008H615/ 391009H610/391012Y070/391012Y175/ 391012Y176/391018H315/391018H710/ 391018H810/392112Y070/391008H710	304821	24548	15-1600	364,383,384
GC041038	NISSAN	39211AV625			15-1509	357,372,373
GC041039	NISSAN	3910050A10/3910050A11/3910052A00/ 3910077A00/3910150A00/3910150A10/ 3910152A00/3910177A00				360,362,363,375, 376,378,379
GC041040	NISSAN	3910041B00/3910041B05/3910041F100/ 3910041F400/3910045B00/391004F100/ 3910141B00/3910141B05/3910141F100/ 3910141F400/3910145B00/391014F100/ 392114F125	303305/303307	20079/20085	15-1196	365
GC041041	NISSAN	3910047A00/3910147A00				355,360,362,363,369,
GC041042	NISSAN	3910164E00/3921161E06/3920202E25/ 39101D4000/3910064E00				358,359,369,374
GC041043	NISSAN	392110E015/391010E417				372
GC041044	NISSAN	391014U010/392112J200				357
GC041045	NISSAN		303122	21004		358,359,369
GC041046	NISSAN	39211AY125	304729	24456	15-1442	364,365,366
GC041047	NISSAN	39211AY625/39211BC50J	305241	24992	15-1443/15-1634	364,365,366,367
GC041048	NISSAN	39211BM526/39101BM510	304820	24547	15-1647	356
GC041049	NISSAN					373
GC041050	NISSAN	39211AW325			15-1445	372,373,374
GC041051	NISSAN	3910031G00				361,381
GC041052	NISSAN	39211BM726/39101BN710/39100BN710	304803	24530	15-1475	356,357
GC041053	NISSAN	39100VB001/39101VB001				369,377
GC041054	NISSAN	3910164E15/391000E410/391000E415/ 391003J110				358,359,369,375
GC041055	NISSAN	391002J211/391002J216				357
GC041057	NISSAN	392115M427/39211BM427	304809	24536	15-1477	357
GC041058	NISSAN	392114F126	303304/303306	20090/20094	15-1197	365,366
GC041059	NISSAN	39112M7225/39100M7270/39101M7270	302097		15-1027	360,361



G-AP Ref.	MAKE	ADAPTABLE TO OE	GKN	SPIDAN	METELLI	PAGE
GC041060	NISSAN	3910011A00/3910011A10/3910011A20/ 3910011M00/3910011M05/3910012A00/ 3910012A10/3910012A20/3910013A00/ 3910013A01/3910013A10/3910013A20/ 3910015A05/3910016R05/3910110A01/ 3910111A00/3910111A10/3910111A20/ 3910111M00/3910111M05/3910112A00/ 3910112A10/3910112A20/3910113A00/ 3910113A01/3910113A10/3910113A20/ 3910116R05/3920511A25/3930110A01/ 3930111A00/3930112A00/3930113A00/ 3930113A01	301000/302098	20904	15-0028/15-1028 15-1100	361,369,378
GC041061	NISSAN	3910001E02/3910002E02/3910101E02/ 3910102E02	302018	24409	15-1098	358,359,369
GC041062	NISSAN	3910158E10/3910073N10/3910173N10				358,359,374,378
GC041063	NISSAN	3910016E00/3910026E00/3910085E00/ 3910116E00/3910126E00/3910185E00/ 3910005E02/3910010E02/3910016E02/ 3910105E02/3910110E02/3910116E02/ 3910085E10/3910185E10/39100D5600/ 39100D5610/39101D5600/39101D5610	302793	24440	15-1249	357,359,378
GC041065	NISSAN					360,377,378
GC041068	NISSAN					380,381
GC041069	NISSAN					377,378,380
GC041070	NISSAN					358
GC041073	NISSAN	3910050A00/3910050A05/3910150A05	302100	21315	15-1060	380
GC041075	NISSAN					360,364
GC041077	NISSAN					375,376,377
GC041078	NISSAN	391000M301/391000M900/391000M905/ 391000M910/391000M970/391004M761/ 3910060Y00/3910060Y05/3910061Y06/ 3910062Y05/3910063Y00/3910063Y01/ 391010M301/391010M900/391010M905/ 391014M761/3910160Y00/3910160Y05/ 3910161Y07/3910162Y05/3910163Y00/ 3910163Y01/3921160Y00/392118V000	300902/302019/ 302789	24434/24439	15-1248	356,381
GC041081	RENAULT					492
GC041083	NISSAN	335712	302766/302790	24438	15-1276	362,375,377,382
GC041084	NISSAN	326582/39210Y02G0	303091	20983	15-1265	377,382,383
GC041085	NISSAN	3910020N00				360,361,363,366,381
GC041086	NISSAN	3910078G00/3921131G00/3921178G00	304722	24450		381,382
GC041087	NISSAN	3910064Y00/3910064Y05/3910164Y00/ 3910164Y05/3921164Y00	302020	24435	15-1315	355,381
GC041088	NISSAN					357
GC041089	NISSAN					364
GC041090	NISSAN					363,365
GC041091	NISSAN					357
GC041092	NISSAN					377,382
GC041095	NISSAN	39210A03G0	303285	21160	15-1043	382
GC041096	NISSAN					372,374
GC041099	NISSAN	392115M300			15-1692	357
GC041100	NISSAN	391002S600/391002S660/3921158G60				361,367
GC041101	NISSAN					364
GC041105	NISSAN	3921150A00			15-1087	379,380
GC041111	NISSAN					360
GC041112	NISSAN	39211BM725				356
GC041113	NISSAN					382
GC041114	NISSAN	3910041B00/3910041B05/3910045B00/ 3910141B00/3910141B05				363
GC041118	NISSAN	391000M801/391000M806/3910040Y05/ 391000M316/391000M806/39100WD200/ 39100WD205/391010M801/391010M806/ 3910140Y05/391010M316/391010M806/ 39101WD200/39101WD205				379
GC041119	NISSAN					363
GC041130	NISSAN					370
GC041131	NISSAN				15-1324	360
GC041135	NISSAN					377
GC041137	NISSAN	392115M325/392118V010/391015M310				356,357
GC041140	NISSAN					374
GC041141	NISSAN	39211BM527			15-1476	356
GC041142	NISSAN	392115V471/392119F626/39211AU325/ 39211BU025/391014U075/C9211AU31A	305763	25569	15-1508	371,372,373,374

G-AP Ref.	MAKE	ADAPTABLE TO OE	GKN	SPIDAN	METELLI	PAGE
GC041149	NISSAN					364
GC041151	NISSAN	3921185E05/3921185E10				364
GC041152	NISSAN	392112Y010				364,383,384
GC041154	NISSAN	391002U010/391002U210/3910041B10/ 3910045B10/391012U310/3910141B10/ 3910145B10/391002U310				363
GC041155	NISSAN	391000M316/391000M816/3910040Y15/ 39100WD210/39100WD215				379
GC041156	NISSAN					363
GC041159	NISSAN	391004M470/391004M475/391014M470				355,359,379
GC041163	NISSAN		302638	24437		359,369,370,371
GC041167	NISSAN	39211ED100				382
GC041170	NISSAN	3020513A25/3910001A00/3910001M15/ 3920213A91	302099	21308	15-1085	361,378
GC041172	NISSAN	3910001B01/3910001B02/3910001B05/ 3910001B11/3910001B15/3910001B60/ 3910101B00/3910101B05/3910101B15/ 3920401B28/3971101B26	300945/302034	24433	15-1129	365
GC041176	NISSAN					358,359,369,372, 374,378
GC041177	NISSAN					378
GC041178	NISSAN	3910078G00				369,381
GC041184	NISSAN	391002J210/391002J215/391003J171/ 391004N175/391004N275/391005J010/ 391006J071/391006J076/391006J915/ 39100AE415/39100AU415/39100AU416/ 39100AW010/39100CX015/39100CX016/ 39100CX115/39100CX215/391010E478/ 391012J215/391014N175/391014N177/ 391014N275/391015J010/391016J010/ 391016J071/391016J076/391016J915/ 39101AE415/39101AU415/39101AU416/ 39101AW110/39101CX116/39101WF715/ 39101WF716/39100WF110/39100WA015/ 39101WF110/39101WF115/39101OE478				373,375,377,378
GC041185	NISSAN	391002Y175/391008H315/391008H515/ 391008H615/391012Y070/391012Y175/ 391012Y176/391018H315/391018H810/ 392112Y070				360,364,383,384
GC041186	NISSAN	392112F025				375
GC041187	NISSAN	391002Y076/391002Y210/391012Y076/ 391012Y215/392112Y210				360
GC041188	NISSAN	39100AX000/39100AX005/39101AX000/ 39101AX005/391001V10A/391011V10C				364
GC041189	NISSAN	391002J201/391002J206/391005J016/ 391006J011/391006J016/391012J201/ 391012J206/391012J211/391012J216/ 391015J016/391016J011/391016J016				373,375
GC041191	NISSAN					355,356,360,368,370, 375,376,378,379,380, 381,383
GC041195	NISSAN					371,374
GC041214	NISSAN	39100JA010/39101JD52B/C9211JD22B/ C92AAJD22B/C9211JA00A/39100JD24B/ 39101JD24B/39100JD52B			15-1784	357,376,377,383
GC041217	NISSAN	C9211EL00B/39125EL000				382
GC041222	NISSAN	39100JN10A				381
GC041224	NISSAN					361
GC041229	NISSAN					382
GC041231	NISSAN	39100EB70A				366
GC041232	NISSAN	39100CA100/39101CA100/39211CA100/				366
GC041233	NISSAN					382
GC041234	NISSAN	39211EL00B				382
GC041236	NISSAN	392115M425				357
GC041239	NISSAN	391004M400/391004M465				355,379
GC041240	NISSAN	39211EB30A/C9211EB30A	304890	24619		366,368
GC041241	NISSAN	39100C6000/39100C7400/ 39101C6000/39101C7400	303857	23962		368,369
GC041243	NISSAN	39211BM580/39211BM528				356
GC041244	NISSAN					365,366,367
GC041245	NISSAN	39100CA000/39100CA100/39101CA000				366
GC041249	NISSAN/RENAULT	39101JY04A/39100JY04A				376,377,384,506
GC041250	NISSAN	39100CN200/39101CN200/ 391009Y115/391019Y110				381

G-AP Ref.	MAKE	ADAPTABLE TO OE	GKN	SPIDAN	METELLI	PAGE
GC041251	NISSAN	391011KD0A/391001KD0A/ 391009Y015/391019Y015				381
GC041252	NISSAN	39100JC20B/39101JC20B				381
GC041255	NISSAN					357
GC041256	NISSAN	392115M426/391015M310			15-1635	357
GC041257	NISSAN	39211EB31A/C9211EB31A				366,368
GC041264	NISSAN					356
GC041271	NISSAN	C9211EL10A				382
GC041279	NISSAN	391011KA0B/391001KA0B				362
GC041281	NISSAN	3910103A00/3910101M15				355,375,378
GC041282	NISSAN	39100AU115/39101AU075				373
GC041285	NISSAN/RENAULT	39211EN100				377,384,506
GC041286	NISSAN	C9B11JD02B/C9211JD02B/ 39101JD02B/39100JD02B			15-1785	376
GC041289	NISSAN					366
GC041294	NISSAN					362
GC041300	NISSAN					371
GC041302	NISSAN	39100ED105/39100ED305/39101ED105/ 39101ED305/39101ED805/39100ED805/ 39100EE70A/39100EE70B/39101EE70A/ 39101EE70B				363,382
GC041303	NISSAN	39100ED005/39100ED00A/ 39101ED005/39101ED00A				360,382
GC041304	NISSAN	391003U007/391003U507/391004V51A/ 391004V70A/391013U505/391014V01C/ 391014V51A/391014V70A				361
GC041306	NISSAN	391000E510/391000E515/ 391010E510/391010E515/392115J000				375
GC041308	NISSAN	39100EE32B/39100EW605/39100EE76A/ 39101EE32B/39101EE76A/39101EW605				360,363,382
GC041309	NISSAN	391001KB0A/391011KB0A				362
GC041311	NISSAN	39100JG32C/39100JG34C/ 39101JG32C/39101JG34C/39100JG34B				361,383,384
GC041314	NISSAN	391002Y016/391002Y115/3910031U10/ 3910032U15/3910032U16/391012Y016/ 3910131U10/3910132U15/3910132U16/ 3921131U00/3921131U10	303861	23966		364
GC041323	DAIHATSU	4342087745/4346087F98/4346087F99				145
GC041335	NISSAN					372
GC041338	NISSAN					375
GC041339	NISSAN					375
GC041340	NISSAN					364,366,367
GC041341	NISSAN					367
GC044001	OPEL/SUZUKI/VAUXHALL	4700644/4701110/4705753/ 4705754/93170265/93170266/ 4410283E10/4410183E11/9204528	304459	24112	15-1394	385,600,601,627
GC044002	GM/OPEL/ VAUXHALL/VAUXHALL LCV	0374403/374403/9201725	304391	23992	15-1451	243,402,403,406, 416,420,645,646, 647,651,655,662
GC044003	OPEL/OPEL LCV/ VAUXHALL/VAUXHALL LCV	1603273/93182575/374671	304384	23985	15-1504	394,395,396,397, 398,399,400,431, 432,433,629,630, 635,636,637,661,662
GC044004	OPEL/OPEL LCV/ VAUXHALL/VAUXHALL LCV	1603261/1603398/93180019/93187468	304388	23989	15-1452	406,416,433,646, 647,651,662
GC044005	OPEL/VAUXHALL	1603251/93176743	304390	23991	15-1439	416,651
GC044006	OPEL/OPEL LCV/ VAUXHALL/VAUXHALL LCV	374241/374262/90496368/90498412/ 9503080/93172152/374461	302816/302863	20183	15-1289A	390,391,392,393, 423,424,425,431, 432,433,628,629, 634,635,639,655, 656,660,661,662
GC044007	OPEL/VAUXHALL	374211/374213/374263/ 90345303/90498406/0374263	302861	20181	15-1118	389,390,423,424, 425,655
GC044008	OPEL/RENAULT/ TOYOTA/VAUXHALL	7700102978/7700102980/ 7700102998/7700102999			15-1371	417,418,514,515, 516,608,652,653
GC044011	OPEL/VAUXHALL	374351/90538428/0374351	304458	24111	15-1412	423,424,425,655
GC044012	OPEL/VAUXHALL	374346/26060700/0374346			15-1290	391,392,633
GC044013	OPEL/VAUXHALL	0374053/374053/0374368/ 374368/26060699/26067600	303890	21800	15-1400	404,405,646,648
GC044014	VAUXHALL	374329/9117611	303888	21822		646
GC044019	VAUXHALL					644
GC044020	OPEL/VAUXHALL	0374218/374218/374221/ 0374377/374377/26032411/26089775	302454/304596	21429/24280	15-1116/15-1437	401,402,403,405, 406,416,420,646,651
GC044024	VAUXHALL					628,645,655



G-AP Ref.	MAKE	ADAPTABLE TO OE	GKN	SPIDAN	METELLI	PAGE
GC044025	RENAULT		303438	20713		514,515,516
GC044026	CHRYSLER/ NISSAN/NISSAN LCV/ OPEL/OPEL LCV/ RENAULT/RENAULT LCV/ VAUXHALL/VAUXHALL LCV	4401720/4401727/8200169277/ 8200169281/8200169285/ 8200169288/8200178618/8200178624	303437	20712	15-1453/15-1713	98,361,384,417,418, 433,514,515,516,537, 652,653,662,663
GC044027	OPEL/OPEL LCV/ VAUXHALL/VAUXHALL LCV	1603270/93182571/93182577	304397	23997	15-1613	394,395,396,397,398, 399,431,432,433,629, 630,637,638,661,662,6
GC044028	OPEL/OPEL LCV/ VAUXHALL/VAUXHALL LCV	374672/1603274/93182543	304386	23987	15-1505	394,395,396,397,398, 400,431,432,433,629, 630,635,636,637,638, 640,661,662,663
GC044029	DAEWOO					144
GC044030	OPEL/VAUXHALL	0374002/374002/90538427	303342/303358	21195	15-1287	390,391,392,393,633
GC044031	GM					241
GC044032	GM	93292610				240,241,243
GC044033	OPEL/VAUXHALL					393,628
GC044034	RENAULT	4414517	303934	22274		535,536
GC044039	VAUXHALL					655
GC044041	OPEL/VAUXHALL	0374066/374066/90157131	300976/302065 /302066	24913/21450/ 21452	15-0007/15-1007	386,404,410,411,412, 413,414,415,628,630, 641,653,654
GC044043	OPEL/PORSCHE/VAUXHALL					401,402,403,405,406, 407,416,483,644,645, 646,647,648,649,651, 655
GC044044	VAUXHALL					645,646,647,649
GC044046	OPEL/VAUXHALL	0374077/374077/374078/374092/ 0374092/7837456/7837457/7839615	302067	21432	15-1029	403,404,653
GC044047	OPEL					386,410
GC044049	OPEL/VAUXHALL	374003/0374003/90538595			15-1289	388,390,391,392,393, 423,424,425,431,632, 634,635,639,661
GC044051	OPEL/VAUXHALL	0374175/374175/90334947	300978/302069	21428	15-1056	387,388,389,390,411, 412,413,414,415,420, 422,630,631,632,639, 642,643
GC044053	VAUXHALL					645
GC044054	OPEL					394
GC044055	OPEL/VAUXHALL	374014/0374147/374147/90304775	300977/302068	21496	15-1057	420,422,642,643
GC044056	OPEL/VAUXHALL	0374176/374176/90334948	301065/302169	21427	15-1051	387,388,389,390,401, 411,412,413,414,415, 416,420,421,422,423, 630,631,632,633,639, 640,642,643,644
GC044057	OPEL/VAUXHALL	0374015/374015/374126/ 90235271/0374126	301064/302170	21497	15-1052	400,401,411,412,413, 414,415,416,420,421, 422,423,630,631,640, 642,643,644,651,655, 656
GC044060	OPEL/VAUXHALL	374423			15-1391	390,404,423,628,645
GC044063	OPEL					387
GC044064	RENAULT					529
GC044065	OPEL/VAUXHALL	374387/374410			15-1618	423,424,425,656
GC044066	CHEVROLET/GM					95,242,243
GC044068	OPEL				15-1307	389,390
GC044069	GM	93225242				243
GC044080	OPEL	4707438/4410185E50/4410285E50/93180229			15-1555	385
GC044083	OPEL	374068			15-1390	389,390
GC044085	OPEL/SUZUKI/VAUXHALL	93194650/4410151K00	305184	24935	15-1724	385,598,627
GC044086	CHEVROLET/DAEWOO					95,142
GC044088	OPEL/VAUXHALL					394,399,400,638,639
GC044090	CHEVROLET	9H2423B	305490			96
GC044099	DAEWOO					142
GC044107	CHEVROLET					96
GC045001	PEUGEOT	3272E3/3273L1/3272F6	303432	21095	15-1216	443,444
GC045003	PEUGEOT	3272S6			15-1292	457,458,459
GC045004	PEUGEOT	3272E0/3272E2/3273L2/3273L4	303431	21094	15-1139	456
GC045005	PEUGEOT	3272S5			15-1282	456,458,459
GC045006	PEUGEOT	327206/327375	303400/303401	21074	15-1259	455,456
GC045008	PEUGEOT					442
GC045009	PEUGEOT					454

G-AP Ref.	MAKE	ADAPTABLE TO OE	GKN	SPIDAN	METELLI	PAGE
GC045010	PEUGEOT					436
GC045011	PEUGEOT	32726E/32727E/32728E/ 32729E/32733X/32733Y/3273CQ	303473	20300		436,437
GC045012	PEUGEOT					436,437
GC045014	PEUGEOT					443,444
GC045015	NISSAN/OPEL/RENAULT					370,429,533
GC045016	PEUGEOT					433
GC045019	PEUGEOT					454
GC045020	PEUGEOT					454
GC045027	PEUGEOT					438,456,457,458,459
GC045028	PEUGEOT					454
GC045031	PEUGEOT					454
GC045033	PEUGEOT	32723C	303930	22270	15-1382	436,437
GC045035	CITROEN/PEUGEOT					132,133,436,437,438, 456,457,458,459,460
GC045036	CITROEN/PEUGEOT					135,445
GC045037	PEUGEOT					436
GC045038	CITROEN	32724T/32738G			15-1588	113,114,115,116
GC045041	CITROEN					113,114,115
GC045042	CITROEN					101
GC045045	PEUGEOT		303931	22271		437
GC045046	PEUGEOT					436
GC045047	CITROEN/PEUGEOT					103,137,438
GC045048	PEUGEOT					436
GC045049	PEUGEOT	3272AH/32730Y			15-1569	437,438
GC045052	PEUGEOT	32725P/32736Y			15-1468	457,458,459,460
GC045056	PEUGEOT	3272HP/3273HF			15-1499	433
GC045057	CITROEN/PEUGEOT	3272EQ/3272FR/3272KW/ 3273EQ/3273KJ/3272HY/9801611180			15-1560/15-1649	106,107,108,109,433, 438,439
GC045058	CITROEN/PEUGEOT/TOYOTA	3272JZ/3273JS/434100H020B/ 434200H020/4346009D00	305360	25137	15-1515	105,433,605
GC045065	PEUGEOT	3272CQ/3273CQ			15-1629	436,437
GC045067	PEUGEOT	3272CS/3273CS/3272XJ/3273YC	304543	24196	15-1568/15-1720	436,437
GC045068	PEUGEOT					438,439,440
GC045074	CITROEN					116,117
GC050001	RENAULT	8942633/8990574			15-1108	488,489,490
GC050003	RENAULT	7701349992/7701351130			15-1317	506
GC050004	NISSAN/NISSAN LCV/ RENAULT/RENAULT LCV	7700110484			15-1378	362,384,494,495,496, 502,505,533,537
GC050005	RENAULT	7701352133/7701349994			15-1422	506,507,518,529,530
GC050007	RENAULT	7701349025/7701349026/7701349028/ 7701349034/7701349689/7701349839/ 7701351124/7701351264/7701352020/ 7701352025/7701394697/7701498918/ 7701498919/7701498921			15-1082	484,488,489, 490,498,500
GC050008	RENAULT	7701349874/7701349880/7701349938/ 7701351479/7701351480/7701351484/ 7701351571/7701351572	303433	21096	15-1204	485,487,488,492, 493,507,508,509
GC050009	RENAULT	299341X2				528,529
GC050010	RENAULT					533
GC050011	RENAULT	7701469363			15-1285	493
GC050012	RENAULT	360113KTX			15-1353	491
GC050014	RENAULT					514,515,516
GC050015	RENAULT					508,509
GC050016	RENAULT					484
GC050017	RENAULT					491,501,517
GC050018	RENAULT					490,491
GC050025	RENAULT					506
GC050026	RENAULT	7701349955/7701351995/7701352001	303561	20357	15-1316	507,508,509,529
GC050027	RENAULT	7701348089/7701348109/7701349769/ 7701351172/7701498775/7701498955			15-1102	488,490,533,534
GC050030	DACIA					141
GC050034	RENAULT					492,495,496, 497,502,513
GC050035	RENAULT					499
GC050041	RENAULT/RENAULT LCV	8200079915/8200169177/8200436848/ 8200436849/8200467679/8200470131/8200647			15-1576	499,510,511, 512,513,537
GC050043	RENAULT	7701352415/7701352471			15-0310/15-1310	517,518,519,520,521
GC050045	RENAULT	7701351948			15-1336	507,508,509,529
GC050046	RENAULT					507,508,509
GC050048	RENAULT					492
GC050050	RENAULT					517
GC050051	RENAULT					507,509,517,518, 519,520,530

G-AP Ref.	MAKE	ADAPTABLE TO OE	GKN	SPIDAN	METELLI	PAGE
GC050052	NISSAN/RENAULT					362,495,496,497, 503,504,505,517, 518,519,520,521,530
GC050053	RENAULT					529
GC050056	RENAULT	7701352488/7701352622/ 7701352907/7701469542/7701469962	303562	21590		529
GC050057	RENAULT					491,499
GC050062	RENAULT					492,502,513
GC050063	RENAULT					492,502,514
GC050065	RENAULT					499
GC050066	RENAULT					494,502,536
GC050069	NISSAN/NISSAN LCV/ RENAULT/RENAULT LCV	7700111918/8200064731/8200236110			15-1542	362,384,494,502, 503,504,517,518, 519,520,521,529,530,5
GC050079	RENAULT	8200014111/8200035673			15-1574	510,511,512
GC050080	OPEL/RENAULT/VAUXHALL					429,430,535,536,659,660
GC050081	DACIA/RENAULT					139,484
GC050082	RENAULT					502,529
GC050083	RENAULT					510,511,512
GC050086	RENAULT					529
GC050087	RENAULT					529
GC050089	RENAULT					499
GC050090	RENAULT					491
GC050092	RENAULT/RENAULT LCV	8200261840/8200261841/8200511225			15-1502	493,495,497,500, 527,528,536,537
GC050093	RENAULT	8200216519/8200216523/8200432517			15-1579	500,501,530,531,536
GC050105	RENAULT	7701349958/7701349990/7701352128/ 7701352493/7701352495	303563	21591		508,509,510
GC050107	RENAULT					530
GC050108	RENAULT					499,513
GC050109	RENAULT	8200285909/8200436365			15-1580	522,523,525
GC050110	RENAULT					484
GC050112	RENAULT/RENAULT LCV	8200341698/8200378880/8200684084			15-1503	493,497,500, 527,528,536,537
GC050113	FIAT/RENAULT	7711134778/7711134777/8200169176/ 8200079913/8200079912/8200470129			15-1522	182,510,511,512,513
GC050114	RENAULT	7700111914/7700111916/ 7700112116/8200110754			15-1573	517,519,520,521,530
GC050116	RENAULT	8200327707/8200575490/8200575489			15-1523	531
GC050117	RENAULT					522,523,526,528
GC050124	RENAULT					498,501,530,531
GC050130	RENAULT					506,513
GC050131	RENAULT					506,511,513
GC050132	OPEL/RENAULT					418,516,517
GC050137	RENAULT					501,522,523,525,531
GC050143	RENAULT	7701210040/8200441337/ 8200441340/8200598563			15-1650	495,496,497,528
GC050145	RENAULT					500,526,527
GC050149	RENAULT					523
GC050152	RENAULT					498
GC050153	SKODA/VOLKSWAGEN					566,738
GC050157	DACIA/RENAULT	391019671R/391001162R/8200725504/ 8200725503/8200725511/8200725510			15-1727	139,500,501,517, 526,527,531,532
GC050162	DACIA	391014021R/391011406R/391004751R/ 391006276R/8200788674/8200788672			15-1728	139
GC050163	RENAULT					500,517,526,527,532
GC050170	SEAT/SKODA/VOLKSWAGEN	1S0498099	305834	25640		564,566,697,738
GC051001	HONDA/ROVER	44340SN7315/44430SN7315/ GCV1112/GCV1117	302137/302138	20918/20919	15-1284	247,540
GC051002	ROVER	BAU5439/BAU5440	301032/302132	20914	15-1090	540,541
GC051003	ROVER	GCV1088/TFB000090	303480	21537	15-1303	538
GC051004	ROVER	GCV1119/TFB000110	303481	21538	15-1288	539
GC051005	ROVER	GCV1076/TDJ10016	302133	20889	15-1366	539
GC051006	ROVER	GCV1075	302134	20894	15-1270	538,539
GC051007	ROVER	GCV1146/TFB000140	303486	21543	15-1383	539
GC051008	ROVER	TFB000060			15-1408	539,540
GC051009	ROVER	17H8600/CGV1053/GCV1105	302046	20895	15-1039	541
GC051010	ROVER	BAU5466	300963/302052	20899	15-1205	537,541
GC051011	ROVER	GCV1181/TDJ100580	303476	21533	15-1431	540
GC051013	AUSTIN/ROVER	27H7567/BAU2018/BAU4444	302044	20896	15-1038	76,541
GC051014	MITSUBISHI					341
GC051015	LAND ROVER/ROVER					297,298,299,540
GC051016	LAND ROVER	RTC6862				296
GC051017	ROVER	44340SN7003	302136	20920		540
GC051018	ROVER	GCV1118			15-1299	539



G-AP Ref.	MAKE	ADAPTABLE TO OE	GKN	SPIDAN	METELLI	PAGE
GC051020	LAND ROVER	TDJ100470	303412	20604	15-1537	297,298
GC051021	HONDA	44011ST3E70/44011ST3G50/ 44011ST3G70/44014ST3E51				252,253
GC051024	ROVER					538
GC051028	MITSUBISHI					347
GC052001	SAAB	4242236/4399325/4610580	302459	23639	15-1269	541,542
GC052002	SAAB	8952905	301056/302165	23657	15-1168	545,546
GC052003	SAAB	4002911/8963571/8983571	302162	21906	15-1170	545
GC052004	SAAB	8990574/9102880	302160/302164	21907/22109	15-1031/15-1062	544,545
GC052005	SAAB					542
GC052007	SAAB	4103263/4610572	302201	23659	15-1169	546
GC052008	SAAB/VOLVO	5232897			15-1487	541,542,544,741
GC052010	SAAB	4000659	301062/302167	21909	15-1144	544,545
GC052011	SAAB	4103255	302200	23658	15-1166	546
GC052012	SAAB	12804149/12804150/93186026			15-1652	541,542,544
GC053001	SEAT/SKODA/VOLKSWAGEN	1K0407311F/1K0498099D/1K0498099DX	304325	23687	15-1465	548,550,552,562,574, 576,579,682,684,687, 688,690,691,692
GC053002	SEAT/SKODA/VOLKSWAGEN	6Q0407311D/6Q0498099F/6Q0498099FX	304436	24089	15-1415	554,557,568,716
GC053004	AUDI/VOLKSWAGEN					71,700
GC053005	SEAT/VOLKSWAGEN	6N0407311/6N0498099/6N0498099X/ JZW498340CX/6N0498340X	302764/302796	23675	15-1190	552,553,697
GC053006	FORD/VOLKSWAGEN					216,674,694,695,718
GC053007	SEAT/VOLKSWAGEN	357407311/357498099/191407311B/ 191407311C/191407311F/191407311L/ 191497311J/191498099A/191498099AV/ 191498099AX/191498099B/191498099BV/ 1H0407311D/1H0498099/1H0498099V/ 1H0498099X/1H0498340X/357498099A/ 357498099D/357498099X/191407311J/ JZW498340BX/191498099BX	301070/301947/ 302175/302177	20399/ 22494/ 23548	15-1009	553,554,556, 668,675,713
GC053008	SEAT/VOLKSWAGEN	171407311F/191407311/191498099/ 171498099A/171498099C/191407311H/ 191498099F/191498099FV/191498099FX/ 191498340X/1H0407311C/JZW498340X	301023/ 302118/ 302123	22782/ 22461/ 22669	15-1021	553,554,555,556, 559,667,668,713
GC054001	SKODA	115420170/115420214/115420217/ 441072651586/441072651706/6U0407311/ 6U0498099A/6U0498099/115420174	302041/303001	20639/23152	15-1158	571
GC054002	SKODA/VOLKSWAGEN	6Q0498099A/6Q0498099C/6Q0498099CX	303555	21585	15-1403	567,568,569, 570,673,715
GC054003	VOLKSWAGEN					671,713,717
GC054004	VOLKSWAGEN	6QE498099B/6QE407311C	304624	24308	15-1531	673
GC054006	AUDI/SEAT/VOLKSWAGEN					22,558,714
GC054007	SUZUKI	4410254J00/4410154J01/4410154J00				596
GC056001	SUBARU	23221GA242/23221GA243	302106	22162	15-1018	592
GC056002	SUBARU	23221GA372/23221GA373/ 23221GA592/23221GA593				592,593
GC056003	SUBARU	28021AA051/28021AA052/ 28021AA053/28021AA150/ 28021AA151/28021AA152/28021AA501	300929/302022	22179	15-1151	591
GC056004	SUBARU	28021AA021/28021AA022/28021AA031/ 28021AA032/28021AA033/28021AA130/ 28021AA131/28021AA132/28021AA511/ 28021AA551/28021AC130/28091AA010/ 28091AA012/28091AA014/28091AA020/ 28091AA024/28021AA560/28021AC150/ 28021FC031AT/28091AA011/28091AA021/ 28091AA024AT/28091AA042/28091AA043	300848/301946	22175	15-1084	588,589,590,591
GC056005	SUBARU	28021AA003/28021AA011/28021AA012/ 28021AA013/28021AA160/28021AA161/ 28021AA162/28021AA481/28021AA491/ 28021AA541/28021AC090/28091AA094/ 28091AC090	300895/301991	22177	15-1247	586
GC056006	SUBARU	723220041/723221971/723291530/723291540	302781	22185		590
GC056007	SUBARU	28321KC001/28321KC041/28321KC051	303986	22967		592,593
GC056008	SUBARU					588,589,590,591
GC056009	SUBARU	28021AC200/28091AC120/28093AC040				589
GC056010	DAIHATSU/SUZUKI	4410175F02/4410175F20/ 4410175F32/4410275F20/4410275F32	303987	22968		149,600
GC056011	SUBARU	723221055/723291013	301007/302102	22151	15-1017	592
GC056012	SUBARU	723221392/723291003	301009/302104	22154	15-1040	592
GC056013	SUBARU	23221GA232/23221GA233	301012/302107	22166	15-1046	592

G-AP Ref.	MAKE	ADAPTABLE TO OE	GKN	SPIDAN	METELLI	PAGE
GC056014	SUBARU	723251001/723251011/723291130/ 723291140/723291300/723291301/ 723291310/723291311	300868/301969	22174	15-1274	590
GC056015	SUBARU					586
GC056016	SUBARU	723291570				590
GC056017	SUBARU					586
GC056020	SUBARU					586,590
GC056021	SUBARU					586,587,588,589
GC056022	SUBARU					593
GC056024	SUBARU					588
GC056026	SUBARU	28094AC060/28321AE012				586,589,591,593
GC056027	SUBARU					586
GC056028	SUBARU					591
GC056029	SUBARU					590
GC056030	SUBARU		302782	22184		590
GC056031	SUBARU					590,593
GC056039	SUBARU	28021FA110	303870	23975		588,589,590,591
GC056040	SUBARU	28021AC210/28021AC280/28021AC281/ 28091AC091/28091AC130/28093AC030				588,590,591
GC056041	SUBARU	28321SA030/28321SA031/28321SA040/ 28321SA050/28321SA051/28321SA033				586
GC056042	SUBARU	28321AG000/28321AG010/28321AG011/ 28321AG012/28321AG020/28321AG021/ 28321AG022				591,592,593
GC056048	SUBARU					588,589
GC056053	SUBARU		303871	23976	15-1319	593
GC056057	SUBARU	28321FE001/28321FE020/28321FE110				589,590
GC056058	SUBARU	28321FE191/28321FE192				589
GC056060	SUBARU	723221981				590
GC056067	SUBARU	28321FE040/28321FE041/28321FE061/ 28321FE081/28321FE082/28321FE090/ 28321FE091/28321FE092/28321FE130/ 28321FE131/28321FE150/28321FE151/ 28321FE170/28321FE171/28321FE181				588
GC057001	SUZUKI	44102M72F12/44102M72F21/44102M72F41	302980/303178	21030		594
GC057002	SUZUKI	4410160G50/4410160G52/ 4410260G50/4410260G52				594
GC057003	SUZUKI	4410171C10/4410171C41/ 4411463B60/4410171C30	303004	21090	15-1252	599
GC057006	SUZUKI	4410182013/4410282013/4411582020/ 4410162D00/4410162D01/4410170B12/ 4410170B50/4410260A00/4411663B20				593,599,600
GC057007	SUZUKI	4410160B12/4410160B20/4410160B30/ 4410162B10/4410162B11/4410162B12/ 4410162B22/4410163B10/4410163B20/ 4410260B12/4410260B20/4410260B30/ 4410262B11/4410262B12/4410262B22/ 4410263B10/4410263B20/4410263B21/ 4411660B20/4411660B30/4411762B10/ 4411662B10/4411663E10/4411763B20	302628	21087	15-1114	594
GC057008	SUZUKI	4410272F00				594
GC057009	SUZUKI	4410278E00/4410167D00/4410178E00			15-1540	596
GC057010	SUZUKI	4410160A00/4410160A01/ 4410160A10/4413160A00				596
GC057011	SUZUKI	4410164B10/4410164B11/4410164B20/ 4410171C12/4410264B10/4410264B11/ 4410264B20/4411664B10	302586/302629	21088	15-1149	599
GC057012	SUZUKI	4410180E21/4410280E21			15-1360	599
GC057013	SUZUKI				15-1361	594
GC057014	SUZUKI	4410160G20/4410160G22	303128	21007	15-1266	594,595
GC057015	SUZUKI	4410160G23/4410160G33/4410160G62/ 4410160G72/4410260G23/4410260G30/ 4410260G62	303739	22935		594,595
GC057016	SUZUKI	4410160G60/4410260G60				595
GC057017	SUZUKI	4410177E00/4410277E00/4410177E01/ 4410277E01/4410277E02	303872	23977		600
GC057018	SUZUKI	4410160G42/4410160G43/4410160G44/ 4410164B12/4410260G42/4410264B12				595
GC057019	SUZUKI	4410183000/4410183300/4410183301/ 4410283000/4410283300/4410283301	303738	22934		598
GC057020	SUZUKI	44101A83300				598
GC057021	SUZUKI					594,595
GC057022	SUZUKI	4410276GK0				594
GC057023	SUZUKI					595,596

G-AP Ref.	MAKE	ADAPTABLE TO OE	GKN	SPIDAN	METELLI	PAGE
GC057024	SUZUKI	4410175F01/4410175F20/4410175F31/ 4410175F51/4410175F52/4410176G70/ 4410178F20/4410178G30/4410180G11/ 4410275F02/4410275F20/4410275F31/ 4410276G70/4410279C00				600
GC057027	SUZUKI	44102M79F60/44102M79F50/ 44101M79F50/44101M79F70/44101M79F60				594
GC057029	SUZUKI					594,595
GC057031	SUZUKI					600
GC057033	SUZUKI					597
GC057034	SUZUKI	4410180000/4410180001/ 4410280000/4410280001	302777	21089		598
GC057035	SUZUKI	4410160A20/4413160A01/4413260A00	301970	21082	15-1380	598
GC057037	SUZUKI	4410160G00/4410160G01/4410160GB0/ 4410160GH0/4410160GN0/4410260G00/ 4410260GB0/4410260GH0/4410260GN0	303740	22936	15-1365	594
GC057038	SUZUKI					594,599
GC057039	SUZUKI	4410175H10/4410176G70/4410180G00/ 4410180G11/4410272J10/4410276G70/ 4410279C00/4410280G00/4410180G20			15-1665	596
GC057041	SUZUKI	4410154G50/4410155G00/4410254G50/ 4410255G00/4410254G5000109	305464	25241		593,595,597,598
GC057042	SUZUKI	4410162J90/4410163J00/4410163J10/ 4410163J80/4410262J90/4410263J00/ 4410263J30/4410263J50/4410263J80/4410162 J01			15-1602	596,597,599,600
GC057043	CHEVROLET / GEO/SUZUKI					97,599
GC057048	SUZUKI	4410180E00/4410280E00/4410180E01/ 4410280E01/44102M72F12	303179	21031		594
GC057053	MARUTI	4411584312/4411584332/4411584342/ 4411684332/4411684342				301,302
GC057054	SUZUKI					597,598
GC057061	SUZUKI	4410179FA0/4410279FA0/ 44101M79F75/44101M79FA0			15-1794	594
GC057062	SUBARU/SUZUKI	4410186G00/4410286G60/4410186G01			15-1614	590,596,597
GC057067	SUZUKI	4411765J00				596
GC057076	SUZUKI	44101M79F10				594,597
GC057078	FIAT/SUZUKI					187,600
GC057079	SUZUKI	4410186G60/4410286G50				597
GC057081	SUZUKI	4410186GA0/4410286GD0				596
GC057083	SUZUKI					594
GC057086	SUZUKI		303873	23978		600
GC057088	TATA					601
GC057092	SUZUKI	4410180J11				600
GC057095	SUZUKI	4410162J20/4410262J20/4410262J30				600
GC057096	SUZUKI					596
GC057097	SUZUKI					596,597
GC057100	OPEL/SUZUKI	93194659/44101T51K90000/ 4410251K90/44102T51K90000	304914	24643	15-1723	385,598
GC057103	SUZUKI					597
GC057104	SUZUKI					596,600
GC057105	SUZUKI	4410186G30/4410286G30/4410286G30000	303884/305808	25614		596
GC057108	SUZUKI					595
GC057112	SUZUKI					593
GC057117	SUZUKI					600
GC057125	SUZUKI	4410176G40/4410176G60/4410176G61/ 4410276G40/4410276G60/4410276G61				597
GC057126	SUZUKI					596
GC057127	SUZUKI					596
GC057141	SUZUKI	4410180J50/4410180JE0/4410280J50				600
GC057149	SUZUKI	4410280J10				600
GC057152	SUZUKI					595
GC057157	SUZUKI	4410176G00/4410176G01/4410176G10/ 4410176G11/4410276G00/4410276G01/ 4410276G10/4410276G11				593,597,601
GC057159	SUZUKI	4410160G31/4410160G51/4410160G70/ 4410260G20/4410260G70				595
GC057160	SUZUKI	4410160G90/4410260G01/4410260G10				595



G-AP Ref.	MAKE	ADAPTABLE TO OE	GKN	SPIDAN	METELLI	PAGE
GC059001	TOYOTA	4341002010/4341002011/4341012030/ 4341012070/4341012090/4341012091/ 4341012101/4341012140/4341012141/ 4341012151/4341012170/4341012171/ 4341012351/4341012352/4341012353/ 4341020020/4341020031/4341020040/ 4341020180/4341020181/4341020220/ 4341032010/4341032011/4341032020/ 4341032022/4341032030/4341032031/ 4341032041/4341032060/4341032061/ 4342012040/4342012041/4342012070/ 4342012100/4342012101/4342012110/ 4342012140/4342012141/4342020010/ 4342020060/4342020070/4342020120/ 4342020291/4342020301/4342020380/ 4342032011/4342032030/4342032031/ 4342032041/4342042021/4346019286/ 4347019236/4347039086/4341012H00/ 4342051Y10/4341012180/4342041Y10/ 4342020340/4341032141/4341020530/ 4341012040/4341012100/4341012150/ 4341012210/4341020010/4341020100/ 4341020342/4341032040/4341042021/ 4342012071/4342012111/4342020020/ 4342020170/4342032010/4342032040/ 4346019306/4233017020	302108/302110	22305/22307	15-1070	606,607,609,610, 611,612,613,614, 615,622,623
GC059002	TOYOTA	4341020310/4341020311/4342020241				608,610
GC059003	TOYOTA	4341020281/4341020301/4341020730/ 4341032070/4342020231/4342020500/4342032				607,610,616,617
GC059004	TOYOTA	4341006060/4341006161/ 4342006060/4342006161/4346009160	302800/302859	20179		606,607,608
GC059005	TOYOTA	4340312040/4341010200/4341020142/ 4341020440/4341020441/4346029098				605
GC059006	TOYOTA	4341010160/4341020451/4341020515	303866	23971		616
GC059007	TOYOTA	4340560040/4430560040			15-0217	618
GC059009	TOYOTA		302768/302967	20180		606,607
GC059010	TOYOTA	4341032111/4342032091				610
GC059011	TOYOTA	4341020670/4341032130/4341032131/ 4341032180/4341032181/4341033010/ 4342020430/4342032110/4342032111/ 4342033010				607,608,610, 616,617,623
GC059012	TOYOTA	4341020251/4341020680/4341032150/ 4341033020/4341033022/4342020201/ 4342020440/4342033020				607,616,621
GC059013	TOYOTA	4341010070/4341010071/4342010070/ 4342010071/4346019415			15-1271	624
GC059014	TOYOTA					606
GC059015	TOYOTA	4341026040/4343026031/4343035010/ 4346039025/4346039026/4346039027/ 4346039046/4346039175/4346039275/ 9031660004/4346035070	303867	23972		601,618
GC059016	TOYOTA	4343026013/4343026021/4343026032/ 4343026040/4343026041/4343035011/ 4343035012/4343035021/4343035022/ 4346029067				617,618,619
GC059017	TOYOTA	4347019827/4342016201/ 4341016270/4341016281	303283	21158		611,624
GC059018	TOYOTA	4341012400/4341032170/ 4342012191/4342020290				612
GC059019	TOYOTA	4341012181/4341012200/4341012360/ 4341020231/4341020291/4341020540/ 4341020580/4342012360/4342020380/ 4342020490/4342032121/4342032122/ 4342042020/4342020420	303587	21765	15-0351/15-1351	609,612,613, 615,621,622,623

G-AP Ref.	MAKE	ADAPTABLE TO OE	GKN	SPIDAN	METELLI	PAGE
GC059020	TOYOTA	4341005060/4341012122/4341012131/ 4341012260/4341012270/4341012350/ 4341012351/4341012352/4341012353/ 4341012420/4341012430/4341016132/ 4341016191/4341020151/4341020152/ 4341020341/4341020342/4341020430/ 4341020431/4341020450/4341020451/ 4341020470/4342005020/4342005080/ 4342012091/4342012250/4342012260/ 4342020111/4342020112/4342020281/ 4346019276/4346029099/4346080094/ 4346080145/4347019216/4347029108/ 4347080148	300878/301992	22311	15-1346	613,614
GC059021	TOYOTA	4341005060/4341012191/4341020101/ 4341020331/4341020444/4342002080/ 4342012161/4342020121/4346019365/ 4347019316/4341020432/4237019115/ 434602918	304322	23683	15-1347	613,614
GC059022	TOYOTA	4346009290/4346009490/4347009480/ 4347009500/4347009740	303894	21843	15-1483/15-1513	604,605
GC059023	TOYOTA	4341016070/4341016071/4341016111/ 4341016131/4341016150/4341016151/ 4341016160/4341016161/4341016210/ 4342016070/4342016071/4342016101/ 4342016121/4342016122/4342016140/ 4342016141/4342016151/4346019165/ 4346019167/4346019516/4346019536/ 4346019556/4346019626/4347019137/ 4347019496/4347019516/4347019536/ 4346019166				613,614,616
GC059024	TOYOTA	4342005130/4346009331/4346009510/ 4347009541/4347009760/4641005310/ 4646009331	303445	21297		604,605
GC059025	TOYOTA	4347059015			15-1392	626
GC059026	TOYOTA	4341052050/4341059050/4342059050/ 4346059025/4347059025/4341052040	303896	21845	15-1460	626
GC059027	TOYOTA	4340560100/4340560110				620
GC059028	TOYOTA	4346009270/4347009440/ 4347009480/4347009560	304827	24554	15-1484	602,604,605
GC059029	TOYOTA	4341052010/4342052010/4346059055				621
GC059032	TOYOTA		303291	21164		624
GC059034	TOYOTA	4343035030/4346039065	305455	25232		619,622
GC059035	TOYOTA	4346059125/4347059065/4347059115			15-1447	626
GC059036	TOYOTA	4341002180/4341012030/4341012500/ 4341012530/4341032301/4342002200/ 4342012450/4342012580/4342032231				615
GC059037	TOYOTA	4341002240/4342002270/4346009600/ 4346009601/4347009A14/4341005330	304693	24381	15-1539	612
GC059038	TOYOTA					626,627
GC059039	TOYOTA					623,624
GC059040	TOYOTA	4341010101/4341010110/4341010121/ 4342010101/4342010110/4342010121/ 4346019496				624
GC059041	TOYOTA	4340560070/4340560080	303992	22973		620
GC059042	TOYOTA	4346049146/4347049226			15-1485	605
GC059043	TOYOTA	4347029635/4347029636				605
GC059044	TOYOTA	4346009611				612
GC059045	TOYOTA	4343028011/4346029056/4346029057				620,621
GC059046	TOYOTA	4340560120				620
GC059047	TOYOTA	4341002220/4341012510				615
GC059048	TOYOTA	4341006180				606,607
GC059050	TOYOTA	4340560015/4340560016/4340560020	301095	22310		618
GC059053	TOYOTA					624,625
GC059054	TOYOTA	4341010010/4341010020/4341010021/ 4341010030/4341010040/4341010050/ 4341010060/4341010090/4341010130/ 4342010020/4342010021/4342010030/ 4342010060/4342010090/4342010130/ 4346019085/4346019086/4341010131	302785	22312	15-1253	624
GC059055	MAZDA/TOYOTA					313,621
GC059056	TOYOTA	4341020060/4341020061/4341020062/ 4341020070/4341020071/4341020072/ 4341020073/4342020040/4342020041/ 4342020042/4342020050/4342020051/ 4342020052/4342020053	302791	22313	15-1134	610

G-AP Ref.	MAKE	ADAPTABLE TO OE	GKN	SPIDAN	METELLI	PAGE
GC059058	TOYOTA	4341003010	303277/303278	21155	15-1334	606
GC059059	TOYOTA					606
GC059060	TOYOTA	4342033030/4342033120/ 4347039185/4441033030			15-1326	606,607
GC059061	TOYOTA					602,607
GC059062	TOYOTA					606,607,608,609, 610,611,612,613, 614,615,616,621, 622,623
GC059063	TOYOTA	4341001030/4342001030				610,612,613,615
GC059064	TOYOTA	4340560030/4340560050			15-0218	620
GC059065	TOYOTA	4341033030	303864	23969		606,607
GC059066	TOYOTA					606,623,625
GC059070	TOYOTA	4341012161				613
GC059071	TOYOTA					624
GC059072	TOYOTA					601,624
GC059073	TOYOTA	4343028040				617
GC059075	TOYOTA					619
GC059081	TOYOTA	4341042120/4341042140/ 4346049106/4347049196			15-1536	623
GC059082	TOYOTA					611
GC059083	TOYOTA					603,604,605,611,625
GC059085	LEXUS/TOYOTA	4343060020/4343060040/4346069145	305451	25228		301,620
GC059086	TOYOTA					604,605
GC059087	TOYOTA	4341006050/4342006050				623
GC059089	TOYOTA	4341028010/4341032211				608,617,620,621
GC059091	TOYOTA		303323/303324	21186		626
GC059092	TOYOTA	4346009420				618
GC059095	TOYOTA	4341006151				607
GC059100	TOYOTA					624
GC059101	TOYOTA	4340560060/4340560070	303318	21177	15-1386	619,620
GC059106	TOYOTA					606
GC059107	TOYOTA	4343060060/4346069055/ 4346069105/4343060061				619,621,622
GC059117	SUZUKI	4410181A00/4410281A00/ 4410181A80/4410281A80			15-0459	597
GC059120	TOYOTA	4341005140/4341020582/ 4342005100/4342012330	303865	23970		608,609,622,623
GC059125	TOYOTA					606,607,622
GC059129	TOYOTA					626
GC059130	TOYOTA					611
GC059131	TOYOTA	4341012660/4347080020/4346080125/ 4347009W20/4346009T10				611,615,625
GC059134	TOYOTA					624
GC059136	TOYOTA	4341012490/4341047020/ 4342012420/4342047020/4346019795		25085		611,622
GC059137	TOYOTA	4341052070/4342052070/4346059045/ 4347059045/4346059365/4346059076/ 4347059076/4347059455	304703	25084/24391	15-1450	626,627
GC059152	TOYOTA	4341052110/4342052110				625
GC059153	TOYOTA	4341012600/4341012670/4341020780/ 4341047010/4342042091/4347080018				612,625
GC059154	TOYOTA	4341028051				601,617,619
GC059155	TOYOTA		303868	23973		610
GC059160	TOYOTA					607
GC059161	LEXUS/TOYOTA	4341033040/4341033140/4342006180/ 4342033040/4342033130/4342033172	302799/302860	20178	15-1325	301,606,607
GC059162	LEXUS/TOYOTA					301,602,607
GC059163	CHEVROLET/GEO/TOYOTA					96,240,612
GC059166	TOYOTA	4343028050				616
GC059167	TOYOTA	4342042050/4346049065/4346049106/ 4346049125/4346049126/4346049165/ 4346049166/4346049167	304650			623
GC059168	TOYOTA		305309	25086		626
GC059173	TOYOTA	4342048042				617
GC059175	TOYOTA	4341028030/4341028040/4341042060/ 4341048071/4342028030/4342028040/ 4342042120/4342048091/4341048061/ 4342048061/4341005412				601,606,617, 618,619,625
GC059177	TOYOTA	4341016141/4342016130				622
GC059182	TOYOTA	4346029425				603
GC059183	TOYOTA	4347009330				607
GC059186	TOYOTA					609,611,621
GC059188	TOYOTA					606



G-AP Ref.	MAKE	ADAPTABLE TO OE	GKN	SPIDAN	METELLI	PAGE
GC059190	TOYOTA	4341052120/4341052130/4342052120/ 4342052130/4346059115/4347059105				625
GC059191	TOYOTA					622
GC059196	TOYOTA	434100D120				624
GC059198	TOYOTA					621
GC059199	TOYOTA	434300K020/4346009V10/4346080033/ 4346080035/4346009V20				618,619,625
GC059201	TOYOTA	4343028031/4343028051				617,619,620,621
GC059202	TOYOTA	4341010210/4342010190				624
GC059203	TOYOTA	4341032090/4341032271/ 4342032070/4342032211				608
GC059207	TOYOTA	434100D110				625
GC059212	TOYOTA	4340598001				605
GC059213	TOYOTA	4340502230/4341002570/4341002580/ 4342002610/4342002620/4346009R20/ 4346009R30/4347009S50/4347009S60	305252	25009		601,602
GC059215	TOYOTA					607
GC059226	TOYOTA	4341002270/4342002300/4346009621/ 4346009A21/4346009A22/4346009P50/ 4346009P70/4347009A15/4347009A38/ 4347009A39	304823	24550	15-1544	603,612
GC059227	TOYOTA	4341010250				624
GC059231	TOYOTA					626
GC059232	TOYOTA	434100D170/434200D170/ 4346009M70/4347009L40				626
GC059233	LEXUS/TOYOTA					301,603,615,616
GC059242	TOYOTA	434300K030/434300k022				618,619
GC059243	TOYOTA					618
GC059244	LEXUS/TOYOTA	4346049406/4347080318				301,619,622,627
GC059245	TOYOTA	4347049665				601,605,616, 621,622,623
GC059253	TOYOTA					617
GC059254	TOYOTA					617
GC059255	TOYOTA	4341052110/4342052110				625
GC059261	LEXUS/TOYOTA	4341020560/4341020600/4341020800/ 4341021011/4341021041/4342020560/ 4342020590				301,610
GC059262	TOYOTA	4341012531/4341020781/4341021060/ 4341032302/4342020581/4342032232				610
GC059263	TOYOTA					626
GC059266	DAIHATSU/TOYOTA	43410B1020/43410BZ020/ 43420B1020/43420BZ020				144,148,621
GC059268	DAIHATSU/TOYOTA	43410B1010/43410B1030/ 43410BZ010/43420B1010/43420BZ010				144,148,621
GC059269	TOYOTA	4341005241/4342005260/ 4347009420/4347009480				602
GC059270	TOYOTA					626,627
GC059271	TOYOTA					625
GC059274	TOYOTA	4341052210/4341052220/4342052210/ 4342052220/43410522210/434100D280/ 4341052270/4341052330/4342052261/ 4342052271				625
GC059285	FORD/LAND ROVER/VOLVO	LR003159/LR005870/36000363/36001194				209,229,230,233, 297,298,746,748, 753,754
GC059288	TOYOTA					622
GC059294	TOYOTA	4347080013/4342048090				601,602,605,606, 613,622,625
GC059297	TOYOTA					626
GC059304	TOYOTA	434100E020/434100E020/434100W160/ 434200E021/434200W190				617,618
GC059305	TOYOTA	434100E011/434200E011/ 434100E011/434200E011				618
GC059306	TOYOTA	4341030021/4342030021				620
GC059308	TOYOTA	4341052180/4341052280/ 4342052180/4342052280				625
GC059314	TOYOTA					622
GC059317	TOYOTA					615
GC059318	TOYOTA					602
GC059320	TOYOTA	4341048010/4341048030/4341048040/ 4342048010/4342048030/4342048050				617
GC059321	TOYOTA	4341058020/4342058010/4341042200/ 4341042160/4342028090				617
GC059332	TOYOTA	4346009M50				626

G-AP Ref.	MAKE	ADAPTABLE TO OE	GKN	SPIDAN	METELLI	PAGE
GC059336	TOYOTA	4343060071				620
GC059337	TOYOTA	4341002031				613
GC059340	TOYOTA	4346049405				622
GC059344	FORD/VOLVO					213,214,228,229,230, 232,233,746,748,750, 753
GC059345	TOYOTA	434708Z034				604,625
GC059365	TOYOTA	434708Z039				604
GC059370	TOYOTA					601,616,621,622,625
GC059383	TOYOTA	4342042160/4341042180				616,617
GC059384	TOYOTA	434100D190/434200D190/ 4341074060/4342074050				619,625
GC059385	TOYOTA	4342052190/4342052191/ 4341052191/4341052190				625
GC059387	TOYOTA	4341012790/4341012810/4342012730/ 4342012750/4342012731/4342012751				611
GC059390	LEXUS	4237039135				301
GC059431	TOYOTA	4347039575/4347039465				601,606,622
GC059432	TOYOTA					623
GC060001	OPEL/OPEL LCV/ VAUXHALL/VAUXHALL LCV					405,406,433,646,662
GC060005	RENAULT	8200452268/8200452273/ 8200776535/8200776537	305133	24874		535,536
GC060006	OPEL/VAUXHALL					408,648
GC061001	VOLKSWAGEN	171407311/171498099	301018/302113	22454	15-1004	674,694,695,718
GC061002	VOLKSWAGEN	871407311/871498099/871498099A/ 871498099AX/871498099X	301022/302117/ 302122	22452/22469	15-1034	671,714,715
GC061003	VOLKSWAGEN	701498099/701407321B/701498099V/ 701498099X/701498340X	300861/301963	20595	15-1123	727,728,732,733,734
GC061004	VOLKSWAGEN	701407321C/701498099A/701498099AV/ 701498099AX/701498340AX	300862/301964	20596	15-1124	727,728,732,733,734
GC061005	VOLKSWAGEN	701407321D/701498099B/ 701498099BX/701498340BX	302363/302446/ 303450	21945/22900	15-1230	727,728,729,732, 733,734
GC061006	VOLKSWAGEN	701407321E/701407321G/701498099C/ 701498099CX/701498340CX/7D0498099	302447/303451	21946/22901	15-0229/15-1229	728,729,732,733,734
GC061007	VOLKSWAGEN	6X0498099/6X0498099X	304814	24541	15-1466	697,717
GC061009	VOLKSWAGEN	7H0407321A/7H0407321B/7H0498099	303993	23979	15-1478	671,698,729,734, 735,736,737
GC061010	SEAT/SKODA/VOLKSWAGEN	6QE498099			15-1533	557,570,580,673,717
GC061011	VOLKSWAGEN	7H0407321/7H0407321C/7H0407321D/ 7H0498099A/7H0498099B	303995	23981	15-1479	698,699,729,730,731, 735,736,737,738
GC061012	SKODA/VOLKSWAGEN	3B0498099/3B0498099D/ 3B0498099DX/8D0407305Q/3B0498099AV	303605	21812	15-1375	582,702,708
GC061013	VOLKSWAGEN	171407311J/171407311K/171498099B/ 171498099BX/171498099CX	301020/301021/ 302115/302121/ 302124	23537/22456/ 22457/22670	15-1005	666,674,694,695,718
GC061014	VOLKSWAGEN					673
GC061017	VOLKSWAGEN					721
GC061018	SEAT/VOLKSWAGEN	357498099DV/357498099DX/357498340AX	300849/301948	24911/22600		553,554,556 ,668,675,716
GC061019	VOLKSWAGEN					673
GC061021	AUDI	8N0498099/8N0498099A/8N0498099AX				74,75,76
GC061022	FORD/SEAT/VOLKSWAGEN					214,547,719,720
GC061023	VOLKSWAGEN	377498099G				673,700
GC061028	VOLKSWAGEN	337407311C				673,700,717
GC061030	VOLKSWAGEN	377498099N				673,700
GC061031	VOLKSWAGEN					673,700
GC061033	VOLKSWAGEN					673
GC061034	VOLKSWAGEN	377498099F				673,700
GC061037	VOLKSWAGEN					671,672,713,717,721
GC061042	VOLKSWAGEN	7L6407271G/7L6498099B			15-1633/15-1644	722,724
GC061045	AUDI/SEAT/VOLKSWAGEN	3C0407311A/3C0498099	304640	24326	15-1658	26,30,549,550,551, 552,561,565,669,670, 672,686,704,706,710 ,726
GC061050	AUDI/VOLKSWAGEN	95534990100/95534990102/7L0407321D/ 7L0498099/7L0498099A/7L0498099AX/ 7L0498099C/7L0498099CX	304557	24237	15-1659	73,722,723,724

G-AP Ref.	MAKE	ADAPTABLE TO OE	GKN	SPIDAN	METELLI	PAGE
GC061059	AUDI/CHEVROLET/ SEAT/SKODA/ VOLKSWAGEN	5M0498099			15-1708	24,25,27,28,29,31,32, 33,93,549,551,561, 562,563,564,574, 576,578,581,582, 583,584,668,669, 671,672,682,690, 692,693,694,701, 707,726
GC061062	VOLKSWAGEN	2H0498099A/2H0498099				663
GC061070	SEAT/SKODA/VOLKSWAGEN					553,556,567,568, 569,715,716
GC061075	AUDI					34,35,36,37,38, 39,45,46,47,48,49
GC062001	VOLVO	5003846/5003847/6843198/8111303/8111304/ 8601100/8601101/9122567/9122833/9163595	301028/302148	20931	15-1133	741,746
GC062002	VOLVO	5003911/5003912/8111307/8111308/8601102/ 8601103/9122919/9122920/9163594	302192	20930	15-1368	741,742
GC062003	VOLVO		303427	20928		743,749
GC062004	VOLVO	34303966	302142	20827	15-1369	740
GC062005	VOLVO	3433105/34331058	302143	20828	15-1376	740
GC062006	VOLVO	34349050	302057	20812	15-1273	740
GC062007	VOLVO	34331017	302058	20826	15-1272	740
GC062008	VOLVO	30611702	303416	20583		742,743,748,749
GC062009	VOLVO	8602574/8602577/8603794/9463378/ 36000518/36000519	303526	21299	15-1538	741,742,744,745,746, 747,748,750,751,752, 753
GC062010	VOLVO	9463379/8601571/8251517/9463397	303560	20431	15-1706	741,743,744,746, 750,751
GC062011	VOLVO	30610835	303426	20587		742,749
GC062012	VOLVO	30611947/8251531/8601967/8601968	303423	20585	15-1642	743,749
GC062014	VOLVO					741
GC062016	VOLVO					741,742
GC062019	VOLVO					744,745,746,750, 751,752,753,754
GC062024	VOLVO					742,743,748
GC062031	VOLVO					754
GC062035	VOLVO	36000505/36000514			15-1673	754
GC062037	VOLVO					745,751,752,754
GC062038	VOLVO					744,745,746,747,748, 750,751,752,753
GC062039	FORD					206
GC062040	VOLVO					741,742,744,745,746, 747,748,750,751,752,7
GC064001	ZAZ		300950/302039	23159	15-1228	754
GC066001	SSANGYONG					586
GC068008	CHEVROLET	96639350				94
GC075002	TOYOTA	4237029245				618
GC075007	PIAGGIO	614627/614628/614694	304908	24637		482
GC099002	PEUGEOT					479
GC099003	PEUGEOT					461
GC099006	CITROEN					135,136,137
GC099008	PEUGEOT	3272AE/3273AL	303933	22273	15-1572	437,438
GC099009	PEUGEOT					436
GC099012	LADA	111102215012/11112215012			15-1341	289
GC099015	FORD	97FU4K258AA				197,201,219
GC099018	FIAT/OPEL/VAUXHALL	1603403/51733777			15-1594	182,407,647
GC099019	BUICK/CHEVROLET					91,93
GC099023	FIAT/OPEL/SAAB/VAUXHALL					157,394,396,397,398, 399,400,401,408,409, 410,419,426,427,428, 429,432,541,544,629, 635,637,638,639,640, 641,649,650,654,655, 657,658,659,661,662
GC099024	OPEL/VAUXHALL					394,395,396,397,398, 416,432,635,636,637, 638,640,652,661,662
GC099025	HYUNDAI	4950705A00/4950805A00				264
GC099032	JEEP					278,279
GC099037	MERCEDES BENZ	1693601572/1693602972/1693604372/ 1693604472/A1693601572/A1693602972/ A1693604372/A1693604472/1693601768/ 1693608372	304831	24558	15-1590	322,323,324, 325,326,327,328
GC099038	HYUNDAI					273
GC099042	MAZDA	GD1522510	303372	21200		312



G-AP Ref.	MAKE	ADAPTABLE TO OE	GKN	SPIDAN	METELLI	PAGE
GC099044	MAZDA					303
GC099045	MAZDA					312,320,321
GC099046	MAZDA	502623/MD0422510				314,319
GC099047	MAZDA					309
GC099048	MAZDA					309
GC099052	MAZDA					309
GC099053	KIA					288
GC099056	NISSAN		303141	21010		364
GC099057	DAEWOO					143
GC099059	SSANGYONG					586
GC099061	OPEL/VAUXHALL					390,391,392,431, 634,635,660,661
GC099064	OPEL					431
GC099065	CHEVROLET					93
GC099070	RENAULT					484,491,494,499
GC099076	GM/RENAULT	7702096438/REN770209643				243,533
GC099085	DACIA/RENAULT/RENAULT LCV	8200261838/8200264664/8200264667/ 8200356803/8200358163/8200358164/ 8200408418/8200432514/8200511122/ 8200511220/391000153R/391015451R			15-1501	140,141,493,498,500, 513,521,522,523,524, 525,526,528,537
GC099086	RENAULT					510
GC099087	RENAULT					495,496,502,503, 504,505,533
GC099088	RENAULT					508,509
GC099089	SUZUKI		303538	21438		594,595
GC099102	SUZUKI					594
GC099110	OPEL/VAUXHALL					385,627
GC099111	TOYOTA					606,616
GC099113	LAND ROVER	AEU2522				296,299
GC099115	TOYOTA					607
GC099124	TOYOTA	4341020292/4341020640/ 4347029445/4347029446				608,609,610
GC099125	TOYOTA					619
GC099128	CITROEN/PEUGEOT/TOYOTA	4346009C80/4347009C90/3272JY/3273JR/ 434100H010A/434100H010/434030H010	305154	24895	15-1529/15-1528	105,433,605
GC099129	FORD	1306055/1360389/1493004/1493012/1702527/ 1306777/1420577/1446232/1474431/1495063/ 1420578/1446235/1474438			15-1564	205,206,207,208,210
GC099132	FORD					205,206
GC099134	VOLKSWAGEN	337407311F				673,700,717
GC099136	SEAT/VOLKSWAGEN					554,555,559,674,716
GC099146	FORD/MERCURY					235,336
GC099147	JAGUAR					275,278
GC099151	ROVER	GCV1194/TDJ100590	303482	21539	15-1514	540
GC099154	FORD/VOLKSWAGEN	547407311				197,697
GC099155	FORD	1322209/1322221			15-1562	206
GC099158	SSANGYONG	4130008001				586
GC099159	HONDA	44014S91010/44014S9A010/ 44305SCAG00/44306SCAG00				255
GC099162	HONDA	628126/44010S50010/44310S50300				258
GC099164	HYUNDAI					261,266,275
GC099172	HYUNDAI					263
GC099176	MITSUBISHI					352
GC099181	HYUNDAI		303330	21182		269,270
GC099187	NISSAN					378
GC099190	NISSAN					370
GC099199	NISSAN					355,356,378,380,381
GC099203	NISSAN	3910172J10				370,371
GC099204	NISSAN	3910051M00/3910060A00/3910060A10/ 3910065A00/3910065A10/3910070A00/ 3910160A00/3910160A10/3910165A00/ 3910165A10				360,361,362,363, 375,376,378,379
GC099205	OPEL/VAUXHALL	0374049/374049/0374061/374061/90125875/ 90147008/93225238/93225287	301063/302168	21455	15-1008	386,387,410,411,412, 413,414,415,416,628, 630,631,641
GC099206	RENAULT					529
GC099207	RENAULT					492,502
GC099208	ROVER					540
GC099209	ROVER					537,539
GC099210	HONDA	44014ST3E01				253
GC099211	LAND ROVER	TDR100790				296
GC099212	SAAB	4000642/E152120186009	301061/302166	23656	15-1167	545,546
GC099213	RENAULT	8200198016/8200436366			15-1519	501,521,522,523, 524,525,531,532
GC099221	CITROEN					135,136,137

G-AP Ref.	MAKE	ADAPTABLE TO OE	GKN	SPIDAN	METELLI	PAGE
GC099225	HONDA		303364	21529		252,253
GC099230	MITSUBISHI/VOLVO					341,742,749
GC099232	KIA					285
GC099233	MAZDA					321
GC099236	NISSAN					372,373
GC099238	OPEL					387
GC099242	MG					336,337
GC099248	HONDA	44305S10J50/44306S10J50				255
GC099249	HYUNDAI					274
GC099252	NISSAN	39211BM727				356
GC099254	SAAB	5390489	304893	24622	15-1486	544
GC099255	SUBARU					590
GC099262	VOLVO					742,743,749
GC099267	PEUGEOT					436,438
GC099268	AUDI/VOLKSWAGEN	6E0407311/6E0498099			15-1547	23,663,697
GC099270	FORD	1434479/1434481			15-1674	235
GC099271	FORD/VOLVO	1483808/1493218/1667957/1667941/1667811/ 1437736/1460786/1667774/1459738/1446227/ 1446223/1483807/36001076/36001531/ 36001075/36000692/36001452/36001451/			15-1738	213,214,228,229, 230,232,233,753
GC099272	MAZDA					302,303
GC099273	MAZDA	GD4022510/GD4022510A/GD402550XA/ GD402560XA/GD382550X/GD622550X/ GD622550XA/GD622550XB/GD622550XC	304312			307,308,309
GC099281	SAAB					544
GC099282	TOYOTA	4346009530/4347009780/434100D020/ 434100D080/434100D150/434200D020/ 434200D080/434200D150	304728	24455	15-1557	626,627
GC099283	RENAULT					503,505,530
GC099284	FORD					235,236,237,238, 239,240
GC099285	MAZDA					319
GC099288	FORD	1223785/1302515/1359663/1493015/ 1676314/36001448/36002896/36002897 /36001450/36002144	304983	24711	15-1510	195,196,205,206, 207,208,209,210,212
GC099289	HYUNDAI/KIA					275,287
GC099290	DAIHATSU/TOYOTA	43410B4010/43420B4010				144,623
GC099291	RENAULT					511,512,513
GC099293	CITROEN/PEUGEOT					101,102,103,137, 138,480,481
GC099294	HYUNDAI/KIA	495002F000/495002F010/495012F000/ 495012F010/495912F000/495912F010/ 495912F090/495912F091				265,282
GC099298	ALFA ROMEO	46307934/46308773			15-1616	2,4,7,11,12
GC099299	DAIHATSU	43410BZ041/43420BZ041				149
GC099301	CITROEN/PEUGEOT					106,108,433
GC099302	TOYOTA	4341005380/4341005420/ 4342005331/4342005360				603
GC099309	PEUGEOT					436,438
GC099310	FIAT					187
GC099316	FIAT					157
GC099317	LDV					300,301
GC099318	FORD	1534270/1534271/1595088/1595093/1595105/ 1603121/1603122/8V413A327AA/ 8V413A327AX/8V413A328AA/8V413A328AB/ 8V413A328AX/9V4N3A327AA/9V4N3A328AA/ 1502118/1703321/1502109/1594945/1594946/ 8V413A327AB/	305520	25297	15-1787	219,220
GC099320	TOYOTA					602
GC099322	SUZUKI	4410278K00/4410265J00/4410165J00/ 4410178K00				596
GC099325	ALFA ROMEO/FIAT					12,182
GC099331	HYUNDAI					270
GC099339	SUBARU					586
GC099348	ALFA ROMEO	46308677			15-1710	11
GC099349	FORD					238,239
GC099351	AUDI	4F0407271K/4F0407272K/4F0498099B			15-1660	61,62,67
GC099354	SUZUKI	4410284A00				597
GC099366	CITROEN/PEUGEOT	3273LP/3273QK/3273LQ/3272LX/3272LW/ 3272LT/3273LR/3272PZ/3273XP/3272WV/ 3272QC/3272TN			15-1675	101,102,108,109,110, 111,112,113,119,120, 439,440,441,445,446, 447,448,449,450,451, 452,453,463,479,480, 481
GC099367	OPEL/SAAB/VAUXHALL					409,410,544, 649,650,651

## Obsolete Part Number Deleted(compared with catalogue 2015)

G-AP Ref.	G-AP Ref.	G-AP Ref.	G-AP Ref.	G-AP Ref.	G-AP Ref.
GDS81019	GCI45010				
GDS81022	GCI45014				
GDS81029	GCI57025				
GDS83029	GCI59010				
GDS83030	GC088020				
GDS85013	GC010044				
GDS88034	GC012016				
GDS88035	GC014028				
GDS10042	GC018008				
GDS10085	GC018022				
GDS10106	GC018065				
GDS10107	GC023040				
GDS10196	GC023072				
GDS10277	GC023159				
GDS12005	GC024049				
GDS14008	GC024059				
GDS14010	GC027053				
GDS15006	GC027059				
GDS15009	GC034097				
GDS18179	GC039095				
GDS23017	GC041168				
GDS23109	GC041287				
GDS23140	GC041291				
GDS24021	GC044062				
GDS26006	GC056052				
GDS27012	GC059138				
GDS27054	GC061024				
GDS27060	GC062015				
GDS27061	GC099075				
GDS34013					
GDS34069					
GDS41330					
GDS45197					
GDS50132					
GDS50291					
GDS51014					
GDS61066					
GDS61078					
GDS61120					
GDS64001					
GCI81007					
GCI83007					
GCI83019					
GCI83020					
GCI89010					
GCI89015					
GCI89016					
GCI89018					
GCI89025					
GCI89027					
GCI10008					
GCI14006					
GCI14010					
GCI14011					
GCI15002					
GCI18026					
GCI18027					
GCI21006					
GCI41036					



## New applications (compared with catalogue 2015)

G-AP Ref.	G-AP Ref.	G-AP Ref.	G-AP Ref.	G-AP Ref.	G-AP Ref.
GDS81010	GDS85044	GDS10288	GDS17068	GDS18012	GDS18382
GDS81047	GDS85045	GDS10291	GDS17069	GDS18018	GDS18402
GDS81056	GDS85052	GDS10292	GDS17076	GDS18083	GDS18405
GDS81066	GDS85053	GDS10293	GDS17077	GDS18175	GDS18406
GDS81067	GDS85054	GDS10294	GDS17078	GDS18176	GDS18407
GDS82005	GDS85058	GDS10295	GDS17079	GDS18189	GDS18408
GDS82008	GDS85060	GDS10306	GDS17080	GDS18190	GDS18409
GDS82009	GDS85061	GDS10309	GDS17081	GDS18191	GDS18413
GDS83036	GDS85063	GDS10325	GDS17088	GDS18192	GDS18414
GDS83065	GDS85064	GDS10335	GDS17089	GDS18193	GDS18434
GDS83066	GDS85066	GDS10340	GDS17099	GDS18194	GDS18435
GDS83236	GDS85067	GDS10343	GDS17101	GDS18195	GDS21035
GDS83241	GDS85068	GDS10344	GDS17102	GDS18197	GDS21036
GDS83255	GDS85069	GDS10345	GDS17106	GDS18198	GDS21050
GDS83261	GDS85070	GDS10348	GDS17107	GDS18199	GDS21051
GDS83267	GDS85071	GDS10361	GDS17108	GDS18201	GDS21053
GDS83269	GDS85073	GDS10362	GDS17109	GDS18202	GDS21054
GDS83270	GDS85081	GDS10363	GDS17110	GDS18206	GDS21055
GDS83271	GDS85082	GDS10364	GDS17111	GDS18209	GDS21061
GDS83273	GDS85085	GDS10380	GDS17112	GDS18213	GDS21063
GDS83278	GDS85091	GDS10381	GDS17113	GDS18230	GDS21070
GDS83288	GDS85093	GDS10382	GDS17115	GDS18231	GDS21072
GDS83289	GDS85098	GDS10383	GDS17116	GDS18232	GDS21073
GDS83290	GDS85107	GDS10384	GDS17117	GDS18240	GDS21074
GDS83291	GDS88061	GDS10385	GDS17118	GDS18248	GDS21075
GDS83292	GDS88082	GDS10396	GDS17119	GDS18251	GDS21076
GDS83293	GDS88093	GDS10419	GDS17120	GDS18252	GDS21092
GDS83300	GDS88094	GDS10420	GDS17121	GDS18259	GDS22019
GDS83302	GDS88095	GDS10421	GDS17122	GDS18260	GDS23020
GDS83303	GDS88107	GDS10422	GDS17123	GDS18261	GDS23042
GDS83304	GDS88108	GDS10423	GDS17124	GDS18262	GDS23155
GDS83306	GDS88115	GDS10424	GDS17136	GDS18280	GDS23164
GDS83310	GDS88137	GDS10425	GDS17137	GDS18290	GDS23165
GDS83311	GDS88150	GDS10427	GDS17141	GDS18291	GDS23188
GDS83322	GDS89067	GDS11006	GDS17142	GDS18292	GDS23189
GDS83329	GDS89073	GDS11007	GDS17143	GDS18293	GDS23190
GDS83330	GDS89074	GDS12058	GDS17144	GDS18294	GDS23191
GDS83337	GDS89082	GDS14035	GDS17145	GDS18295	GDS23192
GDS83345	GDS10053	GDS14036	GDS17148	GDS18296	GDS23198
GDS83346	GDS10126	GDS16001	GDS17149	GDS18322	GDS23199
GDS83347	GDS10173	GDS16002	GDS17151	GDS18323	GDS23216
GDS83349	GDS10210	GDS16009	GDS17152	GDS18324	GDS23250
GDS83350	GDS10221	GDS16021	GDS17153	GDS18325	GDS23259
GDS83352	GDS10229	GDS17010	GDS17157	GDS18335	GDS23266
GDS83355	GDS10234	GDS17011	GDS17158	GDS18336	GDS23270
GDS83362	GDS10237	GDS17040	GDS17159	GDS18337	GDS23287
GDS83363	GDS10238	GDS17044	GDS17170	GDS18340	GDS24002
GDS83364	GDS10239	GDS17045	GDS17171	GDS18341	GDS24033
GDS83373	GDS10244	GDS17046	GDS17172	GDS18342	GDS24058
GDS83374	GDS10248	GDS17050	GDS17178	GDS18343	GDS24104
GDS85006	GDS10249	GDS17052	GDS17179	GDS18350	GDS24129
GDS85010	GDS10250	GDS17053	GDS17180	GDS18361	GDS24140
GDS85011	GDS10251	GDS17054	GDS17187	GDS18362	GDS24141
GDS85019	GDS10253	GDS17056	GDS17190	GDS18363	GDS24147
GDS85024	GDS10270	GDS17057	GDS17191	GDS18364	GDS24148
GDS85025	GDS10283	GDS17059	GDS17192	GDS18365	GDS24153
GDS85026	GDS10285	GDS17060	GDS17193	GDS18366	GDS24156
GDS85041	GDS10286	GDS17062	GDS17194	GDS18367	GDS24157
GDS85043	GDS10287	GDS17067	GDS18011	GDS18381	GDS24162

## New applications (compared with catalogue 2015)

G-AP Ref.	G-AP Ref.	G-AP Ref.	G-AP Ref.	G-AP Ref.	G-AP Ref.
GDS24163	GDS27097	GDS35049	GDS41204	GDS44095	GDS50486
GDS24172	GDS27099	GDS35052	GDS41205	GDS44096	GDS50487
GDS24173	GDS27102	GDS35053	GDS41206	GDS45043	GDS50488
GDS24188	GDS27111	GDS35054	GDS41213	GDS45133	GDS50489
GDS24194	GDS27114	GDS35055	GDS41214	GDS45140	GDS50490
GDS24195	GDS27115	GDS35057	GDS41215	GDS45147	GDS50493
GDS24200	GDS27116	GDS35062	GDS41244	GDS45174	GDS50496
GDS24216	GDS27117	GDS35063	GDS41245	GDS45175	GDS50498
GDS24217	GDS27132	GDS35075	GDS41260	GDS45176	GDS50502
GDS24218	GDS27142	GDS35081	GDS41261	GDS45188	GDS50504
GDS24221	GDS27143	GDS35082	GDS41269	GDS45189	GDS50505
GDS24228	GDS27151	GDS35084	GDS41270	GDS45202	GDS50509
GDS24229	GDS27152	GDS35086	GDS41271	GDS50066	GDS50510
GDS24232	GDS27155	GDS35087	GDS41286	GDS50075	GDS50514
GDS24233	GDS27156	GDS38003	GDS41296	GDS50098	GDS50515
GDS24240	GDS27185	GDS38005	GDS41297	GDS50146	GDS50517
GDS24241	GDS27186	GDS39001	GDS41299	GDS50173	GDS50518
GDS24246	GDS27206	GDS39023	GDS41301	GDS50177	GDS50519
GDS24247	GDS27207	GDS39024	GDS41327	GDS50189	GDS50520
GDS24248	GDS30002	GDS39034	GDS41328	GDS50219	GDS50523
GDS24249	GDS30003	GDS39096	GDS41337	GDS50250	GDS50525
GDS24259	GDS30004	GDS39097	GDS41365	GDS50253	GDS50526
GDS24260	GDS30005	GDS39118	GDS41366	GDS50254	GDS50527
GDS24261	GDS32006	GDS39119	GDS41385	GDS50255	GDS50538
GDS24262	GDS34087	GDS39139	GDS41386	GDS50257	GDS50539
GDS24264	GDS34088	GDS39147	GDS41392	GDS50280	GDS50540
GDS24265	GDS34091	GDS39148	GDS41428	GDS50281	GDS50541
GDS24272	GDS34096	GDS39182	GDS41437	GDS50339	GDS50542
GDS24282	GDS34101	GDS39183	GDS41441	GDS50350	GDS50543
GDS24283	GDS34120	GDS39189	GDS41451	GDS50351	GDS50544
GDS24287	GDS34132	GDS39190	GDS41452	GDS50363	GDS50554
GDS24288	GDS34133	GDS39191	GDS41453	GDS50364	GDS50557
GDS24289	GDS34137	GDS39192	GDS41463	GDS50365	GDS50562
GDS24290	GDS34166	GDS39202	GDS41464	GDS50366	GDS50563
GDS24291	GDS34167	GDS39210	GDS41466	GDS50367	GDS50564
GDS24293	GDS34168	GDS39211	GDS41475	GDS50373	GDS50567
GDS24294	GDS34169	GDS39212	GDS44020	GDS50377	GDS50569
GDS24296	GDS34171	GDS39213	GDS44024	GDS50378	GDS50570
GDS24297	GDS34195	GDS39214	GDS44025	GDS50379	GDS51006
GDS24299	GDS34196	GDS39216	GDS44032	GDS50380	GDS51018
GDS24300	GDS34210	GDS39217	GDS44042	GDS50383	GDS51019
GDS24304	GDS34211	GDS39224	GDS44043	GDS50384	GDS51020
GDS24305	GDS34212	GDS39228	GDS44048	GDS50386	GDS51021
GDS24317	GDS34222	GDS39236	GDS44049	GDS50410	GDS51025
GDS24318	GDS34223	GDS39237	GDS44050	GDS50411	GDS51030
GDS24321	GDS34224	GDS39247	GDS44051	GDS50421	GDS51035
GDS24347	GDS34225	GDS39249	GDS44052	GDS50423	GDS51036
GDS24352	GDS34226	GDS39261	GDS44064	GDS50425	GDS51037
GDS24362	GDS35022	GDS39262	GDS44065	GDS50426	GDS51038
GDS24363	GDS35025	GDS39263	GDS44068	GDS50429	GDS51041
GDS24364	GDS35027	GDS41020	GDS44069	GDS50453	GDS51046
GDS24398	GDS35029	GDS41021	GDS44070	GDS50454	GDS51047
GDS24399	GDS35030	GDS41023	GDS44071	GDS50465	GDS51050
GDS24400	GDS35031	GDS41055	GDS44072	GDS50466	GDS51068
GDS24401	GDS35032	GDS41081	GDS44082	GDS50467	GDS52006
GDS27017	GDS35039	GDS41127	GDS44088	GDS50468	GDS53007
GDS27062	GDS35040	GDS41194	GDS44092	GDS50469	GDS53008
GDS27063	GDS35045	GDS41195	GDS44093	GDS50471	GDS54014
GDS27096	GDS35047	GDS41200	GDS44094	GDS50483	GDS56068



## New applications (compared with catalogue 2015)

G-AP Ref.	G-AP Ref.	G-AP Ref.	G-AP Ref.	G-AP Ref.	G-AP Ref.
GDS57066	GDS60026	GDS62022	GDS99212	GCI17013	GCI24061
GDS57086	GDS60027	GDS62023	GDS99213	GCI17014	GCI24065
GDS57087	GDS60035	GDS62028	GDS99214	GCI17015	GCI24066
GDS57119	GDS61021	GDS62029	GDS99215	GCI17016	GCI24094
GDS57120	GDS61040	GDS62031	GDS99216	GCI17025	GCI24097
GDS57121	GDS61076	GDS62035	GDS99232	GCI17026	GCI24098
GDS57124	GDS61082	GDS62039	GDS99242	GCI17029	GCI27018
GDS57145	GDS61083	GDS62046	GDS99244	GCI17030	GCI27019
GDS57165	GDS61087	GDS62053	GDS99246	GCI17031	GCI27020
GDS57175	GDS61089	GDS62056	GDS99247	GCI17035	GCI27023
GDS57176	GDS61101	GDS62060	GDS99266	GCI17036	GCI27033
GDS57177	GDS61104	GDS62063	GDS99278	GCI17043	GCI27034
GDS57179	GDS61106	GDS62064	GDS99286	GCI17048	GCI27036
GDS57197	GDS61115	GDS62072	GDS99288	GCI17055	GCI27037
GDS57210	GDS61126	GDS66003	GCI82007	GCI17056	GCI27038
GDS57211	GDS61131	GDS66004	GCI82009	GCI17058	GCI27043
GDS57221	GDS61135	GDS75056	GCI82010	GCI17059	GCI31001
GDS57222	GDS61136	GDS99014	GCI82014	GCI17062	GCI34011
GDS57223	GDS61146	GDS99017	GCI83016	GCI17069	GCI34049
GDS59020	GDS61147	GDS99019	GCI83022	GCI17075	GCI34071
GDS59114	GDS61150	GDS99025	GCI83029	GCI17076	GCI34075
GDS59172	GDS61156	GDS99026	GCI85012	GCI17103	GCI34112
GDS59205	GDS61157	GDS99027	GCI85014	GCI18047	GCI35007
GDS59206	GDS61183	GDS99028	GCI85030	GCI18086	GCI35009
GDS59207	GDS61184	GDS99038	GCI85033	GCI18087	GCI35010
GDS59208	GDS61185	GDS99044	GCI85041	GCI18100	GCI35011
GDS59272	GDS61186	GDS99047	GCI85042	GCI18120	GCI35012
GDS59273	GDS61188	GDS99048	GCI85043	GCI18124	GCI35013
GDS59343	GDS61198	GDS99069	GCI85044	GCI18126	GCI35024
GDS59344	GDS61199	GDS99072	GCI85048	GCI18128	GCI35039
GDS59345	GDS61200	GDS99073	GCI88021	GCI18129	GCI35040
GDS59346	GDS61201	GDS99096	GCI88034	GCI18167	GCI35044
GDS59352	GDS61202	GDS99097	GCI88035	GCI18168	GCI35051
GDS59354	GDS61203	GDS99116	GCI88039	GCI18172	GCI38004
GDS59377	GDS61205	GDS99136	GCI88040	GCI18173	GCI39027
GDS59379	GDS61206	GDS99138	GCI88041	GCI18174	GCI39036
GDS59380	GDS61236	GDS99139	GCI88054	GCI18179	GCI39037
GDS59392	GDS61244	GDS99146	GCI88057	GCI18180	GCI39052
GDS59443	GDS61252	GDS99150	GCI10027	GCI18181	GCI39057
GDS59444	GDS61257	GDS99157	GCI10037	GCI18182	GCI39063
GDS59445	GDS61258	GDS99158	GCI10041	GCI21016	GCI39074
GDS59446	GDS61260	GDS99159	GCI10043	GCI21017	GCI39075
GDS59480	GDS61261	GDS99165	GCI10057	GCI21034	GCI41007
GDS59493	GDS61263	GDS99167	GCI10058	GCI23014	GCI41034
GDS59494	GDS61267	GDS99168	GCI10081	GCI23069	GCI41076
GDS59505	GDS61268	GDS99169	GCI10090	GCI24013	GCI41090
GDS59518	GDS61274	GDS99170	GCI10091	GCI24014	GCI41102
GDS59519	GDS61280	GDS99172	GCI10092	GCI24019	GCI41108
GDS59520	GDS61281	GDS99175	GCI10093	GCI24022	GCI41110
GDS59531	GDS61283	GDS99176	GCI12009	GCI24030	GCI41117
GDS59535	GDS61284	GDS99177	GCI16003	GCI24031	GCI41122
GDS59552	GDS61293	GDS99179	GCI16005	GCI24032	GCI41124
GDS59553	GDS61301	GDS99184	GCI17004	GCI24039	GCI41131
GDS59589	GDS61302	GDS99189	GCI17005	GCI24044	GCI41132
GDS60020	GDS61303	GDS99195	GCI17006	GCI24048	GCI41142
GDS60021	GDS61304	GDS99196	GCI17007	GCI24049	GCI41143
GDS60023	GDS61312	GDS99200	GCI17008	GCI24054	GCI41144
GDS60024	GDS62017	GDS99205	GCI17011	GCI24056	GCI41157
GDS60025	GDS62021	GDS99211	GCI17012	GCI24058	GCI44011



## New applications (compared with catalogue 2015)

G-AP Ref.	G-AP Ref.	G-AP Ref.	G-AP Ref.	G-AP Ref.	G-AP Ref.
GCI44012	GCI99089	GCO14096	GC024139	GC039168	GC050117
GCI44013	GCI99107	GCO14098	GC024144	GC039170	GC050124
GCI44014	GCI99109	GCO15010	GC024148	GC039181	GC050130
GCI44017	GCI99130	GCO17047	GC024151	GC039185	GC050131
GCI44018	GCI99136	GCO17054	GC024153	GC039186	GC050132
GCI44022	GCI99138	GCO17057	GC024159	GC039190	GC050137
GCI44023	GCI99146	GCO17061	GC024161	GC039192	GC050145
GCI45031	GCI99147	GCO17063	GC024163	GC039200	GC050149
GCI50008	GCI99150	GCO17064	GC024170	GC039203	GC050152
GCI50040	GCI99158	GCO17067	GC024173	GC039211	GC050153
GCI50045	GCI99159	GCO17068	GC024178	GC039221	GC050157
GCI50046	GCI99160	GCO17070	GC026009	GC039232	GC050162
GCI50048	GCI99169	GCO17093	GC027030	GC039233	GC050163
GCI50061	GCI99177	GCO18200	GC027033	GC039234	GC050170
GCI50079	GCI99179	GCO18204	GC027062	GC039236	GC051028
GCI50083	GCI99188	GCO18206	GC027067	GC041195	GC054006
GCI50084	GC083050	GCO18209	GC027074	GC041217	GC056048
GCI50085	GC083069	GCO18220	GC027075	GC041264	GC056057
GCI50086	GC083095	GCO18222	GC027078	GC041279	GC056058
GCI50087	GC083099	GCO18223	GC027088	GC041289	GC056067
GCI50096	GC083100	GCO18225	GC027091	GC041294	GC057021
GCI50097	GC083101	GCO18237	GC027097	GC041306	GC057027
GCI50098	GC083102	GCO18240	GC027107	GC041309	GC057038
GCI51012	GC083103	GCO18244	GC027108	GC041311	GC057054
GCI51021	GC083107	GCO18245	GC030011	GC041314	GC057078
GCI51034	GC083109	GCO18250	GC030015	GC041323	GC057088
GCI55001	GC083116	GCO18264	GC030016	GC041335	GC057096
GCI59049	GC085004	GCO18270	GC034067	GC041338	GC057097
GCI59069	GC085007	GCO18271	GC034091	GC041339	GC057103
GCI59070	GC085008	GC021043	GC034093	GC041340	GC057104
GCI59073	GC085009	GC023147	GC034105	GC041341	GC057112
GCI59078	GC085016	GC023179	GC034114	GC044019	GC057149
GCI59082	GC088038	GC023182	GC034128	GC044043	GC057157
GCI59092	GC088047	GC023197	GC034146	GC044085	GC057159
GCI59094	GC088066	GC024022	GC034156	GC044086	GC057160
GCI59100	GC089051	GC024024	GC034177	GC044088	GC059055
GCI59140	GC089056	GC024026	GC034178	GC044090	GC059086
GCI60003	GC010069	GC024037	GC034180	GC044099	GC059129
GCI61017	GC010094	GC024044	GC034181	GC044107	GC059168
GCI61028	GC010095	GC024056	GC034200	GC045035	GC059231
GCI61032	GC010097	GC024060	GC035016	GC045037	GC059233
GCI61033	GC010100	GC024063	GC035019	GC045041	GC059244
GCI61039	GC010109	GC024071	GC035020	GC045058	GC059263
GCI61048	GC010115	GC024072	GC035024	GC045068	GC059285
GCI61057	GC010118	GC024074	GC035025	GC045074	GC059317
GCI61062	GC010124	GC024077	GC035027	GC050015	GC059318
GCI61064	GC010127	GC024087	GC035030	GC050030	GC059340
GCI61066	GC010148	GC024099	GC035036	GC050046	GC059344
GCI61070	GC010149	GC024100	GC035040	GC050051	GC059345
GCI61075	GC010155	GC024111	GC035052	GC050052	GC059370
GCI61076	GC010156	GC024114	GC039058	GC050057	GC059383
GCI62028	GC010158	GC024125	GC039060	GC050066	GC059384
GCI62029	GC010159	GC024126	GC039070	GC050080	GC059387
GCI62030	GC012042	GC024129	GC039100	GC050082	GC059390
GCI99001	GC012046	GC024131	GC039103	GC050083	GC059431
GCI99019	GC012049	GC024132	GC039128	GC050089	GC059432
GCI99038	GC014055	GC024136	GC039137	GC050107	GC060006
GCI99053	GC014077	GC024137	GC039157	GC050108	GC061022
GCI99083	GC014078	GC024138	GC039166	GC050109	GC061059

## New applications (compared with catalogue 2015)

G-AP Ref.	G-AP Ref.	G-AP Ref.	G-AP Ref.	G-AP Ref.	G-AP Ref.
GC061062					
GC061070					
GC061075					
GC062019					
GC062031					
GC062035					
GC062037					
GC062038					
GC062039					
GC062040					
GC066001					
GC075002					
GC099006					
GC099023					
GC099024					
GC099059					
GC099061					
GC099087					
GC099088					
GC099102					
GC099132					
GC099147					
GC099221					
GC099230					
GC099232					
GC099236					
GC099242					
GC099262					
GC099267					
GC099271					
GC099272					
GC099281					
GC099284					
GC099285					
GC099289					
GC099291					
GC099293					
GC099301					
GC099309					
GC099310					
GC099316					
GC099317					
GC099318					
GC099320					
GC099322					
GC099325					
GC099339					
GC099349					
GC099366					
GC099367					

**G<sup>®</sup> AUTOPARTS**

**CAT.NO.G31016/E**

